



**Vehicle document wallet**

Here you can find comprehensive information about operating your vehicle and about services and guarantees in printed form.



**Digital – on the Internet**

You can find the Operator's Manual on the Mercedes-Benz homepage.



**Digital – as an app**

The Mercedes-Benz Guides app is available free-of-charge in familiar app stores.



2475840907

Order no. P247 0446 13 Part no. 247 584 09 07  
Edition A 2021



Apple® iOS



Android™

GLA



**GLA**  
Operator's Manual

Mercedes-Benz

Mercedes-Benz



## Front passenger airbag warning

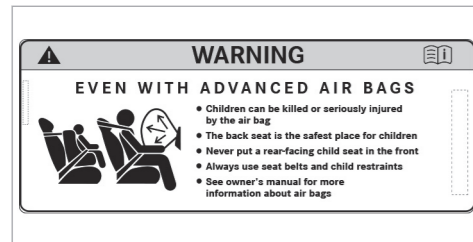

Example

**⚠ WARNING** Risk of injury or fatal injuries if the front passenger airbag is enabled

If the front passenger airbag is enabled, a child on the front passenger seat may be struck by the front passenger airbag during an accident.

NEVER use a rearward facing child restraint system on a seat protected by an ENABLED FRONT AIRBAG in front of it, this can result in DEATH or SERIOUS INJURY to the child.

Observe the chapter "Children in the vehicle".

## Publication details

### Internet

Further information about Mercedes-Benz vehicles and about Mercedes-Benz AG can be found on the following websites:

<https://www.mbusa.com> (USA only)

<https://www.mercedes-benz.ca> (Canada only)

### Documentation team

©Mercedes-Benz AG: Not to be reprinted, translated or otherwise reproduced, in whole or in part, without written permission from Mercedes-Benz AG.

### Vehicle manufacturer

Mercedes-Benz AG

Mercedesstraße 120

70372 Stuttgart

Germany

As at 23.09.2019

## Thank you for purchasing a Mercedes-Benz

Before you first drive off, read this Operator's Manual carefully and familiarize yourself with your vehicle. For your own safety and a longer operating lifespan of the vehicle, follow the instructions and warning notices in this Operator's Manual. Disregarding them may lead to damage to the vehicle or injury to people.

Damage to the vehicle resulting from the disregard of the instructions is not covered by the Mercedes-Benz Limited Warranty.

The standard equipment and product description of your vehicle may vary and depends on the following factors:

- Model
- Order
- National version
- Availability

Mercedes-Benz reserves the right to introduce changes in the following areas:

- Design
- Equipment

- Technical features

The equipment in your vehicle may therefore differ from that shown in the descriptions and illustrations.

The following documents are integral parts of the vehicle:

- Printed Operator's Manual
- Maintenance Booklet
- Equipment-dependent Supplements

Keep these documents in the vehicle at all times. If you sell the vehicle, always pass all of the documents on to the new owner.

Mercedes-Benz USA, LLC  
Mercedes-Benz Canada, Inc.  
A Daimler Company

2475840907



|   |    |   |    |  |     |
|---|----|---|----|--|-----|
| <b>Symbols</b> .....  | 4  | Reporting safety defects .....                    | 25 | <b>Seats and stowing</b> .....   | 84  |
| <b>At a glance</b> .....  | 6  | Limited Warranty .....                            | 26 | Notes on the correct driver's seat position .....                                  | 84  |
| Cockpit .....   | 6  | QR code for rescue card .....                     | 26 | Seats .....  | 85  |
| Indicator and warning lamps (standard) .....                    | 10 | Data storage .....                                | 26 | Steering wheel .....   | 94  |
| Overhead control panel .....                                    | 12 | Copyright .....                                   | 29 | Easy entry and exit feature .....  | 95  |
| Door control panel and seat adjustment .....                    | 14 | <b>Occupant safety</b> .....                      | 31 | Operating the memory function .....  | 96  |
| Emergencies and breakdowns .....                                | 16 | Restraint system .....                            | 31 | Stowage areas .....  | 98  |
| <b>General notes</b> .....                                      | 18 | Seat belts .....                                  | 33 | Sockets .....  | 109 |
| Protecting the environment .....                                | 18 | Airbags .....                                     | 37 | Wireless charging of the mobile phone and connection with the exterior antenna ... | 110 |
| Mercedes-Benz GenuineParts .....                                | 18 | PRE-SAFE® system .....                            | 44 | Installing/removing the floor mats .....   | 112 |
| Operator's Manual .....   | 19 | Automatic measures after an accident .....        | 45 | <b>Light and visibility</b> .....  | 114 |
| Service and vehicle operation .....                             | 20 | Safely transporting children in the vehicle ..... | 46 | Exterior lighting .....  | 114 |
| Operating safety .....  | 21 | Notes on pets in the vehicle .....                | 59 | Interior lighting .....  | 119 |
| Declaration of conformity for wireless vehicle components ..... | 22 | <b>Opening and closing</b> .....                  | 60 | Windshield wiper and windshield washer system .....                                | 120 |
| Diagnostics connection .....                                    | 23 | SmartKey .....                                    | 60 | Mirrors .....  | 124 |
| Qualified specialist workshop .....                             | 23 | Doors .....                                       | 63 | <b>Climate control</b> .....   | 128 |
| Correct use of the vehicle .....                                | 24 | Cargo compartment .....                           | 67 | Overview of climate control systems .....  | 128 |
| Sport Utility Vehicle .....                                     | 24 | Side windows .....                                | 73 | Operating the climate control system .....   | 128 |
| Notes for persons with electronic medical aids .....            | 24 | Sliding sunroof .....                             | 76 |  |     |
| Problems with your vehicle .....                                | 24 | Anti-theft protection .....                       | 80 |  |     |

|  |            |
|--|------------|
| <b>Driving and parking</b> .....         | <b>132</b> |
| Driving .....                            | 132        |
| DYNAMIC SELECT switch .....              | 144        |
| Automatic transmission .....             | 146        |
| Function of the 4MATIC .....             | 151        |
| Refueling .....                          | 152        |
| Parking .....                            | 154        |
| Driving and driving safety systems ..... | 161        |
| Vehicle towing instructions .....        | 205        |

|   |            |
|---|------------|
| <b>Instrument Display and on-board computer</b> .....         | <b>207</b> |
| Notes on the Instrument Display and on-board computer .....   | 207        |
| Instrument Display overview .....                             | 208        |
| Overview of the buttons on the steering wheel .....           | 209        |
| Operating the on-board computer .....                         | 209        |
| Overview of what is shown on the multi-function display ..... | 210        |

|                                     |            |
|-------------------------------------|------------|
| <b>MBUX multimedia system</b> ..... | <b>211</b> |
| Overview and operation .....        | 211        |
| System settings .....               | 214        |

|   |     |
|---|-----|
| Telephone .....                           | 217 |
| Mercedes-Benz emergency call system ..... | 221 |
| Radio & media .....                       | 225 |
| Sound settings .....                      | 228 |

|  |            |
|--|------------|
| <b>Maintenance and care</b> .....          | <b>229</b> |
| ASSYST PLUS service interval display ..... | 229        |
| Engine compartment .....                   | 230        |
| Cleaning and care .....                    | 235        |

|                                   |            |
|-----------------------------------|------------|
| <b>Breakdown assistance</b> ..... | <b>243</b> |
| Emergency .....                   | 243        |
| Flat tire .....                   | 245        |
| Battery (vehicle) .....           | 251        |
| Tow starting or towing away ..... | 256        |
| Electrical fuses .....            | 260        |

|  |            |
|--|------------|
| <b>Wheels and tires</b> .....                            | <b>264</b> |
| Notes on noise or unusual handling characteristics ..... | 264        |
| Notes on regularly inspecting wheels and tires .....     | 264        |
| Notes on snow chains .....                               | 265        |

|   |     |
|---|-----|
| Tire pressure .....                             | 265 |
| Loading the vehicle .....                       | 272 |
| Tire labeling .....                             | 276 |
| Definition of terms for tires and loading ..... | 281 |
| Changing a wheel .....                          | 284 |
| Emergency spare wheel .....                     | 293 |

|  |            |
|--|------------|
| <b>Technical data</b> .....  | <b>296</b> |
| Notes on technical data .....                                      | 296        |
| Vehicle electronics .....  | 296        |
| Vehicle identification plate, VIN and engine number overview ..... | 298        |
| Operating fluids .....   | 299        |
| Vehicle data .....   | 306        |

|   |            |
|---|------------|
| <b>Display messages and warning/indicator lamps</b> ..... | <b>309</b> |
| Display messages .....                                    | 309        |
| Warning and indicator lamps .....                         | 356        |

|                    |            |
|--------------------|------------|
| <b>Index</b> ..... | <b>370</b> |
|--------------------|------------|

## 4 Symbols

In this Operator's Manual, you will find the following symbols:

 **DANGER** Danger due to not observing the warning notices

Warning notices draw your attention to hazards that may endanger your health or life, or the health or life of others.

 Observe the warning notices.

 **ENVIRONMENTAL NOTE** Environmental damage due to failure to observe environmental notes

Environmental notes include information on environmentally responsible behavior or environmentally responsible disposal.

 Observe environmental notes.

 **NOTE** Damage to property due to failure to observe notes on material damage

Notes on material damage inform you of risks which may lead to your vehicle being damaged.

 Observe notes on material damage.

 These symbols indicate useful instructions or further information that could be helpful to you.

 Instruction

 Further information on a topic

**Display** Information on the multifunction display/media display

 Highest menu level, which is to be selected in the multimedia system

 Relevant submenus, which are to be selected in the multimedia system

\* Indicates a cause

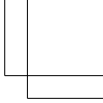
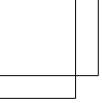

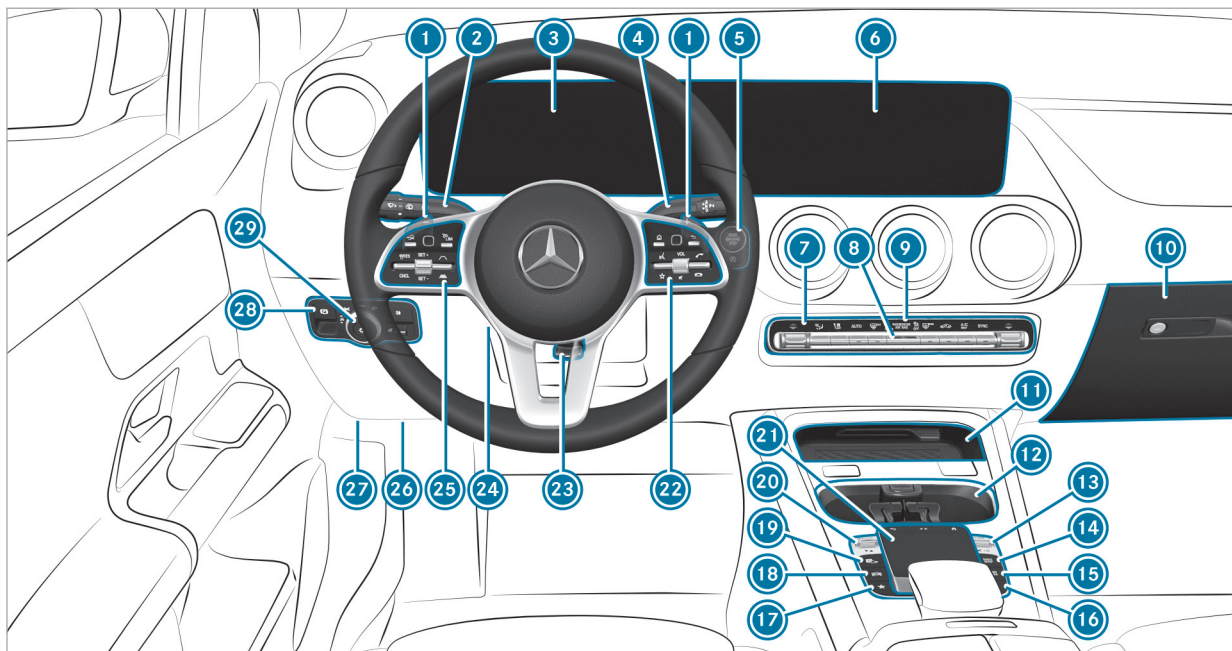

Left-hand-drive vehicles



|  |   |     |  |   |     |
|--|---|-----|--|---|-----|
| ① Steering wheel gearshift paddles                 | → | 148 | ⑭ Calls up navigation                          | → | 212 |
| ② Combination switch                               | → | 115 | ⑮ Calls up radio or media                      | → | 212 |
| ③ Instrument Display                               | → | 208 | ⑯ Calls up the telephone                       | → | 212 |
| ④ DIRECT SELECT lever                              | → | 146 | ⑰ Calls up favorites                           | → | 212 |
| ⑤ Start/stop button                                | → | 133 | ⑱ Calls up vehicle functions                   | → | 212 |
| ECO start/stop function                            | → | 143 | ⑲ Active Parking Assist                        | → | 195 |
| ⑥ Media display                                    | → | 211 | ⑳ DYNAMIC SELECT switch                        | → | 144 |
| ⑦ Climate control systems                          | → | 128 | ㉑ Touchpad                                     | → | 212 |
| ⑧ Hazard warning light system                      | → | 116 | ㉒ Control panel for the MBUX multimedia system | → | 209 |
| ⑨ PASSENGER AIR BAG indicator lamps                | → | 42  | ㉓ Adjusts the steering wheel                   | → | 94  |
| ⑩ Glove box  | → | 100 | ㉔ Switches the steering wheel heater on/off    | → | 95  |
| ⑪ Storage compartment                              | → | 100 | ㉕ Control panel:                               |   |     |
| ⑫ Cup holder                                       |   |     | On-board computer                              | → | 209 |
| ⑬ Controller for volume and switching sound on/off | → | 211 | Cruise control                                 | → | 172 |
| Switches the MBUX multimedia system on/off         | → | 211 | Active Distance Assist DISTRONIC               | → | 177 |
|  |   |     | ㉖ Diagnostics connection                       | → | 23  |

## 8 At a glance – Cockpit

---



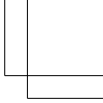
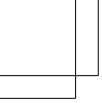



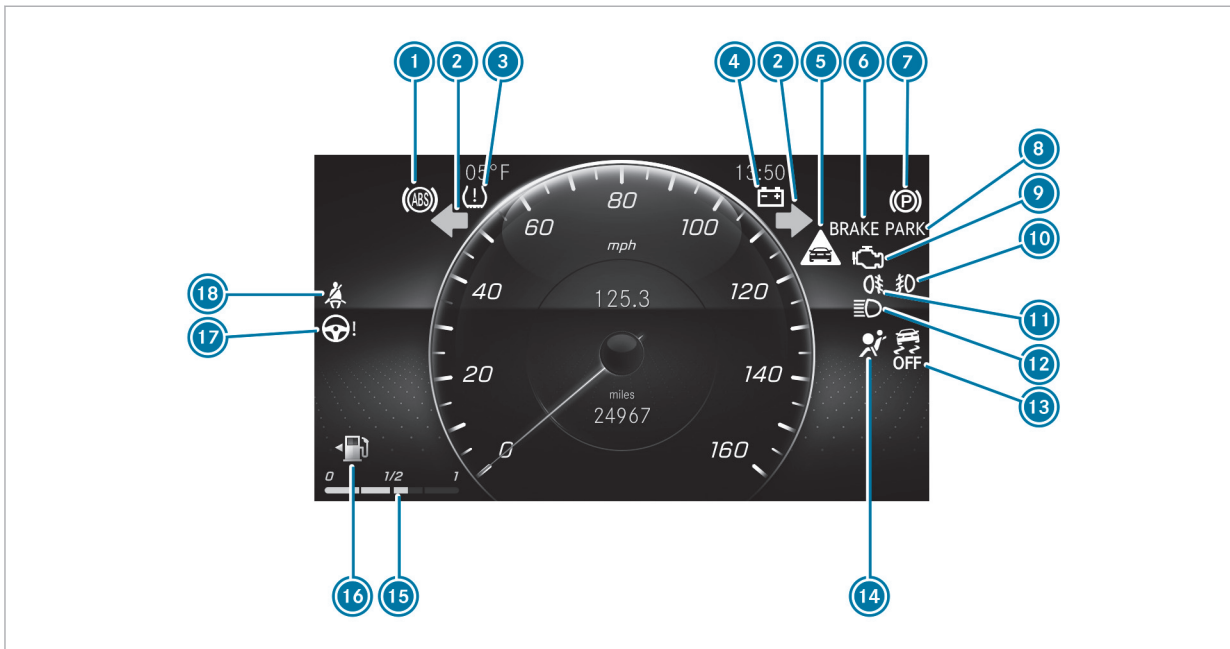















|    |                        |   |     |
|----|------------------------|---|-----|
| 27 | Opens the hood         | → | 230 |
| 28 | Electric parking brake | → | 158 |
| 29 | Light switch           | → | 114 |



10 At a glance – Indicator and warning lamps (standard)









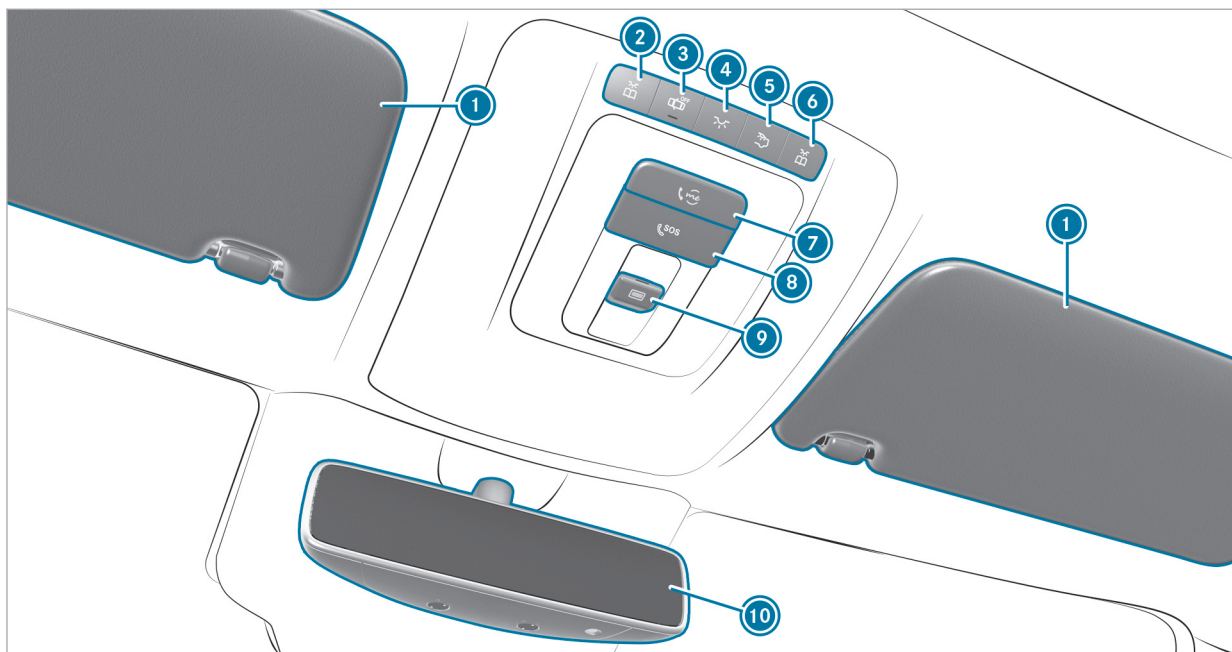

Instrument Display (standard)

|   |   |   |                    |     |     |  |  |               |     |     |
|---|---|---|--------------------|-----|-----|--|--|---------------|-----|-----|
| 1 |  | ABS   | →                  | 365 | 10  |  | Front fog lamps  | →             | 114 |     |
| 2 |  |  | Turn signal lights | →   | 115 | 11   |  | Rear fog lamp | →   | 115 |
| 3 |  | Tire pressure monitor   | →                  | 368 | 12  |  | High beam  | →             | 115 |     |
| 4 |  | Electrical malfunction  | →                  | 359 |     |  | Low beam   | →             | 114 |     |
| 5 |  | Distance warning  | →                  | 365 |     |  | Parking lamps  | →             | 114 |     |
| 6 |   | Brakes (red)  | →                  | 363 | 13  |  | ESP® OFF   | →             | 365 |     |
|   |  | USA only  |                    |     |     |  | ESP®   | →             | 365 |     |
|   |  | Canada only   |                    |     | 14  |  | Restraint system   | →             | 357 |     |
| 7 |  | Electric parking brake (yellow)   | →                  | 363 | 15  |  | Fuel level   | →             | 208 |     |
| 8 |   | Electric parking brake (red)  | →                  | 363 | 16  |  | Reserve fuel with fuel filler flap location indicator                              | →             | 359 |     |
|   |  | USA only  |                    |     | 17  |  | Electric power steering  | →             | 359 |     |
|   |  | Canada only   |                    |     | 18  |  | Seat belt  | →             | 357 |     |
| 9 |  | Check Engine  | →                  | 359 |     |  |  |               |     |     |

## 12 At a glance – Overhead control panel







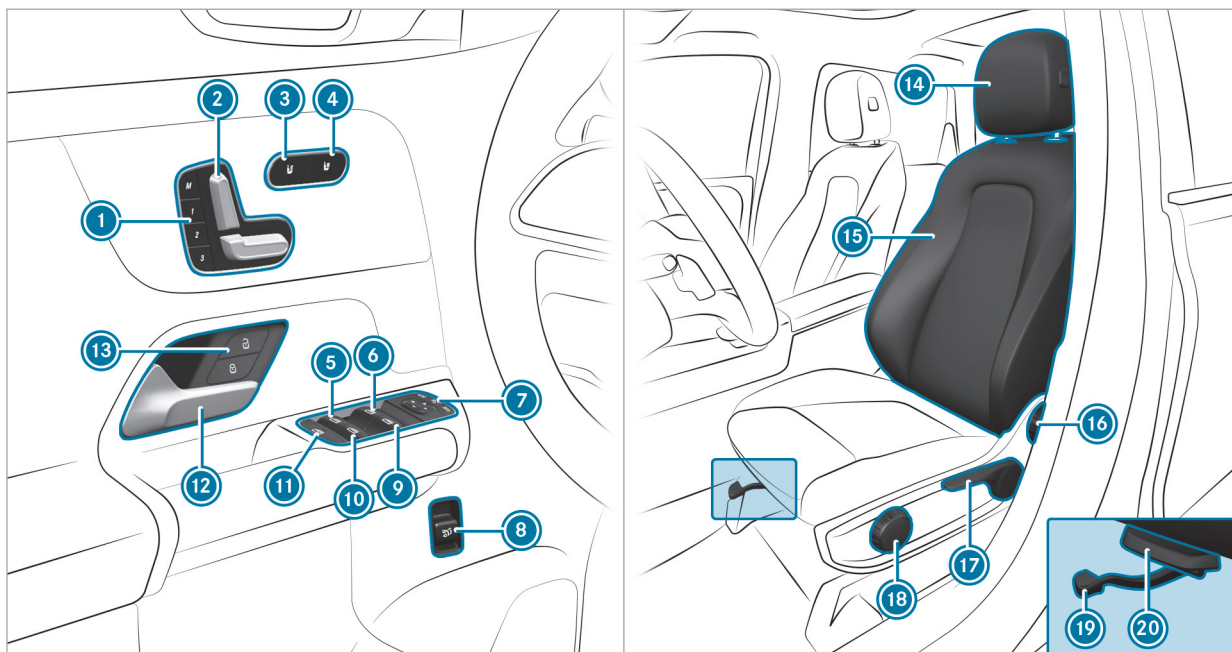

|   |   |   |     |
|---|---|---|-----|
| ① | Sun visors  |   |     |
| ② |  Switches the left-hand reading lamp on/off                    | → | 119 |
| ③ |  Switches automatic interior lighting control on/off           | → | 119 |
| ④ |  Switches the front interior lighting on/off                   | → | 119 |
| ⑤ |  Switches the rear interior lighting on/off                    | → | 119 |
| ⑥ |  Switches the right-hand reading lamp on/off                  | → | 119 |
| ⑦ |  me button  |   |     |
| ⑧ |  SOS button   |   |     |
| ⑨ |  Opens closes the panorama roof with power tilt/sliding panel | → | 76  |
|   |  Opens/closes the roller sunblind                             | → | 76  |
| ⑩ | Inside rearview mirror  | → | 125 |

14 At a glance – Door control panel and seat adjustment





|   |   |     |  |   |    |
|---|---|-----|--|---|----|
| ① Operates the memory function  | → | 96  | ⑪ Child safety lock for the rear side windows  | → | 59 |
| ② Adjusts the seats electrically  | → | 87  | ⑫ Opens the door   | → | 63 |
| ③ Switches the seat heating on/off  | → | 93  | ⑬   Locks/unlocks the vehicle | → | 64 |
| ④ Switches the seat ventilation on/off  | → | 93  | ⑭ Adjusts the head restraints  | → | 90 |
| ⑤  Opens/closes the rear left side window  | → | 73  | ⑮ Configures the seat settings   | → | 92 |
| ⑥  Opens/closes the left side window       | → | 73  | ⑯ Adjusts the seat backrest inclination  | → | 87 |
| ⑦ Operates the outside mirrors  | → | 124 | ⑰ Adjusts the seat height  | → | 87 |
| ⑧ Opens/closes the tailgate   | → | 67  | ⑱ Adjusts the seat cushion inclination   | → | 87 |
| ⑨  Opens/closes the right side window      | → | 73  | ⑲ Sets the seat fore-and-aft position  | → | 87 |
| ⑩  Opens/closes the rear right side window | → | 73  | ⑳ Adjusts the seat cushion length  | → | 87 |

16 At a glance – Emergencies and breakdowns

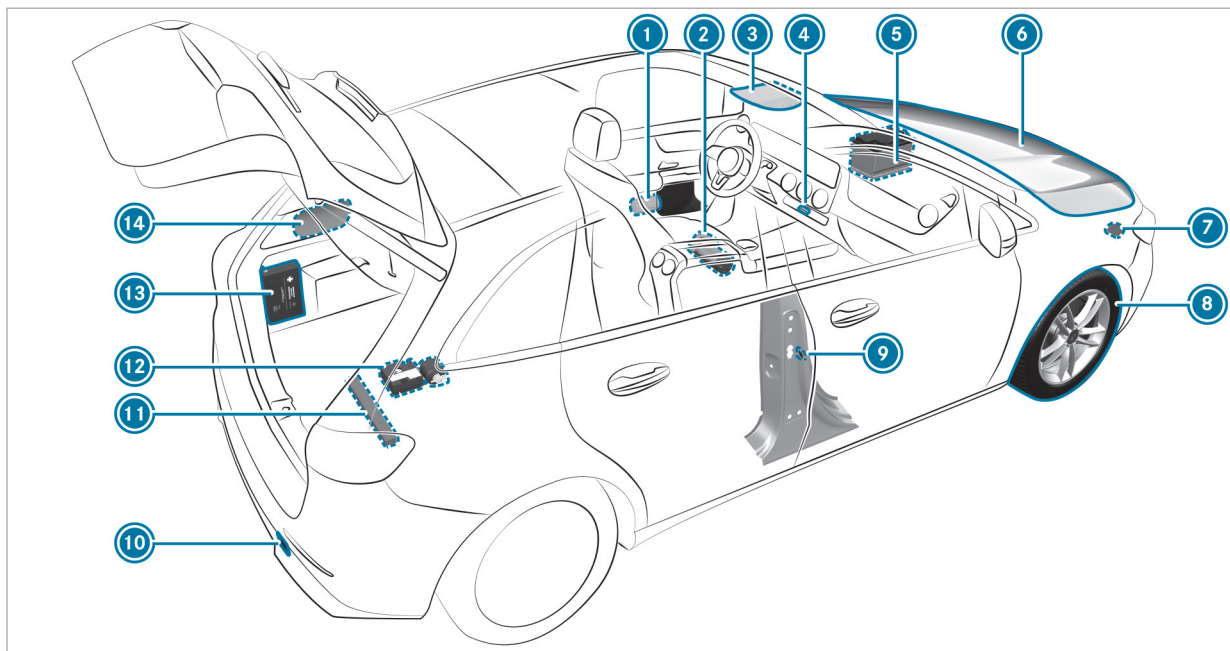

---

|   |   |     |
|---|---|-----|
| ① Safety vests                            | → | 243 |
| ② Fire extinguisher                       | → | 244 |
| ③ me button and SOS button                |   |     |
| ④ Hazard warning light system             | → | 116 |
| ⑤ Starting assistance                     | → | 255 |
| ⑥ Checking and refilling operating fluids | → | 299 |
| ⑦ Tow-starting and towing away            | → | 257 |
| ⑧ Flat tire                               | → | 245 |

---

|   |   |     |
|---|---|-----|
| ⑨ QR code for accessing the rescue card   | → | 26  |
| ⑩ Tow-starting and towing away  | → | 257 |
| ⑪ Warning triangle  | → | 243 |
| ⑫ TIREFIT kit   | → | 247 |
| ⑬ First-aid kit (soft sided)  | → | 244 |
| ⑭ Fuel filler flap with instruction labels for tire pressure, fuel type and QR code for accessing the rescue card | → | 152 |

---

## Protecting the environment

 **ENVIRONMENTAL NOTE** Environmental damage due to operating conditions and personal driving style

The pollutant emission of the vehicle is directly related to the way you operate the vehicle.

Operate your vehicle in an environmentally responsible manner to help protect the environment. Please observe the following recommendations on operating conditions and personal driving style.

### Operating conditions:

- ▶ Make sure that the tire pressure is correct.
- ▶ Do not carry any unnecessary weight (e.g. roof luggage racks once you no longer need them).
- ▶ Adhere to the service intervals. A regularly serviced vehicle will contribute to environmental protection.

- ▶ Always have maintenance work carried out at a qualified specialist workshop.

### Personal driving style:

- ▶ Do not depress the accelerator pedal when starting the engine.
- ▶ Do not warm up the engine while the vehicle is stationary.
- ▶ Drive carefully and maintain a suitable distance from the vehicle in front.
- ▶ Avoid frequent, sudden acceleration and braking.
- ▶ Change gear in good time and use each gear only up to  $\frac{2}{3}$  of its maximum engine speed.
- ▶ Switch off the engine in stationary traffic, e.g. by using the ECO start/stop function.
- ▶ Drive fuel-efficiently. Observe the ECO display for a fuel-efficient driving style.

### Environmental issues and recommendations:

It is recommended that you re-use or recycle materials instead of just disposing of them.

The relevant environmental guidelines and regulations serve to protect the environment and must be strictly observed.

## Mercedes-Benz GenuineParts

 **ENVIRONMENTAL NOTE** Environmental damage caused by not using recycled/reconditioned components

Mercedes-Benz AG offers recycled/reconditioned components and parts with the same quality as new parts. The same entitlement from the Limited Warranty is valid as for new parts.

- ▶ Recycled/reconditioned components and parts from Mercedes-Benz AG.

**!** **NOTE** Impairment of the operating efficiency of the restraint systems from installing accessory parts or from repairs or welding

Airbags and Emergency Tensioning Devices, as well as control units and sensors for the restraint systems, may be installed in the following areas of your vehicle:

- Doors
- Door pillars
- Door sills
- Seats
- Cockpit
- Instrument cluster
- Center console
- Lateral roof frame

▶ Do not install accessory parts such as audio systems in these areas.

▶ Do not carry out repairs or welding.

▶ Have aftermarket installation of accessories carried out at a qualified specialist workshop.

You could jeopardize the operating safety of your vehicle if you use parts, tires and wheels as well as accessories relevant to safety which have not been approved by Mercedes-Benz. Safety-relevant systems, e.g. the brake system, may malfunction. Only use Mercedes-Benz GenuineParts or parts of equal quality. Only use tires, wheels and accessory parts that have been specifically approved for your vehicle model.

Mercedes-Benz GenuineParts are subject to strict quality inspections. Each part has been specially developed, manufactured or selected for Mercedes-Benz vehicles and adapted to them. Therefore, only Mercedes-Benz GenuineParts should be used.

More than 300,000 different Mercedes-Benz GenuineParts are available for Mercedes-Benz models.

All authorized Mercedes-Benz Centers maintain a supply of Mercedes-Benz GenuineParts for

necessary service and repair work. In addition, strategically located parts delivery centers provide for quick and reliable parts service.

Always specify the vehicle identification number (VIN) (→ page 298) when ordering Mercedes-Benz GenuineParts.

### Operator's Manual

This Operator's Manual describes all models and all standard and optional equipment available for your vehicle at the time of this Operator's Manual going to press. Country-specific differences are possible. Note that your vehicle may not be equipped with all features described. This is also the case for systems and functions relevant to safety. Therefore, the equipment on your vehicle may differ from that in the descriptions and illustrations.

The original purchase agreement for your vehicle contains a list of all of the systems in your vehicle.

Should you have any questions concerning equipment and operation, please consult an authorized Mercedes-Benz Center.

## 20 General notes

---

The Operator's Manual and Maintenance Booklet are important documents and should be kept in the vehicle.

### Service and vehicle operation

#### Vehicle operation outside the USA or Canada

When you are abroad with your vehicle, observe the following points:

- Service points or replacement parts may not be available immediately.
- Unleaded fuel may not be available for vehicles with a catalytic converter. Leaded fuel may cause damage to the catalytic converter.
- The fuel may have an extremely low octane number. Unsuitable fuel can cause engine damage.

Some Mercedes-Benz models are available in Europe through our European Delivery Program. For more information, please consult an authorized Mercedes-Benz service center, or write to one of the following address:

#### **In the USA:**

Mercedes-Benz USA, LLC  
European Delivery Department  
One Mercedes-Benz Drive  
Sandy Springs, GA 30328

#### **In Canada:**

Mercedes-Benz Canada, Inc.  
European Delivery Department  
98 Vanderhoof Avenue  
Toronto, Ontario M4G 4C9

#### Maintenance

Your customer advisor confirms the service in the service report.

#### Roadside Assistance

The Mercedes-Benz Roadside Assistance Program offers technical help in the case of a breakdown. Your calls to the toll-free Roadside Assistance Hotline are answered by our agents 24 hours a day, 365 days a year.

1-800-FOR-MERCEdes (1-800-367-6372) (USA)

1-800-387-0100 (Canada)

You can find further information in the Mercedes-Benz Roadside Assistance Program brochure (USA) or the "Roadside Assistance" section in the Service and Warranty booklet (Canada). You will find both in the vehicle document wallet.

#### Change of address or change of ownership

In the event of a change of address, please send us the "Notification of address change" in the Service and Guarantee booklet or simply call the Mercedes-Benz Customer Assistance Center (USA) on the hotline number 1-800-FOR-MERCEdes (1-800-367-6372) or Customer Service (Canada) on 1-800-387-0100. We can then reach you in a timely fashion, if necessary.

If you sell your Mercedes, please leave all literature in the vehicle so that it is available to the next owner. If you have purchased a used vehicle, please send us the "Notice of Purchase of Used Car" in the Service and Guarantee booklet or simply call the Mercedes-Benz Customer

Assistance Center (USA) at the hotline number 1-800-FOR-MERCEdes (1-800-367-6372) or Customer Service (Canada) at 1-800-387-0100.

### Possible danger due to substances hazardous to health

In compliance with Proposition 65 ("Prop65"), the following detachable label has been added to each vehicle sold in California:



## WARNING



Operating, servicing and maintaining a passenger vehicle, pickup truck, van or off-road motor vehicle can expose you to chemicals including engine exhaust, carbon monoxide, phthalates, and lead, which are known to the State of California to cause cancer and birth defects or other reproductive harm. To minimize exposure, avoid breathing exhaust, do not idle the engine except as necessary, service your vehicle in a well-ventilated area and wear gloves or wash your hands frequently when servicing your vehicle. For more information go to [www.P65Warnings.ca.gov/passenger-vehicle](http://www.P65Warnings.ca.gov/passenger-vehicle)

A 000 817 82 02

### Operating safety

**⚠ WARNING** Risk of accident due to malfunctions or system failures

To avoid malfunctions or system failures:

- ▶ Always have the prescribed service and maintenance work as well as any required repairs carried out at a qualified specialist workshop.

**⚠ WARNING** Risk of accident or injury due to incorrect modifications on electronic component parts

Modification of electronic components, their software or wiring could impair their function and/or the function of other networked component parts or safety-relevant systems.

This can endanger the operating safety of the vehicle.

- ▶ Never tamper with the wiring and electronic component parts or their software.

- ▶ You should have all work on electrical and electronic components carried out at a qualified specialist workshop.

Observe the "On-board electronics" section in "Technical data".

**⚠ WARNING** Risk of fire due to flammable materials on hot parts of the exhaust system

Flammable material such as leaves, grass or twigs may ignite if they come into contact with hot parts of the exhaust system.

- ▶ When driving on unpaved roads or off-road, regularly check the vehicle underside.
- ▶ Remove trapped plants or other flammable material, in particular.
- ▶ If there is damage, consult a qualified specialist workshop immediately.

**!** NOTE Damage to the vehicle

In the following situations, in particular, there is a risk of damage to the vehicle:

- The vehicle becomes grounded, e.g. on a high curb or an unpaved road
- The vehicle is driven too fast over an obstacle, e.g. a curb, speed bump or pothole
- A heavy object strikes the underbody or chassis components

In situations such as this, the body, the underbody, chassis components, wheels or tires could be damaged without the damage being visible. Components damaged in this way can unexpectedly fail or, in the case of an accident, may not absorb the loads that arise as intended.

If the underbody paneling is damaged, flammable materials such as leaves, grass or twigs can collect between the underbody and the underbody paneling. These materials may ignite if they come into contact with hot parts on the exhaust system.

▶ Have the vehicle checked and repaired immediately at a qualified specialist workshop.

or

▶ If driving safety is impaired while continuing your journey, pull over and stop the vehicle immediately in accordance with the traffic conditions, and contact a qualified specialist workshop.

**Declaration of conformity for wireless vehicle components**

**USA:** "Radio based devices of this vehicle comply with Part 15 of the FCC Rules. Operation is subject to the following two conditions: 1) These devices may not cause harmful interference, and 2) These devices must accept any interference received, including interference that may cause undesired operation. Changes or modifications not expressly approved by the party responsible for compliance could void the user's authority to operate the equipment."

**Canada:** "This vehicle contains license-exempt transmitter(s)/receiver(s) that comply with Innovation, Science and Economic Development Canada's RSS(s). Operation is subject to the following two conditions: (1) These devices may not cause interference, and (2) These devices must accept any interference, including interference that may cause undesired operation of the device."

**USA:** "Wireless charging system for mobile devices (model: WM12 Wireless Mobile Interface): This device complies with Part 18 of the FCC Rules."

The name and address of the responsible party is:

peiker acoustic GmbH  
Max-Planck-Str. 28-32  
61381 Friedrichsdorf  
Germany



### Diagnostics connection

The diagnostics connection is only intended for the connection of diagnostic devices at a qualified specialist workshop.

**⚠ WARNING** Risk of accident due to connecting devices to the diagnostics connection

If you connect devices to the diagnostics connection of the vehicle, the function of vehicle systems and operating safety may be impaired.

- ▶ Only connect the vehicle diagnostics connection to devices which have been tested with regard to their suitability and are considered safe.

**⚠ WARNING** Risk of accident due to objects in the driver's footwell

Objects in the driver's footwell may impede pedal travel or block a depressed pedal.

This jeopardizes the operating and road safety of the vehicle.

- ▶ Stow all objects in the vehicle securely so that they cannot get into the driver's footwell.
- ▶ Always install the floor mats securely and as prescribed in order to ensure that there is always sufficient room for the pedals.
- ▶ Do not use loose floor mats and do not place floor mats on top of one another.

**ⓘ NOTE** Battery discharging from using devices connected to the diagnostics connection

Using devices at the diagnostics connection drains the battery.

- ▶ Check the charge level of the battery.
- ▶ If the charge level is low, charge the battery, e.g. by driving a considerable distance.

Connecting equipment to the diagnostics connection can lead to emissions monitoring information being reset, for example. This may lead

to the vehicle failing to meet the requirements of the next emissions inspection during the main inspection.

### Qualified specialist workshop

An authorized Mercedes-Benz Center is a qualified specialist workshop. It has the necessary special skills, tools and qualifications to correctly carry out the work required on your vehicle. This particularly applies to safety-relevant works.

For the following, always have your vehicle checked at an authorized Mercedes-Benz Center:

- safety-relevant works
- service and maintenance work
- repair work
- modifications as well as installations and conversions
- work on electronic components

Mercedes-Benz recommends a Mercedes-Benz service center.

### Correct use of the vehicle

If you remove any warning stickers, you or others could fail to recognize certain dangers. Leave warning stickers in position.

Observe the following information in particular when driving your vehicle:

- the safety notes in this manual
- technical data for the vehicle
- traffic rules and regulations
- laws and safety standards pertaining to motor vehicles

### Sport Utility Vehicle

**⚠ WARNING** Risk of accident when the center of gravity is too high

The vehicle may start to skid and rollover in the event of sudden steering maneuvers and/or when the vehicle's speed is not adapted to the road conditions.

- ▶ Always adapt your speed and driving style to the vehicle's driving character-

istics and to the prevailing road and weather conditions.

Utility vehicles have a significantly higher roll-over rate than other types of vehicles.

If this type of vehicle is not driven safely, an accident can occur, the vehicle can roll over and occupants can suffer serious or even fatal injuries.

In a rollover crash, an unbelted person is significantly more likely to die than a person wearing a seat belt.

You and all vehicle occupants should always wear your seat belts.

### Notes for persons with electronic medical aids

Mercedes-Benz AG cannot, despite carefully developing vehicle systems, completely rule out the interaction of vehicle systems with electronic medical aids such as cardiac pacemakers.

For this reason, the following can occur in isolated cases, depending on the aids used:

- Aids malfunctioning
- Adverse health effects

Observe the notes and warnings of the manufacturer of the aids; if in doubt, contact the device manufacturer and your doctor. Mercedes-Benz AG recommends using only few electrical vehicle systems if there is continuing uncertainty concerning the possibility of aids malfunctioning.

Have repairs and maintenance work in the area of vehicle components carrying live voltage and transmission antenna carried out by a qualified specialist workshop.

### Problems with your vehicle

If you should experience a problem with your vehicle, particularly one that you believe may affect its safe operation, we urge you to contact an authorized Mercedes-Benz Center immediately to have the problem diagnosed and rectified. If the problem is not resolved to your satis-

faction, please discuss the problem again with an authorized Mercedes-Benz Center or, if necessary, contact us at one of the following addresses:

**In the USA:**

Mercedes-Benz USA, LLC  
Customer Assistance Center  
One Mercedes-Benz Drive  
Sandy Springs, GA 30328

**In Canada:**

Mercedes-Benz Canada, Inc.  
Customer Relations Department  
98 Vanderhoof Avenue  
Toronto, Ontario M4G 4C9

### Reporting safety defects

**USA only:**

The following text is published as required of manufacturers under Title 49, Code of U.S. Federal Regulations, Part 575 pursuant to the

"National Traffic and Motor Vehicle Safety Act of 1966".

If you believe that your vehicle has a defect which could cause a crash or could cause injury or death, you should immediately inform the National Highway Traffic Safety Administration (NHTSA) in addition to notifying Mercedes-Benz USA, LLC.

If NHTSA receives similar complaints, it may open an investigation, and if it finds that a safety defect exists in a group of vehicles, it may order a recall and remedy campaign. However, NHTSA cannot become involved in individual problems between you, your dealer, or Mercedes-Benz USA, LLC.

To contact NHTSA, you may call the Vehicle Safety Hotline toll-free at 1-888-327-4236 (TTY: 1-800-424-9153); go to the <https://www.safercar.gov/>; or write to: Administrator, NHTSA, 400 Seventh Street, SW., Washington, DC 20590.; USA.

You can also obtain other information about motor vehicle safety from: <https://www.safercar.gov>

**Canada only:**

The following text is published as required of manufacturers under subsection 18.4 (4) of the Motor Vehicle Safety Regulations.

If you believe that your vehicle has a defect which could cause a crash or could cause injury or death, you should immediately inform Transport Canada in addition to notifying Mercedes-Benz Canada Inc.

If Transport Canada received similar complaints, it may open an investigation, and if it finds that a safety defect exists in a group of vehicles, it may order a recall and remedy campaign. However, Transport Canada cannot become involved in individual problems between you, your dealer or Mercedes-Benz Canada Inc.

To contact Transport Canada, you may call the Defect Investigations and Recalls Division toll-free in Canada at 1-800-333-0510 or 819-994-3328 in the Gatineau-Ottawa area or internationally; you may also go to the following websites for more information:

- English: <https://www.tc.gc.ca/recalls>
- French: <https://www.tc.gc.ca/rappels>

### Limited Warranty

**!** **NOTE** Damage to the vehicle arising from violation of these operating instructions.

Damage to the vehicle can arise from violation of these operating instructions.

This damage is not covered either by the Mercedes-Benz implied warranty or by the New- or Used-Vehicle Warranty.

- ▶ Follow the instructions in these operating instructions on proper operation of your vehicle as well as on possible vehicle damage.

### QR code for rescue card

The QR code is secured in the fuel filler flap and on the opposite side on the B-pillar. In the event of an accident, rescue services can use the QR code to quickly find the appropriate rescue card for your vehicle. The current rescue card contains the most important information about your

vehicle in a compact form, e.g. the routing of the electric lines.

Further information can be obtained at <https://www.mercedes-benz.de/qr-code>.

### Data storage

#### Electronic control units

Electronic control units are installed in your vehicle. Some of these are necessary for the safe operation of your vehicle, while some assist you when driving (driver assistance systems). In addition, your vehicle provides comfort and entertainment functions, which are also made possible by electronic control units.

Electronic control units contain data memories which can temporarily or permanently store technical information about the vehicle's operating state, component loads, maintenance requirements and technical events or malfunctions.

In general, this information documents the state of a component part, a module, a system or the surroundings such as:

- Operating status of system components (e.g. fill levels, battery status, tire pressure)
- Status messages concerning the vehicle or its individual components (e.g. number of wheel revolutions/speed, longitudinal acceleration, lateral acceleration, display of fastened seat belts)
- Malfunctions or faults in important system components (e.g. lights, brakes)
- Information on events leading to vehicle damage
- System reactions in special driving situations (e.g. airbag deployment, intervention of stability control systems)
- Ambient conditions (e.g. temperature, rain sensor)

In addition to providing the actual control unit function, this data assists the manufacturer in detecting and rectifying malfunctions and optimizing vehicle functions. The majority of this

data is temporary and is only processed in the vehicle itself. Only a small portion of the data is stored in the event or fault memory.

When your vehicle is serviced, technical data from the vehicle can be read out by service network employees (e.g. workshops, manufacturers) or third parties (e.g. breakdown services). Services include, for example, repair services, maintenance processes, warranty claims and quality assurance measures. The read out is performed via the legally prescribed port for the diagnostics connection in the vehicle. The respective service network locations or third parties collect, process and use the data. They document technical statuses of the vehicle, assist in finding faults and improving quality and are transmitted to the manufacturer, if necessary. Furthermore, the manufacturer is subject to product liability. For this, the manufacturer requires technical data from vehicles.

Fault memories in the vehicle can be reset by a service outlet as part of repair or maintenance work.

Depending on the selected equipment, you can import data into vehicle convenience and information functions yourself.

This includes, for example:

- Multimedia data such as music, films or photos for playback in an integrated multimedia system
- Address book data for use in connection with an integrated hands-free system or an integrated navigation system
- Entered navigation destinations
- Data about the use of Internet services

This data can be saved locally in the vehicle or it is located on a device which you have connected to the vehicle (e.g. a smartphone, USB flash drive or MP3 player). If this data is stored in the vehicle, you can delete it at any time. This data is sent to third parties only at your request, particularly when you use online services in accordance with the settings that you have selected.

You can store or change convenience settings/individualization in the vehicle at any time.

Depending on the equipment, this includes, for example:

- Settings for the seat and steering wheel positions
- Suspension and climate control settings
- Customizations such as interior lighting

If your vehicle is accordingly equipped, you can connect your smartphone or another mobile end device to the vehicle. You can control this by means of the control elements integrated in the vehicle. Images and audio from the smartphone can be output via the multimedia system. Certain information is simultaneously transferred to your smartphone.

Depending on the type of integration, this can include:

- General vehicle data
- Position data

This allows you to use selected apps on your smartphone, such as navigation or music playback. There is no further interaction between the smartphone and the vehicle; in particular, vehicle data is not directly accessible. Which type of

further data processing occurs is determined by the provider of the specific app used. Which settings you can make, if any, depends on the specific app and the operating system of your smartphone.

### Online services

---

#### Wireless network connection

If your vehicle has a wireless network connection, it enables data to be exchanged between your vehicle and additional systems. The wireless network connection is enabled via the vehicle's transmission and reception unit or via connected mobile end devices (e.g. smartphones). Online functions can be used via the wireless network connection. This includes online services and applications/apps provided by the manufacturer or other providers.

#### Manufacturer's services

Regarding online services of the manufacturer, the individual functions are described by the manufacturer in a suitable place (e.g. Operator's Manual, website of the manufacturer) along with the relevant data protection information. Per-

sonal data may be used for the provision of online services. Data is exchanged via a secure connection, e.g. the manufacturer's designated IT systems. Personal data is collected, processed and used via the provision of services exclusively on the basis of legal permissions or with prior consent.

The services and functions (sometimes subject to a fee) can usually be activated or deactivated. In some cases, this also applies to the entire vehicle's data connection. This excludes, in particular, legally prescribed functions and services.

#### Third party services

If it is possible to use online services from other providers, these services are the responsibility of the provider in question and subject to that provider's data protection conditions and terms of use. The manufacturer has no influence on the content exchanged.

For this reason, please ask the service provider for information about the type, extent and purpose of the collection and use of personal data when services are provided by third parties.

### MBUX multimedia system/Mercedes me connect

---

If the vehicle is equipped with the MBUX multimedia system or Mercedes me connect, additional data about the vehicle's operation, the use of the vehicle in certain situations, and the location of the vehicle may be compiled by the MBUX multimedia system or Mercedes me connect.

For additional information, please refer to the "MBUX multimedia system" section and/or the Mercedes me connect Terms and Conditions.

### Event data recorders

---

#### USA only:

This vehicle is equipped with an event data recorder (EDR). The main purpose of an EDR is to record, in certain crash or near crash-like situations, such as an airbag deployment or hitting a road obstacle, data that will assist in understanding how a vehicle's systems performed. The EDR is designed to record data related to

vehicle dynamics and safety systems for a short period of time, typically 30 seconds or less.

The EDR in this vehicle is designed to record such data as:

- How various systems in your vehicle were operating
- Whether or not the driver and front passenger seat belts were buckled/fastened
- How far (if at all) the driver was depressing the accelerator and/or brake pedal and
- How fast the vehicle was traveling

This data can help provide a better understanding of the circumstances in which accidents and injuries occur. NOTE: EDR data is recorded by your vehicle only if a non-trivial crash situation occurs; no data is recorded by the EDR under normal driving conditions and no personal data (e.g. name, gender, age and accident location) is recorded. However, other parties, such as law enforcement, could combine EDR data with the type of personally identifying data routinely acquired during a crash investigation.

To read data recorded by an EDR, special equipment is required, and access to the vehicle or the EDR is needed. In addition to the vehicle manufacturer, other parties that have the special equipment, such as law enforcement, can read the information by accessing the vehicle or the EDR.

EDR data may be used in civil and criminal matters as a tool in accident reconstruction, accident claims and vehicle safety. Since the Crash Data Retrieval (CDR) tool that is used to extract data from the EDR is commercially available, Mercedes-Benz USA, LLC ("MBUSA") expressly disclaims any and all liability arising from the extraction of this information by unauthorized Mercedes-Benz personnel.

MBUSA will not share EDR data with others without the consent of the vehicle owner or, if the vehicle is leased, without the consent of the lessee. Exceptions to this representation include responses to subpoenas by law enforcement; by federal, state or local government; in connection with or arising out of litigation involving MBUSA or its subsidiaries and affiliates; or, as required by law.

Warning: The EDR is a component of the Restraint System Module. Tampering with, altering, modifying or removing the EDR component may result in a malfunction of the Restraint System Module and other systems.

State laws or regulations regarding EDRs that conflict with federal regulation are pre-empted. This means that in the event of such conflict, the federal regulation governs. As of December 2016, 17 states have enacted laws relating to EDRs.

### Copyright

#### Free and open source software

Information on license for free and open-source software used in your vehicle can be found on the data carrier in your vehicle document wallet and with updates on the following website:

<https://www.mercedes-benz.com/opensource>

### Registered trademarks

- Bluetooth® is a registered trademark of Bluetooth SIG, Inc.
- DTS™ is a registered trademark of DTS, Inc.
- Dolby® and MLP™ are registered trademarks of DOLBY Laboratories.
- BabySmart™, ESP® and PRE-SAFE® are registered trademarks of Mercedes-Benz AG.
- HomeLink® is a registered trademark of Gen-tex Corporation.
- iPod® and iTunes® are registered trademarks of Apple Inc.
- Burmester® is a registered trademark of Burmester Audiosysteme GmbH.
- Microsoft® and Windows Media® are registered trademarks of Microsoft Corporation.
- SIRIUS® is a registered trademark of Sirius XM Radio Inc.
- HD Radio™ is a registered trademark of iBiquity Digital Corporation.
- Gracenote® is a registered trademark of Gracenote, Inc.
- ZAGATSurvey® and related brands are registered trademarks of ZagatSurvey, LLC.



## Restraint system

### Protection provided by the restraint system

The restraint system includes the following components:

- Seat belt system
- Airbags
- Child restraint system
- Child seat securing systems

The restraint system can help prevent the vehicle occupants from coming into contact with parts of the vehicle interior in the event of an accident. In the event of an accident, the restraint system can also reduce the forces to which the vehicle occupants are subjected.

A seat belt can only provide the best level of protection if it is worn correctly. Depending on the detected accident situation, Emergency Tensioning Devices and/or airbags supplement the protection offered by a correctly worn seat belt. Emergency Tensioning Devices and/or airbags are not deployed in every accident.

In order for the restraint system to provide the intended level of protection, each vehicle occupant must observe the following information:

- Fasten seat belts correctly.
- Sit in an almost upright seat position with their back against the seat backrest.
- Sit with their feet resting on the floor, if possible.
- Always secure persons under 5 ft (1.50 m) tall in an additional restraint system suitable for Mercedes-Benz vehicles.

However, no system available today can completely eliminate injuries and fatalities in every accident situation. In particular, the seat belt and airbag generally do not protect against objects penetrating the vehicle from the outside. It is also not possible to completely rule out the risk of injury caused by the airbag deploying.

### Reduced restraint system protection

**⚠ WARNING** Risk of injury or death due to modifications to the restraint system

Vehicle occupants may no longer be protected as intended if alterations are made to the restraint system.

- ▶ Never alter the parts of the restraint system.
- ▶ Never tamper with the wiring or any electronic component parts or their software.

If it is necessary to modify the vehicle to accommodate a person with disabilities, contact an authorized Mercedes-Benz Center for details.

USA only: for details, contact our Customer Assistance Center on 1-800-FOR-MERCEdes (1-800-367-6372).



### Restraint system functionality

When the ignition is switched on, a self-test is performed, during which the  restraint sys-

tem warning lamp lights up. It goes out no later than a few seconds after the vehicle is started. The components of the restraint system are then functional.

### Malfunctioning restraint system

A malfunction has occurred in the restraint system if:

- The  restraint system warning lamp does not light up when the ignition is switched on
- The  restraint system warning lamp lights up continuously or repeatedly during a journey

**⚠ WARNING** Risk of injury due to malfunctions in the restraint system

Components in the restraint system may be activated unintentionally or not deploy as planned in an accident.

- ▶ Have the restraint system checked and repaired immediately at a qualified specialist workshop.

### Function of the restraint system in an accident

How the restraint system works is determined by the severity of the impact detected and the type of accident anticipated:

- Frontal impact
- Rear impact
- Side impact
- Rollover

The activation thresholds for the components of the restraint system are determined based on the evaluation of the sensor values measured at various points in the vehicle. This process is preemptive in nature. The triggering/deployment of the components of the restraint system must take place in good time at the start of the collision.

Factors which can only be seen and measured after a collision has occurred do not play a decisive role in the deployment of an airbag. Nor do they provide an indication of airbag deployment.

The vehicle may be deformed significantly without an airbag being deployed. This is the case if

only parts which are relatively easily deformed are affected and the rate of vehicle deceleration is not high. Conversely, an airbag may be deployed even though the vehicle suffers only minor deformation. If very rigid vehicle parts such as longitudinal members are hit, this may result in sufficiently high levels of vehicle deceleration.

Depending on the detected deployment situation, the components of the restraint system can be activated or deployed independently of each other:

- Emergency Tensioning Device: frontal impact, rear impact, side impact, rollover
- Driver's airbag, front passenger airbag: frontal impact
- Knee airbag: frontal impact
- Side airbag: side impact
- Window curtain airbag: side impact, rollover, frontal impact

The front passenger airbag can only be deployed in an accident if the PASSENGER AIR BAG OFF indicator lamp is off. If the front passenger seat

is occupied, make sure, both before and during the journey, that the status of the front passenger airbag is correct (→ page 42).

**▲ WARNING** Risk of burns from hot air bag components

The air bag parts are hot after an air bag has been deployed.

- ▶ Do not touch the air bag parts.
- ▶ Have a deployed air bag replaced at a qualified specialist workshop as soon as possible.

Mercedes-Benz recommends that you have the vehicle towed to a qualified specialist workshop after an accident. Take this into account, particularly if an Emergency Tensioning Device is triggered or an airbag deployed.

If the Emergency Tensioning Devices are triggered or an airbag is deployed, you will hear a bang, and a small amount of powder may also be released:

- The bang will not generally affect your hearing.

- In general, the powder released is not hazardous to health but may cause short-term breathing difficulties to persons suffering from asthma or other pulmonary conditions. Provided it is safe to do so, leave the vehicle immediately or open the window in order to prevent breathing difficulties.

Airbags and pyrotechnic Emergency Tensioning Devices contain perchlorate material, which may require special handling or environmental protection measures. National guidelines regarding waste disposal must be observed. In California, see <https://dtsc.ca.gov/>. Using the search function, you will find information on perchlorate, for example.

## Seat belts

### Protection provided by the seat belt

Always fasten your seat belt correctly before starting a journey. A seat belt can only provide the best level of protection if it is worn correctly.

**▲ WARNING** Risk of injury or death due to incorrectly fastened seat belt

If the seat belt is not worn correctly, it cannot perform its intended protective function. In addition, an incorrectly fastened seat belt can also cause injuries, for example, in the event of an accident or when braking or changing direction suddenly.

- ▶ Always ensure that all vehicle occupants have their seat belts fastened correctly and are sitting properly.

Always observe the instructions about the correct driver's seat position and adjusting the seat (→ page 84).

In order for the correctly worn seat belt to provide the intended level of protection, each vehicle occupant must observe the following information:

- The seat belt must not be twisted and must fit tightly and snugly across the body.

## 34 Occupant safety

- The seat belt must be routed across the center of the shoulder and as low down across the hips as possible.
- The shoulder section of the seat belt should not touch your neck nor be routed under your arm or behind your back.
- Avoid wearing bulky clothing, e.g. a winter coat.
- Push the lap belt down as far as possible across your hips and pull tight with the shoulder section of the belt. Never route the lap belt across your abdomen.

Pregnant women must also take particular care with this.

- Never route the seat belt across sharp, pointed, abrasive or fragile objects.
- Only one person should use each seat belt at any one time. Never allow babies and children to travel sitting on the lap of another vehicle occupant.
- Never secure objects with a seat belt if the seat belt is also being used by one of the vehicle's occupants. Always observe the instructions for loading the vehicle when

securing objects, luggage or loads (→ page 98).

Also ensure that no objects, e.g. a cushion, are ever placed between a person and the seat.

The seat belts on the following seats are equipped with a special seat belt retractor:

- Front passenger seat
- Rear seats

Activate or deactivate the special seatbelt retractor (→ page 50).

If children are traveling in the vehicle, be sure to observe the instructions and safety notes on "Children in the vehicle" (→ page 47).

### Limitations of the protection provided by the seat belt

**⚠ WARNING** Risk of injury or death due to an incorrect seat position

The seat belt does not offer the intended level of protection if you have not moved the seat backrest to an almost vertical position.

You could slip beneath the seat belt and injure yourself.

- ▶ Adjust the seat properly before commencing your journey.
- ▶ Always ensure that the seat backrest is in an almost vertical position and that the shoulder belt is routed across the center of your shoulder.

**⚠ WARNING** Risk of injury or death when additional restraint systems are not used for persons with a smaller stature

Persons under 5 ft (1.50 m) tall cannot wear the seat belt correctly without a suitable additional restraint system.

- ▶ Always secure persons under 5 ft (1.50 m) tall in a suitable restraint system.

**⚠ WARNING** Risk of injury or death due to damaged or modified seat belts

Seat belts cannot provide protection in the following situations:

- The seat belt is damaged, has been modified, is extremely dirty, bleached or dyed
- The seat belt buckle is damaged or extremely dirty
- Modifications have been made to the Emergency Tensioning Device, seat belt anchorage or seat belt retractor

Seat belts may sustain non-visible damage in an accident, e.g. due to glass splinters.

Modified or damaged seat belts could tear or fail in the event of an accident, for example.

Modified Emergency Tensioning Devices may be deployed unintentionally or not function as intended.

- ▶ Never modify the seat belts, Emergency Tensioning Devices, seat belt anchorages or seat belt retractors.
- ▶ Make sure that the seat belts are not damaged, are not worn and are clean.
- ▶ Always have the seat belts checked immediately after an accident at a qualified specialist workshop.

Only use seat belts which have been approved for your vehicle by Mercedes-Benz.

**⚠ WARNING** Risk of injury or death from deployed pyrotechnic Emergency Tensioning Devices

Pyrotechnic Emergency Tensioning Devices that have been deployed are no longer operational and are unable to perform their intended protective function.

- ▶ Therefore, have deployed pyrotechnic Emergency Tensioning Devices immediately replaced at a qualified specialist workshop.

Mercedes-Benz recommends that you have the vehicle towed to a qualified specialist workshop after an accident.

**!** **NOTE** Damage caused by trapping the seat belt

If an unused seat belt is not fully retracted, it may become trapped in the door or in the seat mechanism.

- ▶ Always ensure that an unused seat belt is fully retracted.

### Fastening seat belts

If the seat belt is pulled quickly or sharply, the seat belt retractor locks. The seat belt strap cannot be pulled out any further.



- ▶ Always engage seat belt tongue ② of the seat belt into seat belt buckle ① of the corresponding seat.

**Vehicles with automatic front passenger airbag shutoff:**

**!** **NOTE** Deployment of the Emergency Tensioning Device and side air bag when the front passenger seat is unoccupied

If the seat belt tongue is engaged in the seat belt buckle of the unoccupied front passenger seat, the Emergency Tensioning Device and the side air bag may also deploy in the event of an accident along with other systems.

- ▶ Only one person should use each seat belt at any one time.

**Vehicles without automatic front passenger airbag shutoff:**

**!** **NOTE** Deployment of the Emergency Tensioning Device when the front-passenger seat is unoccupied

If the seat belt tongue is engaged in the seat belt buckle of the unoccupied front-passenger seat, the Emergency Tensioning Device may also deploy in the event of an accident along with other systems.

- ▶ Only one person should use each seat belt at any one time.

### Seat belt adjustment function

**Vehicles with PRE-SAFE®:** If the front seat belt is not pulled tightly across your body, the seat belt adjustment may automatically apply a certain tightening force. Do not hold the seat belt tightly while it is adjusting.

You can activate and deactivate the seat belt adjustment function using the multimedia system (→ page 37).

### Releasing seat belts

- ▶ Press the release button in the seat belt buckle and guide the seat belt back with the seat belt tongue.

### Activating/deactivating seat belt adjustment via the multimedia system

Multimedia system:

→ [Home] >> Settings >> Vehicle

▶ Activate or deactivate **Belt Adjustment**.

### Seat belt warning function for the driver and front passenger

The  seat belt warning lamp in the instrument display is a reminder that all vehicle occupants must wear their seat belts correctly.

The  seat belt warning lamp lights up for six seconds every time the vehicle is started.

In addition, a warning tone may sound.

When the driver's and front passenger's doors are closed and the driver and front passenger have fastened their seat belts, the seat belt warning goes out.

In the following cases, the seat belt warning lights up during a journey if:

- The vehicle speed exceeds 15 mph (25 km/h) and the driver's or front passenger seat belt is not fastened.
- The driver or front passenger unfastens their seat belt while the vehicle is in motion.

### Airbags

#### Overview of airbags

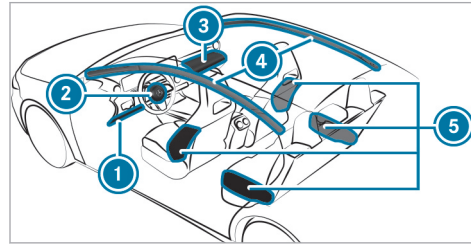

- ① Knee airbag
- ② Driver's airbag

- ③ Front passenger airbag
- ④ Window curtain airbag
- ⑤ Side airbag

The installation location of an airbag is identified by the AIRBAG symbol.

When enabled, an airbag can provide additional protection for the respective vehicle occupant.

Potential protection provided by each airbag:

- Knee airbag: thigh, knee and lower leg
- Driver's airbag, front passenger airbag: head and ribcage
- Window curtain airbag: head
- Side airbag: ribcage and pelvis

**Mercedes-AMG vehicles:** observe the notes in the Supplement. You could otherwise fail to recognize dangers.

**⚠ WARNING** Risk of injury or fatal injuries if the front passenger airbag is enabled

If the front passenger airbag is enabled, a child on the front passenger seat may be

struck by the front passenger airbag during an accident.

NEVER use a rearward facing child restraint system on a seat protected by an ENABLED FRONT AIRBAG in front of it, this can result in DEATH or SERIOUS INJURY to the child.

When installing a child restraint system on the front passenger seat, observe the vehicle-specific information (→ page 56). Also, always observe the notes on rearward-facing or forward-facing child restraint systems on the front passenger seat.

#### Information on automatic front passenger airbag shutoff

The front passenger airbag can only be deployed in an accident if the PASSENGER AIR BAG OFF indicator lamp is off. If the front passenger seat is occupied, make sure, both before and during the journey, that the status of the front passenger airbag is correct (→ page 42).

**!** **NOTE** Important points to remember if the front passenger seat is unoccupied

In an accident, the components of the restraint system may deploy unnecessarily on the front passenger side if:

- There are heavy objects on the front passenger seat.
- The seat belt tongue is engaged in the seat belt buckle of the front passenger seat and the front passenger seat is unoccupied.

- ▶ Stow objects in a suitable place.
- ▶ Only one person should use each seat belt at any one time.

Depending on the detected accident situation, the window curtain airbag on the front passenger side may deploy. The airbag is deployed regardless of whether the front passenger seat is occupied.

#### Protection provided by the airbags

Depending on the accident situation, an airbag may supplement the protection provided by a correctly fastened seat belt.

**!** **WARNING** Risk of injury or death due to an incorrect seat position

If you deviate from the correct seat position, the airbag cannot perform its intended protective function.

Each vehicle occupant must make sure of the following:

- Fasten seat belts correctly. Pregnant women must take particular care to ensure that the lap belt never lies across the abdomen.
  - Adopt the correct seat position and keep as far away as possible from the airbags.
  - Observe the following information.
- ▶ Always make sure that there are no objects between the airbag and vehicle occupant.



To avoid the risks resulting from the deployment of an airbag, each vehicle occupant must observe the following information in particular:

- Before starting your journey, adjust your seat correctly; the driver's seat and front passenger seat should be moved as far back as possible.

When doing so, always observe the information on the correct driver's seat position (→ page 84).

- Only hold the steering wheel by the steering wheel rim. This allows the airbag to be fully deployed.
- Always lean against the seat backrest when the vehicle is in motion. Do not lean forwards or against the door or side window. You may otherwise be in the deployment area of the airbags.
- Always keep your feet on the floor. Do not put your feet on the cockpit, for example. Your feet may otherwise be in the deployment area of the airbag.
- If children are traveling in the vehicle, observe the additional notes (→ page 47).

- Always stow and secure objects correctly.

Objects in the vehicle interior may prevent an airbag from functioning correctly. Each vehicle occupant must always make sure of the following in particular:

- There are no people, animals or objects between the vehicle occupants and an airbag.
- There are no objects between the seat, door and door pillar (B-pillar).
- There are no hard objects, e.g. coat hangers, hanging on the grab handles or coat hooks.
- There are no accessory parts, such as mobile navigation devices, mobile phones or cup holders, attached to the vehicle within the deployment area of an airbag, e.g. on the cockpit, on the door, on the side window or on the side wall trim.

In addition, no connecting cables, tensioning straps or retaining straps must be routed or attached to the vehicle within the deployment area of an airbag. Always comply with the accessory manufacturer's installation

instructions and, in particular, the notes on suitable places for installation.

- There are no heavy, sharp-edged or fragile objects in the pockets of your clothing. Store such objects in a suitable place.

### Limited protection provided by airbags

**⚠ WARNING** Risk of injury due to modifications to the cover of an airbag

If you modify the cover of an airbag or affix objects such as stickers to it, the airbag may no longer function correctly.

- ▶ Never modify the cover of an airbag and do not affix objects to it.

The installation location of an airbag is identified by the airbag symbol (→ page 37).

**▲ WARNING** Risk of injury or death due to the use of unsuitable seat covers

Due to unsuitable seat covers, the airbags cannot protect vehicle occupants as intended.

In addition, the operation of the automatic front passenger airbag shutoff could be restricted.

- ▶ You should only use seat covers that have been approved for the corresponding seats by Mercedes-Benz.

**▲ WARNING** Risk of injury due to malfunctioning sensors in the door

The function of the airbags can be impaired due to modifications or incorrect work performed on the doors or door trim, or if the doors are damaged.

- ▶ Never modify the doors or parts of the doors.

- ▶ Always have work on the doors or door trim carried out at a qualified specialist workshop.

**▲ WARNING** Risk of injury due to deployed airbag

A deployed airbag no longer offers any protection.

- ▶ Have the vehicle towed to a qualified specialist workshop in order to have the deployed airbag replaced.

Have deployed airbags replaced immediately.

### Status of the front passenger front airbag

#### **Function of the automatic front passenger airbag shutoff**

The automatic front passenger airbag shutoff is able to detect whether the front passenger seat is occupied by a person or a child restraint system. The front passenger airbag is enabled or disabled accordingly.

When installing a child restraint system on the front passenger seat, always make sure of the following:

- Ensure that the child restraint system is positioned correctly (→ page 46).
- Always comply with the child restraint system manufacturer's installation instructions.
- Never place objects (e.g. cushions) under or behind the child restraint system.
- Fully retract the seat cushion length adjustment.
- The entire base of the child restraint system must always rest on the sitting surface of the front passenger seat.
- The backrest of the forward-facing child restraint system must, as far as possible, be resting on the seat backrest of the front passenger seat.
- The child restraint system must not touch the roof or be put under strain by the head restraints. Adjust the seat backrest inclination and the head restraint setting accordingly.

**▲ WARNING** Risk of injury or death due to objects between the seat surface and the child restraint system

Objects between the sitting surface and the child restraint system could affect the function of the automatic front passenger airbag shutoff.

- ▶ Do not place any objects between the sitting surface and the child restraint system.
- ▶ The entire base of the child restraint system must always rest on the sitting surface of the front passenger seat.
- ▶ The backrest of the forward-facing child restraint system must, as far as possible, be resting on the seat backrest of the front passenger seat.
- ▶ Always comply with the child restraint system manufacturer's installation instructions.

A person on the front passenger seat must observe the following information:

- Fasten seat belts correctly (→ page 33).
- Sit in an almost upright seat position with their back against the seat backrest.
- Sit with their feet resting on the floor, if possible.

The front passenger airbag may otherwise be disabled by mistake, for example, in the following situations:

- The front passenger transfers their weight by supporting themselves on a vehicle armrest.
- The front passenger sits in such a way that their weight is raised from the sitting surface.

**▲ WARNING** Risk of injury or death due to a disabled front passenger airbag

The front passenger airbag is disabled when the PASSENGER AIR BAG OFF indicator lamp is lit.

A person in the front passenger seat could then, for example, come into contact with the vehicle interior, especially if the person is sitting too close to the cockpit.

If the front passenger seat is occupied, always ensure that:

- The classification of the person in the front passenger seat is correct and the front passenger airbag is enabled or disabled in accordance with the person in the front passenger seat.
  - The front passenger seat has been moved as far back as possible.
  - The person is seated correctly.
- ▶ Both before and during the journey, ensure that the status of the front passenger airbag is correct.

If the front passenger seat is occupied, the classification of the person or child restraint system on the front passenger seat takes place after the front passenger airbag shutoff self-test. The PASSENGER AIR BAG indicator lamps display the status of the front passenger airbag.

Always observe the notes on the function of the PASSENGER AIR BAG indicator lamps (→ page 42).

### Function of the PASSENGER AIR BAG indicator lamps



### Self-test of automatic front passenger airbag shutoff

When the ignition is switched on, a self-test is performed during which the two PASSENGER AIR BAG ON and OFF indicator lamps light up simultaneously.

The status of the front passenger airbag is displayed via the PASSENGER AIR BAG indicator lamps after the self-test:

- **ON is lit:** the front passenger airbag may deploy during an accident.  
The indicator lamp goes out after approximately 60 seconds.
- **ON and OFF are not lit:** the front passenger airbag may deploy during an accident.
- **OFF is lit:** the front passenger airbag is disabled. It will then not be deployed in the event of an accident.

If the PASSENGER AIR BAG ON indicator lamp is off, only the PASSENGER AIR BAG OFF indicator lamp shows the status of the front passenger airbag. The PASSENGER AIR BAG OFF indicator lamp may be lit continuously or be off.

If the PASSENGER AIR BAG OFF indicator lamp and the  restraint system warning lamp light up simultaneously, the front passenger seat may not be used. Also in this case, do not install a child restraint system on the front passenger seat. Have the automatic front passenger airbag shutoff checked and repaired immediately at a qualified specialist workshop.

### Status display

If the front passenger seat is occupied, ensure, both before and during the journey, that the status of the front passenger airbag is correct for the current situation.

**After installing a rearward-facing child restraint system on the front passenger seat:** PASSENGER AIR BAG OFF must be lit continuously.

**▲ WARNING** Risk of injury or death when using a rearward-facing child restraint system while the front passenger airbag is enabled

If you secure a child in a rearward-facing child restraint system on the front passenger seat and the PASSENGER AIR BAG OFF indicator lamp is off, the front passenger airbag can deploy in the event of an accident.

The child could be struck by the airbag.

Always ensure that the front passenger airbag is disabled. The PASSENGER AIR BAG OFF indicator lamp must be lit.

NEVER use a rearward-facing child restraint system on a seat with an ENABLED FRONT AIRBAG; DEATH or SERIOUS INJURY to the CHILD can occur.

When installing a child restraint system on the front passenger seat, observe the vehicle-specific information (→ page 56).

Depending on the child restraint system and the stature of the child, the PASSENGER AIR BAG OFF indicator lamp may be off. In this case, do

not install the rearward-facing child restraint system on the front passenger seat.

Instead, install the rearward-facing child restraint system on a suitable rear seat.

**After installing a forward-facing child restraint system on the front passenger seat:** depending on the child restraint system and the stature of the child, PASSENGER AIR BAG OFF may be lit continuously or be off. Always observe the following information.

**▲ WARNING** Risk of injury or death due to incorrect positioning of the forward-facing child restraint system

If you secure a child in a forward-facing child restraint system on the front passenger seat that is positioned too close to the cockpit, in the event of an accident, the child could:

- come into contact with parts of the vehicle's interior if the PASSENGER AIR BAG OFF indicator lamp is lit, for example
- be struck by the airbag if the PASSENGER AIR BAG OFF indicator lamp is off

- ▶ Always move the front passenger seat as far back as possible and fully retract the seat cushion length adjustment. While doing so, always make sure that the shoulder belt strap is correctly routed from the seat belt outlet of the vehicle to the shoulder belt guide on the child restraint system. The shoulder belt strap must be routed forwards and downwards from the seat belt outlet. If necessary, adjust the front passenger seat accordingly.
- ▶ Always comply with the child restraint system manufacturer's installation instructions.

When installing a child restraint system on the front passenger seat, observe the vehicle-specific information (→ page 56).

**If a person is sitting on the front passenger seat:** PASSENGER AIR BAG OFF may be lit continuously or be off, depending on the person's stature.

## 44 Occupant safety

A person on the front passenger seat must always observe the following information:

- If the front passenger seat is occupied by an adult or a person with a stature corresponding to that of an adult, the PASSENGER AIR BAG OFF indicator lamp must be off. This indicates that the front passenger airbag is enabled.

If the PASSENGER AIR BAG OFF indicator lamp is lit continuously, an adult or person with a build corresponding to that of an adult should not use the front passenger seat.

Instead, they should use a rear seat.

- If the front passenger seat is occupied by a person of smaller stature (e.g. a teenager or small adult), the PASSENGER AIR BAG OFF indicator lamp either lights up continuously or remains off, depending on the classification.
  - If the PASSENGER AIR BAG OFF indicator lamp is off: move the front passenger seat as far back as possible, or the person of smaller stature should use a rear seat.

- If the PASSENGER AIR BAG OFF indicator lamp is lit continuously: the person of smaller stature should not use the front passenger seat.

**⚠ WARNING** Risk of injury or death when the PASSENGER AIR BAG OFF indicator lamp is lit

If the PASSENGER AIR BAG OFF indicator lamp remains lit after the self-test, the front passenger airbag is disabled.

If the front passenger seat is occupied, always ensure that:

- The classification of the person in the front passenger seat is correct and the front passenger airbag is enabled or disabled in accordance with the person in the front passenger seat.
- The person is seated properly with a correctly fastened seat belt.

Be sure to also observe the following further related subjects:

- Securing the child restraint system on the front passenger seat (→ page 56)

### PRE-SAFE® system

#### PRE-SAFE® (anticipatory occupant protection)

PRE-SAFE® is able to detect certain critical driving situations and implement pre-emptive measures to protect the vehicle occupants.

PRE-SAFE® can implement the following measures independently of each other:

- Tightening the seat belts on the driver's seat and front passenger seat.
- Closing the side windows.
- **Vehicles with sliding sunroof:** Close the sliding sunroof.
- **Vehicles with memory function:** Move the front passenger seat to a more favorable seat position.

- PRE-SAFE® Sound: provided that the multi-media system is switched on, generates a brief noise signal to stimulate the innate protective mechanism of a person's hearing.

**!** **NOTE** Damage caused by objects in the footwell or behind the seat

The automatic adjustment of the seat position may result in damage to the seat and/or the object.

- ▶ Stow objects in a suitable place.

### Reversing the PRE-SAFE® system measures

If an accident did not occur, the pre-emptive measures that were taken are reversed.

You will need to perform certain settings yourself.

- ▶ If the seat belt pre-tensioning is not reduced, move the seat backrest back slightly. The locking mechanism releases.

### Function of PRE-SAFE® PLUS (anticipatory occupant protection plus)

PRE-SAFE® PLUS can detect certain impacts, particularly an imminent rear impact, and take pre-emptive measures to protect the vehicle occupants. These measures cannot necessarily prevent an imminent impact.

PRE-SAFE® PLUS can implement the following measures independently of each other:

- Tightening the seat belts on the driver's seat and front passenger seat.
- Increasing brake pressure when the vehicle is stationary. This brake application is canceled automatically when the vehicle pulls away.

If an accident did not occur, the pre-emptive measures that were taken are reversed.

### System limits

The system will not initiate any action in the following situations:

- when backing up

The system will not initiate any braking application in the following situations:

- whilst driving  
or
- when entering or exiting a parking space while using Active Parking Assist

### Automatic measures after an accident

Depending on the type and severity of the accident, and depending on the vehicle's equipment, the following measures can be implemented, for example:

- Automatic braking (post-collision brake)
- Activating the hazard warning lights
- Triggering an automatic emergency call (→ page 222)
- Switching off the engine

To restart the vehicle, switch the ignition off and switch it back on (→ page 133).

Depending on the type and severity of the accident, it is possible that the vehicle can no longer be started.

- Switching off the fuel supply
- Unlocking the vehicle doors
- Lowering the side windows
- Displaying the emergency guide in the multi-media system display
- Switching on the interior lighting

#### Function of the post-collision brake

Depending on the accident situation, the post-collision brake can minimize the severity of a further collision or even avoid it.

If an accident is detected, the post-collision brake can implement automatic braking. When the vehicle has come to a standstill, the electric parking brake is automatically applied.

The driver can cancel automatic braking by taking the following actions:

- Braking more strongly than automatic braking
- Fully depressing the accelerator pedal with force

#### Safely transporting children in the vehicle

##### Always observe when children are traveling in the vehicle

- ❗ Also strictly observe the safety notes for the specific situation. In this way you can recognize potential risks and avoid dangers if children are traveling in the vehicle (→ page 47).

#### Be diligent

Bear in mind that negligence when securing the child in the child restraint system may have serious consequences. Always be diligent in securing a child carefully before every journey.

To improve protection for children younger than twelve years old or under 5 ft (1.50 m) in height, Mercedes-Benz recommends you observe the following information:

- Always secure the child in a child restraint system suitable for this Mercedes-Benz vehicle.
- The child restraint system must be appropriate to the age, weight and size of the child.

- The vehicle seat must be suitable for installing a child restraint system.

Accident statistics show that children secured on the rear seats are generally safer than children secured on the front seats. For this reason, Mercedes-Benz strongly advises that you install a child restraint system on a rear seat.

#### The generic term child restraint system

The generic term child restraint system is used in this Operator's Manual. A child restraint system is, for example:

- a baby car seat
- a rearward-facing child seat
- a forward-facing child seat
- a child booster seat with a backrest and seat belt guide

Mercedes-Benz recommends using a child booster seat with a backrest.

The child restraint system must be appropriate to the age, weight and size of the child.



**Observe laws and legal requirements**

Always observe the legal requirements when using a child restraint system in the vehicle.

**Observe standards for child restraint systems**

All child restraint systems must meet the following standards:

- U.S. Federal Motor Vehicle Safety Standards 213 and 225
- Canadian Motor Vehicle Safety Standards 213 and 210.2

Confirmation that the child restraint system complies with the standards can be found on an instruction label on the child restraint system. This confirmation can also be found in the installation instructions that are included with the child restraint system.

**Detecting risks, avoiding danger****Securing systems for child restraint systems in the vehicle**

Only use the following securing systems for child restraint systems:

- the LATCH-type (ISOFIX) mounting brackets
- the vehicle's seat belt system
- the Top Tether anchorages

Installing a LATCH-type (ISOFIX) child restraint system is preferred.

Simply attaching to the securing rings on the vehicle can reduce the risk of installing the child restraint system incorrectly.

When securing a child with the integrated seat belt of the LATCH-type (ISOFIX) child restraint system, always comply with the permissible gross weight for the child and child restraint system (→ page 51).

A booster seat may be necessary to achieve proper seat belt positioning for children over 40 lbs (18 kg) in weight or until they reach a

height where a three-point seat belt can be fastened properly without a booster seat.

Mercedes-Benz recommends a suitable child booster seat with a backrest and seat belt guide.

**Advantage of a rearward-facing child restraint system**

It is preferable to transport a baby or a small child in a suitable rearward-facing child restraint system. In this case, the child sits in the opposite direction to the direction of travel and faces backwards.

Babies and small children have comparatively weak neck muscles in relation to the size and weight of their head. The risk of injury to the cervical spine during an accident can be reduced in a rearward-facing child restraint system.

### Always secure a child restraint system correctly

**⚠ WARNING** Risk of injury or death due to incorrect installation of the child restraint system

The child can then not be protected or restrained as intended.

- ▶ Be sure to comply with the manufacturer's installation instructions for the child restraint system and its correct use.
- ▶ Make sure that the entire base of the child restraint system always rests on the sitting surface of the seat.
- ▶ Never place objects (e.g. cushions) under or behind the child restraint system.
- ▶ Use child restraint systems only with the original cover designed for them.
- ▶ Always replace damaged covers with genuine covers.

**⚠ WARNING** Risk of injury or death due to unsecured child restraint systems in the vehicle

If the child restraint system is incorrectly installed or not secured, it can come loose.

The child restraint system could be flung around and hit vehicle occupants.

- ▶ Always install child restraint systems correctly, even when not in use.
  - ▶ Always comply with the child restraint system manufacturer's installation instructions.
- Always observe the child restraint system manufacturer's installation and operating instructions as well as the vehicle-specific information:
    - Installing the LATCH-type (ISOFIX) child restraint system on the rear seat (→ page 51).
    - Securing the child restraint system with the seat belt on the rear seat (→ page 54).

- Securing the child restraint system with the seat belt on the front passenger seat (→ page 56). Observe the specific instructions for the rearward-facing and forward-facing child restraint systems (→ page 56).

If the front passenger seat is occupied, ensure, both before and during the journey, that the status of the front passenger airbag is correct for the current situation (→ page 42).

- Observe the warning labels in the vehicle interior and on the child restraint system.
- Also secure Top Tether if present.

### Do not alter the child restraint system

**⚠ WARNING** Risk of injury due to modifications to the child restraint system

The child restraint system can no longer function properly. This poses an increased risk of injury.

- ▶ Never modify a child restraint system.

- ▶ Only affix accessories which have been specially approved for this child restraint system by the child restraint system's manufacturer.

### Only use child restraint systems which are in proper working condition

- ▲ **WARNING** Risk of injury or death caused by the use of damaged child restraint systems

Child restraint systems or their retaining systems that have been subjected to stress in an accident may not be able to perform their intended protective function.

It may be the case that the child cannot be properly restrained.

- ▶ Always immediately replace child restraint systems that have been damaged or involved in an accident.
- ▶ Have the securing systems for the child restraint systems checked at a qualified specialist workshop before installing a child restraint system again.

### Avoid direct sunlight

- ▲ **WARNING** Risk of burns when the child seat is exposed to direct sunlight

If the child restraint system is exposed to direct sunlight or heat, parts could heat up. Children could suffer burns from these parts, particularly on the metallic parts of the child restraint system.

- ▶ Always make sure that the child restraint system is not exposed to direct sunlight.
- ▶ Protect the child restraint system with a blanket, for example.
- ▶ If the child restraint system has been exposed to direct sunlight, allow it to cool before securing a child into it.
- ▶ Never leave children unattended in the vehicle.

### Observe when stopping or parking

- ▲ **WARNING** Risk of accident and injury due to children left unattended in the vehicle

If children are left unsupervised in the vehicle, they could, in particular:

- Open doors, thereby endangering other persons or road users.
- Get out and be struck by oncoming traffic.
- Operate vehicle equipment and become trapped, for example.

In addition, the children could also set the vehicle in motion, for example by:

- Releasing the parking brake.
- Change the transmission position.
- Start the vehicle.
- ▶ Never leave children unattended in the vehicle.

- ▶ When leaving the vehicle, always take the SmartKey with you and lock the vehicle.
- ▶ Keep the SmartKey out of reach of children.

**⚠ WARNING** Risk of fatal injury due to exposure to extreme heat or cold in the vehicle



If people – particularly children – are exposed to extreme temperatures over an extended period of time, there is a risk of serious or even fatal injury.

- ▶ Never leave anyone – particularly children – unattended in the vehicle.
- ▶ Never leave animals in the vehicle unattended.

### Overview of suitable seats in the vehicle for installing a child restraint system

#### Left/right rear seat

Preferred securing system:

-  LATCH-type (ISOFIX) child seat securing system
-  Also secure Top Tether if present (→ page 53)

Alternative securing system:

-  Vehicle seat belt

#### Front passenger seat

Securing system:

-  Vehicle seat belt



Be sure to observe:

- If the front passenger seat is occupied, ensure, both before and during the journey, that the status of the front passenger airbag is correct for the current situation (→ page 42).

- Observe the notes on automatic front passenger airbag shutoff (→ page 40)

#### Center rear seat

Securing system:

-  Vehicle seat belt
-  Also secure Top Tether if present (→ page 53)

### Activating or deactivating the child seat safety feature of the seat belt

**⚠ WARNING** Risk of injury or death if a seat belt is unfastened while the vehicle is in motion

If the seat belt is released while the vehicle is in motion, the child safety lock is deactivated and the child restraint system is no longer correctly secured. The seat belt is retracted slightly by the inertia reel and cannot be immediately fastened again.

- ▶ Stop the vehicle immediately in accordance with the traffic conditions.

- ▶ Activate the special seat belt retractor again and correctly secure the child restraint system.

When enabled, the child seat safety feature ensures that the seat belts of the front passenger seat and rear seats do not slacken once the child restraint system is secured.

The seat belts on the following seats are equipped with a child seat safety feature:

- Front passenger seat
- Rear seats

- ▶ **To install a child restraint system:** when installing a child restraint system, always observe the manufacturer's installation and operating instructions as well as the information in this Operator's Manual.
- ▶ Pull the seat belt smoothly from the seat belt outlet.
- ▶ Engage the seat belt tongue in the seat belt buckle.

- ▶ **To activate the child seat safety feature:** pull the seat belt out fully and let the inertia reel retract it again. When the child seat safety feature is activated, you will hear a ratcheting sound.
- ▶ Push the child restraint system down until the seat belt sits tightly.
- ▶ **To deactivate the child seat safety feature:** press the release button of the seat belt buckle.
- ▶ Hold the seat belt tongue and guide back to the seat belt outlet.

### Installing a LATCH-type (ISOFIX) child restraint system on the rear seat

#### Installing a LATCH-type (ISOFIX) child restraint system on the rear seat

- ⚠ **WARNING** Risk of accident if the rear bench seat, rear seat and seat backrest are not engaged

The rear bench seat, rear seat and seat backrest may fold forwards, even when you are driving.

- As a result, the vehicle occupant will be pushed into the seat belt with increased force. The seat belt will not be able to protect as intended and could cause additional injury.
- Objects or loads in the trunk or cargo compartment will not be restrained by the seat backrest.
- ▶ Make sure that the rear bench seat, the rear seat and the seat backrest are engaged before every trip.

If the rear seat backrest is not engaged and locked in place, the red lock verification indicator will be visible.

**⚠ WARNING** Risk of injury or death if the permissible gross mass of the child and child restraint system is exceeded

Too much load may be placed on the LATCH-type (ISOFIX) child seat securing systems and the child may not be restrained in the event of an accident, for example.

- ▶ If the child and the child restraint system together weigh more than the permissible gross mass of 73 lb (33 kg), use only a LATCH-type (ISOFIX) child restraint system that secures the child with the vehicle seat belt.
- ▶ Also secure the child restraint system with the Top Tether belt, if available.

Always comply with the information about the mass of the child restraint system:

- in the manufacturer's installation and operating instructions for the child restraint system used
- on a label on the child restraint system, if present

Regularly check that the permissible gross mass of the child and child restraint system is still complied with.

When installing a child restraint system, observe the following:

- ☑ Always observe the correct use of the seats and consider their suitability for attaching a child restraint system.
- ☑ Always comply with the manufacturer's installation and operating instructions for the child restraint system used.
- ☑ Make sure that the child's feet do not touch the front seat. If necessary, move the front seat slightly forwards.

 When installing a LATCH-type (ISOFIX) child restraint system, also observe the following:

- ☑ **When using a Group 0/0+ baby car seat and a Group I rearward-facing child restraint system on a rear seat:** adjust the front seat so that the seat does not touch the child restraint system.
- ☑ **When using a Group I forward-facing child restraint system:** remove the head restraint from the respective seat, if possible. In addition, the backrest of the child restraint system must lie as flat as possible against the backrest of the vehicle seat. After the child restraint system has been removed, replace the head restraint immediately and adjust all head restraints correctly.
- ☑ For certain child restraint systems in weight group II or III, there may be restrictions on the maximum size setting, e.g. due to possible contact with the roof.
- ☑ The child restraint system must not be installed between the roof and the seat

cushion and/or be installed facing the wrong direction. Where possible, adjust the seat cushion inclination accordingly.

- ✓ The child restraint system must not be put under strain by the head restraint. Adjust the head restraints accordingly.

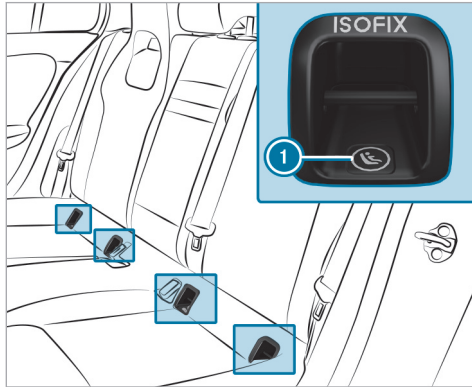

① LATCH-type (ISOFIX) mounting bracket

Before every journey, make sure that the LATCH-type (ISOFIX) child restraint system is engaged correctly in both mounting brackets in the vehicle.

- ! **NOTE** Damage to the seat belt for the center seat during installation of the child restraint system
- ▶ Make sure that the seat belt is not trapped.

- ▶ Attach the LATCH-type (ISOFIX) child restraint system to both mounting brackets in the vehicle.

### Securing a Top Tether

- ! **WARNING** Risk of injury or death if the rear seat backrests are not locked after installing Top Tether belts

The rear seat backrests may fold forwards when driving.

In this case, child restraint systems may no longer perform their intended protective function. Additional injuries may also be caused.

- ▶ Always lock rear seat backrests after installing Top Tether belts.
- ▶ Pay attention to the lock verification indicator.

If the rear seat backrest is not engaged and locked in place, the red lock verification indicator will be visible.

- 🚗 If the child restraint system is equipped with a Top Tether belt:

The risk of injury can be reduced by a Top Tether. The Top Tether belt enables an additional connection between the child restraint system attached with LATCH-type (ISOFIX) and the vehicle.

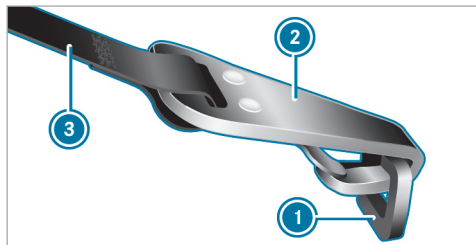
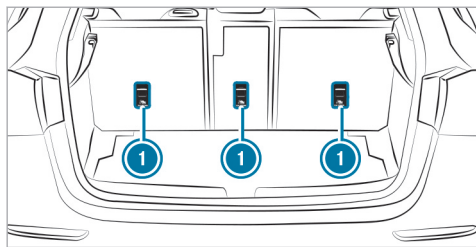

**Vehicles with adjustable head restraints:**

- ▶ If necessary, slide the head restraint upwards (→ page 91).

- ▶ Guide Top Tether belt ③ under the head restraint between the two head restraint bars.

**Vehicles without adjustable head restraints:**

- ▶ Top Tether belt with a seat belt strap: guide Top Tether belt ③ over the center of the head restraint.

or

- ▶ Top Tether belt with two seat belt straps: guide one Top Tether belt ③ past the head restraint on the right and left side respectively.

**All vehicles:**

- ▶ Install the LATCH-type (ISOFIX) child restraint system with Top Tether. Comply with the child restraint system manufacturer's installation instructions.
- ▶ Hook Top Tether hook ② into Top Tether anchorage ① without twisting.
- ▶ Tension Top Tether belt ③. Comply with the child restraint system manufacturer's installation instructions.

**Vehicles with adjustable head restraints:**

- ▶ If necessary, slide the head restraint downwards (→ page 91). Make sure that you do not interfere with the correct routing of Top Tether belt ③.

**Securing the child restraint system with the seat belt**

**Securing the child restraint system with the seat belt on the rear seat**

**⚠ WARNING** Risk of accident if the rear bench seat, rear seat and seat backrest are not engaged

The rear bench seat, rear seat and seat backrest may fold forwards, even when you are driving.

- As a result, the vehicle occupant will be pushed into the seat belt with increased force. The seat belt will not be able to protect as intended and could cause additional injury.



- Objects or loads in the trunk or cargo compartment will not be restrained by the seat backrest.

▶ Make sure that the rear bench seat, the rear seat and the seat backrest are engaged before every trip.

If the rear seat backrest is not engaged and locked in place, the red lock verification indicator will be visible.

**When installing a belt-secured child restraint system, observe the following:**

- ☑ Always comply with the manufacturer's installation and operating instructions for the child restraint system used.
- ☑ **When using a category 0/0+ baby car seat and a category I rearward-facing child restraint system on a rear seat:** adjust the front seat so that the seat does not touch the child restraint system.
- ☑ **When using a category I forward-facing child restraint system:** remove the head restraint from the respective seat, if possible.

After the child restraint system has been removed, replace the head restraint immediately and adjust all head restraints correctly.

- ☑ The backrest of the forward-facing child restraint system must, as far as possible, be resting on the seat backrest of the rear seat.
- ☑ For certain child restraint systems in weight category II or III, there may be restrictions on the maximum size setting, e.g. due to possible contact with the roof.
- ☑ The child restraint system must not be put under strain between the roof and the seat cushion and/or be installed facing the wrong direction. Where possible, adjust the seat cushion inclination accordingly.
- ☑ The child restraint system must not be put under strain by the head restraint. Adjust the head restraints accordingly.
- ☑ Make sure that the child's feet do not touch the front seat. If necessary, move the front seat slightly forwards.

The seat belts on the following seats are equipped with a special seat belt retractor:

- Front passenger seat
- Rear seats

When enabled, the special seat belt retractor ensures that the seat belts of the front passenger seat and rear seats do not slacken once the child restraint system is secured (→ page 50).

- ▶ Install the child restraint system. The entire base of the child restraint system must always rest on the sitting surface of the rear seat.
- ▶ Always make sure that the shoulder belt strap is correctly routed from the seat belt outlet of the vehicle to the shoulder belt guide on the child restraint system. The shoulder belt strap must be routed forwards and downwards from the seat belt outlet.

### Notes on rearward-facing and forward-facing child restraint systems on the front passenger seat

**⚠ WARNING** Risk of injury or death when using a rearward-facing child restraint system while the front passenger airbag is enabled

If you secure a child in a rearward-facing child restraint system on the front passenger seat and the PASSENGER AIR BAG OFF indicator lamp is off, the front passenger airbag can deploy in the event of an accident.

The child could be struck by the airbag.

Always ensure that the front passenger airbag is disabled. The PASSENGER AIR BAG OFF indicator lamp must be lit.

NEVER use a rearward-facing child restraint system on a seat with an ENABLED FRONT AIRBAG; DEATH or SERIOUS INJURY to the CHILD can occur.

Observe the specific instructions for rearward-facing and forward-facing child restraint systems (→ page 56).

Always observe the status of the front passenger airbag on the PASSENGER AIR BAG OFF indicator lamp:

- When using a rearward-facing child restraint system on the front passenger seat, the front passenger airbag must always be disabled. This is only the case if the PASSENGER AIR BAG OFF indicator lamp is lit continuously (→ page 42).
- If the PASSENGER AIR BAG OFF indicator lamp is off, the front passenger airbag is enabled. The front passenger airbag may deploy during an accident.

### Securing the child restraint system with the seat belt on the front passenger seat

When installing a belt-secured child restraint system on the front passenger seat, always observe the following:

- ✓ Observe the child restraint system manufacturer's installation and operating instructions.
- ✓ When using a forward-facing child restraint system in category I: remove the head restraint from the respective seat, if possible.  
After the child restraint system has been removed, replace the head restraint immediately and adjust all head restraints correctly.
- ✓ The backrest of the forward-facing child restraint system must, as far as possible, be resting on the seat backrest of the front passenger seat.
- ✓ For certain child restraint systems in weight category II or III, there may be restrictions on the maximum size setting, e.g. due to possible contact with the roof.

- ☑ The child restraint system must not be put under strain between the roof and the seat cushion and/or be installed facing the wrong direction.
- ☑ The child restraint system must not be put under strain by the head restraint. Adjust the head restraints accordingly.
- ☑ Never place objects (e.g. cushions) under or behind the child restraint system.

The seat belt on the front passenger side is equipped with a child seat safety feature.

When enabled, the child seat safety feature ensures that the seat belt does not slacken once the child seat is secured (→ page 50).

- ▶ Set the front passenger seat as far back as possible and move the seat into the highest position if possible.
- ▶ Adjust the seat cushion inclination so that the front edge of the seat cushion is in the highest position and the rear edge of the seat cushion is in the lowest position.
- ▶ Set the seat backrest to the most vertical position possible.

- ▶ Install the child restraint system. The entire base of the child restraint system must always rest on the sitting surface of the front passenger seat.
- ▶ Always make sure that the shoulder belt strap is correctly routed from the seat belt outlet of the vehicle to the shoulder belt guide on the child restraint system. The shoulder belt strap must be routed forwards and downwards from the seat belt outlet.
- ▶ If necessary, adjust the front passenger seat accordingly.

### Child safety locks

#### Activating or deactivating the child safety lock for the rear doors

**⚠ WARNING** Risk of accident and injury due to children left unattended in the vehicle

If children are left unsupervised in the vehicle, they could, in particular:

- Open doors, thereby endangering other persons or road users.
- Get out and be struck by oncoming traffic.
- Operate vehicle equipment and become trapped, for example.

In addition, the children could also set the vehicle in motion, for example by:

- Releasing the parking brake.
- Change the transmission position.
- Start the vehicle.

- ▶ Never leave children unattended in the vehicle.
- ▶ When leaving the vehicle, always take the SmartKey with you and lock the vehicle.
- ▶ Keep the SmartKey out of reach of children.

**⚠ WARNING** Risk of fatal injury due to exposure to extreme heat or cold in the vehicle

If people – particularly children – are exposed to extreme temperatures over an extended period of time, there is a risk of serious or even fatal injury.

- ▶ Never leave anyone – particularly children – unattended in the vehicle.
- ▶ Never leave animals in the vehicle unattended.

**⚠ WARNING** Risk of accident and injury due to children left unattended in the vehicle

If children are traveling in the vehicle, they could, in particular:

- Open doors, thereby endangering other persons or road users
- Get out and be struck by oncoming traffic
- Operate vehicle equipment and become trapped, for example

- ▶ Always activate the child safety locks installed if children are traveling in the vehicle.
- ▶ Never leave children unattended in the vehicle.
- ▶ When leaving the vehicle, always take the SmartKey with you and lock the vehicle.

There are child safety locks for the rear doors and the rear side windows.

The child safety lock on the rear doors secures each door separately. The doors can no longer be opened from the inside.

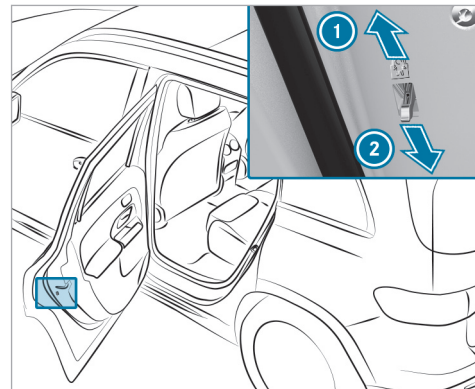

- ▶ Press the lever in direction ① (activate) or ② (deactivate).
- ▶ Make sure that the child safety locks are working properly.

### Activating or deactivating the child safety lock for the rear side windows

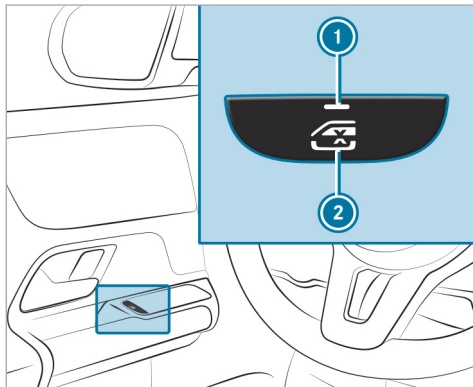

- ▶ **To activate/deactivate:** press button ②.
- The rear side window can be opened or closed in the following cases:
- indicator lamp ① is lit: via the switch on the driver's door

- Indicator lamp ① is off: via the switch on the corresponding rear door or driver's door.

### Notes on pets in the vehicle

**⚠ WARNING** Risk of accident and injury due to animals left unsecured or unattended in the vehicle

If you leave animals in the vehicle unattended or unsecured, they could possibly press down buttons or switches.

Thereby an animal may:

- activate vehicle equipment and become trapped, for example
- switch systems on or off and endanger other road users

Unsecured animals may be thrown around in the vehicle in the event of an accident or sudden steering and braking maneuver and injure vehicle occupants in the process.

- ▶ Never leave animals in the vehicle unattended.
- ▶ Always correctly secure animals while driving, for example using a suitable animal carrier.

## SmartKey

### Overview of SmartKey functions

**⚠ WARNING** Risk of accident and injury due to children left unattended in the vehicle

If children are left unsupervised in the vehicle, they could, in particular:

- Open doors, thereby endangering other persons or road users.
- Get out and be struck by oncoming traffic.
- Operate vehicle equipment and become trapped, for example.

In addition, the children could also set the vehicle in motion, for example by:

- Releasing the parking brake.
- Change the transmission position.
- Start the vehicle.

▶ Never leave children unattended in the vehicle.

▶ When leaving the vehicle, always take the SmartKey with you and lock the vehicle.

▶ Keep the SmartKey out of reach of children.

**!** **NOTE** Damage to the SmartKey caused by magnetic fields

▶ Keep the SmartKey away from strong magnetic fields.

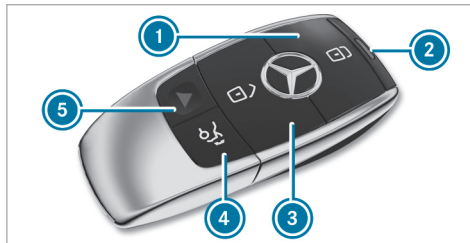

- ① Locks
- ② Indicator lamp

- ③ Unlocks
- ④ Opens/closes the tailgate
- ⑤ Panic alarm

**i** If indicator lamp ② does not light up after pressing the or button, the battery is discharged.

Replacing the SmartKey battery (→ page 62).

The SmartKey locks and unlocks the following components:

- The doors
- The fuel filler flap
- The tailgate

If the vehicle is not opened within approximately 40 seconds after unlocking, it locks again. Anti-theft protection is armed again.

Do not keep the SmartKey together with electronic devices or metal objects. This can affect the SmartKey's functionality.

### Activating/deactivating the acoustic locking verification signal

Multimedia system:

→  >> Settings >> Vehicle

- ▶ Activate or deactivate **Acoustic Lock**.

### Activating/deactivating the panic alarm

#### Requirements:

- The ignition is switched off.



- ▶ **To activate:** press button ① for approximately one second.  
A visual and audible alarm is triggered.



- ▶ **To deactivate:** briefly press button ① again.  
or

- ▶ Press the start/stop button on the cockpit (the SmartKey is inside the vehicle).

### Changing the unlocking settings

Possible unlocking functions of the SmartKey:

- Central unlocking
- Unlocking the driver's door and fuel filler flap

- ▶ **To switch between settings:** press the  and  buttons simultaneously for approximately six seconds until the indicator lamp flashes twice.

Options if the unlocking function for the driver's door and fuel filler flap has been selected:

- **To unlock the vehicle centrally:** press the  button twice.
- **Vehicles with KEYLESS-GO:** if you touch the inner surface of the door handle on the driver's door, only the driver's door and fuel filler flap are unlocked.

### Deactivating the SmartKey functions

If you do not use the vehicle or a SmartKey for an extended period of time, you can reduce the energy consumption of the respective SmartKey. To do so, deactivate the SmartKey functions.

- ▶ **To deactivate:** press the  button on the SmartKey twice in quick succession.

The SmartKey indicator lamp flashes twice briefly and lights up once.

- ▶ **To activate:** press any button on the SmartKey.

- ① When the vehicle is started with the SmartKey in the marked space of the center console, the SmartKey functions are automatically activated (→ page 134).

### Removing/inserting the emergency key

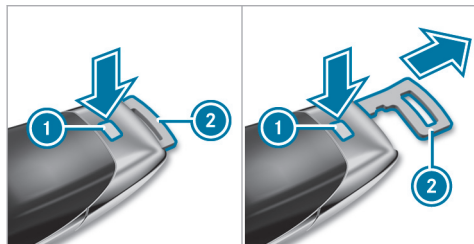

- ▶ **To remove:** press release knob ①. Emergency key ② is pushed out slightly.
  - ▶ Pull out emergency key ② until it engages in the intermediate position.
  - ▶ Press release knob ① again and fully remove emergency key ②.
  - ▶ **To insert:** press release knob ①.
  - ▶ Insert emergency key ② to the intermediate position or fully until it engages.
- ① You can use the intermediate position of emergency key ② to attach the SmartKey to a key ring.

### Replacing the SmartKey battery

**⚠ DANGER** Serious damage to health caused by swallowing batteries

Batteries contain toxic and corrosive substances. Swallowing batteries may cause serious damage to health.

There is a risk of fatal injury.

- ▶ Keep batteries out of the reach of children.
- ▶ If batteries are swallowed, seek medical attention immediately.

**🔥 ENVIRONMENTAL NOTE** Environmental damage caused by improper disposal of batteries



Batteries contain pollutants. It is illegal to dispose of them with the household rubbish.



Dispose of batteries in an environmentally responsible manner. Take discharged batteries to a qualified specialist workshop or to a collection point for used batteries.

#### Requirements:

- You require a CR 2032 3 V cell battery.

Mercedes-Benz recommends that you have the battery replaced at a qualified specialist workshop.

- ▶ Remove the emergency key (→ page 62).



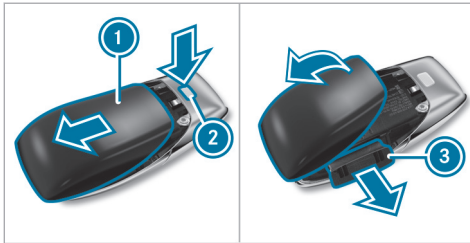

- ▶ Press release knob ② down fully and slide cover ① in the direction of the arrow.
- ▶ Fold out cover ① in the direction of the arrow and remove.
- ▶ Remove battery compartment ③ and take out the discharged battery.
- ▶ Insert the new battery into battery compartment ③. Observe the positive pole marking in the battery compartment and on the battery when doing this.
- ▶ Push in battery compartment ③.
- ▶ Re-attach cover ① and push it until it engages.

### Problems with the SmartKey

#### You can no longer lock or unlock the vehicle

Possible causes:

- The SmartKey battery is weak or discharged.
  - The SmartKey is faulty.
- ▶ Check the battery using the indicator lamp and replace if necessary (→ page 62).
  - ▶ Use the emergency key to lock or unlock (→ page 62).
  - ▶ Have the SmartKey checked at a qualified specialist workshop.

#### There is interference from a powerful radio signal source

The SmartKey function is impaired by, for example:

- High voltage power lines
- Mobile phones
- Electronic devices (notebooks, Tablets)
- Shielding due to metal objects or induction loops for electrical gate systems or automatic barriers

- ▶ Make sure that there is a sufficient distance between the SmartKey and the potential source of interference.

#### You have lost a SmartKey

- ▶ Have the SmartKey deactivated at a qualified specialist workshop.
- ▶ If necessary, have the mechanical lock replaced as well.

### Doors

#### Unlocking and opening doors from the inside

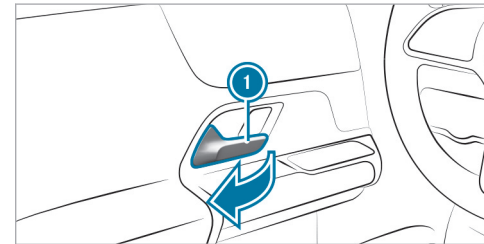

- ▶ **To unlock and open a front door:** pull door handle ①.
- ▶ **To unlock a rear door:** pull the rear door handle.
- ▶ **To open a rear door:** pull the rear door handle again.

### Centrally locking and unlocking the vehicle from the inside

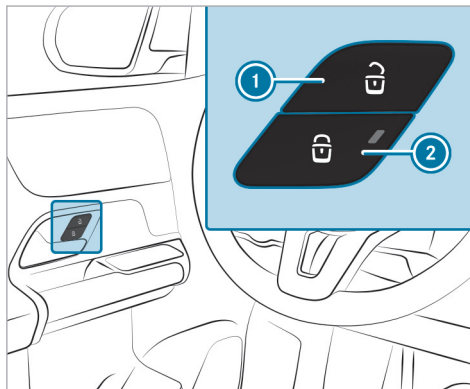

- ▶ **To unlock:** press button ①.
  - ▶ **To lock:** press button ②.
- The indicator lamp in the button on the driver's or front passenger door lights up.

This does not lock or unlock the fuel filler flap.

The vehicle is not unlocked:

- If you have locked the vehicle using the SmartKey.
- If you have locked the vehicle using KEY-LESS-GO.

### Locking/unlocking the vehicle with KEY-LESS-GO

#### Requirements:

- The SmartKey is outside the vehicle.
- The distance between the SmartKey and the vehicle does not exceed 3 ft (1 m).
- The driver's door and the door at which the door handle is used are closed.

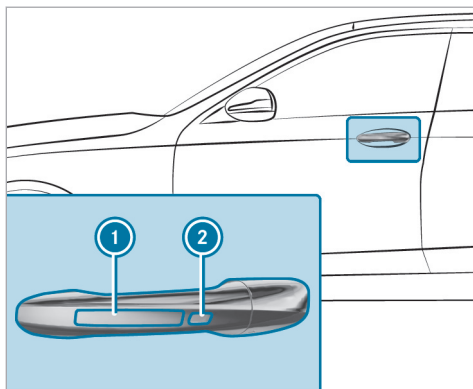

- ▶ **To unlock the vehicle:** touch the inner surface of the door handle.
- ▶ **To lock the vehicle:** touch sensor surface ① or ②.
- ▶ **Convenience closing:** touch recessed sensor surface ② until the closing process has been completed.

ⓘ Further information on convenience closing (→ page 75).

If you open the tailgate from outside, it is automatically unlocked.

### Problems with KEYLESS-GO

**You can no longer lock or unlock the vehicle using KEYLESS-GO.**

Possible causes:

- The SmartKey functions have been deactivated (→ page 61).
  - The SmartKey battery is weak or discharged.
  - The SmartKey is faulty.
- ▶ Activate the SmartKey functions (→ page 61).
  - ▶ Check the battery using the indicator lamp and replace if necessary (→ page 62).
  - ▶ Use the emergency key to unlock or lock the vehicle (→ page 62).
  - ▶ Have the vehicle and SmartKey checked at a qualified specialist workshop.

**There is interference from a powerful radio signal source**

The KEYLESS-GO function is impaired by, for example:

- High voltage power lines
- Mobile phones
- Electronic devices (notebooks, tablets)
- Shielding due to metal objects or induction loops for electrical gate systems or automatic barriers

▶ Make sure that there is a sufficient distance between the SmartKey and the potential source of interference.

### Activating/deactivating the automatic locking feature

The vehicle is locked automatically when the ignition is switched on and the wheels are turning faster than walking pace.

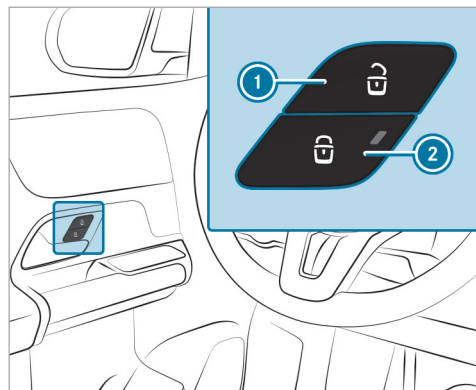

- ▶ **To activate:** press and hold button ② for approximately five seconds until an acoustic signal sounds.
- ▶ **To deactivate:** press and hold button ① for approximately five seconds until an acoustic signal sounds.

When the vehicle is locked automatically, the indicator lamp in button ② lights up.

In the following situations, there is a danger of being locked out when the function is activated:

- While the vehicle is being tow started/ pushed.
- If the vehicle is being tested on a roller dynamometer.

#### Locking/unlocking the vehicle with the emergency key

#### Locking/unlocking the driver's door with the emergency key

- ① If you wish to lock the vehicle entirely using the emergency key, first press the button for locking from the inside while the driver's door is open. Then proceed to lock the driver's door using the emergency key.

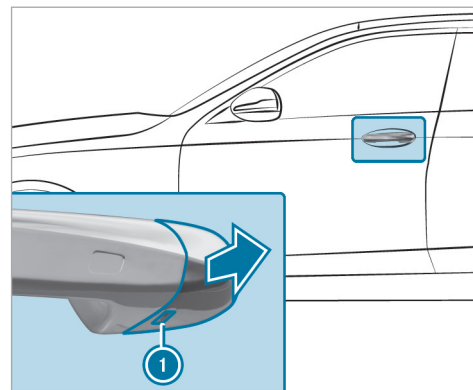

- ▶ Insert the emergency key as far as it will go into opening ① in the cover.
- ▶ Pull and hold the door handle.
- ▶ Pull the cover on the emergency key as straight as possible away from the vehicle until it releases.
- ▶ Release the door handle.

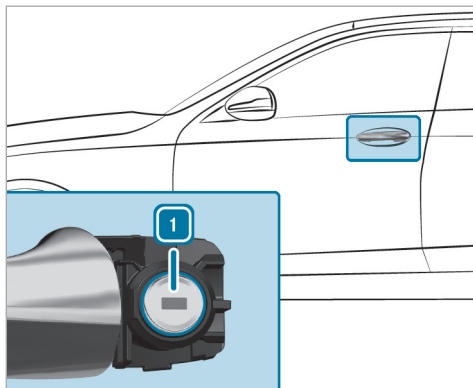

- ▶ **To unlock:** turn the emergency key counter-clockwise to position 1.
- ▶ **To lock:** turn the emergency key clockwise to position 1.
- ▶ Carefully press the cover onto the lock cylinder until it engages and is seated firmly.

### Locking the front passenger door and rear doors with the emergency key

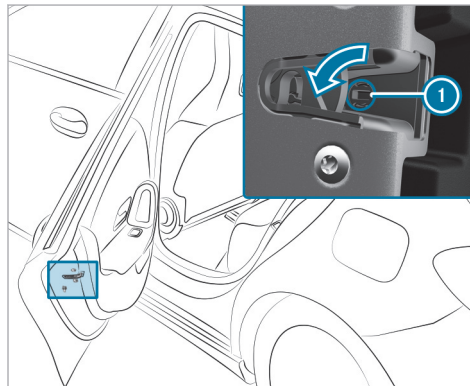

- ▶ Insert a suitable object, e.g. the emergency key, into opening 1 on the door lock.
- ▶ **To lock the left-hand side of the vehicle:** turn the emergency key counter-clockwise as far as it will go.

- ▶ **To lock the right-hand side of the vehicle:** turn the emergency key clockwise as far as it will go.

If the locked door is then closed, it can no longer be opened from outside.

### Cargo compartment

#### Opening the tailgate

#### **⚠ DANGER** Risk of exhaust gas poisoning

Combustion engines emit poisonous exhaust gases such as carbon monoxide. Exhaust gases can enter the vehicle interior if the tailgate is open when the engine is running, especially if the vehicle is in motion.

- ▶ Always switch off the engine before opening the tailgate.
- ▶ Never drive with the tailgate open.

**NOTE** Damage to the tailgate caused by obstacles above the vehicle

The tailgate swings rearwards and upwards when it is opened.

- ▶ Make sure that there is sufficient space behind and above the tailgate.

▶ Pull the tailgate handle.

▶ **Vehicles with HANDS-FREE ACCESS:** Make a kicking movement with your foot below the bumper (→ page 71).

#### Vehicles with an EASY-PACK tailgate

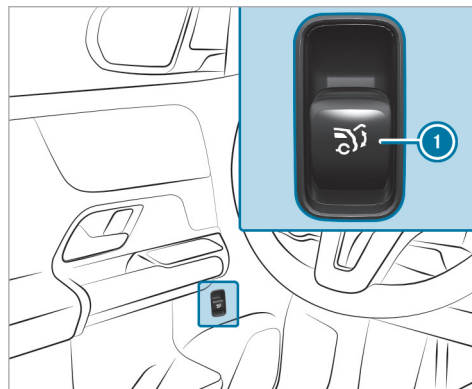

- ▶ Pull remote operating switch ① for the tailgate.
- ▶ Press and hold the  button on the SmartKey.
- ▶ If the tailgate is unlocked, pull the tailgate handle and release it again immediately.

- ▶ For a tailgate stopped in an intermediate position, pull it upwards and release it as soon as it starts to open.

The tailgate is equipped with an automatic object recognition function. If a solid object blocks or restricts the tailgate during automatic opening, this process will be stopped. The automatic object recognition function is only an aid. It is not a substitute for your attentiveness when you are opening the tailgate.

#### Closing the tailgate

**WARNING** Risk of injury from unsecured items in the vehicle

If objects, luggage or loads are not secured or not secured sufficiently, they could slip, tip over or be thrown around and thereby hit vehicle occupants.

There is a risk of injury, particularly in the event of sudden braking or a sudden change in direction.

- ▶ Always stow objects in such a way that they cannot be thrown around.
- ▶ Before the journey, secure objects, luggage or loads against slipping or tipping over.

Observe the notes on loading the vehicle.

- ▶ Pull the tailgate downwards with the handle and let it drop into the lock.

#### Vehicles with an EASY-PACK tailgate

**⚠ WARNING** Risk of becoming trapped during automatic closing of the tailgate

Body parts may become trapped. There may be people in the closing area.

- ▶ Make sure that nobody is in the vicinity of the closing area during the closing process.

Use one of the following options to stop the closing process:

- Press the  button on the SmartKey.

- Press or pull the remote operating switch on the driver's door.
- Press the closing or locking button on the tailgate.
- Pull the tailgate handle.

▶ **Vehicles with HANDS-FREE ACCESS:** it is also possible to stop the closing process by making a kicking movement below the rear bumper.

- ▶ Pull the tailgate downwards slightly. Release it as soon as it begins to close.

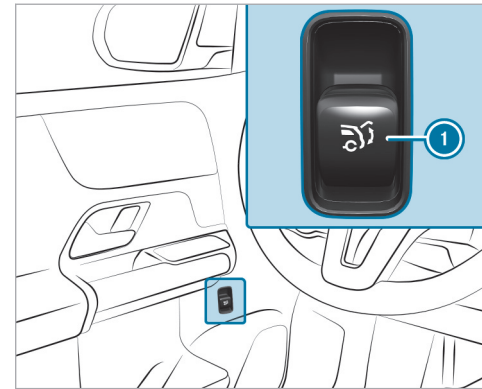

- ▶ Switch on the power supply or the ignition.
- ▶ Press remote operating switch  for the tailgate.

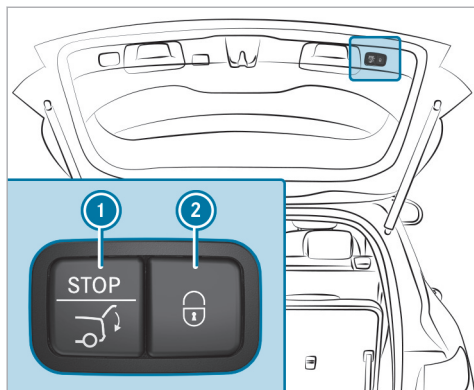

- ▶ Press closing button ① on the tailgate.

#### Vehicles with KEYLESS-GO

- ▶ Press locking button ② on the tailgate. If a SmartKey is detected outside the vehicle, the tailgate will close and the vehicle will be locked.

- ▶ Press and hold the  button on the SmartKey (with the SmartKey in the vicinity of the vehicle).

#### Vehicles with HANDS-FREE ACCESS

- ▶ Make a kicking movement with your foot below the bumper (→ page 71).

#### Automatic reversing function for the tailgate

The tailgate is equipped with automatic object recognition with a reversing function. If a solid object hinders or restricts the tailgate when it is closing automatically, the tailgate will automatically open again slightly. Automatic object recognition with reversing function is only an aid. It is not a substitute for your attentiveness when you are closing the tailgate.

- ▶ During the closing process, make sure that no body parts are in the closing area.

#### **⚠ WARNING** Risk of becoming trapped despite reversing function

The reversing function will not react:

- To soft, light and thin objects, e.g. fingers

- Towards the end of the closing procedure

In these situations in particular, the reversing function cannot prevent someone being trapped.

- ▶ Ensure that no body parts are in the closing area.

If someone is trapped, either:

- Press the  button on the SmartKey.
- Press or pull the remote operating switch on the driver's door.
- Press the closing or locking button on the tailgate.
- Pull the tailgate handle.



## HANDS-FREE ACCESS function

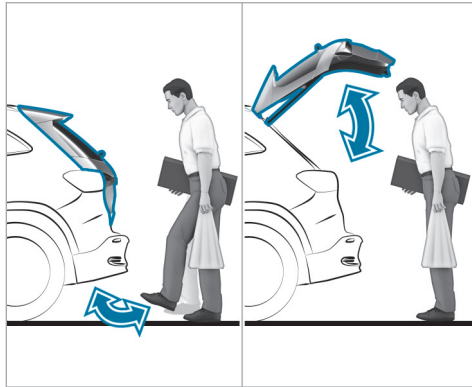

With HANDS-FREE ACCESS you can open, close or stop the closing process of the tailgate by performing a kicking movement under the rear bumper.

The kicking movement triggers the opening or closing process alternately.

Observe the notes when opening (→ page 67) and closing (→ page 68) the tailgate.

- ① Two warning tones sound when the tailgate is opening or closing.

**⚠ WARNING** Risk of burns caused by a hot exhaust system

The vehicle exhaust system can become very hot. If you use HANDS-FREE ACCESS, you could burn yourself by touching the exhaust system.

- ▶ Always ensure that you only make a kicking movement within the detection range of the sensors.

**⚠ NOTE** Vehicle damage due to unintentional opening of the tailgate

- when using an automatic car wash
- when using a high pressure cleaner
- ▶ Deactivate KEYLESS-GO or make sure that the key located is at least 10 ft

(3 m) away from the vehicle in such situations.

When making the kicking movement, make sure that you are standing firmly on the ground. You could otherwise lose your balance, e.g. on ice.

Observe the following notes:

- The SmartKey is behind the vehicle.
- Stand at least 12 in (30 cm) away from the vehicle while performing the kicking movement.
- Do not come into contact with the bumper while making the kicking movement.
- Do not carry out the kicking movement too slowly.
- The kicking movement must be towards the vehicle and back again.

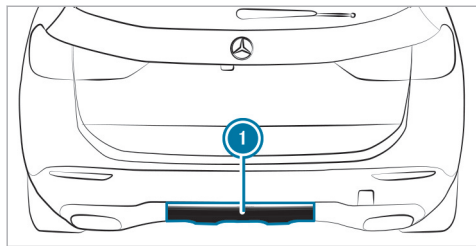

① Detection range of the sensors

If several consecutive kicking movements are not successful, wait ten seconds.

**System limits**

The system may be impaired or may not function in the following cases:

- The sensors are dirty, e.g. due to road salt or snow.
- The kicking movement is made using a prosthetic leg.

The tailgate can open or close unintentionally in the following situations:

- If a person's arms or legs are moving in the sensor detection range, e.g. when polishing the vehicle or picking up objects.
- If objects are moved or placed behind the vehicle, e.g. tensioning straps or luggage.
- If clamping straps, tarps or other coverings are pulled over the bumper.
- If a protective mat with a length reaching over the trunk sill down into the detection range of the sensors is used.
- If the protective mat is not secured correctly.

Deactivate the SmartKey functions (→ page 61) or do not carry the SmartKey about your person in such situations.

**Limiting the opening angle of the tailgate**

**Activating the opening angle limiter**

You can limit the opening angle of the tailgate in the top half of its opening range to approximately 8 in (20 cm) before the end position.

- ▶ Stop the opening procedure of the tailgate at the desired position.
- ▶ Press and hold the closing button on the tailgate until you hear a short acoustic signal. The opening angle limiter will be activated. The tailgate will then stop in the stored position when opened.

To open the tailgate fully, pull the handle on the outside of the tailgate again after it has stopped automatically.

**Deactivating the opening angle limiter**

- ▶ Press and hold the closing button on the tailgate until two short acoustic signals sound.

**Unlocking the tailgate with the emergency key**

- ▶ Fold the rear seat backrest forward.
- ▶ Remove the cargo compartment cover.

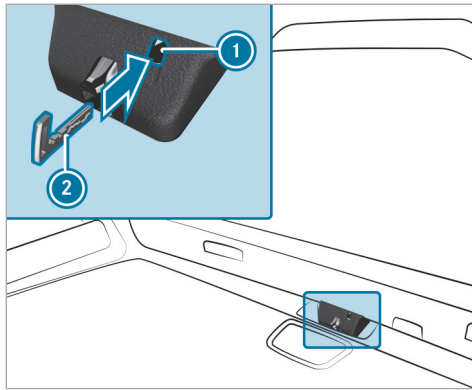

- ▶ Insert emergency key ② into opening ① in the trim and push it in.  
The tailgate will be unlocked.

## Side windows

### Opening and closing the side windows

- ⚠ **WARNING** Risk of entrapment when opening a side window

When opening a side window, parts of the body could be drawn in or become trapped between the side window and window frame.

- ▶ When opening, make sure that nobody is touching the side window.
- ▶ If someone is trapped, release the button immediately or pull it in order to close the side window again.

- ⚠ **WARNING** Risk of becoming trapped when closing a side window

When closing a side window, body parts could be trapped in the closing area in the process.

- ▶ When closing, make sure that no body parts are in the closing area.

- ▶ If someone is trapped, release the button immediately or press the button in order to reopen the side window.

- ⚠ **WARNING** Risk of becoming trapped when children operate the side windows

Children could become trapped if they operate the side windows, particularly when unattended.

- ▶ Activate the child safety lock for the rear passenger compartment side windows.
- ▶ When leaving the vehicle, always take the SmartKey with you and lock the vehicle.
- ▶ Never leave children unattended in the vehicle.

### Requirements:

- The power supply or the ignition is switched on.

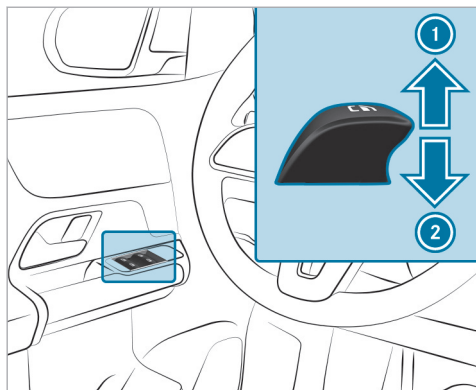

- ① Closes
- ② Opens

The buttons on the driver's door take precedence.

- ▶ **To start automatic operation:** press the  button beyond the point of resistance or pull and release it.

- ▶ **To interrupt automatic operation:** press or pull the  button again.

When the vehicle is switched off, the side windows can continue being operated.

This function is available for around four minutes or until a front door is opened.

#### Automatic reversing function of the side windows

If an object impedes a side window during the closing process, the side window will open again automatically. The automatic reversing function is only an aid and is not a substitute for your attentiveness.

- ▶ During the closing process, make sure that no body parts are in the closing area.

**⚠ WARNING** Risk of becoming trapped despite there being reversing protection on the side window

The reversing function does not react:

- To soft, light and thin objects, e.g. fingers.

- During resetting.

The reversing function cannot prevent someone from becoming trapped in these situations.

- ▶ During the closing process, make sure that no body parts are in the closing area.
- ▶ If someone becomes trapped, press the  button to open the side window again.

#### Convenience opening (ventilating the vehicle before starting a journey)

**⚠ WARNING** Risk of entrapment when opening a side window

When opening a side window, parts of the body could be drawn in or become trapped between the side window and window frame.

- ▶ When opening, make sure that nobody is touching the side window.

- ▶ Release the button immediately if somebody becomes trapped.

▶ Press and hold the  button on the SmartKey.

The following functions are performed:

- The vehicle is unlocked.
- The side windows are opened.
- The panoramic sliding roof is opened.
- The seat ventilation of the driver's seat is switched on.

ⓘ If the roller sunblind of the panoramic sliding sunroof is closed, the roller sunblind is opened first.

▶ **To interrupt convenience opening:** release the  button.

▶ **To continue convenience opening:** press and hold the  button again.

### Convenience closing (closing the vehicle from outside)

**⚠ WARNING** Risk of entrapment due to not paying attention during convenience closing

When the convenience closing feature is operating, parts of the body could become trapped in the closing area of the side window and the sliding sunroof.

- ▶ When the convenience closing feature is operating, monitor the entire closing process and make sure that no body parts are in the closing area.

▶ Press and hold the  button on the SmartKey.

The following functions are performed:

- The vehicle is locked.
- The side windows are closed.
- The panoramic sliding roof is closed.

▶ **To interrupt convenience closing:** release the  button.

▶ **To close the roller sunblinds:** press and hold the  button again.

ⓘ Convenience closing can also be operated with KEYLESS-GO (→ page 64).

### Problems with the side windows

**⚠ WARNING** Risk of becoming trapped or fatally injured if reversing protection is not activated

If you close a side window again immediately after it has been blocked, the side window will close with increased or maximum force. The reversing function is then not active and body parts may become trapped.

- ▶ Make sure that no parts of the body are in the closing area.
- ▶ To stop the closing process, release the button or press the button again to reopen the side window.

**A side window cannot be closed and you cannot see the cause.**

- ▶ Check to see whether any objects are in the window guide.
- ▶ Adjust the side windows.

**Adjusting the side windows**

If a side window is obstructed during closing and reopens again immediately:

- ▶ Immediately after this, pull the corresponding button again until the side window has closed and hold the button for at least one more second (re-adjustment). The side window will be closed without the automatic reversing function.

If the side window is obstructed again and reopens again immediately:

- ▶ Immediately after this, pull the corresponding button again until the side window has closed and hold the button for at least one more second (follow-up adjustment). The side window will be closed without the automatic reversing function.

**The side windows cannot be opened or closed using the convenience opening feature.**

- The SmartKey battery is weak or discharged.
- ▶ Check the battery using the indicator lamp and replace if necessary (→ page 62).

**Sliding sunroof**

**Opening and closing the sliding sunroof**

- ⓘ The term "sliding sunroof" also refers to the panorama roof with power tilt/sliding panel.

**⚠ WARNING** Risk of becoming trapped when the sliding sunroof is being opened and closed

Body parts may become trapped in the range of movement.

- ▶ During opening and closing, make sure that no body parts are in the range of movement.
- ▶ Release the button immediately if somebody becomes trapped.

or

- ▶ Briefly press the button in any direction during automatic operation. The opening or closing process will be stopped.

**⚠ WARNING** Risk of becoming trapped if the sliding sunroof is operated by children

Children operating the sliding sunroof could get caught in the moving parts, particularly if unattended.

- ▶ Never leave children unattended in the vehicle.
- ▶ When leaving the vehicle, always take the key with you and lock the vehicle.

**⚠ WARNING** Risk of becoming trapped when the roller sunblind is being opened and closed

Body parts may become trapped between the roller sunblind and frame or sliding roof.

- ▶ When opening or closing, make sure that no body parts are in the roller sunblind's range of movement.
- ▶ Release the button immediately if somebody becomes trapped.

or

- ▶ Briefly press the button in any direction during automatic operation. The opening or closing process will be stopped.

**!** **NOTE** Malfunction due to snow and ice

Snow and ice may cause the sliding sunroof to malfunction.

- ▶ Open the sliding sunroof only if it is free of snow and ice.

**!** **NOTE** Damage caused by protruding objects

Objects that protrude from the sliding sunroof may damage the sealing strips.

- ▶ Do not allow anything to protrude from the sliding sunroof.

**!** **NOTE** Important points to remember when a roof luggage rack is installed

When a roof luggage rack is installed, raising or opening the sliding sunroof may be limited.

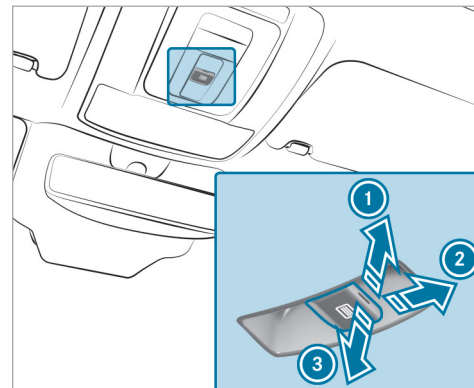

- ▶ Check whether the sliding sunroof can be raised or opened when a roof luggage rack is installed.
- ▶ If in doubt, do not raise or open the sliding sunroof.



- ① To raise
- ② To open
- ③ To close/lower

Use the  button to operate the panorama roof with power tilt/sliding panel and the roller sunblind.

The panorama roof with power tilt/sliding panel can be operated only when the roller sunblind is open.

- ▶ Check whether the sliding sunroof can be raised or opened when a roof luggage rack is installed.
- ▶ **To start automatic operation:** press the  button beyond the point of resistance or pull and release it.
- ▶ **To interrupt automatic operation:** briefly press the  button in any direction. The opening/closing process will be stopped.

**Vehicles with a panorama roof with power tilt/sliding panel:** The automatic raising feature is available only when the sliding sunroof is closed or raised.

#### Automatic reversing function of the sliding sunroof

If an object is obstructing the sliding sunroof during the closing process, the sliding sunroof will open again automatically. The automatic

reversing function is only an aid and is not a substitute for your attentiveness.

- ▶ During the closing process, make sure that no body parts are in the closing area.

**⚠ WARNING** Risk of becoming trapped despite the reversing function being active

In particular, the reversing function does not react:

- To soft, light and thin objects, e.g. fingers.
- Towards the end of the closing procedure.
- During resetting.

▶ During the closing process, make sure that no body parts are in the closing area.

▶ Release the button immediately if somebody becomes trapped.

or

- ▶ Briefly press the button in any direction during automatic operation. The closing process will be stopped.

#### Automatic reversing function of the roller sunblind

If an object is obstructing the roller sunblind during the closing process, the roller sunblind will open again automatically. The automatic reversing function is only an aid and is not a substitute for your attentiveness.

- ▶ When closing the roller sunblind, make sure that no body parts are in the range of movement.

**⚠ WARNING** Risk of becoming trapped despite reversing function

In particular, the reversing function does not react to soft, light and thin objects, e.g. fingers.

- ▶ When closing the roller sunblind, make sure that no body parts are in the range of movement.



- ▶ Release the button immediately if somebody becomes trapped.

or

- ▶ Briefly press the button in any direction during the automatic closing process. The closing process will be stopped.

### Automatic functions of the sliding sunroof

**i** The term "sliding sunroof" also refers to the panorama roof with power tilt/sliding panel.

By pushing or pulling the  button, you can interrupt the automatic functions: "Rain closing function when driving" and "Automatic lowering".

#### Rain closing function when driving

**Vehicles with a panorama roof with power tilt/sliding panel:** If it starts to rain, the raised sliding sunroof will automatically be lowered while the vehicle is in motion.

#### Automatic lowering function

**Vehicles with a panorama roof with power tilt/sliding panel:** If the sliding sunroof is raised

at the rear, it will automatically be lowered slightly at higher speeds. At low speeds, it will be raised again automatically.

**⚠ WARNING** Risk of becoming trapped by automatic lowering of the sliding sunroof

At higher speeds, the raised sliding sunroof will automatically be lowered slightly at the rear.

- ▶ Make sure that nobody reaches into the sliding sunroof's range of movement while the vehicle is in motion.
- ▶ If somebody becomes trapped, briefly push the sliding sunroof button forwards or backwards.

### Problems with the sliding sunroof

**⚠ WARNING** Risk of becoming trapped or fatal injuries when the sliding sunroof is closed again

If the sliding sunroof is closed again immediately after it has been blocked or reset, it will close with increased force.

- ▶ Make sure that no parts of the body are in the closing area.
- ▶ Release the button immediately if somebody becomes trapped.

or

- ▶ Briefly press the button in any direction during the automatic closing process. The closing process will be stopped.

**The sliding sunroof cannot be closed and you cannot see the cause.**

**i** The term "sliding sunroof" also refers to the panorama roof with power tilt/sliding panel.

If the sliding sunroof is obstructed during closing and reopens again slightly:

- ▶ Immediately after automatic reversing, pull and hold the  button down again to the point of resistance until the sliding sunroof is closed.  
The sliding sunroof will be closed with increased force.



If the sliding sunroof is obstructed again and reopens again slightly:

- ▶ Repeat the previous step.  
The sliding sunroof will be closed with even greater force.

**Vehicles with a panorama roof with power tilt/sliding panel: The sliding sunroof or the roller sunblind is not operating smoothly.**

- ▶ Reset the sliding sunroof and the roller sunblind.

**Resetting the sliding sunroof and the roller sunblind**

- ▶ Pull and hold the  button little by little until the sliding sunroof is fully closed.
- ▶ Pull and hold the  button little by little until the roller sunblind is fully closed.

- ▶ Use automatic operation to fully open and then close the sliding sunroof.

### Anti-theft protection

#### Function of the immobilizer

The immobilizer prevents your vehicle from being started without the correct SmartKey.

The immobilizer is automatically activated when the ignition is switched off and deactivated when the ignition is switched on.

When leaving the vehicle, always take the SmartKey with you and lock the vehicle. Anyone can start the engine if a valid SmartKey has been left inside the vehicle.

- ❗ In the event the engine cannot be started (yet the vehicle's battery is charged), the system is not operational. Contact an authorized Mercedes-Benz Center or call 1-800-FOR-MERCEdes (in the USA) or 1-800-387-0100 (in Canada).

### ATA (anti-theft alarm system)

#### Function of the ATA system

If the ATA system is armed, a visual and audible alarm is triggered in the following situations:

- when a door is opened
- when the tailgate is opened
- when the hood is opened
- when interior protection is triggered (→ page 82)
- when the tow-away alarm is triggered (→ page 81)

The ATA system is armed automatically after approximately ten seconds in the following situations:

- after locking the vehicle with the SmartKey
- after locking the vehicle using KEYLESS-GO

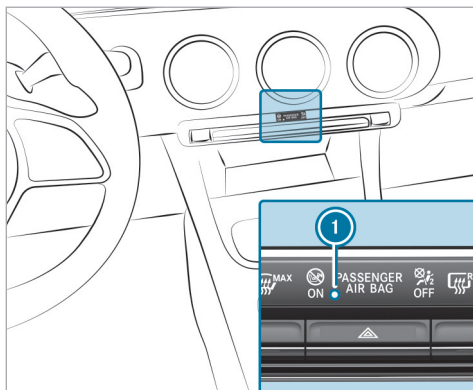

Indicator lamp ① flashes when the ATA system is armed.

The ATA system is deactivated automatically in the following situations:

- after unlocking the vehicle with the SmartKey
- after unlocking the vehicle using KEYLESS-GO
- after pressing the start/stop button with the SmartKey in the stowage compartment (→ page 134)
- ① When the Mercedes-Benz emergency call system is active and the alarm stays on for more than 30 seconds, a message is automatically sent to the Customer Assistance Center (→ page 222).
- ① In the case of severe battery discharging, the anti-theft alarm system is automatically deactivated to facilitate the next engine start.

#### Deactivating the ATA

▶ Press the ,  or  button on the SmartKey.

or

▶ Press the start/stop button with the SmartKey in the marked space (→ page 134)

#### Deactivating the alarm using KEYLESS-GO

▶ Grasp the outside door handle with the SmartKey outside the vehicle.

#### Function of the tow-away alarm

① This function may not be available in all countries.

An audible and visual alarm is triggered if an alteration to your vehicle's angle of inclination is detected while the tow-away alarm is armed.



The tow-away alarm is automatically armed after approximately 60 seconds:

- after locking the vehicle with the SmartKey
- after locking the vehicle using KEYLESS-GO

The tow-away alarm is only armed when the following components are closed:

- the doors
- the tailgate

The tow-away alarm is automatically deactivated:

- after pressing the  or  button on the SmartKey
- after pressing the start/stop button with the SmartKey in the stowage compartment (→ page 134)

- after unlocking the vehicle using KEYLESS-GO
- when using HANDS-FREE ACCESS

Information on collision detection on a parked vehicle (→ page 160).

### Arming/disarming the tow-away alarm

Multimedia system:

→  » Settings » Quick Access

▶ Arm or disarm [Tow-away Protection](#).

The tow-away alarm is armed again in the following cases:

- The vehicle is unlocked again.
- A door is opened.
- The vehicle is locked again.

 If quick access is unavailable, select the [Vehicle](#) submenu in the [Settings](#) main menu to arm or disarm the tow-away alarm.

### Function of the interior motion sensor

 This function may not be available in all countries.

When the interior motion sensor is activated, a visual and audible alarm is triggered if movement is detected in the vehicle interior.



The interior motion sensor is activated automatically after approximately ten seconds:

- after locking the vehicle with the SmartKey
- after locking the vehicle using KEYLESS-GO

The interior motion sensor is only activated when the following components are closed:

- the doors
- the tailgate

The interior motion sensor is automatically deactivated:

- after pressing the  or  button on the SmartKey
- after pressing the start/stop button with the SmartKey in the storage compartment (→ page 134)

- after unlocking the vehicle using KEYLESS-GO
- when using HANDS-FREE ACCESS

The following situations can lead to a false alarm:

- moving objects such as mascots in the vehicle interior
- when the side window is open
- when the panoramic sliding sunroof is open

### Arming/deactivating the interior motion sensor

Multimedia system:

→  » Settings » Quick Access

▶ Activate or deactivate [Interior Motion Sensor](#).

The interior motion sensor is activated again in the following cases:

- The vehicle is unlocked again.
- A door is opened.
- The vehicle is locked again.

- ① If quick access is unavailable, select the **Vehicle** menu under **Settings** to activate or deactivate the interior motion sensor.

### Notes on the correct driver's seat position

**⚠ WARNING** Risk of accident due to adjusting vehicle settings while the vehicle is in motion

You could lose control of the vehicle in the following situations in particular:

- If you adjust the driver's seat, the head restraints, the steering wheel or the mirror while the vehicle is in motion.
  - If you fasten your seat belt while the vehicle is in motion.
- ▶ Before starting the engine: adjust the driver's seat, the head restraints, the steering wheel and the mirror and fasten your seat belt.

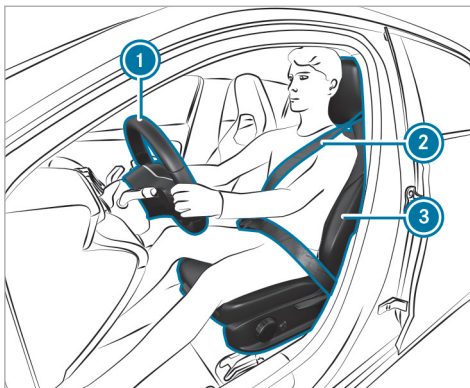

Ensure the following when adjusting the steering wheel ①, seat belt ② and driver's seat ③:

- You are sitting as far away from the driver's airbag as possible, taking the following points into consideration.
- You are sitting in an upright position
- Your thighs are slightly supported by the seat cushion

- Your legs are not fully extended and you can depress the pedals properly
- The back of your head is supported at eye level by the center of the head restraint
- You can hold the steering wheel with your arms slightly bent
- You can move your legs freely
- You can see all the displays on the instrument cluster clearly
- You have a good overview of the traffic conditions
- Your seat belt sits snugly against your body and passes across the center of your shoulder and across your hips in the pelvic area

## Seats

### Adjusting the front seat mechanically (without Seat Comfort Package)

**▲ WARNING** Risk of becoming trapped if the seats are adjusted by children

Children could become trapped if they adjust the seats, particularly when unattended.

- ▶ When leaving the vehicle, always take the SmartKey with you and lock the vehicle.
- ▶ Never leave children unattended in the vehicle.

**▲ WARNING** Risk of becoming trapped when adjusting the seat

When you adjust a seat, you or other vehicle occupants could become trapped, e.g. on the seat guide rail.

- ▶ When adjusting a seat, make sure that no one has any part of their body within the sweep of the seat.

Observe the safety notes on "Airbags" and "Children in the vehicle".

**▲ WARNING** Risk of accident due to the driver's seat not being engaged

The driver's seat may move unexpectedly while the vehicle is in motion.

This could cause you to lose control of the vehicle.

- ▶ Always make sure that the driver's seat is engaged before starting the vehicle.

**▲ WARNING** Risk of accident due to adjusting vehicle settings while the vehicle is in motion

You could lose control of the vehicle in the following situations in particular:

- If you adjust the driver's seat, the head restraints, the steering wheel or the mirror while the vehicle is in motion.
- If you fasten your seat belt while the vehicle is in motion.

- ▶ Before starting the engine: adjust the driver's seat, the head restraints, the steering wheel and the mirror and fasten your seat belt.

**▲ WARNING** Risk of becoming trapped if the seat height is adjusted carelessly

If you adjust the seat height carelessly, you or other vehicle occupants could be trapped and thereby injured.

Children in particular could accidentally press the electrical seat adjustment buttons and become trapped.

- ▶ While moving the seats, make sure that hands or other body parts do not get under the lever assembly of the seat adjustment system.

**⚠ WARNING** Risk of injury due to head restraints not being installed or being adjusted incorrectly

If head restraints have not been installed or have not been adjusted correctly, there is an increased risk of injury in the head and neck area, e.g. in the event of an accident or when braking.

- ▶ Always drive with the head restraints installed.
- ▶ Before driving off, make sure for every vehicle occupant that the center of the head restraint supports the back of the head at about eye level.

Do not interchange the head restraints of the front and rear seats. Otherwise, you will not be able to adjust the height and angle of the head restraints correctly.

Adjust the head restraint fore-and-aft position so that it is as close as possible to the back of your head.

**⚠ WARNING** Risk of injury or death due to an incorrect seat position

The seat belt does not offer the intended level of protection if you have not moved the seat backrest to an almost vertical position.

You could slip beneath the seat belt and injure yourself.

- ▶ Adjust the seat properly before commencing your journey.
- ▶ Always ensure that the seat backrest is in an almost vertical position and that the shoulder belt is routed across the center of your shoulder.

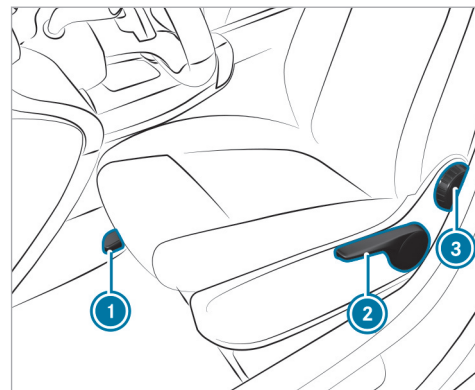

▶ **To adjust the seat fore-and-aft position:**

lift lever ① and slide the seat into the desired position.

▶ Make sure that the seat is engaged.

▶ **To adjust the seat height:** push or pull lever ② until the desired position has been reached.



- ▶ **To adjust the seat backrest inclination:** turn handwheel ③ forwards and backwards until the desired position has been reached.

### Adjusting the front seat mechanically (with Seat Comfort Package)

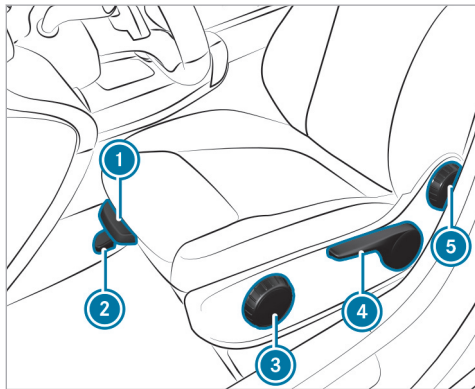

- ▶ **To adjust the seat cushion length:** lift lever ① and slide the front section of the seat cushion forwards or backwards.
- ▶ **To adjust the seat fore-and-aft position:** lift lever ② and slide the seat into the desired position.
- ▶ Make sure that the seat is engaged.
- ▶ **To adjust the seat cushion inclination:** turn handwheel ③ forwards and backwards until the desired position has been reached.
- ▶ **To adjust the seat height:** push or pull lever ④ until the desired position has been reached.
- ▶ **To adjust the seat backrest inclination:** turn handwheel ⑤ forwards and backwards until the desired position has been reached.

### Adjusting the front seat electrically

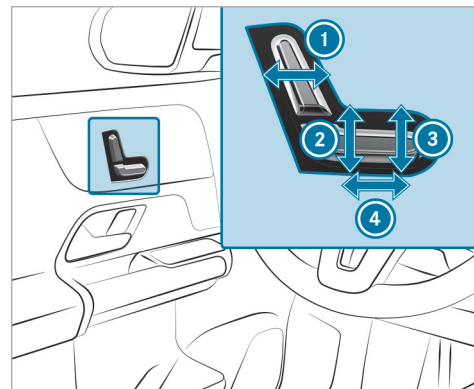

- ① Seat backrest inclination
  - ② Seat height
  - ③ Seat cushion inclination
  - ④ Seat fore-and-aft position
- ▶ Save the settings with the memory function (→ page 96).

### Adjusting the 4-way lumbar support

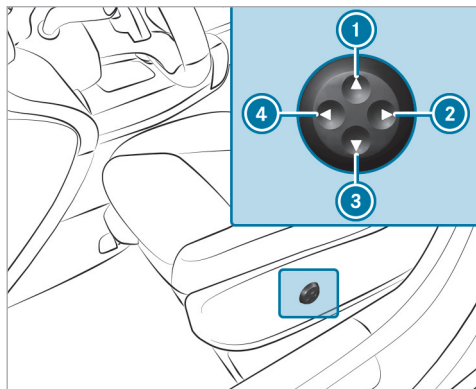

- ① Higher
- ② Softer
- ③ Lower
- ④ Firmer

▶ Using buttons ① to ④, adjust the contour of the backrest individually to suit your back.

### Adjusting rear seats mechanically

**⚠ WARNING** Risk of becoming trapped when adjusting the seats

When you adjust a seat, you may trap yourself or a vehicle occupant.

▶ When adjusting a seat, make sure that no one has any body parts in the sweep of the seat.

**⚠ WARNING** Risk of accident if the seat and seat backrest are not engaged

The seat and seat backrest can fold forwards.

There is a risk of the following, in particular:

- The vehicle occupant may be pressed against the seat belt. The seat belt will not be able to protect as intended and could cause additional injury.
- A child restraint system will no longer be properly supported or positioned and will no longer fulfill its function as intended.

- The seat backrest will not be able restrain objects or goods in the cargo compartment.

Always ensure that the seat and seat backrest are engaged, in particular:

- Before persons travel in the vehicle while sitting on a seat with the easy entry and exit feature
- After you have adjusted the seat
- After the easy entry and exit feature has been used
- After the cargo compartment enlargement has been folded forwards

**⚠ WARNING** Risk of injury when you adjust the rear seats while the vehicle is in motion

You or other vehicle occupants could be trapped and thereby injured.

▶ Adjust the rear seats before the engine is started.

**!** **NOTE** Damage caused by objects in the footwell or behind the rear seats

When adjusting the fore-and-aft position, the rear seats and/or the object can be damaged.

▶ Stow objects in a suitable place.

The components of the rear bench seat can be moved. You can move the right-hand and left-hand part together with the center part independently of each other.



- ▶ Lift release handle ① and slide the corresponding part of the bench seat into the desired position.
- ▶ Let go of release handle ①.
- ▶ Make sure that the seat is engaged.

### Adjusting the rear seat backrests mechanically

Always ensure that all vehicle occupants have their seat belts fastened correctly and are sitting properly. Particular attention must be paid to children.

If you no longer require the seat backrest to be folded down for getting in and out, fold it back into place.

**!** **WARNING** Risk of becoming trapped if the seat is not engaged

The seat does not engage when folded forwards. The seat can fold backwards unexpectedly, e.g. when accelerating, braking or in the event of an abrupt change of direction or an accident.

People in the seat's sweep can become trapped.

- ▶ If a seat is folded forwards, always fold it back before driving off.
- ▶ Make sure that the seat is engaged.

**Requirements:**

- The area into which the seat is folded is clear.

You can fold the seat backrests on the second row of seats forwards for the following situations:

- For easier access to the cargo compartment

You can move the seat backrest to different angles.

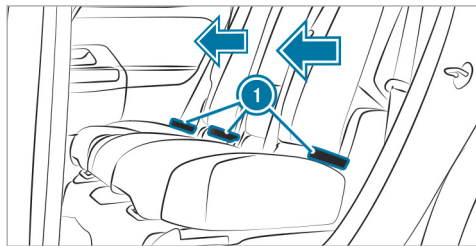

- ▶ **To set the seat backrest:** hold the seat backrest in place with your hand or back.

- ▶ Gently pull one of release loops ① and fold the seat backrest forwards or backwards.
- ▶ Ensure that the seat backrest is engaged.

### Head restraints

#### Adjusting the front seat head restraints manually

**⚠ WARNING** Risk of accident due to adjusting vehicle settings while the vehicle is in motion

You could lose control of the vehicle in the following situations in particular:

- If you adjust the driver's seat, the head restraints, the steering wheel or the mirror while the vehicle is in motion.
  - If you fasten your seat belt while the vehicle is in motion.
- ▶ Before starting the engine: adjust the driver's seat, the head restraints, the steering wheel and the mirror and fasten your seat belt.

**⚠ WARNING** Risk of injury due to head restraints not being installed or being adjusted incorrectly

If head restraints have not been installed or have not been adjusted correctly, there is an increased risk of injury in the head and neck area, e.g. in the event of an accident or when braking.

- ▶ Always drive with the head restraints installed.
- ▶ Before driving off, make sure for every vehicle occupant that the center of the head restraint supports the back of the head at about eye level.

Do not interchange the head restraints of the front and rear seats. Otherwise, you will not be able to adjust the height and angle of the head restraints correctly.

Adjust the head restraint fore-and-aft position so that it is as close as possible to the back of your head.

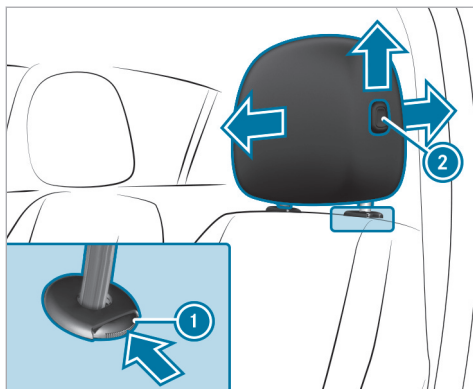

- ▶ **To raise:** pull the head restraint up.
- ▶ **To lower:** press release knob ① in the direction of the arrow and push the head restraint down.
- ▶ **To move the driver's head restraint forwards:** press release knob ② and pull the head restraint forwards.

- ▶ **To move the driver's head restraint backwards:** press release knob ② and push the head restraint backwards.

#### Adjusting the head restraints of the rear seats mechanically

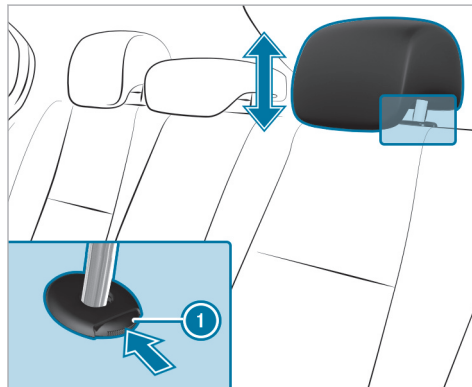

- ▶ **To raise:** pull the head restraint up.

- ▶ **To lower:** press release knob ① in the direction of the arrow and push the head restraint down.
- ▶ **If the center seat on the second row of seats is not occupied:** press the head restraint down all the way.

## Installing/removing the rear seat head restraints

### Removing

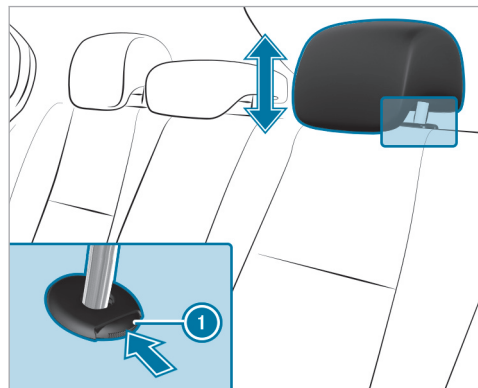

- ▶ Release the rear seat backrest and fold it forwards slightly (→ page 100).
- ▶ Pull the head restraint upwards as far as it will go.

- ▶ Push release knob ① in the direction of the arrow and pull out the head restraint.

### Installing

- ▶ Insert the head restraint such that the notches on the bar are on the left when viewed in the direction of travel.
- ▶ Push the head restraint down until it engages.
- ▶ Fold the rear seat backrest back until it engages.

## Configuring the seat settings

Multimedia system:

→ ▶ Comfort ▶ Seat Comfort

### Adjusting the backrest contour in the lumbar region of the seat backrest (lumbar)

- ▶ Select **Lumbar**.
- ▶ Select the settings for the desired seat.
- ▶ Adjust the air cushions.

## Adjusting the backrest side bolsters

- ▶ Select **Side Bolsters**.
- ▶ Adjust the air cushion for the desired seat.

## Selecting the massage program for the front seats

Multimedia system:

→ ▶ Comfort ▶ Massage

- ▶ Select **Wave Massage** or **Pulsating Massage**.
- ▶ Start the program for the desired seat .
- ▶ **To set the massage intensity:** switch **High Intensity** on or off.

## Resetting seat settings

Multimedia system:

→ ▶ Comfort ▶ Seat Comfort

- ▶ Select a seat, e.g. the front passenger seat .
- ▶ Select **Reset**.
- ▶ Confirm the prompt.

### Switching the seat heating on/off

**⚠ WARNING** Risk of burns due to repeatedly switching on the seat heating

Repeatedly switching on the seat heating can cause the seat cushion and seat backrest padding to become very hot.

The health of persons with limited temperature sensitivity or a limited ability to react to high temperatures may be affected or they may even suffer burn-like injuries.

- ▶ Do not repeatedly switch on the seat heating.

To protect against overheating, the seat heating may be temporarily deactivated after it is switched on repeatedly.

**! NOTE** Damage to the seats caused by objects or documents when the seat heating is switched on

When the seat heating is switched on, overheating may occur due to objects or docu-

ments placed on the seats, e.g. seat cushions or child seats. This could cause damage to the seat surface.

- ▶ Make sure that no objects or documents are on the seats when the seat heating is switched on.

#### Requirements:

- The power supply is switched on.

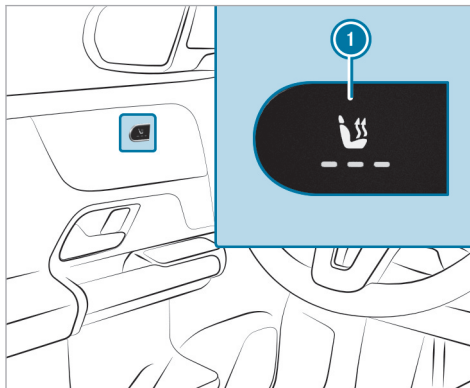

- ▶ Press button ① repeatedly until the desired heating level is set.

Depending on the heating level, up to three indicator lamps will light up. If all indicator lamps are off, the seat heating is switched off.

- ① The seat heating will automatically switch down from the three heating levels after 8, 10 and 20 minutes until the seat heating switches off.

### Switching the seat ventilation on/off

#### Requirements:

- The power supply is switched on.

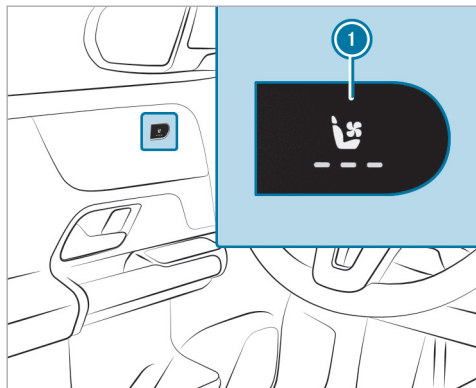

- ▶ Press button ① repeatedly until the desired blower setting has been reached. Depending on the blower setting, up to three indicator lamps will light up. If all indicator lamps are off, the seat ventilation is switched off.

### Steering wheel

#### Adjusting the steering wheel mechanically

- ⚠ **WARNING** Risk of accident due to adjusting vehicle settings while the vehicle is in motion

You could lose control of the vehicle in the following situations in particular:

- If you adjust the driver's seat, the head restraints, the steering wheel or the mirror while the vehicle is in motion.
- If you fasten your seat belt while the vehicle is in motion.

- ▶ Before starting the engine: adjust the driver's seat, the head restraints, the steering wheel and the mirror and fasten your seat belt.

- ⚠ **WARNING** Risk of entrapment for children when adjusting the steering wheel

Children could injure themselves if they adjust the steering wheel.

- ▶ Never leave children unattended in the vehicle.
- ▶ When leaving the vehicle, always take the SmartKey with you and lock the vehicle.

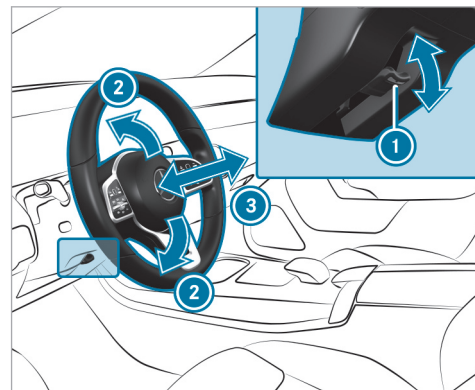

- ▶ **To unlock:** push release lever ① down as far as it will go.



- ▶ Adjust height ② and distance ③ to the steering wheel.
- ▶ **To lock:** push release lever ① up as far as it will go.
- ▶ Check and make sure that the steering column is locked by moving the steering wheel.

### Switching the steering wheel heating on/off

#### Requirements:

- The ignition is switched on.

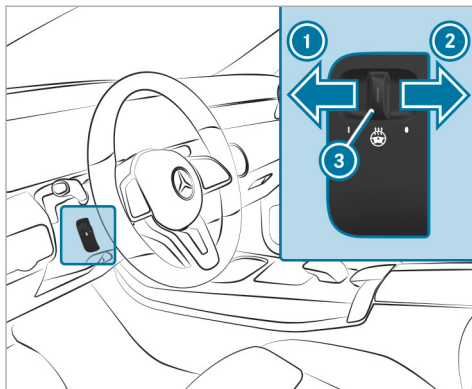

- ▶ Push the switch into position ① or ②. If indicator lamp ③ lights up, the steering wheel heating is switched on.

When you switch the ignition off, the steering wheel heating switches off.

### Easy entry and exit feature

#### Using the easy entry and exit feature

- ⚠ **WARNING** Risk of accident when pulling away during the adjustment process for the easy exit feature

You could lose control of the vehicle.

- ▶ Always wait until the adjustment process is complete before pulling away.

- ⚠ **WARNING** Risk of becoming trapped during adjustment of the easy entry and exit feature

You and other vehicle occupants could become trapped.

- ▶ Ensure that no-one has any body parts in the range of movement of the seat.

If there is a risk of becoming trapped by the driver's seat:

- ▶ Press the seat adjustment switch. The adjustment process will be stopped.

You can stop the adjustment process by pressing one of the memory function position switches.

**⚠ WARNING** Risk of becoming trapped during activation of the easy entry and exit feature by children

If children activate the easy entry and exit feature, they can become trapped, particularly when unattended.

- ▶ Never leave children unattended in the vehicle.
- ▶ When leaving the vehicle, always take the SmartKey with you and lock the vehicle.

When the easy entry and exit feature is active, the driver's seat will move backwards and the backrest will be moved to a steeper position when:

- You switch the ignition off with the driver's door open.
- You open the driver's door with the ignition switched off.

- ⓘ The driver's seat will then move backwards only if it is not already in the rearmost position. The seat backrest will then move forwards only if it is not already in the foremost position.

The driver's seat will move back to the last drive position when:

- You switch the ignition on with the driver's door closed.
- You close the driver's door with the ignition switched on.

The last drive position will be saved when:

- You switch the ignition off.

- You call up the seat settings via the memory function.
- You save the seat settings via the memory function.

### Setting the easy entry and exit feature

Multimedia system:

- ➔  ➔ Settings ➔ Vehicle
- ➔ Automatic Seat Adjustment
- ➔ Easy Entry/Exit

- ▶ Activate or deactivate the function.

### Operating the memory function

**⚠ WARNING** Risk of an accident if the memory function is used while driving

If you use the memory function on the driver's side while driving, you could lose control of the vehicle as a result of the adjustments being made.

- ▶ Only use the memory function on the driver's side when the vehicle is stationary.

**⚠ WARNING** Risk of entrapment when setting the seat with the memory function

When the memory function adjusts the seat, you and other vehicle occupants – particularly children – could become trapped.

- ▶ During the adjustment process of the memory function, make sure that no one has any body parts in the sweep of the seat.
- ▶ If someone becomes trapped, press a preset position button or seat adjustment switch immediately.

**⚠ WARNING** Risk of entrapment if the memory function is activated by children

Children could become trapped if they activate the memory function, particularly when unattended.

- ▶ Never leave children unattended in the vehicle.
- ▶ When leaving the vehicle, always take the SmartKey with you and lock the vehicle.

You can use the memory function when the ignition is switched off.

**Storing**

Seat adjustments for up to three people can be stored and called up using the memory function.

You can save settings for the following systems:

- Seat
- Seat contour
- Outside mirrors

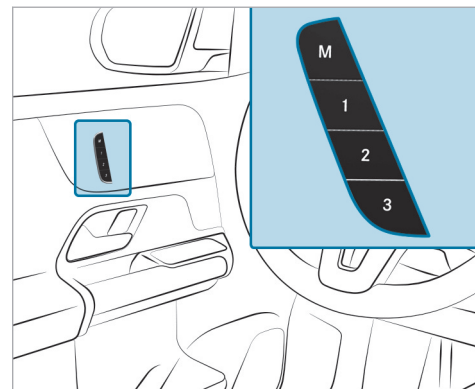

- ▶ Set the desired position for all systems.
- ▶ Briefly press the **M** memory button and then press preset position **1**, **2** or **3** within three seconds.
- ▶ **To call up:** press and briefly hold one of preset position buttons **1**, **2** or **3**. After releasing the button, all systems are moved into the stored position.

## Stowage areas

### Notes on loading the vehicle

#### **⚠ DANGER** Risk of exhaust gas poisoning

Combustion engines emit poisonous exhaust gases such as carbon monoxide. Exhaust gases can enter the vehicle interior if the tailgate is open when the engine is running, especially if the vehicle is in motion.

- ▶ Always switch off the engine before opening the tailgate.
- ▶ Never drive with the tailgate open.

#### **⚠ WARNING** Risk of injury from unsecured items in the vehicle

If objects, luggage or loads are not secured or not secured sufficiently, they could slip, tip over or be thrown around and thereby hit vehicle occupants.

There is a risk of injury, particularly in the event of sudden braking or a sudden change in direction.

- ▶ Always stow objects in such a way that they cannot be thrown around.
- ▶ Before the journey, secure objects, luggage or loads against slipping or tipping over.

#### **⚠ WARNING** Risk of injury due to objects being stowed incorrectly

If you do not adequately stow objects in the vehicle interior, they could slip or be tossed around and thereby strike vehicle occupants. In addition, cup holders, open stowage spaces and mobile phone brackets cannot always restrain the objects they contain in the event of an accident.

There is a risk of injury, particularly in the event of sudden braking or a sudden change in direction.

- ▶ Always stow objects in such a way that they cannot be tossed about in these or similar situations.

- ▶ Always make sure that objects do not project from stowage spaces, parcel nets or stowage nets.
- ▶ Close the lockable stowage spaces before starting a journey.
- ▶ Stow and secure objects that are heavy, hard, pointed, sharp-edged, fragile or too large in the cargo compartment.

#### **⚠ WARNING** - Risk of accident or injury when using the cup holder while the vehicle is moving

The cup holder cannot secure containers while the vehicle is moving.

If you use a cup holder while the vehicle is moving, the container may be flung around and liquids may be spilled. The vehicle occupants may come into contact with the liquid and if it is hot, they could be scalded. You could be distracted from traffic conditions and you may lose control of the vehicle.

- ▶ Only use the cup holder when the vehicle is stationary.

- ▶ Only use the cup holder for containers of the right size.
- ▶ Close the container, particularly if the liquid is hot.

**!** **NOTE** Damage to the cup holder

When the rear armrest is folded back the cup holder could become damaged.

- ▶ Only fold the rear armrest back when the cup holder is closed.

**!** **NOTE** Damage to the rear armrest due to body weight

When folded out, the rear armrest can be damaged by body weight.

- ▶ Do not sit or support yourself on the rear seat armrest.

**⚠** **WARNING** Risk of injury due to an open cargo compartment floor

If you drive with the cargo compartment floor open, objects could be flung around and hit vehicle occupants as a result. There is a risk of injury, particularly in the event of sudden braking or a sudden change in direction.

- ▶ Always close the cargo compartment floor before a journey.

**⚠** **WARNING** - Risk of fire and injury from hot cigarette lighter

You can burn yourself if you touch the hot heating element or the socket of the cigarette lighter.

In addition, flammable materials may ignite if:

- you drop the hot cigarette lighter
- a child holds the hot cigarette lighter to objects, for example

- ▶ Always hold the cigarette lighter by the knob.
- ▶ Always make sure that the cigarette lighter is out of reach of children.
- ▶ Never leave children unattended in the vehicle.

**⚠** **WARNING** Risk of burns from the tailpipe and tailpipe trims

The exhaust tailpipe and tailpipe trims can become very hot. If you come into contact with these parts of the vehicle, you could burn yourself.

- ▶ Always be particularly careful around the tailpipe and the tailpipe trims and supervise children especially closely in this area.
- ▶ Allow vehicle parts to cool down before touching them.

The driving characteristics of your vehicle are dependent on the distribution of the load within the vehicle. You should bear the following in mind when loading the vehicle:

- Never exceed the permissible gross mass or the gross axle weight rating for the vehicle (including occupants). The values are specified on the vehicle identification plate on the vehicle's B-pillar.
- The load must not protrude above the upper edge of the seat backrests.
- Always use the partition net when transporting objects in the cargo compartment.
- Always place the load behind unoccupied seats if possible.
- Secure the load using the tie-down eyes and distribute the load evenly.

### Stowage spaces in the vehicle interior

#### Overview of the front storage compartments

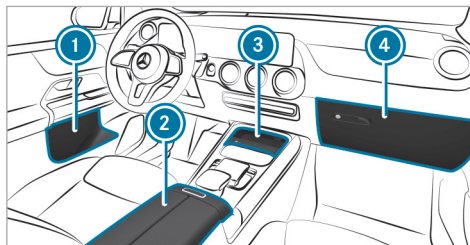

- ① Storage space in the doors
- ② Storage compartment in the armrest with a multimedia and USB connection
- ③ Storage compartment in the front center console with a USB port
- ④ Glove box

### Through-loading feature in the rear bench seat (EASY-PACK Quickfold)

#### Folding the rear seat backrest forwards

**⚠ WARNING** Risk of becoming trapped when adjusting the seats

When you adjust a seat, you may trap yourself or a vehicle occupant.

▶ When adjusting a seat, make sure that no one has any body parts in the sweep of the seat.

**⚠ WARNING** Risk of accident if the rear bench seat, rear seat and seat backrest are not engaged

The rear bench seat, rear seat and seat backrest may fold forwards, even when you are driving.

- As a result, the vehicle occupant will be pushed into the seat belt with increased force. The seat belt will not be able to

protect as intended and could cause additional injury.

- Objects or loads in the trunk or cargo compartment will not be restrained by the seat backrest.

▶ Make sure that the rear bench seat, the rear seat and the seat backrest are engaged before every trip.

If the seat backrests are not engaged and locked in place, the lock verification indicator will be red.

Always ensure that all vehicle occupants have their seat belts fastened correctly and are sitting properly. Particular attention must be paid to children.

If you no longer require the folded-down seat backrest as a loading area, fold the backrest back into place.

**Requirements:**

- The area into which the seat backrest is folded is clear.

- To fold the center seat backrest forwards: the center seat backrest has been unlocked.
- The armrest on the second row of seats is folded back and the cup holders are empty.

You can fold the center and outer seat backrests forwards.



▶ **Folding the left and right seat backrests forwards:** if necessary, fully insert the seat backrest head restraints (→ page 91).

▶ Pull release lever ①.

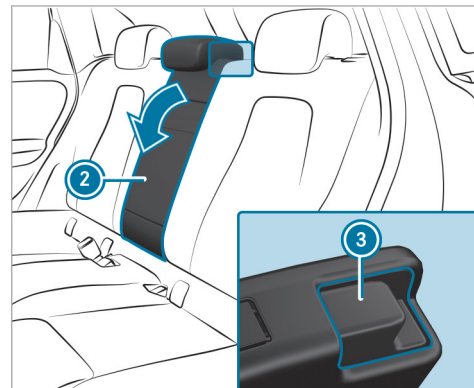

▶ **To fold the center seat backrest forwards:** pull release catch ③ of seat backrest ② forwards.

- ▶ Fold the corresponding seat backrest forwards.

### Folding back the rear seat backrest

**1 NOTE** Damage caused by trapping the seat belt when folding back the seat backrest

The seat belt could become trapped and thus damaged when the seat backrest is folded back.

- ▶ Make sure that the seat belt is not trapped when folding back the seat backrest.

- ▶ Move the driver's or front passenger seat forwards, if necessary.

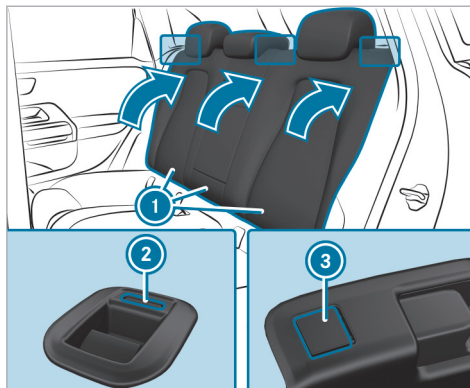

- ▶ Fold corresponding seat backrest **1** back until it engages.

**Left and right seat backrests:** if the seat backrest is not engaged and locked, red lock verification indicator **2** will be visible.

**Center seat backrest:** if the seat backrest is not engaged and locked, red lock verification indicator **3** will be visible.

### Locking the release catch of the center rear seat backrest

#### Requirements:

- The left and center seat backrests are engaged and joined together.

You can lock the center seat backrest. The center seat backrest can then be folded forwards only together with the left seat backrest.

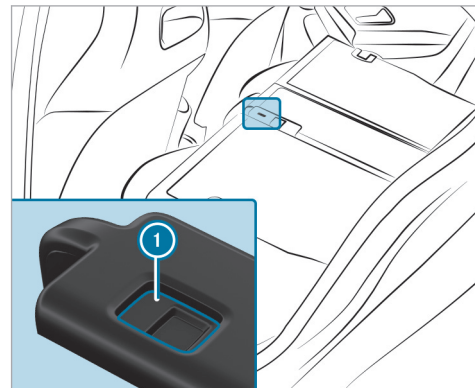



- ▶ Fold the center and left seat backrests forwards.
- ▶ **To lock or unlock:** slide catch ❶ upwards or downwards.

### Adjusting the angle of the rear seat backrests

**⚠ WARNING** Risk of accident if the rear bench seat, rear seat and seat backrest are not engaged

The rear bench seat, rear seat and seat backrest may fold forwards, even when you are driving.

- As a result, the vehicle occupant will be pushed into the seat belt with increased force. The seat belt will not be able to protect as intended and could cause additional injury.
- Objects or loads in the trunk or cargo compartment will not be restrained by the seat backrest.

- ▶ Make sure that the rear bench seat, the rear seat and the seat backrest are engaged before every trip.

For vehicles with longitudinally adjustable rear seats, you can also adjust the angle of the rear seat backrests. There are several possible detent positions.

**⚠ NOTE** Damage to the release loops of the seat backrests in the rear passenger compartment may be damaged due to the attachment of objects.

The release loops of the seat backrests in the rear passenger compartment may be damaged due to the attachment of objects.

- ▶ Only attach objects to the tie-down eyes.

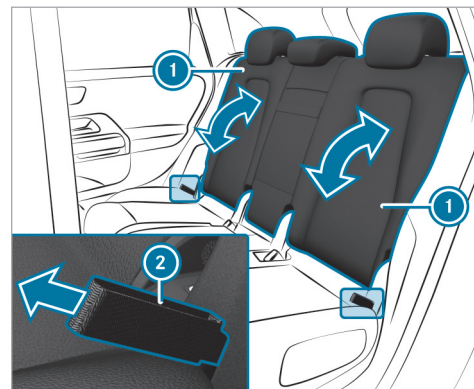

- ▶ Pull the right or left release loop ❷ forwards in the direction of the arrow. Corresponding seat backrest ❶ will be unlocked.
- ▶ Move seat backrest ❶ to the desired angle.
- ▶ Let go of release loop ❷.
- ▶ Ensure that the seat backrest is engaged.

### Cargo compartment cover

#### Installing and removing the cargo compartment cover

**⚠ WARNING** Risk of injury or death due to poorly secured objects

The cargo compartment cover alone cannot secure or restrain heavy objects, items of luggage or heavy loads.

You could be hit by an unsecured load, particularly in the event of abrupt changes in direction, sudden braking or an accident.

- ▶ Always stow objects in such a way that they cannot be thrown around.
- ▶ Secure objects, luggage or loads against slipping or tipping over, e.g. by using tie downs, even if you are using the cargo compartment cover.

Requirements:

- Do not load the cargo compartment cover with more than 5.5 lb (2.5 kg).

- i** Please note that the cargo compartment cover must not be pushed further upwards when the tailgate is open.

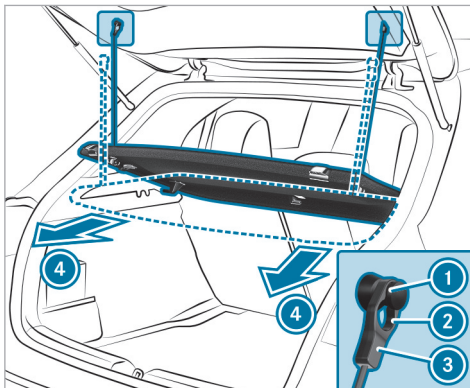

- ▶ **To remove:** pull hanger **3** on the tailgate upwards out of eyelet **1** and unhook it.
- ▶ Swivel the cargo compartment cover downwards and pull it evenly out of the guide rails

on the right and left in the direction of arrow **4**.

- ▶ **To install:** place the cargo compartment cover onto the guide rails on the left and right.
- ▶ Slide the cargo compartment cover forwards evenly in the guide rails on the right and left with both hands until it engages.
- ▶ Swivel the cargo compartment cover upwards and hook hanger **3** through eyelet **2**.
- ▶ Then pull hanger **3** downwards into eyelet **1** until it engages.

- i** Please ensure that the cargo compartment cover is lying flat on the guide rails on the right and left when the tailgate is closed.

#### Overview of the tie-down eyes

Observe the notes on loading the vehicle (→ page 98).

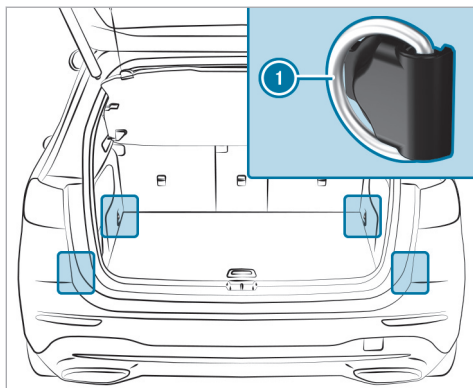

- ① Tie-down eyes (vehicles with through-loading feature in the rear bench seat)

### Overview of bag hooks

**⚠ WARNING** Risk of injury when using bag hooks with heavy objects

The bag hooks cannot restrain heavy objects or items of luggage.

Objects or items of luggage may be flung around and hit vehicle occupants.

- ▶ Only hang light objects on the bag hooks.
- ▶ Never hang hard, sharp-edged or fragile objects on the bag hooks.

Observe the notes on loading the vehicle (→ page 98).

Subject the bag hooks to a maximum load of 6.6 lbs (3 kg) and do not attach any goods to them.

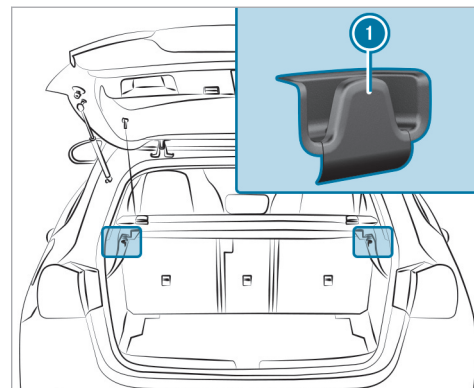

- ① Bag hook

### Overview of clothes hooks on the tailgate

Observe the notes on loading the vehicle (→ page 98).

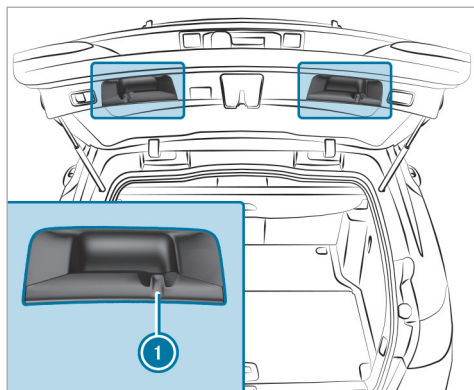

① Clothes hook

Clothes hooks are not suitable for hanging heavy objects as this can cause the tailgate to lower automatically. Use the clothes hooks only for light objects such as jackets.

### Attaching the parcel net

**⚠ WARNING** Risk of injury due to objects being stowed incorrectly

If you do not adequately stow objects in the vehicle interior, they could slip or be tossed around and thereby strike vehicle occupants. In addition, cup holders, open stowage spaces and mobile phone brackets cannot always restrain the objects they contain in the event of an accident.

There is a risk of injury, particularly in the event of sudden braking or a sudden change in direction.

- ▶ Always stow objects in such a way that they cannot be tossed about in these or similar situations.
- ▶ Always make sure that objects do not project from stowage spaces, parcel nets or stowage nets.
- ▶ Close the lockable stowage spaces before starting a journey.

- ▶ Stow and secure objects that are heavy, hard, pointed, sharp-edged, fragile or too large in the cargo compartment.

Observe the notes on loading the vehicle.

**⚠ WARNING** Risk of injury due to an open cargo compartment floor

If you drive with the cargo compartment floor open, objects could be flung around and hit vehicle occupants as a result. There is a risk of injury, particularly in the event of sudden braking or a sudden change in direction.

- ▶ Always close the cargo compartment floor before a journey.
- ▶ Lift the cargo compartment floor upwards using the handle, remove it from the cargo compartment and put it down on a clean surface .

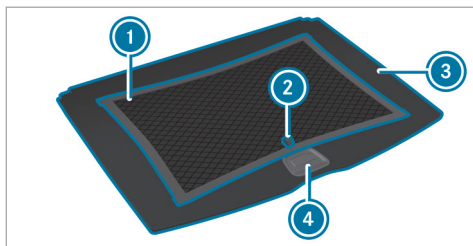

- ▶ Align parcel net ① on cargo compartment floor ③ so that strap ② is positioned at handle ④ and points upwards.

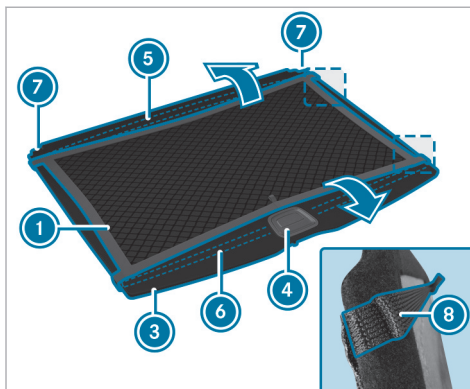

- ▶ Pull rubber sections ⑤ and ⑥, over cargo compartment floor ③ as shown.
- ▶ Align parcel net ① so that
  - Rubber section ⑤ runs underneath recesses ⑦ and beads ⑧ on the left and right are placed on the lower edge of cargo compartment floor ③.
  - Rubber section ⑥ runs above handle ④ and beads ⑧ on the left and right are

placed on the lower edge of cargo compartment floor ③.

- ① Ensure that the parcel net does not block the locking mechanism of the cargo compartment floor.
- ▶ Close the cargo compartment floor.

#### Adjustable cargo compartment floor

The cargo compartment can be made larger or smaller depending on requirements. To this end, you can lock the cargo compartment floor at two different heights. The higher position provides a flat surface when the rear seat backrests are folded forward. Furthermore, you can remove a bracket at the rear to create additional space lengthways.

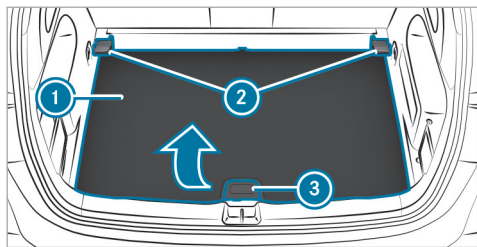

- ▶ **To adjust the height:** lift cargo compartment floor ① (in the lower position in the example) only slightly using handle ③ and pull it towards you.
- ▶ Insert cargo compartment floor ① into rear fixtures ②.
- ▶ Fold cargo compartment floor ① down.

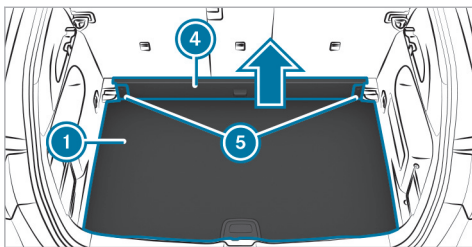

- ▶ **To adjust the length:** fold the seat backrests in the rear passenger compartment forward slightly.
- ▶ Make sure that cargo compartment floor ① is engaged in the lower position.
- ▶ Press a release catch ⑤ and remove bracket ④ upwards.

**!** **NOTE** Damage to the cargo compartment floor

If the cargo compartment floor is loaded in the upper position and the bracket has been removed, the cargo compartment floor may be damaged.

- ▶ Make sure that the cargo compartment floor is not loaded in the upper position when the bracket has been removed.

### Attaching a roof luggage rack

**!** **WARNING** Risk of accident due to exceeding the maximum roof load

The vehicle center of gravity and the usual driving characteristics as well as the steering and braking characteristics alter.

If you exceed the maximum roof load, the driving characteristics, as well as steering and braking, will be greatly impaired.

- ▶ Never exceed the maximum roof load and adjust your driving style.

You will find information on the maximum roof load in the "Technical data" section.

**!** **NOTE** Damage to the panorama roof with power tilt/sliding panel due to non-approved roof luggage racks

The panorama roof with power tilt/sliding panel may be damaged by the roof luggage rack if you attempt to open it when using a roof luggage rack not tested and approved for Mercedes-Benz.

▶ When a roof luggage rack is installed, open the panorama roof with power tilt/sliding panel only if this has been tested and approved for Mercedes-Benz.

The panorama roof with power tilt/sliding panel may be raised to allow ventilation of the vehicle interior.

- ▶ Secure the roof luggage rack to the roof railing.
- ▶ Observe the manufacturer's installation instructions.

## Sockets

### Using the 12 V socket

#### Requirements:

- Only devices up to a maximum of 180 W (15 A) are permissible.

Depending on the vehicle equipment, the vehicle has the following 12 V sockets:

- In the storage compartment in the front center console
- In the cargo compartment

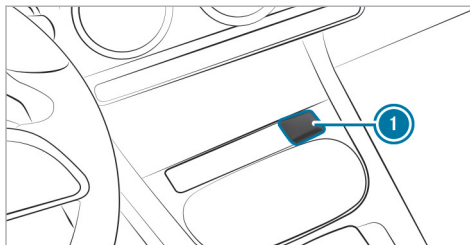

Example: 12 V socket in the storage compartment in the front center console

- ▶ Fold up socket cap ①.
- ▶ Insert the plug of the device.

**12 V socket in the storage compartment with cover:** if you have connected a device to the 12 V socket, leave the cover of the storage compartment open.

### Using the 115 V socket in the rear passenger compartment

**!** **DANGER** Risk of fatal injury due to damaged connecting cables or sockets

You could receive an electric shock if the connecting cable or the 115 V power socket is pulled out of the trim or is damaged or wet.

- ▶ Use only connecting cables that are dry and free of damage.
- ▶ When the ignition is switched off, make sure that the 115 V power socket is dry.
- ▶ Immediately have the 115 V power socket checked or replaced at a quali-

fied specialized workshop if it is damaged or has been pulled out of the trim.

- ▶ Never plug the connecting cable into a 115 V power socket that is damaged or has been pulled out of the trim.

**⚠ DANGER** Risk of fatal injury due to incorrect handling of the socket

You could receive an electric shock in particular:

- If you reach into the socket.
- If you insert unsuitable devices or objects into the socket.
- ▶ Do not reach into the socket.
- ▶ Only connect suitable devices to the socket.

#### Requirements:

- Devices are equipped with a suitable plug which conforms to the standards specific to the country you are in.

- A device up to a maximum of 150 W (1.3 A) is used.
- Do not use multiple socket outlets.

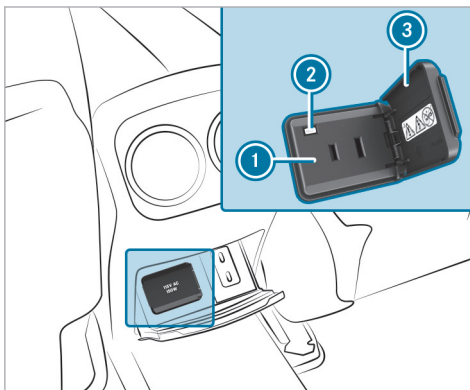

- ▶ Open flap ③.
- ▶ Insert the plug of the device into 115 V socket ①. When the on-board electrical system voltage is sufficient, indicator lamp ② lights up.

#### USB port in the rear passenger compartment

- ⓘ Depending on the vehicle equipment, the design of the storage compartment and the number of USB ports in the rear passenger compartment center console may vary.

If the ignition is switched on you can charge a USB device, e.g. a mobile phone, at USB ports using a suitable charging cable.

#### Wireless charging of the mobile phone and connection with the exterior antenna

#### Notes on wirelessly charging the mobile phone

**⚠ WARNING** Risk of injury due to objects being stowed incorrectly

If objects in the vehicle interior are stowed incorrectly, they can slide or be thrown around and hit vehicle occupants. In addition, cup holders, open stowage spaces and mobile phone receptacles cannot always retain all objects within.



There is a risk of injury, particularly in the event of sudden braking or a sudden change in direction.

- ▶ Always stow objects so that they cannot be thrown around in such situations.
- ▶ Always make sure that objects do not protrude from stowage spaces, parcel nets or stowage nets.
- ▶ Close the lockable stowage spaces before starting a journey.
- ▶ Always stow and secure heavy, hard, pointed, sharp-edged, fragile or bulky objects in the trunk/cargo compartment.

Observe the notes on loading the vehicle.

**⚠ WARNING** Risk of fire from placing objects in the mobile phone storage compartment

Placing other objects in the mobile phone storage compartment could constitute a fire hazard.

- ▶ Apart from a mobile phone, do not place any other objects in the mobile phone storage compartment, especially those made of metal.

**!** **NOTE** Damage to objects caused by placing them in the mobile phone storage compartment

If objects are placed in the mobile phone storage compartment, they may be damaged by electromagnetic fields.

- ▶ Do not place credit cards, data storage devices, ski passes or other objects sensitive to electromagnetic fields in the mobile phone storage compartment.

**!** **NOTE** Damage to the mobile phone stowage compartment caused by liquids

If liquids enter the mobile phone stowage compartment, the compartment may be damaged.

- ▶ Ensure that no liquids enter the mobile phone stowage compartment.

The following notes on wirelessly charging the mobile phone must be observed:

- Depending on the vehicle equipment, the mobile phone is connected to the vehicle's exterior antenna via the charging module.
- The charging function and wireless connection of the mobile phone to the vehicle's exterior antenna are only available if the ignition is switched on.
- Small mobile phones may not be able to be charged in every position of the mobile phone stowage compartment.
- Large mobile phones which do not rest flat in the mobile phone stowage compartment may not be able to be charged or connected with the vehicle's exterior antenna.
- The mobile phone may heat up during the charging process. This may particularly depend on the applications (apps) currently open in the background.

- To ensure more efficient charging and connection with the vehicle's exterior antenna, remove the protective cover from the mobile phone. Protective covers which are necessary for wireless charging are excluded.

### Wirelessly charging a mobile phone

#### Requirements:

- The mobile phone is suitable for wireless charging. You can find a list of compatible mobile phones at:  
<https://www.mercedes-benz-mobile.com>

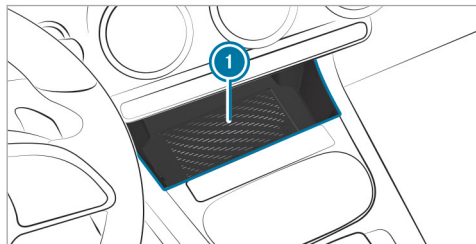

- ▶ Place the mobile phone as close to the center of the marked surface on mat ① as possible with the display facing upwards. When a message is shown in the multimedia system, the mobile phone is being charged. Malfunctions during the charging process are shown in the media display.

- ① The mat can be removed for cleaning, e.g. using clean, lukewarm water.

#### Stowage compartment without cover

Make sure the mobile phone is properly stored and secured to prevent it from falling out while you are driving.

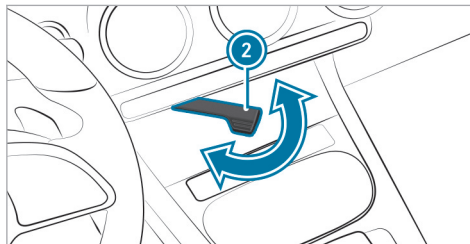

- ▶ **To secure the mobile phone:** swing lever ② out.

### Installing/removing the floor mats

- ⚠ **WARNING** Risk of accident due to objects in the driver's footwell

Objects in the driver's footwell may impede pedal travel or block a depressed pedal.

This jeopardizes the operating and road safety of the vehicle.

- ▶ Stow all objects in the vehicle securely so that they cannot get into the driver's footwell.
- ▶ Always install the floor mats securely and as prescribed in order to ensure that there is always sufficient room for the pedals.
- ▶ Do not use loose floor mats and do not place floor mats on top of one another.

### Installing floor mats

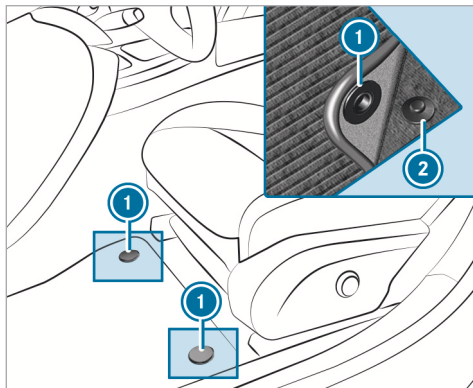

- ▶ Slide the corresponding seat backwards and lay the floor mat in the footwell.
- ▶ Press studs ① onto holders ②.
- ▶ Adjust the corresponding seat.

### Removing floor mats

- ▶ **To remove:** pull the floor mat off the holders ②.
- ▶ Remove the floor mat.

## Exterior lighting

### Information about lighting systems and your responsibility

The various lighting systems of the vehicle are only aids. The driver of the vehicle is responsible for correct vehicle illumination in accordance with the prevailing light and visibility conditions, legal requirements and traffic situation.

### Light switch

#### Operating the light switch

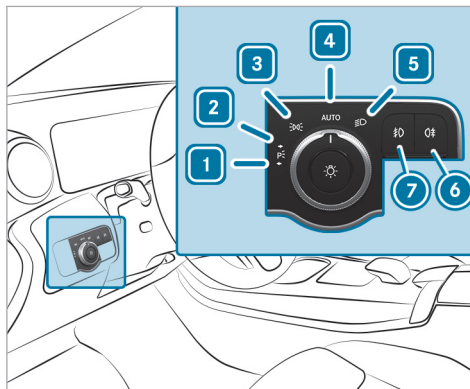

- 1 Left-hand standing lamps
- 2 Right-hand standing lamps
- 3 Parking lamps and license plate lamp
- 4 **AUTO** Automatic driving lights (preferred light switch position)
- 5 Low beam/high beam

- 6 Switches the rear fog light on/off
- 7 Switches the front fog lamp on/off

When low beam is activated, the indicator lamp for the parking lamps will be deactivated and replaced by the low-beam indicator lamp.

▶ Always park your vehicle safely using sufficient lighting, in accordance with the relevant legal stipulations.

**!** **NOTE** Battery discharging by operating the standing lights

Operating the standing lights over a period of hours puts a strain on the battery.

▶ Where possible, switch on the right or left parking light.

In the event of severe battery discharging, the parking lamps or standing lamps will be switched off automatically to facilitate the next engine start.

The exterior lighting (except standing and parking lamps) will switch off automatically when the driver's door is opened.

- Observe the notes on surround lighting (→ page 118).

### Automatic driving lights function

The parking lamps, low beam and daytime running lamps are switched on automatically depending on the ignition status and the ambient light.

**⚠ WARNING** Risk of accident when the low beam is switched off in poor visibility

When the light switch is set to **AUTO**, the low beam may not be switched on automatically if there is fog, snow or other causes of poor visibility such as spray.

- ▶ In such cases, turn the light switch to .

The automatic driving lights are only an aid. You are responsible for vehicle lighting.

### Switching the rear fog lights on or off

**Requirements:**

- The light switch is in the  or **AUTO** position.

- ▶ Press the  button.

Please observe the country-specific laws on the use of rear fog lamps.

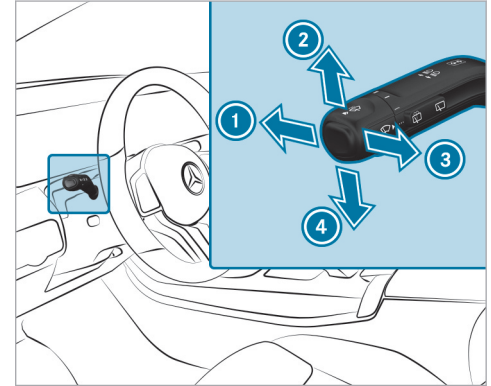

### Operating the combination switch for the lights



- 1 High beam
- 2 Turn signal light, right
- 3 High-beam flasher
- 4 Turn signal light, left

- ▶ Use the combination switch to activate the desired function.

### High beam

- ▶ **To switch on:** turn the light switch to the  or **AUTO** position.
- ▶ Push the combination switch in the direction of arrow ①.  
When the high beam is activated, the  indicator lamp for low beam is deactivated and replaced by the  indicator lamp for high beam.
- ▶ **To switch off:** push the combination switch in the direction of arrow ① or pull it in the direction of arrow ③.

### High-beam flasher

- ▶ Pull the combination switch in the direction of arrow ③.

### Turn signal light

- ▶ **To indicate briefly:** push the combination switch briefly to the point of resistance in the direction of arrow ② or ④.  
The corresponding turn signal light will flash three times.

- ▶ **To indicate permanently:** push the combination switch beyond the point of resistance in the direction of arrow ② or ④.

### Activating/deactivating the hazard warning lights

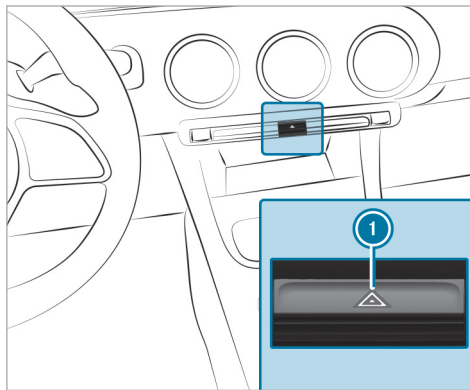

- ▶ Press button ①.

The hazard warning lights will switch on automatically if:

- The airbag has been deployed.

### Cornering light

#### Cornering light function

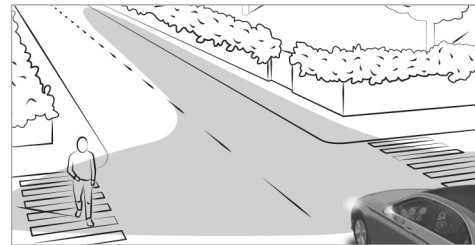

The cornering light improves the illumination of the road over a wide angle in the turning direction, enabling better visibility on tight curves, for example. It can be activated only when the low beam is switched on.

The function is active in the following cases:

- At speeds below 25 mph (40 km/h) when the turn signal light is switched on or the steering wheel is turned
- At speeds between 25 mph (40 km/h) and 43 mph (70 km/h) and when the steering wheel is turned

**Roundabout and intersection function:** the cornering light will be activated on both sides based on an evaluation of the vehicle's current GPS position. It will remain active until after the vehicle has left the roundabout or the intersection.

## Adaptive Highbeam Assist

### Adaptive Highbeam Assist function

**⚠ WARNING** Risk of accident despite Adaptive Highbeam Assist

Adaptive Highbeam Assist does not react to:

- Road users without lights, e.g. pedestrians
- Road users with poor lighting, e.g. cyclists
- Road users whose lighting is obstructed, e.g. by a barrier

On very rare occasions, Adaptive Highbeam Assist may fail to recognize other road users with their own lighting, or may recognize them too late.

In these, or in similar situations, the automatic high beam will not be deactivated or will be activated despite the presence of other road users.

▶ Always observe the road and traffic conditions carefully and switch off the high beam in good time.

Adaptive Highbeam Assist cannot take into account road, weather or traffic conditions.

Detection may be restricted in the following cases:

- In poor visibility, e.g. fog, heavy rain or snow
- If there is dirt on the sensors or the sensors are obscured

Adaptive Highbeam Assist is only an aid. You are responsible for adjusting the vehicle's lighting to the prevailing light, visibility and traffic conditions.

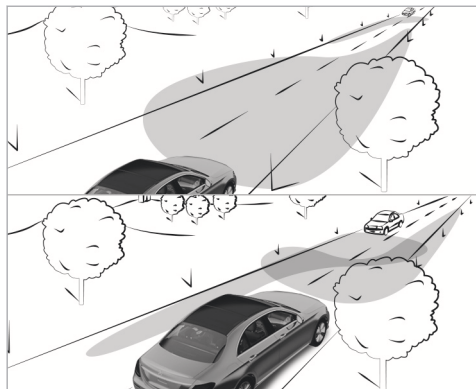

The Adaptive Highbeam Assist automatically switches between the following types of light:

- Low beam
- High beam

At speeds greater than 19 mph (30 km/h):

- If no other road users are detected, the high beam will be switched on automatically.

The high beam switches off automatically in the following cases:

- At speeds below 16 mph (25 km/h).
- If other road users are detected.
- If street lighting is sufficient.

At speeds greater than approximately 31 mph (50 km/h):

- The headlamp range of the low beam is regulated automatically based on the distance to other road users.

The system's optical sensor is located behind the windshield near the overhead control panel.

### Switching Adaptive Highbeam Assist on/off

- ▶ **To switch on:** turn the light switch to the **AUTO** position.
- ▶ Switch on the high beam using the combination switch.  
When the high beam is switched on automatically in the dark, the  indicator lamp on the multifunction display will light up.
- ▶ **To switch off:** switch off the high beam using the combination switch.

### Setting the exterior lighting switch-off delay time

#### Requirements:

- The light switch is in the **AUTO** position.

Multimedia system:

▶  ▶ Settings ▶ Light  
▶ Exterior Lighting Delay

- ▶ Set the switch-off delay time.  
When the vehicle engine is switched off, the exterior lighting will be activated for the set time.

### Switching the surround lighting on/off

Multimedia system:

▶  ▶ Settings ▶ Light  
▶ Locator Lighting

When **Locator Lighting** is active, the exterior lighting lights up for 40 seconds after the vehicle is unlocked. When you start the vehicle, the surround lighting is deactivated and the automatic driving lights are activated.







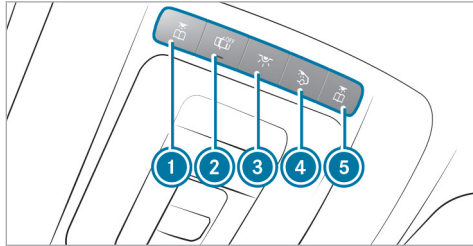

- ▶ Activate or deactivate the function.

## Interior lighting

### Adjusting the interior lighting

#### Front overhead control panel



- ①  Front left reading lamp
- ②  Automatic interior lighting control
- ③  Front interior lighting
- ④  Rear interior lighting
- ⑤  Front right reading lamp

- ▶ **To switch on or off:** press button ① – ⑤ accordingly.

#### Control panel in the grab handle

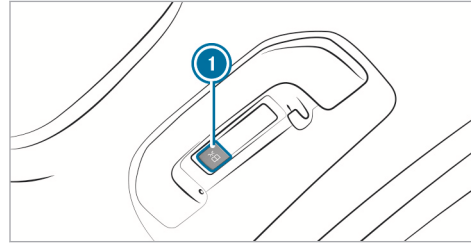

- ①  Rear reading lamp

- ▶ **To switch on or off:** press button ①.

## Adjusting the ambient lighting

Multimedia system:

- ▶  ▶ Settings ▶ Light
- ▶ Ambient Lighting

### Setting the color and brightness

- ▶ Select **Settings**.
- ▶ Set the color and brightness values.

### Activating the brightness for zones

- ▶ Select **Settings**.
- ▶ Select **Brightness Zones**.
- ▶ Activate or deactivate the function. The **ACCENT**, **AMBIANCE** and **VENTS** zones can be set separately.

### Activating multi-color lighting

- ▶ Select **Settings**.
- ▶ Select **Multi-color**.
- ▶ Activate or deactivate the function.

### Activating multi-color animation

- ▶ Select **Multi-color Animation**.

- ▶ Activate or deactivate the function.  
The chosen color combination will change at predefined intervals.

### Activating welcome lighting

- ▶ Select **Welcome**.
- ▶ Activate or deactivate the function.  
When the vehicle is unlocked, a special interior lighting sequence will run.

### Activating dependency on air conditioning settings

- ▶ Select **Climate**.
- ▶ Activate or deactivate the function.  
If changes are made to the temperature setting in the vehicle, the color of the ambient lighting will change briefly.

### Switching the interior lighting switch-off delay time on/off

Multimedia system:

- ▶  ▶ Settings ▶ Light
- ▶▶ Interior Lighting Delay

- ▶ Switch the switch-off delay time on or off.  
When this function is active, the interior lighting lights up for a short time after the vehicle is locked.

### Windshield wiper and windshield washer system

#### Switching the windshield wipers on/off

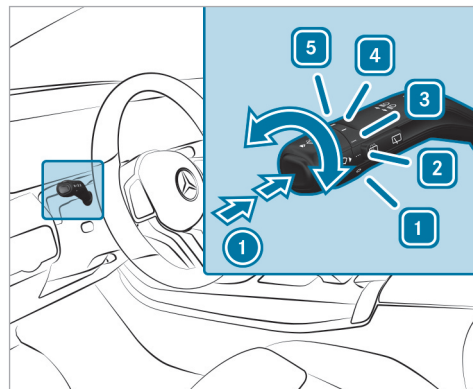



- 1  0 Windshield wipers off
- 2  ... Automatic wiping, normal
- 3  ... Automatic wiping, frequent

4  Continuous wiping, slow

5  Continuous wiping, fast

▶ Turn the combination switch to the correct position 1 - 5.

▶ **Single wipe/washing:** push the button on the combination switch in the direction of arrow 1.

-  Single wipe
-  Wipes with washer fluid

### Switching the rear window wiper on/off

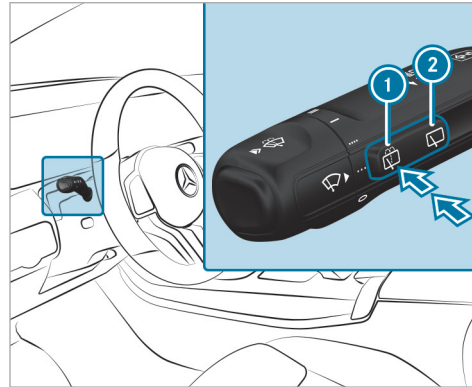

1  Single wipe/washing

2  Intermittent wipe

▶ **Single wipe:** press button 1 to the point of resistance.

▶ **Wiping with washer fluid:** press button 1 beyond the point of resistance.

▶ **Switching intermittent wipe on/off:** press button 2.

The  symbol will appear on the instrument cluster when the rear window wiper is switched on.

### Changing the windshield wiper blades

**⚠ WARNING** Risk of becoming trapped if the windshield wipers are switched on while wiper blades are being replaced

If the windshield wipers begin to move while you are changing the wiper blades, you can be trapped by the wiper arm.

▶ Always switch off the windshield wipers and the ignition before changing the wiper blades.

### Moving the wiper arms into the replacement position

- ▶ Switch the ignition on and switch off again immediately.
- ▶ Within around 15 seconds, press and hold the  button on the combination switch

for approximately three seconds  
(→ page 120).

The wiper arms will move into the replacement position.

### Removing the wiper blades

- ▶ Fold the wiper arms away from the windshield.

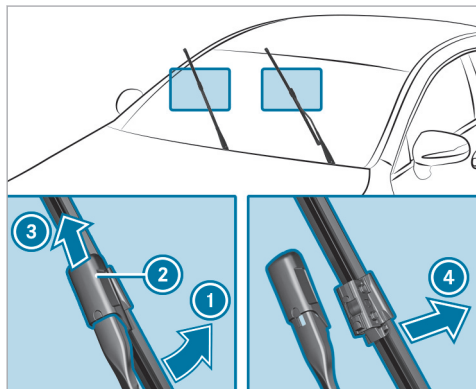

- ▶ Hold the wiper arm with one hand. With the other hand, turn the wiper blade in the direction of arrow ① away from the wiper arm as far as it will go.
- ▶ Slide catch ② in the direction of arrow ③ until it engages in the removal position.
- ▶ Remove the wiper blade from the wiper arm in the direction of arrow ④.

### Installing the wiper blades

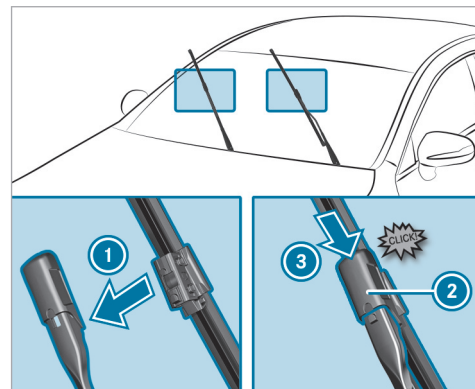

- ▶ Insert the new wiper blade into the wiper arm in the direction of arrow ①.
- ▶ Slide catch ② in the direction of arrow ③ until it engages in the locking position.
- ▶ Make sure that the wiper blade is seated correctly.

- ▶ Fold the wiper arms back onto the windshield.
- ▶ Switch on the ignition.
- ▶ Press the  button on the combination switch (→ page 120). The wiper arms will move into the original position.
- ▶ Switch the ignition off.

### Maintenance display

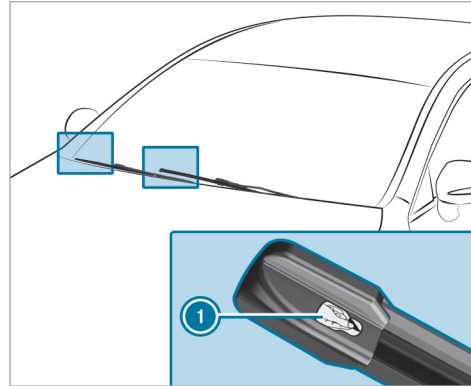

- ▶ Remove protective film ① from the maintenance display on the tip of the newly installed wiper blades.

When the color of the maintenance display changes from black to yellow, the wiper blades should be replaced.

- ① The duration until the color changes varies depending on the usage conditions.

### Replacing the rear window wiper blade

**⚠ WARNING** Risk of becoming trapped if the windshield wipers are switched on while wiper blades are being replaced

If the windshield wipers begin to move while you are changing the wiper blades, you can be trapped by the wiper arm.

- ▶ Always switch off the windshield wipers and the ignition before changing the wiper blades.

### Removing the wiper blade

- ▶ Switch the ignition off.

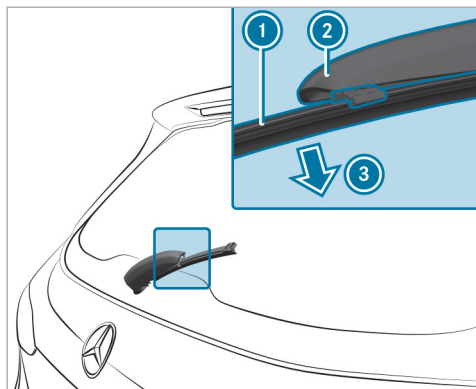

- ▶ Fold wiper arm ② away from the rear window until it engages in the replacement position.
- ▶ Unclip wiper blade ① from wiper arm ② and remove it in the direction of arrow ③.

### Installing the wiper blade

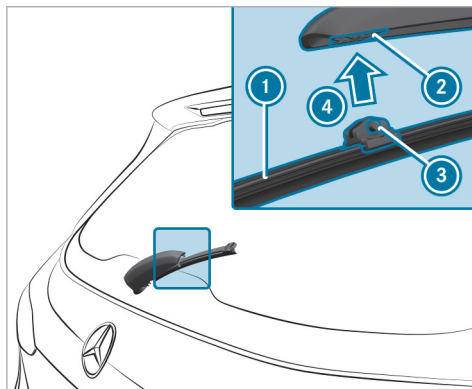

- ▶ Position wiper blade ① with both lugs ③ on holder ② on the wiper arm.
- ▶ Push wiper blade ① in the direction of arrow ④ until it engages in holder ②.
- ▶ Make sure that wiper blade ① is seated correctly.

- ▶ Fold the wiper arm from the replacement position back onto the rear window.

## Mirrors

### Operating the outside mirrors

**⚠ WARNING** Risk of accident due to adjusting vehicle settings while the vehicle is in motion

You could lose control of the vehicle in the following situations in particular:

- If you adjust the driver's seat, the head restraints, the steering wheel or the mirror while the vehicle is in motion.
  - If you fasten your seat belt while the vehicle is in motion.
- ▶ Before starting the engine: adjust the driver's seat, the head restraints, the steering wheel and the mirror and fasten your seat belt.

**⚠ WARNING** Risk of accident due to misjudgment of distance when using the front-passenger mirror

The outside mirror on the front passenger side reflects objects on a smaller scale.

- ▶ Therefore, always look over your shoulder in order to ensure that you are aware of the actual distance between you and the road users driving behind you.

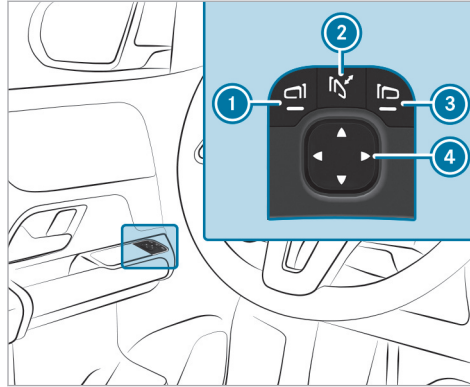

- ▶ **To fold in or out:** briefly press button ②.
  - ▶ **To set:** press button ① or ③ to select the outside mirror to be adjusted.
  - ▶ Press button ④ to adjust the position of the mirror glass.
- ⓘ If the battery has been disconnected or completely discharged, you will have to reset the

outside mirrors. Only then will the automatic mirror folding function work properly.

- ▶ **To adjust:** briefly press button ②.  
An outside mirror that has been pushed out of position can be engaged in position again as follows:
- ▶ **Vehicles without electrically folding outside mirrors:** Manually move the outside mirror into the correct position.
- ▶ **Vehicles with electrically folding outside mirrors:** Press and hold button ②.  
You will hear a click and the mirror will audibly click into place. The outside mirror will now be set to the correct position.

#### Automatic anti-glare mirrors function

**⚠ WARNING** Risk of acid burns and poisoning due to the anti-glare mirror electrolyte

Electrolyte may escape if the glass in an automatic anti-glare mirror breaks.

The electrolyte is hazardous to health and causes irritation. It must not come into contact with your skin, eyes, respiratory organs or clothing or be swallowed.

- ▶ If you come into contact with electrolyte, observe the following:
  - Immediately rinse the electrolyte from your skin with water and seek medical attention.
  - If electrolyte comes into contact with your eyes, immediately rinse them thoroughly with clean water and seek medical attention.
  - If the electrolyte is swallowed, immediately rinse your mouth out thoroughly. Do not induce vomiting. Seek medical attention immediately.
  - Immediately change out of clothing which has been contaminated with electrolyte.
  - If an allergic reaction occurs, seek medical attention immediately.

The inside rearview mirror and the outside mirror on the driver's side will automatically go into anti-glare mode if light from a headlamp hits the sensor on the inside rearview mirror.

#### **System limits**

The system will not go into anti-glare mode if:

- The engine is switched off.
- Reverse gear is engaged.
- The interior lighting is switched on.

#### **Front-passenger outside mirror parking position function**

The parking position makes parking easier.

The front-passenger outside mirror will swivel downwards in the direction of the rear wheel on the front passenger's side when:

- The parking position is stored (→ page 127).
- The front-passenger mirror is selected.
- Reverse gear is engaged.

The front-passenger outside mirror will move back to its original position when:

- You shift the transmission to another transmission position.
- You are traveling at a speed greater than 9 mph (15 km/h).
- You press the button for the outside mirror on the driver's side.



### Storing the parking position of the front-passenger outside mirror using reverse gear

#### Storing

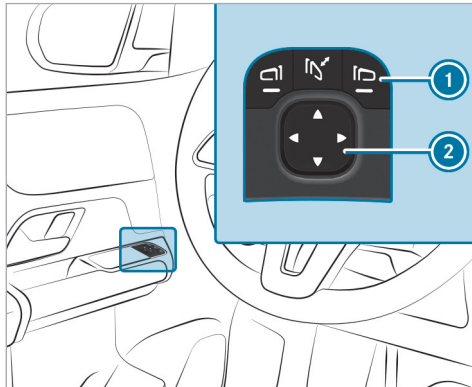

- ▶ Press button ① to select the front-passenger outside mirror.
- ▶ Engage reverse gear.
- ▶ Move the front-passenger outside mirror into the desired parking position using button ②.

#### Calling up

- ▶ Press button ① to select the front-passenger outside mirror.
- ▶ Engage reverse gear.  
The front-passenger outside mirror will move into the stored parking position.

### Activating/deactivating the automatic mirror folding function

Multimedia system:

- ▶  ▶ Settings ▶ Vehicle
- ▶ Switch Automatic Folding on or off.

## Overview of climate control systems

### Notes on climate control

An interior air filter in combination with the pre-filter in the engine compartment must always be used so that the air conditioning system, pollution level monitoring and the air filtration work correctly. Make sure that the filter is installed correctly and the filter housing in the engine compartment is closed correctly using the cap and always tightly sealed when in operation. Use filters recommended and approved by Mercedes-Benz. Always have service work carried out at a qualified specialist workshop.

### Overview of the control panel for 3-zone automatic climate control

The indicator lamps in the **AUTO**, **MAX**, **REAR**, **A/C** and **SYNC** buttons indicate that the corresponding function is activated.

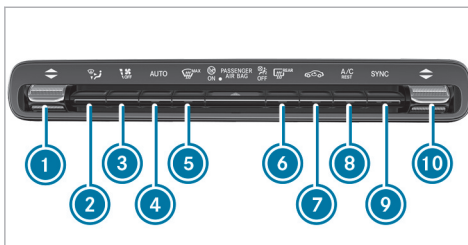

- 1 Sets the temperature on the driver's side
- 2 Sets the air distribution
- 3 Sets the airflow or switches off climate control
- 4 **AUTO** Sets climate control to automatic (→ page 129)
- 5 Defrosts the windshield
- 6 Switches the rear window heater on/off
- 7 Switches air-recirculation mode on/off (→ page 130)
- 8 **A/C** Switches the A/C function on/off (→ page 128)

Switches residual heat on/off (→ page 130)

- 9 **SYNC** Activates/deactivates synchronization (→ page 129)
- 10 Sets the temperature on the front passenger side

## Operating the climate control system

### Switching climate control on/off

- ▶ **To switch on:** set the airflow to level 1 or higher using the button.
- ▶ **To switch off:** set the airflow to level 0 using the button.
- ⓘ If climate control is switched off, the windows may fog up more quickly. Switch off climate control only briefly.

### Switching the A/C function on or off via the control panel

The A/C function heats, cools and dehumidifies the vehicle's interior air.

- ▶ Press the / button.

Switch off the A/C function only briefly; otherwise, the windows may fog up more quickly.

Condensation may drip from the underside of the vehicle when cooling mode is active. This is not a sign that there is a malfunction.

### Calling up the air conditioning menu

#### Calling up the air conditioning menu using the multimedia system

- ▶ Select one of the temperature displays at the lower edge of the media display.

#### Activating/deactivating the A/C function via the multimedia system

The A/C function heats, cools and dehumidifies the vehicle's interior air.

- ▶ Call up the air-conditioning menu (→ page 129).
- ▶ Select **First Row of Seats**.
- ▶ Select **A/C**.



### Setting climate control to automatic mode

In automatic mode, the set temperature is controlled and maintained at a constant level by the air supply.

- ▶ Press the **AUTO** button.
- ▶ **To switch to manual mode:** press the  or **AUTO** button.

In automatic mode, you can choose between five different air quantities using the  button. Automatic mode is retained.

### Setting the air distribution

- ▶ Call up the air conditioning menu (→ page 129).
  - ▶ Select a row of seats.
  - ▶ **To set the air distribution:** select ,  or .
  - ▶ Set the airflow.
- i** Several air distribution options can be selected at the same time, for example to set the climate control for the windshield and the footwells simultaneously.

The  climate control for the windshield can only be selected for the first seat row.

### Activating/deactivating the climate control synchronization function via the control panel

Climate control can be set centrally using the synchronization function. The temperature and air distribution settings for the driver's side will be adopted automatically for the front passenger side.

- ▶ Press the **SYNC** button.

The synchronization function will be deactivated if the settings for one of the other climate zones are changed.

### Activating/deactivating the climate control synchronization function via the multimedia system

Climate control can be set centrally using the synchronization function. The driver's settings for temperature, air quantity and air distribution are adopted automatically for all climate zones.

- ▶ Call up the air conditioning menu (→ page 129).
- ▶ Select **First Row of Seats**.
- ▶ Select **SYNC**.

### Removing condensation from the windows

#### Windows fogged up on the inside

- ▶ Press the **AUTO** button.
- ▶ If the windows continue to fog up: press the  button.

#### Windows fogged up on the outside

- ▶ Switch on the windshield wipers.
- ▶ Press the **AUTO** button.

### Switching air-recirculation mode on/off

- ▶ Press the  button.  
The interior air will be recirculated.

Air-recirculation mode automatically switches to fresh air mode after some time.

- ⓘ If air-recirculation mode is switched on, the windows may fog up more quickly. Switch on air-recirculation mode only briefly.

### Switching the residual heat on/off (Canada)

#### Requirements:

- The vehicle is parked.
- ⓘ Only vehicles with a diesel engine can use residual heat.

It is possible to make use of the residual heat from the engine to continue heating or ventilating the front compartment of the vehicle for approximately 30 minutes, depending on the temperature set.

- ▶ **To activate:** press the  button.

Residual heat will be switched off automatically.

### Air vents

#### Adjusting the front air vents

**⚠ WARNING** Risk of burns and frostbite due to being too close to the air vents

Very hot or very cold air can flow from the air vents.

- ▶ Make sure that all vehicle occupants always maintain a sufficient distance from the air vents.
- ▶ If necessary, direct the airflow to another area of the vehicle interior.

To guarantee the flow of fresh air through the air vents into the vehicle interior, comply with the following:

- Always keep the vents and the vent grille in the vehicle interior free.
- Keep the air inlet free of deposits (→ page 235).

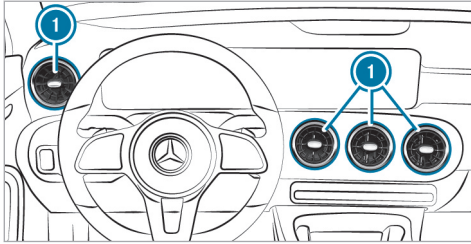

- ▶ **To open or close:** hold air vent ① in the center and turn it counter clockwise (open) or clockwise (closed) as far as it will go.
- ▶ **To set the airflow direction:** hold air vent ① in the center and move it up or down or to the left or right.

### Adjusting the rear air vents

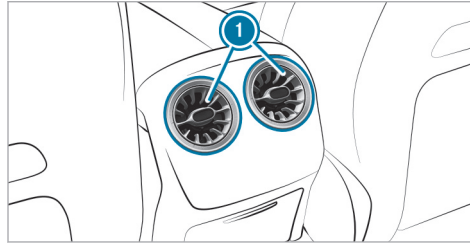

- ▶ **To open or close:** hold air vent ① in the center and turn it to the left (open) or right (closed) as far as it will go.
- ▶ **To set the airflow direction:** hold air vent ① in the center and move it up or down or to the left or right.

## Driving

### Notes on Mercedes-AMG vehicles

Observe the notes on the following additional topics in the Supplement, as you may otherwise fail to recognize dangers:

- Emotion Start
- AMG exhaust system
- RACE START
- DRIFT MODE
- AMG steering-wheel buttons

### Switching on the power supply or the ignition (without engine start)

**⚠ WARNING** Risk of accident and injury due to children left unattended in the vehicle

If children are left unsupervised in the vehicle, they could, in particular:

- Open doors, thereby endangering other persons or road users.
- Get out and be struck by oncoming traffic.
- Operate vehicle equipment and become trapped, for example.

In addition, the children could also set the vehicle in motion, for example by:

- Releasing the parking brake.
- Change the transmission position.
- Start the vehicle.

▶ Never leave children unattended in the vehicle.

- ▶ When leaving the vehicle, always take the SmartKey with you and lock the vehicle.
- ▶ Keep the SmartKey out of reach of children.

Also observe the "Notes on pets in the vehicle".

#### Requirements:

- The SmartKey is in the vehicle and has been recognized.
- **Vehicles with automatic transmission:**  
The brake pedal is not depressed.

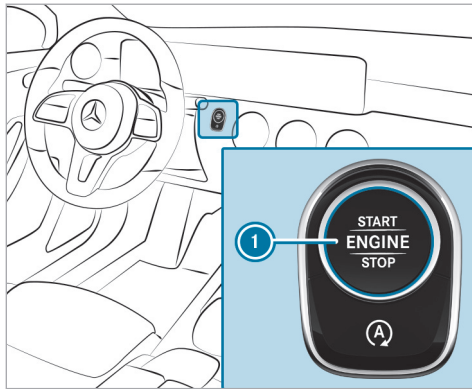

- ▶ **To switch on the power supply:** press button ① once. You can activate the windshield wipers, for example.

The power supply is switched off again if the following conditions are met:

- You open the driver's door.
- You press button ① twice more.

- ▶ **To switch on the ignition:** press button ① twice. The indicator lamps in the instrument cluster light up.

The ignition is switched off again if one of the following conditions is met:

- **Vehicles with automatic transmission:** You do not start the vehicle within 15 minutes and the transmission is in position **P** or the electric parking brake is applied.
- You press button ① once.

### Starting the vehicle

#### Starting the vehicle with the start/stop button

- ▶ **DANGER** Risk of death caused by exhaust gases

Combustion engines emit poisonous exhaust gases such as carbon monoxide. Inhaling these exhaust gases is hazardous to health and leads to poisoning.

- ▶ Never leave the engine or, if present, the auxiliary heating running in an enclosed space without sufficient ventilation.

- ▶ **WARNING** Risk of fire due to flammable material in the engine compartment or the exhaust system

Flammable materials may ignite.

- ▶ Therefore, check regularly that there are no flammable materials in the engine compartment or on the exhaust system.

#### Requirements:

- The SmartKey is in the vehicle and is recognized.
- ▶ Shift the transmission to position **P** or **N**.
- ▶ Depress the brake pedal and press button ① once.

- ▶ If the vehicle does not start: switch off non-essential consumers and press button ① once.
- ▶ If the vehicle still does not start and the **Place the Key in the Marked Space See Operator's Manual** message also appears in the multifunction display: start the vehicle with the SmartKey in the marked space (emergency operation mode) (→ page 134).

① You can switch off the engine while driving by pressing button ① for about three seconds or by pressing button ① three times within three seconds. Be sure to observe the safety notes under "Driving tips" (→ page 136).

### Starting the vehicle with the SmartKey in the marked space (emergency operation mode)

If the vehicle does not start and the **Place the Key in the Marked Space See Operator's Manual** message appears in the multifunction display, you can start the vehicle in emergency operation mode.

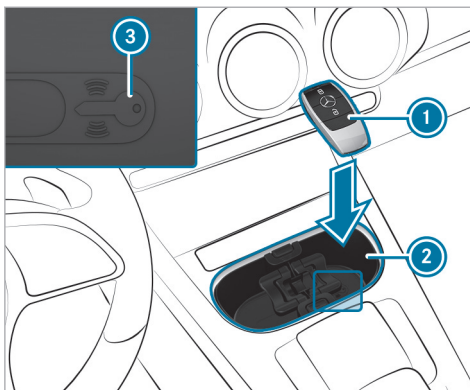

Marked space (example with cup holder without cover)

- ▶ Open the cover of marked space ② if necessary.
- ▶ Make sure that marked space ② is empty.
- ▶ Remove SmartKey ① from the key ring.

- ▶ Place SmartKey ① in marked space ② on symbol ③.  
The vehicle will start after a short time.

If you remove SmartKey ① from marked space ② the engine continues running. For further engine starts however, SmartKey ① must be located in marked space ② on symbol ③ during the entire journey.

- ▶ Have SmartKey ① checked at a qualified specialist workshop.

### If the vehicle does not start:

- ▶ Place SmartKey ① in marked space ② and leave it there.
- ▶ Depress the brake pedal and start the vehicle using the start/stop button.
- ① You can also switch on the power supply or the ignition with the start/stop button.



## Starting the vehicle via Remote Online services

### Cooling or heating the vehicle interior before commencing your journey

Ensure the following before starting the engine:

- The legal stipulations in the area where your vehicle is parked allow engine starting via smartphone.
- It is safe to start and run the engine where your vehicle is parked.
- The fuel tank is sufficiently full.
- The starter battery is sufficiently charged.

### Charging the starter battery before starting the journey

If the vehicle battery is discharged, you receive a message on your smartphone. You can then start the vehicle with the smartphone to charge the battery. The vehicle is automatically switched off after ten minutes.

Ensure the following before starting the engine:

- The legal stipulations in the area where your vehicle is parked allow engine starting via smartphone.
- It is safe to start and run the engine where your vehicle is parked.
- The fuel tank is sufficiently full.

### Starting the vehicle (Remote Online)

**⚠ WARNING** Risk of crushing or entrapment due to unintentional starting of the engine

Limbs could be crushed or trapped if the engine is started unintentionally during service or maintenance work.

- ▶ Always secure the engine against unintentional starting before carrying out maintenance or repair work.

### Requirements:

- Park position **P** is selected.
- The anti-theft alarm system is not activated.

- The panic alarm is not activated.
- The hazard warning light system is switched off.
- The hood is closed.
- The doors are closed and locked.
- The windows and sliding sunroof are closed.

- ▶ Start the vehicle using the smartphone. After every engine start, the engine runs for ten minutes.

You can carry out a maximum of two consecutive starting attempts. The vehicle must be started once with the SmartKey before trying to start the engine again with the smartphone. you can stop the vehicle again at any time.

- ⓘ Further information can be found in the smartphone app.

### Securing the engine against starting before carrying out maintenance or repair work:

- ▶ Switch on the hazard warning light system.

or

- ▶ Unlock the doors.

or

- ▶ Open a side window or the sliding sunroof.

### Breaking-in notes

**Mercedes-AMG vehicles:** observe the notes in the Supplement. You could otherwise fail to recognize dangers.

To preserve the engine during the first 1,000 miles (1,500 km):

- drive at varying road speeds and engine speeds.
- drive the vehicle in drive program **[C]** or **[E]**.
- shift to the next highest gear at the very latest when the needle reaches the last third before the red area in the tachometer.
- do not shift down a gear manually in order to brake.
- avoid overstraining the vehicle, e.g. driving at full throttle.

- **vehicles with automatic transmission:** do not depress the accelerator pedal beyond the pressure point (kickdown).
- only increase the engine speed gradually and accelerate the vehicle to full speed after 1,000 miles (1,500 km).

This also applies when the engine or parts of the drivetrain have been replaced.

Please also observe the following breaking-in notes:

- in certain driving and driving safety systems, the sensors adjust automatically while a certain distance is being driven after the vehicle has been delivered or after repairs. Full system effectiveness is not reached until the end of this teach-in process.
- brakepads, brake discs and tires that are either new or have been replaced only achieve optimum braking effect and grip after several hundred miles of driving. Compensate for the reduced braking effect by applying greater force to the brake pedal.

### Notes on driving

**▲ WARNING** Risk of accident due to objects in the driver's footwell

Objects in the driver's footwell may impede pedal travel or block a depressed pedal.

This jeopardizes the operating and road safety of the vehicle.

- ▶ Stow all objects in the vehicle securely so that they cannot get into the driver's footwell.
- ▶ Always install the floor mats securely and as prescribed in order to ensure that there is always sufficient room for the pedals.
- ▶ Do not use loose floor mats and do not place floor mats on top of one another.

**▲ WARNING** Risk of accident due to incorrect footwear

Incorrect footwear includes, for example:

- Shoes with platform soles
- Shoes with high heels
- Slippers

▶ Always wear suitable footwear so that you can operate the pedals safely.

**▲ WARNING** Risk of accident when switching off the ignition when driving

If you switch off the ignition while driving, safety functions are restricted or no longer available.

You will then need, for example, to use considerably more force to steer and brake.

▶ Do not switch off the ignition while driving.

**▲ DANGER** Risk of death caused by exhaust gases

Combustion engines emit poisonous exhaust gases such as carbon monoxide. Inhaling these exhaust gases is hazardous to health and leads to poisoning.

▶ Never leave the engine or, if present, the auxiliary heating running in an enclosed space without sufficient ventilation.

**▲ WARNING** Risk of skidding and of an accident due to shifting down on slippery road surfaces

If you shift down on slippery road surfaces to increase the engine braking effect, the drive wheels may lose traction.

▶ Do not shift down on slippery road surfaces to increase the engine braking effect.

**▲ DANGER** Risk of fatal injury due to poisonous exhaust gases

If the tailpipe is blocked or sufficient ventilation is not possible, poisonous exhaust gases such as carbon monoxide may enter the vehicle. This is the case when the vehicle becomes stuck in snow, for example.

- ▶ Keep the tailpipe and the area around the vehicle free from snow when the engine or the stationary heater are running.
- ▶ Open a window on the side of the vehicle facing away from the wind to ensure an adequate supply of fresh air.

**▲ WARNING** Risk of accident and injury due to being under the influence of alcohol and drugs while driving

Driving when under the influence of alcohol and/or drugs is an extremely dangerous combination. Even small quantities of alcohol or drugs may affect your reflexes, perception and judgment.

The probability of a serious or even fatal accident greatly increases if you drive when under the influence of alcohol or drugs.

- ▶ Do not drink alcohol or take drugs while driving, and do not allow anyone to drive who has been drinking alcohol or taking drugs.

**⚠ WARNING** Risk of accident due to the brake system overheating

If you leave your foot on the brake pedal when driving, the brake system may overheat.

This increases the braking distance and the brake system may even fail.

- ▶ Never use the brake pedal as a footrest.
- ▶ Do not depress the brake pedal and the accelerator pedal at the same time while driving.

**! NOTE** Engine damage due to excessively high engine speeds

The engine will be damaged if you drive with the engine in the overrevving range.

- ▶ Do not drive with the engine in the overrevving range.

**! NOTE** Wearing out the brake linings by continuously depressing the brake pedal

- ▶ Do not depress the brake pedal continuously whilst driving.
- ▶ To use the braking effect of the engine, shift to a lower gear in good time.

**! NOTE** Damage to the drivetrain and engine when pulling away

- ▶ Do not warm up the engine while the vehicle is stationary. Pull away immediately.
- ▶ Avoid high engine speeds and driving at full throttle until the engine has reached its operating temperature.

**! NOTE** Damage to the catalytic converter due to non-combusted fuel

The engine is not running smoothly and is misfiring.

Non-combusted fuel may get into the catalytic converter.

- ▶ Only depress the accelerator pedal slightly.
- ▶ Have the cause rectified immediately at a qualified specialist workshop.

**Notes on driving on salt-treated roads**

The braking effect is limited on salt-treated roads.

Therefore, observe the following notes:

- due to salt build-up on the brake discs and brakepads, the braking distance can increase considerably or result in braking only on one side
- maintain a much greater safe distance to the vehicle in front

To remove salt build-up:

- brake occasionally while paying attention to the traffic conditions
- carefully depress the brake pedal at the end of the journey and when starting the next journey

### Notes on hydroplaning

Hydroplaning can take place once a certain amount of water has accumulated on the road surface.

Observe the following notes during heavy precipitation or in conditions in which hydroplaning may occur:

- reduce speed
- avoid tire ruts
- avoid sudden steering movements
- brake carefully

 Also observe the notes on regularly checking wheels and tires (→ page 264).

### Notes on driving through water on the road surface

Water which has entered into the vehicle can damage the engine, electrics and transmission.

Water can also enter the air intake of the engine and cause engine damage.

Observe the following if you must drive through water:

- The water, when calm, may only reach the lower edge of the vehicle body.
- Drive at walking pace at most, otherwise water can enter the vehicle interior or engine compartment.
- Vehicles traveling in front, or oncoming vehicles, can create waves which may exceed the maximum permissible depth of the water.

The braking effect of the brakes is reduced after fording. Brake carefully while paying attention to the traffic conditions until braking power has been fully restored.

### Notes on off-road driving

 **WARNING** Risk of accident if you do not keep to line of fall on inclines

If you drive at an angle or turn on an incline, the vehicle could slip sideways, tip and roll-over.

- ▶ Always drive on inclines in the line of fall (straight up or down) and do not turn.

 **WARNING** Risk of fire due to flammable materials on hot parts of the exhaust system

Flammable material such as leaves, grass or twigs may ignite if they come into contact with hot parts of the exhaust system.

- ▶ When driving on unpaved roads or off-road, regularly check the vehicle underside.
- ▶ Remove trapped plants or other flammable material, in particular.

- ▶ If there is damage, consult a qualified specialist workshop immediately.

When driving off-road, sand, mud and water or water mixed with oil may get into the brakes. This may lead to a reduction in braking effect or total brake failure as a result of increased wear. The braking characteristics will vary depending on the material that has entered the system. Clean the brakes after driving off-road. If you then notice reduced braking effect or hear scraping noises, have the brake system checked at a qualified specialist workshop. Adapt your driving style to the changed braking characteristics.

- !** **NOTE** Damage caused by driving over obstacles

The vehicle can be damaged by:

- driving up onto high curbs or unpaved roads.
- quickly driving over obstacles such as curbs, speed bumps or potholes.

- heavy objects hitting the underbody or chassis components.
- ▶ Do not drive over obstacles that could damage the vehicle.
- ▶ Check the vehicle regularly for damage during off-road driving.
- ▶ Adjust the vehicle speed to suit the road surface conditions.
- ▶ If there is damage, consult a qualified specialist workshop immediately.



**ENVIRONMENTAL NOTE** Environmental damage due to non-observance of prohibition signs

Environmental protection has priority. Treat nature with respect.

- ▶ Be sure to observe prohibition signs.

- i** The vehicle is designed for easily negotiable and moderate off-road terrain. When driving off-road, make sure there is sufficient ground clearance.

### Checklist before driving off-road

Check the following points before driving off-road:

- Fuel level
- Engine oil level: fill engine oil to the maximum level to ensure full gradeability (→ page 232).
- Tire-change tool kit and spare wheel
- Tires and wheels

### Off-road driving

Read this section before driving your vehicle off-road. Practice by driving over more gentle off-road terrain first.

- Observe the notes on the cross-country ABS (→ page 163).
- If necessary, select the  (→ page 144) drive program before driving off-road.
- Always keep the engine running and in gear when driving on downhill gradients and slopes. Observe the notes on driving in mountainous terrain.

- Do not drive on unknown terrain that is not easily visible and stay on marked routes.
- Always keep the doors and windows closed while the vehicle is in motion.
- Deactivate Active Distance Assist DISTRONIC and cruise control.
- Adapt your driving style to the terrain.
- Do not use the HOLD function on steep downhill or uphill gradients with slippery or loose surfaces.

### Driving on sand

When driving on sand, also observe the following instructions:

- Select the  drive program.
- Shift to a lower gear.
- Drive quickly to overcome the rolling resistance, otherwise the vehicle may dig itself in.
- Drive in the tracks of other vehicles if possible. Make sure that the following prerequisites are met:
  - the tire ruts are not too deep
  - the sand is firm enough

- the ground clearance is sufficient

**Mercedes-AMG vehicles:** observe the notes in the Supplement. You could otherwise fail to recognize dangers.

### Fording

Also observe the following information when fording:

- Drive no faster than 6 mph (10 km/h).
- The water, when calm, may only reach the lower edge of the vehicle body.
- Switch off automatic climate control (→ page 129).
- Ensure that a bow wave does not form as you drive.
- Do not stop in the water and do not switch off the engine. Ensure the ECO start/stop function is switched off (→ page 143).

### Driving in mountainous terrain

Also observe the following information when driving in mountainous terrain:

- Observe the values of the approach/departure angle and of the maximum gradient (→ page 307).
- Avoid high engine speeds.
- Use the braking power of the engine when driving downhill.
- Shift to a lower gear on uphill gradients and on long, steep downhill gradients.
- Activate DSR before driving downhill, if necessary (→ page 173).

### Checklist after driving off-road

Driving off-road places greater demands on your vehicle than driving on normal roads. Check the entire vehicle for damage and foreign bodies every time after driving off-road. Foreign bodies in the wheels or drivetrain can lead to imbalances and therefore vibrations.

- If the  drive program is selected: select another drive program.
- Deactivate DSR.
- Apply the brakes to dry them after fording.

- Check that the service brake is working normally after a long downhill stretch.
- Clean the following components every time after driving off-road:
  - license plate number
  - headlamps and tail lamps
  - tires, wheels and wheel arches
  - underbody
- After driving through sand, mud, water or gravel, have the following components checked and cleaned:
  - brake discs and brakepads
  - tires and wheels
  - axle joints

### ECO start/stop function

#### Operation of the ECO start/stop function

**Mercedes-AMG vehicles:** observe the notes in the Supplement. You could otherwise fail to recognize dangers.

- The ECO start/stop function is available only in the **[S]**, **[C]**, **[E]** and **[I+]** drive programs (depending on the setting).

If all vehicle-related conditions for an automatic engine stop are met, the engine is switched off automatically:

- **Vehicles with automatic transmission:**  
You brake the vehicle to a standstill in transmission position **[D]** or **[N]**.
- You activate the HOLD function or engage transmission position **[P]**.
- If the system detects an intelligent stop inhibitor, e.g. a stop sign, the engine will not stop. When the HOLD function is active and in transmission position **[P]**, the engine can stop in spite of an intelligent stop inhibitor.

The engine is restarted automatically if:

- **Vehicles with automatic transmission:**  
You shift into transmission position **[D]** or **[R]**.
- You depress the accelerator pedal.
- An automatic engine start is required by the vehicle.

ECO start/stop function symbols in the multifunction display:

- The **[A]** symbol (green) appears when the vehicle is at a standstill: the engine was switched off by the ECO start/stop function.
- The **[A]** symbol (yellow) appears when the vehicle is at a standstill: not all vehicle conditions for an engine stop have been met.
- Neither the **[A]** nor **[A]** symbol appears when the vehicle is at a standstill: an intelligent stop inhibitor was detected, e.g. a stop sign.
- The **[A<sup>OFF</sup>]** symbol appears: the ECO start/stop function is deactivated or there is a malfunction.

If the engine was switched off by the ECO start/stop function and you leave the vehicle, a warning tone sounds and the engine is not restarted. In addition, the [Vehicle Ready to Drive Switch the Ignition Off Before Exiting](#) display message appears in the multifunction display. If you do not switch off the ignition, the ignition is automatically switched off after three minutes.



## Deactivating or activating the ECO start/stop function

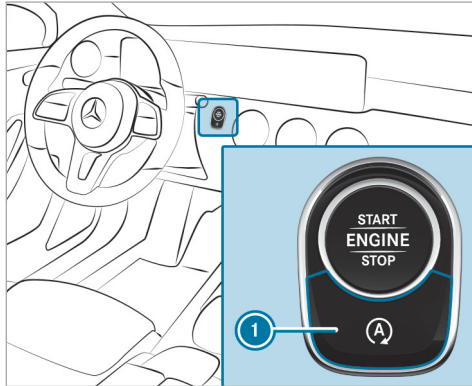

- ▶ Press button ①.  
A display appears in the instrument cluster when switching the ECO start/stop function off/on.
- ① A continuous  display appears in the instrument cluster while the ECO start/stop function is deactivated.

## ECO display function

The ECO display summarizes your driving characteristics from the start of the journey to its completion and assists you in achieving the most economical driving style.

You can influence consumption by doing the following:

- Drive with particular care
- **Vehicles with automatic transmission:**  
Drive in drive program .
- Follow the gearshift recommendations

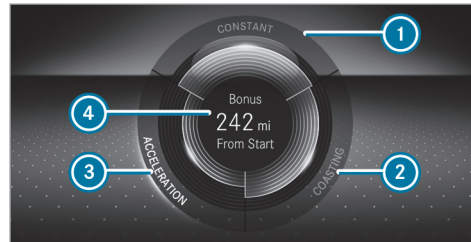

The lettering in the segment will light up brightly, the outer edge will light up and the segment will fill up when the following driving style is adopted:

- ① Steady speed
- ② Gentle deceleration and rolling
- ③ Moderate acceleration

The lettering in the segment will be gray, the outer edge will be dark and the segment will empty when the following driving style is adopted:

- ① Fluctuations in speed
- ② Heavy braking
- ③ Sporty acceleration

The ECO display will show you when you have driven economically:

- The three segments will fill up completely at the same time
- The edges around all three segments will light up

The additional range achieved as a result of your driving style in comparison with a driver with a very sporty driving style will be shown in the center of display ④. The range displayed does not indicate a fixed reduction in consumption.

### DYNAMIC SELECT switch

#### Function of the DYNAMIC SELECT switch

**Mercedes-AMG vehicles:** observe the notes in the Supplement. You could otherwise fail to recognize dangers.

① Depending on the engine and equipment, the vehicle has different drive programs.

Use the DYNAMIC SELECT switch to change between the following drive programs:

**I** (Individual): individual settings

**S** (Sport): sporty driving style

**C** (Comfort): comfortable and economical driving style

**E** (Eco): particularly economical driving style (vehicles with automatic transmission)



**(Offroad):** driving on less demanding off-road terrain

① The drive program selected appears in the multifunction display of the on-board computer.

Depending on the drive program, the following systems change their characteristics:

- Drive
  - Engine and transmission management
  - Active Distance Assist DISTRONIC
- ESP®
- **Vehicles with adaptive damping adjustment:** suspension
- Electric power steering

#### Notes on the roof load display

Certain drive programs and ESP® settings are unsuitable for transporting a roof load.

If one of these drive programs is set or selected,



the symbol is shown as a warning. When

this symbol is shown, the selected drive program is not suitable for transporting a load on the roof.

The following drive programs are affected:

- **Sport** drive program
- **Individual** drive program with the Sport ESP® setting

① The symbol is also shown in the following situations:

- Within the reset display if the previously active drive program is unsuitable for the transport of a roof load

For further information on the reset display, see (→ page 145).

#### Selecting the drive program

① Depending on the equipment, the vehicle is equipped with either a switch or a button.

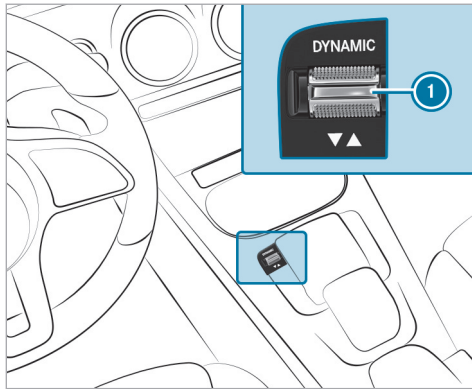

- ▶ Press DYNAMIC SELECT switch ① forwards or backwards. The drive program selected appears in the multifunction display.

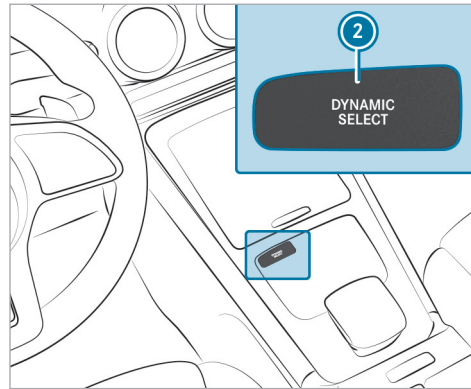

- ▶ Press DYNAMIC SELECT button ②. The DYNAMIC SELECT menu appears in the multifunction display.
- ▶ Press DYNAMIC SELECT button ② again. The chosen drive program appears.

## Configuring DYNAMIC SELECT (multimedia system)

Multimedia system:

- ▶ Settings ▶ Vehicle
- ▶ DYNAMIC SELECT

### Setting drive program I

- ▶ Select **Individual Configuration**.
- ▶ Select and set a category.

### Restoring settings

- ▶ Switch **Request at Start** on or off.

**Function on:** the next time the vehicle is started a prompt appears asking whether the last active drive program should be restored. If the ECO start/stop function was deactivated, an additional prompt appears asking if the function should remain deactivated.

- ① The prompt appears only if the previously active settings deviate from the standard settings.

**Function off:** the next time the vehicle is started the **Comfort** drive program is set automati-

cally. The ECO start/stop function is activated automatically.

## Automatic transmission

### DIRECT SELECT lever

#### Function of the DIRECT SELECT lever

**⚠ WARNING** Risk of accident due to incorrect gearshifting

If the engine speed is higher than the idle speed and you engage the transmission position **D** or **R**, the vehicle may accelerate sharply.

▶ If you engage the transmission position **D** or **R** when the vehicle is at a standstill, always depress the brake pedal firmly and do not accelerate at the same time.

**⚠ WARNING** Risk of accident and injury due to children left unattended in the vehicle

If children are left unsupervised in the vehicle, they could, in particular:

- Open doors, thereby endangering other persons or road users.
- Get out and be struck by oncoming traffic.
- Operate vehicle equipment and become trapped, for example.

In addition, the children could also set the vehicle in motion, for example by:

- Releasing the parking brake.
- Change the transmission position.
- Start the vehicle.

▶ Never leave children unattended in the vehicle.

▶ When leaving the vehicle, always take the SmartKey with you and lock the vehicle.

▶ Keep the SmartKey out of reach of children.

Use the DIRECT SELECT lever to switch the transmission position. The current transmission position is displayed in the multifunction display.

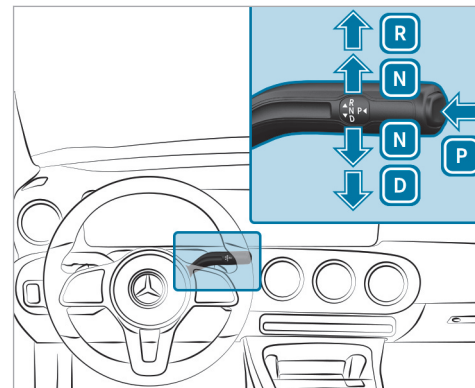

**P** Park position

**R** Reverse gear

- N** Neutral
- D** Drive position

### Engaging reverse gear R

- ▶ Depress the brake pedal and push the DIRECT SELECT lever upwards past the first point of resistance.

### Engaging neutral N

- ▶ Depress the brake pedal and push the DIRECT SELECT lever up or down to the first point of resistance.

Subsequently releasing the brake pedal will allow you to move the vehicle freely, e.g. to push it or tow it away.

**Proceed as follows if you want the automatic transmission to remain in neutral **N** even if the ignition is switched off or the driver's door is opened:**

- ▶ Start the vehicle.
- ▶ Depress the brake pedal and engage neutral **N** when the car is stationary.
- ▶ Release the brake pedal.
- ▶ Switch the ignition off.

- ⓘ If you then exit the vehicle leaving the SmartKey in the vehicle, the automatic transmission remains in neutral **N**.

### Engaging park position P

- ▶ Observe the notes on parking the vehicle (→ page 154).
- ▶ Depress the brake pedal until the vehicle is stationary.
- ▶ When the vehicle is stationary, press button **P**.  
When the transmission position display shows **P**, the park position is engaged. If no transmission position display **P** appears, secure the vehicle to prevent it from rolling away.
- ⓘ Depending on the situation, it may take a short time until **P** is engaged. Therefore, always pay attention to the transmission position display.

Park position **P** is engaged automatically if one of the following conditions is met:

- you switch off the ignition when the vehicle is stationary and the transmission is in position **D** or **R**.
- you open the driver's door when the vehicle is stationary or when driving at a very low speed and the transmission is in position **D** or **R**.
- ⓘ To maneuver with an open driver's door, open the driver's door while stationary and engage transmission position **D** or **R** again.
- ⓘ At very low outside temperatures below approx. -4 °F (-20 °C), you may not be able to shift the transmission from **P** to another transmission position when the engine is switched off. If this is the case, only change the transmission position while the engine is running.

### Engaging drive position D

- ▶ Depress the brake pedal and push the DIRECT SELECT lever down past the first point of resistance.

When the automatic transmission is in transmission position **D**, it shifts the gears automatically. This depends, among other things, on the following factors:

- The selected drive program
- The position of the accelerator pedal
- The driving speed

### Manual gearshifting

**Mercedes-AMG vehicles:** observe the notes in the Supplement. You could otherwise fail to recognize dangers.

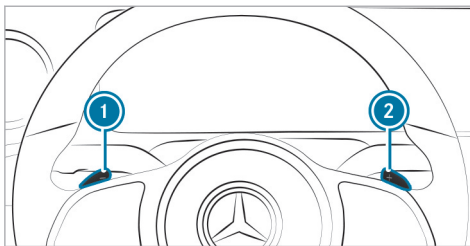

When the automatic transmission is shifted to position **D**, you can manually shift it with the steering wheel gearshift paddle. If permitted, the automatic transmission shifts to a higher or lower gear depending on the steering wheel gearshift paddle being pulled.

You have two options to manually shift the automatic transmission:

- Temporary setting
- Permanent setting

The gears shift automatically when manual gearshifting is deactivated.

#### Temporary setting:

- ▶ **To activate:** pull steering wheel gearshift paddle **1** or **2**. Manual gearshifting is activated for a short time. The transmission position display shows **M** and the current gear.

- ⓘ How long the manual gearshifting stays activated depends on various factors.

Manual gearshifting can be automatically deactivated in the following cases:

- Changing the drive program
- Restarting the vehicle
- When the transmission position **D** is engaged again
- Driving style

- ▶ **To shift up:** pull steering wheel gearshift paddle **2**.

- ▶ **To shift down:** pull steering wheel gearshift paddle **1**.

If you pull and hold the steering wheel gearshift paddle **1**, the transmission shifts to the lowest possible gear.

- ▶ **To deactivate:** pull steering wheel gearshift paddle ② and hold it in place. The transmission position display shows **D**.

#### Permanent setting:

- ▶ Change to drive program **I\*** (→ page 144).
- ▶ Select drive setting **M** (→ page 145).

#### Gearshift recommendation

**Mercedes-AMG vehicles:** observe the notes in the Supplement. You could otherwise fail to recognize dangers.

The gearshift recommendation assists you in adopting an economical driving style.

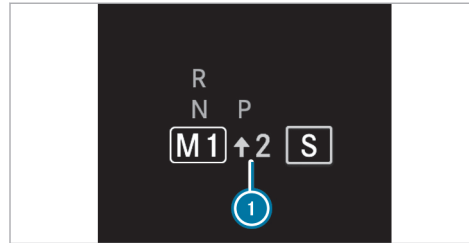

- ▶ If gearshift recommendation ① appears next to the transmission position display, shift to the recommended gear.

#### Using kickdown

**Mercedes-AMG vehicles:** observe the notes in the Supplement. You could otherwise fail to recognize dangers.

- ▶ **Maximum acceleration:** depress the accelerator pedal beyond the pressure point.

The automatic transmission shifts up to the next gear when the maximum engine speed is reached to protect the engine from overrevving.

#### Glide mode function

**Mercedes-AMG vehicles:** observe the notes in the Supplement. You could otherwise fail to recognize dangers.

With an anticipatory driving style, Glide mode helps you to reduce fuel consumption.

Glide mode is characterized by the following:

- The combustion engine is disconnected from the drivetrain and continues to run in neutral.
- The transmission position display **D** is shown in green.

Glide mode is activated if the following conditions are met:

- Drive program **E** is selected.
- The speed is within a suitable range.
- The road's course is suitable, e.g. no steep uphill or downhill inclines or tight curves.
- You do not depress the accelerator or brake pedal (except for light brake applications).

## 150 Driving and parking

---

- ① Glide mode can also be activated if you have selected the "Eco" setting for the drive in the drive program .

Glide mode is deactivated again if one of the conditions is no longer met.

### **Vehicles with Active Distance Assist**

**DISTRONIC:** when Active Distance Assist DISTRONIC is active, the glide mode function is not available.

Glide mode can also be prevented by the following parameters:

- Incline
  - Downhill gradient
  - Temperature
  - Height
  - Speed
  - Operating status of the engine
  - Traffic situation
- ① Glide mode can be ended by pressing a steering wheel gearshift paddle (→ page 148).



### Problems with the transmission

| Problem   | Possible causes/consequences and ► Solutions  |
|---|---|
| The transmission has a faulty gear shift.   | <p>The transmission is losing oil.</p> <ul style="list-style-type: none"> <li>► Have the transmission checked at a qualified specialist workshop immediately.</li> </ul>  |
| <p>The acceleration characteristics are deteriorating.</p> <p>The transmission no longer shifts gear.</p> | <p>The transmission is in emergency operation mode.</p> <ul style="list-style-type: none"> <li>► Stop the vehicle in accordance with the traffic conditions.</li> <li>► Switch the transmission to position <b>P</b>.</li> <li>► Switch off the engine.</li> <li>► Wait at least ten seconds before restarting the engine.</li> <li>► Switch the transmission to position <b>D</b>.</li> <li>► Have the transmission checked at a qualified specialist workshop immediately.</li> </ul> |

### Function of the 4MATIC

4MATIC ensures that all four wheels are driven. Together with ESP® and 4ETS, 4MATIC improves the traction of your vehicle whenever a driven wheel spins due to insufficient traction.

If you fail to adapt your driving style, 4MATIC can neither reduce the risk of an accident nor over-

ride the laws of physics. 4MATIC cannot take account of road, weather and traffic conditions. 4MATIC is only an aid. You are responsible especially for maintaining a safe distance from the vehicle in front, for vehicle speed, for braking in good time and for staying in lane.

**i** In wintry road conditions, the maximum effect of 4MATIC can be achieved only if you

use winter tires (M+S tires), with snow chains if necessary.

## Refueling

### Refueling the vehicle

**⚠ WARNING** Risk of fire or explosion from fuel

Fuels are highly flammable.

- ▶ Fire, open flames, smoking and creation of sparks must be avoided.
- ▶ Switch off the ignition and, if available, the stationary heater, before and while refueling the vehicle.

**⚠ WARNING** Risk of injury from fuels

Fuels are poisonous and hazardous to your health.

- ▶ Do not swallow fuel or let it come into contact with skin, eyes or clothing.
- ▶ Do not inhale fuel vapor.
- ▶ Keep children away from fuel.
- ▶ Keep doors and windows closed during the refueling process.

If you or other people come into contact with fuel, observe the following:

- ▶ Immediately rinse fuel off your skin with soap and water.
- ▶ If fuel comes into contact with your eyes, immediately rinse them thoroughly with clean water. Seek medical attention immediately.
- ▶ If you swallow fuel, seek medical attention immediately. Do not induce vomiting.
- ▶ Change immediately out of clothing that has come into contact with fuel.

**⚠ WARNING** Risk of fire and explosion due to electrostatic charge

Electrostatic charge can ignite fuel vapor.

- ▶ Before you open the fuel filler cap or take hold of the pump nozzle, touch the metallic vehicle body.

- ▶ To avoid creating another electrostatic charge, do not get into the vehicle again during the refueling process.

**! NOTE** Damage caused by the wrong fuel

Vehicles with a gasoline engine:

Even small amounts of the wrong fuel could result in damage to the fuel system, the engine and the emission control system.

- ▶ Only refuel with low-sulfur unleaded fuel.

This fuel may contain up to 10% ethanol. Your vehicle is suitable for use with E10 fuel.

Never refuel with one of the following fuels:

- Diesel
- Gasoline with more than 10% ethanol by volume, e.g. E15, E85, E100
- Gasoline with more than 3% methanol by volume, e.g. M15, M30, M85, M100
- Gasoline with additives containing metal

If you have accidentally refueled with the wrong fuel:

- ▶ Do not switch the ignition on.
- ▶ Consult a qualified specialist workshop.

**!** **NOTE** Do not use diesel to refuel vehicles with a gasoline engine

If you have accidentally refueled with the wrong fuel:

- Do not switch the ignition on. Otherwise fuel can enter the engine. Even small amounts of the wrong fuel could result in damage to the fuel system and the engine. The repair costs are high.
- ▶ Consult a qualified specialist workshop.
- ▶ Have the fuel tank and fuel lines drained completely.

**!** **NOTE** Damage to the fuel system caused by overfilled fuel tanks

- ▶ Only fill the fuel tank until the pump nozzle switches off.

If you have added too much fuel because of a defective filling pump, for instance:

- ▶ Do not switch the ignition on.
- ▶ Consult a qualified specialist workshop.

**!** **NOTE** Fuel may spray out when you remove the fuel pump nozzle

- ▶ Only fill the fuel tank until the pump nozzle switches off.

#### Requirements:

- The vehicle is unlocked.
- i** Do not get into the vehicle again during the refueling process. Otherwise, electrostatic charge could build up again.

Observe the notes on operating fluids and fuel.

Only refuel with fuel that has at least the octane number specified in the information label in the fuel filler flap. Otherwise, engine output can be reduced and fuel consumption increased.

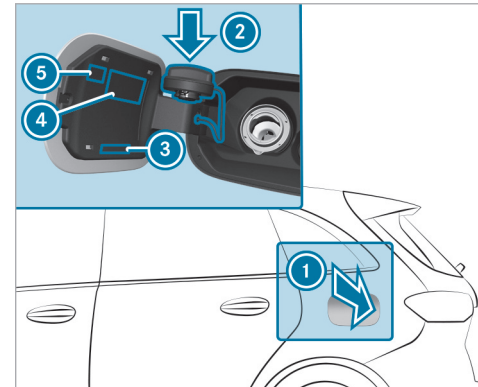

- 1** Fuel filler flap
- 2** Bracket for fuel filler cap
- 3** Fuel type

- ④ Tire pressure table
- ⑤ QR code for rescue card
- ▶ Press on the back area of fuel filler flap ①.
- ▶ Turn the fuel filler cap counter-clockwise and remove it.
- ▶ Insert the fuel filler cap from above into bracket ②.
- ▶ Completely insert the pump nozzle into the tank filler neck, hook in place and refuel.
- ▶ Only fill the fuel tank until the pump nozzle switches off.
- ▶ Replace the cap on the filler neck and turn clockwise until it engages audibly.
- ▶ Close fuel filler flap ①.
- ① Close the fuel filler flap before locking the vehicle.

## Parking

### Parking the vehicle

**⚠ WARNING** Risk of accident and injury caused by an insufficiently secured vehicle rolling away

If the vehicle is not securely parked sufficiently, it can roll away in an uncontrolled way even at a slight downhill gradient.

- ▶ On uphill or downhill gradients, turn the front wheels so that the vehicle rolls towards the curb if it starts moving.
- ▶ Apply the parking brake.
- ▶ Switch the transmission to position **P**.

**⚠ WARNING** Risk of fire caused by hot exhaust system parts

Flammable materials such as leaves, grass or twigs may ignite.

- ▶ Park the vehicle so that no flammable material can come into contact with hot vehicle components.

- ▶ In particular, do not park on dry grass-land or harvested grain fields.

**⚠ WARNING** Risk of accident and injury due to children left unattended in the vehicle

If children are left unsupervised in the vehicle, they could, in particular:

- Open doors, thereby endangering other persons or road users.
- Get out and be struck by oncoming traffic.
- Operate vehicle equipment and become trapped, for example.

In addition, the children could also set the vehicle in motion, for example by:

- Releasing the parking brake.
- Change the transmission position.
- Start the vehicle.
- ▶ Never leave children unattended in the vehicle.

- ▶ When leaving the vehicle, always take the SmartKey with you and lock the vehicle.
- ▶ Keep the SmartKey out of reach of children.

**!** **NOTE** Damage to the vehicle due to it rolling away

- ▶ Always secure the vehicle against rolling away.

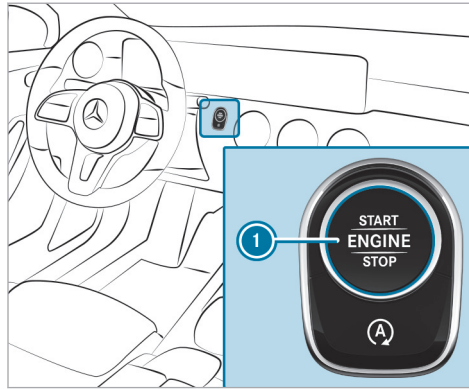

- ▶ Bring the vehicle to a standstill by applying the brake pedal.
- ▶ On gradients, turn the front wheels so that the vehicle will roll towards the curb if it starts moving.
- ▶ Apply the electric parking brake.
- ▶ **Vehicles with automatic transmission:** Engage transmission position **P** in a station-

ary vehicle with the brake pedal applied (→ page 147).

- ▶ Switch off the engine and the ignition by pressing button **1**.
  - ▶ Release the service brake slowly.
  - ▶ Get out of the vehicle and lock it.
- i** When you park the vehicle, you can still operate the side windows and the panorama roof with power tilt/sliding panel for approximately five minutes if the driver's door is closed.

### Garage door opener

#### Programming buttons for the garage door opener

**!** **DANGER** Risk of death caused by exhaust gases

Combustion engines emit poisonous exhaust gases such as carbon monoxide. Inhaling these exhaust gases is hazardous to health and leads to poisoning.

- ▶ Never leave the engine or, if present, the auxiliary heating running in an enclosed space without sufficient ventilation.

**⚠ WARNING** Risk of injury when opening or closing a door with the garage door opener

When you operate or program the door with the integrated garage door opener, persons in the range of movement of the door may become trapped or be struck by the door.

- ▶ Always make sure that nobody is within the range of movement of the door.

Only operate the following doors using the garage door opener:

- Doors with a safety stop and reversing feature
- Doors which conform to the current U.S. safety standards

**Requirements:**

- The vehicle has been parked outside the garage or outside the range of movement of the door.
  - The engine is switched off.
  - The ignition is switched on.
- i** The garage door opener function is always available when the ignition is switched on.

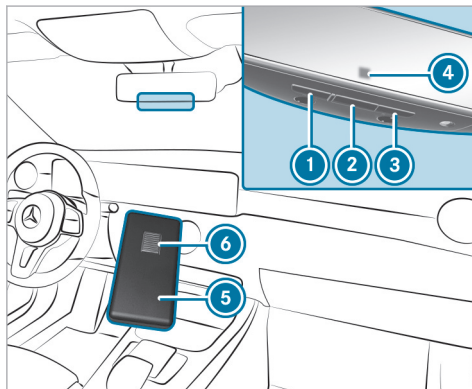

- ▶ Check if the transmitter frequency of the remote control has the frequency range of 280 to 868 MHz.

Radio equipment approval number:

- NZLMUAHL5 (USA)
- 4112A-MUAHL5 (Canada)

- ▶ Press and hold button ①, ② or ③ that you wish to program. Indicator lamp ④ flashes yellow.

- i** It can take up to 20 seconds before the indicator lamp flashes yellow.

- ▶ Release the previously pressed button. Indicator lamp ④ continues to flash yellow.

- ▶ Point remote control ⑤ from a distance of 0.4 in (1 cm) to 3 in (8 cm) towards button ①, ② or ③.

- ▶ Press and hold button ⑥ of remote control ⑤ until one of the following signals appears:

- Indicator lamp ④ lights up green continuously. Programming is complete.
- Indicator lamp ④ flashes green. Programming was successful. Additionally,

synchronization of the rolling code with the door system must also be carried out.

- ▶ If indicator lamp ④ does not light up or flash green: repeat the procedure.
- ▶ Release all of the buttons.
- ⓘ The remote control for the door drive is not included in the scope of delivery of the garage door opener.

#### Synchronizing the rolling code Requirements:

- The door system uses a rolling code.
- The vehicle must be within range of the garage door or door drive.
- The vehicle as well as persons and objects are located outside the range of movement of the door.
- ▶ Press the programming button on the door drive unit.  
Initiate the next step within approximately 30 seconds.

- ▶ Press previously programmed button ①, ② or ③ repeatedly until the door closes. When the door closes, programming is completed.
- ⓘ Please also read the operating instructions for the door drive.

#### Troubleshooting when programming the remote control

- ▶ Check if the transmitter frequency of remote control ⑤ is supported.
- ▶ Replace the batteries in remote control ⑤.
- ▶ Hold remote control ⑤ at various angles from a distance of 0.4 in (1 cm) to 3 in (8 cm) front of the inside rearview mirror. You should test every position for at least 25 seconds before trying another position.
- ▶ Hold remote control ⑤ at the same angles at various distances in front of the inside rearview mirror. You should test every position for at least 25 seconds before trying another position.
- ▶ Note that some remote controls transmit only for a limited period, press button ⑥ on

remote control ⑤ again before transmission ends.

- ▶ Align the antenna line of the door opener unit with the remote control.
- ⓘ Support and additional information on programming:
  - On the toll free HomeLink® Hotline on 1-800-355-3515
  - On the Internet at <https://www.homelink.com/mercedes>

#### Opening or closing the garage door Requirements:

- The corresponding button is programmed to operate the door.
- ▶ Press and hold buttons ①, ② or ③ until the door opens or closes.
- ▶ If indicator lamp ④ flashes yellow after approximately 20 seconds: press and hold the previously pressed button again until the door opens or closes.

### Clearing the garage door opener memory

- ▶ Press and hold buttons ① and ③.  
Indicator lamp ④ lights up yellow.
- ▶ If indicator lamp ④ flashes green: release buttons ① and ③.  
The entire memory has been deleted.

### Electric parking brake

#### Electric parking brake function (applying automatically)

**⚠ WARNING** Risk of accident and injury due to children left unattended in the vehicle

If children are left unsupervised in the vehicle, they could, in particular:

- Open doors, thereby endangering other persons or road users.
- Get out and be struck by oncoming traffic.
- Operate vehicle equipment and become trapped, for example.

In addition, the children could also set the vehicle in motion, for example by:

- Releasing the parking brake.
  - Change the transmission position.
  - Start the vehicle.
- ▶ Never leave children unattended in the vehicle.
  - ▶ When leaving the vehicle, always take the SmartKey with you and lock the vehicle.
  - ▶ Keep the SmartKey out of reach of children.

The electric parking brake is applied if the transmission is in position **P** and one of the following conditions is fulfilled:

- The engine is switched off.
  - The seat belt tongue is not inserted in the seat belt buckle of the driver's seat and the driver's door is opened.
- i** To prevent application: pull the handle of the electric parking brake.

In the following situations, the electric parking brake is also applied:

- Active Distance Assist DISTRONIC is bringing the vehicle to a standstill.
- The HOLD function is keeping the vehicle stationary.
- Active Parking Assist is keeping the vehicle stationary.

This is the case if one of the following conditions is also fulfilled:

- The engine is switched off.
- The seat belt tongue is not inserted in the seat belt buckle of the driver's seat and the driver's door is opened.
- There is a system malfunction.
- The power supply is insufficient.
- The vehicle is stationary for a lengthy period.

When the electric parking brake is applied, the red **PARK** (USA) or **(P)** (Canada) indicator lamp appears in the instrument cluster.



The electric parking brake is not automatically applied if the engine is switched off by the ECO start/stop function.

### Electric parking brake function (releasing automatically)

The electric parking brake is released when the following conditions are fulfilled:

- The driver's door is closed.
- The engine is running.
- **Vehicles with automatic transmission:**  
The transmission is in position **D** or **R** and you depress the accelerator pedal or you shift from transmission position **P** to **D** or **R** when on level ground with the driver's door closed.
- If the transmission is in position **R**, the tailgate must be closed.
- The seat belt tongue is inserted into the seat belt buckle of the driver's seat.

Vehicles with automatic transmission: if the seat belt tongue is not inserted into the seat belt buckle of the driver's seat, one of the following conditions must be fulfilled:

- You shift from transmission position **P**.
- You have previously driven at speeds greater than 2 mph (3 km/h).

When the electric parking brake is released, the red **PARK** (USA) or **(P)** (Canada) indicator lamp in the instrument cluster goes out.

### Applying/releasing the electric parking brake manually

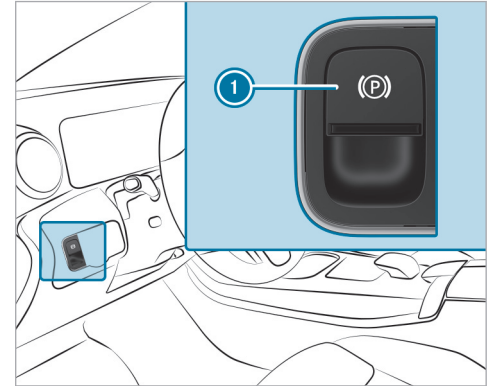

#### Applying





- ▶ Push handle **1**.  
The red **PARK** (USA) or **(P)** (Canada) indicator lamp appears in the instrument cluster.

- ① The electric parking brake is only securely applied if the indicator lamp is lit continuously.

### Releasing

- ▶ Switch on the ignition.
- ▶ Pull handle ①.  
The red  (USA) or  (Canada) indicator lamp in the instrument cluster goes out.

### Emergency braking

- ▶ Press and hold handle ①.  
As long as the vehicle is driving, the [Please Release Parking Brake](#) message is displayed. When the vehicle has been braked to a standstill, the electric parking brake is applied. The red  (USA) or  (Canada) indicator lamp appears in the instrument cluster.

### Information on collision detection on a parked vehicle

If a collision is detected when the tow-away alarm is armed on a locked vehicle, you will

receive a notification in the multimedia system when you switch on the ignition.

You will receive information about the following points:

- The area of the vehicle that may have been damaged.
- The force of the impact.

The following situations can lead to inadvertent activation:

- The parked vehicle is moved, e.g. in a two-story garage.
- ① Deactivate the tow-away alarm in order to prevent inadvertent activation. If you deactivate the tow-away alarm, collision detection will also be deactivated.
- ① If the battery is severely discharged, the function for detecting a collision on a parked vehicle is automatically deactivated to facilitate the next engine start.

### System limits

Detection may be restricted in the following situations:

- The vehicle is damaged without impact, e.g. if an outside mirror is torn off or the paint is damaged by a key
- An impact occurs at low speed
- The electric parking brake is not applied

### Notes on parking the vehicle for an extended period

If you leave the vehicle parked for longer than six weeks, it may suffer damage through disuse.

The 12 V battery may also be impaired or damaged by heavy discharging.

- ① Further information can be obtained at a qualified specialist workshop.

### Standby mode (extension of the starter battery's period out of use)

#### Standby mode function

**i** This function is not available for all models.

If standby mode is activated, energy loss will be minimised during extended periods of non-operation.

Standby mode is characterised by the following:

- The starter battery is preserved.
- The maximum non-operational time appears in the media display.
- The connection to online services is interrupted.
- The ATA (anti-theft alarm system) is not available.
- The interior motion sensor and tow-away alarm functions are not available.
- The function for detecting collisions on a parked vehicle is not available.

If the following conditions are fulfilled, standby mode can be activated or deactivated using the multimedia system:

- The engine is switched off.
- The ignition is switched on.

Exceeding the vehicle's displayed non-operational time may cause inconvenience, i.e. it cannot be guaranteed that the starter battery will reliably start the engine.

The starter battery must be charged first in the following situations:

- The vehicle's non-operational time must be extended.
- The **Battery Charge Insufficient for Standby Mode** message appears in the media display.

**i** Standby mode is automatically deactivated when the ignition is switched on.

#### Activating/deactivating standby mode (parking the vehicle for an extended period) Requirements:

- The engine is switched off.

Multimedia system:

 Settings ▶ Vehicle

- ▶ Activate or deactivate **Standby Mode**.
- ▶ Select **Yes**.

### Driving and driving safety systems

#### Driving systems and your responsibility

Your vehicle is equipped with driving systems which assist you in driving, parking and maneuvering the vehicle. The driving systems are only aids. They are not a substitute for your attention to the surroundings and do not relieve you of your responsibility pertaining to road traffic law. The driver is always responsible for maintaining a safe distance to the vehicle in front, for vehicle speed, for braking in good time and for staying in lane. Pay attention to the traffic conditions at all times and intervene when necessary. Be aware of the limitations regarding the safe use of these systems.

Driving systems can neither reduce the risk of accident if you fail to adapt your driving style nor override the laws of physics. They cannot always

## 162 Driving and parking

take into account road, weather or traffic conditions.

### Information on vehicle sensors and cameras

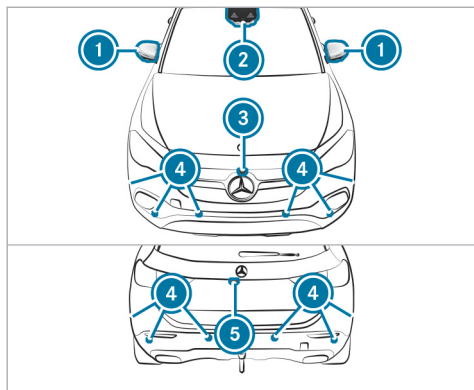

- ① Cameras in the outside mirrors
- ② Multifunction camera

- ③ Front camera
- ④ Ultrasonic sensors
- ⑤ Rear view camera

ⓘ Depending on the vehicle's equipment, the radar sensors are integrated behind the bumpers and/or behind the radiator grill.

Some driving and driving safety systems use cameras as well as radar or ultrasonic sensors to monitor the area in front of, behind or next to the vehicle.

Keep the areas around the sensors and cameras free of dirt, ice or slush (→ page 239). The cameras and sensors must not be covered, for example by bicycle racks, overhanging loads, stickers, foil or foils to protect against stone chipping. Additional license plate brackets can impair the function of the ultrasonic sensors, in particular.

In the event of damage or a severe impact in the area of the sensors, have the function of the sensors checked at a qualified specialist workshop. Have damage or stone chipping in the area of the cameras repaired at a qualified specialist

workshop. If the sensors or cameras are damaged, some driving systems and driving safety systems may no longer function properly.

### Overview of driving systems and driving safety systems

- ABS (**A**nti-**l**ock **B**raking **S**ystem) (→ page 163)
- Off-road ABS (→ page 163)
- BAS (**B**rake **A**ssist **S**ystem) (→ page 163)
- ESP<sup>®</sup> (**E**lectronic **S**tability **P**rogram) (→ page 164)
- ESP<sup>®</sup> Crosswind Assist (→ page 166)
- EBD (**E**lectronic **B**rake**f**orce **D**istribution) (→ page 166)
- STEER CONTROL (→ page 166)
- Active Brake Assist (→ page 166)<sup>1</sup>
- Cruise control (→ page 171)
- Active Distance Assist DISTRONIC (→ page 174)<sup>1</sup>

<sup>1</sup> This function includes subfunctions which are only available in conjunction with the Driving Assistance Package.

- Active Speed Limit Assist (→ page 178)<sup>2</sup>
- Active Steering Assist (→ page 179)<sup>2</sup>
- Active Emergency Stop Assist (→ page 181)<sup>2</sup>
- Hill Start Assist (→ page 182)
- HOLD function (→ page 182)
- Start-off assist (→ page 183)
- Parking Assist PARKTRONIC (→ page 184)
- Rear view camera (→ page 189)
- Surround view camera (→ page 191)
- Active Parking Assist (→ page 194)
- ATTENTION ASSIST (→ page 199)
- Blind Spot Assist and Active Blind Spot Assist with exit warning (→ page 201)<sup>1</sup>
- Active Lane Keeping Assist (→ page 203)<sup>3</sup>

### Function of ABS

The Anti-lock Brake System (ABS) regulates the brake pressure in critical driving situations:

- During braking, e.g. at full brake application or insufficient tire traction, the wheels are prevented from locking.
- Vehicle steerability while braking is ensured.

If ABS intervenes when braking, you will feel a pulsing in the brake pedal. The pulsating brake pedal can be an indication of hazardous road conditions and can serve as a reminder to take extra care while driving.

### Functions of Off-road ABS

- ① Off-road ABS is activated automatically when you select the  drive program.

Off-road ABS is specially adapted for driving off-road:

- The front wheels lock cyclically during braking.
- The braking distance is shortened due to the digging-in effect.

### System limits

- Off-road ABS functions at speeds below 25 mph (40 km/h).
- If Off-road ABS intervenes, the ability to steer may be restricted.

### Function of BAS

The Brake Assist System (BAS) supports your emergency braking situation with additional brake force.

<sup>2</sup> This function is country-dependent and only available in conjunction with the Driving Assistance Package.

<sup>1</sup> This function includes subfunctions which are only available in conjunction with the Driving Assistance Package.

<sup>3</sup> This function includes subfunctions which are only available in conjunction with the Driving Assistance Package or only available depending on the country.

## 164 Driving and parking

If you depress the brake pedal quickly, BAS is activated:

- BAS automatically boosts the brake pressure.
- BAS can shorten the braking distance.
- ABS prevents the wheels from locking.

The brakes will function as usual once you release the brake pedal. BAS is deactivated.

### Functions of ESP®

**⚠ WARNING** Risk of skidding if ESP® is deactivated

If you deactivate ESP®, ESP® cannot carry out vehicle stabilization.

- ▶ ESP® should only be deactivated in the following situations.

**Mercedes-AMG vehicles:** observe the notes in the Supplement. You could otherwise fail to recognize dangers.

The Electronic Stability Program (ESP®) can monitor and improve driving stability and traction in the following situations within physical limits:

- When pulling away on a wet or slippery road.
- When braking.

If the vehicle deviates from the direction desired by the driver, ESP® can stabilize the vehicle by intervening in the following ways:

- One or more wheels are braked.
- The engine output is adapted according to the situation.

ESP® is deactivated if the  ESP® OFF warning lamp lights up continuously in the instrument cluster:

- Driving stability will no longer be improved.
- The drive wheels could spin.
- ETS/4ETS traction control is still active.

- ⓘ When ESP® is deactivated, you are still assisted by ESP® when braking.

If the  ESP® warning lamp flashes in the instrument cluster, one or several vehicle wheels has reached its grip limit:

- Adapt your driving style to suit the current road and weather conditions.
- Do not deactivate ESP®.
- Only depress the accelerator pedal as far as is necessary when pulling away.

It can be advantageous to deactivate ESP® in the following situations to improve traction:

- When using snow chains.
- In deep snow.
- On sand or gravel.

- ⓘ Spinning the wheels results in a cutting action, which enhances traction.

If the  ESP® warning lamp lights up continuously, ESP® is not available due to a malfunction.

Observe the following information:

- Indicator and warning lamps (→ page 356)
- Display messages (→ page 309)

**ETS/4ETS (Electronic Traction System)**

ETS/4ETS traction control is part of ESP® and makes it possible to pull away and accelerate on a slippery road.

If you select the  drive program, a special ETS system specifically suited to off-road terrain is automatically activated.

ETS/4ETS can improve the vehicle's traction by intervening in the following ways:

- The drive wheels are braked individually if they spin.
- More drive torque is transferred to the wheel or wheels with traction.

**ESP® modes**

Depending on the selected drive program, the appropriate ESP® mode will be activated automatically. ESP® adapts to different weather and road conditions as well as the driver's preferred driving style. You can select the drive programs using the DYNAMIC SELECT switch (→ page 144).

**ESP® Comfort**

- active in drive programs  and 

- balance between traction and stability
- recommended for all road surface conditions
- suitable for both dry and difficult road conditions, such as snow or ice, or when the road is wet from rain

**ESP® Sport**

- active in drive program 
- continues to offer stability but with a sporty setup
- allows the sporty driver a more active driving style
- only suitable for good road conditions, a dry road surface and a clear stretch of road

**Off-road ESP®**

- active in drive program 
- intervenes later if there is oversteering or understeering, thus improving traction
- suitable for easily negotiable off-road terrain such as dirt tracks, gravel or sandy surfaces

**Activating/deactivating ESP® (Electronic Stability Program)**

Multimedia system:

  **» Settings » Quick Access**

**Mercedes-AMG vehicles:** observe the notes in the Supplement. You could otherwise fail to recognize dangers.

 Select **ESP**.

 Select **On** or  **Off**.

ESP® is deactivated if the  ESP® OFF warning lamp lights up continuously in the instrument cluster.

Observe the information on warning lamps and display messages which may be shown in the instrument cluster.

 Alternatively, you can also activate or deactivate ESP® in the **Assistance** menu.

### Function of ESP® Crosswind Assist

ESP® Crosswind Assist detects sudden gusts of side wind and helps the driver to keep the vehicle in the lane:

- ESP® Crosswind Assist is active at vehicle speeds between approx. 47 mph (75 km/h) and 125 mph (200 km/h) when driving straight ahead or cornering slightly.
- The vehicle is stabilized by means of individual brake application on one side.

### Function of EBD

Electronic Breakforce Distribution (EBD) is characterized by the following:

- Monitoring and regulating the brake pressure on the rear wheels.
- Improved driving stability when braking, especially on bends.

### Function of STEER CONTROL

STEER CONTROL helps you by transmitting a noticeable steering force to the steering wheel in the direction required for vehicle stabilization.

This steering recommendation is given particularly in the following situations:

- Both right wheels or both left wheels are on a wet or slippery road surface when you brake.
- The vehicle starts to skid.

#### System limits

STEER CONTROL may be impaired or may not function in the following situations:

- ESP® is deactivated.
- ESP® is malfunctioning.
- The steering is malfunctioning.

If ESP® is malfunctioning, you will be assisted further by the electric power steering.

### Function of Active Brake Assist

Active Brake Assist consists of the following functions:

- Distance warning function
- Autonomous braking function
- Situation-dependent braking assistance
- **Vehicles with Driving Assistance Package:** Evasive Steering Assist and cornering function

Active Brake Assist can help you to minimise the risk of a collision with vehicles, cyclists or pedestrians, or reduce the effects of such a collision.

If Active Brake Assist has detected a risk of collision, a warning tone sounds and the  distance warning lamp lights up in the instrument cluster.

**Vehicles with PRE-SAFE®:** depending on the country, an additional haptic warning occurs in the form of slight, repeated tensioning of the seat belt.



If you do not react to the warning, autonomous braking can be initiated in critical situations.

In especially critical situations, Active Brake Assist can initiate autonomous braking directly. In this case, the warning lamp and warning tone occur simultaneously with the braking application.

If you apply the brake yourself in a critical situation or apply the brake during autonomous braking, situation-dependent braking assistance occurs. The brake pressure increases up to maximum full-stop braking if necessary.

Observe the notes on driving systems and your responsibility; you may otherwise fail to recognize dangers (→ page 161).



If autonomous braking or situation-dependent braking assistance has occurred, display ❶ appears in the multifunction display and then automatically goes out after a short time.

If the autonomous braking function or the situation-dependent braking assistance is triggered, additional preventive measures for occupant protection (PRE-SAFE®) may also be initiated.

**⚠ WARNING** Risk of an accident caused by limited detection performance of Active Brake Assist

Active Brake Assist cannot always clearly identify objects and complex traffic situations.

- ▶ Always pay careful attention to the traffic situation; do not rely on Active Brake Assist alone. Active Brake Assist is only an aid. The driver is responsible for maintaining a sufficiently safe distance to the vehicle in front, vehicle speed and for braking in good time.
- ▶ Be prepared to brake or swerve if necessary.

Also observe the system limits of Active Brake Assist.

**The individual subfunctions are available in various speed ranges:**

The distance warning function can issue a warning in the following situations:

- From approximately 4 mph (7 km/h), if your vehicle is critically close to a vehicle, cyclist or pedestrian, you will hear an intermittent warning tone and the  distance warning lamp lights up in the instrument cluster.

**Vehicles with PRE-SAFE®:** depending on the country, an additional haptic warning occurs in the form of slight, repeated tensioning of the seat belt.

Brake immediately or take evasive action, provided it is safe to do so and the traffic situation allows this.

**Distance warning function (vehicles without Driving Assistance Package)**

The distance warning function can aid you in the following situations with an intermittent warning tone and a warning lamp:

- at speeds up to approximately 155 mph (250 km/h) when approaching vehicles ahead
- at speeds up to approximately 50 mph (80 km/h) when approaching stationary vehicles, moving pedestrians and cyclists ahead
- at speeds up to approximately 37 mph (60 km/h) when approaching crossing cyclists

**Distance warning function (vehicles with Driving Assistance Package)**

The distance warning function can aid you in the following situations with an intermittent warning tone and a warning lamp:

- at speeds up to approximately 155 mph (250 km/h) when approaching vehicles ahead

- at speeds up to approximately 62 mph (100 km/h) when approaching stationary vehicles
- at speeds up to approximately 50 mph (80 km/h) when approaching moving pedestrians and cyclists ahead
- at speeds up to approximately 43 mph (70 km/h) when approaching stationary pedestrians, crossing vehicles and stationary and crossing cyclists

**Autonomous braking function (vehicles without Driving Assistance Package)**

If the vehicle is traveling at speeds above approximately 4 mph (7 km/h), the autonomous braking function may intervene in the following situations:

- at speeds up to approximately 124 mph (200 km/h) when approaching vehicles ahead
- at speeds up to approximately 50 mph (80 km/h) when approaching cyclists ahead

- at speeds up to approximately 37 mph (60 km/h) when approaching moving pedestrians and crossing cyclists
- at speeds up to approximately 31 mph (50 km/h) when approaching stationary vehicles

#### **Autonomous braking function (vehicles with Driving Assistance Package)**

If the vehicle is traveling at speeds above approximately 4 mph (7 km/h), the autonomous braking function may intervene in the following situations:

- at speeds up to approximately 155 mph (250 km/h) when approaching vehicles ahead
- at speeds up to approximately 62 mph (100 km/h) when approaching stationary vehicles
- at speeds up to approximately 50 mph (80 km/h) when approaching cyclists ahead
- at speeds up to approximately 43 mph (70 km/h) when approaching stationary and

moving pedestrians, crossing vehicles and stationary and crossing cyclists

#### **Situation-dependent braking assistance (vehicles without Driving Assistance Package)**

The situation-dependent braking assistance can intervene from a speed of approximately 4 mph (7 km/h) in the following situations:

- at speeds up to approximately 155 mph (250 km/h) when approaching vehicles ahead
- at speeds up to approximately 50 mph (80 km/h) when approaching stationary vehicles and vehicles ahead
- at speeds up to approximately 37 mph (60 km/h) when approaching moving pedestrians and crossing cyclists

#### **Situation-dependent braking assistance (vehicles with Driving Assistance Package)**

The situation-dependent braking assistance can intervene from a speed of approximately 4 mph (7 km/h) in the following situations:

- at speeds up to approximately 155 mph (250 km/h) when approaching vehicles ahead
- at speeds up to approximately 62 mph (100 km/h) when approaching stationary vehicles
- at speeds up to approximately 50 mph (80 km/h) when approaching cyclists ahead
- at speeds up to approximately 37 mph (60 km/h) when approaching stationary and moving pedestrians, crossing vehicles and stationary and crossing cyclists

#### **Canceling a brake application of Active Brake Assist**

You can cancel a brake application of Active Brake Assist at any time by:

- Activating kickdown.
- Releasing the brake pedal.

## 170 Driving and parking

Active Brake Assist may cancel the brake application when one of the following conditions is fulfilled:

- You maneuver to avoid the obstacle.
- There is no longer a risk of collision.
- An obstacle is no longer detected in front of your vehicle.

### **Evasive Steering Assist (only vehicles with Driving Assistance Package)**

Evasive Steering Assist has the following characteristics:

- The ability to detect stationary or moving pedestrians.
- Assistance through power-assisted steering if it detects a swerving maneuver.
- Activation by an abrupt steering movement during a swerving maneuver.
- Assistance during swerving and straightening of the vehicle.
- Reaction from a speed of approximately 12 mph (20 km/h) up to a speed of approximately 43 mph (70 km/h).

You can prevent the assistance at any time by actively steering.

### **Cornering function (only vehicles with Driving Assistance Package)**

If a danger of collision from an oncoming vehicle is detected when turning across an oncoming lane, autonomous braking can be initiated at speeds below 9 mph (15 km/h) before you have left the lane in which you are driving.

#### **⚠ WARNING Risk of accident despite Evasive Steering Assist**

Evasive Steering Assist cannot always recognize objects or complex traffic situations clearly.

Moreover, the steering support provided by Evasive Steering Assist is not sufficient to avoid a collision.

- ▶ Always pay careful attention to the traffic situation; do not rely on Evasive Steering Assist alone.
- ▶ Be prepared to brake or swerve if necessary.

- ▶ End the support by actively steering in non-critical situations.
- ▶ Drive at an appropriate speed if there are pedestrians close to the path of your vehicle.

### **System limits**

Full system performance is not available for a few seconds after switching on the ignition or after driving off.

The system may be impaired or may not function in the following situations:

- In snow, rain, fog, heavy spray, if there is glare, in direct sunlight or in greatly varying ambient light.
- If the sensors are dirty, fogged up, damaged or covered.
- If the sensors are impaired due to interference from other radar sources, e.g. strong radar reflections in parking garages.
- If a loss of tire pressure or a faulty tire has been detected and displayed.
- If DSR is active.

- In complex traffic situations where objects cannot always be clearly identified.
  - If pedestrians or vehicles move quickly into the sensor detection range.
  - If pedestrians are hidden by other objects.
  - If the typical outline of a pedestrian cannot be distinguished from the background.
  - If a pedestrian is not detected as such, e.g. due to special clothing or other objects.
  - On curves with a tight radius.
- i** The Active Brake Assist sensors adjust automatically while a certain distance is being driven after the vehicle has been delivered. Active Brake Assist is unavailable or only partially available during this teach-in period.

### Setting Active Brake Assist

#### Requirements:

- The ignition is switched on.

Multimedia system:

  **» Settings » Assistance**  
**» Active Brake Assist**

- ▶ Select the desired setting.  
The setting is retained when the engine is next started.

#### Deactivating Active Brake Assist

- i** It is recommended that you always leave Active Brake Assist activated.
- ▶ Select **Off**.  
The distance warning function, the autonomous braking function and the Evasive Steering Assist are deactivated.  
When the vehicle is next started, the middle setting is automatically selected.
- i** If Active Brake Assist is deactivated, the  symbol appears in the status bar of the multifunction display.

### Speed control cruise control

#### Function of cruise control

Cruise control regulates the speed to the value selected by the driver.



If you accelerate to overtake, for example, the stored speed is not deleted. If you remove your foot from the accelerator pedal after overtaking, cruise control will resume speed regulation back to the stored speed.

Cruise control is operated using the corresponding steering wheel buttons. You can store any speed above 15 mph (20 km/h) up to the maximum design speed.

Observe the notes on driving systems and your responsibility; you may otherwise fail to recognize dangers (→ page 161).

**Mercedes-AMG vehicles:** Cruise control is available up to a maximum speed of 155 mph (250 km/h).

#### Displays on the multifunction display

-  (gray): cruise control is selected but not yet active, or temporarily passive.
-  (green): cruise control is active.

A stored speed appears along with the  display.

- ① The segments between the stored speed and the end of the segment display light up in the speedometer.

### System limits

Cruise control may be unable to maintain the stored speed on uphill gradients. The stored speed is resumed when the gradient evens out. Change into a lower gear in good time on long and steep downhill gradients. Take particular note of this when driving a laden vehicle. By doing so, you will make use of the braking effect of the engine. This relieves the load on the brake system and prevents the brakes from overheating and wearing too quickly.

Do not use cruise control in the following situations:

- In traffic situations which require frequent changes of speed, e.g. in heavy traffic, on winding roads.
- On slippery roads. Accelerating can cause the drive wheels to lose traction and the vehicle could then skid.

- If you are driving when visibility is poor.

### Operating cruise control

**⚠ WARNING** Risk of accident due to stored speed

If you call up the stored speed and this is lower than your current speed, the vehicle decelerates.

- ▶ Take into account the traffic situation before calling up the stored speed.

### Requirements:

- ESP® must be activated, but not intervening.
- The vehicle speed is at least 15 mph (20 km/h).
- The transmission is in position .

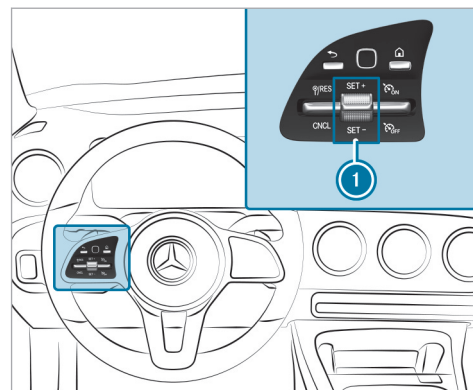



### Operating cruise control

- ▶ Press the rocker switch on the steering wheel control panel up or down to the desired position.



### Activating cruise control

- ▶ Select  with the right rocker switch.

### Activating cruise control

- ▶ Press rocker switch  up **SET+** or down **SET-**.  
The current speed is stored and maintained by the vehicle.
- or
- ▶ Select **RES/Ⓟ** with the left rocker switch.  
The last stored speed is called up and maintained by the vehicle.
- If the last stored speed has previously been deleted, the current vehicle speed is stored.
-  When you switch off the vehicle, the last speed stored is cleared.

#### Increasing/decreasing the stored speed

- ▶ 1 mph (1 km/h): press rocker switch  up **SET+** or down **SET-** to the pressure point.
- or
- ▶ 5 mph (10 km/h): press rocker switch  up **SET+** or down **SET-** beyond the pressure point.
- or
- ▶ Accelerate the vehicle to the desired speed and press rocker switch  up **SET+**.

#### Adopting a detected speed

- ▶ Activate cruise control or the variable limiter.
- ▶ If a traffic sign has been detected and is displayed in the instrument cluster: select **RES/Ⓟ** with the left rocker switch.  
The maximum permissible speed shown by the traffic sign is stored and the vehicle maintains or does not exceed this speed.

#### Deactivating cruise control

- ▶ Select **CNCL** with the left rocker switch.

#### Deactivating cruise control

- ▶ Select **OFF** with the right rocker switch.
-  If you brake, deactivate ESP® or if ESP® intervenes, cruise control is deactivated.

#### DSR (Downhill Speed Regulation)

##### Function of DSR (Downhill Speed Regulation)

DSR is an aid to assist you when driving downhill. It keeps the speed of travel at the selected target speed. The steeper the downhill gradient, the greater the DSR braking effect on the vehicle. On flat stretches of road and uphill gradi-

ents, the DSR brakes the vehicle minimally or not at all.

When DSR is activated and the transmission is in position **D**, **R** or **N**, DSR controls the driving speed. The target speed can be set to a value between 1 mph (2 km/h) and 11 mph (18 km/h). By braking or accelerating, you can drive at a higher or lower speed than the target speed at any time.

DSR is deactivated automatically if you drive at speeds greater than 28 mph (45 km/h) or select drive program **S**. The  Off message then appears in the multifunction display. The status indicator in the multifunction display disappears. You also hear a warning tone.

#### Notes on DSR

 **WARNING** Risk of skidding and accident when DSR is activated on slippery road surfaces

If the driven speed and the target speed differ, the wheels may lose traction.

- ▶ Take into account the road surface and the difference between the driving speed and target speed before activating DSR.

Observe the notes on driving systems and your responsibility; you may otherwise fail to recognize dangers (→ page 161).

You are always responsible for keeping control of the vehicle and for assessing whether the downhill gradient can be negotiated. Depending on road surface and tires, DSR may not always be able to keep to the target speed. Select a target speed suitable for the environmental conditions and also apply the brakes yourself if required.

### Activating or deactivating DSR (Downhill Speed Regulation)

#### Requirements:

- You are driving at 25 mph (40 km/h) or slower.

If the current vehicle speed is too high, the **Max. Speed 24 mph** message appears in the multifunction display.

- Active Distance Assist DISTRONIC is deactivated.



Multimedia system:

→  **Settings** **Quick Access**

- ▶ Select .  
A status display appears in the multifunction display when the function is activated.

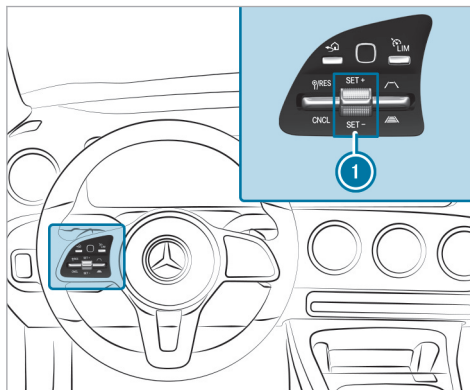
### Changing the target speed



- ▶ **To increase/reduce the target speed:** press rocker switch  up **SET+** or down **SET-** to the point of resistance. The selected target speed increases or decreases by 1 mph (1 km/h) and appears along with the  symbol in the multifunction display.

### Active Distance Assist DISTRONIC

#### Function of Active Distance Assist DISTRONIC

Active Distance Assist DISTRONIC maintains the set speed on free-flowing roads. If vehicles in front are detected, the set distance is maintained, if necessary, until the vehicle comes to a halt. The vehicle accelerates or brakes depending on the distance to the vehicle in front and the set speed. The speed and distance to the vehicle in front are set and saved using the steering wheel.

Available speed range:

- **Vehicles without Driving Assistance Package:** 15 mph (20 km/h) - 120 mph (200 km/h)



- **Vehicles with Driving Assistance Package:** 15 mph (20 km/h) - 130 mph (210 km/h)

Other features of Active Distance Assist DISTRONIC:

- Adjusts the driving style depending on the selected drive program (fuel efficient, comfortable or dynamic)
- Initiates acceleration to the stored speed if the turn signal indicator is switched on to change to the overtaking lane
- **Vehicles with Driving Assistance Package:**
  - Reacts to stationary vehicles detected in urban speed ranges (except bicycles and motorcycles)
  - Takes one-sided overtaking restrictions into account on highways or on multi-lane roads with separate roadways (country-dependent)

Observe the notes on driving systems and your responsibility; you may otherwise fail to recognize dangers (→ page 161).

### Active Distance Assist DISTRONIC displays in the instrument cluster

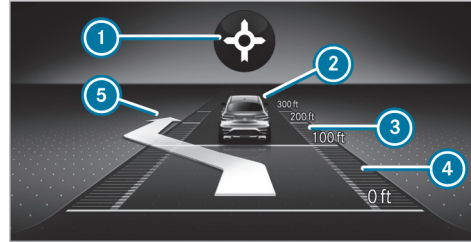

Assistance graphic

- ① Route-based speed adaptation: type of route event
- ② Vehicle in front
- ③ Distance indicator
- ④ Set specified distance
- ⑤ Active Lane Change Assist lane change display

### Permanent status display of Active Distance Assist DISTRONIC

- (white): Active Distance Assist DISTRONIC selected, specified distance set
- (green): Active Distance Assist DISTRONIC active, specified distance set and vehicle detected
- : Route-based speed adaptation active

The stored speed is shown along with the permanent status display and highlighted on the speedometer. When Active Distance Assist DISTRONIC is passive, the speed is grayed out.

- ① On highways or high-speed major roads, the green vehicle symbol is displayed cyclically when the vehicle is ready to pull away.
- ① If you depress the accelerator pedal beyond the setting of the Active Distance Assist DISTRONIC, the system is switched to passive mode. The **Suspended** message appears in the multifunction display.

### Active Distance Assist DISTRONIC display in the speedometer

The stored speed is highlighted on the speedometer. If the speed of the vehicle in front or the speed adjustment is less than the stored speed due to the route event ahead, the segments in the speedometer light up. Deactivation of Active Distance Assist DISTRONIC, as well as alterations to the speed due to manual or automatic adoption of the maximum permissible speed, are displayed in the control feedback of the multi-function display on a single line.

### System limits

The system may be impaired or may not function in the following situations, for example:

- In snow, rain, fog, heavy spray, if there is glare, in direct sunlight or in greatly varying ambient light.
- If there is swirling dust, e.g. when driving off-road or on sandy surfaces.
- The windshield in the area of the camera is dirty, fogged up, damaged or covered.
- If the radar sensors are dirty or covered.

- In parking garages or on roads with steep uphill or downhill gradients.
- If there are narrow vehicles in front, such as bicycles or motorcycles.

In addition, on slippery roads, braking or accelerating can cause one or several wheels to lose traction and the vehicle could then skid.

Do not use Active Distance Assist DISTRONIC in these situations.

**⚠ WARNING** Risk of accident from acceleration or braking by Active Distance Assist DISTRONIC

Active Distance Assist DISTRONIC may accelerate or brake in the following cases, for example:

- If the vehicle pulls away using Active Distance Assist DISTRONIC.
- If the stored speed is called up and is considerably faster or slower than the currently driven speed.

- If Active Distance Assist DISTRONIC no longer detects a vehicle in front or does not react to relevant objects.

- ▶ Always carefully observe the traffic conditions and be ready to brake at all times.
- ▶ Take into account the traffic situation before calling up the stored speed.

**⚠ WARNING** Risk of accident due to insufficient deceleration by Active Distance Assist DISTRONIC

Active Distance Assist DISTRONIC brakes your vehicle with up to 50% of the possible deceleration. If this deceleration is not sufficient, Active Distance Assist DISTRONIC alerts you with a visual and acoustic warning.

- ▶ Adjust your speed and maintain a suitable distance from the vehicle in front.
- ▶ Brake the vehicle yourself and/or take evasive action.

**⚠ WARNING** Risk of accident if detection function of Active Distance Assist DISTRONIC is impaired

Active Distance Assist DISTRONIC does not react or has a limited reaction:

- when driving on a different lane or when changing lanes
- to pedestrians, animals, bicycles or stationary vehicles, or unexpected obstacles
- to complex traffic conditions
- to oncoming vehicles and crossing traffic

As a result, Active Distance Assist DISTRONIC may neither give warnings nor intervene in such situations.

▶ Always observe the traffic conditions carefully and react accordingly.

### Operating Active Distance Assist DISTRONIC Requirements:

- The electric parking brake is released.
- ESP® is activated and is not intervening.
- The transmission is in position **D**.

- The driver's door is closed.
- Check of the radar sensor system has been successfully completed.
- Parking Assist PARKTRONIC is not being used to park the vehicle or to exit from a parking space.
- DSR is deactivated.

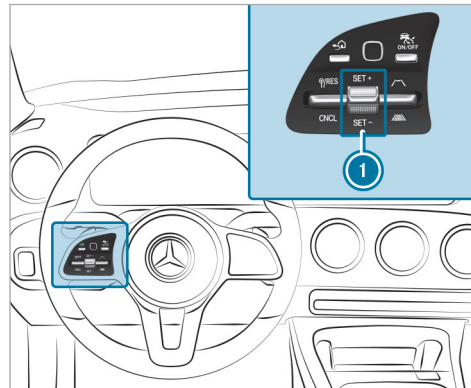

▶ **To operate Active Distance Assist DISTRONIC:** press the rocker switch on the steering wheel control unit up or down to the desired position.

### Activating/deactivating Active Distance Assist DISTRONIC

▶ Press the button.

### Activating Active Distance Assist DISTRONIC

▶ **To activate without a stored speed:** press rocker switch **1** up **SET+** or down **SET-**, or select **RES/0** with the left rocker switch.

or

▶ **To activate with a stored speed:** select **RES/0** with the left rocker switch.

▶ Remove your foot from the accelerator pedal. The current speed is stored and maintained by the vehicle.

### Adopting a detected speed limit

▶ Activate Active Distance Assist DISTRONIC.

- ▶ If a traffic sign has been detected and is displayed in the instrument cluster: select  with the left rocker switch. The maximum permissible speed on the traffic sign is adopted as the stored speed. The vehicle adapts its speed to that of the vehicle in front, but only up to the stored speed.

#### Pulling away with Active Distance Assist DISTRONIC

- ▶ Activate Active Distance Assist DISTRONIC and remove your foot from the brake pedal.
- ▶ Select  with the left rocker switch.

or

- ▶ Depress the accelerator pedal briefly and firmly. The functions of Active Distance Assist DISTRONIC continue to be carried out.

#### Deactivating Active Distance Assist DISTRONIC

**⚠ WARNING** Risk of accident due to Active Distance Assist DISTRONIC still being activated when you leave the driver's seat



If you leave the driver's seat while the vehicle is being braked by Active Distance Assist DISTRONIC only, the vehicle can roll away.

- ▶ Always deactivate Active Distance Assist DISTRONIC and secure the vehicle to prevent it from rolling away before you leave the driver's seat.



- ▶ Select  with the left rocker switch.

**i** If you brake, deactivate ESP® or if ESP® intervenes, Active Distance Assist DISTRONIC is deactivated.



#### Increasing or decreasing the speed

- ▶ 1 mph (1 km/h): press rocker switch  up  or down  to the pressure point.



or

- ▶ 5 mph (10 km/h): press rocker switch  up  or down  beyond the pressure point.

or

- ▶ Accelerate the vehicle to the desired speed and press rocker switch  up .

#### Changing the specified distance to the vehicle in front

- ▶ **To reduce the specified distance:** press the right rocker switch up ().
- ▶ **To increase the specified distance:** press the right rocker switch down (.

#### Function of Active Speed Limit Assist

If speed limit change between 12 mph (20 km/h) and 80 mph (130 km/h) is detected and the automatic adoption of speed limits is active, it will be automatically adopted as the stored speed .

The driven speed is adjusted when the vehicle is level with the traffic sign at the latest. In the case of signs indicating entry into an urban area, the speed is adapted according to the speed

permitted within the urban area. The speed limit display in the Instrument Display is always updated when the vehicle is level with the traffic sign.

If there is no speed restriction on an unlimited stretch of road (e.g. on a freeway), the recommended speed is automatically adopted as the stored speed. The system uses the speed stored on an unlimited stretch of road as the recommended speed. If you do not alter the stored speed on an unlimited stretch of road, the recommended speed is 80 mph (130 km/h).

If Active Distance Assist DISTRONIC has been put into passive mode by pressing the accelerator pedal, only speed limits which are higher than the set speed are adopted.

Observe the notes on driving systems and your responsibility; you may otherwise fail to recognize dangers (→ page 161).

### System limits

The system limits of Traffic Sign Assist apply to the detection of traffic signs .

Speed limits below 12 mph (20 km/h) are not automatically adopted by the system as the stored speed. Temporary speed restrictions (e.g.

for a certain time or due to weather conditions) cannot be properly detected by the system. The maximum permissible speed applying to a vehicle with a trailer is not detected by the system.

Adjust the speed in these situations.

**⚠ WARNING** Risk of accident due to Active Speed Limit Assist adapting the vehicle's speed

The speed adopted by Active Speed Limit Assist may be too high or incorrect in some individual cases, such as:

- at speed limits below 12 mph (20 km/h)
- in wet conditions or in fog
- when towing a trailer

- ▶ Ensure that the driven speed complies with traffic regulations.
- ▶ Adjust the driving speed to suit current traffic and weather conditions.

## Active Steering Assist



### Function of Active Steering Assist





Active Steering Assist is only available up to a speed of 130 mph (210 km/h). The system helps you to stay in the center of the lane by means of moderate steering interventions. Depending on the speed driven, Active Steering Assist uses the vehicles ahead and lane markings as a reference.

- ① Depending on the country, in the lower speed range Active Steering Assist can use the surrounding traffic as a reference. If necessary, Active Steering Assist can then also provide assistance when driving outside the center of the lane, for example to form a rescue lane.

If the detection of lane markings and vehicles ahead is impaired, Active Steering Assist switches to passive mode. The system provides no support in this case.

### Status display of Active Steering Assist in the multifunction display

-  (gray): activated and passive
-  (green): activated and active

-  (red): system limits detected
  -  (white, red hands): "hands on the steering wheel" prompt
- i** During the transition from active to passive status, the  symbol is shown as enlarged and flashing. Once the system is passive, the  symbol is shown as gray in the multifunction display.
- i** Depending on the selected vehicle settings, Active Steering Assist may be unavailable.

### Steering and touch detection

The driver is required to keep their hands on the steering wheel at all times and be able to intervene at any time to correct the course of the vehicle and keep it in lane. The driver must expect a change from active to passive mode or vice versa at any time.



If the system detects that the driver has not steered the vehicle for a considerable period of time or has removed their hands from the steering wheel, display **1** appears. If the driver still does not steer the vehicle, a warning tone sounds in addition to the visual warning message.

If the driver does not react to this warning for a considerable period, an emergency stop is initiated (→ page 181).

The warning is not issued or is stopped when the driver gives confirmation to the system:

- The driver steers the vehicle.

- The driver presses a steering wheel button or operates Touch Control.

If Active Steering Assist detects that a system limit has been reached, a visual warning is issued and a warning tone sounds.

Observe the notes on driving systems and your responsibility; you may otherwise fail to recognize dangers (→ page 161).

### System limits

Active Steering Assist has a limited steering torque for lateral guidance. In some cases, the steering intervention is not sufficient to keep the vehicle in the lane or to drive through exits.

The system may be impaired or may not function in the following instances:

- There is poor visibility, e.g. due to snow, rain, fog, heavy spray, greatly varying ambient light or strong shadows on the road.
- There is glare, e.g. from oncoming traffic, direct sunlight or reflections.
- Insufficient road illumination.

- The windshield is dirty, fogged up, damaged or covered in the vicinity of the camera, e.g. by a sticker.
- No, or several, unclear lane markings are present for one lane, or the markings change quickly, for example, in a construction area or intersections.
- The lane markings are worn away, dark or covered up, e.g. by dirt or snow.
- If the distance to the vehicle in front is too short and thus the lane markings cannot be detected.
- The road is narrow and winding.
- There are obstacles on the lane or projecting out into the lane, such as object markers.

The system does not provide assistance in the following conditions:

- On tight curves and when turning.
- When crossing intersections.
- At roundabouts or toll stations.
- When the tire pressure is too low.

**⚠ WARNING** Risk of accident if Active Steering Assist unexpectedly stops functioning

If the system limits of Active Steering Assist are reached there is no guarantee that the system will remain active or will keep the vehicle in lane.

- ▶ Always keep your hands on the steering wheel and observe the traffic carefully.
- ▶ Always steer the vehicle paying attention to traffic conditions.

**⚠ WARNING** Risk of accident if Active Steering Assist unexpectedly intervenes

The detection of lane markings and objects may malfunction and cause unexpected steering interventions.

- ▶ Steer according to traffic conditions.



### Activating/deactivating Active Steering Assist

#### Requirements:

- ESP® is activated, but is not intervening.

- Active Distance Assist DISTRONIC is activated.

Multimedia system:

- ▶  [Settings](#) ▶ [Quick Access](#)
- ▶ Select  [Steering Assist](#).

### Function of Active Emergency Stop Assist



If the system detects that the driver has not steered the vehicle for a considerable period of time or has removed their hands from the steering wheel, display ① appears in the multifunction display. If the driver still does not steer the vehicle, or gives no confirmation to the system,

a warning tone sounds in addition to the visual warning message.

If the driver still does not respond to the warning, the **Beginning Emergency Stop** message appears in the multifunction display. If the driver still does not respond, Active Distance Assist DISTRONIC reduces the speed. The vehicle is decelerated in stages to a standstill.

Depending on the country, at speeds below 40 mph (60 km/h) the hazard warning lights switch on automatically.

When the vehicle is stationary, the following actions are carried out:

- The vehicle is secured with the electric parking brake.
- Active Distance Assist DISTRONIC is ended
- The vehicle is unlocked.
- If possible, an emergency call is placed to the Mercedes-Benz emergency call center

The driver can cancel the deceleration at any time by performing one of the following actions:

- Steering

- Braking or accelerating
- Deactivating Active Distance Assist DISTRONIC

### Function of Hill Start Assist

Hill Start Assist holds the vehicle for a short time when pulling away on a hill under the following conditions:

- **Vehicles with automatic transmission:**  
The transmission is in position **D** or **R**.
- The electric parking brake is released.

This gives you enough time to move your foot from the brake pedal to the accelerator pedal and depress it before the vehicle begins to roll away.

**▲ WARNING** Risk of accident and injury due to the vehicle rolling away

After a short time, Hill Start Assist no longer holds the vehicle.

- ▶ Swiftly move your foot from the brake pedal to the accelerator pedal. Do not

leave the vehicle when it is being held by Hill Start Assist.

### HOLD function

#### HOLD function

The HOLD function holds the vehicle at a standstill without requiring you to depress the brake pedal, e.g. while waiting in traffic.

The HOLD function is only an aid. The responsibility for the vehicle safely standing still remains with the driver.

#### System limits

The HOLD function is only intended to provide assistance when driving and is not a sufficient means of safeguarding the vehicle against rolling away when stationary.

- The incline must not be greater than 30%.



### Activating/deactivating the HOLD function

**⚠ WARNING** Risk of an accident due to the HOLD function being activated when you leave the vehicle

If the vehicle is only braked with the HOLD function it could, in the following situations, roll away:

- If there is a malfunction in the system or in the power supply.
  - If the HOLD function is deactivated by depressing the accelerator pedal or brake pedal, e.g. by a vehicle occupant.
- ▶ Always secure the vehicle against rolling away before you leave it.

#### Requirements:

- The vehicle is stationary.
- The driver's door is closed or the seat belt on the driver's side is fastened.
- The engine is running or has been automatically switched off by the ECO start/stop function.
- The electric parking brake is released.
- Active Distance Assist DISTRONIC is deactivated.
- **Vehicles with automatic transmission:**  
The transmission is in position **[D]**, **[R]** or **[N]**.

#### Activating the HOLD function

- ▶ Depress the brake pedal and after a short time quickly depress further until the **[HOLD]** display appears in the multifunction display.
- ▶ Release the brake pedal.

#### Deactivating the HOLD function

- ▶ Depress the accelerator pedal to pull away.
- or
- ▶ Depress the brake pedal until the **[HOLD]** display disappears from the multifunction display.

The HOLD function is deactivated in the following situations:

- The vehicle is secured with the electric parking brake.

In the following situations, the vehicle is held by transmission position **[P]** and/or by the electric parking brake:

- The seat belt is unfastened and the driver's door is opened.
- The vehicle is switched off.
- There is a malfunction in the system or the power supply is insufficient.

#### Start-off assist

##### Function of the start-off assist

The start-off assist enables optimal vehicle acceleration from a standstill. For this, a suitably high-grip road surface is required, the tires and vehicle must also be in good condition.

Do not activate the start-off assist on public roads.

Be sure to observe the safety notes and information on ESP® (→ page 164).

### Activating the start-off assist

**⚠ WARNING** Risk of skidding and having an accident from wheels spinning

When you use start-off assist, individual wheels could spin and you could lose control of the vehicle.

If ESP® is deactivated, there is a risk of skidding and accident!

- ▶ Make sure that no persons or obstacles are in the close vicinity of your vehicle.

- ▶ Deactivating ESP® (→ page 165).
- ▶ Move the steering wheel to the straight-ahead position.
- ▶ Depress the brake pedal firmly with your left foot and keep it depressed.
- ▶ Engage the **D** drive position (→ page 148).
- ▶ Select the sportiest available drive program **S+** or **S** (→ page 144).
- ▶ Rapidly depress the accelerator pedal fully.

- ▶ Take your foot off the brake, but keep the accelerator pedal depressed. The vehicle pulls away at maximum acceleration.
- ▶ Switch on ESP® once the acceleration procedure is complete. ESP® will otherwise not be able to stabilize the vehicle if the vehicle starts to skid or a wheel starts to spin.

### Canceling the start-off assist

- ▶ Remove your foot from the accelerator pedal.
- ▶ Reactivate the ESP®.

### Parking Assist PARKTRONIC

#### Function of Parking Assist PARKTRONIC

Parking Assist PARKTRONIC is an electronic parking assistance system with ultrasound. It monitors the area around your vehicle using multiple sensors on the front bumper and on the rear bumper. Parking Assist PARKTRONIC shows you the distance between your vehicle and a detected obstacle visually and audibly.

Parking Assist PARKTRONIC is only an aid. It is not a substitute for your attention to the surroundings. The responsibility for safe maneuvering and parking remains with you. Make sure that there are no persons, animals or objects in the maneuvering area while maneuvering and parking in/exiting parking spaces.

In the standard setting, an intermittent warning tone sounds from a distance of approximately 1.0 ft (0.3 m) to an obstacle in front and approximately 3.3 ft (1.0 m) to an obstacle behind. A continuous warning tone sounds from a distance of approximately 0.7 ft (0.2 m). Using the **Warn Early All Around** setting in the multimedia system, the warning tones for front and side impact protection can be set to sound at a greater distance of approximately 3.3 ft (1.0 m) in front and 2.0 ft (0.6 m) on the sides (→ page 188).

- ⓘ The **Warn Early All Around** setting is always active at the rear of the vehicle.

If Parking Assist PARKTRONIC is deactivated, Active Parking Assist is unavailable.

### Parking Assist PARKTRONIC display in the multimedia system



Vehicles with Active Parking Assist without a surround view camera



Vehicles with Active Parking Assist and a surround view camera

If Active Parking Assist is deactivated and an obstacle is detected in the path of the vehicle, a pop-up window for Parking Assist PARKTRONIC ① appears in the multimedia system at speeds below 6 mph (10 km/h).

The color of the individual segments of the warning display is based on the distance to the detected obstacle:

- **Yellow segments:** obstacles at a distance between approx. 2.0 ft (0.6 m) and 3.3 ft (1.0 m)

- **Orange segments:** obstacles at a distance between approx. 1.0 ft (0.3 m) and 2.0 ft (0.6 m)
- **Red segments:** obstacles at a very short distance of approx. 1.0 ft (0.3 m) or less

### Display of Parking Assist PARKTRONIC in the Head-up Display

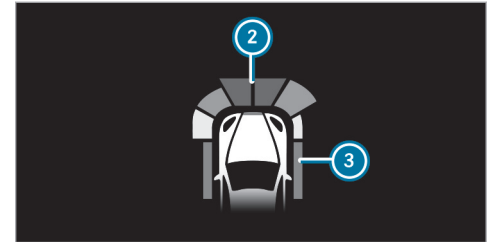

Optionally, obstacles detected by Parking Assist PARKTRONIC from a distance of approximately 3.3 ft (1.0 m) in front ② and 2.0 ft (0.6 m) on the sides ③ can also be displayed in the Head-up Display.

### System limits

Parking Assist PARKTRONIC does not necessarily take into account the following obstacles:

- Obstacles below the detection range, e.g. persons, animals or objects.
- Obstacles above the detection range, e.g. overhanging loads, overhangs or loading ramps of trucks.

The sensors must be free of dirt, ice and slush. Otherwise, they may not function correctly. Clean the sensors regularly, especially after driving off-road, taking care not to scratch or damage them.

### Problems with Parking Assist PARKTRONIC

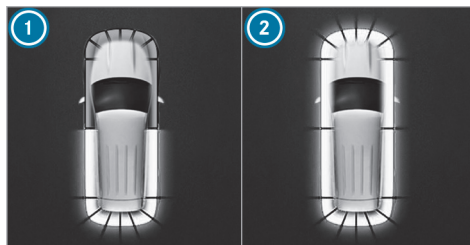

Example: vehicles with surround view camera

When rear segments ① or all-around segments ② light up red and the  symbol appears in the multifunction display, Parking Assist PARKTRONIC may have been deactivated due to signal interference. Start the vehicle again and check if Parking Assist PARKTRONIC is working at a different location.

If a warning tone also sounds for approximately two seconds every time the vehicle is started, it may be due to one of the following causes:

- **The sensors are dirty:** clean the sensors and observe the notes on care of vehicle parts (→ page 239).
- **Parking Assist PARKTRONIC has been deactivated due to a malfunction:** restart the vehicle. If the problem persists, consult a qualified specialist workshop.

### Function of the passive side impact protection

Passive side impact protection is an additional Parking Assist PARKTRONIC function which warns the driver about obstacles at the side of the vehicle. A warning is issued when obstacles are detected between the front and rear detection range. In order for an object on the side to be detected, the sensors in the front and rear bumper must first detect the object while you are driving past it.

During the parking procedure or when maneuvering, objects are detected as the vehicle drives past. If you steer in the direction of a detected

obstacle and there is a risk of a lateral collision, a warning is issued and the segments light up in color in the display.

The segment color changes depending on the distance to the detected obstacle:

- **Yellow:** approximately 1.0 - 2.0 ft (30 - 60 cm)
- **Red:** less than approximately 1.0 ft (30 cm)

In order for lateral front or rear segments to be displayed, the vehicle must first travel a distance of at least half of the vehicle length. Once the vehicle has traveled the length of the vehicle, all of the lateral front and rear segments can be displayed.

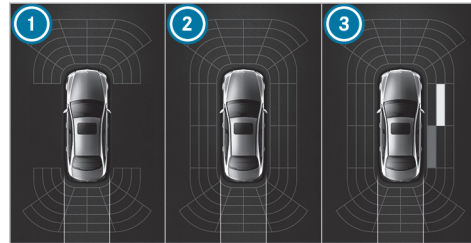

Parking Assist PARKTRONIC display: vehicles without a surround view camera

- 1 Operational front and rear
- 2 Operational front, rear and sides
- 3 Obstacle detected at the front right (yellow) and rear (red)

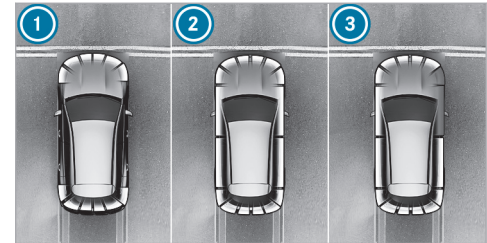

Parking Assist PARKTRONIC display: vehicles with a surround view camera

- 1 Operational front and rear
- 2 Operational front, rear and sides
- 3 Obstacles detected at the front right (red)

Saved obstacles on the sides are deleted in the following situations, for example:

- You park the vehicle and switch off the ignition.
- You open the doors.

After the engine is restarted, obstacles on the sides must be detected again before a new warning can be issued.

### System limits

The system limits for Parking Assist PARKTRONIC apply to passive side impact protection.

The following objects are not detected, for example:

- Pedestrians who approach the vehicle from the side
- Objects placed next to the vehicle

### Activating/deactivating Parking Assist PARKTRONIC

**!** **NOTE** Risk of an accident from objects at close range

Parking Assist PARKTRONIC may not detect certain objects at close range.

- ▶ When parking or maneuvering the vehicle, pay particular attention to any objects which are above or below the sensors, e.g. flower pots or drawbars. The vehicle or other objects could otherwise be damaged.

### Requirements:

- The camera menu is open.
- Or: Active Parking Assist is active.
- Or: the PARKTRONIC pop-up window appears.

**i** Make sure that there are no persons, animals or objects in the maneuvering area while maneuvering and parking in/exiting parking spaces.

▶ Tap  in the media display.

**i** If the  symbol is shown in the multifunction display, Parking Assist PARKTRONIC is not active. Parking Assist PARKTRONIC is automatically activated when the vehicle is started.

Alternatively, Parking Assist PARKTRONIC can be activated or deactivated in the quick access menu.

### Adjusting the warning tones of Parking Assist PARKTRONIC

Multimedia system:

▶  ▶ Settings ▶ Assistance  
▶▶ Camera & Parking

### Adjusting the volume of the warning tones

- ▶ Select [Warning Tone Volume](#).
- ▶ Set a value.

### Adjusting the pitch of the warning tones

- ▶ Select [Warning Tone Pitch](#).
- ▶ Set a value.

### Specifying the starting point for the warning tones

You can specify whether the Parking Assist PARKTRONIC warning tones should commence when the vehicle is further away from an obstacle.

- ▶ Select [Warn Early All Around](#).
- ▶ Activate or deactivate the function.

### Activating/deactivating audio fadeout

You can specify whether the volume of a media source in the multimedia system is to be reduced when Parking Assist PARKTRONIC sounds a warning tone.

- ▶ Select **Audio Fadeout During Warning Tones**.
- ▶ Activate or deactivate the function.

### Reversing camera

#### Function of the rear view camera

When you engage reverse gear, the image from the rear view camera is shown in the media display. Dynamic guide lines show the path the vehicle will take with the current steering angle. This helps you to orient yourself and to avoid obstacles when backing up.

The rear view camera is only an aid. It is not a substitute for your attention to the surroundings. The responsibility for safe maneuvering and parking remains with you. Make sure that there are no persons, animals or objects etc., in the maneuvering area while maneuvering and parking.

**i** You can open the cover of the rear view camera manually (→ page 194).

The guide lines in the media display show the distances to your vehicle. The distances displayed only apply to road level.

Depending on the vehicle equipment, you can select from the following views:

- Normal view
- Wide-angle view

The area behind the vehicle is displayed as a mirror image, as in the inside rearview mirror.

#### Vehicles without Active Parking Assist

The following camera views are available in the multimedia system:

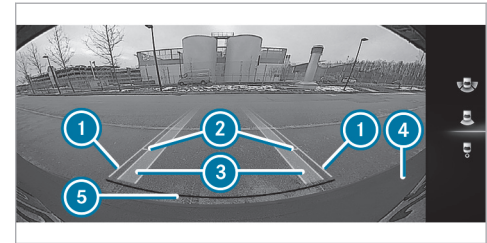

Normal view

- ① Yellow guide line, vehicle width (driven surface) depending on the current steering angle (dynamic)
- ② Yellow guide line at a distance of approximately 3.3 ft (1.0 m) from the rear area
- ③ Yellow lanes marking the course the tires will take with the current steering angle (dynamic)
- ④ Bumper
- ⑤ Red guide line at a distance of approximately 1.0 in (0.3 m) from the rear area

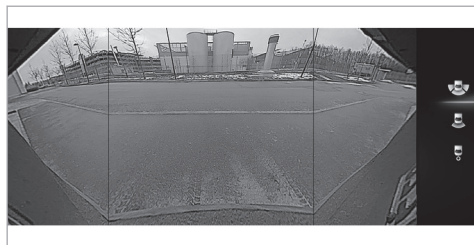

Wide-angle view

### Vehicles with Active Parking Assist

The following camera views are available in the multimedia system:

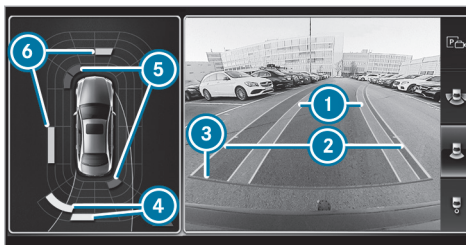

Normal view

- ① Yellow lanes marking the course the tires will take with the current steering angle (dynamic)
- ② Yellow guide line, vehicle width (driven surface) depending on the current steering angle (dynamic)
- ③ Red guide line at a distance of approximately 1.0 in (0.3 m) from the rear area
- ④ Yellow warning indicator of Parking Assist PARKTRONIC: obstacles at a distance between approximately 2.0 ft (0.6 m) and 3.3 ft (1.0 m)
- ⑤ Red warning display of Parking Assist PARKTRONIC: obstacles are very close (approximately 1.0 ft (0.3 m) or less)
- ⑥ Orange warning display of Parking Assist PARKTRONIC: obstacles are a medium distance away (between approximately 1.0 ft (0.3 m) and 2.0 ft (0.6 m))



Wide-angle view

### System failure

If the rear view camera is not operational, the following display appears in the multimedia system.





### System limits

The rear view camera will not function or will only partially function in the following situations:

- The tailgate is open.
  - There is heavy rain, snow or fog.
  - The ambient light conditions are poor, e.g. at night.
  - Cameras, or vehicle components in which the cameras are installed, are damaged, dirty or covered. Observe the information on vehicle sensors and cameras (→ page 162).
- i** Do not use the rear view camera in these types of situation. You could otherwise injure others or collide with objects when parking the vehicle.
- i** The contrast of the display may be impaired by direct sunlight or by other light sources, e.g. when driving out of a garage. In this case, pay particular attention.

- i** Have the display repaired or replaced if, for example, pixel errors considerably restrict its use.

### 360° camera

#### Function of the surround view camera

The surround view camera is a system that consists of four cameras. The cameras cover the immediate vehicle surroundings. The system assists you, e.g. when parking or at exits with reduced visibility.

The views of the surround view camera are always available when driving forwards up to a speed of approx. 10 mph (16 km/h) and when backing up.

The surround view camera is only an aid and may show a distorted view of obstacles, show them incorrectly or not show them at all. It is not a substitute for your attention to the surroundings. The responsibility for safe maneuvering and parking remains with you. Make sure that there are no persons, animals or objects etc., in the maneuvering area while maneuvering and parking.

The system evaluates images from the following cameras:

- Rear view camera
- Front camera
- Two side cameras in the outside mirrors

- i** You can open the cover of the rear view camera manually (→ page 194).

#### Views of the surround view camera

You can select from different views:



- 1** Wide-angle view, front
- 2** Top view with image from the front camera

## 192 Driving and parking

- ③ Top view with images from the side cameras in the outside mirrors
- ④ Wide-angle view, rear
- ⑤ Top view with image from the rear view camera
- ⑥ Top view with trailer view (vehicles with a trailer hitch)

### Top view

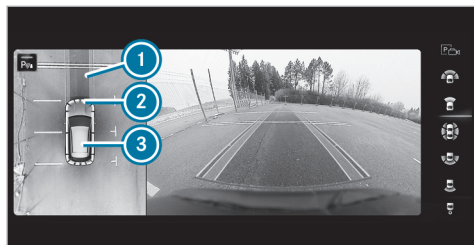

- ① Lane indicating the route the vehicle will take at the current steering wheel angle
- ② Warning display of Parking Assist PARKTRONIC
- ③ Your vehicle from above

The color of the individual segments of warning display ② is based on the distance to the detected obstacle:

- **Yellow segments:** obstacles at a distance between approx. 2.0 ft (0.6 m) and 3.3 ft (1.0 m)
- **Orange segments:** obstacles at a distance between approx. 1.0 ft (0.3 m) and 2.0 ft (0.6 m)
- **Red segments:** obstacles at a very short distance of approx. 1.0 ft (0.3 m) or less

When Parking Assist PARKTRONIC is operational and no object is detected, the segments of the warning display are shown in gray.

### Guide lines

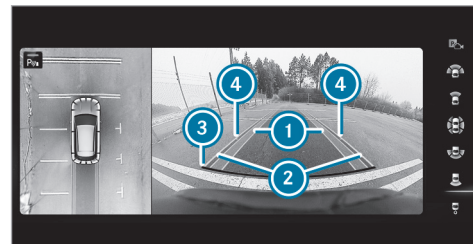

- ① Yellow lane marking the course the tires will take at the current steering wheel angle (dynamic)
- ② Yellow guide line, vehicle width (driven surface) depending on the current steering wheel angle (dynamic)
- ③ Red guide line at a distance of approximately 1.0 in (0.3 m) from the rear area
- ④ Mark at a distance of approx. 3.3 ft (1.0 m)
- i When Active Parking Assist is active, lane markings ① are displayed in green.

The guide lines in the media display show the distances to your vehicle. The distances apply to road level.

### Side view of the mirror cameras

The sides of the vehicle can be seen in this view.

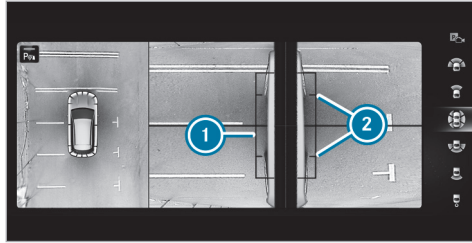

- ① Guide line of external vehicle dimensions with outside mirrors folded out
- ② Marker of the wheel contact points

### System failure

If the system is not ready for operation, the following message appears in the media display:



### System limits

The surround view camera will not function or will only partially function in the following situations:

- The doors are open.
  - The outside mirrors are folded in.
  - The tailgate is open.
  - There is heavy rain, snow or fog.
  - The ambient light conditions are poor, e.g. at night.
  - Cameras, or vehicle components in which the cameras are installed, are damaged, dirty or covered. Observe the information on vehicle sensors and cameras (→ page 162).
- ⓘ Do not use the surround view camera under such circumstances. You could otherwise injure others or collide with objects when parking the vehicle.

For technical reasons, the standard height of the vehicle may be altered if the vehicle is carrying a heavy load and can result in inaccuracies in the guide lines and in the display of the generated images.

- ⓘ The contrast of the display may be impaired by abrupt, direct sunlight or by other light sources, e.g. when driving out of a garage. In this case, pay particular attention.
- ⓘ Have the display repaired or replaced if, for example, pixel errors considerably restrict its use.

See the notes on cleaning the surround view camera (→ page 239).

### Selecting a view for the surround view camera

- ▶ Shift to reverse gear.
- ▶ Select the desired view in the multimedia system (→ page 191).
- ▶ If, after shifting to reverse gear, the image of the rear view camera is not shown: switch off the ignition, press and hold the  button, switch on the ignition and engage reverse gear again.

### Opening the camera cover of the rear view camera

Multimedia system:

→  ► Settings ► Assistance  
► Camera & Parking

► Select **Open Camera Cover**.

ⓘ The camera cover closes automatically after some time or after an ignition cycle.

### Active Parking Assist

#### Function of Active Parking Assist

Active Parking Assist is an electronic parking assistance system that automatically searches for and measures parking spaces on both sides of the vehicle when traveling forwards up to approx. 22 mph (35 km/h).

**Vehicles with automatic transmission:** Active Parking Assist provides assistance when changing gear, accelerating, braking and steering the vehicle.

If all requirements are met, the  display appears in the multifunction display. The system then independently locates and measures paral-

lel and perpendicular parking spaces on both sides of the vehicle.

When Active Parking Assist has detected parking spaces, the  display appears in the multifunction display. The arrows show on which side of the road detected parking spaces are located. They are then shown in the media display. The parking space and, if necessary, the parking direction can be selected as desired. Active Parking Assist calculates a suitable vehicle path, switches on the turn signal indicator and assists you in parking and exiting the parking space.

Active Parking Assist is only an aid. It is not a substitute for your attention to the surroundings. The responsibility for safe maneuvering and parking remains with you. Make sure that no persons, animals or objects etc. are in the maneuvering range.

If one of the following actions is carried out, Active Parking Assist is canceled:

- Parking Assist PARKTRONIC is deactivated.
- You begin steering.
- You apply the parking brake.

- **Vehicles with automatic transmission:** you engage transmission position .

- ESP<sup>®</sup> intervenes.

- You open the doors or the tailgate while driving.

#### System limits

Objects located above or below the detection range of the sensors, e.g. overhanging loads, tail sections or loading ramps of goods vehicles, or the borders of parking spaces, are not detected during measurement of the parking space. These are also then not taken into account when calculating the parking procedure. In some circumstances, Active Parking Assist may therefore guide you into the parking space incorrectly.

**⚠ WARNING** Risk of accident due to objects located above or below the detection range of Active Parking Assist

If there are objects above or below the detection range, the following situations may arise:

- Active Parking Assist may steer too early.
- The vehicle may not stop in front of these objects.

This could cause a collision.

▶ In these situations, do not use Active Parking Assist.

Extreme environmental conditions, such as snowfall or heavy rain, may lead to a parking space being measured inaccurately. Parking spaces that are partially occupied by trailer drawbars might not be identified as such or be measured incorrectly. Only use Active Parking Assist on level, high-grip ground.

Do not use Active Parking Assist in the following situations:

- In extreme weather conditions such as ice, packed snow or in heavy rain.
- When transporting a load that protrudes beyond the vehicle.
- If the parking space is on a steep downhill or uphill gradient.
- When snow chains are installed.
- Directly after a tire change or when spare tires are installed.
- If the tire pressure is too low or too high.
- If the suspension is out of alignment, e.g. after bottoming out on a curb.
- On steep inclines of more than approx. 15%.

Active Parking Assist may also display parking spaces that are not suitable for parking, such as, e.g.:

- Parking spaces where parking is prohibited.
- Parking spaces on unsuitable surfaces.

### Parking with Active Parking Assist

ⓘ Depending on the vehicle's equipment, the button may also be located at a different position in the center console.

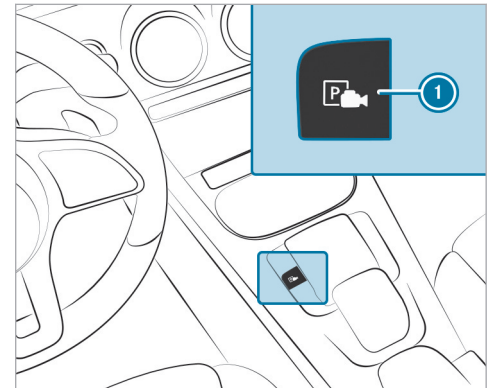

▶ Press button ①.

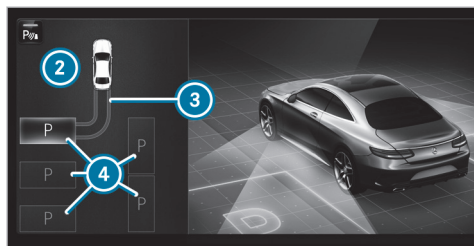

The media display shows the view of Active Parking Assist. Area ② displays detected parking spaces ④ and vehicle path ③.

- ① Vehicle path ③ shown on the media display may differ from the actual vehicle path.
- ▶ If a parking space is displayed: stop the vehicle.
- ▶ Select desired parking space ④ and confirm.
- ▶ If necessary, select the parking direction: forwards or reverse, and confirm. Vehicle path ③ is shown, depending on selected parking space ④ and the parking direction.

- ① The turn signal indicator is switched on automatically when the parking procedure begins.

You are responsible for selecting the turn signal indicator in accordance with the traffic conditions. If necessary, select the turn signal indicator accordingly.

**⚠ WARNING** Risk of accident due to vehicle swinging out while parking or pulling out of a parking space

While parking or exiting a parking space, the vehicle swings out and can drive onto areas of the oncoming lane.

This could cause you to collide with objects or other road users.

- ▶ Pay attention to objects and other road users.
- ▶ Where necessary, stop the vehicle or cancel the parking procedure with Active Parking Assist.

- ▶ If, for example, the **Please Engage Reverse Gear** message appears in the media display:

select the corresponding transmission position.

**Vehicles with automatic transmission:**

The vehicle drives into the selected parking space.

- ① During the parking procedure with Active Parking Assist, the lane markings are displayed in green in the camera image.

On completion of the parking procedure, the  **Parking Assist Finished, Take Control of Vehicle** display message appears. Further maneuvering may still be necessary.

- ▶ After completion of the parking procedure, safeguard the vehicle against rolling away. When required by legal requirements or local conditions: turn the wheels towards the curb.
- ① You can stop the vehicle and change the transmission position during the parking procedure. The system then calculates a new vehicle path. If no new vehicle path is available, the system can change the transmission position again or cancel the parking procedure.

## Exiting a parking space with Active Parking Assist

### Requirements:

- The vehicle has been parked with Active Parking Assist.

Please note that you are responsible for the vehicle and surroundings during the entire parking procedure.

- ▶ Start the vehicle.

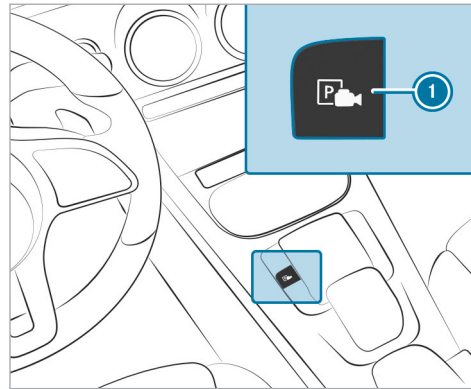

- ▶ Press button ①.  
The media display shows the view of Active Parking Assist.

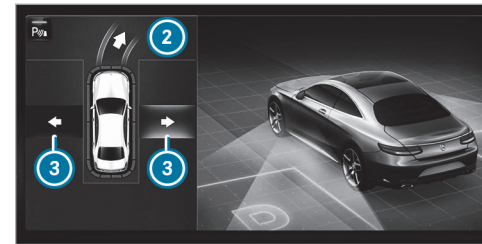

- ▶ If the vehicle has been parked perpendicular to the direction of travel: in area ②, select direction of travel ③ Left or Right.

ⓘ The vehicle path shown on the media display may differ from the actual vehicle path.

- ▶ Confirm direction of exit ③ to drive out of the parking space.

ⓘ The turn signal indicator is switched on automatically when the exiting procedure begins.

You are responsible for selecting the turn signal indicator in accordance with the traffic conditions. If necessary, select the turn signal indicator accordingly.

**▲ WARNING** Risk of accident due to vehicle swinging out while parking or pulling out of a parking space

While parking or exiting a parking space, the vehicle swings out and can drive onto areas of the oncoming lane.

This could cause you to collide with objects or other road users.

- ▶ Pay attention to objects and other road users.
- ▶ Where necessary, stop the vehicle or cancel the parking procedure with Active Parking Assist.

- ▶ If, for example, the **Please Engage Forward Gear** message appears in the media display: select the corresponding transmission position. The vehicle moves out of the parking space. The turn signal indicator is switched off automatically.

After the parking space has been exited, a warning tone and the  **Parking Assist Finished**,

**Take Control of Vehicle** message prompt you to take control of the vehicle.

The vehicle is not automatically braked and can roll away. You have to accelerate, brake, steer and change gear yourself again.

#### Function of Drive Away Assist

Drive Away Assist can reduce the severity of an impact when pulling away. If an obstacle is detected in the direction of travel, the vehicle's speed is briefly reduced to approx. 1 mph (2 km/h). If a critical situation is detected, the  symbol appears in the media display.

- ① You can cancel an intervention by Drive Away Assist at any time by pressing the  button.

**▲ WARNING** Risk of accident caused by limited detection performance of Drive Away Assist

Drive Away Assist cannot always clearly identify objects and traffic situations.

- ▶ Always pay careful attention to the traffic situation; do not rely on Drive Away Assist alone.
- ▶ Be prepared to brake or swerve as necessary, provided the traffic situation permits and that it is safe to take evasive action.

Drive Away Assist is only an aid. It is not a substitute for your attention to the surroundings. The responsibility for safe maneuvering and parking remains with you. Make sure that no persons, animals or objects etc. are in the maneuvering range.

A risk of a collision may arise in the following situations, for example:

- If the driver mixes up the accelerator and brake pedals.
- If an incorrect transmission position is engaged.

Drive Away Assist is active under the following conditions:

- If Parking Assist PARKTRONIC is activated.



- If you shift the transmission position to **R** or **D** when the vehicle is stationary.
- If the detected obstacle is less than approx. 3.3 ft (1.0 m) away.
- If the maneuvering assistant function is activated in the multimedia system.

### System limits

The performance of Drive Away Assist is limited on inclines.

- ⓘ Also observe the system limits of Parking Assist PARKTRONIC (→ page 184).

### Function of Cross Traffic Alert

- ⓘ Also observe the instructions on Blind Spot Assist and Active Blind Spot Assist (→ page 201).

### Vehicles with Blind Spot Assist or Active

**Blind Spot Assist:** Cross Traffic Alert can warn drivers of any crossing traffic when backing up and maneuvering out of a parking space. The radar sensors in the bumper also monitor the area adjacent to the vehicle. If a critical situation is detected, the  symbol appears in the media display. If the driver does not respond to

the warning, the vehicle's brakes can be applied automatically.

If the radar sensors are obstructed by vehicles or other objects, detection is not possible.

Cross Traffic Alert is active under the following conditions:

- If the vehicle is backing up at walking pace.
- If the maneuvering assistant function is activated in the multimedia system.

### System limits

Cross Traffic Alert is not available on inclines.

### Activating/deactivating maneuvering assistance

Multimedia system:

→  **▶ Settings ▶ Assistance**  
**▶ Camera & Parking**

 Switch **Maneuvering Assistance** on or off.

- ⓘ Maneuvering assistance must be active for the function of Drive Away Assist (→ page 198) and Cross Traffic Alert (→ page 199).

### ATTENTION ASSIST

#### Function of ATTENTION ASSIST

ATTENTION ASSIST assists you on long, monotonous journeys, e.g. on highways and trunk roads. If ATTENTION ASSIST detects indicators of fatigue or increasing lapses in concentration on the part of the driver, it suggests taking a break.

ATTENTION ASSIST is only an aid. It cannot always detect fatigue or lapses in concentration in time. The system is not a substitute for a well-rested and attentive driver. On long journeys, take regular breaks in good time that allow for adequate recuperation.

You can choose between two settings:

- **Standard:** normal system sensitivity.
- **Sensitive:** higher system sensitivity. The driver is warned earlier and the attention level detected by ATTENTION ASSIST is adapted accordingly.

If drowsiness or increasing lapses in concentration are detected, the **ATTENTION ASSIST: Take a Break!** warning appears in the Instrument Display. You can acknowledge the message and

## 200 Driving and parking

take a break where necessary. If you do not take a break and ATTENTION ASSIST continues to detect increasing lapses in concentration, you will be warned again after a minimum of 15 minutes.



You can have the following status information for ATTENTION ASSIST displayed in the assistance menu of the on-board computer:

- The length of the journey since the last break.
- The attention level determined by ATTENTION ASSIST:
  - the fuller the circle, the higher the attentional level determined
  - as your attention wanes, the circle in the center of the display becomes smaller

If ATTENTION ASSIST is unable to calculate the attention level and cannot issue a warning, the **System Suspended** message appears.

If ATTENTION ASSIST is deactivated, the  symbol appears in the assistance graphic in the Instrument Display when the engine is running. ATTENTION ASSIST is activated automatically when the engine is re-started. The last selected sensitivity level remains stored.

### System limits

ATTENTION ASSIST is active in the 37 mph (60 km/h) to 124 mph (200 km/h) speed range.

The functionality of ATTENTION ASSIST is restricted, and warnings may be delayed or not occur at all in the following situations:

- If you have been driving for less than approximately 30 minutes.
  - If the road condition is poor (uneven road surface or potholes).
  - If there is a strong side wind.
- If you adopt a sporty driving style (high cornering speeds or high rates of acceleration).
  - If the Steering Assist function of Active Distance Assist DISTRONIC is active.
  - If the time has been set incorrectly.
  - If you change lanes and vary your speed frequently in active driving situations.

The ATTENTION ASSIST tiredness or alertness assessment is deleted and restarted when continuing the journey in the following situations:

- If you switch off the engine.
- If you unfasten your seat belt and open the driver's door (e.g. changing drivers or taking a break).

### Setting ATTENTION ASSIST

Multimedia system:

 [Settings](#) [Assistance](#)  
[Attention Assist](#)

### Setting options

 Select [Standard](#), [Sensitive](#) or [Off](#).

### Suggesting a rest area

- ▶ Select **Suggest Rest Area**.
- ▶ Activate or deactivate the function. If ATTENTION ASSIST detects fatigue or increasing lack of attention, it suggests a rest area in the vicinity.
- ▶ Select the suggested rest area. You are guided to the selected rest area.



### Blind Spot Assist and Active Blind Spot Assist with exit warning

#### Function of Blind Spot Assist and Active Blind Spot Assist with exit warning

Blind Spot Assist and Active Blind Spot Assist use two lateral, rear-facing radar sensors to monitor the area up to 130 ft (40 m) behind and 10 ft (3 m) next to your vehicle.

If a vehicle is detected at speeds above approximately 8 mph (12 km/h) and this vehicle subsequently enters the monitoring range directly next to your vehicle, the warning lamp in the outside mirror lights up red.

Permanent status display in the instrument cluster:

-  (gray): system is activated but inoperative
-  (green): system is activated and operational

If a vehicle is detected close to your vehicle and you switch on the turn signal indicator in the corresponding direction, a double warning tone sounds and the red warning lamp in the outside mirror flashes. If the turn signal indicator remains switched on, all other detected vehicles are indicated only by the flashing of the red warning lamp.

If you overtake a vehicle quickly, no warning is given.

#### **WARNING** Risk of accident despite Blind Spot Assist

Blind Spot Assist does not react to vehicles approaching and overtaking you at a greatly different speed.

Blind Spot Assist cannot warn drivers in this situation.

- ▶ Always pay careful attention to the traffic situation and maintain a safe distance at the side of the vehicle.

Observe the notes on driving systems and your responsibility; you may otherwise fail to recognize dangers (→ page 161).

#### Exit warning

The exit warning is an additional function of Blind Spot Assist and can warn vehicle occupants about approaching vehicles when leaving the vehicle when stationary.

#### **WARNING** Risk of accident despite exit warning

The exit warning neither reacts to stationary objects nor to vehicles approaching you at a greatly differing speed.

The exit warning cannot warn drivers in these situations.

- ▶ Always pay particular attention to the traffic situation when opening the doors and make sure there is sufficient clearance.

If there is a vehicle in the monitoring range, this is indicated in the outside mirror. If a vehicle occupant opens the door on the side with the warning, a warning tone sounds and the warning lamp in the outside mirror starts to flash.

This additional function is only available when Blind Spot Assist is active. When the exit warning is activated, it can warn vehicle occupants for up to three minutes after switching the ignition off. The exit warning is no longer available once the warning lamp in the outside mirror flashes three times.

The exit warning is only an aid and not a substitute for the attention of vehicle occupants. The responsibility for opening and closing the doors and for leaving the vehicle remains with the vehicle occupants.

### System limits

Blind Spot Assist and Active Blind Spot Assist may be limited in the following situations:

- if there is dirt on the sensors or the sensors are obscured
- in poor visibility, e.g. due to fog, heavy rain or snow
- if there are narrow vehicles, e.g. bicycles or motorbikes
- if the road has very wide or narrow lanes
- if vehicles are not driving in the middle of their lane

Warnings may be issued in error when driving close to crash barriers or similar continuous lane borders. Always make sure that there is sufficient distance to the side for other traffic or obstacles.

Warnings may be interrupted when driving alongside long vehicles, for example trucks, for a prolonged time.

Blind Spot Assist is not operational when reverse gear is engaged.

The exit warning may be limited in the following situations:

- when the sensors are covered by adjacent vehicles in narrow parking spaces
- when people approach the vehicle
- in the event of stationary or slowly moving objects

### Function of brake application (Active Blind Spot Assist)

If Active Blind Spot Assist detects a risk of a side impact in the monitoring range, a course-correcting brake application is carried out. This is designed to help you avoid a collision.

The course-correcting brake application is available in the speed range between approximately 20 mph (30 km/h) and 125 mph (200 km/h).

**⚠ WARNING** Risk of accident despite brake application of Active Blind Spot Assist

A course-correcting brake application cannot always prevent a collision.

- ▶ Always steer, brake or accelerate yourself, especially if Active Blind Spot Assist warns you or makes a course-correcting brake application.
- ▶ Always maintain a safe distance at the sides.



If a course-correcting brake application occurs, the red warning lamp flashes in the outside mirror and a warning tone sounds. In addition, a display **1** indicating the danger of a side collision appears in the multifunction display.

In rare cases, the system may make an inappropriate brake application. This brake application

may be interrupted at any time if you steer slightly in the opposite direction or accelerate.

#### System limits

Note the system limitations of Active Blind Spot Assist; you may otherwise not recognize the dangers (→ page 201).

Either a course-correcting brake application appropriate to the driving situation, or none at all, may occur in the following situations:

- Vehicles or obstacles, e.g. crash barriers, are located on both sides of your vehicle.
- A vehicle approaches too closely on the side.
- You have adopted a sporty driving style with high cornering speeds.
- You brake or accelerate significantly.
- A driving safety system intervenes, e.g. ESP® or Active Brake Assist.
- ESP® is deactivated.
- A loss of tire pressure or a faulty tire is detected.

#### Activating/deactivating Blind Spot Assist or Active Blind Spot Assist

Multimedia system:

▶ ▶ Settings ▶ Assistance

▶ Activate or deactivate [Blind Spot Assist](#).  
or

▶ Activate or deactivate [Act. Blind Spot Assist](#).

#### Active Lane Keeping Assist

##### Function of Active Lane Keeping Assist



Active Lane Keeping Assist monitors the area in front of your vehicle by means of the multifunction camera (→ page 162). It serves to protect you against unintentionally leaving your lane. You will be warned by vibration pulses in the steering wheel and guided by a course-correcting brake application back into your lane.

Active Lane Keeping Assist is available in the speed range between 37 mph (60 km/h) and 124 mph (200 km/h).

Active Lane Keeping Assist can neither reduce the risk of an accident if you fail to adapt your driving style nor override the laws of physics. It

cannot take into account road, weather or traffic conditions. Active Lane Keeping Assist is only an aid. You are responsible for maintaining a safe distance to the vehicle in front, for vehicle speed, for braking in good time and for staying in lane.

The status of Active Lane Keeping Assist is displayed in the on-board computer:

-  (green): Active Lane Keeping Assist is active and operating.
-  (gray): Active Lane Keeping Assist is active but not operating.
- : Active Lane Keeping Assist is deactivated or there is a malfunction.



If a lane-correcting brake application occurs, display  appears in the multifunction display.

The system does not intervene if you activate the turn signal indicator. If the system detects an obstacle, such as another vehicle in the adjacent lane, it will intervene regardless of the turn signal indicator.

If you leave the lane without using the turn signal indicator but an obstacle is detected in your lane, the system will not intervene.

You are warned by vibrations in the steering wheel in the following circumstances:

- Active Lane Keeping Assist detects a lane marking.
- A front wheel drives over this lane marking.

#### Conditions for a course-correcting brake application (vehicles without Driving Assistance Package)

Lane markings were detected on both sides of the lane. The front wheel drives over a continuous lane marking.

-  A brake application may be interrupted at any time if you steer slightly in the opposite direction.

#### Conditions for a course-correcting brake application (vehicles with Driving Assistance Package)

- A continuous lane marking was detected and driven over with the front wheel.
- A lane marking and an approaching vehicle, an overtaking vehicle or vehicles driving parallel to your vehicle were detected in the adjacent lane. The front wheel drives over the lane marking.
-  A brake application may be interrupted at any time if you steer slightly in the opposite direction.

#### System limits

No lane-correcting brake application occurs in the following situations:

- You clearly and actively steer, brake or accelerate.

- If a driving safety system intervenes, such as ESP®, Active Brake Assist or Active Blind Spot Assist.
- You have adopted a sporty driving style with high cornering speeds or high rates of acceleration.
- When ESP® is deactivated.
- If a loss of tire pressure or a faulty tire has been detected and displayed.



If you deactivate the Active Lane Keeping Assist warning and the lane markings cannot be clearly detected, it is possible that no lane correcting brake application takes place (→ page 205).

The system may be impaired or may not function in the following situations:

- If there is poor visibility, e.g. due to insufficient illumination of the road, if there are highly variable shade conditions or in rain, snow, fog or heavy spray.
- If there is glare, e.g. from oncoming traffic, the sun or reflections.
- If the windshield in the area of the multifunction camera is dirty, or if the camera is fogged up, damaged or covered.
- If there are no lane markings, or several unclear lane markings are present for one lane, e.g. around roadworks.
- If the lane markings are worn, dark or covered.
- If the distance from the vehicle in front is too short and thus the lane markings cannot be detected.
- If the lane markings change quickly, e.g. lanes branch off, cross one another or merge.
- If the road is very narrow and winding.
- **Vehicles with Driving Assistance Package:** if the radar sensors in the rear bumper are dirty or covered in snow and an obstacle is detected in your lane, no lane-correcting brake application takes place.

### Activating/deactivating Active Lane Keeping Assist

Multimedia system:

  **» Settings** **» Quick Access**  
**» Active Lane Keeping Assist**

 Activate or deactivate the function.

### Setting Active Lane Keeping Assist

Multimedia system:

  **» Settings** **» Assistance**  
**» Active Lane Keeping Assist**

### Setting the sensitivity

 The availability of this function is dependent on the country.

 Select **Standard**, **Sensitive** or **Off**.

### Activating or deactivating the haptic warning

 Select **Warning**.  
Activate or deactivate the function.

### Vehicle towing instructions

The vehicle is not suitable for the use of tow bar systems that are used for flat towing or dinghy

## 206 Driving and parking

---

towing, for example. Attaching and using tow bar systems can lead to damage on the vehicle. When you are towing a vehicle with tow bar systems, safe driving characteristics cannot be guaranteed for the towing vehicle or the towed vehicle. The vehicle-trailer combination may swerve from side to side. Comply with the permitted towing methods (→ page 256) and the instructions for towing with both axles on the ground (→ page 257).



### Notes on the Instrument Display and on-board computer

#### **▲ WARNING** Risk of accident due to an Instrument Display malfunction

If the Instrument Display has failed or malfunctioned, the function restrictions applying to safety relevant systems are not visible.

The operating safety of your vehicle may be impaired.

- ▶ Drive on carefully.
- ▶ Have the vehicle checked immediately at a qualified specialist workshop.

#### **▲ WARNING** Risk of distraction from information systems and communications equipment

If you operate information and communication equipment integrated in the vehicle when driving, you will be distracted from the traffic situation. This could also cause you to lose control of the vehicle.

- ▶ Only operate this equipment when the traffic situation permits.
- ▶ If you cannot be sure of this, stop the vehicle whilst paying attention to road and traffic conditions and operate the equipment with the vehicle stationary.

You must observe the legal requirements for the country in which you are currently driving when operating the on-board computer.

The on-board computer shows only display messages and warnings from specific systems on the multifunction display. You must therefore ensure that your vehicle is always reliable.

If the operating safety of your vehicle is impaired, park the vehicle immediately and safely. Contact a qualified specialist workshop.

**Mercedes-AMG vehicles:** be sure to observe the notes in the Supplement. You could otherwise fail to recognize dangers.

### Instrument Display overview

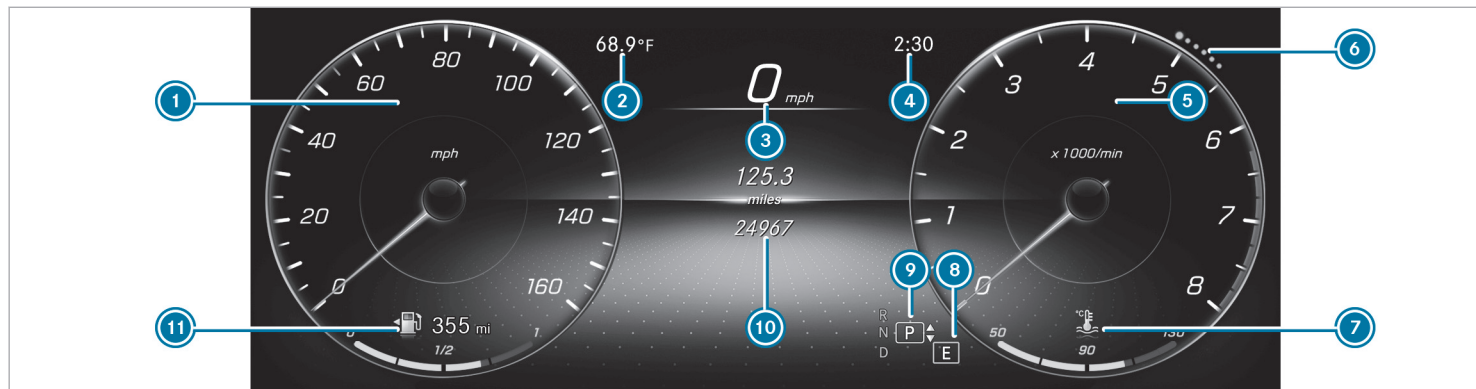

- ① Display content on left (example: speedometer): speedometer/time/date/trip computer **From Start** and **From Reset**/range/audio  
The segments on the speedometer indicate the status of the following systems: cruise control/limiter/Active Distance Assist DISTRONIC
- ② Outside temperature

- ③ Digital speedometer
- ④ Time
- ⑤ Display content on right (example: tachometer): tachometer/average fuel consumption/ECO display/navigation/G-meter/assistant display

- ⑥ Index points  
These show the selected display or menu content.
  - ⑦ Coolant temperature display
- The fuel supply will be interrupted to protect the engine when the red mark on the tachometer (overrevving range) is reached.



The coolant temperature display is permitted to rise to 248°F during normal operation. Vehicles with 48 V on-board electrical system: POWER and CHARGE display (electrical drive support and recuperation power of the electric motor)

- ⑧ Selected drive program
- ⑨ Selected transmission position
- ⑩ Multifunction display (example: standard display for trip): Assistance/Telephone/Navigation/Trip/Media/Radio/Styles and displays/Service
- ⑪ Fuel level, fuel filler flap location indicator, range

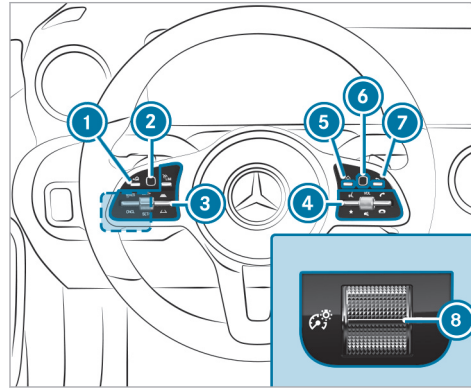
### Overview of the buttons on the steering wheel



- ①  Back/Home button (press and hold), on-board computer
- ② Touch Control, on-board computer
- ③ Control panel for cruise control or Active Distance Assist DISTRONIC

- ④ Control panel for the MBUX multimedia system (→ page 211)
  -  Voice control
- ⑤  To call up the home screen of the multimedia system
- ⑥ Touch Control multimedia system
- ⑦  Back button (multimedia system)
- ⑧ Brightness control to adjust the lighting in the Instrument Display and in the control elements of the vehicle interior

### Operating the on-board computer

Observe the legal requirements for the country in which you are currently driving when operating the on-board computer.

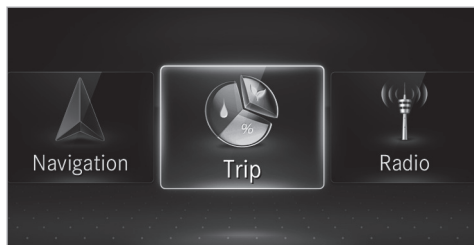

The on-board computer is operated using the left-hand Touch Control and the left-hand back/home button.

When the on-board computer is being operated, different acoustic signals will sound as operating feedback, e.g. when the end of a list is reached or when you are scrolling through a list.

The following menus are available:

- Assistance
- Phone
- Trip
- Radio
- Media

- Service
- Driving Dynam

**i** You can find information about the possible settings and selections on the menus in the Digital Operator's Manual.

**▶ To call up the menu bar:** press the left-hand back button until the menu bar is displayed.

**i** **Vehicles without Active Distance Assist DISTRONIC:** press the  button to call up the menu bar of the on-board computer.

**▶ To scroll in the menu bar:** swipe left or right on the left-hand Touch Control.











**▶ To call up a menu, submenu or possible settings on the menu, or confirm a selection or setting:** press the left-hand Touch Control.

**▶ To scroll through displays or lists on the menu, or select display content, a function, an entry or a display:** swipe upwards or downwards on the left-hand Touch Control.

**▶ To exit a submenu:** press the left-hand back button.

### Overview of what is shown on the multi-function display

Also shown on the multifunction display:

-  Active Parking Assist (→ page 195)
-  Parking Assist PARKTRONIC deactivated (→ page 188)
-  DSR (→ page 173)
-  Cruise control (→ page 171)
-  Active Distance Assist DISTRONIC (→ page 174)
-  Active Brake Assist (→ page 166)
-  Active Steering Assist (→ page 179)
-  Active Lane Keeping Assist (→ page 203)
-  ECO start/stop function (→ page 142)
-  HOLD function (→ page 182)
-  Adaptive Highbeam Assist (→ page 117)

## Overview and operation

### Notes on the MBUX multimedia system

**⚠ WARNING** Risk of distraction from information systems and communications equipment

If you operate information and communication equipment integrated in the vehicle when driving, you will be distracted from the traffic situation. This could also cause you to lose control of the vehicle.

- ▶ Only operate this equipment when the traffic situation permits.
- ▶ If you cannot be sure of this, stop the vehicle whilst paying attention to road and traffic conditions and operate the equipment with the vehicle stationary.

You must observe the legal requirements for the country in which you are currently driving when operating the multimedia system.

### Overview of the MBUX multimedia system

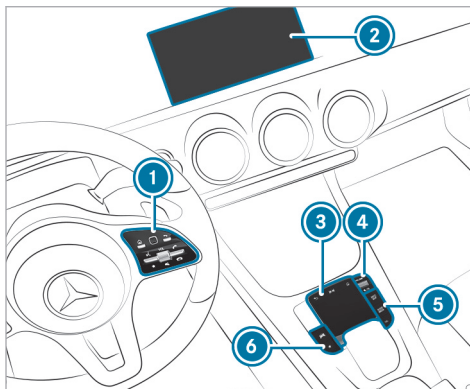

- ① Touch Control and control panel for the MBUX multimedia system
- ② Media display with touch functionality
- ③ Touchpad
- ④ Controller  
Turning: adjusts the volume

Press briefly: switches the mute function on/off

Press and hold: switches the multimedia system or media display on or off

⑤ Buttons for navigation, radio/media and telephone

⑥ Buttons for vehicle functions/system settings and favorites/themes

Further operating options:

- Conducting a voice dialog with the Voice Control System.
  - Operating functions contact-free with the MBUX Interior Assistant.
- ① You can find further information about operation as well as about applications and services in the Digital Operator's Manual.

#### Anti-theft protection

This device is equipped with technical provisions to protect it against theft. Further information on protection against theft can be obtained from an authorized Mercedes-Benz Center.

### Home screen overview

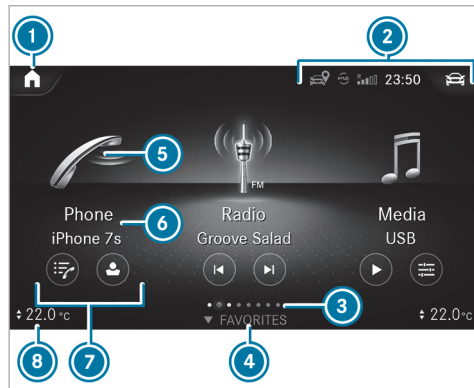

- ① Depending on the display, calls up the first three applications or the home screen
- ② Displays, for example network display, signal strength of the mobile phone network, time Quickly switches driving systems on or off
- ③ Index points and selected display area

- ④ Calls up **FAVORITES**
- ⑤ Calls up an application using the symbol
- ⑥ Application and current information
- ⑦ Quick-access, e.g. display call lists and searches for contacts
- ⑧ Calls up the air conditioning menu

### Operating the MBUX multimedia system

#### Using Touch Control

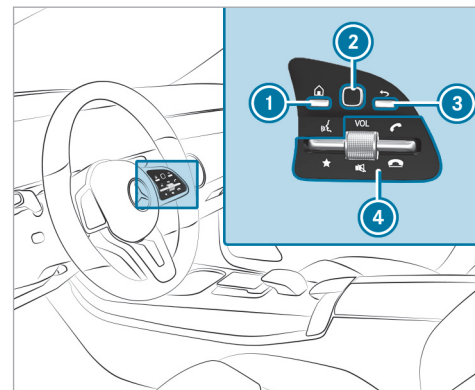



- ① Calls up the home screen
- ② Touch Control
- ③ Pressing briefly: returns to the previous display
- ④ Pressing the rocker switch down briefly: shows favorites

★ Pressing the rocker switch down and holding: adds favorites and themes

VOL: control adjusts the volume or switches the sound off  (press)

 Pressing the rocker switch up: makes or accepts a call

 Pressing the rocker switch down: rejects or ends a call

Navigation through the menus is carried out with Touch Control  with single-finger swipes.

- ▶ **To select a menu option:** swipe and press.
- ▶ **To move the digital map:** swipe in any direction.

### Using the touchscreen



- ▶ Select menu options, symbols or characters by pressing briefly.
- ▶ **To navigate in menus:** swipe up, down, left or right.
- ▶ **To use handwriting to enter characters:** write the character with one finger on the touchscreen.

▶ **To zoom in and out of the map:** move two fingers together or apart.

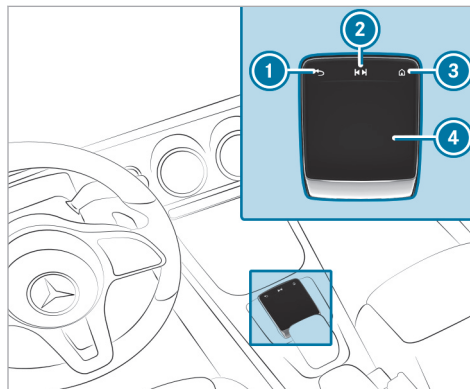

▶ **To call up the global menu:** press and hold on the touchscreen until the **OPTIONS** menu appears.

### Using the touchpad



-  Returns to the previous display
-  Calls up the audio control menu

Swiping to the left of right: selects the previous or next radio station/music track

-  Calls up the home screen
-  Touchpad

- ▶ **To select a menu option:** swipe and press.
- ▶ **To use handwriting recognition:** write a character on the touchpad.
- ▶ **To open or close the Notifications Center:** swipe down or up with two fingers.
- ▶ **To zoom in and out of the map:** move two fingers together or apart.

### Calling up applications using buttons

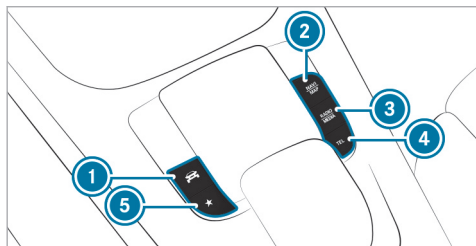

- ① Calls up vehicle functions
- ② Calls up navigation
- ③ Calls up radio or media
- ④ Calls up the telephone
- ⑤ Press briefly: calls up favorites  
Press and hold: adds a favorite or theme

▶ Alternatively, tap on the touchscreen.  
or

▶ Press the button on the Touch Control or on the touchpad.  
The home screen appears.

▶ Call up the application (→ page 212).

### System settings

#### Overview of the system settings menu

In the system settings menu, you can make settings in the following menus and control elements:

- Display
  - Styles
  - Instrument lighting
  - Display brightness
  - Edge lighting
  - Day/night design
- Control elements
  - Keyboard language and handwriting recognition
  - Touchpad sensitivity
  - Sensitivity of the Touch Controls
- Voice Control System
- MBUX Interior Assistant
- Sound
  - Entertainment
  - Navigation and traffic announcements
  - Telephone
  - Voice amplification to the rear passenger compartment
- Connectivity
  - Wi-Fi, Bluetooth, NFC
- MBUX Remote Control
  - Authorizing and de-authorizing devices
- Time & date
- Language
- Units for distance
- Software updates
- Data import/export
- PIN protection
- System Reset



### Information on important system updates

Important system updates may be necessary for the security of your multimedia system's data. Install these updates, or else the security of your multimedia system cannot be ensured.

A system update consists of three steps:

- Downloading or copying of the data required for installation
- Installation of the downloaded system update
- Activation of the downloaded system update by restarting the system

**i** If automatic software updates are activated, the system updates will be downloaded automatically.

The multimedia system provides a message when a system update is available.

You have the following selection options:

- **Accept and Install**  
The system update will be downloaded in the background.
- **Information**

Information about the pending system update is displayed.

- **Later**

The system update can be downloaded manually at a later time.

### Deep system updates

Deep system updates access vehicle or system settings and can therefore only be carried out when the vehicle is stationary and the ignition is switched off.

If the download of a deep system update is completed and the downloaded system update is ready for installation, you will be informed of this after the next ignition cycle, for example.

**i** Park the vehicle safely in a suitable location before starting the installation.

Requirements for the installation:

- The ignition is switched off.
- Notes and warnings have been read and accepted.
- The electric parking brake is applied.

If all requirements have been fulfilled, the downloaded system update is installed. The multimedia system cannot be operated while the downloaded system update is being installed and vehicle functions are restricted.

If errors should occur during the installation, the multimedia system automatically attempts to restore the previous version. If restoration of the previous version is not possible, a symbol appears on the media display. Consult a qualified specialist workshop to resolve the problem.

### Setting up a Wi-Fi hotspot

**Requirements:**

- **To set up the Wi-Fi connection of the multimedia system with external hotspots:** there is no communication module installed.
- The device to be connected supports at least one of the types of connection described.

Multimedia system:

-  ▶ Settings ▶ System
- ▶ Wi-Fi & Bluetooth

### Activating/deactivating Wi-Fi

- ▶ Select [Wi-Fi](#).

### Connecting the multimedia system with an external hotspot using Wi-Fi

The type of connection established must be selected on the multimedia system and on the device to be connected.

- ⓘ The connection procedure may differ depending on the device. Follow the instructions that are shown in the display. Further information can be found in the manufacturer's operating instructions.

- ▶ Select [Internet Settings](#).
- ▶ Select [Connect via Wi-Fi](#).
- ▶ Select [Add Hotspot](#).

### Connecting using a security key

- ▶ Select the options  of the desired Wi-Fi network.

- ▶ Select [Connect Using Security Key](#).
- ▶ Have the security key displayed on the device to be connected (see the manufacturer's operating instructions).
- ▶ Enter this security key on the multimedia system.
- ▶ Confirm the entry with .

### Connecting using a WPS PIN

- ▶ Select the options  of the desired Wi-Fi network.
- ▶ Select [Connect via WPS PIN Input](#).  
The multimedia system generates an eight-digit PIN.
- ▶ Enter this PIN on the device to be connected.
- ▶ Confirm the entry.

### Connecting using a button

- ▶ Select the options  of the desired Wi-Fi network.
- ▶ Select [Connect via WPS PBC](#).

- ▶ Select "Connect via WPS PBC" in the options on the device to be connected (see the manufacturer's operating instructions).
- ▶ Press the WPS button on the device to be connected.
- ▶ Select [Continue](#) in the multimedia system.

### Activating automatic connection

- ▶ Select [Connect via Wi-Fi](#).
- ▶ Select the options  of the desired Wi-Fi network.
- ▶ Activate [Permanent Internet Connection](#).

### Connecting with a known Wi-Fi

- ▶ Select [Connect via Wi-Fi](#).
- ▶ Select a Wi-Fi network.  
The connection is established again.

### Configuring the multimedia system as a Wi-Fi hotspot for external devices

The type of connection established depends on the device to be connected. The function must be supported by the multimedia system and by the device to be connected. The type of connection established must be selected on the multi-

media system and on the device to be connected.

- ▶ Select [Vehicle Hotspot](#).
- ▶ Select [Connect Device to Vehicle Hotspot](#).

#### Connecting using WPS PIN generation

- ▶ Select [Connect via WPS PIN Generation](#).
- ▶ Enter the PIN shown in the media display on the device to be connected and confirm.

#### Connecting using WPS PIN entry

- ▶ Select [Connect via WPS PIN Input](#).
- ▶ Enter the PIN that is shown on the external device's display on the multimedia system.

#### Connecting using a button

- ▶ Select [Connect via WPS PBC](#).
- ▶ Press the push button on the device to be connected (see the manufacturer's operating instructions).
- ▶ Select [Continue](#).

#### Connecting using a security key

- ▶ Select [Connect Device to Vehicle Hotspot](#). A security key is displayed.
- ▶ Select the vehicle from the device to be connected. The vehicle is displayed with the **MB Hotspot XXXXX** network name.
- ▶ Enter the security key which is shown in the media display on the device to be connected.
- ▶ Confirm the entry.

#### Connecting using NFC

- ▶ Select [Connect via NFC](#).
- ▶ Activate NFC on the mobile device (see the manufacturer's operating instructions).
- ▶ Bring the mobile device into the NFC interface of the vehicle.
- ▶ Select [Finished](#). The mobile device is now connected to the multimedia system hotspot via NFC.

#### Generating a new security key

- ▶ Select [Vehicle Hotspot](#).

- ▶ Select [Generate Security Key](#). A connection will be established with the newly created security key.
- ▶ **To save a security key:** select [Save](#). When a new security key is saved, all existing Wi-Fi connections are then disconnected. If the Wi-Fi connections are being re-established, the new security key must be entered.

## Telephone

### Telephony

#### Notes on telephony

**⚠ WARNING** Risk of distraction from operating integrated communication equipment while the vehicle is in motion

If you operate communication equipment integrated in the vehicle when driving, you will be distracted from the traffic situation. This could also cause you to lose control of the vehicle.

- ▶ Only operate this equipment when the traffic situation permits.
- ▶ If you cannot be sure of this, stop the vehicle whilst paying attention to road and traffic conditions and operate the equipment with the vehicle stationary.

**⚠ WARNING** Risk of an accident from operating mobile communication equipment while the vehicle is in motion

Mobile communications devices distract the driver from the traffic situation. This could also cause the driver to lose control of the vehicle.

- ▶ As the driver, only operate mobile communications devices when the vehicle is stationary.
- ▶ As a vehicle occupant, only use mobile communications devices in the areas intended for this purpose, e.g. in the rear passenger compartment.

You must observe the legal requirements for the country in which you are currently driving when

operating mobile communication equipment in the vehicle.

**⚠ WARNING** Risk of injury due to objects being stowed incorrectly

If objects in the vehicle interior are stowed incorrectly, they can slide or be thrown around and hit vehicle occupants. In addition, cup holders, open stowage spaces and mobile phone receptacles cannot always retain all objects within.

There is a risk of injury, particularly in the event of sudden braking or a sudden change in direction.

- ▶ Always stow objects so that they cannot be thrown around in such situations.
- ▶ Always make sure that objects do not protrude from stowage spaces, parcel nets or stowage nets.
- ▶ Close the lockable stowage spaces before starting a journey.
- ▶ Always stow and secure heavy, hard, pointed, sharp-edged, fragile or bulky

objects in the trunk /cargo compartment.

Observe the additional information on stowing mobile communications devices correctly:

- Loading the vehicle (→ page 98)
- Stowing and securing the mobile phone (→ page 112)

**Bluetooth® connection:**

The menu view and the available functions in the telephone menu are in part dependent on the Bluetooth® profile of the connected mobile phone. Full functionality is only available if the mobile phone supports both of the following Bluetooth® profiles:

- PBAP (Phone Book Access Profile)
  - The contacts on the mobile phone are shown automatically on the multimedia system.
- MAP (Message Access Profile)
  - The mobile phone message functions can be used on the multimedia system.

Irrespective of this, Bluetooth® audio functionality can be used with any mobile radio unit.

For information on the range of functions of the mobile radio unit to be connected, see the manufacturer's operating instructions.

#### **Network connection:**

The following cases can lead to the call being disconnected while the vehicle is in motion:

- You switch into a transmission/reception station, in which no communication channel is free.
- The SIM card used is not compatible with the network available
- a mobile phone with "Twincard" is logged into the network with the second SIM card at the same time

The multimedia system supports calls in HD Voice® for improved speech quality. A requirement for this is that the mobile phone and the mobile phone network provider of the person you are calling support HD Voice® .

Depending on the quality of the connection, the voice quality may fluctuate.

Further information can be obtained from an authorized Mercedes-Benz Center or at:  
<https://www.mercedes-benz.com/connect>

## Telephone menu overview

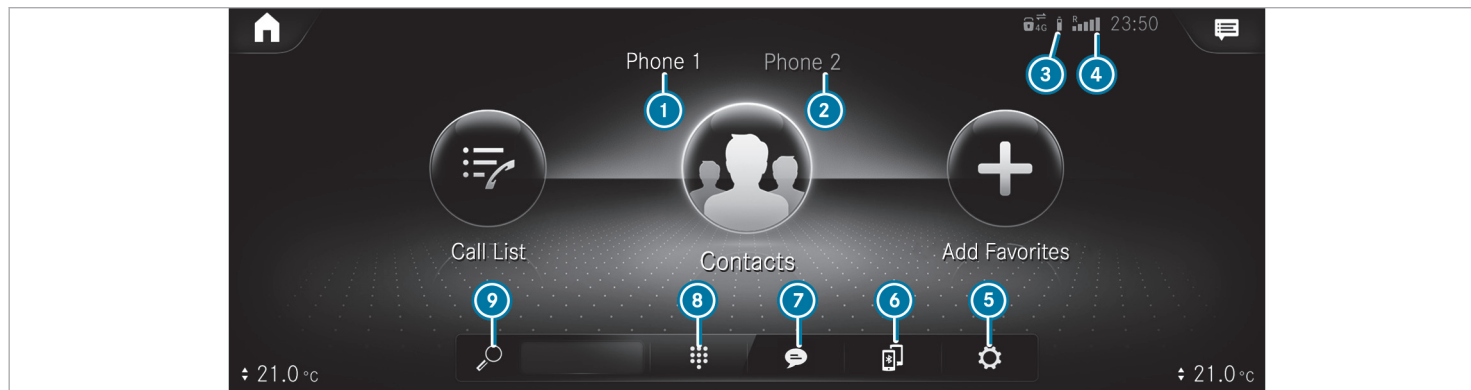

- ① Bluetooth® device name of the currently connected mobile phone/of the mobile phone
- ② Bluetooth® device name of the currently connected mobile phone/of the mobile phone (two phone mode)
- ③ Battery status of the connected mobile phone

- ④ Signal strength of the mobile phone network
- ⑤ Options
- ⑥ Device manager
- ⑦ Messages
- ⑧ Numerical pad
- ⑨ Contact search

## Telephony operating modes overview

Depending on your equipment, the following telephony operating modes are available:

- A mobile phone is connected to the multimedia system via Bluetooth®.

- Two mobile phones are connected with the multimedia system via Bluetooth® (two phone mode).
  - You can use all the functions of the multimedia system with the mobile phone in the foreground.
  - You can receive incoming calls and messages with the mobile phone in the background.

You can interchange the mobile phone in the foreground and background.

### Connecting a mobile phone

#### Requirements:

- Bluetooth® is activated on the mobile phone (see the manufacturer's operating instructions).
- Bluetooth® is activated on the multimedia system.

Multimedia system:



### Searching for a mobile phone

- ▶ Select .
- ▶ Select [Connect New Device](#).



### Connecting a mobile phone

Authorization follows using secure simple pairing.

- ▶ Select a mobile phone.  
A code is displayed in the multimedia system and on the mobile phone.
- ▶ If both codes match, confirm the code on the mobile phone.

### Functions in the telephony menu

In the telephony menu you have the following functions, for example:

- Making calls, e.g.:
  -  Accept a call
  -  [End Call](#)
  -  [Create Conf. Call](#)
  - Accepting or rejecting a waiting call

- Managing contacts, e.g.:
  - Downloading mobile phone contacts
  - Managing the format of a contact's name
  - Saving a contact as a favorite
- Receiving and sending messages, e.g.:
  - Using the read-aloud function
  - Dictating a new message

### Mercedes-Benz emergency call system

#### Information on the Mercedes-Benz emergency call system

Your vehicle is equipped with the Mercedes-Benz emergency call system ("eCall"). This feature can help save lives in the event of an accident. eCall in no way replaces assistance provided from dialing 911.

Mercedes-Benz eCall only functions in areas where mobile phone coverage is available from the wireless service providers. Insufficient network coverage from the wireless service providers may result in an emergency call not being transmitted.

eCall is a standard feature in your Mercedes-Benz vehicle. In order to function as intended, the system relies on the transmission of data detailed in the "Mercedes-Benz emergency call system data transmission" section that follows (→ page 224).

To disable eCall, a customer must visit an authorized Mercedes-Benz Service department to deactivate the vehicle's communication module.

**Deactivation of this module prevents the activation of any and all Mercedes me connect services. After the deactivation of eCall, automatic emergency call and manual emergency call will not be available.**

The ignition must be switched on before an automatic emergency call can be made.

- ① eCall is activated at the factory.
- ① eCall can be deactivated by an authorized Mercedes-Benz dealer. Please note that in the event ownership of the vehicle is transferred to another owner in its deactivated state, eCall will remain deactivated unless the new owner visits an authorized

Mercedes-Benz dealership to reactivate the system.

### Overview of the Mercedes-Benz emergency call system

---

eCall can help to reduce the time between an accident and the arrival of emergency services at the site of the accident. It helps locate an accident site in places that are difficult to access. However, even if a vehicle is equipped with eCall, this does not mean the system is ON. As such, eCall does not replace dialing 911 in the event of an accident.

An emergency call can be made automatically (→ page 222) or manually (→ page 223) Only make emergency calls if you or others are in need of rescue.

Only make emergency calls if you or others are in need of rescue. Do not make an emergency call in the event of a breakdown or a similar situation.

### Messages on the display

**SOS NOT READY:** the ignition is not on or eCall not available.

During an active emergency call,  appears in the display.

You can find more information on the regional availability of eCall at: <https://www.mercedes-benz-mobile.com/extra/ecall/>

- ① If there is a malfunction in the Mercedes-Benz emergency call system (e.g. a fault with the speaker, microphone, airbag, SOS button), a corresponding message appears in the multifunction display of the instrument cluster.

### Triggering an automatic Mercedes-Benz emergency call

---

#### Requirements:

- The ignition is switched on.
- The starter battery is sufficiently charged.



The Mercedes-Benz emergency call system triggers an emergency call automatically in the following cases:

- After activation of the restraint systems such as airbags or Emergency Tensioning Devices after an accident

The emergency call has been made:

- A voice connection is made to the Mercedes-Benz emergency call center.
- A message with accident data is transmitted to the Mercedes-Benz emergency call center. The Mercedes-Benz emergency call center can transmit the vehicle position data to one of the emergency call centers.

The SOS button in the overhead control panel flashes until the emergency call is finished.

It is not possible to immediately end an automatic emergency call.

If no connection can be made to the emergency services either, a corresponding message appears in the media display.

- ▶ Dial the local emergency number on your mobile phone.

If an emergency call has been initiated:

- Remain in the vehicle if the road and traffic conditions permit you to do so until a voice connection is established with the emergency call center operator.
- Based on the call, the operator decides whether it is necessary to call rescue teams and/or the police to the accident site.
- If no vehicle occupant answers, an ambulance is sent to the vehicle immediately.

### Triggering a manual Mercedes-Benz emergency call

- ▶ **To use the SOS button in the overhead control panel:** press and hold the SOS button for at least one second .

The emergency call has been made:

- A voice connection is made to the Mercedes-Benz emergency call center.

- A message with accident data is transmitted to the Mercedes-Benz emergency call center. The Mercedes-Benz emergency call center can transmit the vehicle position data to one of the emergency call centers.
- Remain in the vehicle if the road and traffic conditions permit you to do so until a voice connection is established with the emergency call center operator.
- Based on the call, the operator decides whether it is necessary to call rescue teams and/or the police to the accident site.

If no connection can be made to the emergency services either, a corresponding message appears in the media display.

- ▶ Dial the local emergency number on your mobile phone.

### Ending an unintentionally triggered manual Mercedes-Benz emergency call

- ▶ **On the multifunction steering wheel:** select . Depress the button for several seconds.

### Data transfer of the Mercedes-Benz emergency call system

---

In the event of an automatic or manual emergency call the following data is transmitted, for example:

- Vehicle's GPS position data
- GPS position data on the route ( a few hundred meters )before the incident)
- Direction of travel
- Vehicle identification number
- Vehicle drive type
- Number of people determined to be in the vehicle
- Whether Mercedes me connect is available or not
- Whether the emergency call was initiated manually or automatically
- Time of the accident
- Language setting on the multimedia system

Data transmitted is vehicle information. For any questions about the collection, use and sharing of the eCall system data, please contact MBU-

SA's Customer Assistance Center at 800-FOR-MERC.

For Canada, please contact MBC's Customer Assistance Center at 1-800-387-0100.









Customer requests for covered information should be submitted via the same channels.





For accident clarification purposes, the following measures can be taken up to an hour after the emergency call has been initiated:

- The current vehicle position can be determined.
- A voice connection to the vehicle occupants can be established.

## Radio &amp; media

## Overview of the symbols and functions in the media menu

| Symbol  | Designation        | Function   |
|---|--------------------|--|
|  | Play               | Select to start or continue playback.  |
|  | Rest               | Select to pause the playback.  |
|  | Repeating a track  | Select to repeat the current track or the active playlist. <ul style="list-style-type: none"> <li>• Select once: the active playlist is repeated.</li> <li>• Select twice: the current track is repeated.</li> <li>• Select three times: the function is deactivated.</li> </ul> |
|  | Random playback    | Select to play back tracks in random order.  |
|  | Skip forwards/back | Select to skip to the next or to the previous track.   |
|  | Options            | Select to show additional options.   |
|  | Categories         | Select to show or search through available categories (e.g. playback lists, albums, artists, etc.).  |
|  | Search             | Select to search in the active menu. You can search for artists, genres, moods or videos, for example.   |

| Symbol  | Designation | Function                             |
|---|-------------|--------------------------------------|
|  | Settings    | Select to make settings.             |
|  | Home        | Select to return to the home screen. |
|  | Messaging   | Select to call up messaging.         |
|  | Full screen | Select to switch to full screen mode |

#### The following functions and settings are available in the media menu:

- Connecting external data storage media with the multimedia system (e.g. using USB or Bluetooth®)
- Playing back audio files

#### Authorizing a Bluetooth® audio device for media playback

##### Requirements:

- Bluetooth® is activated on the multimedia system and audio equipment.

- The audio equipment supports the Bluetooth® audio profiles A2DP and AVRCP.
- The audio equipment is "visible" for other devices.

Multimedia system:



With Bluetooth® audio, you can play back music files from an external data storage medium, e.g. your smartphone, using the MBUX multimedia system.

- ▶ To play back audio files using the multimedia system, authorize the external data storage medium on the MBUX multimedia system.







#### Authorizing a new Bluetooth® audio device



- ▶ Select **Connect New Device**.
- ▶ Select an audio device. Authorization starts. A code is displayed on the multimedia system and on the mobile phone.
- ▶ If the codes are identical, confirm on the audio equipment.

#### Connecting previously authorized Bluetooth® audio equipment

- ▶ Select a Bluetooth® audio device from the list. The connection is being established.

### Overview of the symbols and functions in the radio menu

| Symbol  | Designation            | Function  |
|---|------------------------|---|
|  | Home                   | Select to return to the home screen.  |
|  | Messaging              | Select to call up messaging.  |
|  | Skip forwards/back     | Select to skip to the next or to the previous station.  |
|  | Options                | Select to have further options shown. Settings can be made to the following additional functions, for example: <ul style="list-style-type: none"> <li>• Navigation and traffic announcements</li> <li>• Frequency Fix function</li> <li>• Radio additional text</li> <li>• Emergency warnings</li> </ul> The setting options are country-dependent. |
| HD  | HD radio               | Select to switch the HD radio function on or off.<br>This function is not available in all countries.   |
|  | Mute function          | Select to switch off the sound  |
|  | Storing radio stations | Select to save a station in the presets   |

| Symbol  | Designation  | Function   |
|---|--------------|--|
|  | Station list | Select to have the station list shown.   |
|  | Search       | Select to search in the active menu. You can search for artists, genres, moods or videos, for example. |

Depending on the frequency band selected, different functions are available to you.

Select the desired frequency band in the radio menu head runner.

## Sound settings

### Overview of functions in the sound menu

The setting options and functions available depend on the sound system installed. You can find out which sound system is installed in your vehicle in the Digital Operator's Manual.

#### Standard sound system and Advanced sound system

The following functions are available:

- Equalizer

- Treble, mid-range and bass
- Balance and fader
- Volume
  - Automatic adjustment

#### Burmester® surround sound system and Burmester® high-end 3D surround sound system

The following functions are available:

- Equalizer
  - Treble, mid-range and bass
- Balance and fader
- Sound focus
- VIP seats (Burmester® high-end 3D surround sound system)

- Sound profiles
- Volume
  - Automatic adjustment

## ASSYST PLUS service interval display

### Function of the ASSYST PLUS service interval display

The ASSYST PLUS service interval display on the Instrument Display provides information on the remaining time or distance before the next service due date.

You can hide this service display using the back button on the left-hand side of the steering wheel.

Depending on how the vehicle is used, the ASSYST PLUS service interval display may shorten the service interval, e.g. in the following cases:

- Mainly short-distance driving
- When the engine is often left idling for long periods
- In the event of frequent cold start phases

Mercedes-Benz recommends avoiding such operating conditions.

You can obtain information concerning the servicing of your vehicle from a qualified specialist

workshop, e.g. an authorized Mercedes-Benz Center.

### Displaying the service due date

On-board computer:

↳ Service ► ASSYST PLUS

The next service due date is displayed.

► **To exit the display:** press the back button on the left-hand side of the steering wheel.

Bear in mind the following related topic:

- Operating the on-board computer (→ page 209).

### Information on regular maintenance work

**!** **NOTE** Premature wear through failure to observe service due dates

Service work which is not carried out at the right time or incompletely can lead to increased wear and damage to the vehicle.

- Always observe the prescribed service intervals.
- Always have the prescribed service work carried out at a qualified specialist workshop.

### Special service requirements

The prescribed service interval is based on normal operation of the vehicle. Maintenance work will need to be performed more often if the vehicle is operated under arduous conditions or increased loads.

The ASSYST PLUS service interval display is only an aid. The driver of the vehicle bears responsibility as regards to whether maintenance work needs to be performed more often than specified based on the actual operating conditions and/or loads.

Examples of arduous operating conditions:

- regular city driving with frequent intermediate stops
- mainly short-distance driving

- frequent operation in mountainous terrain or on poor road surfaces
- when the engine is often left idling for long periods
- operation in particularly dusty conditions and/or if air-recirculation mode is frequently used

In these or similar operating conditions, have the interior air filter, engine air cleaner, engine oil and oil filter etc. changed more frequently. The tires must be checked more frequently if the vehicle is operated under increased loads. Further information can be obtained at a qualified specialist workshop.

### Battery disconnection periods

**The ASSYST PLUS service interval display can only calculate the service due date when the battery is connected.**

- ▶ Note down the service due date displayed on the instrument display before disconnecting the battery (→ page 229).

### Engine compartment

#### Opening/closing the hood

**⚠ WARNING** Risk of accident due to driving with the hood unlocked

The hood may open and block your view.

- ▶ Never release the hood when driving.
- ▶ Before every trip, ensure that the hood is locked.

**⚠ WARNING** Risk of accident and injury when opening and closing the hood

The hood may suddenly drop into the end position.

There is a risk of injury for anyone in the hood's range of movement.

- ▶ Open or close the hood only when there is nobody in the hood's range of movement.

**⚠ WARNING** Danger of burns when opening the hood

If you open the hood when the engine has overheated or during a fire in the engine compartment, you could come into contact with hot gases or other escaping operating fluids.

- ▶ Before opening the hood, allow the engine to cool down.
- ▶ In the event of a fire in the engine compartment, keep the hood closed and call the fire service.

**⚠ WARNING** Risk of injury due to moving parts

Components in the engine compartment may continue running or start up suddenly, even if the ignition is switched off.

Make sure of the following before performing tasks in the engine compartment:

- ▶ Switch the ignition off.



- ▶ Never reach into the danger zone surrounding moving components, e.g. the rotation area of the fan.
- ▶ Remove jewellery and watches.
- ▶ Keep items of clothing and hair away from moving parts.

**⚠ WARNING** Risk of injury from touching components under voltage

The ignition system and the fuel injection system work under high voltage. You could receive an electric shock.

- ▶ Never touch components of the ignition system or the fuel injection system when the ignition is switched on.

**⚠ WARNING** Risk of burns from hot component parts in the engine compartment

Certain components in the engine compartment can be very hot, e.g. the engine, the radiator and parts of the exhaust system.

- ▶ Allow the engine to cool down and only touch component parts described in the following.

**⚠ WARNING** Risk of injury from using the windshield wipers while the engine hood is open

When the engine hood is open and the windshield wipers are set in motion, you can be trapped by the wiper linkage.

- ▶ Always switch off the windshield wipers and ignition before opening the engine hood.

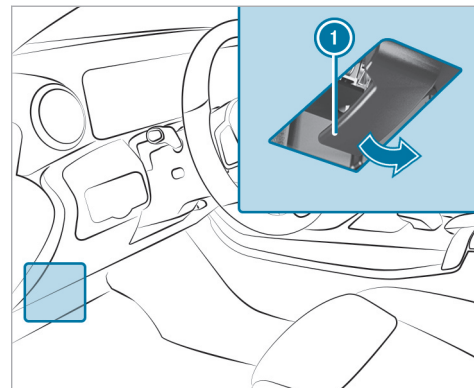

▶ **To open:** pull lever ① to release the hood.

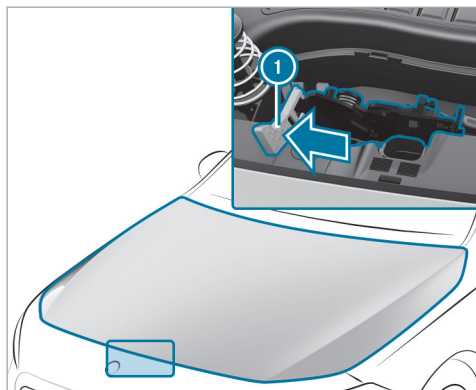

- ▶ Push yellow handle ① on the hood catch to the left as far as it will go (palm downwards). Lift the hood until it is automatically raised by the pneumatic spring.
- ▶ **To close:** lower the hood and let it fall from a height of approximately 8 in (20 cm).
- ▶ If the hood can still be lifted slightly, open the hood again and close it with a little force until it engages correctly.

## Engine oil

### Checking the engine oil level using the on-board computer

#### Requirements:

- The engine has been warmed up.
- The vehicle is parked on a level surface.
- The engine is running at idle speed.

The engine oil level is determined during driving. Determining the engine oil level can take up to 30 minutes with a normal driving style and even longer with an active driving style.

On-board computer:

↪ Service ▶▶ Engine Oil Level

You will see one of the following messages on the multifunction display:

- **Measuring Engine Oil Level...:** measurement of the oil level is not yet possible.
- ▶ Repeat the request after a maximum of 30 minutes' driving.
- **Engine Oil Level OK** and the bar display for indicating the oil level on the multifunction

display is green and is between "min" and "max": the oil level is correct.

- **Engine Oil Level Add 1,1 qts.** and the bar display for indicating the oil level on the multifunction display is orange and is below "min":
  - ▶ Add 1.1 US qt (1 l) of engine oil.
- **Reduce Engine Oil Level** and the bar display for indicating the oil level on the multifunction display is orange and is above "max":
  - ▶ Drain off any excess engine oil that has been added. To do so, consult a qualified specialist workshop.
- **For Engine Oil Level Switch Ignition On**
  - ▶ Switch on the ignition to check the engine oil level.
- **Engine Oil Level System Inoperative:** The oil level sensor is defective or not connected.
  - ▶ Consult a qualified specialist workshop.
- **Engine Oil Level System Currently Unavail.**
  - ▶ Close the hood.

## Adding engine oil

**⚠ WARNING** Risk of burns from hot component parts in the engine compartment

Certain components in the engine compartment can be very hot, e.g. the engine, the radiator and parts of the exhaust system.

- ▶ Allow the engine to cool down and only touch component parts described in the following.

**⚠ WARNING** Risk of fire and injury from engine oil

If engine oil comes into contact with hot component parts in the engine compartment, it may ignite.

- ▶ Make sure that no engine oil is spilled next to the filler opening.
- ▶ Allow the engine to cool off and thoroughly clean the engine oil from component parts before starting the vehicle.

**! NOTE** Engine damage caused by an incorrect oil filter, incorrect oil or additives

- ▶ Do not use engine oils or oil filters which do not correspond to the specifications explicitly prescribed for the service intervals.
- ▶ Do not alter the engine oil or oil filter in order to achieve longer change intervals than prescribed.
- ▶ Do not use additives.
- ▶ Follow the instructions in the service interval display regarding the oil change.

**! NOTE** Damage caused by refilling too much engine oil

Too much engine oil can damage the engine or the catalytic converter.

- ▶ Have excess engine oil removed at a qualified specialist workshop.

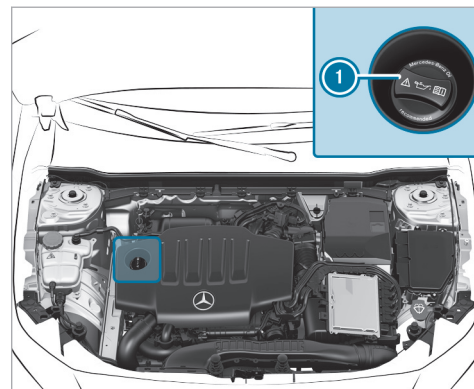

- ▶ Turn cap ① counter-clockwise and remove it.
- ▶ Add engine oil.
- ▶ Replace cap ① and turn it clockwise until it engages.
- ▶ Check the oil level again (→ page 232).

### Checking coolant level

**⚠ WARNING** Risk of burns from hot component parts in the engine compartment

Certain components in the engine compartment can be very hot, e.g. the engine, the radiator and parts of the exhaust system.

- ▶ Allow the engine to cool down and only touch component parts described in the following.

**⚠ WARNING** Risk of scalding from hot coolant

If you open the cap, you could be scalded.

- ▶ Let the motor cool down before opening the cap.
- ▶ When opening the cap, wear protective gloves and safety glasses.
- ▶ Open the cap slowly to release pressure.

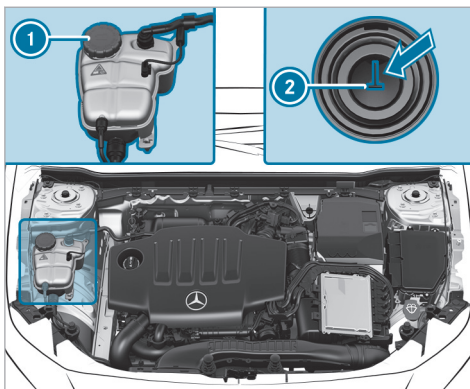

- ▶ Park the vehicle on a level surface.
- ▶ Check the coolant temperature display in the instrument cluster. The coolant temperature must be in the bottom quarter of the temperature display.
- ▶ Slowly turn cap ① counter-clockwise to release overpressure.

- ▶ Continue turning cap ① counter-clockwise and remove it.

The coolant level is correct in the following cases:

- If the engine is cold, the coolant is up to marker bar ②.
  - If the engine is warm, the coolant is up to 0.6 in (1.5 cm) over marker bar ②.
- ▶ If necessary, add coolant that has been approved for Mercedes-Benz.
  - Further information on coolant (→ page 303).

### Adding washer fluid to the windshield washer system

**⚠ WARNING** Risk of burns from hot component parts in the engine compartment

Certain components in the engine compartment can be very hot, e.g. the engine, the radiator and parts of the exhaust system.

- ▶ Allow the engine to cool down and only touch component parts described in the following.

**⚠ WARNING** Danger of burns when opening the hood

If you open the hood when the engine has overheated or during a fire in the engine compartment, you could come into contact with hot gases or other escaping operating fluids.

- ▶ Before opening the hood, allow the engine to cool down.
- ▶ In the event of a fire in the engine compartment, keep the hood closed and call the fire service.

**⚠ WARNING** - Risk of fire and injury from windshield washer concentrate

Windshield washer concentrate is highly flammable. It could ignite if it comes into contact with hot engine component parts or the exhaust system.

- ▶ Make sure that no windshield washer concentrate spills out next to the filler opening.

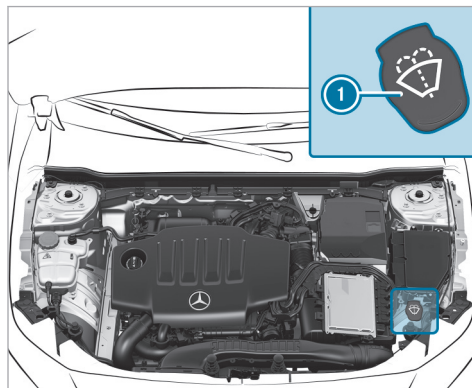

- ▶ Remove cap ① by the tab.
- ▶ Add washer fluid.

### Keeping the air-water duct free

- ▶ Keep the area between the hood and the windshield free of deposits, e.g. ice, snow and leaves.

### Cleaning and care

#### Notes on washing the vehicle in a car wash

**⚠ WARNING** Risk of accident due to reduced braking effect after washing the vehicle

The braking effect is reduced after washing the vehicle.

- ▶ After the vehicle has been washed, brake carefully while paying attention to the traffic conditions until the braking effect has been fully restored.

**!** NOTE Damage from automatic braking

If one of the following functions is switched on, the vehicle brakes automatically in certain situations:

- Active Brake Assist
- Active Distance Assist DISTRONIC
- HOLD function
- Active Parking Assist

To avoid damage to the vehicle, deactivate these systems in the following or similar situations:

- ▶ During towing
- ▶ In a car wash

**!** NOTE Damage due to unsuitable car wash

- ▶ Before driving into a car wash make sure that the car wash is suitable for the vehicle dimensions.

- ▶ Ensure there is sufficient ground clearance between the underbody and the guide rails of the car wash.
- ▶ Ensure that the clearance width of the car wash, in particular the width of the guide rails, is sufficient.

To avoid damage to your vehicle when using a car wash, ensure the following beforehand:

- Active Distance Assist DISTRONIC and the HOLD function are deactivated.
- The side windows and sliding sunroof are completely closed.
- The blower for the ventilation/heating is switched off.
- The windshield wiper switch is in position **0**.
- The SmartKey is at a minimum distance of 10 ft (3 m) away from the vehicle, otherwise the tailgate could open unintentionally.
- In car washes with a conveyor system: neutral **N** is engaged.

**i** In car washes with a conveyor system: if you would like to leave the vehicle while it is being washed, make sure the SmartKey is located in the vehicle. The park position **P** is otherwise automatically engaged.

**i** If, after the car wash, you remove the wax from the windshield and wiper rubbers, this will prevent smearing and reduce wiper noise.

**Automatic car wash mode**

In car wash mode, the vehicle is prepared for driving into the automatic car wash. Car wash mode can be activated at a speed of up to 12 mph (20 km/h) (→ page 237).

The following settings are made when car wash mode is activated:

- The outside mirrors are folded in.
- The rain sensor is deactivated to prevent the windshield washer system from starting up automatically.
- The rear window wiper is deactivated.
- The air conditioning system is set to air-recirculation mode.

- Parking Assist PARKTRONIC is deactivated.
- **Vehicles with surround view camera:** the front image is activated after approx. eight seconds.

If one of the settings cannot be selected, this is displayed by a  behind the respective setting.

Above a speed of 12 mph (20 km/h) car wash mode is automatically deactivated.

The following settings are reset when car wash mode is deactivated:

- The outside mirrors are folded out.
- The rain sensor is activated.
- The rear window wiper is activated.
- The air conditioning system is set to fresh air mode.
- Parking Assist PARKTRONIC is reset to the previously selected setting.
- **Vehicles with surround view camera:** the front image is deactivated at speeds above 11 mph (18 km/h).

### Activating/deactivating automatic car wash mode

#### Requirements:

- The vehicle is stationary.
- The engine is running.

Multimedia system:

  **Settings**  **Quick Access**

#### Activating automatic car wash mode

- ▶ Select **Automatic Car Wash Mode**.
- ▶ Select **Start**.

If one of the settings cannot be selected, this is displayed by a  behind the respective setting.

- ① For an overview of the settings made when activating automatic car wash mode (→ page 235).

#### Deactivating automatic car wash mode

- ▶ Select **Stop**.  
The automatic car wash settings are reset.

- ① The automatic car wash mode is automatically deactivated as soon as a speed of 12 mph (20 km/h) is exceeded.

### Notes on using a power washer

 **WARNING** Risk of an accident when using power washers with round-spray nozzles

The water jet can cause externally invisible damage.

Components damaged in this way may unexpectedly fail.

- ▶ Do not use a power washer with round-spray nozzles.
- ▶ Have damaged tires or chassis parts replaced immediately.

To avoid damage to your vehicle, observe the following when using a power washer:

- Keep the SmartKey at least 10 ft (3 m) away from the vehicle. Otherwise the tailgate could open unintentionally.

- Maintain a distance of at least 11.8 in (30 cm) to the vehicle.
- **Vehicles with decorative foil:** parts of your vehicle are covered with a decorative foil. Maintain a distance of at least 27.6 in (70 cm) between the foil-covered parts of the vehicle and the nozzle of the power washer. Move the power washer nozzle around whilst cleaning. The water temperature of the power washer must not exceed 140 °F (60 °C).
- Observe the information on the correct distance in the equipment manufacturer's operating instructions.
- Do not point the nozzle of the power washer directly at sensitive parts such as tires, gaps, electrical components, batteries, light sources and ventilation slots.

### Washing the vehicle by hand

Observe the legal requirements, e.g. in a number of countries, washing by hand is only permitted in specially designated wash bays.

- ▶ Use a mild cleaning agent, e.g. car shampoo.
- ▶ Wash the vehicle with lukewarm water using a soft car sponge. When doing so, do not expose the vehicle to direct sunlight.
- ▶ Carefully hose the vehicle off with water and dry using a chamois. Take care not to point the water jet directly towards the air inlet grille below the hood.

### Notes on paintwork/matte finish paintwork care

Observe the notes on cleaning and care to avoid damaging the paintwork.

#### **Paint**

- Insect remains: soak with insect remover and rinse off the treated areas afterwards.
- Bird droppings: soak with water and rinse off afterwards.
- Tree resin, oils, fuels and greases: remove by rubbing gently with a cloth soaked in petroleum ether or lighter fluid.
- Coolant and brake fluid: remove with a damp cloth and clean water.

- Tar stains: use tar remover.
- Wax: use silicone remover.
- Do not attach stickers, films or similar materials.
- Remove dirt immediately, where possible.

#### **Matte finish**

- Only use care products approved for Mercedes-Benz.
- Do not polish the vehicle and alloy wheels.
- Only use car washes that correspond to the latest engineering standards.
- Do not use car wash programs with a final hot wax treatment.
- Do not use paint cleaners, buffing or polishing products, gloss preservers, e.g. wax.
- Always have paintwork repairs carried out at a qualified specialist workshop.

### Notes on cleaning decorative foils

Observe the notes on matte finish care in the chapter "Notes on paintwork/matte finish paint-



work care" (→ page 238). They also apply to matte decorative foils.

Observe the notes on cleaning decorative foils to avoid vehicle damage.

### Cleaning

- For cleaning, use plenty of water and a mild cleaning agent without additives or abrasive substances, e.g. a car shampoo approved for Mercedes-Benz.
- Remove dirt immediately, where possible, whilst avoiding rubbing too hard. There is otherwise a risk of damaging the decorative foil irreparably.
- If there is dirt on the finish or if the decorative foil is dull: use the Paint Cleaner recommended and approved for Mercedes-Benz.
- Insect remains: soak with insect remover and rinse off the treated areas afterwards.
- Bird droppings: soak with water and rinse off afterwards.
- To prevent water stains, dry a foil-wrapped vehicle with a soft, absorbent cloth after every car wash.

### Avoiding damage to the decorative foil

- The service life and color of decorative foils are impaired by:
  - Sunlight
  - Temperature, e.g. hot air blower
  - Weather conditions
  - Stone chippings and dirt
  - Chemical cleaning agents
  - Oily products
- Do not use polish on matte decorative foil. Polishing will have the effect of shining the foil-wrapped surface.
- Do not treat matte or structured decorative foils with wax. Permanent stains may occur.

Scratches, corrosive deposits, areas affected by corrosion and damage caused by incorrect care cannot always be completely repaired. In such cases, visit a qualified specialist workshop.

You can obtain more information on care and cleaning products from the manufacturer.

In the case of foil-wrapped surfaces, optical differences may occur between the surfaces that

were not protected by a decorative foil after removing a decorative foil.

- ① Have work or repairs to decorative foils carried out at a qualified specialist workshop, e.g. at an authorized Mercedes-Benz Center.

### Notes on care of vehicle parts

**⚠ WARNING** Risk of entrapment if the windshield wipers are switched on while the windshield is being cleaned

If the windshield wipers are set in motion while you are cleaning the windshield or wiper blades, you can be trapped by the wiper arm.

- ▶ Always switch off the windshield wipers and the ignition before cleaning the windshield or wiper blades.

**⚠ WARNING** Risk of burns from the tailpipe and tailpipe trims

The exhaust tailpipe and tailpipe trims can become very hot. If you come into contact with these parts of the vehicle, you could burn yourself.

- ▶ Always be particularly careful around the tailpipe and the tailpipe trims and supervise children especially closely in this area.
- ▶ Allow vehicle parts to cool down before touching them.

Observe the notes on cleaning and care of the following vehicle parts to avoid damage.

### Wheels/rims

- Use water and acid-free wheel cleaners.
- Do not use acidic wheel cleaners to remove brake dust. This could damage wheel bolts and brake components.
- To avoid corrosion of the brake discs and brake pads, drive the vehicle for a few minutes after cleaning before parking it. The

brake discs and brake pads warm up and dry out.

### Windows

- Clean windows inside and outside with a damp cloth and with a cleaning agent recommended for Mercedes-Benz.
- Do not use dry cloths or abrasive or solvent-based cleaning agents to clean the inside of windows.

### Wiper blades

- Fold out the wiper blades and clean them using a damp cloth.
- Do not clean the wiper blades too often.

### Exterior lighting

- Clean the lenses with a wet sponge and mild cleaning agent, e.g. car shampoo.
- Only use cleaning agents or cleaning cloths that are suitable for plastic lenses.

### Sensors

- Clean the sensors in the front and rear bumper and in the radiator grill with a soft cloth and car shampoo.

- When using a power washer, maintain a minimum distance of 11.8 in (30 cm).

### Rear view camera and surround view camera

- Use clean water and a soft cloth to clean the camera lens.
- Do not use a power washer.

### Tailpipes

- Clean with a cleaning agent recommended for Mercedes-Benz, especially in the winter and after washing the vehicle.
- Do not use acidic cleaning agents.

### Notes on care of the interior

**⚠ WARNING** Risk of injury from plastic parts breaking off after the use of solvent-based care products

Care and cleaning products containing solvents can cause surfaces in the cockpit to become porous. When the airbags are deployed, plastic parts may break away.

- ▶ Do not use any care or cleaning products containing solvents to clean the cockpit.

**▲ WARNING** Risk of injury or death from bleached seat belts

Bleaching or dyeing seat belts can severely weaken them.

This can, for example, cause seat belts to tear or fail in an accident.

- ▶ Never bleach or dye seat belts.

Observe the notes on cleaning and care to avoid vehicle damage.

#### Seat belts

- Clean with lukewarm and soapy water.
- Do not use chemical cleaning agents.
- Do not dry seat belts by heating them to over 176 °F (80 °C) or exposing them to direct sunlight.

#### Display

- Switch off the display and let it cool down.

- Clean the surface carefully with a microfiber cloth and a suitable display care product (TFT/LCD).
- Do not use any other agents.

#### Plastic trim

- Clean with a damp microfiber cloth.
- For heavy soiling: use a care product recommended for Mercedes-Benz.
- Do not attach stickers, films or similar materials.
- Do not allow cosmetics, insect repellent or sun cream to come in contact with the plastic trim.

#### Real wood/trim elements

- Clean with a microfiber cloth.
- Black piano-lacquer look: clean with a damp cloth and soapy water.
- For heavy soiling: use a care product recommended for Mercedes-Benz.
- Do not use solvent-based cleaning agents, polishes or waxes.

#### Headliner

- Clean with a brush or dry shampoo.

#### Carpet

- Use a carpet and textile cleaning agent recommended for Mercedes-Benz.

#### Genuine leather seat covers

- Clean with a damp cloth and then wipe with a dry cloth.
- Leather care: use a leather care agent that has been recommended for Mercedes-Benz.
- Do not allow the leather to become too damp.
- Do not use a microfiber cloth.

#### DINAMICA seat covers

- Clean with a damp cloth.
- Do not use a microfiber cloth.

#### Imitation leather seat covers

- Clean with a damp cloth and 1% soapy water.
- Do not use a microfiber cloth.

## 242 Maintenance and care

---

### **Cloth seat covers**

- Clean with a damp microfiber cloth and 1% soap solution and allow to dry.

## Emergency

### Removing the safety vest

The safety vests are located in the storage compartments in the driver and front passenger door.

- ▶ **To remove:** pull out the safety vest bag by the loop.
- ▶ Open the safety vest bag and pull out the safety vest.

**i** There are also safety vest compartments in the rear door storage compartments in which safety vests can be stored.

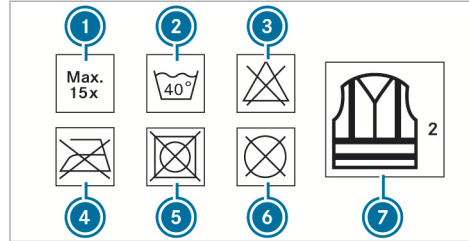

- ① Maximum number of washes
- ② Maximum wash temperature
- ③ Do not bleach
- ④ Do not iron
- ⑤ Do not tumble dry
- ⑥ Do not dry clean
- ⑦ Class 2 safety vest

The requirements defined by the legal standard are only fulfilled if the safety vest is the correct size and is fully closed.

The safety vest must be replaced in the following situations:

- the reflective strips are damaged or dirty

- the maximum permissible number of washes is exceeded
- the fluorescence has faded

### Warning triangle

#### Removing the warning triangle

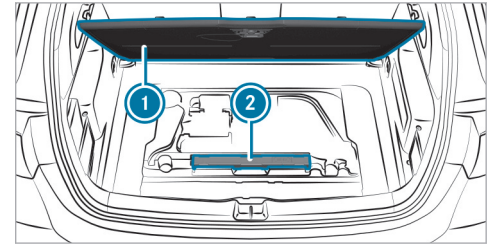

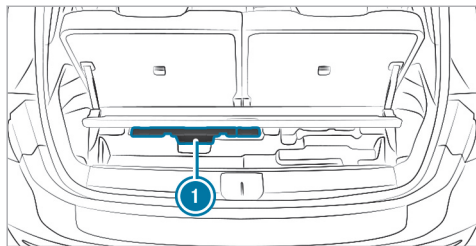

Vehicles with three rows of seats

- ▶ Open cargo compartment floor ①.
- ▶ Remove warning triangle ②.

### Setting up the warning triangle

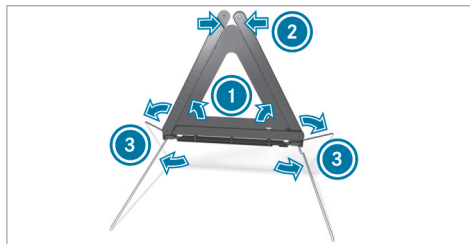

- ▶ Fold side reflectors ① upwards to form a triangle and attach at the top using upper press-stud ②.
- ▶ Fold legs ③ down and out to the side.

### First-aid kit (soft-sided) overview

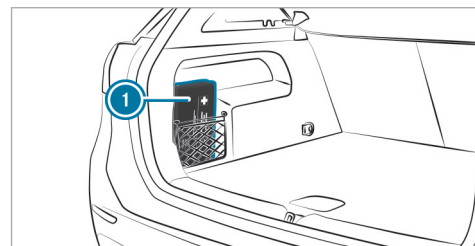

First-aid kit (soft sided) ① is in the cargo compartment in the left-hand storage net.

### Removing the fire extinguisher

**⚠ WARNING** Risk of accident due to an incorrectly secured fire extinguisher in the driver's footwell

A fire extinguisher may impede pedal travel or block a depressed pedal.

This jeopardizes the operating and road safety of the vehicle.

The fire extinguisher can be flung around and injure the driver or other vehicle occupants.

- ▶ Always store and secure the fire extinguisher in the bracket.
- ▶ Do not remove the fire extinguisher while driving.

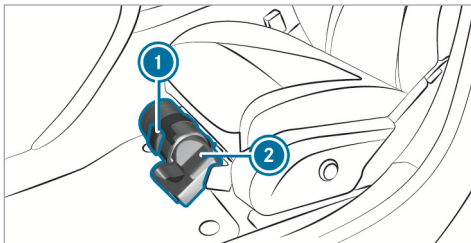

- ▶ **Left-hand drive vehicle:** Pull tab ① upwards.
- ▶ Remove fire extinguisher ②.

## Flat tire

### Notes in the event of a flat tire

**⚠ WARNING** Risk of accident due to a flat tire

A flat tire severely affects the driving characteristics as well as the steering and braking of the vehicle.

#### Tires without run-flat characteristics:

- ▶ Do not drive with a flat tire.
- ▶ Change the flat tire immediately with an emergency spare wheel or spare wheel. Alternatively, consult a qualified specialist workshop.

#### Tires with run-flat characteristics:

- ▶ Observe the information and warning notes on MOExtended tires (run-flat tire).

In the event of a flat tire, the following options are available depending on your vehicle's equipment:

- **Vehicles with MOExtended tires:** it is possible to continue the journey for a short period of time. Make sure you observe the notes on MOExtended tires (run-flat tires) (→ page 246).
  - **Vehicles with a TIREFIT kit:** you can repair the tire so that it is possible to continue the journey for a short period of time. To do this, use the TIREFIT kit (→ page 247).
  - **Vehicles with Mercedes me connect:** you can make a call for breakdown assistance via the overhead control panel in the case of a breakdown .
  - **All vehicles:** change the wheel (→ page 288).
- ① The emergency spare wheel is only available in certain countries.

### Notes on MOExtended tires (run-flat tires)

#### **▲ WARNING** Risk of accident when driving in limp-home mode

When driving in emergency mode the handling characteristics are impaired.

- ▶ Do not exceed the specified maximum speed of the MOExtended tires.
- ▶ Avoid any abrupt steering and driving maneuvers as well as driving over obstacles (curbs, pot holes, off-road). This applies, in particular, to a loaded vehicle.
- ▶ Stop driving in the emergency mode if you notice:
  - Banging noise
  - Vehicle vibration
  - Smoke which smells like rubber
  - Continuous ESP® intervention
  - Cracks in the tire side walls
- ▶ After driving in emergency mode, have the rims checked by a qualified special-

ist workshop with regard to their further use.

- ▶ The defective tire must be replaced in every case.

With MOExtended tires (run-flat tires), you can continue to drive your vehicle even if there is a total loss of pressure in one or more tires. However, the tire affected must not show any clearly visible damage.

You can recognize MOExtended tires by the MOExtended marking which appears on the side wall of the tire.

**Vehicles with tire pressure loss warning system:** MOExtended tires may only be used in conjunction with an activated tire pressure loss warning system.

**Vehicles with tire pressure monitoring system:** MOExtended tires may only be used in conjunction with an activated tire pressure monitoring system.

If a pressure loss warning message appears in the multifunction display, proceed as follows:

- Check the tires for damage.
- If driving on, observe the following notes.

#### **Driving distance possible in emergency mode after the pressure loss warning:**

| Load condition  | Driving distance possible in emergency mode |
|-----------------|---|
| Partially laden | 50 miles (80 km)                            |
| Fully laden     | 19 miles (30 km)                            |

The driving distance possible in emergency mode may vary depending on the driving style. Observe the maximum permissible speed of 50 mph (80 km/h).

If a tire has gone flat and cannot be replaced with an MOExtended tire, you can use a standard tire as a temporary measure.



### TIREFIT kit storage location

The TIREFIT kit is located under the cargo compartment floor.

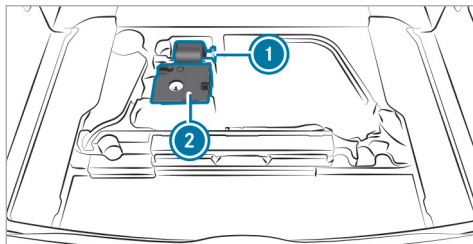

- ① Tire sealant bottle
- ② Tire inflation compressor

### Using the TIREFIT kit

#### Requirements:

Required tools:

- Tire sealant bottle
- TIREFIT sticker

- Sticker with details of the maximum permissible speed
- Tire inflation compressor
- Gloves

TIREFIT kit storage location: (→ page 247)

You can use TIREFIT tire sealant to seal perforation damage of up to 0.16 in (4 mm), particularly those in the tire contact surface. You can use TIREFIT in outside temperatures down to -4 °F (-20 °C).

#### **⚠ WARNING** Risk of accident when using tire sealant

The tire sealant may be unable to seal the tire properly, especially in the following cases:

- There are cuts or punctures in the tire larger than damage previously mentioned.
- The wheel rim is damaged.
- You have driven at very low tire pressure or on a flat tire.

- ▶ Do not continue driving.
- ▶ Consult a qualified specialist workshop.

#### **⚠ WARNING** Risk of injury and poisoning from tire sealant

The tire sealant is harmful and causes irritation. Do not allow it to come into contact with the skin, eyes or clothing, and do not swallow it. Do not inhale tire sealant fumes. Keep the tire sealant away from children.

If you come into contact with the tire sealant, observe the following:

- ▶ Rinse off the tire sealant from your skin immediately using water.
- ▶ If tire sealant gets into your eyes, thoroughly rinse out the eyes using clean water.
- ▶ If tire sealant has been swallowed, immediately rinse out the mouth thoroughly and drink plenty of water. Do not induce vomiting and seek medical attention immediately.

- ▶ Change out of any clothes contaminated with tire sealant immediately.
- ▶ If allergic reactions occur, seek medical attention immediately.

**!** **NOTE** Overheating due to the tire inflation compressor running too long

- ▶ Do not run the tire inflation compressor for longer than ten minutes without interruption.

Comply with the manufacturer's safety notes on the sticker on the tire sealant bottle.

Have the tire sealant bottle replaced in a qualified specialist workshop every five years.

- ▶ Do not remove any foreign objects which have entered the tire.



- ▶ Remove sticker 1 from the tire inflation compressor housing and affix it to the instrument cluster within the driver's field of vision.

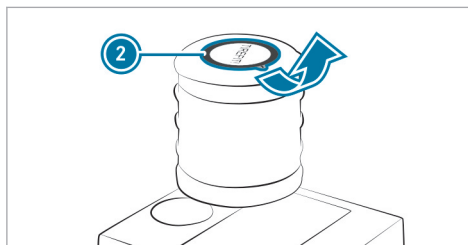

- ▶ Remove sticker 2 from the tire sealant bottle and affix it near the valve on the wheel with the faulty tire.

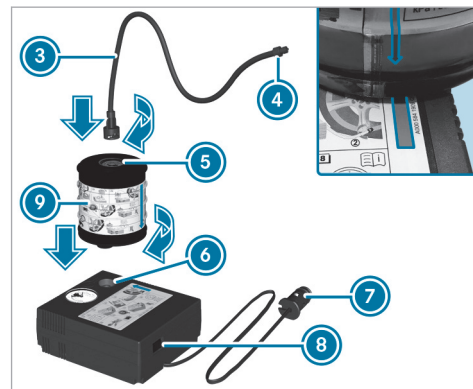

- ▶ Pull plug 7 with the cable and filler hose 3 out of the tire inflation compressor housing.
- ▶ Insert tire sealant bottle 9 in socket 6 of the tire inflation compressor in such a way that the red arrow on tire sealant bottle 9

- ▶ matches the red arrow on the tire inflation compressor.
- ▶ Turn tire sealant bottle ⑨ a quarter turn clockwise.
- ▶ Insert the plug of filler hose ③ in socket ⑤ of tire sealant bottle ⑨.
- ▶ Turn filler hose ③ a quarter turn clockwise.

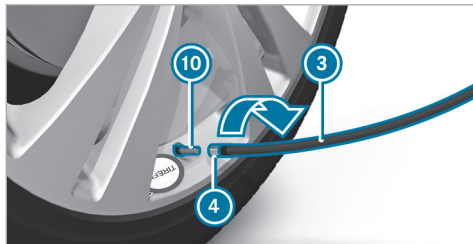

- ▶ Remove the valve cap from valve ⑩ on the faulty tire.
- ▶ Screw union nut ④ of filler hose ③ onto valve ⑩.

- ▶ Insert plug ⑦ into a 12 V socket in your vehicle.
- ▶ Turn the SmartKey to position ① in the ignition lock.
- ▶ Press on and off switch ⑧ on the tire inflation compressor. The tire inflation compressor is switched on. The tire is inflated. First, tire sealant is pumped into the tire. The pressure may briefly rise to approximately 500 kPa (5 bar/73 psi).

**Do not switch off the tire inflation compressor during this phase.**

- ▶ Let the tire inflation compressor run for a maximum of ten minutes. The tire should then have attained a tire pressure of at least 200 kPa (2.0 bar/29 psi).

If tire sealant leaks out, make sure you clean the affected area as quickly as possible. It is preferable to use clean water.

If you get tire sealant on your clothing, have it cleaned as soon as possible with perchloroethylene.

**If, after ten minutes, a tire pressure of 200 kPa (2.0 bar/29 psi) has not been attained:**

- ▶ Switch off the tire inflation compressor.
- ▶ Unscrew the filling hose from the valve of the faulty tire.

Please note that tire sealant may leak out when unscrewing the filling hose.

- ▶ Drive forwards or in reverse very slowly for approximately 33 ft (10 m).
- ▶ Pump up the tire again. After a maximum of ten minutes the tire pressure must be at least 200 kPa (2.0 bar/29 psi).

**⚠ WARNING** Risk of accident due to the specified tire pressure not being attained

If the minimum tire pressure is not reached after the specified time, the tire is too badly damaged. The tire sealant cannot repair the tire in this instance.

The braking and driving characteristics may be greatly impaired.

- ▶ Do not continue driving.
- ▶ Consult a qualified specialist workshop.

**!** **NOTE** Staining caused by leaking tire sealant

After use, excess tire sealant may leak out from the filling hose.

- ▶ Therefore, place the filling hose in the plastic bag that contained the TIREFIT kit.

**If, after ten minutes, a tire pressure of 200 kPa (2.0 bar/29 psi) has been attained:**

- ▶ Switch off the tire inflation compressor.
- ▶ Unscrew the filling hose from the valve of the faulty tire.

Please note that tire sealant may leak out when unscrewing the filling hose.

**!** **WARNING** Risk of accident from driving with sealed tires

A tire temporarily sealed with tire sealant impairs the handling characteristics and is not suitable for higher speeds.

- ▶ Adapt your driving style accordingly and drive carefully.
- ▶ Do not exceed the maximum speed limit with a tire that has been repaired using tire sealant.

- ▶ Observe the maximum permissible speed for a tire sealed with tire sealant 50 mph (80 km/h).
- ▶ The sticker with details of the maximum permissible speed must be affixed to the instrument cluster where it can be easily seen by the driver.

**!** **NOTE** Staining caused by leaking tire sealant

After use, excess tire sealant may leak out from the filling hose.

- ▶ Therefore, place the filling hose in the plastic bag that contained the TIREFIT kit.

**!** **ENVIRONMENTAL NOTE** Environmental pollution caused by environmentally irresponsible disposal

Tire sealant contains pollutants.

- ▶ Have the tire sealant bottle disposed of professionally, e.g. at an authorized Mercedes-Benz Center.

- ▶ Store the tire sealant bottle and the tire inflation compressor.
- ▶ **Pull away immediately.**
- ▶ Stop driving after approximately ten minutes and check the tire pressure using the tire inflation compressor.  
The tire pressure must now be at least 130 kPa (1.3 bar/19 psi).

**▲ WARNING** Risk of accident due to the specified tire pressure not being attained

If the specified tire pressure is not reached, the tire is too badly damaged. The tire sealant cannot repair the tire in this instance.

The braking and driving characteristics may be greatly impaired.

- ▶ Do not continue driving.
- ▶ Consult a qualified specialist workshop.

In cases such as the one mentioned above, contact an authorized Mercedes-Benz Center. Or call 1-800-FOR-MERCEdes (in the USA) or 1-800-387-0100 (in Canada).

- ▶ Correct the tire pressure if it is still at least 130 kPa (1.3 bar / 19 psi). See the Tire and Loading Information placard on the B-pillar on the driver's side or the tire pressure table in the fuel filler flap for values.
- ▶ **To increase the tire pressure:** switch on the tire inflation compressor.

- ▶ **To reduce the tire pressure:** remove the tire sealant bottle from the tire inflation compressor.
- ▶ Insert the filler hose in the socket of the tire inflation compressor and turn it a quarter turn clockwise.

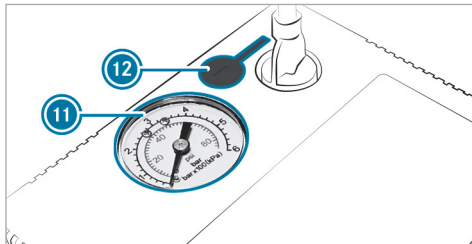

- ▶ Press pressure release button ⑫ next to manometer ⑪.
- ▶ When the tire pressure is correct, unscrew the filling hose from the valve of the sealed tire.
- ▶ Screw the valve cap onto the valve of the sealed tire.

- ▶ Store the tire sealant bottle and the tire inflation compressor.
- ▶ Drive to the nearest qualified specialist workshop and have the tire, tire sealant bottle and filling hose replaced there.

## Battery (vehicle)

### Notes on the 12 V battery

**▲ WARNING** Risk of an accident due to work carried out incorrectly on the battery

Work carried out incorrectly on the battery can, for example, lead to a short circuit. This can restrict functions relevant for safety systems and impair the operating safety of your vehicle.

You could lose control of the vehicle in the following situations in particular:

- When braking

- In the event of abrupt steering maneuvers and/or when the vehicle's speed is not adapted to the road conditions
  - ▶ In the event of a short circuit or a similar incident, contact a qualified specialist workshop immediately.
  - ▶ Do not drive on.
  - ▶ Always have work on the battery carried out at a qualified specialist workshop.

- Further information on ABS (→ page 163)
  - Further information on ESP® (→ page 164)
- For safety reasons, Mercedes-Benz recommends that you only use batteries which have been tested and approved for your vehicle by Mercedes-Benz. These batteries provide increased impact protection to prevent vehicle occupants from suffering acid burns should the battery be damaged in the event of an accident.

**⚠ WARNING** Risk of explosion due to electrostatic charge

Electrostatic charge can ignite the highly explosive gas mixture in the battery.

- ▶ To discharge any electrostatic charge that may have built up, touch the metal vehicle body before handling the battery.

The highly flammable gas mixture is created while the battery is charging and during starting assistance.

**⚠ WARNING** Danger of chemical burns from the battery acid

Battery acid is caustic.

- ▶ Avoid contact with the skin, eyes or clothing.
- ▶ Do not lean over the battery.
- ▶ Do not inhale battery gases.
- ▶ Keep children away from the battery.

- ▶ Immediately rinse battery acid off thoroughly with plenty of clean water and seek medical attention immediately.

**🔥 ENVIRONMENTAL NOTE** Environmental damage caused by improper disposal of batteries



Batteries contain pollutants. It is illegal to dispose of them with the household rubbish.



Dispose of batteries in an environmentally responsible manner. Take discharged batteries to a qualified specialist workshop or to a collection point for used batteries.

If you have to disconnect the 12 V battery, contact a qualified specialist workshop.

Comply with safety notes and take protective measures when handling batteries.



Risk of explosion.



Fire, open flames and smoking are prohibited when handling the battery. Avoid creating sparks.



Electrolyte or battery acid is corrosive. Avoid contact with the skin, eyes or clothing. Wear suitable protective clothing, in particular gloves, an apron and a face mask. Immediately rinse electrolyte or acid splashes off with clean water. Consult a doctor if necessary.



Wear safety glasses.



Keep children away.



Observe this Operator's Manual.

If you do not intend to use the vehicle over an extended period of time:

- activate standby mode, or
- connect the battery to a battery charger approved by Mercedes-Benz, or
- consult a qualified specialist workshop to disconnect the battery

### Notes on starting assistance and charging the 12 V battery

When charging the battery and during starting assistance, always use the jump-start connection point in the engine compartment.

**!** **NOTE** Damage to the battery from over-voltage

When charging using a battery charger without a maximum charging voltage, the battery or the on-board electronics may be damaged.

- ▶ Only use battery chargers with a maximum charging voltage of 14.8 V.

**!** **WARNING** Risk of explosion from hydrogen gas igniting

There is a danger of hydrogen gas igniting when charging the battery if there is a short circuit or sparks start to form.

- ▶ Make sure that the positive terminal of the connected battery does not come into contact with vehicle parts.
- ▶ Never place metal objects or tools on a battery.
- ▶ The described order of the battery clamps must be observed when connecting and disconnecting the battery.

- ▶ When giving starting assistance, always make sure that you only connect battery terminals with identical polarity.
- ▶ During starting assistance, you must observe the described order for connecting and disconnecting the jumper cable.
- ▶ Do not connect or disconnect the battery clamps while the engine is running.

**⚠ WARNING** Risk of explosion during charging process and starting assistance

During the charging process and starting assistance, the battery may release an explosive gas mixture.

- ▶ Avoid fire, open flames, creating sparks and smoking.
- ▶ Make sure there is sufficient ventilation.
- ▶ Do not lean over a battery.

**⚠ WARNING** Risk of explosion from a frozen battery

A discharged battery may freeze at temperatures slightly above or below freezing point.

During starting assistance or battery charging, battery gas can be released.

- ▶ Always allow a battery to thaw before charging it or performing starting assistance.

If the indicator/warning lamps in the instrument cluster do not light up at low temperatures, it is very likely that the discharged battery has frozen. In this case you may neither jump-start the vehicle nor charge the battery.

The service life of a battery that has been thawed may be dramatically shortened. The starting characteristics may be impaired, especially at low temperatures.

It is recommended that you have a thawed battery checked at a qualified specialist workshop.

**! NOTE** Damage caused by numerous or extended attempts to start the engine

Numerous or extended attempts to start the engine may damage the catalytic converter due to non-combusted fuel.

- ▶ Avoid numerous and extended attempts to start the engine.

Observe the following points during starting assistance and when charging the battery:

- Only use undamaged jumper cable/charging cables with a sufficient cross-section and insulated terminal clamps.
- Non-insulated parts of the terminal clamps must not come into contact with other metal parts while the jumper cable/charging cable is connected to the battery/jump-start connection point.
- The jumper cable/charging cable must not come into contact with any parts which may move when the engine is running.
- Always make sure that neither you nor the battery is electrostatically charged.



- Keep away from fire and open flames.
- Do not lean over the battery.

Observe the additional following points when charging the battery:

- Only use battery chargers tested and approved for Mercedes-Benz.
- Read the battery charger's operating instructions before charging the battery.

Observe the additional following points during starting assistance:

- For starting assistance, only use batteries with a nominal voltage of 12 V.
- The vehicles must not touch.
- **Gasoline engine:** Only accept starting assistance if the engine and exhaust system are cold.

### Starting assistance and charging the 12 V battery

#### Requirements:

- The vehicle is secured with the electric parking brake.
- **Automatic transmission:** The transmission is in position **P**.
- The ignition and all electrical consumers are switched off.
- The hood is open.

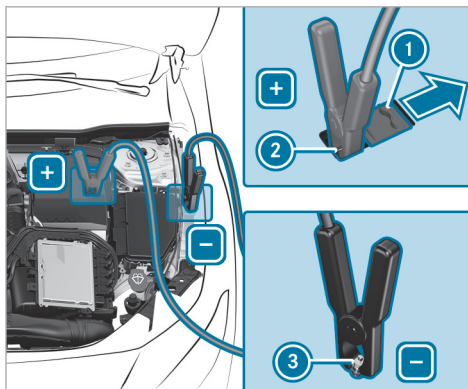

- ▶ Slide cover **1** of positive clamp **2** on the jump-starting connection point in the direction of the arrow.
- ▶ Connect positive clamp **2** on your vehicle to the positive pole of the donor battery using the jumper cable/charging cable. Always begin with positive clamp **2** on your own vehicle first.
- ▶ **During starting assistance:** start the engine of the donor vehicle and run at idle speed.
- ▶ Connect the negative pole of the donor battery and ground point **3** of your own vehicle by using the jumper cable/charging cable. Begin with the donor battery first.
- ▶ **During starting assistance:** start the engine of your own vehicle.
- ▶ **During the charging process:** start the charging process.
- ▶ **During starting assistance:** let the engines run for several minutes.
- ▶ **During starting assistance:** before disconnecting the jumper cable, switch on an elec-

trical consumer in your own vehicle, e.g. the rear window heater or lighting.

When the starting assistance/charging process is complete:

- ▶ First, remove the jumper cable/charging cable from ground point ③ and the negative pole of the donor battery, then from positive clamp ② and the positive pole of the donor battery. Begin each time with the contacts on your own vehicle first.
- ▶ After removing the jumper cable/charging cable, close cover ① of positive clamp ②.

Further information can be obtained at a qualified specialist workshop.

### Replacing the 12 V battery

- ▶ Observe the notes on the 12 V battery (→ page 251).

Mercedes-Benz recommends that you have the 12 V battery replaced at a qualified specialist workshop, e.g. at an authorized Mercedes-Benz Center.

Observe the following notes if you want to replace the battery yourself:

- Always replace a faulty battery with a battery which meets the specific vehicle requirements.

The vehicle is equipped with an AGM technology battery (Absorbent Glass Mat). Full vehicle functionality is only guaranteed with an AGM battery. For safety reasons, Mercedes-Benz recommends that you only use batteries which have been tested and approved for your vehicle by Mercedes-Benz.

- Use detachable parts such as vent hoses, elbow fittings or terminal covers from the battery which is to be replaced.
- Make sure that the vent hose is always connected to the original opening on the side of the battery.

Install any existing or supplied cell caps. Otherwise, gases or battery acid could escape.

- Make sure that detachable parts are reconnected in the same way.

### Tow starting or towing away

#### Permitted towing methods

##### Permitted towing methods

Mercedes-Benz recommends transporting your vehicle in the case of a breakdown, rather than towing it away.

For towing, use a tow rope or tow bar with both axles on the ground. Do not use tow bar systems.

**⚠ WARNING** Risk of accident when towing with steering wheel lock

You will no longer be able to steer the vehicle if the steering wheel lock is engaged.

- ▶ Always switch on the ignition when towing the vehicle with a tow cable or a tow bar.

**! NOTE** Damage to the vehicle due to towing away incorrectly

- ▶ Observe the instructions and notes on towing away.

**Vehicles with automatic transmission**

|                          |   |
|--------------------------|---|
| Both axles on the ground | Yes, maximum 31 miles (50 km) at 31 mph (50 km/h) |
| Front axle raised        | Yes, maximum 31 miles (50 km) at 31 mph (50 km/h) |
| Rear axle raised         | Yes, maximum 31 miles (50 km) at 31 mph (50 km/h) |

**4MATIC vehicles**

|                          |   |
|--------------------------|---|
| Both axles on the ground | Yes, maximum 31 miles (50 km) at 31 mph (50 km/h) |
| Front axle raised        | No  |
| Rear axle raised         | No  |

**To tow with a raised axle:** towing should be performed by a towing company.

**Towing the vehicle with both axles on the ground**

- ▶ Observe the notes on the permitted towing methods (→ page 256).
- ▶ Make sure that the battery is connected and charged.

Observe the following points when the battery is discharged:

- The engine cannot be started
  - The electric parking brake cannot be released or applied
  - **Vehicles with automatic transmission:** The automatic transmission cannot be shifted to position **N** or **P**
- i** **Vehicles with automatic transmission:** If the automatic transmission cannot be shifted to position **N**, or the multifunction display in the instrument cluster does not show anything, have the vehicle transported away (→ page 258). A towing vehicle with lifting equipment is required for vehicle transportation.

**!** **NOTE** Damage due to towing away at excessively high speeds or over long distances

The drivetrain could be damaged when towing at excessively high speeds or over long distances.

- ▶ A towing speed of 30 mph (50 km/h) must not be exceeded.
- ▶ A towing distance of 30 miles (50 km) must not be exceeded.

**!** **WARNING** Risk of accident when towing a vehicle which is too heavy

If another vehicle is tow-started or towed away, its weight must not exceed the permissible gross mass of your own vehicle, otherwise the following could occur:

- The towing eye may become detached.
  - The vehicle/trailer combination may swerve or even rollover.
- ▶ If another vehicle is tow-started or towed away, its weight must not exceed

the permissible gross mass of your own vehicle.

If a vehicle must be tow-started or towed away, its permissible gross weight must not exceed the permissible gross weight of the towing vehicle.

- ▶ Information on the permissible gross mass of the vehicle can be found on the vehicle identification plate (→ page 298).
- ▶ **Vehicles with automatic transmission:** Do not open the driver's door or front passenger door, otherwise the automatic transmission automatically shifts to position **P**.
- ▶ Install the towing eye (→ page 260).
- ▶ Fasten the tow bar.

**!** **NOTE** Damage due to incorrect connection of the tow bar

- ▶ Only connect the tow rope or tow bar to the towing eyes.

- ▶ Deactivate the automatic locking mechanism (→ page 65).

- ▶ Do not activate the HOLD function.
- ▶ Deactivate the tow-away alarm (→ page 82).
- ▶ Deactivate Active Brake Assist (→ page 171).
- ▶ **Vehicles with automatic transmission:** Shift the automatic transmission to position **N**.
- ▶ Release the electric parking brake.

**!** **WARNING** Risk of accident due to limited safety-related functions during the towing process

Safety-related functions are limited or no longer available in the following situations:

- The ignition is switched off.
- The brake system or power steering system is malfunctioning.
- The energy supply or the on-board electrical system is malfunctioning.

When your vehicle is then towed away, significantly more effort may be required to steer and brake than is normally required.

- ▶ Use a tow bar.
- ▶ Make sure that the steering wheel can move freely before towing the vehicle away.

**!** **NOTE** Damage due to excessive tractive power

If you pull away sharply, the tractive power may be too high and the vehicles could be damaged.

- ▶ Pull away slowly and smoothly.

### Loading the vehicle for transport

- ▶ Observe the notes on towing away (→ page 257).
- ▶ Connect the tow bar to the towing eye in order to load the vehicle.
- ▶ **Vehicles with automatic transmission:** Shift the automatic transmission to position **N**.

**i Vehicles with automatic transmission:**

The automatic transmission may be locked in position **P** in the event of damage to the electrical system. To shift to **N**, provide the on-board electrical system with power (→ page 255).

▶ Load the vehicle onto the transporter.

**Vehicles with automatic transmission:**

Shift the automatic transmission to position **P**.

▶ Use the electric parking brake to secure the vehicle against rolling away.

▶ Only secure the vehicle by the wheels.

**Vehicles with ADS PLUS (Adaptive Damping System PLUS)**

**⚠ WARNING** Risk of an accident when transporting vehicles with Adaptive Damping System PLUS

When transporting vehicles with Adaptive Damping System PLUS, the vehicle/trailer combination may begin to rock and start to skid.

- ▶ When transporting, ensure that:
- The vehicle has been loaded onto the transporter correctly
  - The vehicle is secured at all four wheels with suitable tensioning straps
  - The maximum permissible speed of 35 mph (60 km/h) is not exceeded when transporting

**!** **NOTE** Damage to the vehicle from securing it incorrectly

- ▶ After loading, the vehicle must be secured on all four wheels. Otherwise, the vehicle could be damaged.
- ▶ A minimum distance of 8 in (20 cm) upwards and 4 in (10 cm) downwards must be kept to the transport platform.

▶ Secure the vehicle on all four wheels after loading.

**4MATIC vehicles/vehicles with automatic transmission**

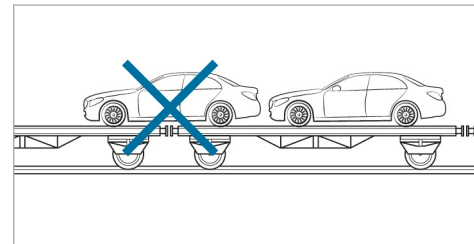

▶ Make sure that the front and rear axles come to rest on the same transportation vehicle.

**!** **NOTE** Damage to the drivetrain due to incorrect positioning

▶ Do not position the vehicle above the connection point of the transport vehicle.

### Towing eye storage location

Towing eye is under the cargo compartment floor.

### Installing the towing eye

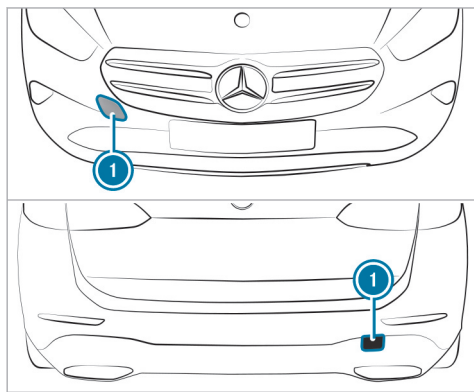

▶ Press the mark on cover ❶ inwards and remove.

- ▶ Screw in the towing eye clockwise as far as it will go and tighten.
- ❶ Make sure that cover ❶ engages in the bumper when you remove the towing eye.

**!** **NOTE** Damage to the vehicle due to incorrect use of the towing eye

When a towing eye is used to recover a vehicle, the vehicle may be damaged in the process.

- ▶ Only use the towing eye to tow away or tow start the vehicle.

### Tow starting the vehicle (emergency engine start)

#### Vehicles with automatic transmission

**!** **NOTE** Damage to the automatic transmission due to tow starting

The automatic transmission may be damaged in the process of tow starting vehicles with automatic transmission.

- ▶ Vehicles with automatic transmission must not be tow started.

- ▶ Vehicles with automatic transmission must not be tow-started.

### Electrical fuses

#### Notes on electrical fuses

**!** **WARNING** Risk of accident and injury due to overloaded lines

If you manipulate or bridge a faulty fuse or if you replace it with a fuse with a higher amperage, the electric line could be overloaded.

This could result in a fire.

- ▶ Always replace faulty fuses with specified new fuses containing the correct amperage.

**!** NOTE Damage due to incorrect fuses

Electrical components or systems may be damaged by incorrect fuses, or their functionality may be significantly impaired.

- ▶ Only use fuses that have been approved by Mercedes-Benz and which have the correct fuse rating.

Blown fuses must be replaced with fuses of the same rating, which you can recognize by the color and fuse rating. The fuse ratings and further information to be observed can be found in the fuse assignment diagram.

**Fuse assignment diagram:** on the fuse box in the engine compartment (→ page 261).

**!** NOTE Damage or malfunctions caused by moisture

Moisture may cause damage to the electrical system or cause it to malfunction.

- ▶ When the fuse box is open, make sure that no moisture can enter the fuse box.
- ▶ When closing the fuse box, make sure that the seal of the lid is positioned correctly on the fuse box.

If the newly inserted fuse also blows, have the cause traced and rectified at a qualified specialist workshop.

Ensure the following before replacing a fuse:

- The vehicle is secured against rolling away.
- All electrical consumers are switched off.
- The ignition is switched off.

The electrical fuses are located in various fuse boxes:

- Fuse box in the engine compartment on the left-hand side of the vehicle, when viewed in the direction of travel (→ page 261)
- Fuse box in the front passenger footwell (→ page 262)

- Fuse box in the center of the cargo compartment (→ page 263)

### Opening and closing the fuse box in the engine compartment

#### Requirements:

- A dry cloth and a screwdriver are available.

Observe the notes on electrical fuses (→ page 260).

#### Opening

**!** WARNING Risk of injury from using the windshield wipers while the engine hood is open

When the engine hood is open and the windshield wipers are set in motion, you can be trapped by the wiper linkage.

- ▶ Always switch off the windshield wipers and ignition before opening the engine hood.

- ▶ Open the hood.

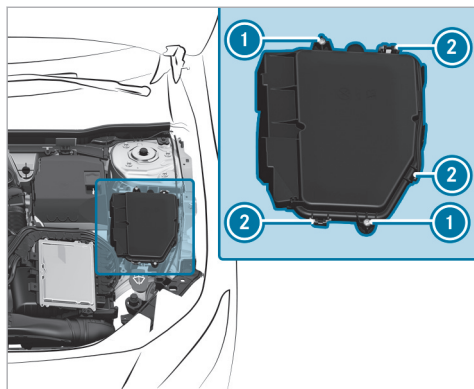

- ▶ Remove any existing moisture from the fuse box using a dry cloth.
- ▶ Loosen screws ①.
- ▶ Press clamps ② and lift the fuse box lid up and out.

The fuse assignment diagram is in a recess on the side of the fuse box.

### Closing

- ▶ Check whether the seal is positioned correctly in the lid.
- ▶ Place the lid on the fuse box.
- ▶ Make sure that clamps ② engage.
- ▶ Tighten screws ①.
- ▶ Close the hood.

### Opening and closing the fuse box in the front passenger footwell

Observe the notes on electrical fuses (→ page 260).

### Opening

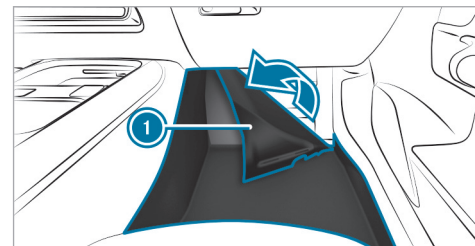

- ▶ Lift carpet ① in the direction of the arrow.



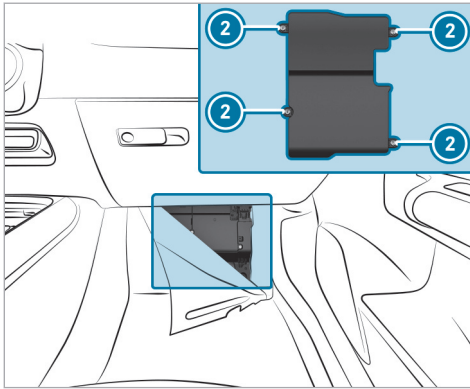

- ▶ Loosen screws ② and remove the fuse box lid from the top.

### Closing

- ▶ Place the lid on the fuse box.
- ▶ Tighten screws ②.
- ▶ Fold back the carpet.

### Opening and closing the fuse box in the cargo compartment

Observe the notes on electrical fuses  
(→ page 260).

- ▶ Open the cargo compartment floor .

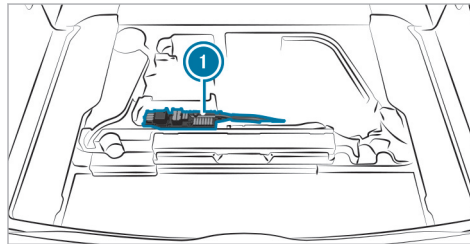

Fuse box ① is located underneath the cargo compartment floor.

### Notes on noise or unusual handling characteristics

Make sure there are no vibrations, noises or unusual handling characteristics when the vehicle is in motion. This may indicate that the wheels or tires are damaged. Hidden tire damage could also be causing the unusual handling characteristics.

If you suspect that a tire is malfunctioning, reduce your speed immediately and have the tires and wheels checked at a qualified specialist workshop.

### Notes on regularly inspecting wheels and tires

**⚠ WARNING** Risk of injury through damaged tires

Damaged tires can cause tire pressure loss.

- ▶ Check the tires regularly for signs of damage and replace any damaged tires immediately.

**⚠ WARNING** Risk of hydroplaning due to insufficient tire tread

Insufficient tire tread will result in reduced tire grip.

In heavy rain or slush the risk of hydroplaning is increased, in particular where speed is not adapted to suit the conditions.

- ▶ Thus, you should regularly check the tread depth and the condition of the tread across the entire width of all tires.

Minimum tread depth for:

- Summer tires:  $\frac{1}{8}$  in (3 mm)
- M+S tires:  $\frac{1}{16}$  in (4 mm)
- ▶ For safety reasons, replace the tires before the legally-prescribed limit for the minimum tread depth is reached.

Carry out the following checks on all wheels regularly, at least once a month or as required, for example, prior to a long journey or driving off-road:

- Check the tire pressure (→ page 265).

- Visually inspect wheels and tires for damage.
- Check the valve caps.
- Visual check of the tire tread depth and the tire contact surface across the entire width.  
The minimum tread depth for summer tires is  $\frac{1}{8}$  in (3 mm) and for winter tires  $\frac{1}{16}$  in (4 mm).

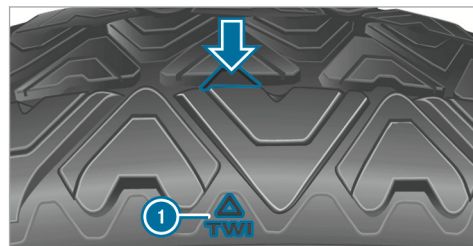

Six marks ① show where the bar indicators (arrow) are integrated into the tire tread. They are visible once a tread depth of approximately  $\frac{1}{16}$  in (1.6 mm) has been reached.

### Notes on snow chains

**⚠ WARNING** Risk of accident due to incorrect snow chain fitting

If you fit snow chains to the rear wheels, the snow chains may grind against the vehicle body or chassis components.

This could cause damage to the vehicle or the tires.

- ▶ Never fit snow chains to the rear wheels.
- ▶ Always fit snow chains to the front wheels in pairs.

**!** **NOTE** Damage to components of the vehicle body or chassis due to mounted snow chains

If you mount snow chains to the front wheels of 4MATIC vehicles, you may damage components of the vehicle body or chassis.

- ▶ Only mount snow chains to the rear wheels of 4MATIC vehicles.

**!** **NOTE** Damage to the wheel trim from mounted snow chains

If snow chains are mounted to steel wheels, the wheel trims can be damaged.

- ▶ Remove the wheel trims of steel wheels before mounting snow chains.

Observe the following notes when using snow chains:

- Snow chains are only permissible for certain wheel/tire combinations. You can obtain information about this from an authorized Mercedes-Benz Center.
- For safety reasons, only use snow chains that have been specifically approved for your vehicle by Mercedes-Benz, or snow chains with the same quality standard.
- If snow chains are installed, the maximum permissible speed is 30 mph (50 km/h).
- **Vehicles with Active Parking Assist:** Do not use Active Parking Assist when snow chains are installed.

- ① You can deactivate ESP® to pull away (→ page 165). This allows the wheels to spin, achieving an increased driving force.

### Tire pressure

#### Notes on tire pressure

**⚠ WARNING** Risk of accident due to insufficient or excessive tire pressure

Underinflated or overinflated tires pose the following risks:

- The tires may burst, especially as the load and vehicle speed increase.
  - The tires may wear excessively and/or unevenly, which may greatly impair tire traction.
  - The driving characteristics, as well as steering and braking, may be greatly impaired.
- ▶ Comply with the recommended tire pressure and check the tire pressure of

all tires including the spare wheel regularly:

- at least once a month
  - when the load changes
  - before embarking on a longer journey
  - if operating conditions change, e.g. off-road driving
- ▶ Adjust the tire pressure as necessary.

Tire pressure which is too high or too low can:

- Shorten the service life of the tires.
- Cause increased tire damage.
- Adversely affect driving characteristics and thus driving safety, e.g. due to hydroplaning.

**▲ WARNING** Risk of an accident due to insufficient tire pressure

Tires with pressure that is too low can overheat and burst as a result.

In addition, they also suffer from excessive and/or irregular wear, which can significantly

impair the braking properties and the handling characteristics.

- ▶ Avoid excessively low tire pressures in all the tires, including the spare wheel.

Tire pressure which is too low can cause:

- Tire malfunctions as a result of overheating
- Impaired handling characteristics
- Irregular wear
- Increased fuel consumption

**▲ WARNING** Risk of accident from excessive tire pressure

Tires with excessively high pressure can burst because they are damaged more easily by highway fill, pot holes etc.

In addition, they also suffer from irregular wear, which can significantly impair the braking properties and the handling characteristics.

- ▶ Avoid excessively high tire pressures in all the tires, including the spare wheel.

Tire pressure which is too high can cause:

- Increased braking distance
- Impaired handling characteristics
- Irregular wear
- Impaired driving comfort
- Susceptibility to damage

**▲ WARNING** Risk of accident caused by repeated drop in tire pressure

If the tire pressure drops repeatedly, the wheel, valve or tire may be damaged.

Insufficient tire pressure can cause the tires to burst.

- ▶ Inspect the tire for signs of foreign objects.
- ▶ Check whether the wheel or valve has a leak.
- ▶ If you are unable to rectify the damage, contact a qualified specialist workshop.

You can find information on tire pressure for the vehicle's factory-installed tires on the following labels:

- Tire and Loading Information placard on the B-pillar of your vehicle (→ page 272).
- Tire pressure table on the inside of the fuel filler flap (→ page 267).

Observe the maximum tire pressure (→ page 278).

Use a suitable pressure gauge to check the tire pressure. The outer appearance of a tire does not permit any reliable conclusion about the tire pressure.

Only correct tire pressure when the tires are cold. Conditions for cold tires:

- The vehicle has been parked with the tires out of direct sunlight for at least three hours.
- The vehicle has traveled less than 1 mile (1.6 km).

The vehicle's tires heat up when driving. As the temperature of the tires increases, so too does the tire pressure.

**Vehicles with a tire pressure monitoring system:** You can also check the tire pressure using the on-board computer.

The tire pressure recommended for increased load/speed in the tire pressure table can affect the ride comfort.

**⚠ WARNING** Risk of accident due to unsuitable accessories on tire valve

If you mount unsuitable accessories onto tire valves, the tire valves may be overloaded and malfunction, which can cause a loss of tire pressure. Aftermarket tire pressure monitoring systems will cause the tire valve to remain open, depending on the design. This can also result in a loss of tire pressure.

- ▶ Only screw standard valve caps or valve caps specifically approved by Mercedes-Benz for your vehicle onto the tire valve.

## Tire pressure table

The tire pressure table is on the inside of the fuel filler flap.

- ⓘ The data shown in the images is example data.

| COLD TIRE PRESSURE        |                  |
|---------------------------|------------------|
| normal load               | 35 psi / 2.4 bar |
| maximum load              | 35 psi / 2.4 bar |
| Warm tires up to: + 4 psi |                  |

Additional information on the display: A 212 584 00 15, 1234567

If one or more tire sizes precede a tire pressure, the following tire pressure information is only valid for those tire sizes and their respective load condition.

The load conditions "partially laden" and "fully laden" are defined in the table for different numbers of passengers and amounts of luggage. The actual number of seats may differ from this.

|     |  | kPa | psi | kPa | psi |
|-----|--|-----|-----|-----|-----|
| R18 |  |     |     |     |     |
| R19 |  |     |     |     |     |
| M+S |  |     |     |     |     |

Some tire pressure tables only show the rim diameter instead of the complete tire size, e.g. **R18**. The rim diameter is part of the tire size and can be found on the tire side wall (→ page 279).

- Tire and Loading Information placard (→ page 272)
- Maximum tire pressure (→ page 278)

### Checking tire pressures manually

- ▶ Read the tire pressure for the current operating conditions from the Tire and Loading Information placard or the tire pressure table. Observe the notes on tire pressure.
- ▶ Remove the valve cap of the tire to be checked.
- ▶ Press the tire pressure gauge securely onto the valve.
- ▶ Read the tire pressure.
- ▶ If the tire pressure is lower than the recommended value, increase the tire pressure to the recommended value.
- ▶ If the tire pressure is higher than the recommended value, release air. To do so, press down the metal pin in the valve, e.g. using the tip of a pen for example. Then check the tire pressure again using the tire pressure gauge.
- ▶ Screw the valve cap onto the valve.

Further related subjects:

- Notes on tire pressure (→ page 265)

- Tire pressure table (→ page 267)
- Tire and Loading Information placard (→ page 272)

### Tire pressure monitoring system

#### Function of the tire pressure monitoring system

**⚠ DANGER** Risk of accident due to incorrect tire pressure

Each tire, including the spare (if provided), should be checked monthly when cold and inflated to the inflation pressure recommended by the vehicle manufacturer on the vehicle placard or tire inflation pressure label. (If your vehicle has tires of a different size than the size indicated on the vehicle placard or tire inflation pressure label, you should determine the proper tire inflation pressure for those tires.)

As an added safety feature, your vehicle has been equipped with a tire pressure monitoring system (TPMS) that illuminates a low tire

pressure telltale when one or more of your tires is significantly under-inflated. Accordingly, when the low tire pressure telltale illuminates, you should stop and check your tires as soon as possible, and inflate them to the proper pressure. Driving on a significantly under-inflated tire causes the tire to overheat and can lead to tire failure. Under-inflation also reduces fuel efficiency and tire tread life, and may affect the vehicle's handling and stopping ability. Please note that the TPMS is not a substitute for proper tire maintenance, and it is the driver's responsibility to maintain correct tire pressure, even if under-inflation has not reached the level to trigger illumination of the TPMS low tire pressure telltale.

Your vehicle has also been equipped with a TPMS malfunction indicator to indicate that the system is not operating properly. The TPMS malfunction indicator is combined with the low tire pressure telltale. When the system detects a malfunction, the indicator lamp will flash for approximately one minute

and then remain continuously illuminated. This sequence will continue upon subsequent vehicle start-ups as long as the malfunction exists.

When the malfunction indicator is illuminated, the system may not be able to detect or signal low tire pressure as intended. TPMS malfunctions may occur for a variety of reasons, including the installation of replacement or alternate tires or wheels on the vehicle that prevent the TPMS from functioning properly.

Always check the TPMS malfunction telltale after replacing one or more tires or wheels on your vehicle to ensure that the replacement or alternate tires and wheels allow the TPMS to continue to function properly.

The system checks the tire pressure and the tire temperature of the tires installed to the vehicle by means of a tire pressure sensor.

The tire pressure and the tire temperature appear in the multifunction display (→ page 270).

If there is a substantial pressure loss or if the tire temperature is excessive, you will be warned in the following ways:

- via display messages (→ page 349)
- via the  warning lamp in the instrument cluster (→ page 368)

The tire pressure monitoring system is only an aid. It is the driver's responsibility to set the tire pressure to the recommended cold tire pressure suitable for the operating situation.

In most cases, the tire pressure monitoring system will automatically update the new reference values after you have changed the tire pressure. You can, however, also update the reference values by restarting the tire pressure monitoring system manually (→ page 270).

### System limits

The system may be impaired or may not function in the following situations:

- the tire pressure has been set incorrectly
- there is a sudden pressure loss caused, for example, by a foreign object penetrating the tire

- there is a malfunction caused by another radio signal source

### Checking the tire pressure with the tire pressure monitoring system

#### Requirements:

- The ignition is switched on.

On-board computer:

→ Service ▶ Tires

One of the following displays appears:

- Current tire pressure and tire temperature of the individual wheels:

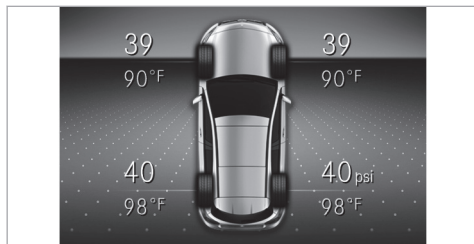

- **Tire pressure will be displayed after driving a few minutes**
- **Tire Pressure Monitor Active:** the teach-in process of the system is not yet complete. The tire pressures are already being monitored.

▶ Compare the tire pressure with the recommended tire pressure for the current operating condition (→ page 267). Observe the notes on tire temperature (→ page 265).

ⓘ The values displayed in the multifunction display may deviate from those of the tire pressure gauge as they refer to sea level. At high altitudes, the tire pressure value indicated by a pressure gauge are higher than those shown by the on-board computer. In this case, do not reduce the tire pressure.

### Restarting the tire pressure monitoring system

#### Requirements:

- The recommended tire pressure is correctly set for the respective operating status on all of the wheels (→ page 265).

Restart the tire pressure monitoring system in the following situations:

- The tire pressure has changed.
- The wheels or tires have been changed or newly installed.

On-board computer:

→ Service ▶ Tires

▶ Swipe downwards on Touch Control on the left-hand side of the steering wheel.

The **Use Current Pressures as New Reference Values** message is shown in the multifunction display.

▶ To restart, press Touch Control on the left-hand side of the steering wheel.

The **Tire Press. Monitor Restarted** message is shown in the multifunction display.

Current warning messages are deleted and the yellow  warning lamp goes out.

After you have been driving for a few minutes, the system checks whether the current tire pressures are within the specified range. The current tire pressures are then accepted as reference values and monitored.



Be sure to also pay attention to the following related topic:

- Notes on tire pressure (→ page 265)

### **Tire pressure loss warning system**

#### **Function of the tire pressure loss warning system**

The tire pressure loss warning system warns the driver by means of display messages when there is a severe tire pressure loss.

#### **System limits**

The system may be impaired or may not function particularly in the following situations:

- incorrectly set tire pressure
- sudden pressure loss caused, for example, by a foreign object penetrating the tire
- steady pressure loss in several tires

The system has a restricted or delayed function particularly in the following situations:

- poor ground conditions, e.g. snow or gravel
- driving with snow chains

- when adopting a very sporty driving style with high cornering speeds or sudden acceleration
- driving with a high load

The tire pressure loss warning system is only an aid. It is the driver's responsibility to set the tire pressure to the recommended cold tire pressure suitable for the operating situation and to check it.

Be sure to also observe the following further related subjects:

- Notes on tire pressure (→ page 265)
- Display messages about the tires (→ page 349)

#### **Restarting the tire pressure loss warning system**

##### **Requirements:**

- The recommended tire pressure is correctly set for the respective operating status on all wheels.

Restart the tire pressure loss warning system in the following situations:

- The tire pressure has changed.
- The wheels or tires have been changed or newly installed.

On-board computer:

↳ [Service](#) ▶ [Tires](#)

- ▶ Swipe downwards on Touch Control on the left-hand side of the steering wheel. The [Tire Pressure Control System ActiveRestart](#) message is shown in the multi-function display.
- ▶ To begin restart, press Touch Control on the left-hand side of the steering wheel. The [Tire Pressure Now OK?](#) message is shown in the multifunction display.
- ▶ Select [Yes](#).
- ▶ To confirm restart, press Touch Control on the left-hand side of the steering wheel. The [Run Flat Indicator Restarted](#) message is shown in the multifunction display.

## 272 Wheels and tires

After you have driven for a few minutes, the tire pressure loss warning system monitors the set tire pressures of all the tires.

Be sure to also pay attention to the following related topic:

- Notes on tire pressure (→ page 265)

### Loading the vehicle

#### Notes on Tire and Loading Information placard

**⚠ WARNING** Risk of accident from overloaded tires

Overloaded tires may overheat and burst as a consequence. Overloaded tires can also impair the steering and handling characteristics and lead to brake failure.

- ▶ Observe the load-bearing capacity of the tires.
- ▶ The load-bearing capacity must be at least half the gross axle weight rating of the vehicle.

▶ Never overload the tires by exceeding the maximum load.

The Tire and Loading Information placard is on the B-pillar on the driver's side of the vehicle.

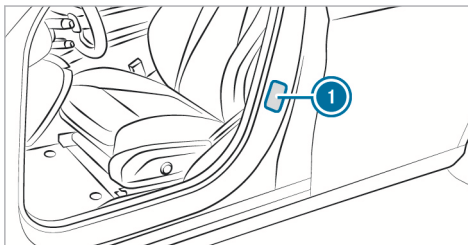

① Tire and Loading Information placard

| TIRE AND LOADING INFORMATION   |   |
|--|---|
| RENSEIGNEMENTS SUR LES PNEUS ET LE CHARGEMENT  |   |
| SEATING CAPACITY / NOMBRE DE PLACES  | TOTAL 7 FRONT AVANT 2 MIDDLE 3 REAR ARRIERE 2 |
| The combined weight of occupants and cargo should never exceed XXX kg or XXX lbs. / Le poids total des occupants et du chargement ne doit jamais dépasser XXX kg ou XXX lbs. |   |
| TIRE / PNEU  | SIZE / DIMENSIONS                             |
| FRONT / AVANT  | 255/40 ZR18 99Y XL                            |
| REAR / ARRIERE   | 285/35 ZR18 101Y XL                           |
| SPARE / DE SECOURS   | 175/55-18 95P                                 |
| COLD TIRE PRESSURE / PRESSION DES PNEUS A FROID  |   |
| FRONT / AVANT  | 200 KPA, 29 PSI                               |
| REAR / ARRIERE   | 200 KPA, 29 PSI                               |
| SPARE / DE SECOURS   | 420 KPA, 60 PSI                               |
| SEE OWNER'S MANUAL FOR ADDITIONAL INFORMATION / VOIR LE MANUEL DE L'USAGER POUR PLUS DE RENSEIGNEMENTS   |   |

① The data shown in the illustration is example data.

The Tire and Loading Information placard shows:

- Maximum number of seats ② according to the maximum number of people permitted to travel in the vehicle.
- Maximum permissible load ③ comprises the gross weight of all vehicle occupants, load and luggage.

- Recommended tire pressures  for cold tires. The recommended tire pressures are valid for the maximum permissible load and up to the maximum permissible vehicle speed.

Please also note:

- Information on permissible weights and loads on the vehicle identification plate (→ page 298).
- Information on tire pressure in the tire pressure table (→ page 267).

Further related subjects:

- Determining the maximum permissible load (→ page 273)
- Notes on tire pressure (→ page 265).

### Steps for Determining Correct Load Limit

The following steps have been developed as required of all manufacturers under Title 49, Code of U.S. Federal Regulations, Part 575, pursuant to the "National Traffic and Motor Vehicle Safety Act of 1966".

- ▶ **(1):** Locate the statement "The combined weight of occupants and cargo should never exceed XXX kg or XXX lbs." on your vehicle's placard.
- ▶ **(2):** Determine the combined weight of the driver and passengers that will be riding in your vehicle.
- ▶ **(3):** Subtract the combined weight of the driver and passengers from XXX kg or XXX lbs.
- ▶ **(4):** The resulting figure equals the available amount of cargo and luggage load capacity. For example, if the "XXX" amount equals 1400 lbs. and there will be five 150 lb passengers in your vehicle, the amount of available cargo and luggage load capacity is 650 lbs. (1400 - 750 (5 x 150) = 650 lbs.)
- ▶ **(5):** Determine the combined weight of luggage and cargo being loaded on the vehicle. The weight may not safely exceed the available cargo and luggage load capacity calculated in Step 4.
- ▶ **(6):** If your vehicle will be towing a trailer, load from your trailer will be transferred to

your vehicle. Consult this manual to determine how this reduces the available cargo and luggage load capacity of your vehicle.

-  **(i)** Not all vehicles are permitted to tow a trailer. Towing a trailer is only permitted if a trailer-hitch is installed. Please consult an authorized Mercedes-Benz dealer if you have any questions about towing a trailer with your vehicle.

Even if you have calculated the total load carefully, you should still make sure that the maximum permissible gross weight and the maximum gross axle weight rating of your vehicle are not exceeded. Details can be found on the vehicle identification plate.

- ▶ Have your loaded vehicle – including driver, occupants and load – weighed on a vehicle weighbridge. The measured values may not exceed the maximum permissible values stated on the vehicle identification plate.

Further related subjects:

- Calculation example for determining the maximum load (→ page 274)

## 274 Wheels and tires

- Tire and Loading Information placard (→ page 272)
- Tire pressure table (→ page 267)
- Vehicle identification plate

### Calculation example for determining the maximum load

The following table shows examples of how to calculate total and load capacities with varying seating configurations and different numbers and sizes of occupants. The following examples use a maximum load of 1500 lbs (680 kg). **This**

**is for illustration purposes only.** Make sure you are using the actual load limit for your vehicle stated on your vehicle's Tire and Loading Information placard (→ page 272).

The higher the weight of all the occupants, the smaller the maximum load for luggage.

### Step 1

|  | Example 1         | Example 2         |
|--|-------------------|-------------------|
| Combined maximum weight of occupants and load (data from the Tire and Loading Information placard) | 1500 lbs (680 kg) | 1500 lbs (680 kg) |

### Step 2

|  | Example 1           | Example 2 |
|--|---------------------|-----------|
| Number of people in the vehicle (driver and occupants) | 5                   | 1         |
| Distribution of the occupants                          | Front: 2<br>Rear: 3 | Front: 1  |

|                               | Example 1   | Example 2                   |
|-------------------------------|---|-----------------------------|
| Weight of occupants           | Occupant 1: 150 lbs (68 kg)<br>Occupant 2: 180 lbs (82 kg)<br>Occupant 3: 160 lbs (73 kg)<br>Occupant 4: 140 lbs (63 kg)<br>Occupant 5: 120 lbs (54 kg) | Occupant 1: 200 lbs (91 kg) |
| Total weight of all occupants | 750 lbs (340 kg)  | 200 lbs (91 kg)             |

**Step 3**

|  | Example 1   | Example 2   |
|--|---|---|
| Permissible load (maximum gross vehicle weight rating from the Tire and Loading Information placard minus the gross weight of all occupants) | 1500 lbs (680 kg) - 750 lbs (340 kg) = 750 lbs (340 kg) | 1500 lbs (680 kg) - 200 lbs (91 kg) = 1300 lbs (589 kg) |

## Tire labeling

### Overview of tire labeling

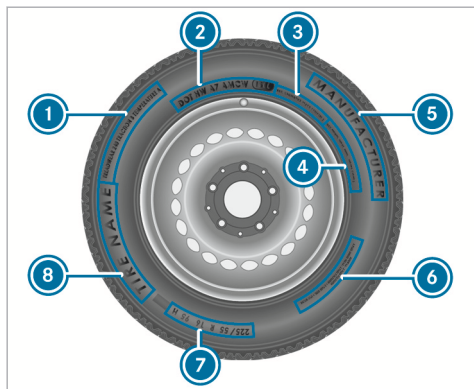

- ① Uniform Tire Quality Grading Standard (→ page 276)
- ② DOT, Tire Identification Number (→ page 277)
- ③ Maximum tire load (→ page 278)
- ④ Maximum tire pressure (→ page 278)

- ⑤ Manufacturer
- ⑥ Characteristics of the tire (→ page 279)
- ⑦ Tire size designation, load-bearing capacity, speed rating and load index (→ page 279)
- ⑧ Tire name
- ⓘ The data shown in the image is example data.

### Tire Quality Grading

In accordance with the US Department of Transportation's "Uniform Tire Quality Grading Standards", tire manufacturers are required to grade their tires on the basis of the following three performance factors:

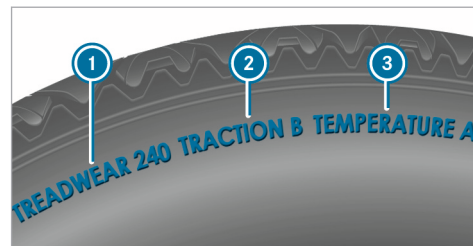

- ① Tread wear grade
- ② Traction grade
- ③ Temperature grade
- ⓘ The data shown in the illustration is example data.
- ⓘ The classification is not legally stipulated for Canada, but it is generally stated.

### Tread wear grade

The tread wear grade is a comparative rating based on the wear rate of the tire when tested under controlled conditions on a specified test track of the US Department of Transportation. For example, a tire graded 150 would wear one

and one-half times as well on the government test track as a tire graded 100.

The relative performance of tires depends upon the actual conditions of their use, however, and may depart significantly from the norm due to variations in driving habits, service practices and differences in road characteristics and climate conditions.

### Traction grade

**⚠ DANGER** Risk of accident due to inadequate traction

The traction grade assigned to this tire is based on straight-ahead braking traction tests, and does not include either acceleration, cornering, hydroplaning or peak traction characteristics.

- ▶ Always adapt your driving style and drive at a speed to suit the prevailing traffic and weather conditions.

**⚠ NOTE** Damage to the drivetrain from wheelspin

- ▶ Avoid wheelspin.

The traction classes, from highest to lowest, are AA, A, B and C. Those grades represent the tire's ability to stop on wet pavement as measured under controlled conditions on specified government test surfaces of asphalt and concrete. A tire marked C may have poor traction performance.

### Temperature grade

**⚠ WARNING** Risk of accident from tire overheating and tire failure

The temperature grade for this tire is established for a tire that is properly inflated and not overloaded. Excessive speed, underinflation, or excessive loading, either separately or in combination, can cause excessive heat build-up and possible tire failure.

- ▶ Observe the recommended tire pressures and regularly check the tire pres-

sure of all tires including the spare wheel.

- ▶ Adjust the tire pressure as necessary.

The temperature grades are A (the highest), B and C. They represent the tire's resistance to the generation of heat and its ability to dissipate heat when tested under controlled conditions on a specified indoor laboratory test wheel. Sustained high temperature can cause the material of the tire to degenerate and reduce tire life, and excessive temperature can lead to sudden tire failure. Grade C corresponds to a level of performance which all passenger car tires must meet under the Federal Motor Safety Standard No. 109. Grades B and A represent higher levels of performance on the laboratory test wheel than the minimum required by law.

### DOT, Tire Identification Number (TIN)

US tire regulations stipulate that every tire manufacturer or retreader must imprint a TIN in or on the side wall of each tire produced.

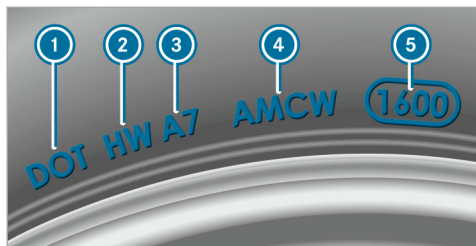

**i** The data shown in the image is example data.

The TIN is a unique identification number to identify tires and comprises the following:

- **DOT (Department of Transportation):** tire symbol marks **1** indicating that the tire complies with the requirements of the US Department of Transportation.
- **Manufacturer identification code:** manufacturer identification code **2** contains details of the tire manufacturer. New tires have a code with two symbols. Retreaded tires have a code with four symbols. Further information on retreaded tires (→ page 284).

- **Tire size:** identifier **3** describes the tire size.
- **Tire type code:** tire type code **4** can be used by the manufacturer as a code to describe specific characteristics of the tire.
- **Manufacturing date:** manufacturing date **5** provides information about the age of a tire. The 1st and 2nd positions represent the calendar week and the 3rd and 4th positions state the year of manufacture (e.g. "3208" represents the 32nd week of 2008).

#### Information on the maximum tire load

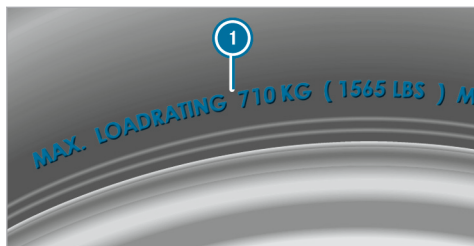

**i** The data shown in the image is example data.

Maximum tire load **1** is the maximum permissible weight for which the tire is approved.

Do not overload the tires by exceeding the specified load limit. The maximum permissible load can be found on the vehicle's Tire and Loading Information placard on the B-pillar on the driver's side (→ page 272).

#### Specifications for maximum tire pressure



**i** The data shown in the image is example data.



Never exceed maximum tire pressure ❶ specified for the tire.

### Information on tire characteristics



❶ The data shown in the image is example data.

This information describes the type of tire cord and the number of layers in side wall ❶ and under tire tread ❷.

### Tire size designation, load-bearing capacity, speed rating and load index

**⚠ WARNING** Risk of injury through exceeding the specified tire load rating or the permissible speed rating

Exceeding the specified tire load rating or the permissible speed rating may lead to tire damage and to the tires bursting.

- ▶ Therefore, only use tire types and sizes approved for your vehicle model.
- ▶ Observe the tire load rating and speed rating required for your vehicle.

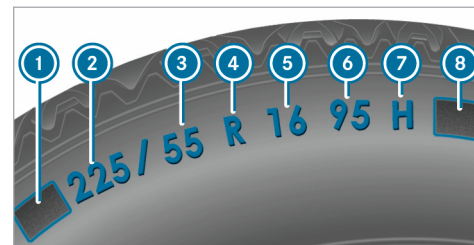

- ❶ Preceding letter
- ❷ Nominal tire width in millimeters
- ❸ Aspect ratio in %
- ❹ Tire code
- ❺ Rim diameter
- ❻ Load-bearing index
- ❼ Speed rating
- ❽ Load index

❶ The data shown in the image is example data.

Information about reading tire data can be obtained from any qualified specialist workshop.

**Preceding letter 1:**

- Without: passenger vehicle tires according to European manufacturing standards.
- "P": passenger vehicle tires according to US manufacturing standards.
- "LT": light truck tires according to US manufacturing standards.
- "T": compact emergency spare wheels with high tire pressure that are only designed for temporary use in an emergency.

**Aspect ratio 3:**

Ratio between tire height and tire width in percent (tire height divided by tire width).

**Tire code 4 (tire type):**

- "R" radial tire
- "D": bias ply tire
- "B": bias belted tires
- "ZR": radial tire with a maximum speed above 149 mph (240 km/h) (optional)

**Rim diameter 5:**

The diameter of the bead seat (not the diameter of the rim flange). The rim diameter is specified in inches (in).

**Load-bearing index 6:**

Numerical code that specifies the maximum load-bearing capacity of a tire (e.g. "91" corresponds to 1356 lbs (615 kg)).

The load-bearing capacity of the tire must be at least half the permissible axle load of your vehicle. Do not overload the tires by exceeding the specified load limit.

See also:

- Maximum permissible load on the Tire and Loading Information placard (→ page 272)
- Maximum tire load (→ page 278)
- Load index

**Speed rating 7:**

Specifies the approved maximum speed of the tire.

**i** An electronic speed limiter prevents your vehicle from exceeding a speed of 130 mph (210 km/h).

Make sure that your tires have the required speed rating. You can obtain information on the required speed rating from an authorized Mercedes-Benz Center.

**Summer tires**

| Index | Speed rating             |
|-------|--------------------------|
| Q     | up to 100 mph (160 km/h) |
| R     | up to 106 mph (170 km/h) |
| S     | up to 112 mph (180 km/h) |
| T     | up to 118 mph (190 km/h) |
| H     | up to 130 mph (210 km/h) |
| V     | up to 149 mph (240 km/h) |
| W     | up to 168 mph (270 km/h) |
| Y     | up to 186 mph (300 km/h) |

| Index                   | Speed rating             |
|-------------------------|--------------------------|
| ZR...Y <sup>4</sup>     | up to 186 mph (300 km/h) |
| ZR...(..Y) <sup>4</sup> | over 186 mph (300 km/h)  |
| ZR <sup>4</sup>         | over 149 mph (240 km/h)  |

- Specifying the speed rating as the "ZR" index in tire code ④ is optional for tires up to 186 mph (300 km/h).
- If your tire code ④ includes "ZR" and there is no speed rating ⑦, find out what the maximum speed is from the tire manufacturer.
- If load-bearing index ⑥ and speed rating ⑦ are in brackets, the maximum speed rating of your tire is above 186 mph (300 km/h). To find out the maximum speed, ask the tire manufacturer.

<sup>4</sup> "ZR" stated in the tire code.

<sup>5</sup> Or "M+S"  " for winter tires

### All-weather tires and winter tires

| Index              | Speed rating             |
|--------------------|--------------------------|
| Q M+S <sup>5</sup> | up to 100 mph (160 km/h) |
| T M+S <sup>5</sup> | up to 118 mph (190 km/h) |
| H M+S <sup>5</sup> | up to 130 mph (210 km/h) |
| V M+S <sup>5</sup> | up to 149 mph (240 km/h) |

Winter tires bear the  snowflake symbol and fulfill the requirements of the Rubber Manufacturers Association (RMA) and the Rubber Association of Canada (RAC) regarding the tire traction on snow.

### Load index ⑧:

- No specification given: standard load (SL) tire
- "XL" or "Extra Load": extra load tire or reinforced tire
- "Light Load": light load tire

- "C", "D", "E": a load range that depends on the maximum load that the tire can carry at a certain pressure

### Definition of terms for tires and loading

**Tire structure and characteristics:** describes the number of layers or the number of rubber-coated belts in the tire contact surface and the tire wall. These are made of steel, nylon, polyester and other materials.

**Bar:** metric unit for tire pressure. 14.5038 pounds per square inch (psi) and 100 kilopascal (kPa) is the equivalent of one bar.

**DOT (Department of Transportation):** DOT-marked tires fulfill the requirements of the US Department of Transportation.

**Average weight of the vehicle occupants:** the number of vehicle occupants for which the vehicle is designed, multiplied by 150 lb (68 kg).

**Uniform Tire Quality Grading Standards:** a uniform standard to grade the quality of tires with regard to tread quality, tire traction and temperature characteristics. The quality grading assessment is made by the manufacturer following specifications from the U.S. government. The quality grade of a tire is imprinted on the side wall of the tire.

**Recommended tire pressure:** the recommended tire pressure is the tire pressure specified for the tires mounted to the vehicle at the factory.

The tire and information table contains the recommended tire pressures for cold tires, the maximum permissible load and the maximum permissible vehicle speed.

The tire pressure table contains the recommended tire pressures for cold tires under various operating conditions, i.e. loading and/or speed of the vehicle.

**Increased vehicle weight due to optional equipment:** the combined weight of all standard and optional equipment available for the vehicle,

regardless of whether it is actually installed on the vehicle or not.

**Rim:** the part of the wheel on which the tire is installed.

**GAWR (Gross Axle Weight Rating):** the GAWR is the maximum permissible axle load. The actual load on an axle must never exceed the gross axle weight rating. The gross axle weight rating can be found on the vehicle identification plate on the B-pillar on the driver's side.

**Speed rating:** the speed rating is part of the tire identification. It specifies the speed range for which a tire is approved.

**GVW (Gross Vehicle Weight):** the gross vehicle weight comprises the weight of the vehicle including fuel, tools, the spare wheel, accessories installed, occupants, luggage and the trailer drawbar noseweight, if applicable. The gross vehicle weight must not exceed the gross vehicle weight rating GVWR as specified on the vehicle identification plate on the B-pillar on the driver's side.

**GVWR (Gross Vehicle Weight Rating):** the GVWR is the maximum permitted gross weight

of the fully laden vehicle (weight of the vehicle including all accessories, occupants, fuel, luggage and the trailer drawbar noseweight if applicable). The gross vehicle weight rating is specified on the vehicle identification plate on the B-pillar on the driver's side.

**Maximum weight of the laden vehicle:** the maximum weight is the sum of the curb weight of the vehicle, the weight of the accessories, the maximum load and the weight of optional equipment installed at the factory.

**Kilopascal (kPa):** metric unit for tire pressure. 6.9 kPa corresponds to 1 psi. Another unit for tire pressure is bar. 100 kilopascal (kPa) equals 1 bar.

**Load index:** in addition to the load-bearing index, the load index may also be imprinted on the side wall of the tire. This specifies the load-bearing capacity of the tire more precisely.

**Curb weight:** the weight of a vehicle with standard equipment including the maximum capacity of fuel, oil and coolant. It also includes the air conditioning system and optional equipment if

these are installed on the vehicle, but does not include passengers or luggage.

**Maximum tire load:** the maximum tire load is the maximum permissible weight in kilograms or lbs for which a tire is approved.

**Maximum permissible tire pressure:** maximum permissible tire pressure for one tire.

**Maximum load on one tire:** maximum load on one tire. This is calculated by dividing the maximum axle load of one axle by two.

**PSI (pounds per square inch):** standard unit of measurement for tire pressure.

**Aspect ratio:** ratio between tire height and tire width in percent.

**Tire pressure:** pressure inside the tire applying an outward force to every square inch of the tire. The tire pressure is specified in pounds per square inch (psi), in kilopascals (kPa) or in bar. The tire pressure should only be corrected when the tires are cold.

**Cold tire pressure:** the tires are cold when the vehicle has been parked for at least 3 hours

without direct sunlight on the tires or the vehicle has been driven for less than 1 mile (1.6 km).

**Tire contact surface:** the part of the tire that comes into contact with the road.

**Tire bead:** the purpose of the tire bead is to ensure that the tire sits securely on the wheel rim. There are several wire cores in the tire bead to prevent the tire from changing length on the wheel rim.

**Side wall:** the part of the tire between the tread and the tire bead.

**Weight of optional equipment:** the combined weight of the optional equipment weighing more than the replaced standard parts and more than 5 lbs (2.3 kg). This optional equipment, such as high-performance brakes, level control system, a roof luggage rack or high-performance batteries, is not included in the curb weight and the weight of the accessories.

**TIN (Tire Identification Number):** a unique identification number which can be used by a tire manufacturer to identify tires, for example, in a product recall, and thus identify the purchasers. The TIN is made up of the manufactur-

er's identity code, tire size, tire type code and the manufacturing date.

**Load-bearing index:** the load-bearing index is a code that contains the maximum load-bearing capacity of a tire.

**Traction:** traction is the grip resulting from friction between the tires and the road surface.

**Wear indicator:** narrow bars (tread wear bars) that are distributed over the tire contact surface. If the tire tread is level with the bars, the wear limit of 1/16 in (1.6 mm) has been reached.

**Distribution of vehicle occupants:** distribution of vehicle occupants over designated seat positions in a vehicle.

**Maximum permissible payload weight:** nominal load and luggage load plus 150 lb (68 kg) multiplied by the number of seats in the vehicle.

## Changing a wheel

### Notes on selecting, installing and replacing tires

**Mercedes-AMG vehicles:** observe the notes in the Supplement. You could otherwise fail to recognize dangers.

**⚠ WARNING** Risk of accident due to incorrect dimensions of wheels and tires

If wheels and tires of the wrong size are installed, the wheel brakes or wheel suspension components may be damaged.

- ▶ Always replace wheels and tires with those that fulfill the specifications of the original part.

When replacing wheels, make sure to fit the correct:

- Designation
- Model

When replacing tires, make sure to install the correct:

- Designation
- Manufacturer
- Model

**⚠ WARNING** Risk of injury through exceeding the specified tire load-bearing capacity or the permissible speed rating

Exceeding the specified tire load rating or the permissible speed rating may lead to tire damage and to the tires bursting.

- ▶ Therefore, only use tire types and sizes approved for your vehicle model.
- ▶ Observe the tire load rating and speed rating required for your vehicle.

**! NOTE** Vehicle and tire damage through tire types and sizes that have not been approved

For safety reasons, only use tires, wheels and accessories which have been specially approved by Mercedes-Benz for your vehicle. These tires are specially adapted to the control systems, such as ABS, ESP® and 4MATIC, and marked as follows:

- MO = Mercedes-Benz Original
- MOE = Mercedes-Benz Original Extended (run-flat tire only for certain wheels)
- MO1 = Mercedes-Benz Original (only certain AMG tires)

Certain characteristics, such as handling, vehicle noise emissions, consumption, etc. may otherwise be adversely affected. Furthermore, other tire sizes could result in the tires rubbing against the body and axle components when loaded. This could result in damage to the tire or the vehicle.

Only use tires, wheels and accessories that have been checked and recommended by Mercedes-Benz.

**!** **NOTE** Risk to driving safety from retreaded tires

Retreaded tires are neither tested nor recommended by Mercedes-Benz, since previous damage cannot always be detected on retreaded tires.

For this reason driving safety cannot be guaranteed.

- ▶ Do not use used tires if you have no information about their previous usage.

**!** **NOTE** Possible damage to wheels or tires when driving over obstacles

Large wheels have a lower tire section width. The lower the tire section width, the greater is the risk of damage to wheels or tires when driving over obstacles.

- ▶ Avoid obstacles or drive particularly carefully.

**!** **NOTE** Possible wheel and tire damage when parking on curbs or in potholes

Parking on curbs or in potholes may damage the wheels and tires.

- ▶ If possible, park only on flat surfaces.
- ▶ Avoid curbs and potholes when parking.

**!** **NOTE** Damage to electronic component parts from the use of tire-mounting tools

**Vehicles with a tire pressure monitoring system:** Electronic component parts are located in the wheel. Tire-mounting tools should not be used in the area of the valve.

This could otherwise damage the electronic component parts.

- ▶ Have the tires changed at a qualified specialist workshop only.

**!** **NOTE** Damage to summer tires at low ambient temperatures

At low ambient temperatures, tears could form when driving with summer tires, causing permanent damage to the tires.

- ▶ At temperatures below 45 °F (7 °C), use M+S tires .

Accessory parts that are not approved for your vehicle by Mercedes-Benz or are not being used correctly can impair the operating safety.

Before purchasing and using non-approved accessories, visit a qualified specialist workshop and inquire about:

- Suitability
- Legal stipulations
- Factory recommendations

**⚠** **WARNING** Risk of accident with high performance tires

There is an increased risk of skidding and hydroplaning when using sport tires on wet roads.

In addition, the tire grip is greatly reduced at a low outside temperature and tire running temperature.

- ▶ Activate ESP® and adapt your driving style accordingly.
- ▶ Use M+S tires at outside temperatures below 50 °F (10 °C).
- ▶ Only use the tires for their intended purpose.

Observe the following when selecting, installing and replacing tires:

- Furthermore, the use of certain tire types in certain regions and areas of operation can be highly beneficial.
- Only use tires and wheels of the same type (summer tires, winter tires, MOExtended tires) and the same make.
- Only install wheels of the same size on one axle (left and right).

It is only permissible to install a different wheel size in the event of a flat tire in order to drive to the specialist workshop.

- **Vehicles with a tire pressure monitoring system:** All installed wheels must be equipped with functioning sensors for the tire pressure monitoring system.
- At temperatures below 45 °F (7 °C) use winter tires or all-season tires marked M+S for all wheels.

Winter tires bearing the  snowflake symbol in addition to the M+S marking provide the best possible grip in wintry road conditions.

- For M+S tires, only use tires with the same tread.
- Observe the maximum permissible speed for the M+S tires installed.

If the tire's maximum speed is below that of the vehicle, this must be indicated by an appropriate label in the driver's field of vision.

- Break in new tires at moderate speeds for the first 60 miles (100 km).
- Replace the tires after six years at the latest, regardless of wear.

- **When replacing with tires that do not feature run-flat characteristics:** vehicles with MOExtended tires are not equipped with a TIREFIT kit at the factory. Equip the vehicle with a TIREFIT kit after replacing with tires that do not feature run-flat characteristics, e.g. winter tires.

For more information on wheels and tires, contact a qualified specialist workshop.

Be sure to also observe the following further related subjects:

- Notes on tire pressure (→ page 265)
- Tire and Loading Information placard (→ page 272)
- Tire size designation, load-bearing capacity, speed rating and load index (→ page 279)
- Tire pressure table (→ page 267)
- Notes on the emergency spare wheel (→ page 293)



### Notes on rotating wheels

**▲ WARNING** Risk of injury through different wheel sizes

Interchanging the front and rear wheels if the wheels or tires have different dimensions may severely impair the driving characteristics.

The wheel brakes or wheel suspension components may also be damaged.

- ▶ Rotate front and rear wheels only if the wheels and tires are of the same dimensions.

The wear patterns on the front and rear wheels differ:

- Front wheels wear more on the shoulder of the tire
- Rear wheels wear more at the center of the tire

Do not drive with tires that have too little tread depth. This significantly reduces traction on wet roads (hydroplaning).

On vehicles that have the same size front and rear wheels, rotate the wheels according to the intervals in the tire manufacturer's warranty book in your vehicle documents. If this is not available, rotate the tires every 3,000 to 6,000 miles (5,000 to 10,000 km), depending on the wear. Ensure that the direction of rotation is maintained.

Observe the instructions and safety notes on "Changing a wheel" when doing so (→ page 288).

### Notes on storing wheels

When storing wheels, observe the following notes:

- After removing wheels, store them in a cool, dry and preferably dark place.
- Protect the tires from contact with oil, grease or fuel.

### Overview of the tire-change tool kit

**Mercedes-AMG vehicles:** observe the notes in the Supplement. You could otherwise fail to recognize dangers.

Apart from some country-specific variants, vehicles are not equipped with a tire-change tool kit. For more information on which tire-changing tools are required and approved for performing a wheel change on your vehicle, consult a qualified specialist workshop.

You require the following tools, for example, to change a wheel:

- Jack
- Chock
- Lug wrench
- Alignment bolt

The tire-change tool kit is located in tool bag ① in the cargo compartment.

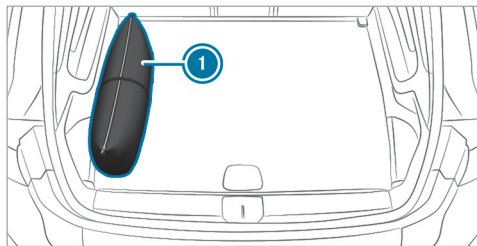

The tool bag contains:

- Jack
- Gloves
- Lug wrench
- Alignment bolt
- Folding chock
- Ratchet for jack

### Preparing the vehicle for a wheel change

#### Requirements:

- The required tire-change tool is available. If your vehicle is not equipped with the tire-

change tool kit, consult a qualified specialist workshop to find out about suitable tools.

- The vehicle is not on a slope.
  - The vehicle is on solid, non-slippery and level ground.
- ▶ Apply the electric parking brake manually.
  - ▶ Move the front wheels to the straight-ahead position.
  - ▶ **Vehicles with automatic transmission:** Shift into position **P**.
  - ▶ Switch off the engine.
  - ▶ Make sure that the engine cannot be started.
  - ▶ Place chocks or other suitable items under the front and rear of the wheel that is diagonally opposite the wheel you wish to change.
  - ▶ Remove the hub caps if necessary (→ page 288).
  - ▶ Raise the vehicle (→ page 288).

### Removing and installing hub caps

#### Requirements:

- The vehicle is prepared for a wheel change (→ page 288).

#### Plastic hub cap

- ▶ **To remove:** turn the center cover of the hub cap counter-clockwise and remove the hub cap.
- ▶ **To install:** make sure that the center cover of the hub cap is turned counter-clockwise.
- ▶ Position the hub cap and turn the center cover clockwise until the hub cap engages physically and audibly.

### Raising the vehicle when changing a wheel

#### Requirements:

- There are no persons in the vehicle.
- The vehicle has been prepared for a wheel change (→ page 288).
- The hub caps have been removed (→ page 288).

## Important notes on using the jack:

- Use only a vehicle-specific jack that has been approved by Mercedes-Benz to raise the vehicle.
- The jack is only designed for raising and holding the vehicle for a short time while a wheel is being changed and not for maintenance work under the vehicle.
- The jack must be placed on a firm, flat and non-slip surface. If necessary, use a large, flat, load-bearing, non-slip underlay.
- The foot of the jack must be positioned vertically under the jack support point.

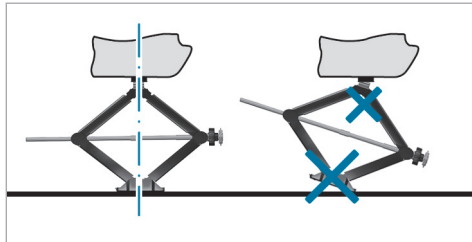

## Rules of conduct when the vehicle is raised:

- Never place your hands or feet under the vehicle.
- Never lie under the vehicle.
- Do not start the engine and do not release the electric parking brake.
- Do not open or close any doors or the tailgate.

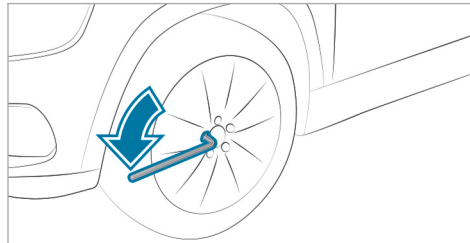

- ▶ Using the lug wrench, loosen the wheel bolts on the wheel you wish to change by about one full turn. Do not unscrew the bolts completely.

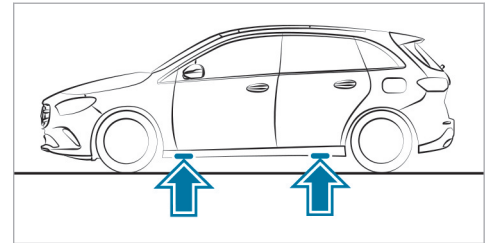

## Position of jack support points

**Mercedes-AMG vehicles:** observe the notes in the Supplement. You could otherwise fail to recognize dangers.

**⚠ WARNING** Risk of injury from incorrect positioning of the jack

If you do not position the jack correctly at the appropriate jacking point of the vehicle, the jack could tip with the vehicle raised.

- ▶ Only position the jack at the appropriate jacking point of the vehicle. The base of the jack must be positioned

vertically under the jacking point of the vehicle.

**! NOTE** Vehicle damage from the jack

If you do not position the jack correctly at the appropriate jack support point of the vehicle, the jack could tip over with the vehicle raised.

▶ The jack is designed exclusively for jacking up the vehicle at the jack support points.

▶ Take the ratchet out of the tire-change tool kit and place it on the hexagon nut of the jack so that the letters "AUF" are visible.

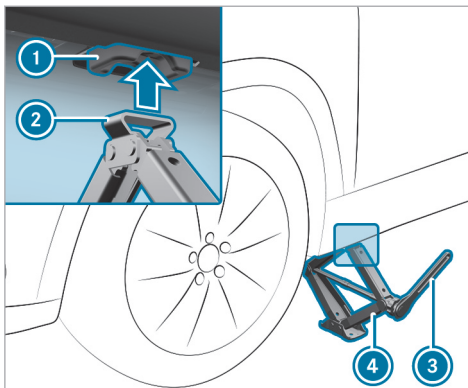

- ▶ Position jack ② at jack support point ①.
- ▶ Turn ratchet ③ clockwise until jack ② sits completely on jack support point ① and the base of the jack lies evenly on the ground.
- ▶ Turn ratchet ③ until the tire is raised a maximum of 1.2 in (3 cm) from the ground.
- ▶ Loosen and remove the wheel (→ page 290).

### Removing a wheel

**Requirements:**

- The vehicle is raised (→ page 288).

When changing a wheel, avoid applying any force to the brake discs, since this could impair the level of comfort when braking.

**! NOTE** Damage to threading from dirt on wheel bolts

▶ Do not place wheel bolts in sand or on a dirty surface.

▶ Unscrew the uppermost wheel bolt completely.

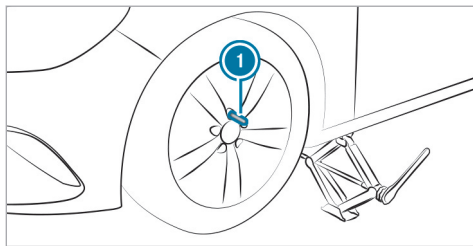

- ▶ Screw alignment bolt ① into the thread instead of the wheel bolt.
- ▶ Unscrew the remaining wheel bolts completely.
- ▶ Remove the wheel and, if necessary, store it in the cargo compartment.
- ▶ Notes on removing an emergency spare wheel (→ page 293).

### Mounting a new wheel

#### Requirements:

- The wheel is removed (→ page 290).

**⚠ WARNING** Risk of accident from losing a wheel

Oiled, greased or damaged wheel bolt/wheel nut threads or wheel hub/wheel mounting bolt threads can cause the wheel bolts/wheel nuts to come loose.

As a result, you could lose a wheel while driving.

- ▶ Never oil or grease the threads.
- ▶ In the event of damage to the threads, contact a qualified specialist workshop immediately.
- ▶ Have the damaged wheel bolts or damaged hub threads replaced.
- ▶ Do not continue driving.

- ▶ Observe the information on the choice of tires (→ page 284).

For tires with a specified direction of rotation, an arrow on the side wall of the tire indicates the correct direction of rotation. Observe the direction of rotation when installing.

- ▶ Slide the wheel to be mounted onto the alignment bolt and push it on.
- ▶ Notes on installing an emergency spare wheel (→ page 293).

**⚠ WARNING** Risk of injury from tightening wheel bolts and nuts

If you tighten the wheel bolts or wheel nuts when the vehicle is raised, the jack could tip.

- ▶ Only tighten wheel bolts or wheel nuts when the vehicle is on the ground.
- ▶ Be sure to observe the instructions and safety notes on "Changing a wheel" (→ page 284).
- ▶ For safety reasons, only use wheel bolts which have been approved by Mercedes-Benz and for the wheel in question.

- NOTE** Damage to paintwork of the wheel rim when screwing on the first wheel bolt

If the wheel has too much play when screwing in the first wheel bolt, the wheel rim paint can be damaged.

- ▶ Press the wheel firmly against the wheel hub when screwing on the first wheel bolt.

- ▶ Tighten the wheel bolts evenly in a diagonal pattern in the order indicated until they are finger-tight.
- ▶ Unscrew the alignment bolt.
- ▶ Tighten the last wheel bolt until it is finger-tight.
- ▶ Lower the vehicle (→ page 292).

### Lowering the vehicle after a wheel change

#### Requirements:

- The new wheel has been installed (→ page 291).

- ▶ **To lower the vehicle:** place the ratchet onto the hexagon nut of the jack so that the letters "AB" are visible and turn the ratchet of the jack to the left.

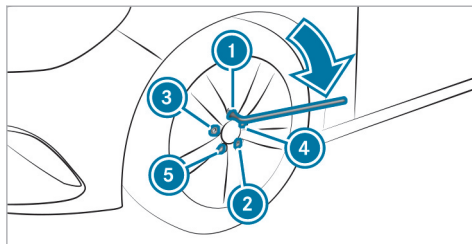

- ▶ Tighten the wheel bolts evenly in a diagonal pattern in the order indicated ① to ⑤ with a maximum of 59 lb-ft (80 Nm).
- ▶ Tighten the wheel bolts evenly in a diagonal pattern in the order indicated ① to ⑤ the specified tightening torque of 96 lb-ft (130 Nm).

- ▶ **WARNING** Risk of injury through incorrect tightening torque

The wheels could come loose if the wheel bolts or wheel nuts are not tightened to the prescribed tightening torque.

- ▶ Ensure that the wheel bolts or nuts are tightened to the prescribed tightening torque.
- ▶ If you are not sure, do not move the vehicle. Consult a qualified specialist workshop and have the tightening torque checked immediately.

- ▶ Check the tire pressure of the newly installed wheel and adjust it if necessary.
- ▶ **Vehicles with tire pressure loss warning system:** Restart the tire pressure loss warning system (→ page 271).  
**Exception:** the new wheel is an emergency spare wheel.

- ▶ **Vehicles with a tire pressure monitoring system:** Restart the tire pressure monitoring system (→ page 270).  
**Exception:** the new wheel is an emergency spare wheel.

## Emergency spare wheel

### Notes on the emergency spare wheel

**⚠ WARNING** Risk of accident caused by incorrect wheel and tire dimensions

The wheel or tire size and the tire type of the emergency spare wheel or spare wheel and the wheel to be replaced may differ. The emergency spare wheel or spare wheel can significantly impair driving characteristics of the vehicle.

To prevent hazardous situations:

- ▶ Adapt your driving style accordingly and drive carefully.

- ▶ Never install more than one emergency spare wheel or spare wheel that differs in size.
- ▶ Only use an emergency spare wheel or spare wheel of a different size briefly.
- ▶ Do not switch off ESP®.
- ▶ Have the emergency spare wheel or spare wheel of a different size replaced at the nearest qualified specialist workshop. The new wheel must have the correct dimensions.

- ⓘ The deflated emergency spare wheel is secured in the emergency spare wheel bag in the cargo compartment and is secured to the adjustable cargo compartment floor in the lower position.

Observe the following notes on removing an emergency spare wheel:

- Before stowing the emergency spare wheel, make sure there is no air left in the tire. If necessary, allow the air to escape.

- **To release air from the tire:** remove the valve cap of the tire.
- Press down the metal insert in the valve using a pointed object, e.g. a pen.
- Screw the valve cap onto the valve.

Observe the following notes on installing an emergency spare wheel:

- Check the tire pressure of the emergency spare wheel installed. Correct the pressure as necessary.
  - The maximum permissible speed with an emergency spare wheel installed is 50 mph (80 km/h).
  - Do not install snow chains on the emergency spare wheel.
  - Replace the emergency spare wheel after six years at the latest, regardless of wear.
- ⓘ **Vehicles with a tire pressure loss warning system:** If an emergency spare wheel is installed, the tire pressure loss warning system cannot function reliably. Only restart the system again when the emergency spare wheel has been replaced with a new wheel.

**Vehicles with a tire pressure monitoring system:**

If an emergency spare wheel is installed, the tire pressure monitoring system cannot function reliably. For a few minutes after an emergency spare wheel is installed, the system may still display the tire pressure of the removed wheel. Only restart the system again when the emergency spare wheel has been replaced with a new wheel.

Be sure to also observe the following further related subjects:

- Notes on tire pressure (→ page 265)
- Tire and Loading Information placard (→ page 272)
- Tire pressure table (→ page 267)
- Notes on installing tires (→ page 284)

**Inflating the emergency spare wheel**

**NOTE** Overheating due to the tire inflation compressor running too long

▶ Do not run the tire inflation compressor for longer than ten minutes without interruption.

**Requirements:**

Comply with the manufacturer's safety notes on the sticker of the emergency spare wheel and on the tire inflation compressor.

- ▶ Remove sticker with the label 50 mph (80 km/h) from the tire inflation compressor housing and affix it to the instrument cluster within the driver's field of vision.
- ▶ Remove the tire inflation compressor from the storage space under the cargo compartment floor (→ page 247).

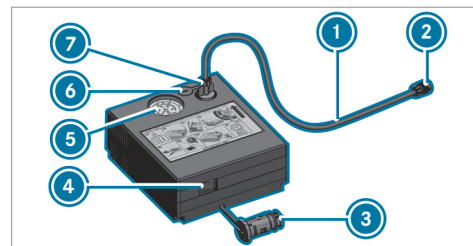

- ▶ Pull filler hose ① and plug ③ out of the tire inflation compressor housing.
- ▶ Insert plug ⑦ of filler hose ① in the socket on the tire inflation compressor and then turn it until plug ⑦ engages.
- ▶ Unscrew the cap from the valve on the emergency spare wheel.
- ▶ Screw union nut ② of filler hose ① onto valve .
- ▶ Make sure on and off switch ④ of the tire inflation compressor is set to 0.
- ▶ Insert plug ③ in a socket in your vehicle.
  - 12 V socket: (→ page 109)



- Observe the notes on sockets: (→ page 109)
  - ▶ Press the start/stop button once to switch on the power supply. (→ page 132)
  - ▶ Press On/Off switch ④ on the tire inflation compressor to **I**.  
The tire inflation compressor is switched on. The tire is inflated. The tire pressure is shown on manometer ⑤.
  - ▶ Pump the tire to the specified tire pressure.
  - ⓘ The specified tire pressure is stated on the label of the emergency spare wheel.
  - ▶ When the specified tire pressure has been reached, press on and off switch ④ on the tire inflation compressor to **O**.  
The tire inflation compressor is switched off.
  - ▶ Press the start/stop button to switch off the power supply.
  - ▶ If the tire pressure is higher than the specified pressure, press pressure release valve button ⑥ until the correct tire pressure has been reached.
- ▶ Unscrew union nut ② of filler hose ① from the valve.
  - ▶ Screw the valve cap of the emergency spare wheel onto the valve again.
  - ▶ Store filler hose ① and plug ③ in the lower section of the tire inflation compressor housing.
  - ▶ Store the tire inflation compressor in the vehicle.

### Notes on technical data

**Mercedes-AMG vehicles:** be sure to observe the notes in the Supplement. Otherwise, you may fail to recognize dangers.

The data stated only applies to vehicles with standard equipment. You can obtain further information from an authorized Mercedes-Benz Center.

### Vehicle electronics

#### Two-way radios

##### Notes on installing two-way radios

**⚠ WARNING** Risk of accident due to improper work on two-way radios

If two-way radios are manipulated or retrofitted incorrectly, the electromagnetic radiation from the two-way radios can interfere with the vehicle electronics and jeopardize the operating safety of the vehicle.

▶ You should have all work on electrical and electronic components carried out at a qualified specialist workshop.

**⚠ WARNING** Risk of accident from incorrect operation of two-way radios

If you operate two-way radios incorrectly in the vehicle, the electromagnetic radiation could interfere with the on-board electronics, for example, if:

- The tow-way radio is not connected to an exterior antenna
- If the exterior antenna is not correctly mounted or is not of low reflection

This could jeopardize the operating safety of the vehicle.

- ▶ Have the low-reflection exterior antenna installed at a qualified specialist workshop.
- ▶ When operating two-way radios in the vehicle, always connect them to the low-reflection exterior antenna.

**! NOTE** Invalidation of the operating permit due to failure to comply with the instructions for installation and use

The operating permit may be invalidated if the instructions for installation and use of two-way radios are not observed.

- ▶ Only use approved frequency bands.
- ▶ Observe the maximum permissible output power in these frequency bands.
- ▶ Only use approved antenna positions.

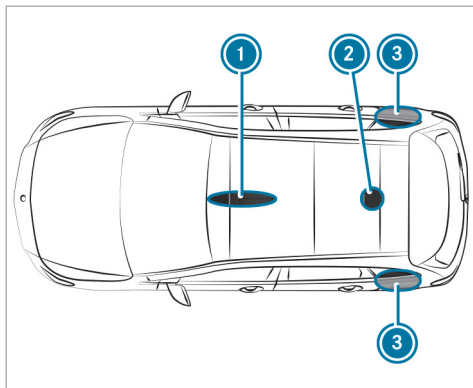

- ① Front roof area
- ② Rear roof area
- ③ Rear fenders

On vehicles with a panoramic sliding sunroof, installing an antenna to the front or rear roof area is not permitted.

On the rear fenders, it is recommended that you install the antenna on the side of the vehicle closest to the center of the road.

Use Technical Specification ISO/TS 21609 (Road Vehicles - "EMCs for installation of aftermarket radio frequency transmitting equipment") when retrofitting two-way radios. Comply with the legal requirements for detachable parts.

If your vehicle has installing for two-way radio equipment, use the power supply and antenna connectors provided in the pre-installation. Observe the manufacturer's supplements when installing.

#### Two-way radio transmission output

The maximum transmission output (PEAK) at the base of the antenna must not exceed the values in the following table.

#### Frequency band and maximum transmission output

| Frequency band  | Maximum transmission output |
|---|-----------------------------|
| 2 m frequency band<br>144 - 174 MHz                   | 50 W                        |
| Terrestrial Trunked<br>Radio (TETRA)<br>380 - 460 MHz | 10 W                        |
| 70 cm frequency<br>band<br>430 - 470 MHz              | 35 W                        |
| Two-way radio<br>2G                                   | 2 W                         |
| Two-way radio<br>3G/4G/5G                             | 0.5 W                       |

The following can be used in the vehicle without restrictions:

- two-way radios with a maximum transmission output of up to 100 mW
- RF transmitters with transmitter frequencies in the 380 - 410 MHz frequency band and a maximum transmission output of up to 2 W (trunked radio system/Tetra)
- mobile phones (2G/3G/4G/5G)

There are no restrictions when positioning the antenna on the outside of the vehicle for some wavebands.

- Terrestrial Trunked Radio (TETRA)
- 70 cm frequency band
- 2G/3G/4G/5G

### Vehicle identification plate, VIN and engine number overview

#### Vehicle identification plate

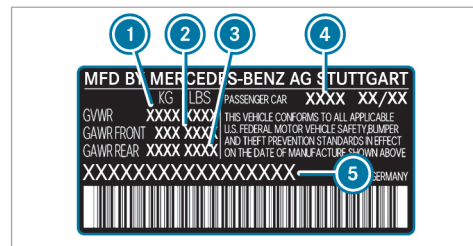
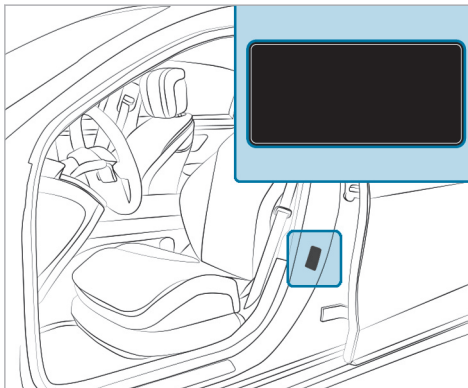

Vehicle identification plate (USA only)

- 1 Maximum permissible gross vehicle weight
- 2 Maximum permissible front axle load
- 3 Maximum permissible rear axle load
- 4 Paint code
- 5 VIN (vehicle identification number)

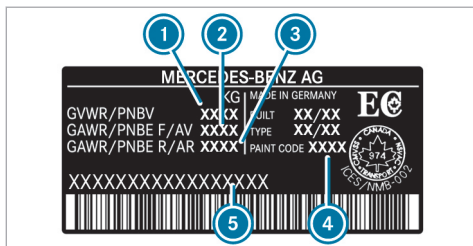

Vehicle identification plate (Canada only)

- ① Maximum permissible gross vehicle weight
- ② Maximum permissible front axle load
- ③ Maximum permissible rear axle load
- ④ Paint code
- ⑤ VIN (vehicle identification number)

The maximum permissible gross vehicle weight is made up of the vehicle weight, all vehicle occupants, the fuel and the load. The maximum gross axle weight rating is the maximum weight that can be carried on one axle (front or rear axle).

Do not exceed the maximum gross vehicle weight or the maximum gross axle weight rating for the front or rear axle.

### VIN, engine number and other signs

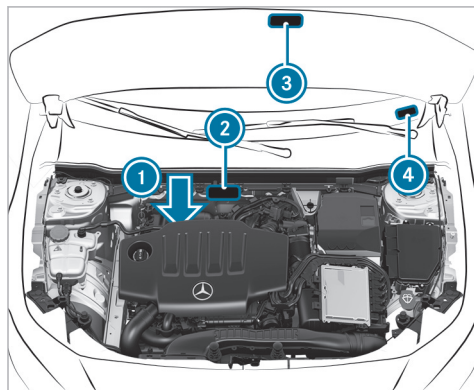

- ① Engine number stamped into the crankcase
- ② VIN (vehicle identification number) stamped into the crossmember

- ③ Plate with information about emissions testing, including confirmation of emissions guidelines at the U.S. federal level as well as for California
- ④ VIN as a label at the lower edge of the windshield

### Operating fluids

#### Notes on operating fluids

**Mercedes-AMG vehicles:** be sure to observe the notes in the Supplement. You could otherwise fail to recognize dangers.

**⚠ WARNING** Risk of injury from operating fluids harmful to your health

Operating fluids may be poisonous and harmful to your health.

- ▶ Observe the text on the original containers when using, storing or disposing of operating fluids.
- ▶ Always store operating fluids sealed in their original containers.

- ▶ Always keep children away from operating fluids.

 **ENVIRONMENTAL NOTE** Environmental pollution caused by environmentally irresponsible disposal

- ▶ Dispose of operating fluids in an environmentally responsible manner.

Operating fluids include the following:

- Fuels
- Lubricants
- Coolant
- Brake fluid
- Windshield washer fluid
- Climate control system refrigerant

Only use products approved by Mercedes-Benz. Damage caused by the use of products that have not been approved is not covered by the Mercedes-Benz warranty or goodwill gestures.

You can identify operating fluids approved by Mercedes-Benz by the following inscriptions on the container:

- MB-Freigabe (e.g. MB-Freigabe 229.51)
- MB-Approval (e.g. MB-Approval 229.51)

Further information on approved operating fluids is available at the following locations:

- In the Mercedes-Benz Specifications for Operating Fluids by entering the designation
  - At <https://bevo.mercedes-benz.com>
  - In the Mercedes-Benz BeVo app
- At a qualified specialist workshop

 **WARNING** Risk of fire or explosion from fuel

Fuels are highly flammable.

- ▶ Fire, open flames, smoking and creation of sparks must be avoided.
- ▶ Switch off the ignition and, if available, the stationary heater, before and while refueling the vehicle.

 **WARNING** Risk of injury from fuels

Fuels are poisonous and hazardous to your health.

- ▶ Do not swallow fuel or let it come into contact with skin, eyes or clothing.
- ▶ Do not inhale fuel vapor.
- ▶ Keep children away from fuel.
- ▶ Keep doors and windows closed during the refueling process.

If you or other people come into contact with fuel, observe the following:

- ▶ Immediately rinse fuel off your skin with soap and water.
- ▶ If fuel comes into contact with your eyes, immediately rinse them thoroughly with clean water. Seek medical attention immediately.
- ▶ If you swallow fuel, seek medical attention immediately. Do not induce vomiting.

- ▶ Change immediately out of clothing that has come into contact with fuel.

## Fuel

### Notes on fuel grades for vehicles with gasoline engines

Observe the notes on operating fluids (→ page 299).

#### ! NOTE Damage caused by the wrong fuel

Even small amounts of the wrong fuel could result in damage to the fuel system, the engine and the emission control system.

- ▶ Only refuel with low-sulfur unleaded fuel.

This fuel may contain up to 10% ethanol by volume. Your vehicle is suitable for use with E10 fuel.

Never refuel with one of the following fuels:

- Diesel

- Gasoline with more than 10% ethanol by volume, e.g. E15, E85, E100
- Gasoline with more than 3% methanol by volume, e.g. M15, M30, M85, M100
- Gasoline with additives containing metal

If you have accidentally refueled with the wrong fuel:

- ▶ Do not switch the ignition on.
- ▶ Consult a qualified specialist workshop.

If the available fuel is not sufficiently low in sulfur, this can produce unpleasant odors.

Only refuel with fuel that has at least the octane number specified in the information label in the fuel filler flap (→ page 152). Otherwise engine output can be reduced and fuel consumption increased.

**If you want maximum engine output:** only refuel with unleaded premium grade gasoline with an octane number of at least 91 AKI/95 RON.

As a temporary measure, if the recommended fuel is not available, you may also refuel with

unleaded regular gasoline with at least 87 AKI/91 RON. This may reduce engine output and increase fuel consumption.

Never refuel using gasoline with an even lower RON.

#### ! NOTE Premature wear through unleaded regular gasoline

Unleaded regular gasoline can cause the engine to wear more quickly and impair longevity and performance.

If unleaded premium grade gasoline is unavailable and you have to refuel using unleaded regular gasoline:

- ▶ Only fill the fuel tank to half full with unleaded regular gasoline and refill as soon as possible with unleaded premium grade gasoline.
- ▶ Do not drive at the maximum design speed.
- ▶ Avoid sudden acceleration engine speeds over 3000 rpm.

## 302 Technical data

Further information on fuel is available at the following locations:

- At a gas station
- At a qualified specialist workshop
- On the <https://www.mbusa.com> (USA only)

### Information on additives in gasoline

Observe the notes on operating fluids (→ page 299).

**!** **NOTE** Damage from use of unsuitable additives

Even small amounts of the wrong additive may lead to malfunctions occurring.

▶ Only add cleaning additives recommended by Mercedes-Benz to the fuel.

Mercedes-Benz recommends that you use fuel brands that have additives.

In some countries, the fuel available may not have sufficient additives. Residue could build up in the fuel injection system as a result. In this case, in consultation with an authorized Mercedes-Benz Center, the fuel may be mixed

with the cleaning additive recommended by Mercedes-Benz. Be sure to observe the notes and mixing ratios specified on the container.

### Tank content and reserve fuel

| Model      | Total capacity         |
|------------|------------------------|
| All models | 13.5 gal (51.0 liters) |

| Model      | of which reserve fuel |
|------------|-----------------------|
| All models | 1.3 gal (5.0 liters)  |

### Engine oil

#### Notes on engine oil

Observe the notes on operating fluids (→ page 299).



**!** **NOTE** Engine damage caused by an incorrect oil filter, incorrect oil or additives

- ▶ Do not use engine oils or oil filters other than those which meet the specifications necessary for the prescribed service intervals.
- ▶ Do not alter the engine oil or oil filter in order to achieve longer change intervals than prescribed.
- ▶ Do not use additives.
- ▶ Have the engine oil changed after the prescribed intervals.



Mercedes-Benz recommends that you have the oil change carried out at a qualified specialist workshop.

### Quality and capacity of engine oil

| Gasoline engines | MB-Freigabe or MB-Approval           |
|------------------|--------------------------------------|
| GLA 250          | 137.6                                |
| GLA 250 4MATIC   | 229.71*                              |
| All other models | 229.51, 229.52,<br>229.61<br>229.71* |

\* Recommended for lowest possible fuel consumption (lowest SAE viscosity class in each case; observe possible restrictions of the approved SAE viscosity classes).

To achieve the lowest possible fuel consumption, it is recommended to use the engine oil specifications marked in the table for the lowest SAE viscosity class. Possible restrictions of the approved SAE viscosity classes must be observed.

The following values refer to an oil change, including the oil filter.

| Model      | Capacity             |
|------------|----------------------|
| All models | 1.5 gal (5.5 liters) |

### Notes on brake fluid

Observe the notes on operating fluids (→ page 299).

**⚠ WARNING** Risk of an accident due to vapor pockets forming in the brake system

The brake fluid constantly absorbs moisture from the air. This lowers the boiling point of the brake fluid. If the boiling point is too low, vapor pockets may form in the brake system when the brakes are applied hard.

This causes the braking effect to be impaired.

- ▶ Have the brake fluid renewed at the specified intervals.

Have the brake fluid regularly replaced at a qualified specialist workshop. Only use a brake fluid approved by Mercedes-Benz according to MB-Freigabe or MB-Approval 331.0.

### Coolant

#### Notes on coolant

Observe the notes on operating fluids (→ page 299).

**⚠ WARNING** - Risk of fire and injury from antifreeze

If antifreeze comes into contact with hot component parts in the engine compartment, it may ignite.

- ▶ Allow the engine to cool down before adding antifreeze.
- ▶ Make sure that no antifreeze spills out next to the filler opening.
- ▶ Thoroughly clean off any antifreeze from component parts before starting the vehicle.

**!** **NOTE** Damage caused by incorrect coolant

- ▶ Only add coolant that has been pre-mixed with the required antifreeze protection.

Information on coolant is available at the following locations:

- In the Mercedes-Benz Specifications for Operating Fluids 310.1:
  - At <https://bevo.mercedes-benz.com>
  - In the Mercedes-Benz BeVo app
- At a qualified specialist workshop

**!** **NOTE** Overheating at high outside temperatures

If an inappropriate coolant is used, the engine cooling system is not sufficiently protected against overheating and corrosion at high outside temperatures.

- ▶ Always use coolant approved by Mercedes-Benz.

- ▶ Observe the instructions in the Mercedes-Benz Specifications for Operating Fluids 310.1.

Have the coolant regularly replaced at a qualified specialist workshop.

The proportion of corrosion inhibitor/antifreeze concentrate in the engine cooling system should be:

- A minimum of 50% (antifreeze protection down to approximately -35 °F (-37 °C))
- A maximum of 55% (antifreeze protection down to -49 °F (-45 °C))

#### Coolant capacity

Missing values were not yet available at the time of going to press.

| Model      | Capacity |
|------------|----------|
| All models |          |

#### Notes on windshield washer fluid

Observe the notes on operating fluids (→ page 299).

**!** **WARNING** - Risk of fire and injury from windshield washer concentrate

Windshield washer concentrate is highly flammable. It could ignite if it comes into contact with hot engine component parts or the exhaust system.

- ▶ Make sure that no windshield washer concentrate spills out next to the filler opening.

**!** **NOTE** Damage to the exterior lighting due to unsuitable windshield washer fluid

Unsuitable windshield washer fluid may damage the plastic surface of the exterior lighting.

- ▶ Only use windshield washer fluid which is also suitable for use on plastic surfaces, e.g. MB SummerFit or MB WinterFit.

**!** **NOTE** Blocked spray nozzles caused by mixing windshield washer fluids

- ▶ Do not mix MB SummerFit and MB WinterFit with other windshield washer fluids.

Do not use distilled or de-ionized water as the fill level sensor may be triggered erroneously.

Recommended windshield washer fluid:

- Above freezing point: e.g. MB SummerFit
- Below freezing point: e.g. MB WinterFit

For the correct mixing ratio, refer to the information on the antifreeze container.

Mix the washer fluid with the windshield washer fluid all year round.

## Refrigerant

### Notes on refrigerant

Observe the notes on operating fluids (→ page 299).

**!** **NOTE** Damage due to incorrect refrigerant

If a non-approved refrigerant is used, the climate control system may be damaged.

- ▶ **USA/China:** Use only R-134a refrigerant.
- ▶ **Canada:** Use only R-1234yf refrigerant.

**!** **NOTE** Damage to the climate control system due to incorrect refrigerant compressor oil

- ▶ Only use refrigerant compressor oil that has been approved by Mercedes-Benz.
- ▶ Do not mix the approved refrigerant compressor oil with a different refrigerant compressor oil.

Work on the climate control system may be carried out only by a qualified specialist workshop. All applicable regulations, as well as SAE standard J639, must be adhered to.

The information label on the climate control system for the refrigerant type and the refrigerant

compressor oil is located on the inside of the hood.

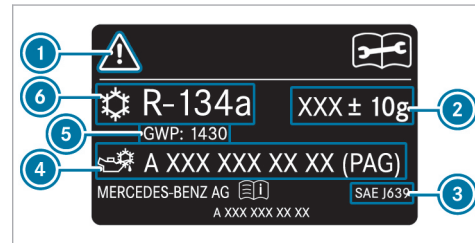

Information label (example - USA/China)

- ① Hazard and service warning symbols
- ② Refrigerant filling capacity
- ③ Applicable standards
- ④ PAG oil part number
- ⑤ GWP (Global Warming Potential) of the refrigerant used
- ⑥ Refrigerant type

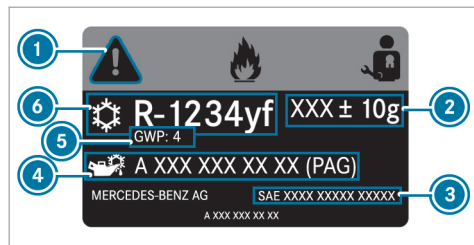

Information label (example – Canada)

- ① Hazard and service warning symbols
- ② Refrigerant filling capacity
- ③ Applicable standards
- ④ PAG oil part number
- ⑤ GWP (Global Warming Potential) of the refrigerant used
- ⑥ Refrigerant type

Symbols ① indicate the following:

- Possible dangers
- The need to have service work carried out at a qualified specialist workshop only

### Filling capacity for refrigerant and PAG oil

| Model      | Refrigerant                   |
|------------|-------------------------------|
| All models | 24.3 ± 0.4 oz<br>(690 ± 10 g) |
| Model      | PAG oil                       |
| All models | 2.8 ± 0.4 oz<br>(80 ± 10 g)   |

### Vehicle data

#### Vehicle dimensions

The heights specified may vary as a result of the following factors:

- tires
- load
- condition of the suspension
- optional equipment

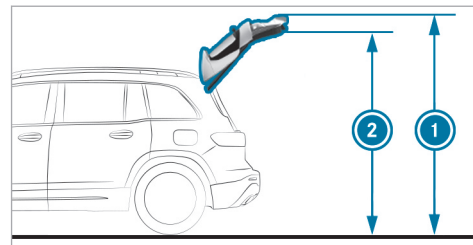

Missing values were not yet available at the time of going to press.

### Height when opened and headroom

| Model      | ① Height when opened | ② Headroom         |
|------------|----------------------|--------------------|
| All models | 83 in<br>(2119 mm)   | 75 in<br>(1907 mm) |

## Vehicle dimensions

| All models                              |                       |
|---|-----------------------|
| Vehicle length                          | 174 in<br>(4410 mm)   |
| Vehicle width including outside mirrors | 80 in<br>(2020 mm)    |
| Vehicle height                          |                       |
| Wheelbase                               | 107 in<br>(2729 mm)   |
| Turning radius                          | 37.40 ft<br>(11.40 m) |

## Weights and loads

Please observe the following notes for the specified vehicle data:

- Items of optional equipment increase the curb weight and reduce the payload.

Missing values were not yet available at the time of going to press.

| Model      | Maximum roof load |
|------------|-------------------|
| All models |                   |

## Off-road driving

### Angle of approach/departure

The specified values are maximum values for vehicles that are ready to drive.

Observe the notes on driving in mountainous terrain (→ page 139).

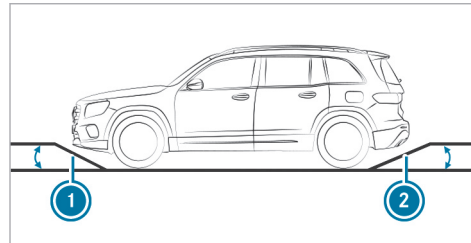

Missing values were not yet available at the time of going to press.

| Model      | ① Front | ② Rear |
|------------|---------|--------|
| All models |         |        |

### Maximum gradient climbing ability

The vehicle's gradient climbing ability depends on the weight distribution in the vehicle, the terrain conditions and the road surface conditions.

The specified value applies in the following cases:

- the vehicle is ready to drive
- the road surface conditions and thus traction are good

A gradient climbing ability of 100% corresponds to an incline of 45°.

Observe the notes on driving in mountainous terrain (→ page 139).

Missing values were not yet available at the time of going to press.

### 308 Technical data

---

| Model      | Maximum gradient climbing ability |
|------------|-----------------------------------|
| All models |                                   |

## Display messages

### Introduction



#### Notes about display messages

Display messages appear on the multifunction display.

Display messages with graphic symbols are simplified in the Operator's Manual and may differ from the symbols on the multifunction display. The multifunction display shows high-priority display messages in red. Certain display messages are accompanied by a warning tone.

Please act in accordance with the display messages and follow the additional notes in the Operator's Manual.

For some display messages, a symbol will also be shown:

-  Further information
-  Hide display message

With the left-hand Touch Control, you can select the respective symbol by swiping to the left or right. Press the  symbol to show further infor-

mation on the multifunction display. Press the  symbol to hide the display message.

You can hide low-priority display messages by pressing the  button or the left-hand Touch Control. The display messages will then be stored in the message memory.

Rectify the cause of a display message as quickly as possible.

High-priority display messages cannot be hidden. The multifunction display shows these display messages continuously until the cause of the display message has been rectified.



#### Calling up saved display messages

On-board computer:



 [Service](#)  [1 Message](#)

If there are no display messages, [No Messages](#) will appear on the multifunction display.

 Scroll through the display messages by swiping upwards or downwards on the left-hand Touch Control.

 **To exit the message memory:** press the  button.

### Occupant safety

| Display messages   | Possible causes/consequences and ► Solutions  |
|--|---|
|  <p>SRS Malfunction Service Required</p>                                | <p>* The restraint system is malfunctioning (→ page 32).</p> <p><b>▲ WARNING</b> Risk of injury due to malfunctions in the restraint system</p> <p>Components in the restraint system may be activated unintentionally or not deploy as planned in an accident.</p> <p>► Have the restraint system checked and repaired immediately at a qualified specialist workshop.</p>   |
|  <p>Front Left Malfunction Service Required (example)</p>               | <p>* The corresponding restraint system is malfunctioning (→ page 32).</p> <p><b>▲ WARNING</b> Risk of injury due to malfunctions in the restraint system</p> <p>Components in the restraint system may be activated unintentionally or not deploy as planned in an accident.</p> <p>► Have the restraint system checked and repaired immediately at a qualified specialist workshop.</p>   |
|  <p>Left Side Curtain Airbag Malfunction Service Required (example)</p> | <p>* The corresponding window curtain airbag is malfunctioning (→ page 32).</p> <p><b>▲ WARNING</b> Risk of injury or fatal injury due to a malfunction in the window curtain airbag</p> <p>The window curtain airbag might be triggered unintentionally or might not be triggered at all in the event of an accident.</p> <p>► Have the window curtain airbag checked and repaired immediately at a qualified specialist workshop.</p> |







| Display messages   | Possible causes/consequences and ► Solutions   |
|--|--|
| <p>Front Passenger Airbag Disabled See Operator's Manual</p> | <p>* The front passenger airbag has been disabled even though an adult or a person of adult stature is on the front passenger seat. If additional forces are applied to the seat, the weight the system detects may be too low.</p> <div data-bbox="547 319 1696 524" style="border: 1px solid gray; padding: 5px;"> <p><b>▲ WARNING</b> Risk of injury or fatal injury due to a disabled front passenger airbag</p> <p>If the front passenger airbag is disabled, the front passenger airbag will not be deployed in the event of an accident and cannot perform its intended protective function.</p> <p>A person in the front passenger seat could then, for example, come into contact with the vehicle's interior, especially if the person is sitting too close to the cockpit.</p> <p>► Make sure, both before and during the journey, that the status of the front passenger airbag is correct.</p> </div> <p>► Stop the vehicle immediately in accordance with the traffic conditions.</p> <p>► Check the status of the automatic front passenger airbag actuation (→ page 42).</p> <p>► If necessary, consult a qualified specialist workshop immediately.</p> |
| <p>Front Passenger Airbag Enabled See Operator's Manual</p>  | <p>* The front passenger airbag is enabled while the vehicle is in motion:</p> <ul style="list-style-type: none"> <li>• even when a child, a person of smaller stature or an object weighing less than the system weight threshold is located on the front passenger seat</li> <li>• even when the front passenger seat is not occupied</li> </ul> <p>The system may detect objects or forces that are adding to the weight applied to the seat.</p>   |

## 312 Display messages and warning/indicator lamps



| Display messages                           | Possible causes/consequences and ► Solutions   |
|--|--|
|  | <p><b>▲ WARNING</b> Risk of injury or fatal injury when using a child restraint system while the front passenger airbag is enabled</p> <p>If you secure a child in a child restraint system on the front passenger seat and the front passenger airbag is enabled, the front passenger airbag may deploy in the event of an accident.</p> <p>The child could be struck by the airbag.</p> <ul style="list-style-type: none"><li>► Both before and during the journey, ensure that the status of the front passenger airbag is correct.</li></ul> <p>NEVER use a child restraint system facing to the rear on a seat with an ACTIVATED FRONT AIRBAG. DEATH or SERIOUS INJURY to the child can occur.</p> <ul style="list-style-type: none"><li>► Stop the vehicle immediately in accordance with the traffic conditions.</li><li>► Check the status of the automatic front passenger airbag actuation (→ page 42).</li><li>► If necessary, consult a qualified specialist workshop immediately.</li></ul> |
| PRE-SAFE Inoperative See Operator's Manual | <ul style="list-style-type: none"><li>* The PRE-SAFE® functions are malfunctioning.</li><li>► Consult a qualified specialist workshop.</li></ul>   |





## SmartKey

| Display messages  | Possible causes/consequences and ► Solutions   |
|---|--|
|  <p data-bbox="195 384 376 407">Obtain a New Key</p>                         | <ul style="list-style-type: none"> <li data-bbox="519 291 979 313">* The SmartKey needs to be replaced.</li> <li data-bbox="543 324 979 347">► Consult a qualified specialist workshop.</li> </ul>   |
|  <p data-bbox="195 529 402 552">Replace Key Battery</p>                      | <ul style="list-style-type: none"> <li data-bbox="519 436 911 458">* The SmartKey battery is discharged.</li> <li data-bbox="543 469 911 492">► Replace the battery (→ page 62).</li> </ul>  |
|  <p data-bbox="195 674 445 717">Key Not Detected (white display message)</p> | <ul style="list-style-type: none"> <li data-bbox="519 581 929 603">* The SmartKey is currently undetected.</li> <li data-bbox="543 614 1095 637">► Change the location of the SmartKey in the vehicle.</li> <li data-bbox="543 647 1557 691">► If the SmartKey is still not recognized, place it in the marked space for starting with the SmartKey (→ page 134).</li> </ul> |

| Display messages  | Possible causes/consequences and ► Solutions  |
|---|---|
|  <p>Key Not Detected (red display message)</p> | <ul style="list-style-type: none"> <li>* The SmartKey cannot be detected and may no longer be in the vehicle. The SmartKey is no longer in the vehicle and you switch off the engine:               <ul style="list-style-type: none"> <li>• You can no longer start the engine.</li> <li>• You cannot centrally lock the vehicle.</li> </ul> </li> <li>► Ensure that the SmartKey is in the vehicle.</li> </ul> <p>If the SmartKey detection function has a malfunction due to a strong radio signal source:</p> <ul style="list-style-type: none"> <li>► Stop the vehicle immediately in accordance with the traffic conditions.</li> <li>► Place the SmartKey in the marked space for starting the engine with the SmartKey (→ page 134).</li> </ul> |
| <p>Place the Key in the Marked Space See Operator's Manual</p>  | <ul style="list-style-type: none"> <li>* SmartKey detection is malfunctioning.               <ul style="list-style-type: none"> <li>► Change the location of the SmartKey in the vehicle.</li> <li>► Place the SmartKey in the marked space for starting the engine with the SmartKey (→ page 134).</li> </ul> </li> </ul>  |
|  <p>Don't Forget Your Key</p>                  | <ul style="list-style-type: none"> <li>* A warning tone will also sound. This message reminds you to take your SmartKey with you when you leave the vehicle.</li> </ul>   |

## Lights



| Display messages   | Possible causes/consequences and ► Solutions  |
|--|---|
|  <p data-bbox="195 384 358 436">Check Left Low Beam (example)</p>       | <ul style="list-style-type: none"> <li data-bbox="519 291 944 317">* The corresponding light source is faulty.               <ul style="list-style-type: none"> <li data-bbox="543 325 759 351">► Drive on carefully.</li> <li data-bbox="543 359 1101 385">► Consult a qualified specialist workshop immediately.</li> </ul> </li> <li data-bbox="543 393 1646 443">① LED light sources: the display message for the corresponding light appears only when all the light-emitting diodes in the light are faulty.</li> </ul> |
|  <p data-bbox="195 553 436 605">Malfunction See Operator's Manual</p>   | <ul style="list-style-type: none"> <li data-bbox="519 459 925 485">* The exterior lighting is malfunctioning.               <ul style="list-style-type: none"> <li data-bbox="543 494 977 520">► Consult a qualified specialist workshop.</li> </ul> </li> </ul>  |
|  <p data-bbox="195 721 473 772">Automatic Headlamp Mode Inoperative</p> | <ul style="list-style-type: none"> <li data-bbox="519 627 888 653">* The light sensor is malfunctioning.               <ul style="list-style-type: none"> <li data-bbox="543 662 977 687">► Consult a qualified specialist workshop.</li> </ul> </li> </ul>   |

| Display messages  | Possible causes/consequences and ► Solutions  |
|---|---|
|  <p data-bbox="144 342 417 391">Active Headlamps Inoperative</p>     | <ul style="list-style-type: none"> <li>* The active headlamps are malfunctioning.                             <ul style="list-style-type: none"> <li>► Consult a qualified specialist workshop.</li> </ul> </li> </ul>  |
|  <p data-bbox="144 514 371 534">Switch On Headlamps</p>              | <ul style="list-style-type: none"> <li>* You are driving without low-beam headlamps.                             <ul style="list-style-type: none"> <li>► Turn the light switch to the  or <b>AUTO</b> position.</li> </ul> </li> </ul>                |
|  <p data-bbox="144 656 321 676">Switch Off Lights</p>                | <ul style="list-style-type: none"> <li>* You are leaving the vehicle and the lights are still switched on.                             <ul style="list-style-type: none"> <li>► Turn the light switch to the <b>AUTO</b> position.</li> </ul> </li> </ul>   |
|  <p data-bbox="144 798 417 847">Intell. Light System Inoperative</p> | <ul style="list-style-type: none"> <li>* The Intelligent Light System is malfunctioning. The lighting system continues to function properly without the functions of the Intelligent Light System.                             <ul style="list-style-type: none"> <li>► Consult a qualified specialist workshop.</li> </ul> </li> </ul> |



| Display messages   | Possible causes/consequences and ► Solutions   |
|--|--|
| Adaptive Highbeam Assist Currently Unavailable See Operator's Manual | <ul style="list-style-type: none"> <li>* Adaptive Highbeam Assist is temporarily unavailable. The system limits have been reached (→ page 117).               <ul style="list-style-type: none"> <li>► Drive on. Once the cause of the problem is no longer present, the system will be available again. The <b>Adaptive Highbeam Assist Now Available</b> display message will appear.</li> </ul> </li> </ul> |
| Adaptive Highbeam Assist Inoperative                                 | <ul style="list-style-type: none"> <li>* Adaptive Highbeam Assist is malfunctioning.               <ul style="list-style-type: none"> <li>► Consult a qualified specialist workshop.</li> </ul> </li> </ul>  |
| Hazard Warning Flashers Malfunctioning                               | <ul style="list-style-type: none"> <li>* The hazard warning lamp switch is malfunctioning.               <ul style="list-style-type: none"> <li>► Consult a qualified specialist workshop.</li> </ul> </li> </ul>  |

## Vehicle



| Display messages   | Possible causes/consequences and ► Solutions  |
|--|---|
|  <p>Vehicle Ready to Drive Switch the Ignition Off Before Exiting</p> | <ul style="list-style-type: none"> <li>* You are leaving the vehicle when it is in a ready-to-drive state.               <ul style="list-style-type: none"> <li>► When you leave the vehicle, switch off the ignition, secure the vehicle against rolling away and take the Smart-Key with you.</li> <li>► If you do not leave the vehicle, switch off the electrical consumers, e.g. the seat heating. Otherwise, the 12 V battery may discharge and it will then be possible to start the vehicle only with the aid of a second battery (starting assistance).</li> </ul> </li> </ul> |



| Display messages  | Possible causes/consequences and ► Solutions  |
|---|---|
|  <p>Steering Malfunction<br/>Increased Physical Effort<br/>See Operator's Manual</p> | <p>* The power steering assistance is malfunctioning.</p> <p><b>▲ WARNING</b> Risk of an accident due to altered steering characteristics</p> <p>If the power assistance of the steering fails partially or completely, you will need to use more force to steer.</p> <ul style="list-style-type: none"> <li>▶ If safe steering is possible, drive on carefully.</li> <li>▶ Visit or consult a qualified specialist workshop immediately.</li> </ul>  |
|  <p>Steering Malfunction Stop<br/>Immediately See Operator's Manual</p>              | <p>* The steering is malfunctioning. Steering capability is significantly impaired.</p> <p><b>▲ WARNING</b> Risk of accident if steering capability is impaired</p> <p>If the steering does not function as intended, the vehicle's operating safety is jeopardized.</p> <ul style="list-style-type: none"> <li>▶ Pull over and stop the vehicle safely as soon as possible, paying attention to road and traffic conditions. Do not continue driving under any circumstances.</li> <li>▶ Consult a qualified specialist workshop.</li> </ul> |
|  <p>Steering Malfunction See<br/>Operator's Manual</p>                               | <p>* The electric steering lock is malfunctioning. The steering may be locked by the electric steering lock.</p> <p><b>▲ WARNING</b> Risk of accident if steering capability is impaired</p> <p>If the steering does not function as intended, the vehicle's operating safety is jeopardized.</p>   |



| Display messages   | Possible causes/consequences and ► Solutions  |
|--|---|
|  | <ul style="list-style-type: none"> <li>► Pull over and stop the vehicle safely as soon as possible, paying attention to road and traffic conditions. Do not continue driving under any circumstances.</li> <li>► Consult a qualified specialist workshop.</li> </ul><br><ul style="list-style-type: none"> <li>► Pull over and stop the vehicle safely as soon as possible in accordance with the traffic conditions. Do not continue driving under any circumstances.</li> <li>► Consult a qualified specialist workshop.</li> </ul> |
|  <p data-bbox="195 565 467 615">Before Starting the Engine,<br/>Turn Steering Wheel</p> | <ul style="list-style-type: none"> <li>* The electric steering lock could not unlock the steering.                             <ul style="list-style-type: none"> <li>► Switch off the ignition.</li> <li>► To unlock the steering, move the steering wheel slightly to the left and right.</li> <li>► Switch the ignition back on.</li> </ul> </li> </ul>  |
|   | <ul style="list-style-type: none"> <li>* At least one door is open.                             <ul style="list-style-type: none"> <li>► Close all doors.</li> </ul> </li> </ul>  |
|   | <ul style="list-style-type: none"> <li>* The hood is open.                             <div style="background-color: #e0e0e0; padding: 5px; margin-top: 10px;"> <p><b>⚠ WARNING</b> Risk of accident due to driving with the hood unlocked</p> </div> <p>The hood may open and block your view.</p> </li> </ul>   |

### 320 Display messages and warning/indicator lamps



| Display messages   | Possible causes/consequences and ► Solutions   |
|--|--|
|  | <ul style="list-style-type: none"><li>▶ Never release the hood when driving.</li><li>▶ Before every trip, ensure that the hood is locked.</li></ul> <ul style="list-style-type: none"><li>▶ Stop the vehicle immediately, paying attention to road and traffic conditions.</li><li>▶ Close the hood.</li></ul>   |
|                                       | <p>* The tailgate is open.</p> <p><b>▲ DANGER</b> Risk of exhaust gas poisoning</p> <p>Combustion engines emit poisonous exhaust gases such as carbon monoxide. Exhaust gases can enter the vehicle interior if the tailgate is open when the engine is running, especially if the vehicle is in motion.</p> <ul style="list-style-type: none"><li>▶ Always switch off the engine before opening the tailgate.</li><li>▶ Never drive with the tailgate open.</li></ul> <ul style="list-style-type: none"><li>▶ Close the tailgate.</li></ul> |
|  <p>2nd Seat Row, Left Not Locked</p> | <p>* The left-hand seat or the seat backrest in the second row of seats is not engaged.</p> <ul style="list-style-type: none"><li>▶ Fold the corresponding seat backrest back until it engages and push the row of seats back (→ page 89).</li><li>▶ Make sure that the seat is engaged (→ page 89).</li></ul>   |



| Display messages  | Possible causes/consequences and ► Solutions  |
|---|---|
|  <p data-bbox="195 342 445 391">2nd Seat Row, Right Not Locked</p> | <p data-bbox="522 249 1373 273">* The right-hand seat or the seat backrest in the second row of seats is not engaged.</p> <ul style="list-style-type: none"> <li data-bbox="543 283 1628 307">► Fold the corresponding seat backrest back until it engages and push the row of seats back (→ page 89).</li> <li data-bbox="543 318 1073 341">► Make sure that the seat is engaged (→ page 89).</li> </ul> |
|  <p data-bbox="195 511 399 535">Check Washer Fluid</p>             | <p data-bbox="522 418 1387 442">* The washer fluid level in the washer fluid reservoir has dropped below the minimum.</p> <ul style="list-style-type: none"> <li data-bbox="543 452 903 476">► Add washer fluid (→ page 234).</li> </ul>  |

## Engine

| Display messages   | Possible causes/consequences and ► Solutions   |
|--|--|
| <p data-bbox="195 684 467 788">To switch engine off, press and hold Start/Stop button for at least 3 seconds or press 3 times.</p> | <p data-bbox="522 684 1243 708">* You have pressed the start/stop button while the vehicle is in motion.</p> <ul style="list-style-type: none"> <li data-bbox="543 718 1291 742">► Information about switching off the engine while driving (→ page 133).</li> </ul> |

## 322 Display messages and warning/indicator lamps

| Display messages  | Possible causes/consequences and ► Solutions   |
|---|--|
|  <p data-bbox="144 342 399 391">Check Coolant Level See Operator's Manual</p>    | <p data-bbox="476 249 772 270">* The coolant level is too low.</p> <div data-bbox="500 294 1646 377"><p data-bbox="513 301 1042 325"><b>!</b> <b>NOTE</b> Engine damage due to insufficient coolant</p><p data-bbox="513 342 994 366">► Avoid long journeys with insufficient coolant.</p></div> <ul data-bbox="495 394 1282 453" style="list-style-type: none"><li data-bbox="495 394 802 418">► Add coolant (→ page 234).</li><li data-bbox="495 428 1282 453">► Have the engine cooling system checked at a qualified specialist workshop.</li></ul>  |
|  <p data-bbox="144 563 421 612">Coolant Too Hot Stop Vehicle Turn Engine Off</p> | <p data-bbox="476 470 717 491">* The coolant is too hot.</p> <ul data-bbox="495 501 1622 529" style="list-style-type: none"><li data-bbox="495 501 1622 529">► Pull over and stop the vehicle safely and switch off the engine, paying attention to road and traffic conditions.</li></ul> <div data-bbox="500 553 1646 733"><p data-bbox="513 563 1068 587"><b>!</b> <b>WARNING</b> Danger of burns when opening the hood</p><p data-bbox="513 605 1591 653">If you open the hood when the engine has overheated or during a fire in the engine compartment, you could come into contact with hot gases or other escaping operating fluids.</p><ul data-bbox="513 667 1498 723" style="list-style-type: none"><li data-bbox="513 667 1110 691">► Before opening the hood, allow the engine to cool down.</li><li data-bbox="513 698 1498 723">► In the event of a fire in the engine compartment, keep the hood closed and call the fire service.</li></ul></div> <ul data-bbox="495 750 1622 868" style="list-style-type: none"><li data-bbox="495 750 912 773">► Wait until the engine has cooled down.</li><li data-bbox="495 784 1153 808">► Make sure that the air supply to the radiator is not obstructed.</li><li data-bbox="495 818 1622 868">► Avoiding high loads on the engine, drive to the nearest qualified specialist workshop. In doing so, ensure that the coolant temperature display remains below the red marking.</li></ul> |

| Display messages  | Possible causes/consequences and ► Solutions  |
|---|---|
|    | <ul style="list-style-type: none"> <li>* The fan motor is faulty.               <ul style="list-style-type: none"> <li>► Avoiding high loads on the engine, drive to the nearest qualified specialist workshop. In doing so, ensure that the coolant temperature display remains below the red marking.</li> </ul> </li> </ul>              |
|  <p data-bbox="195 449 347 472">Fuel Level Low</p> | <ul style="list-style-type: none"> <li>* The fuel supply has dropped into the reserve range.               <ul style="list-style-type: none"> <li>► Refuel.</li> </ul> </li> </ul>  |
|  <p data-bbox="195 589 347 612">Gas Cap Loose</p>  | <ul style="list-style-type: none"> <li>* The fuel filler cap is not closed correctly or the fuel system is leaking.               <ul style="list-style-type: none"> <li>► Close the fuel filler cap.</li> <li>► <b>If the fuel filler cap was already properly closed:</b> consult a qualified specialist workshop.</li> </ul> </li> </ul> |

## Transmission

| Display messages  | Possible causes/consequences and ► Solutions   |
|---|--|
| <p data-bbox="195 765 473 816">Only Shift to 'P' when Vehicle is Stationary</p> | <ul style="list-style-type: none"> <li>* Park position <b>P</b> can be engaged only when the vehicle is stationary.               <ul style="list-style-type: none"> <li>► To stop, depress the brake pedal.</li> <li>► Shift the transmission to park position <b>P</b> while the vehicle is stationary.</li> </ul> </li> </ul> |

### 324 Display messages and warning/indicator lamps

| Display messages  | Possible causes/consequences and ► Solutions   |
|---|--|
| Apply Brake to Shift from 'P'   | <ul style="list-style-type: none"><li>* You have attempted to shift the transmission out of park position <b>P</b> and into another transmission position.<ul style="list-style-type: none"><li>► Depress the brake pedal.</li><li>► Select transmission position <b>D</b>, <b>R</b> or neutral <b>N</b>.</li></ul></li></ul>              |
| To Deselect P or N, Depress Brake and Start Engine                      | <ul style="list-style-type: none"><li>* You have attempted to shift the transmission out of park position <b>P</b> or neutral <b>N</b> and into another transmission position.<ul style="list-style-type: none"><li>► Depress the brake pedal.</li><li>► Change the transmission position.</li><li>► Start the engine.</li></ul></li></ul> |
| Apply Brake to Shift to D or R  | <ul style="list-style-type: none"><li>* You have attempted to select transmission position <b>D</b> or <b>R</b>.<ul style="list-style-type: none"><li>► Depress the brake pedal.</li><li>► Select transmission position <b>D</b> or <b>R</b>.</li></ul></li></ul>  |
| Apply Brake to Shift to 'R'   | <ul style="list-style-type: none"><li>* You have attempted to select transmission position <b>R</b>.<ul style="list-style-type: none"><li>► Depress the brake pedal.</li><li>► Select transmission position <b>R</b>.</li></ul></li></ul>  |
| Driver's Door Open & Transmission Not in P Risk of Vehicle Rolling Away | <ul style="list-style-type: none"><li>* The driver's door is not fully closed and transmission position <b>D</b>, <b>R</b> or neutral <b>N</b> is selected.<ul style="list-style-type: none"><li>► Select park position <b>P</b> when switching off the vehicle.</li></ul></li></ul>   |





| Display messages                                 | Possible causes/consequences and ► Solutions  |
|--|---|
| N Permanently Active Risk of Rolling Away        | <ul style="list-style-type: none"> <li>* While the vehicle is rolling or while you are driving, neutral <b>N</b> has been engaged.               <ul style="list-style-type: none"> <li>► To stop, depress the brake pedal.</li> <li>► Shift the transmission to park position <b>P</b> while the vehicle is stationary.</li> <li>► To continue driving, select transmission position <b>D</b> or <b>R</b>.</li> </ul> </li> </ul>  |
| Service Required Do Not Shift Gears Visit Dealer | <ul style="list-style-type: none"> <li>* The transmission is malfunctioning. The transmission position can no longer be changed.               <ul style="list-style-type: none"> <li>► When transmission position <b>D</b> is selected, consult a qualified specialist workshop and do not change the transmission position.</li> <li>► For all other transmission positions, park the vehicle safely.</li> <li>► Consult a qualified specialist workshop or breakdown service.</li> </ul> </li> </ul> |
| Reversing Not Possible Service Required          | <ul style="list-style-type: none"> <li>* The transmission is malfunctioning. The transmission position <b>R</b> cannot be selected.               <ul style="list-style-type: none"> <li>► Consult a qualified specialist workshop.</li> </ul> </li> </ul>  |
| Transmission Malfunction Stop                    | <ul style="list-style-type: none"> <li>* The transmission is malfunctioning. The transmission shifts to neutral <b>N</b> automatically.               <ul style="list-style-type: none"> <li>► Stop the vehicle immediately in accordance with the traffic conditions.</li> <li>► Depress the brake pedal.</li> <li>► Engage park position <b>P</b>.</li> <li>► Consult a qualified specialist workshop.</li> </ul> </li> </ul>   |
| Auxiliary Battery Malfunction                    | <ul style="list-style-type: none"> <li>* The auxiliary battery for the transmission is no longer being charged.               <ul style="list-style-type: none"> <li>► Consult a qualified specialist workshop.</li> </ul> </li> </ul>  |









| Display messages  | Possible causes/consequences and ► Solutions   |
|---|--|
|   | <ul style="list-style-type: none"> <li>► Until then, always select park position <b>P</b> manually before you switch off the engine.</li> <li>► Before leaving the vehicle, apply the electric parking brake.</li> </ul>   |
| <p>Transmission Malfunction</p>   | <ul style="list-style-type: none"> <li>* The transmission is malfunctioning. The cause could be an overheated clutch or blocked gears.</li> <li>► Let the transmission cool down.</li> <li>► If the display message still appears following a restart, consult a qualified specialist workshop.</li> </ul>   |
| <div data-bbox="155 436 312 519" data-label="Image"> </div> <p>Transmission Oil Overheated Drive with Caution</p> | <ul style="list-style-type: none"> <li>* The transmission is overheating. When the display message is active, start-up and driving characteristics may be temporarily impaired.</li> <li>► Drive at low engine speed.</li> <li>► Avoid sporty driving.</li> <li>► Before pulling away on uphill gradients, let the transmission cool down until the display message disappears.</li> </ul>   |
| <p>Parking Lock Inoperative Apply Parking Brake</p>   | <ul style="list-style-type: none"> <li>* The transmission is malfunctioning. The park position <b>P</b> cannot be selected.</li> <li>► Park the vehicle safely.</li> <li>► Use the electric parking brake to secure the vehicle against rolling away.</li> </ul>   |
| <p>Teaching in Transmission Operate Selector Lever Apply Brake for XX s Risk of Vehicle Rolling Away</p>          | <ul style="list-style-type: none"> <li>* The transmission is being taught in. There is a risk of the vehicle rolling away.</li> <li>► Depress and hold the brake pedal until the teach-in process has been completed. The electric parking brake is applied automatically during the teach-in process.</li> <li>► Switch on the ignition.</li> <li>► Select park position <b>P</b>, transmission position <b>R</b> or neutral <b>N</b>.</li> </ul> |



| Display messages   | Possible causes/consequences and ► Solutions   |
|--|--|
| Apply Parking Brake Risk of Rolling Away See Operator's Manual | <ul style="list-style-type: none"><li>* The transmission position cannot be reliably identified.<ul style="list-style-type: none"><li>► Use the electric parking brake to secure the vehicle against rolling away.</li></ul></li></ul> |
| Teaching in Transmission Complete                              | <ul style="list-style-type: none"><li>* The transmission's teach-in process is complete. All transmission positions can be selected again.</li></ul>   |
| Transmission Malfunction Service Required                      | <ul style="list-style-type: none"><li>* The transmission is malfunctioning.<br/>Consult a qualified specialist workshop.</li></ul>   |





## Brakes



| Display messages  | Possible causes/consequences and ► Solutions   |
|---|--|
| <div data-bbox="155 293 310 373" data-label="Image"> </div> <p data-bbox="155 381 260 408">(USA only)</p> <div data-bbox="155 420 310 501" data-label="Image"> </div> <p data-bbox="155 508 291 535">(Canada only)</p> <p data-bbox="144 542 408 593">Parking Brake See Operator's Manual</p> | <p data-bbox="476 288 1308 314">* The yellow  indicator lamp is lit. The electric parking brake is malfunctioning.</p> <p data-bbox="495 322 593 349"><b>To apply:</b></p> <ul data-bbox="495 356 1097 418" style="list-style-type: none"> <li data-bbox="495 356 975 383">► Switch the ignition off and switch it back on.</li> <li data-bbox="495 390 1097 418">► Apply the electric parking brake manually (→ page 159).</li> </ul> <p data-bbox="495 443 1031 470">If it is not possible to apply the electric parking brake:</p> <ul data-bbox="495 477 1227 539" style="list-style-type: none"> <li data-bbox="495 477 925 504">► Consult a qualified specialist workshop.</li> <li data-bbox="495 511 1227 539">► Where necessary, also secure the parked vehicle against rolling away.</li> </ul> <p data-bbox="476 547 1641 598">* The yellow  indicator lamp and the red  (USA only) or  (Canada only) indicator lamp are lit. The electric parking brake is malfunctioning.</p> <p data-bbox="495 606 611 632"><b>To release:</b></p> <ul data-bbox="495 640 1123 702" style="list-style-type: none"> <li data-bbox="495 640 975 667">► Switch the ignition off and switch it back on.</li> <li data-bbox="495 674 1123 702">► Release the electric parking brake manually (→ page 159).</li> </ul> <p data-bbox="495 709 519 736">or</p> <ul data-bbox="495 743 1166 770" style="list-style-type: none"> <li data-bbox="495 743 1166 770">► Release the electric parking brake automatically (→ page 159).</li> </ul> <p data-bbox="495 774 1097 801">If it is still not possible to release the electric parking brake:</p> <ul data-bbox="495 809 1171 836" style="list-style-type: none"> <li data-bbox="495 809 1171 836">► Do not continue driving. Consult a qualified specialist workshop.</li> </ul> |

| Display messages | Possible causes/consequences and ► Solutions   |
|------------------|--|
|                  | <p>* The yellow  indicator lamp is lit and the red  (USA only) or  (Canada only) indicator lamp is flashing. The electric parking brake is malfunctioning.</p> <p>The electric parking brake could not be applied or released.</p> <ul style="list-style-type: none"> <li>► Switch the ignition off and switch it back on.</li> </ul> <p><b>To apply:</b></p> <ul style="list-style-type: none"> <li>► Release and then apply the electric parking brake manually (→ page 159).</li> </ul> <p><b>To release:</b></p> <ul style="list-style-type: none"> <li>► Apply and then release the electric parking brake manually.</li> </ul> <p>If the electric parking brake cannot be applied or the red  (USA only) or  (Canada only) indicator lamp continues to flash:</p> <ul style="list-style-type: none"> <li>► Do not continue driving. Consult a qualified specialist workshop.</li> <li>► Where necessary, also secure the parked vehicle against rolling away.</li> </ul> <p>* The yellow  indicator lamp is lit and the red  indicator lamp (USA only) or  indicator lamp (Canada only) flashes for approximately ten seconds after the electric parking brake has been applied or released. It then remains lit or goes out. The electric parking brake is malfunctioning.</p> <p><b>If the charge level is too low:</b></p> <ul style="list-style-type: none"> <li>► Charge the 12 V battery.</li> </ul> |

### 330 Display messages and warning/indicator lamps



| Display messages | Possible causes/consequences and ► Solutions  |
|------------------|---|
|                  | <p><b>To apply:</b></p> <ul style="list-style-type: none"><li>► switch the ignition off.<br/>The electric parking brake will be applied automatically.</li></ul> <p>If the electric parking brake is not to be applied, e.g. at an automatic car wash or when the vehicle is being towed, leave the ignition switched on. This does not include having the vehicle towed with the rear axle raised.</p> <p>If the electric parking brake is not applied automatically:</p> <ul style="list-style-type: none"><li>► Switch the ignition off and switch it back on.</li><li>► Release and then apply the electric parking brake manually (→ page 159).</li></ul> <p>If it is still not possible to apply the electric parking brake:</p> <ul style="list-style-type: none"><li>► Consult a qualified specialist workshop.</li><li>► Where necessary, also secure the parked vehicle against rolling away.</li></ul> <p><b>To release:</b></p> <ul style="list-style-type: none"><li>► If the conditions for automatic release are fulfilled and the electric parking brake is not released automatically, release the electric parking brake manually (→ page 159).</li></ul> <p>If it is still not possible to release the electric parking brake:</p> <ul style="list-style-type: none"><li>► Do not continue driving. Consult a qualified specialist workshop.</li></ul> |

| Display messages   | Possible causes/consequences and ► Solutions   |
|--|--|
|  <p>(USA only)</p>  <p>(Canada only)</p> <p>Please Release Parking Brake</p> | <p>* The red  indicator lamp (USA only) or  indicator lamp (Canada only) is flashing.</p> <p>The electric parking brake is applied while you are driving:</p> <ul style="list-style-type: none"><li>• A condition for automatic release of the electric parking brake has not been fulfilled (→ page 159).</li><li>• You are performing emergency braking using the electric parking brake (→ page 160).</li></ul> <p>► Check the conditions for automatic release of the electric parking brake.</p> <p>► Release the electric parking brake manually.</p> |

| Display messages  | Possible causes/consequences and ► Solutions  |
|---|---|
| <div data-bbox="155 252 312 335" data-label="Image"> </div> <p data-bbox="155 342 260 366">(USA only)</p> <div data-bbox="155 379 312 462" data-label="Image"> </div> <p data-bbox="155 469 291 493">(Canada only)</p> <p data-bbox="147 505 410 554">Turn On the Ignition to Release the Parking Brake</p> | <p data-bbox="473 249 1363 308">* The red  (USA only) or  indicator lamp (Canada only) is lit. You have attempted to release the electric parking brake with the ignition switched off.</p> <ul data-bbox="495 319 753 342" style="list-style-type: none"> <li>► Switch on the ignition.</li> </ul>   |
| <div data-bbox="155 584 312 667" data-label="Image"> </div> <p data-bbox="147 674 253 698">(USA only)</p> <div data-bbox="155 710 312 793" data-label="Image"> </div> <p data-bbox="147 800 284 824">(Canada only)</p> <p data-bbox="147 837 389 857">Check Brake Fluid Level</p>                           | <p data-bbox="473 581 1079 605">* There is insufficient brake fluid in the brake fluid reservoir.</p> <div data-bbox="500 622 1650 837" data-label="Complex-Block" style="border: 1px solid black; padding: 5px;"> <p data-bbox="513 632 1134 656"><b>▲ WARNING</b> Risk of an accident due to low brake fluid level</p> <p data-bbox="513 671 1511 695">If the brake fluid level is too low, the braking effect and the braking characteristics may be impaired.</p> <ul data-bbox="513 705 1585 826" style="list-style-type: none"> <li>► Pull over and stop the vehicle safely as soon as possible, paying attention to road and traffic conditions. Do not continue driving under any circumstances.</li> <li>► Consult a qualified specialist workshop.</li> <li>► Do not add brake fluid.</li> </ul> </div> |

| Display messages  | Possible causes/consequences and ► Solutions   |
|---|--|
|  <p data-bbox="195 342 426 391">Check Brake Pads See Operator's Manual</p> | <ul style="list-style-type: none"> <li>* The brakepads have reached the wear limit.                             <ul style="list-style-type: none"> <li>► Consult a qualified specialist workshop.</li> </ul> </li> </ul> |

### Driving systems

| Display messages   | Possible causes/consequences and ► Solutions  |
|--|---|
|  <p data-bbox="195 637 469 685">ATTENTION ASSIST Inoperative</p>    | <ul style="list-style-type: none"> <li>* ATTENTION ASSIST is malfunctioning.                             <ul style="list-style-type: none"> <li>► Consult a qualified specialist workshop.</li> </ul> </li> </ul>   |
|  <p data-bbox="195 808 469 856">ATTENTION ASSIST: Take a Break!</p> | <ul style="list-style-type: none"> <li>* ATTENTION ASSIST has detected fatigue or an increasing lack of concentration on the part of the driver (→ page 199).                             <ul style="list-style-type: none"> <li>► If necessary, take a break.</li> </ul> </li> </ul> |

### 334 Display messages and warning/indicator lamps

| Display messages  | Possible causes/consequences and ► Solutions  |
|---|---|
| <p>Active Steering Assist Currently Unavailable See Operator's Manual</p>         | <p>* Active Steering Assist is temporarily unavailable. The ambient conditions are outside the system limits (→ page 179).</p> <ul style="list-style-type: none"><li>► Drive on. As soon as the ambient conditions are within the system limits, the system will become available again.</li><li>► If necessary, clean the windshield in the camera's field of vision.</li><li>► Check the tire pressure if necessary.</li></ul>  |
| <p>Active Steering Assist Inoperative</p>   | <p>* Active Steering Assist is malfunctioning. Active Distance Assist DISTRONIC remains available.</p> <ul style="list-style-type: none"><li>► Consult a qualified specialist workshop.</li></ul>   |
|  | <p>* Active Steering Assist has reached the system limits (→ page 179). You have not steered independently for a considerable period of time.</p> <ul style="list-style-type: none"><li>► Take over the steering and drive on in accordance with the traffic conditions.</li></ul>  |
| <p>Beginning Emergency Stop</p>   | <p>* Your hands are not on the steering wheel. An emergency stop is being initiated (→ page 181).</p> <ul style="list-style-type: none"><li>► Put your hands back on the steering wheel.</li></ul> <p>You can cancel the deceleration at any time by performing one of the following actions:</p> <ul style="list-style-type: none"><li>• Steering</li><li>• Depressing the brake or accelerator pedal</li><li>• Pressing a steering-wheel button</li><li>• Operating Touch Control</li></ul> |









| Display messages  | Possible causes/consequences and ► Solutions   |
|---|--|
| Active Steering Asst. Currently Unavailable Due to Multiple Emergency Stops | <ul style="list-style-type: none"> <li>• Deactivating Active Distance Assist DISTRONIC</li> </ul> <p>* Active Steering Assist is temporarily unavailable due to multiple emergency stops.</p> <ul style="list-style-type: none"> <li>► Take over the steering and stop in accordance with the traffic conditions.</li> <li>► Switch the ignition off and switch it back on.</li> </ul> <p>Active Steering Assist is available once more.</p>                             |
| Active Lane Keeping Assist Currently Unavailable See Operator's Manual      | <p>* Active Lane Keeping Assist is temporarily unavailable.</p> <p>The ambient conditions are outside the system limits (→ page 203).</p> <ul style="list-style-type: none"> <li>► Drive on.</li> </ul> <p>As soon as the ambient conditions are within the system limits, the system will become available again.</p>   |
| Active Lane Keeping Assist Inoperative                                      | <p>* Active Lane Keeping Assist is malfunctioning.</p> <ul style="list-style-type: none"> <li>► Consult a qualified specialist workshop.</li> </ul>  |
| Blind Spot Assist Currently Unavailable See Operator's Manual               | <p>* Blind Spot Assist is temporarily unavailable.</p> <p>The system limits have been reached (→ page 201).</p> <ul style="list-style-type: none"> <li>► Drive on.</li> </ul> <p>Once the cause of the problem is no longer present, the system will be available again.</p> <p>or</p> <ul style="list-style-type: none"> <li>► If the display message does not disappear, stop the vehicle in accordance with the traffic conditions and restart the engine.</li> </ul> |



### 336 Display messages and warning/indicator lamps

| Display messages   | Possible causes/consequences and ► Solutions   |
|--|--|
| Blind Spot Assist Inoperative  | <ul style="list-style-type: none"><li>* Blind Spot Assist is malfunctioning.<ul style="list-style-type: none"><li>► Consult a qualified specialist workshop.</li></ul></li></ul>   |
| Active Blind Spot Assist Currently Unavailable See Operator's Manual   | <ul style="list-style-type: none"><li>* Active Blind Spot Assist is temporarily unavailable. The system limits have been reached (→ page 201).<ul style="list-style-type: none"><li>► Drive on. Once the cause of the problem is no longer present, the system will be available again.</li><li>or</li><li>► If the display message does not disappear, stop the vehicle in accordance with the traffic conditions and restart the engine.</li></ul></li></ul> |
| Active Blind Spot Assist Inoperative                                   | <ul style="list-style-type: none"><li>* Active Blind Spot Assist is malfunctioning.<ul style="list-style-type: none"><li>► Consult a qualified specialist workshop.</li></ul></li></ul>  |
| Active Parking Assist and PARKTRONIC Inoperative See Operator's Manual | <ul style="list-style-type: none"><li>* Active Parking Assist and Parking Assist PARKTRONIC are malfunctioning.<ul style="list-style-type: none"><li>► Stop the vehicle in accordance with the traffic conditions and restart the engine.</li><li>► If the display message still appears, consult a qualified specialist workshop.</li></ul></li></ul>   |

| Display messages   | Possible causes/consequences and ► Solutions   |
|--|--|
|  <p data-bbox="199 598 412 648">Currently Unavailable<br/>Radar Sensors Dirty</p> | <p data-bbox="528 252 1147 273">* The radar sensor system is malfunctioning. Possible causes:</p> <ul data-bbox="552 288 1221 377" style="list-style-type: none"> <li data-bbox="552 288 772 308">• dirt on the sensors</li> <li data-bbox="552 319 772 339">• heavy rain or snow</li> <li data-bbox="552 354 1221 377">• extended country driving without other traffic, e.g. in the desert</li> </ul> <p data-bbox="547 397 1480 418">Driving systems and driving safety systems may be malfunctioning or temporarily unavailable.</p> <p data-bbox="547 433 1702 480">Once the cause of the problem is no longer present, the driving systems and driving safety systems will be available again.</p> <p data-bbox="547 495 972 515">If the display message does not disappear:</p> <ul data-bbox="547 530 1618 619" style="list-style-type: none"> <li data-bbox="547 530 1618 551">► Pull over and stop the vehicle safely as soon as possible, paying attention to road and traffic conditions.</li> <li data-bbox="547 565 907 586">► Clean all sensors (→ page 239).</li> <li data-bbox="547 600 772 621">► Restart the engine.</li> </ul> |

| Display messages  | Possible causes/consequences and ► Solutions   |
|---|--|
|  <p data-bbox="144 681 421 733">Currently Unavailable Camera View Restricted</p> | <p data-bbox="476 249 966 270">* The camera view is restricted. Possible causes:</p> <ul data-bbox="500 283 1073 373" style="list-style-type: none"> <li data-bbox="500 283 1049 304">• Dirt on the windshield in the camera's field of vision</li> <li data-bbox="500 318 765 338">• Heavy rain, snow or fog</li> <li data-bbox="500 352 1073 372">• Condensation on the windshield in front of the camera</li> </ul> <p data-bbox="495 394 1622 443">❗ Condensation detected on the windshield will be automatically removed using a built-in heater within approximately 12 minutes.</p> <p data-bbox="495 456 1428 477">Driving systems and driving safety systems may be malfunctioning or temporarily unavailable.</p> <p data-bbox="495 491 1650 539">Once the cause of the problem is no longer present, the driving systems and driving safety systems will be available again.</p> <p data-bbox="495 553 924 573">If the display message does not disappear:</p> <ul data-bbox="495 587 1105 643" style="list-style-type: none"> <li data-bbox="495 587 1105 608">► Stop the vehicle in accordance with the traffic conditions.</li> <li data-bbox="495 620 870 641">► Clean the windshield if necessary.</li> </ul> |
|  <p data-bbox="144 850 181 871">Off</p>  | <p data-bbox="476 760 1567 781">* The HOLD function is deactivated because the vehicle is slipping or a condition for activation is not fulfilled.</p> <ul data-bbox="495 794 1604 815" style="list-style-type: none"> <li data-bbox="495 794 1604 815">► Reactivate the HOLD function later or check the activation conditions for the HOLD function (→ page 182).</li> </ul>   |

| Display messages  | Possible causes/consequences and ► Solutions  |
|---|---|
| <br>Inoperative              | * The Downhill Speed Regulation is malfunctioning.<br>► Consult a qualified specialist workshop.  |
| <br>Not in Curr. Drive Prog. | * The Downhill Speed Regulation is not available in the currently selected drive program.<br>► Change the drive program (→ page 144).   |
| <br>Max. Speed 25 mph        | * The maximum speed of 25 mph (40 km/h) for the Downhill Speed Regulation has been exceeded.<br>► Drive more slowly.  |
| <br>--- mph                  | * Active Distance Assist DISTRONIC cannot be activated as not all activation conditions are fulfilled.<br>► Comply with the activation conditions of Active Distance Assist DISTRONIC (→ page 177). |



| Display messages   | Possible causes/consequences and ► Solutions  |
|--|---|
|  <p>Suspended</p> | <p>* If you depress the accelerator pedal beyond the Active Distance Assist DISTRONIC setting, the system will switch to passive mode (→ page 174).</p>   |
|  <p>Off</p>       | <p>* Active Distance Assist DISTRONIC was deactivated. If a warning tone also sounds, Active Distance Assist DISTRONIC has deactivated automatically (→ page 177).</p>  |
| <p>Active Distance Assist Currently Unavailable See Operator's Manual</p>                          | <p>* Active Distance Assist DISTRONIC is temporarily unavailable. The ambient conditions are outside the system limits (→ page 174).</p> <p>► Drive on.<br/>As soon as the ambient conditions are within the system limits, the system will become available again.</p> |
| <p>Active Distance Assist Inoperative</p>  | <p>* Active Distance Assist DISTRONIC is malfunctioning. Other driving systems and driving safety systems may also be malfunctioning.</p> <p>► Consult a qualified specialist workshop.</p>   |
| <p>Active Distance Assist Now Available</p>  | <p>* Active Distance Assist DISTRONIC is operational again and can be activated (→ page 177).</p>   |

| Display messages   | Possible causes/consequences and ► Solutions   |
|--|--|
|  <p>--- mph</p> | <ul style="list-style-type: none"> <li>* Cruise control cannot be activated as not all activation conditions are fulfilled.               <ul style="list-style-type: none"> <li>► Observe the activation conditions for cruise control (→ page 172).</li> </ul> </li> </ul> |
| Cruise Control Inoperative   | <ul style="list-style-type: none"> <li>* Cruise control is malfunctioning.               <ul style="list-style-type: none"> <li>► Consult a qualified specialist workshop.</li> </ul> </li> </ul>  |
| Cruise Control Off   | <ul style="list-style-type: none"> <li>* Cruise control has been deactivated.               <ul style="list-style-type: none"> <li>If there is an additional warning tone, cruise control has been deactivated automatically (→ page 171).</li> </ul> </li> </ul>            |

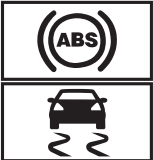
## Driving safety systems

| Display messages   | Possible causes/consequences and ► Solutions  |
|--|---|
|  <p data-bbox="144 467 408 519">Currently Unavailable See Operator's Manual</p> | <p data-bbox="476 291 1615 410">* ABS and ESP® are temporarily unavailable.<br/>Other driving systems and driving safety systems (e.g. BAS) may also be temporarily unavailable.<br/>The brake system will continue to operate normally. The braking distance in an emergency braking situation can increase.</p> <div data-bbox="495 430 1646 650" style="border: 1px solid gray; padding: 5px;"> <p data-bbox="513 441 1190 467"><b>▲ WARNING</b> Risk of skidding if ABS and ESP® are malfunctioning</p> <p data-bbox="513 482 1628 570">The wheels may block during braking and ESP® does not perform any vehicle stabilization.<br/>The steerability and braking characteristics are heavily impaired and the braking distance may increase. In addition, other driving safety systems are switched off.</p> <ul style="list-style-type: none"> <li data-bbox="513 581 728 607">► Drive on carefully.</li> <li data-bbox="513 617 1308 643">► Have ABS and ESP® checked immediately at a qualified specialist workshop.</li> </ul> </div> <ul style="list-style-type: none"> <li data-bbox="495 669 1572 721">► Drive carefully on a suitable stretch of road, making slight steering movements at a speed above 19 mph (30 km/h).</li> <li data-bbox="495 731 1633 754">► If the display message does not disappear, consult a qualified specialist workshop immediately. Drive carefully.</li> </ul> |



| Display messages   | Possible causes/consequences and ► Solutions   |
|--|--|
|  <p data-bbox="195 427 469 477">Inoperative See Operator's Manual</p>           | <p data-bbox="528 251 1665 370">* ABS and ESP® are malfunctioning.<br/>Other driving systems and driving safety systems (e.g. BAS) may also be malfunctioning.<br/>The brake system will continue to operate normally. The braking distance in an emergency braking situation can increase.</p> <div data-bbox="556 391 1696 436" style="background-color: #f0f0f0; padding: 5px;"> <p data-bbox="565 401 1240 427">▲ <b>WARNING</b> Risk of skidding if ABS and ESP® are malfunctioning</p> </div> <p data-bbox="565 443 1677 529">The wheels may block during braking and ESP® does not perform any vehicle stabilization.<br/>The steerability and braking characteristics are heavily impaired and the braking distance may increase. In addition, other driving safety systems are switched off.</p> <ul data-bbox="565 539 1360 601" style="list-style-type: none"> <li data-bbox="565 539 778 565">► Drive on carefully.</li> <li data-bbox="565 576 1360 601">► Have ABS and ESP® checked immediately at a qualified specialist workshop.</li> </ul> |
|  <p data-bbox="195 717 458 767">Currently Unavailable See Operator's Manual</p> | <p data-bbox="528 631 1424 692">* ESP® is temporarily unavailable.<br/>Other driving systems and driving safety systems (e.g. BAS) may also be malfunctioning.</p> <div data-bbox="556 712 1696 757" style="background-color: #f0f0f0; padding: 5px;"> <p data-bbox="565 717 1134 743">▲ <b>WARNING</b> Risk of skidding if ESP® is malfunctioning</p> </div> <p data-bbox="565 764 1665 809">If ESP® is malfunctioning, ESP® cannot carry out vehicle stabilization. In addition, other driving safety systems are switched off.</p> <ul data-bbox="565 819 778 845" style="list-style-type: none"> <li data-bbox="565 819 778 845">► Drive on carefully.</li> </ul>  |

## 344 Display messages and warning/indicator lamps

| Display messages   | Possible causes/consequences and ► Solutions   |
|--|--|
|  | <ul style="list-style-type: none"><li>► Have ESP® checked at a qualified specialist workshop.</li><li>► Drive carefully on a suitable stretch of road, making slight steering movements at a speed above 19 mph (30 km/h).</li><li>► If the display message does not disappear, consult a qualified specialist workshop immediately. Drive carefully.</li></ul>  |
|  <p data-bbox="145 508 417 555">Inoperative See Operator's Manual</p> | <p data-bbox="476 415 731 441">* ESP® is malfunctioning.</p> <p data-bbox="495 451 1374 477">Other driving systems and driving safety systems (e.g. BAS) may also be malfunctioning.</p> <p data-bbox="495 487 1613 534">The brake system will continue to operate normally. The braking distance in an emergency braking situation can increase.</p> <div data-bbox="495 555 1650 596" style="background-color: #e0e0e0;"><p data-bbox="513 565 1082 591"><b>▲ WARNING</b> Risk of skidding if ESP® is malfunctioning</p></div> <p data-bbox="513 607 1613 653">If ESP® is malfunctioning, ESP® cannot carry out vehicle stabilization. In addition, other driving safety systems are switched off.</p> <ul style="list-style-type: none"><li>► Drive on carefully.</li><li>► Have ESP® checked at a qualified specialist workshop.</li></ul> |

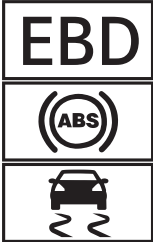
| Display messages   | Possible causes/consequences and ► Solutions  |
|--|---|
|  <p data-bbox="195 513 469 560">Inoperative See Operator's Manual</p> | <p data-bbox="524 249 1424 311">* EBD, ABS and ESP® are malfunctioning.<br/>Other driving systems and driving safety systems (e.g. BAS) may also be malfunctioning.</p> <div data-bbox="547 329 1696 547" style="border: 1px solid gray; padding: 5px;"> <p data-bbox="565 339 1295 365">▲ <b>WARNING</b> Risk of skidding if EBD, ABS and ESP® are malfunctioning</p> <p data-bbox="565 381 1465 407">The wheels may block during braking and ESP® does not perform any vehicle stabilization.</p> <p data-bbox="565 417 1683 469">The steerability and braking characteristics are heavily impaired and the braking distance may increase. In addition, other driving safety systems are switched off.</p> <ul style="list-style-type: none"> <li data-bbox="565 479 778 505">► Drive on carefully.</li> <li data-bbox="565 515 1387 541">► Have the brake system checked immediately at a qualified specialist workshop.</li> </ul> </div> |
| <p data-bbox="195 588 469 666">Active Brake Assist Functions Currently Limited See Operator's Manual</p>   | <p data-bbox="524 588 1683 640">* <b>Vehicles with the Driving Assistance Package:</b> Active Brake Assist with cross-traffic function, Evasive Steering Assist or PRE-SAFE® PLUS are temporarily unavailable or only partially available.</p> <p data-bbox="543 650 1702 702"><b>Vehicles without the Driving Assistance Package:</b> Active Brake Assist is temporarily unavailable or only partially available.</p> <p data-bbox="543 712 1230 738">The ambient conditions are outside the system limits (→ page 166).</p> <ul style="list-style-type: none"> <li data-bbox="543 749 1613 800">► Drive on.<br/>As soon as the ambient conditions are within the system limits, the system will become available again.</li> <li data-bbox="543 811 1696 857">► If the display message does not disappear, stop the vehicle in accordance with the traffic conditions and restart the engine.</li> </ul>                                    |



## 346 Display messages and warning/indicator lamps



| Display messages  | Possible causes/consequences and ► Solutions   |
|---|--|
| Active Brake Assist Functions Limited See Operator's Manual | <ul style="list-style-type: none"><li>* <b>Vehicles with Driving Assistance Package:</b> Active Brake Assist with cross-traffic function, Evasive Steering Assist or PRE-SAFE® PLUS is malfunctioning.</li><li><b>Vehicles without Driving Assistance Package:</b> Active Brake Assist is malfunctioning.</li></ul> <ul style="list-style-type: none"><li>► Consult a qualified specialist workshop.</li></ul> |

### Mercedes me connect

| Display messages   | Possible causes/consequences and ► Solutions  |
|--|---|
| Mercedes me connect Services Limited See Operator's Manual                                       | <ul style="list-style-type: none"><li>* The vehicle functions for malfunction detection are restricted.<br/>At least one of the main functions of the Mercedes me connect system is malfunctioning.</li></ul> <ul style="list-style-type: none"><li>► Observe the notes on the diagnostics connection (→ page 23).</li><li>► Consult a qualified specialist workshop.</li></ul> |
| <br>Inoperative | <ul style="list-style-type: none"><li>* At least one of the main functions of the Mercedes me connect system or of the SOS emergency call system is malfunctioning.</li></ul> <ul style="list-style-type: none"><li>► Consult a qualified specialist workshop.</li></ul>  |



## Battery

| Display messages  | Possible causes/consequences and ► Solutions  |
|---|---|
|  <p data-bbox="195 384 445 433">12 V Battery See Operator's Manual</p> | <ul style="list-style-type: none"> <li>* The engine is off and the charge level is too low.               <ul style="list-style-type: none"> <li>► Switch off electrical consumers that are not required.</li> </ul> </li> <li>To charge the battery:               <ul style="list-style-type: none"> <li>► Leave the engine running for a few minutes, or drive an extended distance.</li> </ul> </li> <li>* If the message appears while the engine is running, this indicates an on-board electrical system malfunction.               <ul style="list-style-type: none"> <li>► Consult a qualified specialist workshop.</li> </ul> </li> </ul> |
|  <p data-bbox="195 615 426 636">See Operator's Manual</p>              | <ul style="list-style-type: none"> <li>* The battery is not being charged.               <div style="border: 1px solid gray; padding: 5px; margin: 10px 0;"> <p><b>!</b> <b>NOTE</b> Possible engine damage if you continue driving</p> <ul style="list-style-type: none"> <li>► Do not continue driving under any circumstances.</li> <li>► Consult a qualified specialist workshop.</li> </ul> </div> <ul style="list-style-type: none"> <li>► Pull over and stop the vehicle safely and switch off the engine, paying attention to road and traffic conditions.</li> <li>► Consult a qualified specialist workshop.</li> </ul> </li> </ul>       |

| Display messages  | Possible causes/consequences and ► Solutions   |
|---|--|
|  <p data-bbox="144 342 391 391">Stop Vehicle See Operator's Manual</p> | <p data-bbox="476 249 1193 273">* The battery is no longer being charged and the charge level is too low.</p> <div data-bbox="500 291 1646 412" style="border: 1px solid black; padding: 5px;"> <p data-bbox="513 301 1092 325"><b>!</b> <b>NOTE</b> Possible engine damage if you continue driving</p> <ul style="list-style-type: none"> <li data-bbox="513 342 1045 366">► Do not continue driving under any circumstances.</li> <li data-bbox="513 377 944 400">► Consult a qualified specialist workshop.</li> </ul> </div> <ul style="list-style-type: none"> <li data-bbox="495 428 1618 477">► Stop the vehicle immediately in accordance with the traffic conditions. Do not continue driving under any circumstances.</li> <li data-bbox="495 487 750 511">► Switch off the engine.</li> <li data-bbox="495 522 925 545">► Consult a qualified specialist workshop.</li> </ul> |
|  <p data-bbox="144 660 413 709">Stop Vehicle Leave Engine Running</p>  | <p data-bbox="476 567 842 591">* The battery charge level is too low.</p> <ul style="list-style-type: none"> <li data-bbox="495 601 1480 625">► Stop the vehicle immediately in accordance with the traffic conditions. Do not continue driving.</li> <li data-bbox="495 636 787 659">► Leave the engine running.</li> <li data-bbox="495 670 1153 694">► Wait until the display message disappears before pulling away.</li> <li data-bbox="495 704 1391 728">► <b>If the display message does not disappear:</b> consult a qualified specialist workshop.</li> </ul>   |

## Tire pressure monitor

| Display messages  | Possible causes/consequences and ► Solutions  |
|---|---|
| Tire Press. Monitor Currently Unavailable   | <ul style="list-style-type: none"> <li>* There is interference from a powerful radio signal source. As a result, no signals from the tire pressure sensor are being received. The tire pressure monitor is temporarily unavailable.               <ul style="list-style-type: none"> <li>► Drive on.<br/>The tire pressure monitor will restart automatically as soon as the cause has been rectified.</li> </ul> </li> </ul>   |
| Tire Press. Monitor Inoperative   | <ul style="list-style-type: none"> <li>* The tire pressure monitor is malfunctioning.               <div style="border: 1px solid gray; padding: 5px; margin-top: 10px;"> <p><b>⚠ WARNING</b> There is a risk of an accident if the tire pressure monitoring system is malfunctioning</p> <p>The tire pressure monitoring system cannot issue a warning if there is pressure loss in one or more of the tires. Tires with insufficient tire pressure may impair the driving characteristics as well as steering and braking.</p> <p>► Have the tire pressure monitoring system checked at a qualified specialist workshop.</p> </div> </li> </ul> |
| Tire Pressure Monitor Inoperative No Wheel Sensors  | <ul style="list-style-type: none"> <li>* The wheels installed do not have suitable tire pressure sensors. The tire pressure monitor is deactivated.               <ul style="list-style-type: none"> <li>► Install wheels with suitable tire pressure sensors.</li> </ul> </li> </ul>   |
| <div style="text-align: center;">  </div> <p>Wheel Sensor(s) Missing</p> | <ul style="list-style-type: none"> <li>* There is no signal from the tire pressure sensor of one or more wheels. No pressure value is displayed for the affected tire.               <ul style="list-style-type: none"> <li>► Have the faulty tire pressure sensor replaced at a qualified specialist workshop.</li> </ul> </li> </ul>  |

| Display messages  | Possible causes/consequences and ► Solutions   |
|---|--|
|  <p data-bbox="144 342 266 363">Check Tires</p>                  | <p data-bbox="476 249 1498 270">* The tire pressure in one or more tires has dropped significantly. The wheel position will be displayed.</p> <div data-bbox="500 291 1646 557" style="border: 1px solid gray; padding: 5px;"> <p data-bbox="513 301 1179 322">▲ <b>WARNING</b> Risk of an accident due to insufficient tire pressure</p> <ul data-bbox="519 342 1415 433" style="list-style-type: none"> <li>• The tires can burst.</li> <li>• The tires can wear excessively and/or unevenly.</li> <li>• The driving characteristics as well as the steering and braking may be greatly impaired.</li> </ul> <p data-bbox="513 453 931 474">You could then lose control of the vehicle.</p> <ul data-bbox="513 487 968 547" style="list-style-type: none"> <li>► Observe the recommended tire pressures.</li> <li>► Adjust the tire pressure if necessary.</li> </ul> </div> <ul data-bbox="495 570 1105 629" style="list-style-type: none"> <li>► Stop the vehicle in accordance with the traffic conditions.</li> <li>► Check the tire pressure (→ page 265) and the tires.</li> </ul> |
|  <p data-bbox="144 743 395 788">Please Correct Tire Pressure</p> | <p data-bbox="476 650 1591 695">* The tire pressure is too low in at least one of the tires, or the difference in tire pressure between the individual wheels is too great.</p> <ul data-bbox="495 712 1452 767" style="list-style-type: none"> <li>► Check the tire pressure and add air, if necessary.</li> <li>► When the tire pressure is correct, restart the tire pressure monitoring system (→ page 270).</li> </ul>  |



| Display messages  | Possible causes/consequences and ► Solutions   |
|---|--|
|  <p data-bbox="195 342 449 366">Warning Tire Malfunction</p> | <p data-bbox="524 249 1520 273">* The tire pressure in one or more tires has dropped suddenly. The wheel position will be displayed.</p> <div data-bbox="561 291 1698 521" style="border: 1px solid gray; padding: 5px;"> <p data-bbox="565 301 1184 325">▲ <b>WARNING</b> Risk of an accident from driving with a flat tire</p> <ul data-bbox="565 342 1467 401" style="list-style-type: none"> <li>• The tires can overheat and cause a fire.</li> <li>• The driving characteristics as well as the steering and braking may be greatly impaired.</li> </ul> <p data-bbox="565 418 981 442">You could then lose control of the vehicle.</p> <ul data-bbox="565 453 907 512" style="list-style-type: none"> <li>► Do not drive on with a flat tire.</li> <li>► Observe the notes on flat tires.</li> </ul> </div> <p data-bbox="543 539 879 563">Notes on flat tires (→ page 245).</p> <ul data-bbox="543 574 1156 629" style="list-style-type: none"> <li>► Stop the vehicle in accordance with the traffic conditions.</li> <li>► Check the tires.</li> </ul> |
| <p data-bbox="195 648 371 672">Tires Overheated</p>   | <p data-bbox="524 648 1692 703">* At least one tire is overheating. The affected tires are displayed in red. At temperatures close to the limit value, the tires are displayed in yellow.</p> <div data-bbox="561 721 1698 835" style="border: 1px solid gray; padding: 5px;"> <p data-bbox="565 731 1254 755">▲ <b>WARNING</b> Risk of an accident from driving with overheated tires</p> <p data-bbox="565 771 837 795">Overheated tires can burst.</p> <ul data-bbox="565 807 1018 830" style="list-style-type: none"> <li>► Reduce speed so that the tires cool down.</li> </ul> </div>  |

## 352 Display messages and warning/indicator lamps



| Display messages | Possible causes/consequences and ► Solutions  |
|------------------|---|
| Decrease Speed   | <p>* At least one tire is overheating. The affected tires are displayed in red. At temperatures close to the limit value, the tires are displayed in yellow.</p> <p><b>▲ WARNING</b> Risk of an accident from driving with overheated tires</p> <p>Overheated tires can burst.</p> <p>► Reduce speed so that the tires cool down.</p> |



### Tire pressure loss warning system

| Display messages         | Possible causes/consequences and ► Solutions  |
|--------------------------|---|
| Check Tire Pressure Soon | <p>* Canada only:<br/>The tire pressure loss warning system has detected a significant loss of pressure.</p> <p><b>▲ WARNING</b> Risk of an accident due to insufficient tire pressure</p> <ul style="list-style-type: none"><li>• The tires can burst.</li><li>• The tires can wear excessively and/or unevenly.</li><li>• The driving characteristics as well as the steering and braking may be greatly impaired.</li></ul> <p>You could then lose control of the vehicle.</p> |

| Display messages                                    | Possible causes/consequences and ► Solutions  |
|---|---|
|   | <ul style="list-style-type: none"> <li>▶ Observe the recommended tire pressures.</li> <li>▶ Adjust the tire pressure if necessary.</li> </ul><br><ul style="list-style-type: none"> <li>▶ Stop the vehicle in accordance with the traffic conditions.</li> <li>▶ Check the tire pressure (→ page 265) and the tires.</li> <li>▶ When the tire pressure is correct, restart the tire pressure loss warning system (→ page 271).</li> </ul> |
| Check Tire Pressure Then Restart Run Flat Indicator | * Canada only:<br>The tire pressure loss warning system generated a display message and has not been restarted since. <ul style="list-style-type: none"> <li>▶ When the tire pressure is correct, restart the tire pressure loss warning system (→ page 271).</li> </ul>  |
| Run Flat Indicator Inoperative                      | * Canada only:<br>The tire pressure loss warning system is malfunctioning. <ul style="list-style-type: none"> <li>▶ Consult a qualified specialist workshop.</li> </ul>   |

## Engine oil

| Display messages  | Possible causes/consequences and ► Solutions   |
|---|--|
|  <p data-bbox="144 381 376 433">Check Engine Oil Level<br/>(Add 1 quart)</p> | <p data-bbox="476 288 1038 347">* Display message only for certain engines:<br/>The engine oil level has dropped to the minimum level.</p> <div data-bbox="500 366 1646 453" style="border: 1px solid #ccc; padding: 5px;"> <p data-bbox="513 373 1223 401">! <b>NOTE</b> Engine damage caused by driving with insufficient engine oil</p> <p data-bbox="513 415 1020 443">► Avoid long journeys with insufficient engine oil.</p> </div> <p data-bbox="495 467 1204 536">► When next refueling, add 1.1 US qt (1 l) of engine oil (→ page 233).<br/>Notes on engine oil (→ page 302).</p> |
|  <p data-bbox="144 647 421 671">Engine Oil Reduce Oil Level</p>              | <p data-bbox="476 554 909 613">* Display message only for certain engines:<br/>The engine oil level is too high.</p> <div data-bbox="500 632 1646 720" style="border: 1px solid #ccc; padding: 5px;"> <p data-bbox="513 640 1179 668">! <b>NOTE</b> Engine damage caused by driving with excess engine oil</p> <p data-bbox="513 681 975 709">► Avoid long journeys with excess engine oil.</p> </div> <p data-bbox="495 733 1432 761">► Consult a qualified specialist workshop immediately and have the engine oil level reduced.</p>  |

| Display messages   | Possible causes/consequences and ► Solutions  |
|--|---|
|  <p data-bbox="195 342 458 391">Engine Oil Level Low Stop<br/>Vehicle Turn Engine Off</p> | <p data-bbox="524 249 962 308">* Display message only for certain engines:<br/>The engine oil level is too low.</p> <div data-bbox="561 327 1698 368" style="border: 1px solid black; padding: 5px;"> <p data-bbox="569 337 1273 360">! <b>NOTE</b> Engine damage caused by driving with insufficient engine oil</p> </div> <div data-bbox="561 373 1698 412" style="border: 1px solid black; padding: 5px;"> <p data-bbox="569 379 1068 401">► Avoid long journeys with insufficient engine oil.</p> </div> <ul data-bbox="543 430 1530 557" style="list-style-type: none"> <li data-bbox="543 430 1530 456">► Stop the vehicle immediately in accordance with the traffic conditions. Do not continue driving.</li> <li data-bbox="543 462 800 487">► Switch off the engine.</li> <li data-bbox="543 493 1045 519">► Add 1.1 US qt (1 l) of engine oil (→ page 233).</li> <li data-bbox="543 524 842 550">► Check the engine oil level.</li> </ul> <p data-bbox="543 576 892 598">Notes on engine oil (→ page 302).</p> |
|  <p data-bbox="195 705 445 754">Engine Oil Pressure Stop<br/>Switch Off Engine</p>        | <p data-bbox="524 617 962 676">* Display message only for certain engines:<br/>The oil pressure is too low.</p> <div data-bbox="561 695 1698 736" style="border: 1px solid black; padding: 5px;"> <p data-bbox="569 705 1295 728">! <b>NOTE</b> Engine damage caused by driving with insufficient oil pressure</p> </div> <div data-bbox="561 741 1698 780" style="border: 1px solid black; padding: 5px;"> <p data-bbox="569 746 1021 769">► Avoid driving with insufficient oil pressure.</p> </div> <ul data-bbox="543 793 1530 852" style="list-style-type: none"> <li data-bbox="543 793 1530 819">► Stop the vehicle immediately in accordance with the traffic conditions. Do not continue driving.</li> <li data-bbox="543 824 975 850">► Consult a qualified specialist workshop.</li> </ul>   |

## 356 Display messages and warning/indicator lamps

| Display messages   | Possible causes/consequences and ► Solutions  |
|--|---|
|  <p data-bbox="144 342 417 391">Engine Oil Level Cannot Be Measured</p> | <p data-bbox="473 249 1489 272">* The electrical connection to the oil level sensor has been interrupted or the oil level sensor is faulty.</p> <p data-bbox="491 282 925 305">► Consult a qualified specialist workshop.</p> |

### Warning and indicator lamps



#### Overview of indicator and warning lamps

Some systems will perform a self-test when the ignition is switched on. Some indicator and warning lamps may briefly light up or flash. This behavior is non-critical. These indicator and warning lamps indicate a malfunction only if they light up or flash after the engine has been started or during a journey.

### Instrument Display (standard)



#### Indicator and warning lamps:

-  Restraint system (→ page 357)
-  Seat belt (→ page 357)



Electric power steering  
(→ page 359)



Check Engine (→ page 359)



Electrical malfunction (→ page 359)



Reserve fuel with fuel filler flap location indicator (→ page 359)



USA: electric parking brake (red)  
(→ page 363)



Canada: electric parking brake (red)  
(→ page 363)













Electric parking brake (yellow)  
(→ page 363)



USA: brakes (red) (→ page 363)





Canada: brakes (red) (→ page 363)

|   |                                    |
|---|------------------------------------|
|  | Distance warning (→ page 365)      |
|  | ABS (→ page 365)                   |
|  | ESP® (→ page 365)                  |
|  | ESP® OFF (→ page 365)              |
|  | Tire pressure monitor (→ page 368) |
|  | Parking lamps (→ page 114)         |
|  | Low beam (→ page 114)              |
|  | High beam (→ page 115)             |
|  | Turn signal lights (→ page 115)    |
|  | Front fog lamps (→ page 114)       |
|  | Rear fog lamp (→ page 114)         |

## Occupant safety

| Warning/indicator lamp   | Possible causes/consequences and ► Solutions   |
|--|--|
|  <p data-bbox="195 790 452 840">Restraint system warning lamp</p> | <p data-bbox="504 697 1215 723">The red restraint system warning lamp is lit while the engine is running.</p> <p data-bbox="513 731 1053 757">*The restraint system is malfunctioning (→ page 32).</p> <div data-bbox="532 774 1696 852" style="background-color: #e0e0e0; padding: 5px;"> <p data-bbox="541 783 1271 809"><b>▲ WARNING</b> Risk of injury due to malfunctions in the restraint system</p> <p data-bbox="541 821 1641 847">Components in the restraint system may be activated unintentionally or not deploy as planned in an accident.</p> </div> |

| Warning/indicator lamp  | Possible causes/consequences and ► Solutions   |
|---|--|
|   | <p>► Have the restraint system checked and repaired immediately at a qualified specialist workshop.</p> <ul style="list-style-type: none"> <li>► Drive on carefully.</li> <li>► Note the messages on the multifunction display.</li> <li>► Consult a qualified specialist workshop immediately.</li> </ul>   |
|  <p>Seat belt warning lamp flashes</p>   | <p>The red seat belt warning lamp flashes and an intermittent warning tone sounds.</p> <ul style="list-style-type: none"> <li>* The driver or front passenger has not fastened their seat belt while the vehicle is in motion.           <ul style="list-style-type: none"> <li>► Fasten your seat belt (→ page 35).</li> </ul> </li> <li>* There are objects on the front passenger seat.           <ul style="list-style-type: none"> <li>► Remove the objects from the front passenger seat.</li> </ul> </li> </ul> |
|  <p>Seat belt warning lamp lights up</p> | <p>The red seat belt warning lamp will light up for six seconds once the engine has started. In addition, a warning tone may sound.</p> <ul style="list-style-type: none"> <li>* The seat belt warning lamp reminds the driver and front passenger to fasten their seat belts.           <ul style="list-style-type: none"> <li>► Fasten your seat belt (→ page 35).</li> </ul> </li> </ul> <p>If you have placed objects on the front passenger seat, the seat belt warning lamp may remain lit.</p>                  |





## Vehicle

| Warning/indicator lamp  | Possible causes/consequences and ► Solutions  |
|---|---|
|  <p data-bbox="195 384 426 433">Electric power steering warning lamp (red)</p> | <p data-bbox="506 291 1282 314">The red electric power steering warning lamp is lit while the engine is running.</p> <p data-bbox="506 325 1134 349">*The power assistance or the steering itself is malfunctioning.</p> <div data-bbox="537 366 1696 547" style="border: 1px solid gray; padding: 5px;"> <p data-bbox="547 377 1190 400"><b>▲ WARNING</b> Risk of accident if steering capability is impaired</p> <p data-bbox="547 418 1448 442">If the steering does not function as intended, the vehicle's operating safety is jeopardized.</p> <ul style="list-style-type: none"> <li data-bbox="547 452 1652 501">▶ Pull over and stop the vehicle safely as soon as possible, paying attention to road and traffic conditions. Do not continue driving under any circumstances.</li> <li data-bbox="547 511 981 535">▶ Consult a qualified specialist workshop.</li> </ul> </div> <p data-bbox="528 563 1045 587">► Note the messages on the multifunction display.</p> |

## Engine

| Warning/indicator lamp  | Possible causes/consequences and ► Solutions   |
|---|--|
|  <p data-bbox="195 824 417 848">Coolant warning lamp</p> | <p data-bbox="506 731 1129 755">The red coolant warning lamp is lit while the engine is running.</p> <p data-bbox="506 765 694 789">*Possible causes:</p> <ul style="list-style-type: none"> <li data-bbox="537 799 981 823">• The temperature sensor is malfunctioning</li> <li data-bbox="537 833 833 857">• The coolant level is too low</li> </ul> |

| Warning/indicator lamp | Possible causes/consequences and ► Solutions  |
|------------------------|---|
|                        | <ul style="list-style-type: none"><li>• The air supply to the radiator is obstructed</li><li>• The radiator fan is faulty</li></ul> <p>If there is an additional warning tone, the coolant temperature has exceeded the maximum permissible temperature.</p> <div data-bbox="482 368 1646 410"><p><b>▲ WARNING</b> Danger of burns when opening the hood</p></div> <p>If you open the hood when the engine has overheated or during a fire in the engine compartment, you could come into contact with hot gases or other escaping operating fluids.</p> <ul style="list-style-type: none"><li>▶ Before opening the hood, allow the engine to cool down.</li><li>▶ In the event of a fire in the engine compartment, keep the hood closed and call the fire service.</li></ul> <ul style="list-style-type: none"><li>▶ Pull over and stop the vehicle safely and switch off the engine, paying attention to road and traffic conditions. Do not continue driving.</li><li>▶ Note the messages on the multifunction display.</li></ul> <p>If the coolant temperature display is at the lower end of the temperature scale:</p> <ul style="list-style-type: none"><li>▶ Consult a qualified specialist workshop.</li></ul> <p>or</p> <ul style="list-style-type: none"><li>▶ Exit the vehicle and keep a safe distance from it until the engine has cooled down.</li><li>▶ Check the coolant level (→ page 234).</li><li>▶ Make sure that the air supply to the radiator is not obstructed.</li></ul> |

| Warning/indicator lamp   | Possible causes/consequences and ► Solutions   |
|--|--|
|  | <ul style="list-style-type: none"> <li>► Avoiding high loads on the engine, drive to the nearest qualified specialist workshop. In doing so, ensure that the coolant temperature display remains below the red area.</li> </ul>  |
|  <p data-bbox="195 410 454 458">Engine diagnosis warning lamp</p>       | <p data-bbox="510 319 1221 342">The yellow Check Engine warning lamp is lit while the engine is running.</p> <p data-bbox="510 353 1341 377">*A malfunction has occurred in the engine, the exhaust system or the fuel system.</p> <p data-bbox="528 387 1406 411">The emission limit values may be exceeded and the engine may be in emergency mode.</p> <p data-bbox="528 421 1665 470">In some states, legal requirements stipulate that you must immediately consult a qualified specialist workshop as soon as the yellow Check Engine warning lamp lights up.</p> <ul style="list-style-type: none"> <li>► Have the vehicle checked as soon as possible at a qualified specialist workshop.</li> </ul> |
|  <p data-bbox="195 612 473 660">Electrical malfunction warning lamp</p> | <p data-bbox="510 521 925 544">The red electrical fault warning lamp is lit.</p> <p data-bbox="510 555 842 579">* There is a fault in the electrics.</p> <ul style="list-style-type: none"> <li>► Note the messages on the multifunction display.</li> </ul>   |
|  <p data-bbox="195 772 463 821">Fuel reserve warning lamp flashes</p>   | <p data-bbox="510 681 1184 705">The yellow fuel reserve warning lamp lights up while you are driving.</p> <p data-bbox="510 715 1683 764">*There has been pressure loss in the fuel system. The fuel filler cap is not closed correctly or the fuel system is leaking.</p> <ul style="list-style-type: none"> <li>► Close the fuel filler cap.</li> </ul> <p data-bbox="528 826 1064 850">If the fuel filler cap has already been closed correctly:</p> <ul style="list-style-type: none"> <li>► Consult a qualified specialist workshop.</li> </ul>   |

## 362 Display messages and warning/indicator lamps

---

### Warning/indicator lamp



Fuel reserve warning lamp  
lights up

### Possible causes/consequences and ► Solutions

The yellow fuel reserve warning lamp lights up while the engine is running.

\* The fuel supply has dropped into the reserve range.

► Refuel.

## Brakes

| Warning/indicator lamp   | Possible causes/consequences and ► Solutions  |
|--|---|
| <div data-bbox="203 295 360 372" data-label="Image"> </div> <p data-bbox="194 383 471 429">Electric parking brake indicator lamp (red) (USA only)</p> <div data-bbox="203 440 360 518" data-label="Image"> </div> <p data-bbox="194 528 471 606">Electric parking brake indicator lamp (red) (Canada only)</p> <div data-bbox="203 616 360 694" data-label="Image"> </div> <p data-bbox="194 704 471 751">The electric parking brake (yellow) indicator lamp</p> | <p data-bbox="508 290 1108 315">The red electric parking brake indicator lamp flashes or is lit.</p> <p data-bbox="508 326 1422 352">The yellow electric parking brake indicator lamp also lights up in the event of a malfunction.</p> <p data-bbox="508 362 1044 388">* ► Note the messages on the multifunction display.</p> |

**Warning/indicator lamp**



Brake warning lamp (USA only)



Brake system warning lamp (Canada only)

**Possible causes/consequences and ► Solutions**

The red brake system warning lamp is lit while the engine is running.

\*Possible causes:

- The brake force boosting is malfunctioning and the braking characteristics may be affected.
- There is insufficient brake fluid in the brake fluid reservoir.

► Note the messages on the multifunction display.

**▲ WARNING Risk of accident and injury if brake force boosting is malfunctioning**

If brake force boosting is malfunctioning, increased brake pedal force may be necessary for braking. The braking characteristics may be impaired. The braking distance can increase in emergency braking situations.

- Stop in a safe location immediately. Do not continue driving.
- Consult a qualified specialist workshop.

**▲ WARNING Risk of an accident due to low brake fluid level**

If the brake fluid level is too low, the braking effect and the braking characteristics may be impaired.



- Pull over and stop the vehicle safely as soon as possible, paying attention to road and traffic conditions. Do not continue driving under any circumstances.
- Consult a qualified specialist workshop.
- Do not add brake fluid.

## Driving systems

| Warning/indicator lamp  | Possible causes/consequences and ► Solutions  |
|---|---|
|  <p data-bbox="195 384 462 433">Warning lamp for distance warning function</p> | <p data-bbox="504 291 1204 314">The red distance warning lamp lights up while the vehicle is in motion.</p> <p data-bbox="513 325 1230 349">* The distance to the vehicle in front is too small for the speed selected.</p> <p data-bbox="526 359 1435 383">If there is an additional warning tone, you are approaching an obstacle at too high a speed.</p> <ul style="list-style-type: none"> <li data-bbox="526 393 907 417">► Be prepared to brake immediately.</li> <li data-bbox="526 427 787 451">► Increase the distance.</li> </ul> <p data-bbox="526 469 990 493">Function of Active Brake Assist (→ page 166).</p> |

## Driving safety systems



| Warning/indicator lamp  | Possible causes/consequences and ► Solutions   |
|---|--|
|  <p data-bbox="195 729 380 753">ABS warning lamp</p> | <p data-bbox="504 636 1127 659">The yellow ABS warning lamp is lit while the engine is running.</p> <p data-bbox="513 670 753 694">* ABS is malfunctioning.</p> <p data-bbox="526 704 1130 728">If there is an additional warning tone, EBD is malfunctioning.</p> <p data-bbox="526 738 1304 762">Other driving systems and driving safety systems may also be malfunctioning.</p> <ul style="list-style-type: none"> <li data-bbox="526 772 1045 796">► Note the messages on the multifunction display.</li> </ul> |

| Warning/indicator lamp   | Possible causes/consequences and ► Solutions   |
|--|--|
|  | <p><b>▲ WARNING</b> There is a risk of skidding if EBD or ABS is malfunctioning</p> <p>The wheels may lock during braking.</p> <p>The steerability and braking characteristics are heavily impaired and the braking distance may increase. In addition, other driving safety systems are switched off.</p> <ul style="list-style-type: none"> <li>▶ Drive on carefully.</li> <li>▶ Have the brake system checked immediately at a qualified specialist workshop.</li> </ul>  |
|  <p>ESP® warning lamp flashes</p>   | <p>The yellow ESP® warning lamp flashes while the vehicle is in motion.</p> <p>* One or more wheels has reached its grip limit (→ page 164).</p> <ul style="list-style-type: none"> <li>▶ Adapt your driving style to suit the road and weather conditions.</li> </ul>   |
|  <p>ESP® warning lamp lights up</p> | <p>The yellow ESP® warning lamp is lit while the engine is running.</p> <p>*ESP® is malfunctioning.</p> <p>Other driving systems and driving safety systems (e.g. BAS) may also be malfunctioning.</p> <ul style="list-style-type: none"> <li>▶ Note the messages on the multifunction display.</li> </ul> <p><b>▲ WARNING</b> Risk of skidding if ESP® is malfunctioning</p> <p>If ESP® is malfunctioning, ESP® cannot carry out vehicle stabilization. In addition, other driving safety systems are switched off.</p> |



| Warning/indicator lamp   | Possible causes/consequences and ► Solutions   |
|--|--|
|  | <ul style="list-style-type: none"> <li>▶ Drive on carefully.</li> <li>▶ Have ESP® checked at a qualified specialist workshop.</li> </ul>   |
|  <p data-bbox="195 439 439 464">ESP® OFF warning lamp</p> | <p data-bbox="506 346 1184 370">The yellow ESP® OFF warning lamp is lit while the engine is running.</p> <p data-bbox="506 381 735 406">*ESP® is deactivated.</p> <p data-bbox="528 416 1267 441">Other driving systems and driving safety systems may also be inoperative.</p> <div data-bbox="528 462 1696 505" style="background-color: #e0e0e0; padding: 5px;"> <p data-bbox="543 470 1227 495">▲ <b>WARNING</b> Risk of skidding when driving with ESP® deactivated</p> </div> <p data-bbox="543 513 1600 538">ESP® does not act to stabilize the vehicle. The availability of further driving safety systems is also limited.</p> <ul style="list-style-type: none"> <li>▶ Drive on carefully.</li> <li>▶ Deactivate ESP® only for as long as the situation requires.</li> </ul> <p data-bbox="543 638 1073 663">If ESP® cannot be activated, ESP® is malfunctioning.</p> <ul style="list-style-type: none"> <li>▶ Have ESP® checked immediately at a qualified specialist workshop.</li> </ul> <p data-bbox="528 729 1119 754">► Observe the notes on deactivating ESP® (→ page 164).</p> |

### Tire pressure monitor

| Warning/indicator lamp  | Possible causes/consequences and ► Solutions   |
|---|--|
|  <p>Tire pressure monitoring system warning lamp flashes</p>   | <p>The yellow tire pressure monitor warning lamp (pressure loss/malfunction) flashes for approximately one minute and then remains lit.</p> <p>*The tire pressure monitor is malfunctioning.</p> <div style="border: 1px solid gray; padding: 5px; margin-top: 10px;"> <p><b>▲ WARNING</b> There is a risk of an accident if the tire pressure monitoring system is malfunctioning</p> <p>The tire pressure monitoring system cannot issue a warning if there is pressure loss in one or more of the tires. Tires with insufficient tire pressure may impair the driving characteristics as well as steering and braking.</p> <p>► Have the tire pressure monitoring system checked at a qualified specialist workshop.</p> </div> |
|  <p>Tire pressure monitoring system warning lamp lights up</p> | <p>The yellow tire pressure monitoring system warning lamp (pressure loss/malfunction) is lit.</p> <p>*The tire pressure monitoring system has detected tire pressure loss in at least one of the tires.</p> <div style="border: 1px solid gray; padding: 5px; margin-top: 10px;"> <p><b>▲ WARNING</b> Risk of an accident due to insufficient tire pressure</p> <ul style="list-style-type: none"> <li>• The tires can burst.</li> <li>• The tires can wear excessively and/or unevenly.</li> <li>• The driving characteristics as well as the steering and braking may be greatly impaired.</li> </ul> <p>You could then lose control of the vehicle.</p> <p>► Observe the recommended tire pressures.</p> </div>                |

| Warning/indicator lamp | Possible causes/consequences and ► Solutions   |
|------------------------|--|
|                        | <ul style="list-style-type: none"><li data-bbox="543 256 1698 288">▶ Adjust the tire pressure if necessary.</li><li data-bbox="543 311 1698 332">▶ Stop the vehicle in accordance with the traffic conditions.</li><li data-bbox="543 346 1698 366">▶ Check the tire pressure and the tires.</li></ul> |

## 1, 2, 3 ...

|   |     |
|---|-----|
| <b>4MATIC</b> .....                               | 151 |
| Function .....                                    | 151 |
| <b>12 V battery</b>                               |     |
| see Battery (vehicle)                             |     |
| <b>12 V socket</b>                                |     |
| see Socket (12 V)                                 |     |
| <b>115 V socket</b>                               |     |
| see Socket (115 V)                                |     |
| <b>360° Camera</b> .....                          | 191 |
| Function .....                                    | 191 |
| Opening the camera cover (rear view camera) ..... | 194 |
| Selecting a view .....                            | 193 |

## A

**A/C function**

|  |     |
|--|-----|
| Activating/deactivating (MBUX multimedia system) ..... | 129 |
| Switching on/off (control panel) .....                 | 128 |
| <b>ABS (Anti-lock Braking System)</b> .....            | 163 |
| <b>Acceleration</b>                                    |     |
| see Kickdown   |     |

**Acoustic locking verification signal**

|                                       |     |
|---------------------------------------|-----|
| Activating/deactivating .....         | 61  |
| <b>Active Blind Spot Assist</b> ..... | 201 |
| Activating/deactivating .....         | 203 |
| Brake application .....               | 202 |
| Function .....                        | 201 |
| System limitations .....              | 201 |

**Active Brake Assist**

|                      |     |
|----------------------|-----|
| Function/notes ..... | 166 |
| Setting .....        | 171 |

**Active Distance Assist DISTRONIC**

|                                    |     |
|------------------------------------|-----|
| Active Emergency Stop Assist ..... | 181 |
| Calling up a speed .....           | 177 |
| Function .....                     | 174 |
| Increasing/decreasing speed .....  | 177 |
| Requirements .....                 | 177 |
| Steering wheel buttons .....       | 177 |
| Storing a speed .....              | 177 |
| Switching off/deactivating .....   | 177 |
| Switching on/activating .....      | 177 |
| System limitations .....           | 174 |

**Active Emergency Stop Assist**

|   |     |
|---|-----|
| <b>Active Lane Keeping Assist</b> ..... | 203 |
| Activating/deactivating .....           | 205 |

|   |     |
|---|-----|
| Activating/deactivating the warning ... | 205 |
| Function .....                          | 203 |
| Setting the sensitivity .....           | 205 |
| System limits .....                     | 203 |

**Active Parking Assist**

|                               |     |
|-------------------------------|-----|
| Cross Traffic Alert .....     | 199 |
| Drive Away Assist .....       | 198 |
| Exiting a parking space ..... | 197 |
| Function .....                | 194 |
| Maneuvering assistance .....  | 199 |
| Parking .....                 | 195 |
| System limitations .....      | 194 |

**Active Service System PLUS**

see ASSYST PLUS

**Active Speed Limit Assist**

|                |     |
|----------------|-----|
| Display .....  | 178 |
| Function ..... | 178 |

**Active Steering Assist**

|                                    |     |
|------------------------------------|-----|
| Activating/deactivating .....      | 181 |
| Active Emergency Stop Assist ..... | 181 |
| Function .....                     | 179 |
| System limits .....                | 179 |

**Adaptive cruise control**

see Active Distance Assist DISTRONIC

- Adaptive Highbeam Assist**  
 Function ..... 117  
 Switching on/off ..... 118
- Additives** ..... 302  
 Engine oil ..... 302  
 Fuel ..... 302
- Additives (engine oil)**  
 see Additives
- Additives (fuel)**  
 see Fuel
- Adjustable cargo compartment floor** .... 107
- After-sales service center**  
 see ASSYST PLUS
- Air bag**  
 Reduced protection ..... 39
- Air conditioning menu**  
 Calling up ..... 129
- Air distribution**  
 Setting (MBUX multimedia system) ..... 129
- Air inlet**  
 see Air-water duct
- Air pressure**  
 see Tire pressure
- Air vents** ..... 130  
 Adjusting (front) ..... 130  
 Adjusting (rear) ..... 131
- Air vents**  
 see Air vents
- Air-recirculation mode** ..... 130
- Air-water duct** ..... 235  
 Keeping free ..... 235
- Airbag** ..... 37  
 Activation ..... 32  
 Front airbag (driver, front passenger) .... 37  
 Installation locations ..... 37  
 Knee airbag ..... 37  
 Overview ..... 37  
 PASSENGER AIR BAG indicator lamp ..... 42  
 Protection ..... 38  
 Side airbag ..... 37  
 Window curtain airbag ..... 37
- Alarm**  
 see Panic alarm
- Alarm system**  
 see ATA (anti-theft alarm system)
- All-wheel drive**  
 see 4MATIC
- Ambient lighting**  
 Setting (multimedia system) ..... 119
- Animals**  
 Pets in the vehicle ..... 59
- Anti-lock braking system**  
 see ABS (Anti-lock Braking System)
- Anti-skid chains**  
 see Snow chains
- Anti-theft protection**  
 Immobilizer ..... 80
- Anticipatory occupant protection**  
 see PRE-SAFE® (anticipatory occupant protection)  
 see PRE-SAFE® PLUS (anticipatory occupant protection plus)
- Assistance systems**  
 see Driving safety system
- ASSYST PLUS** ..... 229  
 Battery disconnection periods ..... 230  
 Displaying the service due date ..... 229  
 Function/notes ..... 229

- Regular maintenance work ..... 229  
 Special service requirements ..... 229
- ATA (anti-theft alarm system)** ..... 80  
 Activating/deactivating the interior motion sensor ..... 82  
 Arming/disarming the tow-away alarm ..... 82  
 Deactivating the alarm ..... 81  
 Function ..... 80  
 Function of the interior motion sensor .. 82  
 The tow-away alarm function ..... 81
- ATTENTION ASSIST** ..... 199, 200  
 Function ..... 199  
 Setting ..... 200  
 System limitations ..... 199
- Attention assistant**  
 see ATTENTION ASSIST
- Authorized Mercedes-Benz Center**  
 see Qualified specialist workshop
- Authorized workshop**  
 see Qualified specialist workshop
- Automatic car wash mode**  
 Activating ..... 237
- Automatic distance control**  
 see Active Distance Assist DISTRONIC
- Automatic driving lights** ..... 115
- Automatic engine start (ECO start/stop function)** ..... 142
- Automatic engine stop (ECO start/stop function)** ..... 142
- Automatic front passenger front air-bag shutoff** ..... 40, 42  
 Function of the automatic front passenger front airbag shutoff ..... 40  
 PASSENGER AIR BAG indicator lamp .... 42
- Automatic front passenger front air-bag shutoff**  
 see Automatic front passenger front airbag shutoff
- Automatic measures after an accident** ... 45
- Automatic mirror folding function**  
 Activating/deactivating ..... 127
- Automatic transmission**  
 DIRECT SELECT lever ..... 146  
 Drive program display ..... 144  
 Drive programs ..... 144
- DYNAMIC SELECT switch ..... 144  
 Engaging drive position ..... 148  
 Engaging neutral ..... 147  
 Engaging park position ..... 147  
 Engaging reverse gear ..... 147  
 Kickdown ..... 149  
 Manual gearshifting ..... 148  
 Steering wheel paddle shifters ..... 148  
 Transmission position display ..... 146  
 Transmission positions ..... 146
- Automatic transmission (problem)**  
 see Transmission (problem)
- B**
- Bag hook** ..... 105
- BAS (Brake Assist System)** ..... 163
- Battery**  
 SmartKey ..... 62
- Battery**  
 see Battery (vehicle)
- Battery (vehicle)** ..... 256  
 Charging ..... 255  
 Charging (Remote Online) ..... 135  
 Notes ..... 251

- Notes (starting assistance and charging) ..... 253  
 Replacing ..... 256  
 Starting assistance ..... 255
- Belt**  
 see Seat belt
- Blind Spot Assist** ..... 201  
 Activating/deactivating ..... 203  
 Function ..... 201  
 System limitations ..... 201
- Brake Assist System**  
 see BAS (Brake Assist System)
- Brake fluid**  
 Notes ..... 303
- Brake force distribution**  
 EBD (electronic brake force distribution) ..... 166
- Brakes**  
 ABS (Anti-lock Braking System) ..... 163  
 Active Brake Assist ..... 166  
 BAS (Brake Assist System) ..... 163  
 Driving tips ..... 136  
 EBD (electronic brake force distribution) ..... 166
- HOLD function ..... 182  
 Limited braking effect (salt-treated roads) ..... 136  
 New/replaced brakepads/brake discs ..... 136  
 Notes on breaking-in a new vehicle ..... 136  
 Post-collision brake ..... 45
- Braking assistance**  
 see BAS (Brake Assist System)
- Breakdown**  
 Changing a wheel ..... 288  
 Overview of the help functions ..... 16  
 Roadside Assistance ..... 20  
 Tow-starting ..... 260  
 Towing away ..... 257  
 Transporting the vehicle ..... 258
- Breakdown**  
 see Flat tire
- Buttons**  
 Steering wheel ..... 209
- C**
- Camera**  
 see 360° Camera
- see Rear view camera
- Car key**  
 see SmartKey
- Car wash**  
 see Care
- Car wash (care)** ..... 235
- Care** ..... 240  
 Air-water duct ..... 235  
 Automatic car wash ..... 235  
 Carpet ..... 240  
 Decorative foil ..... 238  
 Display ..... 240  
 Exterior lighting ..... 239  
 Headliner ..... 240  
 Matte finish ..... 238  
 Paintwork ..... 238  
 Plastic trim ..... 240  
 Power washer ..... 237  
 Real wood/trim elements ..... 240  
 Rear view camera ..... 239  
 Seat belts ..... 240  
 Seat cover ..... 240  
 Sensors ..... 239  
 Surround view camera ..... 239

- |                                   |     |  |     |
|-----------------------------------|-----|--|-----|
| Tailpipes .....                   | 239 | <b>Charging</b>                          |     |
| Washing by hand .....             | 238 | Battery (vehicle) .....                  | 255 |
| Wheels/rims .....                 | 239 | USB port .....                           | 110 |
| Windows .....                     | 239 | <b>Child safety lock</b>                 |     |
| Wiper blades .....                | 239 | Rear doors .....                         | 57  |
| <b>Cargo compartment cover</b>    |     | Rear side windows .....                  | 59  |
| Removing/installing .....         | 104 | <b>Child seat</b>                        |     |
| <b>Cargo compartment floor</b>    |     | Attaching (notes) .....                  | 50  |
| Adjustable .....                  | 107 | Basic instructions .....                 | 46  |
| <b>Cargo tie-down rings</b> ..... | 104 | Front-passenger seat (notes) .....       | 56  |
| <b>Carpet (Care)</b> .....        | 240 | LATCH-type (ISOFIX) (installing) .....   | 51  |
| <b>Change of address</b> .....    | 20  | Notes on risks and dangers .....         | 47  |
| <b>Change of ownership</b> .....  | 20  | Securing on the front passenger seat ... | 56  |
| <b>Changing a wheel</b>           |     | Securing on the rear seat .....          | 54  |
| Preparation .....                 | 288 | Top Tether .....                         | 53  |
| Raising the vehicle .....         | 288 | <b>Children</b>                          |     |
| <b>Changing a wheel</b>           |     | Avoiding dangers in the vehicle .....    | 47  |
| see Emergency spare wheel         |     | Basic instructions .....                 | 46  |
| <b>Changing gears</b> .....       | 148 | Special seat belt retractor .....        | 50  |
| Manually .....                    | 148 | <b>Chock</b> .....                       | 287 |
| <b>Changing hub caps</b> .....    | 288 | Storage location .....                   | 287 |
|                                   |     | <b>Chock</b>                             |     |
|                                   |     | see Chock                                |     |
|                                   |     | <b>Cleaning</b>                          |     |
|                                   |     | see Care                                 |     |
|                                   |     | <b>Climate control</b>                   |     |
|                                   |     | Activating/deactivating .....            | 128 |
|                                   |     | Activating/deactivating the A/C          |     |
|                                   |     | function (control panel) .....           | 128 |
|                                   |     | Activating/deactivating the A/C          |     |
|                                   |     | function (MBUX multimedia system) ....   | 129 |
|                                   |     | Activating/deactivating the synchroni-   |     |
|                                   |     | zation function (control panel) .....    | 129 |
|                                   |     | Activating/deactivating the synchroni-   |     |
|                                   |     | zation function (MBUX multimedia         |     |
|                                   |     | system) .....                            | 129 |
|                                   |     | Air-recirculation mode .....             | 130 |
|                                   |     | Automatic control .....                  | 129 |
|                                   |     | Calling up the air conditioning menu ... | 129 |
|                                   |     | Control panel for 3-zone automatic       |     |
|                                   |     | climate control .....                    | 128 |
|                                   |     | Filling capacity for PAG oil .....       | 306 |
|                                   |     | Front air vents .....                    | 130 |
|                                   |     | Note .....                               | 128 |
|                                   |     | Rear air vents .....                     | 131 |
|                                   |     | Refrigerant .....                        | 305 |
|                                   |     | Refrigerant filling capacity .....       | 306 |





























































|   |     |
|---|-----|
| Removing condensation from the windows .....        | 130 |
| Residual heat .....                                 | 130 |
| Setting (MBUX multimedia system) .....              | 129 |
| Ventilating the vehicle (convenience opening) ..... | 74  |
| <b>Coat hook</b> .....                              | 105 |
| <b>Coat hook on the tailgate</b> .....              | 105 |
| <b>Cockpit</b> .....                                | 6   |
| Overview .....                                      | 6   |
| <b>Coffee cup symbol</b><br>see ATTENTION ASSIST    |     |
| <b>Collision detection (parked vehicle)</b> .....   | 160 |
| <b>Combination switch</b> .....                     | 115 |
| <b>Computer</b><br>see On-board computer            |     |
| <b>Connecting the parcel net</b> .....              | 106 |
| <b>Convenience closing feature</b> .....            | 75  |
| <b>Convenience opening</b> .....                    | 74  |
| <b>Coolant (engine)</b>                             |     |
| Capacity .....                                      | 304 |
| Check level .....                                   | 234 |

|   |     |
|---|-----|
| Notes .....                                   | 303 |
| <b>Copyrights</b>                             |     |
| License .....                                 | 29  |
| Trademarks .....                              | 30  |
| <b>Cornering light</b> .....                  | 116 |
| <b>Cross Traffic Alert</b> .....              | 199 |
| <b>Crosswind Assist</b>                       |     |
| Function/notes .....                          | 166 |
| <b>Cruise control</b> .....                   | 171 |
| Buttons .....                                 | 172 |
| Calling up a speed .....                      | 172 |
| Function .....                                | 171 |
| Requirements: .....                           | 172 |
| Selecting .....                               | 172 |
| Setting a speed .....                         | 172 |
| Storing a speed .....                         | 172 |
| Switching off .....                           | 172 |
| Switching on .....                            | 172 |
| System limitations .....                      | 171 |
| <b>Customer Assistance Center (CAC)</b> ..... | 24  |
| <b>Customer Relations Department</b> .....    | 24  |

**D**

|   |     |
|---|-----|
| <b>Dashboard</b><br>see Cockpit                                       |     |
| <b>Data acquisition</b><br>Vehicle .....                              | 26  |
| <b>Data storage</b><br>Electronic control units .....                 | 26  |
| Online services .....   | 28  |
| Vehicle .....   | 26  |
| <b>Deactivating the alarm (ATA)</b> .....                             | 81  |
| <b>Dealership</b><br>see Qualified specialist workshop                |     |
| <b>Declaration of conformity</b><br>Wireless vehicle components ..... | 22  |
| <b>Decorative foil (cleaning instructions)</b><br>.....               | 238 |
| <b>Definitions (tires and loading)</b> .....                          | 281 |
| <b>Detecting inattentiveness</b><br>see ATTENTION ASSIST              |     |
| <b>Diagnostics connection</b> .....                                   | 23  |
| <b>Dinghy towing</b><br>see Tow-bar system                            |     |

- DIRECT SELECT lever** ..... 146
- Engaging drive position ..... 148
  - Engaging neutral ..... 147
  - Engaging park position ..... 147
  - Engaging park position automatically .. 147
  - Engaging reverse gear ..... 147
  - Function ..... 146
- Display (Care)** ..... 240
- Display (MBUX multimedia system)**
- Home screen ..... 212
- Display (multimedia system)** ..... 212
- Operating ..... 212
- Display (on-board computer)**
- Displays on the multifunction display .. 210
- Display message** ..... 309
- Calling up (on-board computer) ..... 309
  - Notes ..... 309
- Display messages**
-  --- mph ..... 341
  -  --- mph ..... 339
  -  2nd Seat Row, Left Not Locked ..... 320
  -  2nd Seat Row, Right Not Locked ..... 321
  -  12 V Battery See Operator's Manual ..... 347
  -  Active Headlamps Inoperative .... 316
  -  ATTENTION ASSIST Inoperative ..... 333
  -  ATTENTION ASSIST: Take a Break! ..... 333
  -  Automatic Headlamp Mode Inoperative ..... 315
  -  Before Starting the Engine, Turn Steering Wheel ..... 319
  -  BRAKE Check Brake Fluid Level ..... 332
  -  Check Brake Pads See Operator's Manual ..... 333
  -  Check Coolant Level See Operator's Manual ..... 322
  -  Check Engine Oil Level (Add 1 quart) ..... 354
  -  Check Left Low Beam (example) ..... 315
  -  Check Tires ..... 350
  -  Check Washer Fluid ..... 321
  -  Coolant Too Hot Stop Vehicle Turn Engine Off ..... 322
  -  Currently Unavailable Camera View Restricted ..... 338
  -  Currently Unavailable Radar Sensors Dirty ..... 337
  -  Currently Unavailable See Operator's Manual ..... 342
  -  Currently Unavailable See Operator's Manual ..... 343
  -  Don't Forget Your Key ..... 314
  -  Engine Oil Level Cannot Be Measured ..... 356
  -  Engine Oil Level Low Stop Vehicle Turn Engine Off ..... 355

-  Engine Oil Pressure Stop  
Switch Off Engine ..... 355
-  Engine Oil Reduce Oil Level ..... 354
-  Front Left Malfunction Service  
Required (example) ..... 310
-  Fuel Level Low ..... 323
-  Gas Cap Loose ..... 323
-  Inoperative See Operator's  
Manual ..... 343
-  Inoperative See Operator's  
Manual ..... 344
- EBD** Inoperative See Operator's  
Manual ..... 345
-  Inoperative ..... 346
-  Inoperative ..... 339
-  Intell. Light System Inoperative .. 316
-  Key Not Detected (red display  
message) ..... 314
-  Key Not Detected (white display  
message) ..... 313
-  Left Side Curtain Airbag Mal-  
function Service Required (example) ... 310
-  Malfunction See Operator's  
Manual ..... 315
-  Max. Speed 25 mph ..... 339
-  Not in Curr. Drive Prog. .... 339
-  Obtain a New Key ..... 313
-  Off ..... 340
- HOLD** Off ..... 338
- PARK** Parking Brake See Operator's  
Manual ..... 328
-  Please Correct Tire Pressure ..... 350
- PARK** Please Release Parking Brake ..... 331
-  Replace Key Battery ..... 313
-  See Operator's Manual ..... 347
-  SRS Malfunction Service  
Required ..... 310
-  Steering Malfunction Increased  
Physical Effort See Operator's Man-  
ual ..... 318
-  Steering Malfunction See Oper-  
ator's Manual ..... 318
-  Steering Malfunction Stop  
Immediately See Operator's Manual .... 318
-  Stop Vehicle Leave Engine Run-  
ning ..... 348
-  Stop Vehicle See Operator's  
Manual ..... 348
-  Suspended ..... 340
-  Switch Off Lights ..... 316
-  Switch On Headlamps ..... 316
-  Transmission Oil Overheated  
Drive with Caution ..... 326
- PARK** Turn On the Ignition to Release  
the Parking Brake ..... 332
-  Vehicle Ready to Drive Switch  
the Ignition Off Before Exiting ..... 317
-  Warning Tire Malfunction ..... 351
-  Wheel Sensor(s) Missing ..... 349

- Active Blind Spot Assist Currently Unavailable See Operator's Manual ..... 336
- Active Blind Spot Assist Inoperative .... 336
- Active Brake Assist Functions Currently Limited See Operator's Manual ..... 345
- Active Brake Assist Functions Limited See Operator's Manual ..... 346
- Active Distance Assist Currently Unavailable See Operator's Manual ..... 340
- Active Distance Assist Inoperative ..... 340
- Active Distance Assist Now Available ..... 340
- Active Lane Keeping Assist Currently Unavailable See Operator's Manual ..... 335
- Active Lane Keeping Assist Inoperative ..... 335
- Active Parking Assist and PARKTRONIC Inoperative See Operator's Manual ..... 336
- Active Steering Assist Currently Unavailable See Operator's Manual ..... 334
- Active Steering Assist Inoperative ..... 334
- Active Steering Asst. Currently Unavailable Due to Multiple Emergency Stops ..... 335
- Adaptive Highbeam Assist Currently Unavailable See Operator's Manual ..... 317
- Adaptive Highbeam Assist Inoperative ..... 317
- Apply Brake to Shift from 'P' ..... 324
- Apply Brake to Shift to 'R' ..... 324
- Apply Brake to Shift to D or R ..... 324
- Apply Parking Brake Risk of Rolling Away See Operator's Manual ..... 327
- Auxiliary Battery Malfunction ..... 325
- Beginning Emergency Stop ..... 334
- Blind Spot Assist Currently Unavailable See Operator's Manual ..... 335
- Blind Spot Assist Inoperative ..... 336
- Check Tire Pressure Soon ..... 352
- Check Tire Pressure Then Restart Run Flat Indicator ..... 353
- Cruise Control Inoperative ..... 341
- Cruise Control Off ..... 341
- Decrease Speed ..... 352
- Driver's Door Open & Transmission Not in P Risk of Vehicle Rolling Away ... 324
- Front Passenger Airbag Disabled See Operator's Manual ..... 311
- Front Passenger Airbag Enabled See Operator's Manual ..... 311
- Hazard Warning Flashers Malfunctioning ..... 317
- Mercedes me connect Services Limited See Operator's Manual ..... 346
- N Permanently Active Risk of Rolling Away ..... 325
- Only Shift to 'P' when Vehicle is Stationary ..... 323

- Parking Lock Inoperative Apply Parking Brake ..... 326
- Place the Key in the Marked Space
- See Operator's Manual ..... 314
- PRE-SAFE Inoperative See Operator's Manual ..... 312
- Reversing Not Possible Service Required ..... 325
- Run Flat Indicator Inoperative ..... 353
- Service Required Do Not Shift Gears
- Visit Dealer ..... 325
- Teaching in Transmission Complete .... 327
- Teaching in Transmission Operate Selector Lever Apply Brake for XX s
- Risk of Vehicle Rolling Away ..... 326
- Tire Press. Monitor Currently
- Unavailable ..... 349
- Tire Press. Monitor Inoperative ..... 349
- Tire Pressure Monitor Inoperative No Wheel Sensors ..... 349
- Tires Overheated ..... 351
- To Deselect P or N, Depress Brake and Start Engine ..... 324
- To switch engine off, press and hold Start/Stop button for at least 3 seconds or press 3 times. .... 321
- Transmission Malfunction ..... 326
- Transmission Malfunction Service Required ..... 327
- Transmission Malfunction Stop ..... 325
- Distance control**  
see Active Distance Assist DISTRONIC
- DISTRONIC**  
see Active Distance Assist DISTRONIC
- Door**  
Child safety lock (rear doors) ..... 57  
Locking (emergency key) ..... 66  
Opening (from the inside) ..... 63  
Unlocking (emergency key) ..... 66  
Unlocking (from the inside) ..... 63
- Door control panel** ..... 14
- DOT, Tire Identification Number (TIN)** ... 277
- Downhill driving assistance**  
see DSR
- Drawbar**  
see Tow-bar system
- Drinking and driving** ..... 136
- Drive Away Assist** ..... 198
- Drive Away Assist**  
see Protection against collision
- Drive position**  
Inserting ..... 148
- Drive program display** ..... 144
- Drive programs**  
see DYNAMIC SELECT
- Driver's seat**  
see Seat
- Driving safety system** ..... 161  
ABS (Anti-lock Braking System) ..... 163  
Active Brake Assist ..... 166  
BAS (Brake Assist System) ..... 163  
Cameras ..... 162

- EBD (electronic brake force distribution) ..... 166
  - ESP® Crosswind Assist ..... 166
  - Off-road ABS ..... 163
  - Overview ..... 162
  - Radar and ultrasonic sensors ..... 162
  - Responsibility ..... 161
  - STEER CONTROL ..... 166
  - Driving system**
    - see 360° Camera
    - see Active Blind Spot Assist
    - see Active Distance Assist DISTRONIC
    - see Active Emergency Stop Assist
    - see Active Lane Keeping Assist
    - see Active Parking Assist
    - see Active Speed Limit Assist
    - see Active Steering Assist
    - see ATTENTION ASSIST
    - see Blind Spot Assist
    - see Cruise control
    - see Driving safety system
    - see DSR
    - see HOLD function
    - see Parking Assist PARKTRONIC
    - see Rear view camera
  - see Start-off assist
  - Driving tips**
    - Drinking and driving ..... 136
    - General driving tips ..... 136
    - Notes on breaking-in a new vehicle ..... 136
  - Drowsiness detection**
    - see ATTENTION ASSIST
  - DSR** ..... 173
    - Activating/deactivating ..... 174
    - Changing the target speed ..... 174
    - Function ..... 173
    - Notes ..... 173
  - Dynamic handling control system**
    - see ESP® (Electronic Stability Program)
  - DYNAMIC SELECT** ..... 144
    - Configuring drive program I ..... 145
    - Drive program display ..... 144
    - Drive programs ..... 144
    - Function ..... 144
    - Operating (DYNAMIC SELECT switch) ..... 144
    - Selecting the drive program ..... 144
- E**
- E10** ..... 301
  - Easy entry feature**
    - Function/notes ..... 95
    - Setting ..... 96
  - Easy exit feature**
    - Function/notes ..... 95
    - Setting ..... 96
  - EBD (electronic brake force distribution)**
    - Function/notes ..... 166
  - ECO display**
    - Function ..... 143
  - ECO start/stop function** ..... 142
    - Automatic engine start ..... 142
    - Automatic engine stop ..... 142
    - Method of operation ..... 142
    - Switching off/on ..... 143
  - Electric parking brake** ..... 158
    - Applying automatically ..... 158
    - Applying or releasing manually ..... 159
    - Emergency braking ..... 160
    - Releasing automatically ..... 159

- Electronic Stability Program**  
 see ESP® (Electronic Stability Program)
- Emergency**  
 Fire extinguisher ..... 244  
 First-aid kit (soft sided) ..... 244  
 Overview of the help functions ..... 16  
 Reflective safety vest ..... 243  
 Removing the warning triangle ..... 243  
 Setting up the warning triangle ..... 244
- Emergency braking** ..... 160
- Emergency braking**  
 see BAS (Brake Assist System)
- Emergency call system**  
 see Mercedes-Benz emergency call system
- Emergency engine start** ..... 260
- Emergency key**  
 Locking a door ..... 66  
 Unlocking a door ..... 66
- Emergency operation mode**  
 Starting the vehicle ..... 134
- Emergency spare wheel** ..... 293  
 Inflating ..... 294  
 Notes ..... 293
- Emergency Tensioning Devices**  
 Activation ..... 32
- Engine**  
 ECO start/stop function ..... 142  
 Engine number ..... 298  
 Starting (emergency operation mode) ..... 134  
 Starting (Remote Online) ..... 135  
 Starting (start/stop button) ..... 133  
 Starting assistance ..... 255  
 Switching off (start/stop button) ..... 154
- Engine number** ..... 298
- Engine oil** ..... 233  
 Additives ..... 302  
 Capacity ..... 303  
 Checking the oil level using the on-board computer ..... 232  
 MB-Freigabe or MB-Approval ..... 303  
 Quality ..... 303  
 Topping up ..... 233
- ESC (Electronic Stability Control)**  
 see ESP® (Electronic Stability Program)
- ESP®**  
 Crosswind Assist ..... 166
- ESP® (Electronic Stability Program)** ..... 164  
 Activating/deactivating ..... 165  
 Function/notes ..... 164
- Exterior lighting**  
 see Lights
- Exterior lighting (Care)** ..... 239
- Exterior mirrors** ..... 124, 125  
 Anti-glare mode (automatic) ..... 125  
 Automatic mirror folding function ..... 127  
 Folding in/out ..... 124  
 Operating the memory function ..... 96  
 Parking position ..... 126  
 Setting ..... 124
- F**
- Fatigue detection**  
 see ATTENTION ASSIST
- Fire extinguisher** ..... 244
- First-aid kit (soft sided)** ..... 244
- Flat tire** ..... 245  
 Changing a wheel ..... 288  
 MOExtended tires ..... 246  
 Notes ..... 245

- TIREFIT kit ..... 247
- Flat towing**  
see Tow-bar system
- Floor mats** ..... 112
- Foil covering**  
Radar and ultrasonic sensors ..... 162
- Free software** ..... 29
- Frequencies**  
Mobile phone ..... 297  
Two-way radio ..... 297
- Front airbag (driver, front passenger)** ..... 37
- Front passenger seat**  
see Seat
- Fuel** ..... 302  
Additives ..... 302  
E10 ..... 301  
Fuel reserve ..... 302  
Gasoline ..... 301  
Quality (gasoline) ..... 301  
Refueling ..... 152  
Sulfur content ..... 301  
Tank content ..... 302
- Function seat**  
see Door control panel
- Fuses** ..... 260  
Before replacing a fuse ..... 260  
Fuse assignment diagram ..... 260  
Fuse box in the cargo compartment .... 263  
Fuse box in the engine compartment .. 261  
Fuse box in the front-passenger foot-  
well ..... 262  
Notes ..... 260
- Fuses**  
see Fuses
- G**
- Garage door opener**  
Clearing the memory ..... 158  
Opening or closing the door ..... 157  
Programming buttons ..... 155  
Resolving problems ..... 157  
Synchronizing the rolling code ..... 157
- Gasoline** ..... 301
- Gearshift recommendation** ..... 149
- Genuine parts** ..... 18
- Glide mode** ..... 149
- H**
- Handbrake**  
see Electric parking brake
- Handling characteristics (unusual)** ..... 264
- HANDS-FREE ACCESS** ..... 71
- Hazard warning lights** ..... 116
- Hazardous substances**  
Information ..... 21
- Head restraint**  
Front (adjusting mechanically) ..... 90  
Rear (installing/removing) ..... 92  
Rear passenger compartment  
(adjusting) ..... 91
- Head-up Display**  
Operating the memory function ..... 96
- Headlamps**  
see Automatic driving lights
- Headliner (care)** ..... 240
- High beam**  
Activating/deactivating ..... 115



- High-beam flasher** ..... 115
- High-beam headlamps**  
Adaptive Highbeam Assist ..... 117
- Hill start assist** ..... 182
- HOLD function** ..... 182  
Function/notes ..... 182  
Switching on/off ..... 183
- Home screen (media display)**  
Overview ..... 212
- Hood**  
Opening/closing ..... 230
- I**
- Identification plate**  
Engine ..... 298  
Refrigerant ..... 305  
Vehicle ..... 298
- Ignition**  
Switching on (Start/Stop button) ..... 132
- Ignition key**  
see SmartKey
- Immobilizer** ..... 80
- Indicator lamps**  
see Warning/indicator lamps
- Individual drive program**  
Configuring ..... 145  
Selecting ..... 144
- Inside rearview mirror**  
see Exterior mirrors
- Inspection**  
see ASSYST PLUS
- Instrument cluster**  
Function/notes ..... 207, 208
- Instrument Display**  
Function/notes ..... 208  
Instrument cluster ..... 10  
Warning/indicator lamps ..... 356
- Instrument Display and on-board computer**  
Function/notes ..... 207
- Intelligent Light System**  
Adaptive Highbeam Assist ..... 117  
Cornering light ..... 116
- Interior lighting** ..... 119  
Ambient lighting ..... 119
- Reading light ..... 119  
Setting ..... 119  
Switch-off delay time ..... 120
- Interior motion sensor**  
Activating/deactivating ..... 82  
Function ..... 82
- J**
- Jack**  
Storage location ..... 287
- Jump-start connection** ..... 255  
General notes ..... 253
- K**
- KEYLESS-GO**  
Locking the vehicle ..... 64  
Problem ..... 65  
Unlocking setting ..... 61  
Unlocking the vehicle ..... 64
- Kickdown** ..... 149  
Using ..... 149
- Knee airbag** ..... 37

- L**
- Labeling (tires)**  
see Tire labeling
- Lamp**  
see Interior lighting
- Lamps (Instrument Display)**  
see Warning/indicator lamps
- Lane detection (automatic)**  
see Active Lane Keeping Assist
- Lane Keeping Assist**  
see Active Lane Keeping Assist
- LATCH-type (ISOFIX) child seat securing system**  
Installing ..... 51
- Light switch**  
Overview ..... 114
- Lighting**  
see Interior lighting  
see Lights
- Lights** ..... 114  
Adaptive Highbeam Assist ..... 117  
Automatic driving lights ..... 115  
Combination switch ..... 115  
Cornering light ..... 116  
Hazard warning lights ..... 116  
High beam ..... 115  
High-beam flasher ..... 115  
Light switch ..... 114  
Low-beam headlamps ..... 114  
Parking lights ..... 114  
Rear fog lamp ..... 114  
Responsibility for lighting systems ..... 114  
Setting the exterior lighting switch-off delay time ..... 118  
Standing lights ..... 114  
Switching the surround lighting on/off ..... 118  
Turn signal light ..... 115
- Limited Warranty**  
Vehicle ..... 26
- Limiting the opening angle (tailgate)** ..... 72
- Load index (tires)** ..... 279
- Load-bearing capacity (tires)** ..... 279
- Loading** ..... 104  
Adjustable cargo compartment floor ... 107  
Bag hook ..... 105  
Cargo tie-down rings ..... 104  
Coat hook ..... 105  
Definitions ..... 281  
Notes ..... 98  
Roof luggage rack ..... 108
- Loading guidelines** ..... 98
- Loading information table** ..... 272
- Loads**  
Securing ..... 98
- Locking/unlocking**  
Activating/deactivating the automatic locking feature ..... 65  
Emergency key ..... 66  
KEYLESS-GO ..... 64  
Opening the tailgate ..... 67  
Unlocking and opening doors from the inside ..... 63
- Low-beam headlamps**  
Switching on/off ..... 114
- Lubricant additives**  
see Additives
- Luggage**  
Parcel net ..... 106  
Securing ..... 98

- Lumbar support**  
 see Lumbar support (4-way)
- Lumbar support (4-way)** ..... 88
- M**
- Maintenance**  
 Vehicle ..... 20
- Maintenance**  
 see ASSYST PLUS
- Malfunction**  
 Restraint system ..... 32
- Malfunction message**  
 see Display message
- Massage program**  
 Resetting the settings ..... 92
- Massage programs**  
 Selecting the front seats ..... 92
- Massage settings**  
 Resetting ..... 92
- Matte finish (cleaning instructions)** ..... 238
- Maximum load rating** ..... 278
- Maximum permissible load**  
 Calculation example ..... 274  
 Determining ..... 273
- Maximum tire pressure** ..... 278
- MBUX multimedia system** ..... 211  
 Activating/deactivating standby  
 mode ..... 161  
 Configuring drive program I ..... 145  
 Notes ..... 211  
 Overview ..... 211  
 Standby mode function ..... 161
- Mechanical key**  
 Inserting/removing ..... 62  
 Unlocking the tailgate ..... 72
- Media**  
 Overview of the functions and symbols ..... 225
- Media mode**  
 Connecting Bluetooth® audio equipment ..... 226
- Medical aids** ..... 24
- Memory function**  
 Head-up Display – Calling up stored  
 settings ..... 96  
 Head-up Display – Storing settings ..... 96  
 Operating ..... 96  
 Outside mirrors – Calling up stored  
 settings ..... 96  
 Outside mirrors – Storing settings ..... 96  
 Seat – Calling up stored settings ..... 96  
 Seat – Storing settings ..... 96
- Menu (on-board computer)**  
 Overview ..... 209
- Mercedes-AMG vehicles**  
 Notes ..... 132
- Mercedes-Benz emergency call system** ..... 221  
 Automatic emergency call ..... 222  
 Information ..... 221  
 Information on data transfer ..... 224  
 Manual emergency call ..... 223  
 Overview ..... 222
- Message (multifunction display)**  
 see Display message
- Message memory** ..... 309

**Mirrors**

see Exterior mirrors

**Mobile phone**

Frequencies ..... 297  
Transmission output (maximum) ..... 297  
Wireless charging ..... 112

**Mobile phone**

see Telephone

**Model series**

see Vehicle identification plate

**MOExtended tires** ..... 246

**Multifunction display**

Overview of the displays ..... 210

**Multifunction steering wheel**

Overview of buttons ..... 209

**Multifunction steering wheel**

see Steering wheel

**Multimedia system**

Activating/deactivating DSR ..... 174  
Collision detection (parked vehicle) ..... 160

**Multimedia system**

see Display (multimedia system)  
see MBUX multimedia system

see Touchpad

**N****Neutral**

Inserting ..... 147

**Notes on breaking-in a new vehicle** ..... 136

**O****Occupant safety**

see Airbag  
see Automatic front passenger front  
airbag shutoff  
see Automatic measures after an accident  
see Pets in the vehicle  
see Post-collision brake  
see PRE-SAFE® (anticipatory occu-  
pant protection)  
see PRE-SAFE® PLUS (anticipatory  
occupant protection plus)  
see Restraint system  
see Seat belt

**Off-road driving** ..... 139

**Off-road driving**

see Off-road driving

**Oil**

see Engine oil

**On-board computer** ..... 209

Displaying the service due date ..... 229  
Multifunction display ..... 210  
Operating ..... 209  
Overview of menus ..... 209

**On-board diagnostics interface**

see Diagnostics connection

**Online services**

Data storage ..... 28

**Open-source software** ..... 29

**Opening the tailgate using your foot**

HANDS-FREE ACCESS ..... 71

**Operating fluids**

Additives (fuel) ..... 302  
Brake fluid ..... 303  
Coolant (engine) ..... 303  
Engine oil ..... 302  
Fuel (gasoline) ..... 301  
Notes ..... 299  
Refrigerant (air conditioning system) ... 305  
Windshield washer fluid ..... 304

- Operating safety**
    - Declaration of conformity (wireless vehicle components) ..... 22
    - Information ..... 21
  - Operating system**
    - see On-board computer
  - Operator's Manual**
    - Vehicle equipment ..... 19
  - Overhead control panel**
    - Overview ..... 12
- P**
- Paint code** ..... 298
  - Paintwork (cleaning instructions)** ..... 238
  - Panic alarm** ..... 61
    - Activating/deactivating ..... 61
  - Panorama roof with power tilt/sliding panel**
    - see Sliding sunroof
  - Park position**
    - Inserting ..... 147
    - Selecting automatically ..... 147
  - Parking**
    - see Electric parking brake
  - Parking aid**
    - see Parking Assist PARKTRONIC
  - Parking Assist PARKTRONIC** ..... 184
    - Activating ..... 188
    - Adjusting warning tones ..... 188
    - Function ..... 184
    - Side impact protection ..... 186
    - Switching off ..... 188
    - System limitations ..... 184
  - Parking assistance systems**
    - see Active Parking Assist
  - Parking brake**
    - see Electric parking brake
  - Parking for an extended period** ..... 160
  - Parking lights** ..... 114
  - Parking position**
    - Exterior mirrors ..... 126
    - Storing the position of the front-passenger outside mirror using reverse gear ..... 127
  - PASSENGER AIR BAG status display**
    - see Automatic front passenger front airbag shutoff
  - Payload**
    - Calculation example ..... 274
    - Determining the maximum ..... 273
  - Period out of use**
    - Activating/deactivating standby mode ..... 161
    - Standby mode function ..... 161
  - Permitted towing methods** ..... 256
  - Pets in the vehicle** ..... 59
  - Plastic trim (Care)** ..... 240
  - Post-collision brake** ..... 45
  - Power supply**
    - Switching on (Start/Stop button) ..... 132
  - Power washer (care)** ..... 237
  - Power windows**
    - see Side windows
  - PRE-SAFE® (anticipatory occupant protection)** ..... 44
    - Function ..... 44

|   |     |
|---|-----|
| PRE-SAFE® Sound .....   | 44  |
| Reversing measures .....  | 45  |
| <b>PRE-SAFE® PLUS (anticipatory occupant protection plus)</b> ..... | 45  |
| Function .....  | 45  |
| Reversing measures .....  | 45  |
| <b>Preventative occupant protection system</b>                      |     |
| see PRE-SAFE® (anticipatory occupant protection)                    |     |
| <b>Programs</b>   |     |
| see DYNAMIC SELECT  |     |
| <b>Protecting the environment</b>                                   |     |
| Notes .....   | 18  |
| <b>Protection against collision</b> .....                           | 198 |

## Q

|  |    |
|--|----|
| <b>QR code</b>                             |    |
| Rescue card .....                          | 26 |
| <b>Qualified specialist workshop</b> ..... | 23 |

## R

|   |     |
|---|-----|
| <b>Radar and ultrasonic sensors</b>           |     |
| Damage .....                                  | 162 |
| <b>Radio</b>                                  |     |
| Overview of the functions and symbols .....   | 227 |
| <b>Rain-closing feature</b>                   |     |
| Sliding sunroof .....                         | 79  |
| <b>Reading light</b>                          |     |
| see Interior lighting                         |     |
| <b>Real wood (Care)</b> .....                 | 240 |
| <b>Rear doors (child safety lock)</b> .....   | 57  |
| <b>Rear fog lamp</b>                          |     |
| Switching on/off .....                        | 115 |
| <b>Rear seat</b>                              |     |
| see Seat                                      |     |
| <b>Rear view camera</b> .....                 | 189 |
| Care .....                                    | 239 |
| Function .....                                | 189 |
| Opening the camera cover (360° Camera) .....  | 194 |
| <b>Rear window</b>                            |     |
| Changing the wiper blade .....                | 123 |
| <b>Rear window wipers</b>                     |     |
| Activating/deactivating .....                 | 121 |
| <b>Reflective safety vest</b> .....           | 243 |
| <b>Refrigerant (air conditioning system)</b>  |     |
| Notes .....                                   | 305 |
| <b>Refueling</b>                              |     |
| Refueling the vehicle .....                   | 152 |
| <b>Remote Online</b>                          |     |
| Charging the starter battery .....            | 135 |
| Cooling or heating the vehicle interior ..... | 135 |
| Starting the vehicle .....                    | 135 |
| <b>Reporting safety defects</b> .....         | 25  |
| <b>Rescue card</b> .....                      | 26  |
| <b>Reserve</b>                                |     |
| Fuel .....                                    | 302 |
| <b>Residual heat</b> .....                    | 130 |
| <b>Restraint system</b> .....                 | 31  |
| Basic instructions for children .....         | 46  |
| Function in an accident .....                 | 32  |

- Functionality ..... 31
- Malfunction ..... 32
- Protection ..... 31
- Reduced protection ..... 31
- Self-test ..... 31
- Warning lamp ..... 31
- Reverse gear**
  - Inserting ..... 147
- Rims (Care)** ..... 239
- Roadside Assistance (breakdown)** ..... 20
- Roll away protection**
  - see HOLD function
- Roller sunblind**
  - Panorama roof with power tilt/sliding panel ..... 76
- Rollover crash** ..... 24
- Roof load** ..... 307
- Roof load display**
  - Information ..... 144
- Roof luggage rack**
  - Loading ..... 108
  - Securing ..... 108
- Run-flat characteristics**
  - MOExtended tires ..... 246
- S**
- Safety systems**
  - see Driving safety system
- Seat** ..... 84, 100
  - 4-way lumbar support ..... 88
  - Adjusting (electrically) ..... 87
  - Adjusting (Seat Comfort) ..... 87
  - Adjusting the backrest (rear passenger compartment) ..... 89
  - Adjusting the rear seat (mechanically) .. 88
  - Adjusting the seat backrest angle (rear passenger compartment) ..... 103
  - Adjustment (without Seat Comfort Package) ..... 85
  - Backrest (rear) locking ..... 102
  - Configuring the settings ..... 92
  - Correct driver's seat position ..... 84
  - Folding the backrest (rear passenger compartment) back ..... 102
  - Folding the backrest (rear) forwards .... 100
  - Operating the memory function ..... 96
  - Resetting the settings ..... 92
- Setting options ..... 14
- Seat belt** ..... 33
  - Fastening ..... 35
  - Protection ..... 33
- Seat belt adjustment**
  - Activating/deactivating ..... 37
  - Function ..... 36
- Seat belt warning**
  - see Seat belts
- Seat belts** ..... 37
  - Activating/deactivating seat belt adjustment ..... 37
  - Care ..... 240
  - Reduced protection ..... 34
  - Releasing ..... 36
  - Seat belt adjustment (function) ..... 36
  - Warning lamp ..... 37
- Seat cover (Care)** ..... 240
- Seat heating**
  - Activating/deactivating ..... 93
- Seat ventilation**
  - Activating/deactivating ..... 93

- Selecting a gear**  
see Changing gears
- Selector lever**  
see DIRECT SELECT lever
- Self-test**  
Automatic front passenger front air-bag shutoff ..... 42
- Sensors (Care)** ..... 239
- Service center**  
see Qualified specialist workshop
- Service interval display**  
see ASSYST PLUS
- Setting a speed**  
see Cruise control
- Shift paddles**  
see Steering wheel paddle shifters
- Shifting gears**  
Gearshift recommendation ..... 149
- Side airbag** ..... 37
- Side impact protection** ..... 186
- Side windows** ..... 73  
Child safety lock in the rear  
passenger compartment ..... 59  
Closing ..... 73  
Closing using the SmartKey ..... 75  
Convenience closing feature ..... 75  
Convenience opening ..... 74  
Opening ..... 73  
Opening with the SmartKey ..... 74  
Problem ..... 75
- Size designation (tires)** ..... 279
- Sliding sunroof** ..... 76  
Automatic features ..... 79  
Closing ..... 76  
Closing using the SmartKey ..... 75  
Opening ..... 76  
Opening with the SmartKey ..... 74  
Problem ..... 79  
Rain-closing feature ..... 79
- SmartKey** ..... 60  
Acoustic locking verification signal ..... 61  
Battery ..... 62  
Energy consumption ..... 61  
Features ..... 60  
Key ring attachment ..... 62
- Mechanical key ..... 62  
Overview ..... 60  
Panic alarm ..... 61  
Problem ..... 63  
Unlocking setting ..... 61
- SmartKey functions**  
Deactivating ..... 61
- Smartphone**  
see Telephone
- Snow chains** ..... 265
- Socket (12 V)** ..... 109  
Front center console ..... 109
- Socket (115 V)** ..... 109  
Rear passenger compartment ..... 109
- Software update**  
System updates ..... 215
- Sound**  
PRE-SAFE® Sound ..... 44  
Wheels and tires ..... 264
- Sound menu**  
Functions overview ..... 228
- Spare wheel**  
see Emergency spare wheel



- Special seat belt retractor** ..... 50
- Specialist workshop** ..... 23
- Speed index (tires)** ..... 279
- Sport Utility Vehicle** ..... 24
- Standby mode**
- Activating/deactivating ..... 161
  - Function ..... 161
- Standing lights** ..... 114
- Start-off assist** ..... 184
- Activating ..... 184
  - Function ..... 183
- Start/Stop button**
- Parking the vehicle ..... 154
  - Starting the vehicle ..... 133
  - Switching on the power supply or ignition ..... 132
- Start/stop function**
- see ECO start/stop function
- Starter battery**
- Charging (Remote Online) ..... 135
- Starting assistance**
- see Jump-start connection
- Starting the engine**
- see Vehicle
- Starting-off aid**
- see Hill start assist
- STEER CONTROL**
- Function/notes ..... 166
- Steering wheel** ..... 209
- Adjusting (manually) ..... 94
  - Buttons ..... 209
  - Steering wheel heater ..... 95
- Steering wheel heater**
- Switching on/off ..... 95
- Steering wheel paddle shifters** ..... 148
- Storage areas**
- see Storage compartment
- Storage compartment** ..... 100
- Armrest ..... 100
  - Center console ..... 100
  - Door ..... 100
  - Glove box ..... 100
- Storage compartments**
- see Storage compartment
- Storage spaces**
- USB ports ..... 100
- Stowage areas**
- see Loading
- Stowage compartments**
- see Loading
- Sulfur content** ..... 301
- Surround lighting**
- Switching on/off ..... 118
- Surround View**
- see 360° Camera
- Surround view camera**
- Care ..... 239
- Switch-off delay time**
- Exterior ..... 118
  - Interior ..... 120
- Synchronization function**
- Activating/deactivating (MBUX multimedia system) ..... 129
  - Switching on/off (control panel) ..... 129
- System settings**
- Overview of the system settings menu ..... 214

- T**
- Tailgate** ..... 67  
 Closing ..... 68  
 HANDS-FREE ACCESS ..... 71  
 Limiting the opening angle ..... 72  
 Opening ..... 67  
 Opening dimensions ..... 306  
 Unlocking (mechanical key) ..... 72
- Tailpipes (Care)** ..... 239
- Tank content**  
 Fuel ..... 302  
 Reserve (fuel) ..... 302
- Technical data**  
 Information ..... 296  
 Vehicle identification plate ..... 298
- Telephone** ..... 217, 220  
 Connecting a mobile phone (Pass-key) ..... 221  
 Connecting a mobile phone (Secure Simple Pairing) ..... 221  
 Functions in the telephone menu ..... 221  
 Notes ..... 217  
 Operating modes ..... 220  
 Telephone menu overview ..... 220
- Wireless charging (mobile phone) ..... 112
- Telephony operating modes**  
 Bluetooth® Telephony ..... 220
- Temperature grade** ..... 276
- Through-loading feature**  
 see Seat
- TIN (Tire Identification Number)** ..... 277
- Tire and Loading Information placard** ... 272
- Tire characteristics** ..... 279
- Tire inflation compressor**  
 see TIREFIT kit
- Tire information table** ..... 272
- Tire labeling** ..... 276  
 Characteristics ..... 279  
 DOT, Tire Identification Number (TIN) ..... 277  
 Load index ..... 279  
 Load-bearing capacity ..... 279  
 Maximum tire load ..... 278  
 Maximum tire pressure ..... 278  
 Overview ..... 276  
 Speed rating ..... 279  
 Temperature grade ..... 276
- Tire Quality Grading ..... 276  
 Tire size designation ..... 279  
 Traction grade ..... 276  
 Tread wear grade ..... 276
- Tire load (maximum)** ..... 278
- Tire pressure** ..... 267, 268  
 Checking (manually) ..... 268  
 Checking (tire pressure monitoring system) ..... 270  
 Maximum ..... 278  
 Notes ..... 265  
 Restarting the tire pressure loss warning system ..... 271  
 Restarting the tire pressure monitoring system ..... 270  
 Tire pressure loss warning system (function) ..... 271  
 Tire pressure monitoring system (function) ..... 268  
 Tire pressure table ..... 267  
 TIREFIT kit ..... 247
- Tire pressure loss warning system**  
 Function ..... 271  
 Restarting ..... 271

- Tire pressure monitor**
  - Function ..... 268
  - Restarting ..... 270
- Tire pressure monitoring system**
  - Checking the tire pressure ..... 270
  - Checking the tire temperature ..... 270
- Tire pressure table** ..... 267
- Tire Quality Grading** ..... 276
- Tire temperature**
  - Checking (tire pressure monitoring system) ..... 270
  - Tire pressure monitoring system (function) ..... 268
- Tire tread** ..... 264
- Tire-change tool kit**
  - Overview ..... 287
- TIREFIT kit** ..... 247
  - Storage location ..... 247
  - Using ..... 247
- Tires**
  - Changing hub caps ..... 288
  - Characteristics ..... 279
  - Checking ..... 264
  - Checking the tire pressure (manually) ..... 268
  - Checking the tire pressure (tire pressure monitoring system) ..... 270
  - Definitions ..... 281
  - DOT, Tire Identification Number (TIN) ..... 277
  - Flat tire ..... 245
  - Installing ..... 291
  - Load index ..... 279
  - Load-bearing capacity ..... 279
  - Maximum tire load ..... 278
  - Maximum tire pressure ..... 278
  - MOExtended tires ..... 246
  - Noise ..... 264
  - Notes on installing ..... 284
  - Overview of tire labeling ..... 276
  - Removing ..... 290
  - Replacing ..... 284, 288
  - Restarting the tire pressure loss warning system ..... 271
  - Restarting the tire pressure monitoring system ..... 270
  - Rotating ..... 287
  - Selection ..... 284
  - Snow chains ..... 265
  - Speed rating ..... 279
  - Storing ..... 287
  - Temperature grade ..... 276
  - Tire and Loading Information placard .. 272
  - Tire pressure (notes) ..... 265
  - Tire pressure loss warning system (function) ..... 271
  - Tire pressure monitoring system (function) ..... 268
  - Tire pressure table ..... 267
  - Tire Quality Grading ..... 276
  - Tire size designation ..... 279
  - TIREFIT kit ..... 247
  - Traction grade ..... 276
  - Tread wear grade ..... 276
  - Unusual handling characteristics ..... 264
- Tool**
  - see Vehicle tool kit
- Top Tether** ..... 53
- Touch Control**
  - On-board computer ..... 209
  - Operating ..... 212
- Touchpad** ..... 212
  - Operating ..... 212

- Touchscreen (media display)**  
Operating ..... 212
- Tow-away alarm**  
Activating/deactivating ..... 82  
Function ..... 81
- Tow-bar system** ..... 205
- Tow-starting** ..... 260
- Towing away** ..... 257
- Towing eye**  
Installing ..... 260  
Storage location ..... 260
- Towing methods** ..... 256
- Traction grade** ..... 276
- Transmission (problem)** ..... 151
- Transmission position display** ..... 146
- Transporting**  
Vehicle ..... 258
- Tread wear grade** ..... 276
- Trim element (Care)** ..... 240
- Trunk lid**  
see Tailgate
- Turn signal indicator** ..... 115
- Turn signal light**  
Activating/deactivating ..... 115
- Two-way radios**  
Frequencies ..... 297  
Notes on installation ..... 296  
Transmission output (maximum) ..... 297
- U**
- Unlocking setting** ..... 61
- Updates**  
Important system updates ..... 215
- USB port**  
Rear passenger compartment ..... 110
- V**
- Vehicle** ..... 134  
Activating/deactivating standby  
mode ..... 161  
Collision detection (parking) ..... 160  
Correct use ..... 24  
Data acquisition ..... 26  
Data storage ..... 26  
Diagnostics connection ..... 23
- Equipment ..... 19  
Limited Warranty ..... 26  
Locking (automatically) ..... 65  
Locking (from inside) ..... 64  
Locking (KEYLESS-GO) ..... 64  
Locking/unlocking (emergency key) ..... 66  
Lowering ..... 292  
Maintenance ..... 20  
Medical aids ..... 24  
Parking for an extended period ..... 160  
Problem notification ..... 24  
QR code rescue card ..... 26  
Qualified specialist workshop ..... 23  
Raising ..... 288  
Standby mode function ..... 161  
Starting (emergency operation  
mode) ..... 134  
Starting (Remote Online) ..... 135  
Starting (start/stop button) ..... 133  
Switching off (start/stop button) ..... 154  
Towing ..... 205  
Unlocking (from inside) ..... 64  
Unlocking (KEYLESS-GO) ..... 64  
Ventilating (convenience opening) ..... 74

**Vehicle data**

|  |     |
|--|-----|
| Angle of approach/departure .....          | 307 |
| Maximum gradient-climbing capability ..... | 307 |
| Roof load .....                            | 307 |
| Turning radius .....                       | 306 |
| Vehicle height .....                       | 306 |
| Vehicle length .....                       | 306 |
| Vehicle width .....                        | 306 |
| Wheelbase .....                            | 306 |

**Vehicle data storage**

|  |    |
|--|----|
| Event data recorders .....                       | 28 |
| MBUX multimedia system/Mercedes me connect ..... | 28 |

**Vehicle dimensions** ..... 306**Vehicle electronics**

|                      |     |
|----------------------|-----|
| Notes .....          | 296 |
| Two-way radios ..... | 296 |

**Vehicle identification number**

see VIN

**Vehicle identification plate** ..... 298

|                  |     |
|------------------|-----|
| Paint code ..... | 298 |
| VIN .....        | 298 |

**Vehicle interior**

|  |     |
|--|-----|
| Cooling or heating (Remote Online) ..... | 135 |
|--|-----|

**Vehicle key**

see SmartKey

**Vehicle maintenance**

see ASSYST PLUS

**Vehicle operation**

|                                 |    |
|---------------------------------|----|
| Outside the USA or Canada ..... | 20 |
|---------------------------------|----|

**Vehicle tool kit** ..... 247

|                   |     |
|-------------------|-----|
| TIREFIT kit ..... | 247 |
| Towing eye .....  | 260 |

**Vehicle with a high center of gravity** ..... 24**Ventilating**

|                           |    |
|---------------------------|----|
| Convenience opening ..... | 74 |
|---------------------------|----|

**Vents**

see Air vents

**VIN** ..... 298

|                            |     |
|----------------------------|-----|
| Engine compartment .....   | 298 |
| Identification plate ..... | 298 |
| Windshield .....           | 298 |

**Vision**

|  |     |
|--|-----|
| Removing condensation from the windows ..... | 130 |
|--|-----|

**W****Warning lamps**

see Warning/indicator lamps







**Warning system**















see ATA (anti-theft alarm system)

**Warning triangle**

|                  |     |
|------------------|-----|
| Removing .....   | 243 |
| Setting up ..... | 244 |

**Warning/indicator lamp**

|   |     |
|---|-----|
|  ABS warning lamp .....  | 365 |
|  Brake system warning lamp (Canada only) .....                     | 364 |
|  BRAKE Brake warning lamp (USA only) ..                            | 364 |
|  Coolant warning lamp .....  | 359 |
|  Electric parking brake indicator lamp (red) (Canada only) .....   | 363 |
|  PARK Electric parking brake indicator lamp (red) (USA only) ..... | 363 |
|  Electric power steering warning lamp (red) .....                  | 359 |

-  Electrical malfunction warning lamp ..... 361
-  Engine diagnosis warning lamp ... 361
-  ESP® OFF warning lamp ..... 367
-  ESP® warning lamp flashes ..... 366
-  ESP® warning lamp lights up ..... 366
-  Fuel reserve warning lamp flashes ..... 361
-  Fuel reserve warning lamp lights up ..... 362
-  Restraint system warning lamp .. 357
-  Seat belt warning lamp flashes .. 358
-  Seat belt warning lamp lights up ..... 358
-  The electric parking brake (yellow) indicator lamp ..... 363
-  Tire pressure monitoring system warning lamp flashes ..... 368
-  Tire pressure monitoring system warning lamp lights up ..... 368
-  Warning lamp for distance warning function ..... 365
- Warning/indicator lamps** ..... 356
  - Overview ..... 356
  - PASSENGER AIR BAG ..... 42
- Warranty** ..... 26
- Washer fluid**  
see Windshield washer fluid
- Washing by hand (care)** ..... 238
- Water tank**  
see Air-water duct
- Wheel change**
  - Lowering the vehicle ..... 292
  - Mounting a new wheel ..... 291
  - Removing a wheel ..... 290
  - Removing/installing hub caps ..... 288
- Wheel rotation** ..... 287
- Wheels**
  - Care ..... 239
  - Changing hub caps ..... 288
  - Checking ..... 264
  - Checking the tire pressure (manually) ..... 268
  - Checking the tire pressure (tire pressure monitoring system) ..... 270
  - Definitions ..... 281
  - DOT, Tire Identification Number (TIN) ..... 277
  - Flat tire ..... 245
  - Installing ..... 291
  - Load index ..... 279
  - Load-bearing capacity ..... 279
  - Maximum tire load ..... 278
  - Maximum tire pressure ..... 278
  - MOExtended tires ..... 246
  - Noise ..... 264
  - Notes on installing ..... 284
  - Overview of tire labeling ..... 276
  - Removing ..... 290
  - Replacing ..... 284, 288
  - Restarting the tire pressure loss warning system ..... 271
  - Restarting the tire pressure monitoring system ..... 270
  - Rotating ..... 287
  - Selection ..... 284
  - Snow chains ..... 265
  - Speed rating ..... 279
  - Storing ..... 287

- Temperature grade ..... 276
- Tire and Loading Information placard .. 272
- Tire characteristics ..... 279
- Tire pressure (notes) ..... 265
- Tire pressure loss warning system  
(function) ..... 271
- Tire pressure monitoring system  
(function) ..... 268
- Tire pressure table ..... 267
- Tire Quality Grading ..... 276
- Tire size designation ..... 279
- TIREFIT kit ..... 247
- Traction grade ..... 276
- Tread wear grade ..... 276
- Unusual handling characteristics ..... 264
- Wi-Fi**
  - Setting ..... 215
- Window curtain airbag** ..... 37
- Windows**
  - see Side windows
- Windows (Care)** ..... 239
- Windshield** ..... 121
  - Replacing the wiper blades ..... 121
- Windshield**
  - see Windshield
- Windshield washer fluid** ..... 304
  - Notes ..... 304
- Windshield washer system**
  - Topping up ..... 234
- Windshield wipers**
  - Activating/deactivating ..... 120
  - Replacing the wiper blades ..... 121
- Winter operation**
  - Snow chains ..... 265
- Wiper blades**
  - Care ..... 239
  - Replacing ..... 121
- Wireless charging**
  - Function/notes ..... 110
  - Mobile phone ..... 112
- Wireless vehicle components**
  - Declaration of conformity ..... 22
- Workshop**
  - see Qualified specialist workshop

