



Digital – in the vehicle

Familiarize yourself with the contents of the Operator's Manual directly via the vehicle's multimedia system (menu item "Vehicle information"). Start with the quick guide or broaden your knowledge with practical tips.



Vehicle document wallet

Here you can find comprehensive information about operating your vehicle and about services and guarantees in printed form.



Digital – on the Internet

You can find the Operator's Manual on the Mercedes-Benz homepage.



Digital – as an app

The Mercedes-Benz Guides app is available free-of-charge in familiar app stores.



2575841703

Order no. P257 0218 13 Part no. 257 584 17 03
Edition B-2021



Apple® iOS



Android™

CLS



CLS

Operator's Manual

Mercedes-Benz



Mercedes-Benz

Front passenger airbag warning

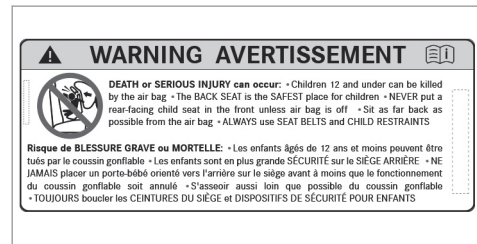
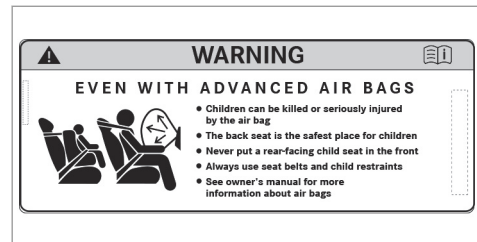

Airbag warning sticker for USA and Canada

⚠ WARNING Risk of injury or death if the co-driver airbag is enabled

If the co-driver airbag is enabled, a child on the co-driver seat may be struck by the co-driver airbag during an accident.

NEVER use a rearward-facing child restraint system on a seat with an ENABLED FRONT AIRBAG; DEATH or SERIOUS INJURY to the CHILD can occur.

Observe the chapter "Children in the vehicle".

Publication details

Internet

Further information about Mercedes-Benz vehicles and about Mercedes-Benz AG can be found on the following websites:

<https://www.mbusa.com> (USA only)

<https://www.mercedes-benz.ca> (Canada only)

Documentation team

©Mercedes-Benz AG: Not to be reprinted, translated or otherwise reproduced, in whole or in part, without written permission from Mercedes-Benz AG.

Vehicle manufacturer

Mercedes-Benz AG

Mercedesstraße 120

70372 Stuttgart

Germany

Thank you for purchasing a Mercedes-Benz

Before you first drive off, read this Operator's Manual carefully and familiarize yourself with your vehicle. For your own safety and a longer operating lifespan of the vehicle, follow the instructions and warning notices in this Operator's Manual. Disregarding them may lead to damage to the vehicle or injury to people.

Damage to the vehicle resulting from the disregard of the instructions is not covered by the Mercedes-Benz Limited Warranty.

The standard equipment and product description of your vehicle may vary and depends on the following factors:

- Model
- Order
- National version
- Availability

Mercedes-Benz reserves the right to introduce changes in the following areas:

- Design
- Equipment

- Technical features

The equipment in your vehicle may therefore differ from that shown in the descriptions and illustrations.

The following documents are integral parts of the vehicle:

- Digital Operator's Manual
- Printed Operator's Manual
- Maintenance Booklet
- Equipment-dependent Supplements

Keep these documents in the vehicle at all times. If you sell the vehicle, always pass all of the documents on to the new owner.

Mercedes-Benz USA, LLC
Mercedes-Benz Canada, Inc.
A Daimler Company

2575841703



Symbols	5	Notes for persons with electronic medical aids	27	Roller sun blinds	82
At a glance	6	Problems with your vehicle	28	Anti-theft protection	83
Cockpit	6	Reporting safety defects	28	Seats and stowing	87
Indicator and warning lamps	10	Limited Warranty	29	Notes on the correct driver's seat position	87
Overhead control panel	12	QR code for rescue card	29	Seats	88
Door control panel and seat adjustment	14	Data storage	29	Steering wheel	96
Emergencies and breakdowns	16	Copyright	34	Easy entry and exit feature	98
Digital Operator's Manual	18	Occupant safety	35	Memory function	99
Calling up the Digital Operator's Manual	18	Restraint system	35	Stowage areas	100
General notes	20	Seat belts	37	Sockets	108
Protecting the environment	20	Airbags	41	Wireless charging of the mobile phone and connection with the exterior antenna ...	110
Genuine Mercedes-Benz parts	20	PRE-SAFE® system	49	Installing/removing the floor mats	112
Operator's Manual	21	Safely transporting children in the vehicle	50	Light and visibility	114
Service and vehicle operation	22	Notes on pets in the vehicle	63	Exterior lighting	114
Operating safety	23	Opening and closing	64	Interior lighting	119
Declaration of conformity for wireless vehicle components	25	SmartKey	64	Windshield wiper and windshield washer system	120
Diagnostics connection	25	Doors	68	Mirrors	123
Qualified specialist workshop	27	Trunk	71	Area permeable to radio waves on the windshield	126
Correct use of the vehicle	27	Side windows	77		
		Sliding sunroof	80		

Infrared-reflective windshield function	126	Operating the on-board computer	217	Battery (vehicle)	283
Climate control	127	Overview of displays on the multifunc-		Tow starting or towing away	288
Overview of climate control systems	127	tion display	219	Electrical fuses	293
Operating the climate control system	128	Head-up Display	219		
Driving and parking	133	MBUX multimedia system	222	Wheels and tires	296
Driving	133	Overview and operation	222	Notes on noise or unusual handling char-	
DYNAMIC SELECT switch	145	System settings	230	acteristics	296
Automatic transmission	147	Navigation	234	Notes on regularly inspecting wheels and	
Function of the 4MATIC	151	Telephone	240	tires	296
Refueling	152	Mercedes me and apps	243	Notes on snow chains	297
Parking	154	Mercedes-Benz emergency call system	251	Tire pressure	297
Driving and driving safety systems	161	Radio & media	255	Loading the vehicle	304
Vehicle towing instructions	214	Sound settings	262	Tire labeling	308
				Definition of terms for tires and loading	313
Instrument Display and on-board		Maintenance and care	263	Changing a wheel	316
computer	215	ASSYST PLUS service interval display	263	Emergency spare wheel	325
Notes on the Instrument Display and on-		Engine compartment	264		
board computer	215	Cleaning and care	269	Technical data	327
Instrument Display overview	216			Notes on technical data	327
Overview of the buttons on the steering		Breakdown assistance	276	Vehicle electronics	327
wheel	217	Emergency	276	Radio operating permits for vehicle com-	
		Flat tire	277	ponents	329
				Vehicle identification plate, VIN and	
				engine number overview	329

4 Contents

Operating fluids	331
Vehicle data	337

Display messages and warning/indicator lamps	340
Display messages	340
Warning and indicator lamps	387

Index	401
--------------------	------------

In this Operator's Manual, you will find the following symbols:

⚠ DANGER Danger due to not observing the warning notices

Warning notices draw your attention to hazards that may endanger your health or life, or the health or life of others.

▶ Observe the warning notices.

🌿 ENVIRONMENTAL NOTE Environmental damage due to failure to observe environmental notes

Environmental notes include information on environmentally responsible behavior or environmentally responsible disposal.

▶ Observe environmental notes.

! NOTE Damage to property due to failure to observe notes on material damage

Notes on material damage inform you of risks which may lead to your vehicle being damaged.

▶ Observe notes on material damage.

i These symbols indicate useful instructions or further information that could be helpful to you.

▶ Instruction

(→ page) Further information on a topic

Display Information on the multifunction display/media display







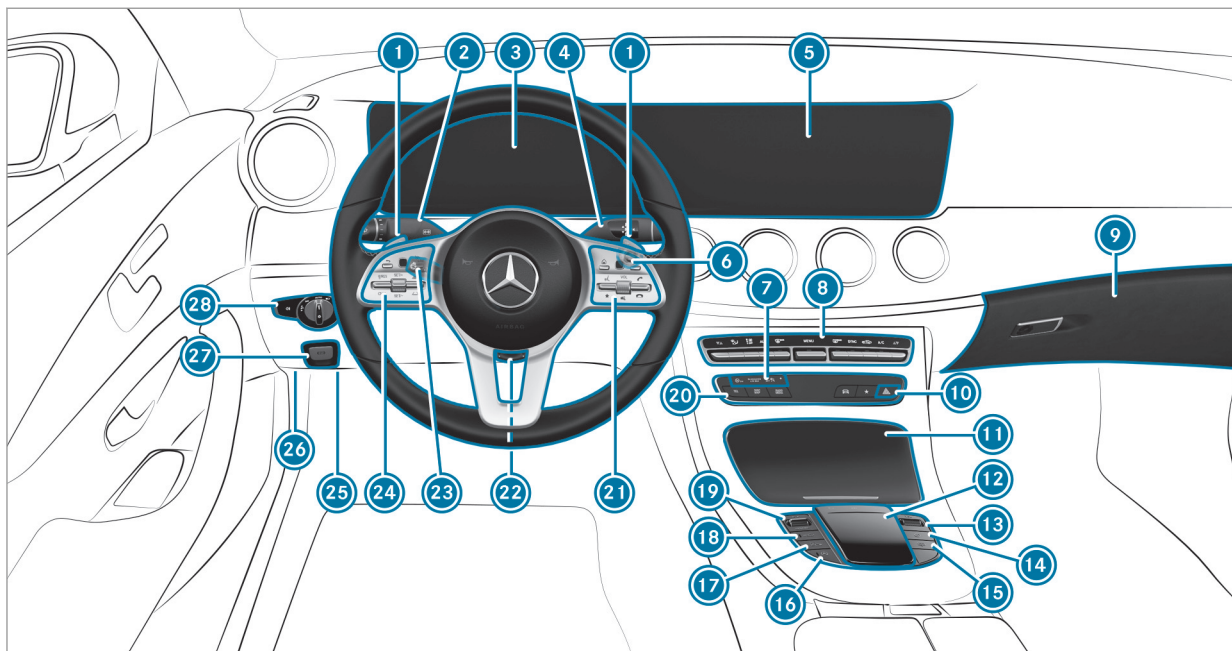

↗▶ Highest menu level, which is to be selected in the multimedia system

▶▶ Relevant submenus, which are to be selected in the multimedia system

* Indicates a cause



Left-hand-drive vehicles

1	Steering wheel gearshift paddles	→	149	16	 ECO start/stop function	→	142
2	Combination switch	→	115	17	 Active Parking Assist	→	210
3	Instrument Display	→	216	18	 Sets the vehicle level	→	197
4	DIRECT SELECT lever	→	147	19	DYNAMIC SELECT switch	→	146
5	Media display	→	222	20	Calls up MBUX multimedia system applications	→	224
6	Start/stop button	→	134	21	Control panel for the MBUX multimedia system	→	217
7	PASSENGER AIR BAG indicator lamps	→	46	22	Adjusts the steering wheel mechanically	→	96
8	Climate control systems	→	128	23	Adjusts the steering wheel electrically	→	97
9	Glove box	→	103		 Switches the steering wheel heater on/off	→	97
10	 Hazard warning light system	→	116	24	Control panel:		
11	Storage compartment	→	103		On-board computer	→	217
12	Touchpad	→	224		Cruise control	→	170
13	 Controller for volume and switching sound on/off	→	222		 Active Distance Assist DISTRONIC	→	173
14	 Switches the MBUX multimedia system on/off	→	222	25	Diagnostics connection	→	25
15	 Rear-window roller sunblind	→	82	26	Opens the hood	→	264

8 At a glance – Cockpit

27  Electric parking brake



158

28 Light switch









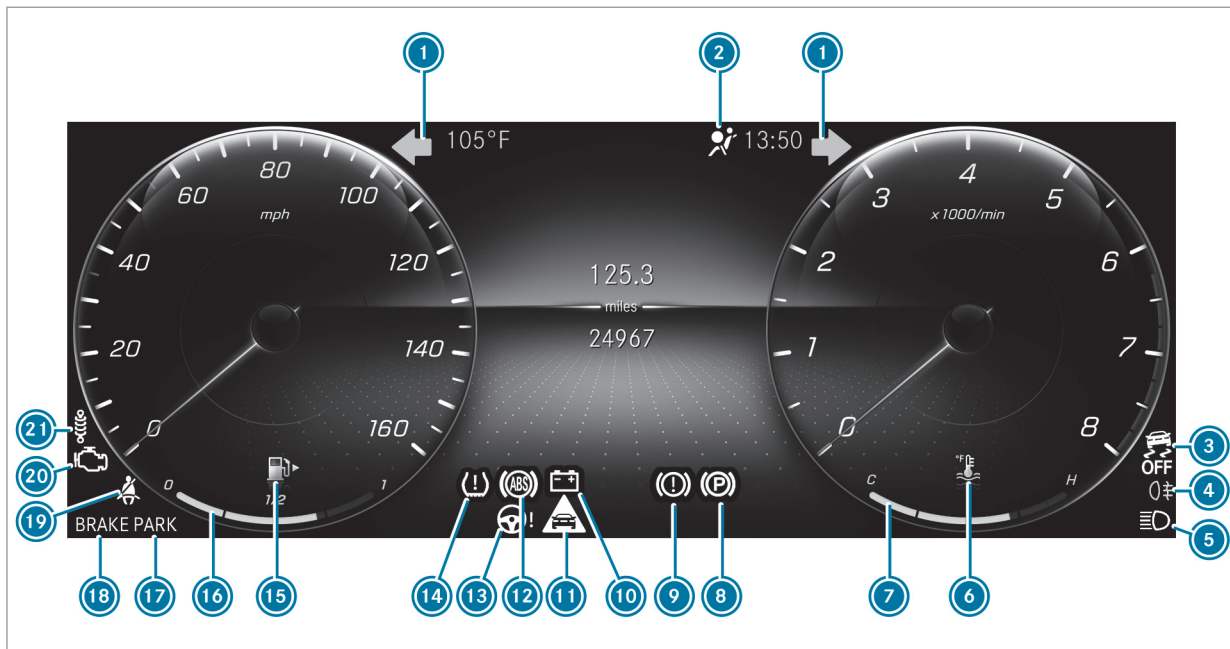

















114



10 At a glance – Indicator and warning lamps









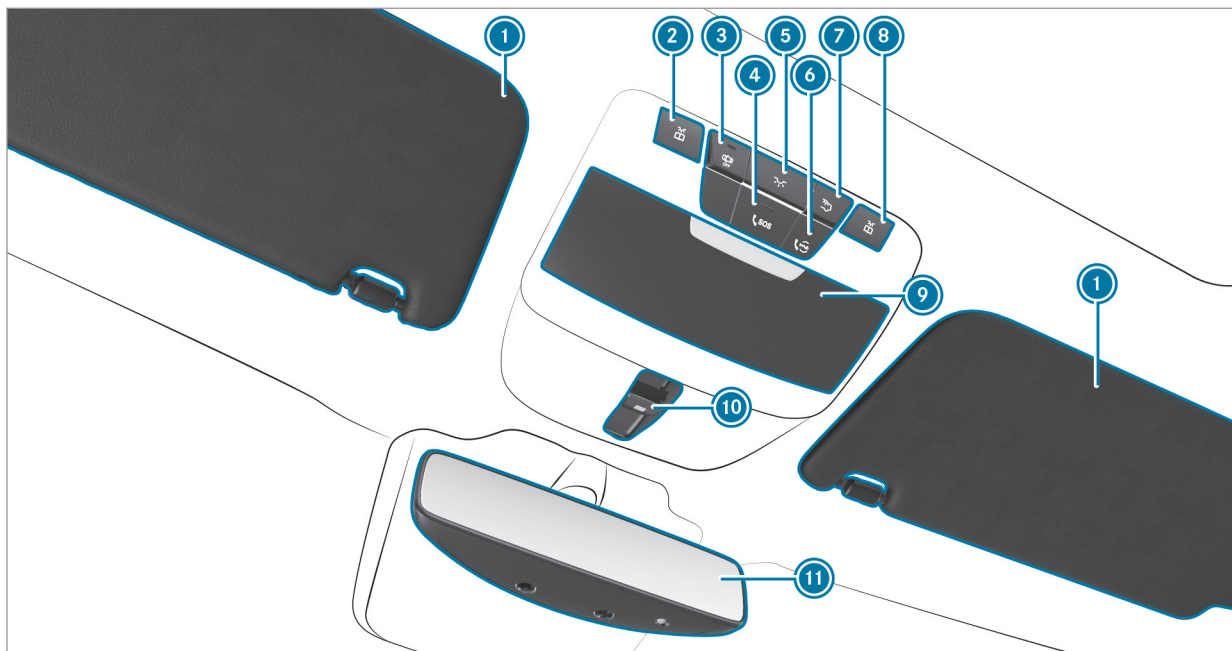

Instrument Display

1		Turn signal lights	→	115	12		ABS	→	397
2		Restraint system	→	388	13		Electric power steering	→	389
3		ESP® OFF	→	397	14		Tire pressure monitoring system	→	399
		ESP®	→	397	15		Reserve fuel with fuel filler flap location indicator	→	390
4		Rear fog lamp	→	115	16		Fuel level	→	216
5		High beam	→	115	17		Electric parking brake (red)	→	393
		Low beam	→	114			USA only		
		Parking lamps	→	114			Canada only		
6		Coolant temperature	→	390	18		Brakes (red)	→	393
7		Coolant temperature display	→	216			USA only		
8		Electric parking brake (yellow)	→	393			Canada only		
9		Recuperative Brake System, USA only	→	393	19		Seat belt	→	388
		Brakes (yellow), Canada only	→	393	20		Check Engine	→	390
10		Electrical malfunction	→	390	21		Suspension	→	396
11		Distance warning	→	396					









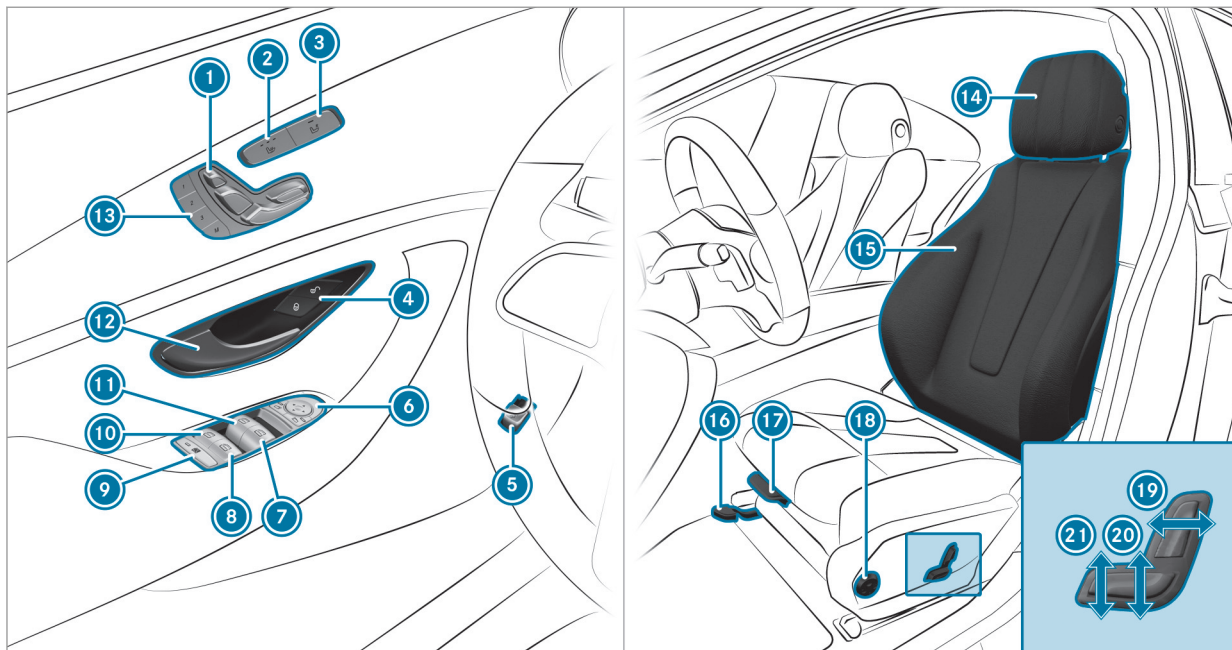

12 At a glance – Overhead control panel





①	Sun visors		
②	 Switches the left-hand reading lamp on/off	→	119
③	 Switches the automatic interior lighting control on/off	→	119
④	 SOS button	→	245
⑤	 Switches the front interior lighting on/off	→	119
⑥	 me button	→	245
⑦	 Switches the rear interior lighting on/off	→	119
⑧	 Switches the right-hand reading lamp on/off	→	119
⑨	Eyeglasses compartment		
⑩	 Opens/closes the sliding sunroof	→	80
⑪	Inside rearview mirror	→	124

14 At a glance – Door control panel and seat adjustment

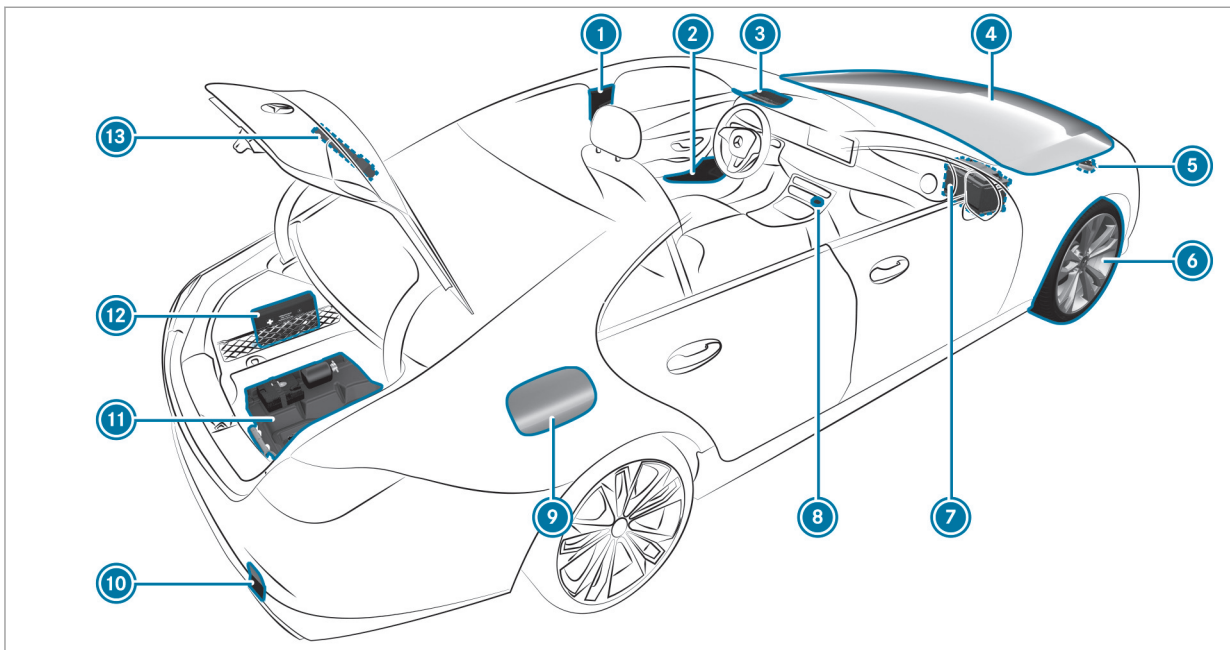

①	Adjusts the seats electrically	→	90	⑪	 Opens/closes the left side window	→	77
②	 Switches the seat heating on/off	→	94	⑫	Opens the door	→	68
③	 Switches the seat ventilation on/off	→	95	⑬	Operates the memory function	→	100
④	  Locks/unlocks the vehicle	→	68	⑭	Adjusts the head restraints	→	90
⑤	 Opens/closes the trunk lid	→	71	⑮	Configures the seat settings	→	92
⑥	 Operates the outside mirrors	→	123	⑯	Sets the seat fore-and-aft position	→	88
⑦	 Opens/closes the right side window	→	77	⑰	Adjusts the seat cushion length	→	88
⑧	 Opens/closes the rear right side window	→	77	⑱	Adjusts the 4-way lumbar support	→	88
⑨	Child safety lock for the rear passenger compartment side windows	→	63	⑲	Adjusts the seat backrest inclination	→	88
⑩	 Opens/closes the rear left side window	→	77	⑳	Adjusts the seat height	→	88
				㉑	Adjusts the seat cushion inclination	→	88



① B-pillar with:		
QR code for accessing the rescue card	→	29
② Safety vests	→	276
③  me button	→	245
 SOS button	→	245
④ Checking and refilling operating fluids	→	331
⑤ Tow-starting or towing away	→	288
⑥ Flat tire	→	277
⑦ Starting assistance	→	287

⑧  Hazard warning light system	→	116
⑨ Fuel filler flap with:		
information label on fuel type	→	152
Information label on tire pressure	→	299
QR code for accessing the rescue card	→	29
⑩ Tow-starting or towing away	→	288
⑪ TIREFIT kit	→	279
⑫ First-aid kit	→	277
⑬ Warning triangle	→	276

Calling up the Digital Operator's Manual

Multimedia system:

→  » Info » Operator's Manual
» 



The Digital Operator's Manual describes the functions and operation of the vehicle and the multimedia system.

► Select one of the following menu items in the Digital Operator's Manual:

- **Search:** search for keywords in order to find quick answers to questions about the operation of the vehicle.

- **Quick start:** here is where you find the first steps towards setting up your vehicle.
- **Tips:** find information that prepares you for certain everyday situations with your vehicle.
- **Animations:** watch animations of the vehicle functions.
- **Messages:** receive additional information about the messages in the Instrument Display.
- **Bookmarks:** gain access to your personally saved bookmarks.
- **Language:** select the language for the Digital Operator's Manual.

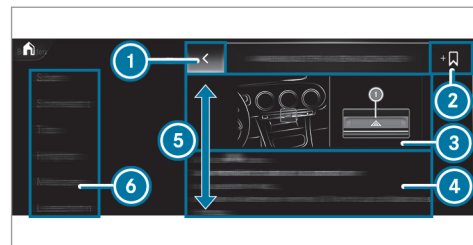

- 1 Back
- 2 Adds bookmarks
- 3 Picture
- 4 Contents section
- 5 Directions of movement of contents section
- 6 Menu

Some sections in the Digital Operator's Manual, e.g. warning notes, can be expanded and collapsed.

Additional methods of calling up the Digital Operator's Manual:

Direct access: open the required content in the Digital Operator's Manual by pressing and hold-

ing an entry on the tab bar in the multimedia system:

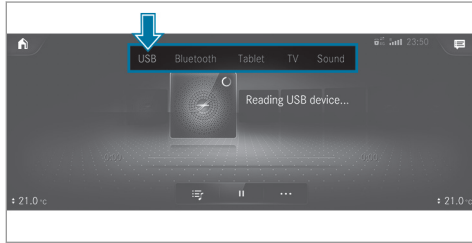

Instrument Display: call up brief information as display messages in the instrument cluster

Voice Control System: call up via the voice control system

For safety reasons, the Digital Operator's Manual is deactivated while driving.

Protecting the environment

 **ENVIRONMENTAL NOTE** Environmental damage due to operating conditions and personal driving style

The pollutant emission of the vehicle is directly related to the way you operate the vehicle.

Operate your vehicle in an environmentally responsible manner to help protect the environment. Please observe the following recommendations on operating conditions and personal driving style.

Operating conditions:

- ▶ Make sure that the tire pressure is correct.
- ▶ Do not carry any unnecessary weight (e.g. roof luggage racks once you no longer need them).
- ▶ Adhere to the service intervals. A regularly serviced vehicle will contribute to environmental protection.

- ▶ Always have maintenance work carried out at a qualified specialist workshop.

Personal driving style:

- ▶ Do not depress the accelerator pedal when starting the engine.
- ▶ Do not warm up the engine while the vehicle is stationary.
- ▶ Drive carefully and maintain a suitable distance from the vehicle in front.
- ▶ Avoid frequent, sudden acceleration and braking.
- ▶ Change gear in good time and use each gear only up to $\frac{2}{3}$ of its maximum engine speed.
- ▶ Switch off the engine in stationary traffic, e.g. by using the ECO start/stop function.
- ▶ Drive fuel-efficiently. Observe the ECO display for a fuel-efficient driving style.

Environmental issues and recommendations

It is recommended that you re-use or recycle materials instead of just disposing of them.

The relevant environmental guidelines and regulations serve to protect the environment and must be strictly observed.

Genuine Mercedes-Benz parts

 **ENVIRONMENTAL NOTE** Environmental damage due to not using recycled reconditioned components

Mercedes-Benz AG offers recycled reconditioned components and parts with the same quality as new parts. The same entitlement from the Limited Warranty is valid as for new parts.

- ▶ Use recycled reconditioned components and parts from Mercedes-Benz AG.

! **NOTE** Impairment of the operating efficiency of the restraint systems from installing accessory parts or from repairs or welding

Airbags and Emergency Tensioning Devices, as well as control units and sensors for the restraint systems, may be installed in the following areas of your vehicle:

- Doors
- Door pillars
- Door sills
- Seats
- Cockpit
- Instrument cluster
- Center console
- Lateral roof frame

▶ Do not install accessory parts such as audio systems in these areas.

▶ Do not carry out repairs or welding.

▶ Have aftermarket installation of accessories carried out at a qualified specialist workshop.

You could jeopardize the operating safety of your vehicle if you use parts, tires and wheels as well as accessories relevant to safety which have not been approved by Mercedes-Benz. Safety-relevant systems, e.g. the brake system, may malfunction. Only use Mercedes-Benz GenuineParts or parts of equal quality. Only use tires, wheels and accessories that have been specifically approved for your vehicle model.

Mercedes-Benz GenuineParts are subject to strict quality inspections. Each part has been specially developed, manufactured or selected for Mercedes-Benz vehicles and adapted to them. Therefore, only Mercedes-Benz GenuineParts should be used.

More than 300,000 different Mercedes-Benz GenuineParts are available for Mercedes-Benz models.

All authorized Mercedes-Benz Centers maintain a supply of Mercedes-Benz GenuineParts for

necessary service and repair work. In addition, strategically located parts delivery centers provide for quick and reliable parts service.

Always specify the vehicle identification number (VIN) (→ page 329) when ordering Mercedes-Benz GenuineParts.

Operator's Manual

This Operator's Manual describes all models and all standard and optional equipment available for your vehicle at the time of this Operator's Manual going to press. Country-specific differences are possible. Note that your vehicle may not be equipped with all features described. This is also the case for systems and functions relevant to safety. Therefore, the equipment on your vehicle may differ from that in the descriptions and illustrations.

The original purchase agreement for your vehicle contains a list of all of the systems in your vehicle.

Should you have any questions concerning equipment and operation, please consult an authorized Mercedes-Benz Center.

22 General notes

The Operator's Manual and Maintenance Booklet are important documents and should be kept in the vehicle.

Service and vehicle operation

Vehicle operation outside the USA or Canada

When you are abroad with your vehicle, observe the following points:

- Service points or replacement parts may not be available immediately.
- Unleaded fuel may not be available for vehicles with a catalytic converter. Leaded fuel may cause damage to the catalytic converter.
- The fuel may have an extremely low octane number. Unsuitable fuel can cause engine damage.

Some Mercedes-Benz models are available in Europe through our European Delivery Program. For more information, please consult an authorized Mercedes-Benz service center, or write to one of the following address:

In the USA:

Mercedes-Benz USA, LLC
European Delivery Department
One Mercedes-Benz Drive
Sandy Springs, GA 30328

In Canada:

Mercedes-Benz Canada, Inc.
European Delivery Department
98 Vanderhoof Avenue
Toronto, Ontario M4G 4C9

Maintenance

Your customer advisor confirms the service in the service report.

Roadside Assistance

The Mercedes-Benz Roadside Assistance Program offers technical help in the case of a breakdown. Your calls to the toll-free Roadside Assistance Hotline are answered by our agents 24 hours a day, 365 days a year.

1-800-FOR-MERCEdes (1-800-367-6372) (USA)

1-800-387-0100 (Canada)

You can find further information in the Mercedes-Benz Roadside Assistance Program brochure (USA) or the "Roadside Assistance" section in the Service and Warranty booklet (Canada). You will find both in the vehicle document wallet.

Change of address or change of ownership

In the event of a change of address, please send us the "Notification of address change" in the Service and Guarantee booklet or simply call the Mercedes-Benz Customer Assistance Center (USA) on the hotline number 1-800-FOR-MERCEdes (1-800-367-6372) or Customer Service (Canada) on 1-800-387-0100. We can then reach you in a timely fashion, if necessary.

If you sell your Mercedes, please leave all literature in the vehicle so that it is available to the next owner. If you have purchased a used vehicle, please send us the "Notice of Purchase of Used Car" in the Service and Guarantee booklet or simply call the Mercedes-Benz Customer

Assistance Center (USA) at the hotline number 1-800-FOR-MERCEdes (1-800-367-6372) or Customer Service (Canada) at 1-800-387-0100.

Possible danger due to substances hazardous to health

In compliance with Proposition 65 ("Prop65"), the following detachable label has been added to each vehicle sold in California:



WARNING



Operating, servicing and maintaining a passenger vehicle, pickup truck, van or off-road motor vehicle can expose you to chemicals including engine exhaust, carbon monoxide, phthalates, and lead, which are known to the State of California to cause cancer and birth defects or other reproductive harm. To minimize exposure, avoid breathing exhaust, do not idle the engine except as necessary, service your vehicle in a well-ventilated area and wear gloves or wash your hands frequently when servicing your vehicle. For more information go to www.P65Warnings.ca.gov/passenger-vehicle

A 000 817 82 02

Operating safety

⚠ WARNING Risk of accident due to malfunctions or system failures

To avoid malfunctions or system failures:

- ▶ Always have the prescribed service and maintenance work as well as any required repairs carried out at a qualified specialist workshop.

⚠ WARNING Risk of accident or injury due to incorrect modifications on electronic component parts

Modification of electronic components, their software or wiring could impair their function and/or the function of other networked component parts or safety-relevant systems.

This can endanger the operating safety of the vehicle.

- ▶ Never tamper with the wiring and electronic component parts or their software.

- ▶ You should have all work on electrical and electronic components carried out at a qualified specialist workshop.

Observe the "On-board electronics" section in "Technical data".

⚠ WARNING Risk of fire due to flammable materials on hot parts of the exhaust system

Flammable material such as leaves, grass or twigs may ignite if they come into contact with hot parts of the exhaust system.

- ▶ When driving on unpaved roads or off-road, regularly check the vehicle underside.
- ▶ Remove trapped plants or other flammable material, in particular.
- ▶ If there is damage, consult a qualified specialist workshop immediately.

! **NOTE** Damage to the vehicle due to driving too fast and due to impacts to the vehicle underbody or suspension components

In the following situations, in particular, there is a risk of damage to the vehicle:

- The vehicle becomes grounded, e.g. on a high curb or an unpaved road
- The vehicle is driven too fast over an obstacle, e.g. a curb, speed bump or pothole
- A heavy object strikes the underbody or suspension components

In situations such as these, damage to the body, underbody, suspension components, wheels or tires may not be visible. Components damaged in this way can unexpectedly fail or, in the case of an accident, may no longer absorb the resulting force as intended.

If the underbody paneling is damaged, flammable materials such as leaves, grass or twigs can collect between the underbody and

the underbody paneling. These materials may ignite if they come into contact with hot parts of the exhaust system.

▶ Have the vehicle checked and repaired immediately at a qualified specialist workshop.

or

▶ If driving safety is impaired while continuing your journey, pull over and stop the vehicle immediately, while paying attention to road and traffic conditions, and contact a qualified specialist workshop.

Vehicles with a 48 V on-board electrical system (EQ Boost technology)

! **DANGER** Risk of fatal injury by touching damaged high-voltage components

Vehicles with a 48 V on-board electrical system contain individual high-voltage components. These high-voltage components are under high voltage.

If you modify component parts of these high-voltage components or touch damaged component parts, you may be electrocuted.

High voltage components may be damaged in an accident, although the damage may not be visible.

- ▶ Never perform modifications to component parts of high-voltage components.
- ▶ Never touch damaged component parts of high-voltage components.
- ▶ Never touch component parts of high-voltage components after an accident.

Vehicles with a 48 V on-board electrical system contain high voltage components. These components are marked with a high voltage label:



All work on high voltage components must be carried out at a qualified specialist workshop.

Declaration of conformity for wireless vehicle components

USA: "Radio based devices of this vehicle comply with Part 15 of the FCC Rules. Operation is subject to the following two conditions: 1) These devices may not cause harmful interference, and 2) These devices must accept any interference received, including interference that may cause undesired operation. Changes or modifications not expressly approved by the party responsible

for compliance could void the user's authority to operate the equipment."

Canada: "This vehicle contains license-exempt transmitter(s)/receiver(s) that comply with Innovation, Science and Economic Development Canada's RSS(s). Operation is subject to the following two conditions: (1) These devices may not cause interference, and (2) These devices must accept any interference, including interference that may cause undesired operation of the device."

Charging unit for wireless charging of mobile phones (WMI)

This equipment complies with the FCC and IC radiation exposure limits set forth for an uncontrolled environment. This equipment should be installed and operated with a minimum distance of **0 cm (in contact)** between the radiator and your body. This transmitter must not be co-located or operating in conjunction with any other antenna or transmitter.

USA: "Wireless charging system for mobile devices (Model: D-WMI2015A): this device complies with Part 18 of the FCC Rules."

The name and address of the responsible party is:

Continental Automotive Systems US Inc.
2400 Executive Hills Drive
Auburn Hills, MI 48326-2980
United States of America

Diagnostics connection

The diagnostics connection is a technical interface in the vehicle. It is used, for example, within the scope of repair and maintenance work or for reading out vehicle data by a specialist workshop. Diagnostic devices should therefore only be connected by a qualified specialist workshop.

⚠ WARNING Risk of accident due to connecting devices to the diagnostics connection

If you connect devices to the diagnostics connection of the vehicle, the function of vehicle systems and operating safety may be impaired.

- ▶ For safety reasons, we recommend that you only use and connect products approved by your authorized Mercedes-Benz Center.

⚠ WARNING Risk of accident due to objects in the driver's footwell

Objects in the driver's footwell may impede pedal travel or block a depressed pedal.

This jeopardizes the operating and road safety of the vehicle.

- ▶ Stow all objects in the vehicle securely so that they cannot get into the driver's footwell.
- ▶ Always install the floor mats securely and as prescribed in order to ensure that there is always sufficient room for the pedals.
- ▶ Do not use loose floor mats and do not place floor mats on top of one another.

! **NOTE** Battery discharging from using devices connected to the diagnostics connection

Using devices at the diagnostics connection drains the battery.

- ▶ Check the charge level of the battery.
- ▶ If the charge level is low, charge the battery, e.g. by driving a considerable distance.

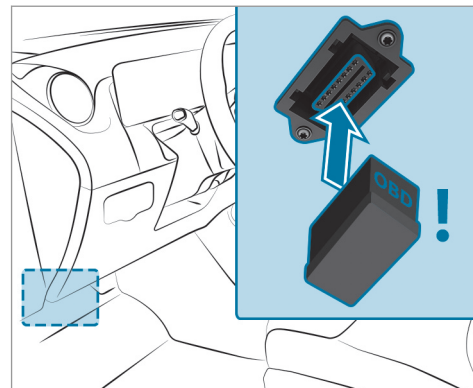

Connecting and using another device with the diagnostics connection can have the following effects:

- Malfunctions in the vehicle system
- Permanent damage to vehicle components

Please refer to the warranty terms and conditions for this matter.

Moreover, connecting equipment to the diagnostics connection can lead to emissions monitoring information being reset, for example. This may lead to the vehicle failing to meet the requirements of the next emissions inspection during the main inspection.

Qualified specialist workshop

An authorized Mercedes-Benz Center is a qualified specialist workshop. It has the necessary special skills, tools and qualifications to correctly carry out the work required on your vehicle. This particularly applies to safety-relevant works.

For the following, always have your vehicle checked at an authorized Mercedes-Benz Center:

- Safety-relevant works
- Service and maintenance work
- Repair work
- Modifications as well as installations and conversions
- Work on electronic components

- **Vehicles with 48 V on-board electrical system (EQ boost technology):** work on high voltage components of the 48 V on-board electrical system

Mercedes-Benz recommends a Mercedes-Benz service center.

Correct use of the vehicle

If you remove any warning stickers, you or others could fail to recognize certain dangers. Leave warning stickers in position.

Observe the following information in particular when driving your vehicle:

- the safety notes in this manual
- technical data for the vehicle
- traffic rules and regulations
- laws and safety standards pertaining to motor vehicles

Notes for persons with electronic medical aids

Mercedes-Benz AG cannot, despite carefully developing vehicle systems, completely rule out the interaction of vehicle systems with electronic medical aids such as cardiac pacemakers.

In addition, there are components installed in the vehicle that, regardless of the operating status of the vehicle, can generate magnetic fields on a par with permanent magnets. These fields can be found, for example, in the area around the multimedia and sound system or also in the area of the seats, depending on the vehicle equipment.

For this reason, the following can occur in isolated cases, depending on the aids used:

- Medical aids malfunctioning
- Adverse health effects

Observe the notes and warnings of the manufacturer of the medical aids; if in doubt, contact the device manufacturer and/or your doctor. If there is continuing uncertainty concerning the possibility of medical aids malfunctioning, Mercedes-

Benz AG recommends using only few electrical vehicle systems and/or maintaining a distance from the components.

Only have repairs and maintenance work in the area of the following components carried out by a qualified specialist workshop:

- Vehicle components carrying live voltage
- Transmission antenna
- Multimedia system and sound system

If you have any queries or suggestions, consult a qualified specialist workshop.

Problems with your vehicle

If you should experience a problem with your vehicle, particularly one that you believe may affect its safe operation, we urge you to contact an authorized Mercedes-Benz Center immediately to have the problem diagnosed and rectified. If the problem is not resolved to your satisfaction, please discuss the problem again with an authorized Mercedes-Benz Center or, if necessary, contact us at one of the following addresses:

In the USA:

Mercedes-Benz USA, LLC
Customer Assistance Center
One Mercedes-Benz Drive
Sandy Springs, GA 30328

In Canada:

Mercedes-Benz Canada, Inc.
Customer Relations Department
98 Vanderhoof Avenue
Toronto, Ontario M4G 4C9

Reporting safety defects

USA only:

The following text is published as required of manufacturers under Title 49, Code of U.S. Federal Regulations, Part 575 pursuant to the "National Traffic and Motor Vehicle Safety Act of 1966".

If you believe that your vehicle has a defect which could cause a crash or could cause injury or death, you should immediately inform the

National Highway Traffic Safety Administration (NHTSA) in addition to notifying Mercedes-Benz USA, LLC.

If NHTSA receives similar complaints, it may open an investigation, and if it finds that a safety defect exists in a group of vehicles, it may order a recall and remedy campaign. However, NHTSA cannot become involved in individual problems between you, your dealer, or Mercedes-Benz USA, LLC.

To contact NHTSA, you may call the Vehicle Safety Hotline toll-free at 1-888-327-4236 (TTY: 1-800-424-9153); go to the <https://www.safercar.gov/>; or write to: Administrator, NHTSA, 400 Seventh Street, SW., Washington, DC 20590.; USA.

You can also obtain other information about motor vehicle safety from: <https://www.safercar.gov>

Canada only:

The following text is published as required of manufacturers under subsection 18.4 (4) of the Motor Vehicle Safety Regulations.

If you believe that your vehicle has a defect which could cause a crash or could cause injury or death, you should immediately inform Transport Canada in addition to notifying Mercedes-Benz Canada Inc.

If Transport Canada received similar complaints, it may open an investigation, and if it finds that a safety defect exists in a group of vehicles, it may order a recall and remedy campaign. However, Transport Canada cannot become involved in individual problems between you, your dealer or Mercedes-Benz Canada Inc.

To contact Transport Canada, you may call the Defect Investigations and Recalls Division toll-free in Canada at 1-800-333-0510 or 819-994-3328 in the Gatineau-Ottawa area or internationally; you may also go to the following websites for more information:

- English: <https://www.tc.gc.ca/recalls>
- French: <https://www.tc.gc.ca/rappels>

Limited Warranty

! **NOTE** Damage to the vehicle arising from violation of these operating instructions.

Damage to the vehicle can arise from violation of these operating instructions.

This damage is not covered either by the Mercedes-Benz implied warranty or by the New- or Used-Vehicle Warranty.

- ▶ Follow the instructions in these operating instructions on proper operation of your vehicle as well as on possible vehicle damage.

QR code for rescue card

QR codes are attached in the fuel filler flap and on the opposite side on the B-pillar. In the event of an accident, rescue services can use the QR code to quickly find the appropriate rescue card for your vehicle. The current rescue card contains the most important information about your

vehicle in a compact form, e.g. the routing of the electric lines.

Further information can be obtained at <https://www.mercedes-benz.de/qr-code>.

Data storage

Data processing in the vehicle

Electronic control units

Electronic control units are installed in your vehicle. Control units process data which, for example, they receive from vehicle sensors, generate themselves or exchange between themselves. Some control units are required for the safe operation of your vehicle, some assist you when driving, such as driver assistance systems, while others enable comfort or infotainment functions.

The following provides you with general information regarding data processing in the vehicle. Additional information regarding exactly which data in your vehicle are collected, saved and transmitted to third parties and for what purpose, can be found in the information directly related to the functional characteristics in ques-

tion in their respective operating instructions. This information is also available on line and, depending on the vehicle equipment, digitally.

Personal data

Every vehicle is identified by a unique vehicle identification number. Depending on the country, this vehicle identification number can be used by, for example, governmental authorities to determine the identity of the owner. There are other possibilities to use data collected from the vehicle to identify the owner or driver, such as the license plate number.

Therefore, data generated or processed by control units may be attributable to a person or, under certain conditions, become attributable to a person. Depending on which vehicle data are available, it may be possible to make inferences about, for example, your driving behavior, your location, your route or your use patterns.

Legal requirements regarding the disclosure of data

If legally required to do so, manufacturers are, in individual cases, legally obliged to provide governmental entities, upon request and to the

extent required, data stored by the manufacturer. For example, this may be the case during the investigation of a criminal offense.

Governmental entities are themselves, in individual cases and within the applicable legal framework, authorized to read out data from the vehicle. In the case of an accident, information that can help with an investigation can, therefore, be taken from the airbag control unit, for example.

Operational data in the vehicle

This is data regarding the operation of the vehicle, which have been processed by control units.

This includes the following data, for example:

- Vehicle status information such as the speed, longitudinal acceleration, lateral acceleration, number of wheel revolutions or the fastened seat belts display
- Ambient conditions, such as temperature, rain sensor or distance sensor

Generally, the use of these data is temporary; they will not be stored beyond the period of operation and will only be processed within the vehicle itself. Control units often contain data

memories for vehicle keys, for example. Their use permits the temporary or permanent documentation of technical information about the vehicle's operating state, component loads, maintenance requirements and technical events or malfunctions.

Depending on the vehicle equipment, the following data are stored:

- Operating status of system components, such as fill levels, tire pressure or battery status
- Malfunctions or faults in important system components, such as lights or brakes
- System reactions in special driving situations, such as airbag deployment or the intervention of stability control systems
- Information on events leading to vehicle damage

In certain cases, it may be required to store data that would have otherwise been used only temporarily. This may be the case if the vehicle has detected a malfunction, for example.

If you use services, such as repair services and maintenance work, stored operational data as well as the vehicle identification number can be read out and used. They can be read out by service network employees, such as workshops and manufacturers or third parties, such as breakdown services. The same is true in the case of warranty claims and quality assurance measures.

In general, the read out is performed via the legally prescribed port for the diagnostics connection in the vehicle. The operational data that are read out document technical states of the vehicle or of individual components and assist in the diagnosis of malfunctions, compliance with warranty obligations and quality improvement. To that end, these data, in particular information about component loads, technical events, malfunctions and other faults may be transmitted along with the vehicle identification number to the manufacturer. Furthermore, the manufacturer is subject to product liability. For this reason the manufacturer also uses operational data from the vehicle, for example, for recalls. These

data can also be used to examine the customer's warranty and guarantee claims.

Fault memories in the vehicle can be reset by a service outlet or at your request as part of repair or maintenance work.

Convenience and infotainment functions

You can store convenience settings and individual settings in the vehicle and change or reset them at any time.

Depending on the vehicle equipment, this includes the following settings, for example:

- Seat and steering wheel positions
- Suspension and climate control settings
- Individual settings, such as interior lighting

Depending on the selected equipment, you can import data into vehicle infotainment functions yourself.

Depending on the vehicle equipment, this includes the following data, for example:

- Multimedia data, such as music, films or photos for playback in an integrated multimedia system

- Address book data for use in connection with an integrated hands-free system or an integrated navigation system
- Entered navigation destinations
- Data about the use of Internet services

These data for convenience and infotainment functions may be saved locally in the vehicle or they may be located on a device which you have connected to the vehicle, such as a smartphone, USB flash drive or MP3 player. If you have entered these data yourself, you can delete them at any time.

This data is transmitted from the vehicle to third parties only at your request. This applies, in particular, when you use online services in accordance with the settings that you have selected.

Smartphone integration (e.g. Android Auto or Apple CarPlay)

If your vehicle is accordingly equipped, you can connect your smartphone or another mobile end device to the vehicle. You can then control them by means of the control elements integrated in the vehicle. Images and audio from the smartphone can be output via the multimedia system.

Certain information is simultaneously transferred to your smartphone. Depending on the type and integration, this includes position data, the day/night mode and other general vehicle statuses. For more information please consult the Operator's Manual of the vehicle/infotainment system.

This integration allows the use of selected smartphone apps, such as navigation or music player apps. There is no further interaction between the smartphone and the vehicle; in particular, vehicle data is not directly accessible. The type of additional data processing is determined by the provider of the app being used. Which settings you can make, if any, depends on the specific app and the operating system of your smartphone.

Online services

Wireless network connection

If your vehicle has a wireless network connection, it enables data to be exchanged between your vehicle and additional systems. The wireless network connection is made possible by the

vehicle's own transmitter and receiver or by a mobile end device that you have brought into the vehicle, for example, a smartphone. Online functions can be used via the wireless network connection. This includes online services and applications/apps provided to you by the manufacturer or by other providers.

Manufacturer's services

Regarding the manufacturer's online services, the individual functions are described by the manufacturer in a suitable place, for example, in the Operator's Manual or on the manufacturer's website, where the relevant data protection information is also given. Personal data may be used for the provision of online services. Data are exchanged via a secure connection, such as the manufacturer's designated IT systems. Any personal data which are collected, processed and used, other than for the provision of services, is done so exclusively on the basis of legal permission. This is the case, for example, for a legally prescribed emergency call system, a contractual agreement or when consent has been given.

You can have services and functions, some of which are subject to a fee, activated or deactivated. This excludes legally prescribed functions and services, such as an emergency call system.

Third party services

If you use online services from other providers (third parties), these services are the responsibility of the provider in question and subject to that provider's data protection conditions and terms of use. As a general rule, the manufacturer has no influence on the content exchanged.

For this reason, when services are provided by third parties, please ask the service provider in question for information about the type, extent and purpose of the collection and use of personal data.

Data protection rights

Depending on your country or the equipment and range of functions of your vehicle as well as the services you use and the services on offer, you are entitled to different data protection rights. Further information on data protection

and your data protection rights can either be found on the manufacturer's website or you will receive this information as part of the various services and service offers. There you will also find the contact information for the manufacturer and its data protection officers.

At a workshop, for example, with the support of a specialist and possibly for a fee, you can have data read out which is stored only locally in the vehicle.

MBUX multimedia system/Mercedes me connect

If the vehicle is equipped with the MBUX multimedia system or Mercedes me connect, additional data about the vehicle's operation, the use of the vehicle in certain situations, and the location of the vehicle may be compiled by the MBUX multimedia system or Mercedes me connect.

For additional information, please refer to the "MBUX multimedia system" section and/or the Mercedes me connect Terms and Conditions.

Event data recorders

USA only:

This vehicle is equipped with an event data recorder (EDR). The main purpose of an EDR is to record, in certain crash or near crash-like situations, such as an airbag deployment or hitting a road obstacle, data that will assist in understanding how a vehicle's systems performed. The EDR is designed to record data related to vehicle dynamics and safety systems for a short period of time, typically 30 seconds or less.

The EDR in this vehicle is designed to record such data as:

- How various systems in your vehicle were operating
- Whether or not the driver and front passenger seat belts were buckled/fastened
- How far (if at all) the driver was depressing the accelerator and/or brake pedal and
- How fast the vehicle was traveling

This data can help provide a better understanding of the circumstances in which accidents and injuries occur. NOTE: EDR data is recorded by

your vehicle only if a non-trivial crash situation occurs; no data is recorded by the EDR under normal driving conditions and no personal data (e.g. name, gender, age and accident location) is recorded. However, other parties, such as law enforcement, could combine EDR data with the type of personally identifying data routinely acquired during a crash investigation.

To read data recorded by an EDR, special equipment is required, and access to the vehicle or the EDR is needed. In addition to the vehicle manufacturer, other parties that have the special equipment, such as law enforcement, can read the information by accessing the vehicle or the EDR.

EDR data may be used in civil and criminal matters as a tool in accident reconstruction, accident claims and vehicle safety. Since the Crash Data Retrieval (CDR) tool that is used to extract data from the EDR is commercially available, Mercedes-Benz USA, LLC ("MBUSA") expressly disclaims any and all liability arising from the extraction of this information by unauthorized Mercedes-Benz personnel.

MBUSA will not share EDR data with others without the consent of the vehicle owner or, if the vehicle is leased, without the consent of the lessee. Exceptions to this representation include responses to subpoenas by law enforcement; by federal, state or local government; in connection with or arising out of litigation involving MBUSA or its subsidiaries and affiliates; or, as required by law.

Warning: The EDR is a component of the Restraint System Module. Tampering with, altering, modifying or removing the EDR component may result in a malfunction of the Restraint System Module and other systems.

State laws or regulations regarding EDRs that conflict with federal regulation are pre-empted. This means that in the event of such conflict, the federal regulation governs. As of December 2016, 17 states have enacted laws relating to EDRs.

Copyright

Free and open source software

Information on license for free and open-source software used in your vehicle can be found on the data carrier in your vehicle document wallet and with updates on the following website:

<https://www.mercedes-benz.com/opensource>

Registered trademarks

- Bluetooth® is a registered trademark of Bluetooth SIG, Inc.
- DTS™ is a registered trademark of DTS, Inc.
- Dolby® and MLP™ are registered trademarks of DOLBY Laboratories.
- ESP® and PRE-SAFE® are registered trademarks of Daimler AG.
- HomeLink® is a registered trademark of Genex Corporation.
- iPod® and iTunes® are registered trademarks of Apple Inc.
- Burmester® is a registered trademark of Burmester Audiosysteme GmbH.
- Microsoft® and Windows Media® are registered trademarks of Microsoft Corporation.
- SIRIUS® is a registered trademark of Sirius XM Radio Inc.
- HD Radio™ is a registered trademark of iBiquity Digital Corporation.
- Gracenote® is a registered trademark of Gracenote, Inc.
- ZAGAT Survey® and related brands are registered trademarks of Zagat Survey, LLC.

Restraint system

Protection provided by the restraint system

The restraint system includes the following components:

- Seat belt system
- Airbags
- Child restraint system
- Child seat securing systems

The restraint system can help prevent the vehicle occupants from coming into contact with parts of the vehicle interior in the event of an accident. In the event of an accident, the restraint system can also reduce the forces to which the vehicle occupants are subjected.

A seat belt can only provide the best level of protection if it is worn correctly. Depending on the detected accident situation, Emergency Tensioning Devices and/or airbags supplement the protection offered by a correctly worn seat belt. Emergency Tensioning Devices and/or airbags are not deployed in every accident.

In order for the restraint system to provide the intended level of protection, each vehicle occupant must observe the following information:

- Fasten seat belts correctly.
- Sit in an almost upright seat position with their back against the seat backrest.
- Sit with their feet resting on the floor, if possible.
- Always secure persons under 5 ft (1.50 m) tall in an additional restraint system suitable for Mercedes-Benz vehicles.

However, no system available today can completely eliminate injuries and fatalities in every accident situation. In particular, the seat belt and airbag generally do not protect against objects penetrating the vehicle from the outside. It is also not possible to completely rule out the risk of injury caused by the airbag deploying.

Reduced restraint system protection

⚠ WARNING Risk of injury or death due to modifications to the restraint system

Vehicle occupants may no longer be protected as intended if alterations are made to the restraint system.

- ▶ Never alter the parts of the restraint system.
- ▶ Never tamper with the wiring or any electronic component parts or their software.

If it is necessary to modify the vehicle to accommodate a person with disabilities, contact an authorized Mercedes-Benz Center for details.

USA only: for details, contact our Customer Assistance Center on 1-800-FOR-MERCEDES (1-800-367-6372).



Restraint system functionality

When the ignition is switched on, a self-test is performed, during which the  restraint sys-

tem warning lamp lights up. It goes out no later than a few seconds after the vehicle is started. The components of the restraint system are then functional.

Malfunctioning restraint system

A malfunction has occurred in the restraint system if:

- The  restraint system warning lamp does not light up when the ignition is switched on
- The  restraint system warning lamp lights up continuously or repeatedly during a journey

⚠ WARNING Risk of injury due to malfunctions in the restraint system

Components in the restraint system may be activated unintentionally or not deploy as planned in an accident.

- ▶ Have the restraint system checked and repaired immediately at a qualified specialist workshop.

Function of the restraint system in an accident

How the restraint system works is determined by the severity of the impact detected and the type of accident anticipated:

- Frontal impact
- Rear impact
- Side impact
- Rollover

The activation thresholds for the components of the restraint system are determined based on the evaluation of the sensor values measured at various points in the vehicle. This process is preemptive in nature. The triggering/deployment of the components of the restraint system must take place in good time at the start of the collision.

Factors which can only be seen and measured after a collision has occurred do not play a decisive role in the deployment of an airbag. Nor do they provide an indication of airbag deployment.

The vehicle may be deformed significantly without an airbag being deployed. This is the case if

only parts which are relatively easily deformed are affected and the rate of vehicle deceleration is not high. Conversely, an airbag may be deployed even though the vehicle suffers only minor deformation. If very rigid vehicle parts such as longitudinal members are hit, this may result in sufficiently high levels of vehicle deceleration.

Depending on the detected deployment situation, the components of the restraint system can be activated or deployed independently of each other:

- Emergency Tensioning Device: frontal impact, rear impact, side impact, rollover
- Driver's airbag, front passenger airbag: frontal impact
- Knee airbag: frontal impact
- Side airbag: side impact
- Window curtain airbag: side impact, rollover, frontal impact
- PRE-SAFE® Impulse Side: side impact

The front passenger airbag can only be deployed in an accident if the PASSENGER AIR BAG OFF

indicator lamp is off. If the front passenger seat is occupied, make sure, both before and during the journey, that the status of the front passenger airbag is correct (→ page 46).

⚠ WARNING Risk of burns from hot air bag components

The air bag parts are hot after an air bag has been deployed.

- ▶ Do not touch the air bag parts.
- ▶ Have a deployed air bag replaced at a qualified specialist workshop as soon as possible.

Mercedes-Benz recommends that you have the vehicle towed to a qualified specialist workshop after an accident. Take this into account, particularly if an Emergency Tensioning Device is triggered or an airbag deployed.

If the Emergency Tensioning Devices are triggered or an airbag is deployed, you will hear a bang, and a small amount of powder may also be released:

- The bang will not generally affect your hearing.
- In general, the powder released is not hazardous to health but may cause short-term breathing difficulties to persons suffering from asthma or other pulmonary conditions. Provided it is safe to do so, leave the vehicle immediately or open the window in order to prevent breathing difficulties.

Airbags and pyrotechnic Emergency Tensioning Devices contain perchlorate material, which may require special handling or environmental protection measures. National guidelines regarding waste disposal must be observed. In California, see <https://dtsc.ca.gov/>. Using the search function, you will find information on perchlorate, for example.

Seat belts

Protection provided by the seat belt

Always fasten your seat belt correctly before starting a journey. A seat belt can only provide the best level of protection if it is worn correctly.

⚠ WARNING Risk of injury or death due to incorrectly fastened seat belt

If the seat belt is not worn correctly, it cannot perform its intended protective function.

In addition, an incorrectly fastened seat belt can also cause injuries, for example, in the event of an accident or when braking or changing direction suddenly.

- ▶ Always ensure that all vehicle occupants have their seat belts fastened correctly and are sitting properly.

Always observe the instructions about the correct driver's seat position and adjusting the seat (→ page 87).

In order for the correctly worn seat belt to provide the intended level of protection, each vehicle occupant must observe the following information:

- The seat belt must not be twisted and must fit tightly and snugly across the body.
- The seat belt must be routed across the center of the shoulder and as low down across the hips as possible.
- The shoulder section of the seat belt should not touch your neck nor be routed under your arm or behind your back.
- Avoid wearing bulky clothing, e.g. a winter coat.
- Push the lap belt down as far as possible across your hips and pull tight with the shoulder section of the belt. Never route the lap belt across your abdomen.
Pregnant women must also take particular care with this.
- Never route the seat belt across sharp, pointed, abrasive or fragile objects.

- Only one person should use each seat belt at any one time. Never allow babies and children to travel sitting on the lap of another vehicle occupant.
- Never secure objects with a seat belt if the seat belt is also being used by one of the vehicle's occupants. Always observe the instructions for loading the vehicle when securing objects, luggage or loads (→ page 100).
Also ensure that no objects, e.g. a cushion, are ever placed between a person and the seat.

The seat belts on the following seats are equipped with a special seat belt retractor:

- Front passenger seat
- Rear seats

Activate or deactivate the special seatbelt retractor (→ page 54).

If children are traveling in the vehicle, be sure to observe the instructions and safety notes on "Children in the vehicle" (→ page 51).

Limitations of the protection provided by the seat belt

⚠ WARNING Risk of injury or death due to an incorrect seat position

The seat belt does not offer the intended level of protection if you have not moved the seat backrest to an almost vertical position. You could slip beneath the seat belt and injure yourself.

- ▶ Adjust the seat properly before commencing your journey.
- ▶ Always ensure that the seat backrest is in an almost vertical position and that the shoulder belt is routed across the center of your shoulder.

⚠ WARNING Risk of injury or death when additional restraint systems are not used for persons with a smaller stature

Persons under 5 ft (1.50 m) tall cannot wear the seat belt correctly without a suitable additional restraint system.

- ▶ Always secure persons under 5 ft (1.50 m) tall in a suitable restraint system.

⚠ WARNING Danger of injury or death due to blocked seat belt anchorage

The restraint effect of the seat belt is impaired if objects between the front seat and the door are blocking the movable seat belt anchorage on the front seat.

- ▶ Before starting a journey, make sure that there are no objects between the front seat and the door.

⚠ WARNING Risk of injury or death due to damaged or modified seat belts

Seat belts cannot provide protection in the following situations:

- The seat belt is damaged, has been modified, is extremely dirty, bleached or dyed

- The seat belt buckle is damaged or extremely dirty
- Modifications have been made to the Emergency Tensioning Device, seat belt anchorage or seat belt retractor

Seat belts may sustain non-visible damage in an accident, e.g. due to glass splinters.

Modified or damaged seat belts could tear or fail in the event of an accident, for example.

Modified Emergency Tensioning Devices could accidentally trigger or fail to function as intended.

- ▶ Never modify the seat belt system, for example the seat belt, seat belt buckle, Emergency Tensioning Device, seat belt anchorage and seat belt retractor.
- ▶ Make sure that the seat belts are undamaged, not worn and clean.
- ▶ Always have the seat belts checked immediately after an accident at a qualified specialist workshop.

Only use seat belts which have been approved for your vehicle by Mercedes-Benz.

⚠ WARNING Risk of injury or death from deployed pyrotechnic Emergency Tensioning Devices

Pyrotechnic Emergency Tensioning Devices that have been deployed are no longer operational and are unable to perform their intended protective function.

- ▶ Therefore, have deployed pyrotechnic Emergency Tensioning Devices immediately replaced at a qualified specialist workshop.

Mercedes-Benz recommends that you have the vehicle towed to a qualified specialist workshop after an accident.

! NOTE Damage caused by trapping the seat belt

If an unused seat belt is not fully retracted, it may become trapped in the door or in the seat mechanism.

- ▶ Always ensure that an unused seat belt is fully retracted.

Fastening and adjusting seat belts

If the seat belt is pulled quickly or sharply, the seat belt retractor locks. The seat belt strap cannot be pulled out any further.

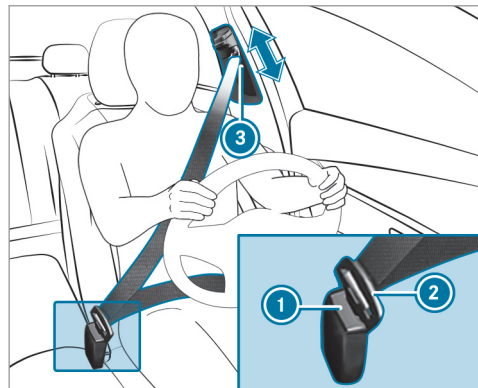

- ▶ Always engage seat belt tongue (2) of the seat belt into seat belt buckle (1) of the corresponding seat.
- ▶ Press and hold the seat belt outlet release and slide seat belt outlet (3) into the desired position.
- ▶ Let go of the seat belt outlet release and ensure that seat belt outlet (3) locks into position.

Vehicles with automatic front passenger airbag shutoff:

- ! **NOTE** Deployment of the Emergency Tensioning Device and side air bag when the front passenger seat is unoccupied

If the seat belt tongue is engaged in the seat belt buckle of the unoccupied front passenger seat, the Emergency Tensioning Device and the side air bag may also deploy in the event of an accident along with other systems.

- ▶ Only one person should use each seat belt at any one time.

Vehicles without automatic front passenger airbag shutoff:

- ! **NOTE** Deployment of the Emergency Tensioning Device when the front-passenger seat is unoccupied

If the seat belt tongue is engaged in the seat belt buckle of the unoccupied front-passenger seat, the Emergency Tensioning Device may also deploy in the event of an accident along with other systems.

- ▶ Only one person should use each seat belt at any one time.

Seat belt adjustment function

Vehicles with PRE-SAFE®: After a front seat belt has been fastened, the automatic seat belt adjustment may apply a certain tightening force. Do not hold the seat belt tightly while it is adjusting.

You can activate and deactivate the seat belt adjustment function using the multimedia system (→ page 41).

Activating/deactivating seat belt adjustment via the multimedia system

Multimedia system:

→ [Home] ▶▶ Settings ▶▶ Vehicle

- ▶ Activate or deactivate **Belt Adjustment**.

Releasing seat belts

- ▶ Press the release button in the seat belt buckle and guide the seat belt back with the seat belt tongue.

Seat belt warning function for the driver and front passenger

The  seat belt warning lamp in the instrument display is a reminder that all vehicle occupants must wear their seat belts correctly.

The  seat belt warning lamp lights up for six seconds every time the vehicle is started.

In addition, a warning tone may sound.

When the driver's and front passenger's doors are closed and the driver and front passenger

have fastened their seat belts, the seat belt warning goes out.

In the following cases, the seat belt warning lights up during a journey if:

- The vehicle speed exceeds 15 mph (25 km/h) and the driver's or front passenger seat belt is not fastened.
- The driver or front passenger unfastens their seat belt while the vehicle is in motion.

Airbags

Overview of airbags

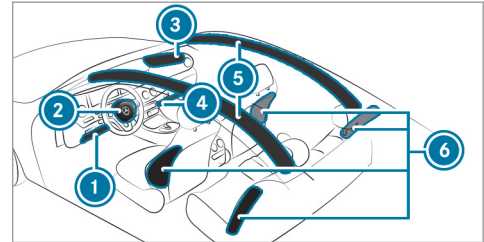

- 1 Driver's knee airbag
- 2 Driver's airbag
- 3 Front passenger airbag
- 4 Front passenger knee airbag
- 5 Window curtain airbag
- 6 Side airbag

The installation location of an airbag is identified by the AIRBAG symbol.

When enabled, an airbag can provide additional protection for the respective vehicle occupant.

42 Occupant safety

Potential protection provided by each airbag:

- Knee airbag: thigh, knee and lower leg
- Driver's airbag, front passenger airbag: head and ribcage
- Window curtain airbag: head
- Side airbag: ribcage, also pelvis for front seat occupants

⚠ WARNING Risk of injury or death if the co-driver airbag is enabled

If the co-driver airbag is enabled, a child on the co-driver seat may be struck by the co-driver airbag during an accident.

NEVER use a rearward-facing child restraint system on a seat with an ENABLED FRONT AIRBAG; DEATH or SERIOUS INJURY to the CHILD can occur.

When installing a child restraint system on the front passenger seat, observe the vehicle-specific information (→ page 60). Also, always observe the notes on rearward-facing or forward-facing child restraint systems on the front passenger seat.

Information on automatic front passenger airbag shutoff

The front passenger airbag can only be deployed in an accident if the PASSENGER AIR BAG OFF indicator lamp is off. If the front passenger seat is occupied, make sure, both before and during the journey, that the status of the front passenger airbag is correct (→ page 46).

! NOTE Important points to remember if the front passenger seat is unoccupied

In an accident, the components of the restraint system may deploy unnecessarily on the front passenger side if:

- There are heavy objects on the front passenger seat.
 - The seat belt tongue is engaged in the seat belt buckle of the front passenger seat and the front passenger seat is unoccupied.
- ▶ Stow objects in a suitable place.
- ▶ Only one person should use each seat belt at any one time.

Depending on the detected accident situation, the window curtain airbag on the front passenger side may deploy. The airbag is deployed regardless of whether the front passenger seat is occupied.

Protective capacity of the airbags

Depending on the accident situation, an airbag may supplement the protection offered by a correctly fastened seat belt.

⚠ WARNING Risk of injury or death due to an incorrect seat position

If you deviate from the correct seat position, the airbag cannot perform its intended protective function.

Each vehicle occupant must make sure of the following:

- Fasten seat belts correctly. Pregnant women must take particular care to ensure that the lap belt never lies across the abdomen.

- Adopt the correct seat position and keep as far away as possible from the airbags.
- Observe the following information.
- ▶ Always make sure that there are no objects between the airbag and vehicle occupant.

To avoid the risks resulting from the deployment of an airbag, each vehicle occupant must observe the following information in particular:

- Before starting your journey, adjust your seat correctly; the driver's seat and front passenger seat should be moved as far back as possible.
When doing so, always observe the information on the correct driver's seat position (→ page 87).
- Only hold the steering wheel by the steering wheel rim. This allows the airbag to be fully deployed.
- Always lean against the seat backrest when the vehicle is in motion. Do not lean forwards or against the door or side window. You may

otherwise be in the deployment area of the airbags.

- The occupants must always keep their feet on the floor. Do not put your feet on the cockpit, for example. Your feet may otherwise be in the deployment area of the airbag.
- If children are traveling in the vehicle, observe the additional notes (→ page 51).
- Always store and secure objects correctly.

Objects in the vehicle interior may prevent an airbag from functioning correctly. Each vehicle occupant must always make sure of the following in particular:

- There are no people, animals or objects between the vehicle occupants and an airbag.
- There are no objects between the seat, door and door pillar (B-pillar).
- There are no hard objects, e.g. coat hangers, hanging on the grab handles or coat hooks.
- There are no accessory parts, such as mobile navigation devices, mobile phones or cup holders, within the deployment area of an air-

bag, e.g. on the cockpit, on the door, on the side window or on the side trim.

In addition, no connecting cables, tensioning straps or retaining straps must be routed or attached to the vehicle within the deployment area of an airbag. Always comply with the accessory manufacturer's installation instructions and, in particular, the notes on suitable places for installation.

- There are no heavy, sharp-edged or fragile objects in the pockets of your clothing. Store such objects in a suitable place.

Limited protection provided by airbags

▲ WARNING Risk of injury due to modifications to the cover of an airbag

If you modify the cover of an airbag or affix objects such as stickers to it, the airbag may no longer function correctly.

- ▶ Never modify the cover of an airbag and do not affix objects to it.

44 Occupant safety

The installation location of an airbag is identified by the AIRBAG symbol (→ page 41).

⚠ WARNING Risk of injury or death due to the use of unsuitable seat covers

Due to unsuitable seat covers, the airbags cannot protect vehicle occupants as intended.

In addition, the operation of the automatic front passenger airbag shutoff could be restricted.

- ▶ You should only use seat covers that have been approved for the corresponding seats by Mercedes-Benz.

⚠ WARNING Risk of injury due to malfunctioning sensors in the door

The function of the airbags can be impaired due to modifications or incorrect work performed on the doors or door trim, or if the doors are damaged.

- ▶ Never modify the doors or parts of the doors.

- ▶ Always have work on the doors or door trim carried out at a qualified specialist workshop.

⚠ WARNING Risk of injury due to deployed airbag

A deployed airbag no longer offers any protection.

- ▶ Have the vehicle towed to a qualified specialist workshop in order to have the deployed airbag replaced.

Have deployed airbags replaced immediately.

Status of the front passenger front airbag

Function of the automatic front passenger airbag shutoff

The automatic front passenger airbag shutoff is able to detect whether the front passenger seat is occupied by a person or a child restraint system. The front passenger airbag and front passenger knee airbag are enabled or disabled accordingly.

⚠ WARNING Risk of injury or death due to objects under the co-driver seat

Objects trapped under the co-driver seat can interfere with the function of the automatic co-driver airbag shutoff or damage the system.

- ▶ Do not store any objects under the co-driver seat.
- ▶ When the co-driver seat is occupied, make sure that no objects are trapped under the co-driver seat.

When installing a child restraint system on the front passenger seat, always make sure of the following:

- Ensure that the child restraint system is positioned correctly (→ page 50).
- Always comply with the child restraint system manufacturer's installation instructions.
- Never place objects (e.g. cushions) under or behind the child restraint system.
- Fully retract the seat cushion length adjustment.

- The entire base of the child restraint system must always rest on the sitting surface of the front passenger seat.
- The backrest of the forward-facing child restraint system must, as far as possible, be resting on the seat backrest of the front passenger seat.
- The child restraint system must not touch the roof or be put under strain by the head restraints. Adjust the seat backrest inclination and the head restraint setting accordingly.

⚠ WARNING Risk of injury or death due to objects between the seat surface and the child restraint system

Objects between the sitting surface and the child restraint system could affect the function of the automatic co-driver airbag shut-off.

- ▶ Do not place any objects between the sitting surface and the child restraint system.

- ▶ The entire base of the child restraint system must always rest on the sitting surface of the co-driver seat.
- ▶ The backrest of the forward-facing child restraint system must, as far as possible, be resting on the seat backrest of the co-driver seat.
- ▶ Always comply with the child restraint system manufacturer's installation instructions.

A person on the front passenger seat must observe the following information:

- Fasten seat belts correctly (→ page 37).
- Sit in an almost upright seat position with their back against the seat backrest.
- Sit with their feet resting on the floor, if possible.

The front passenger airbag may otherwise be disabled by mistake, for example, in the following situations:

- The front passenger transfers their weight by supporting themselves on a vehicle armrest.

- The front passenger sits in such a way that their weight is raised from the sitting surface.

⚠ WARNING Risk of injury or death due to a disabled front passenger airbag

The front passenger airbag is disabled when the PASSENGER AIR BAG OFF indicator lamp is lit.

A person in the front passenger seat could then, for example, come into contact with the vehicle interior, especially if the person is sitting too close to the cockpit.

If the front passenger seat is occupied, always ensure that:

- The classification of the person in the front passenger seat is correct and the front passenger airbag is enabled or disabled in accordance with the person in the front passenger seat.
- The front passenger seat has been moved as far back as possible.
- The person is seated correctly.

- ▶ Both before and during the journey, ensure that the status of the front passenger airbag is correct.

If the front passenger seat is occupied, the classification of the person or child restraint system on the front passenger seat takes place after the front passenger airbag shutoff self-test. The PASSENGER AIR BAG indicator lamps display the status of the front passenger airbag.

Always observe the notes on the function of the PASSENGER AIR BAG indicator lamps (→ page 46).

Function of the PASSENGER AIR BAG indicator lamps

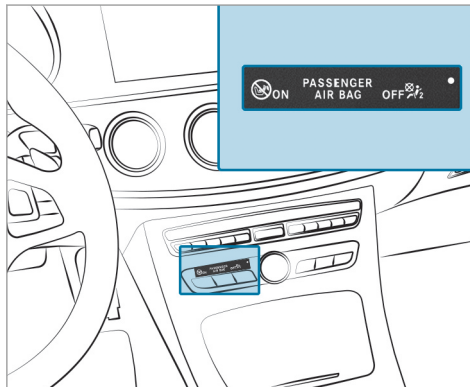

Self-test of automatic front passenger airbag shutoff

When the ignition is switched on, a self-test is performed during which the two PASSENGER AIR BAG ON and OFF indicator lamps light up simultaneously.

The status of the front passenger airbag is displayed via the PASSENGER AIR BAG indicator lamps after the self-test:

- **ON is lit:** the front passenger airbag may deploy during an accident. The indicator lamp goes out after approximately 60 seconds.
- **ON and OFF are not lit:** the front passenger airbag may deploy during an accident.
- **OFF is lit:** the front passenger airbag is disabled. It will then not be deployed in the event of an accident.

If the PASSENGER AIR BAG ON indicator lamp is off, only the PASSENGER AIR BAG OFF indicator lamp shows the status of the front passenger airbag. The PASSENGER AIR BAG OFF indicator lamp may be lit continuously or be off.

If the PASSENGER AIR BAG OFF indicator lamp and the  restraint system warning lamp light up simultaneously, the front passenger seat may not be used. Also in this case, do not install a child restraint system on the front passenger seat. Have the automatic front passenger airbag

shutoff checked and repaired immediately at a qualified specialist workshop.

Status display

If the front passenger seat is occupied, ensure, both before and during the journey, that the status of the front passenger airbag is correct for the current situation.

After installing a rearward-facing child restraint system on the front passenger seat: PASSENGER AIR BAG OFF must be lit continuously.

⚠ WARNING Risk of injury or death when using a rearward-facing child restraint system while the front passenger airbag is enabled

If you secure a child in a rearward-facing child restraint system on the front passenger seat and the PASSENGER AIR BAG OFF indicator lamp is off, the front passenger airbag can deploy in the event of an accident.

The child could be struck by the airbag.

Always ensure that the front passenger airbag is disabled. The PASSENGER AIR BAG OFF indicator lamp must be lit.

NEVER use a rearward-facing child restraint system on a seat with an ENABLED FRONT AIRBAG; DEATH or SERIOUS INJURY to the CHILD can occur.

When installing a child restraint system on the front passenger seat, observe the vehicle-specific information (→ page 60).

Depending on the child restraint system and the stature of the child, the PASSENGER AIR BAG OFF indicator lamp may be off. In this case, do not install the rearward-facing child restraint system on the front passenger seat.

Instead, install the rearward-facing child restraint system on a suitable rear seat.

After installing a forward-facing child restraint system on the front passenger seat: depending on the child restraint system and the stature of the child, PASSENGER AIR BAG OFF may be lit continuously or be off. Always observe the following information.

⚠ WARNING Risk of injury or death due to incorrect positioning of the forward-facing child restraint system

If you secure a child in a forward-facing child restraint system on the front passenger seat that is positioned too close to the cockpit, in the event of an accident, the child could:

- come into contact with the vehicle interior if the PASSENGER AIR BAG OFF indicator lamp is lit, for example
 - be struck by the airbag if the PASSENGER AIR BAG OFF indicator lamp is off.
- ▶ Always move the front passenger seat as far back as possible and fully retract the seat cushion length adjustment. While doing so, always make sure that the shoulder belt strap is correctly routed from the seat belt outlet of the vehicle to the shoulder belt guide on the child restraint system. The shoulder belt strap must be routed forwards and downwards from the seat belt outlet. If necessary, adjust the seat belt outlet

and the front passenger seat accordingly.

- ▶ Always comply with the child restraint system manufacturer's installation instructions.

When installing a child restraint system on the front passenger seat, observe the vehicle-specific information (→ page 60).

If a person is sitting on the front passenger seat: PASSENGER AIR BAG OFF may be lit continuously or be off, depending on the person's stature.

A person on the front passenger seat must always observe the following information:

- If the front passenger seat is occupied by an adult or a person with a stature corresponding to that of an adult, the PASSENGER AIR BAG OFF indicator lamp must be off. This indicates that the front passenger airbag is enabled.

If the PASSENGER AIR BAG OFF indicator lamp is lit continuously, an adult or person

with a build corresponding to that of an adult should not use the front passenger seat.

Instead, they should use a rear seat.

- If the front passenger seat is occupied by a person of smaller stature (e.g. a teenager or small adult), the PASSENGER AIR BAG OFF indicator lamp either lights up continuously or remains off, depending on the classification.
 - If the PASSENGER AIR BAG OFF indicator lamp is off: move the front passenger seat as far back as possible, or the person of smaller stature should use a rear seat.
 - If the PASSENGER AIR BAG OFF indicator lamp is lit continuously: the person of smaller stature should not use the front passenger seat.

⚠ WARNING Risk of injury or death when the PASSENGER AIR BAG OFF indicator lamp is lit

If the PASSENGER AIR BAG OFF indicator lamp remains lit after the self-test, the front passenger airbag is disabled.

If the front passenger seat is occupied, always ensure that:

- The classification of the person in the front passenger seat is correct and the front passenger airbag is enabled or disabled in accordance with the person in the front passenger seat.
- The person is seated properly with a correctly fastened seat belt.

Be sure to also observe the following further related subjects:

- Child restraint system on the front passenger seat (→ page 60)

PRE-SAFE® system

PRE-SAFE® (anticipatory occupant protection)

PRE-SAFE® is able to detect certain critical driving situations and implement pre-emptive measures to protect the vehicle occupants.

PRE-SAFE® can implement the following measures independently of each other:

- Tightening the seat belts on the driver's seat and front passenger seat.
- Closing the side windows.
- **Vehicles with sliding sunroof:** Close the sliding sunroof.
- **Vehicles with memory function:** Move the front passenger seat to a more favorable seat position.
- **Vehicles with multicontour seat:** Increase the air pressure in the seat side bolsters of the seat backrest.
- PRE-SAFE® Sound: provided that the multimedia system is switched on, generates a

brief noise signal to stimulate the innate protective mechanism of a person's hearing.

NOTE Damage caused by objects in the footwell or behind the seat

The automatic adjustment of the seat position may result in damage to the seat and/or the object.

► Stow objects in a suitable place.

Reversing the PRE-SAFE® system measures

If an accident did not occur, the pre-emptive measures that were taken are reversed.

You will need to perform certain settings yourself.

- If the seat belt pre-tensioning is not reduced, move the seat backrest back slightly. The locking mechanism releases.

Function of PRE-SAFE® PLUS (anticipatory occupant protection plus)

PRE-SAFE® PLUS can detect certain impacts, particularly an imminent rear impact, and take pre-emptive measures to protect the vehicle occupants. These measures cannot necessarily prevent an imminent impact.

PRE-SAFE® PLUS can implement the following measures independently of each other:

- Tightening the seat belts on the driver's seat and front passenger seat.
- Increasing brake pressure when the vehicle is stationary. This brake application is canceled automatically when the vehicle pulls away.

If an accident did not occur, the pre-emptive measures that were taken are reversed.

System limits

The system will not initiate any action in the following situations:

- When backing up

The system will not initiate any braking application in the following situations:

- Whilst driving
or
- When entering or exiting a parking space while using Active Parking Assist

Function of PRE-SAFE® Impulse Side

If an imminent side impact is detected, PRE-SAFE® Impulse Side can pre-emptively move the front seat vehicle occupant's upper body towards the center of the vehicle. It does this by rapidly inflating an air cushion in the outer seat side bolster of the seat backrest on the side on which the impact is anticipated. This increases the distance between the door and the vehicle occupant.

If PRE-SAFE® Impulse Side has been deployed or is faulty, the **PRE-SAFE Impulse Side Inoperative** See Operator's Manual (→ page 341) display message appears.

Safely transporting children in the vehicle

Always observe when children are traveling in the vehicle

- ❗ Also strictly observe the safety notes for the specific situation. In this way you can recognize potential risks and avoid dangers if children are traveling in the vehicle (→ page 51).

Be diligent

Bear in mind that negligence when securing a child in the child restraint system may have serious consequences. Always be diligent in securing a child carefully before every journey.

To improve protection for children younger than 12 years old or under 5 ft (1.50 m) in height, Mercedes-Benz recommends you observe the following information:

- Always secure the child in a child restraint system suitable for this Mercedes-Benz vehicle.
- The child restraint system must be appropriate to the age, weight and size of the child.

- The vehicle seat must be suitable for installing a child restraint system.

Accident statistics show that children secured on the rear seats are generally safer than children secured on the front seats. For this reason, Mercedes-Benz strongly advises that you install a child restraint system on a rear seat.

The generic term child restraint system

The generic term child restraint system is used in this Operator's Manual. A child restraint system is, for example:

- A baby car seat
- A rearward-facing child seat
- A forward-facing child seat
- A child booster seat with a backrest and seat belt guide
Mercedes-Benz recommends using a child booster seat with a backrest.

The child restraint system must be appropriate to the age, weight and size of the child.

Observe laws and legal requirements

Always observe the legal requirements when using a child restraint system in the vehicle.

Observe standards for child restraint systems

All child restraint systems must meet the following standards:

- U.S. Federal Motor Vehicle Safety Standards 213 and 225
- Canadian Motor Vehicle Safety Standards 213 and 210.2

Confirmation that the child restraint system complies with the standards can be found on an instruction label on the child restraint system. This confirmation can also be found in the installation instructions that are included with the child restraint system.

Detecting risks, avoiding danger**Securing systems for child restraint systems in the vehicle**

Only use the following securing systems for child restraint systems:

- The LATCH-type (ISOFIX) securing rings
- The vehicle's seat belt system
- The Top Tether anchorages

Installing a LATCH-type (ISOFIX) child restraint system is favored.

Simply attaching to the securing rings on the vehicle can reduce the risk of installing the child restraint system incorrectly.

When securing a child with the integrated seat belt of the LATCH-type (ISOFIX) child restraint system, always comply with the permissible gross weight for the child and child restraint system (→ page 55).

A booster seat may be necessary to achieve proper seat belt positioning for children over 40 lbs (18 kg) in weight or until they reach a

height where a three-point seat belt can be installed properly without a booster seat.

Mercedes-Benz recommends a suitable child booster seat with a backrest and seat belt guide.

Advantage of a rearward-facing child restraint system

It is preferable to transport a baby or a small child in a suitable rearward-facing child restraint system. In this case, the child sits in the opposite direction to the direction of travel and faces backwards.

Babies and small children have comparatively weak neck muscles in relation to the size and weight of their head. The risk of injury to the cervical spine during an accident can be reduced in a rearward-facing child restraint system.

Always secure a child restraint system correctly

⚠ WARNING Risk of injury or death due to incorrect installation of the child restraint system

The child can then not be protected or restrained as intended.

- ▶ Be sure to comply with the manufacturer's installation instructions for the child restraint system and its correct use.
- ▶ Make sure that the entire base of the child restraint system always rests on the sitting surface of the seat.
- ▶ Never place objects (e.g. cushions) under or behind the child restraint system.
- ▶ Use child restraint systems only with the original cover designed for them.
- ▶ Always replace damaged covers with genuine covers.

⚠ WARNING Risk of injury or death due to unsecured child restraint systems in the vehicle

If the child restraint system is incorrectly installed or not secured, it can come loose.

The child restraint system could be flung around and hit vehicle occupants.

- ▶ Always install child restraint systems correctly, even when not in use.
 - ▶ Always comply with the child restraint system manufacturer's installation instructions.
- Always observe the child restraint system manufacturer's installation and operating instructions as well as the vehicle-specific information:
 - Installing the LATCH-type (ISOFIX) child restraint system on the rear seat (→ page 55).
 - Securing the child restraint system with the seat belt on the rear seat (→ page 58).

- Securing the child restraint system with the seat belt on the front passenger seat (→ page 60). Observe the specific instructions for the rearward-facing and forward-facing child restraint systems (→ page 60).

If the front passenger seat is occupied, ensure, both before and during the journey, that the status of the front passenger airbag is correct for the current situation (→ page 46).

- Observe the warning labels in the vehicle interior and on the child restraint system.
- Also secure Top Tether if present.

Do not modify the child restraint system

⚠ WARNING Risk of injury due to modifications to the child restraint system

The child restraint system can no longer function properly. This poses an increased risk of injury.

- ▶ Never modify a child restraint system.

- ▶ Only affix accessories which have been specially approved for this child restraint system by the child restraint system's manufacturer.

Only use child restraint systems which are in proper working condition

- ▲ **WARNING** Risk of injury or death caused by the use of damaged child restraint systems

Child restraint systems or their retaining systems that have been subjected to stress in an accident may not be able to perform their intended protective function.

It may be the case that the child cannot be properly restrained.

- ▶ Always immediately replace child restraint systems that have been damaged or involved in an accident.
- ▶ Have the securing systems for the child restraint systems checked at a qualified specialist workshop before installing a child restraint system again.

Avoid direct sunlight

- ▲ **WARNING** Risk of burns when the child seat is exposed to direct sunlight

If the child restraint system is exposed to direct sunlight or heat, parts could heat up. Children could suffer burns from these parts, particularly on the metallic parts of the child restraint system.

- ▶ Always make sure that the child restraint system is not exposed to direct sunlight.
- ▶ Protect the child restraint system, e.g. with a blanket.
- ▶ If the child restraint system has been exposed to direct sunlight, allow it to cool before securing a child in it.
- ▶ Never leave children unattended in the vehicle.

Observe when stopping or parking

- ▲ **WARNING** Risk of accident and injury due to children left unattended in the vehicle

If children are left unsupervised in the vehicle, they could, in particular:

- Open doors, thereby endangering other persons or road users.
- Get out and be struck by oncoming traffic.
- Operate vehicle equipment and become trapped, for example.

In addition, the children could also set the vehicle in motion, for example by:

- Releasing the parking brake.
- Changing the transmission position.
- Starting the vehicle.
- ▶ Never leave children unattended in the vehicle.

- ▶ When leaving the vehicle, always take the SmartKey with you and lock the vehicle.
- ▶ Keep the vehicle SmartKey out of reach of children.

⚠ WARNING Danger to life due to exposure to extreme heat or cold in the vehicle

If people, particularly children, are exposed to extreme temperatures over an extended period of time, there is a risk of serious injury or danger to life.

- ▶ Never leave persons, children in particular, unattended in the vehicle.

Overview of suitable seats in the vehicle for installing a child restraint system

Left/right rear seat

Preferred securing system:

-  LATCH-type (ISOFIX) child seat anchor

-  Also secure Top Tether if present (→ page 57).

Alternative securing system:

-  Vehicle seat belt

Front passenger seat

Securing system:



-  Vehicle seat belt

Be sure to observe:

- If the front passenger seat is occupied, ensure, both before and during the journey, that the status of the front passenger airbag is correct for the current situation (→ page 46).
- Observe the notes on automatic front passenger airbag shutoff (→ page 44)

Center rear seat

Securing system:

-  Vehicle seat belt
-  Also secure Top Tether if present (→ page 57).

Activating or deactivating the special seal belt retractor of the seat belt

⚠ WARNING Risk of injury or death if a seat belt is unfastened while the vehicle is in motion

If the seat belt is released while the vehicle is in motion, the child safety lock is deactivated and the child restraint system is no longer correctly secured. The seat belt is drawn in slightly by the inertia reel and cannot be immediately closed again.

- ▶ Stop the vehicle immediately in accordance with the traffic conditions.
- ▶ Activate the special seal belt retractor again and correctly secure the child restraint system.

When enabled, the special seal belt retractor ensures that the seat belts of the front passenger seat and rear seats do not slacken once the child restraint system is secured.

The seat belts on the following seats are equipped with a special seal belt retractor:

- Front passenger seat
- Rear seats

- ▶ **To install a child restraint system:** when installing a child restraint system, always observe the manufacturer's installation and operating instructions as well as the information in this Operator's Manual.
- ▶ Pull the seat belt smoothly from the seat belt outlet.
- ▶ Engage the seat belt tongue in the seat belt buckle.
- ▶ **To activate the special seal belt retractor:** pull the seat belt out fully and let the inertia reel retract it again. When the special seal belt retractor is activated, you will hear a ratcheting sound.
- ▶ Push the child restraint system down until the seat belt sits tightly.
- ▶ **To deactivate the special seal belt retractor:** press the release button of the seat belt buckle.

- ▶ Hold the seat belt tongue and guide back to the seat belt outlet.

Installing a LATCH-type (ISOFIX) child restraint system on the rear seat

Installing a LATCH-type (ISOFIX) child restraint system on the rear seat

⚠ WARNING Risk of accident if the rear bench seat, rear seat and seat backrest are not engaged

The rear bench seat, rear seat and seat backrest may fold forwards, even when you are driving.

- As a result, the vehicle occupant will be pushed into the seat belt with increased force. The seat belt will not be able to protect as intended and could cause additional injury.
- Objects or loads in the trunk or cargo compartment will not be restrained by the seat backrest.

- ▶ Make sure that the rear bench seat, the rear seat and the seat backrest are engaged before every trip.

If the left and right seat backrests are not engaged and locked in place, this will be shown on the multifunction display on the instrument cluster.

If the center seat backrest is not engaged and locked in place, the red lock verification indicator will be visible.

⚠ WARNING Risk of injury or death if the permissible gross mass of the child and child restraint system is exceeded

The LATCH-type (ISOFIX) child seat securing systems may be overloaded and the child may not be restrained in the event of an accident, for example.

- ▶ If the child and the child restraint system together weigh more than the permissible gross mass of 73 lb (33 kg), use only a LATCH-type (ISOFIX) child

restraint system that secures the child with the vehicle seat belt.

- ▶ Also secure the child restraint system with the Top Tether belt, if available.

Always comply with the information about the mass of the child restraint system:

- In the manufacturer's installation and operating instructions for the child restraint system used
- On a label on the child restraint system, if present

Regularly check that the permissible gross mass of the child and child restraint system is still complied with.

When installing a child restraint system, observe the following:

- ☑ Always observe the correct use of the seats and consider their suitability for attaching a child restraint system.
- ☑ Always comply with the manufacturer's installation and operating instructions for the child restraint system used.

- ☑ Make sure that the child's feet do not touch the front seat. If necessary, move the front seat slightly forwards.

 When installing a LATCH-type (ISOFIX) child restraint system, also observe the following:

- ☑ **When using a baby car seat in weight group 0/0+ and a rearward-facing child restraint system in weight group I on a rear seat:** adjust the front seat so that the seat does not touch the child restraint system.
- ☑ **When using a forward-facing child restraint system in weight group I:** the backrest of the child restraint system must lie as flat as possible against the backrest of the vehicle seat.
- ☑ If the head restraint of the child seat cannot be fully extended when it is installed in the vehicle, this will result in restrictions on the maximum size setting for child restraint systems in weight group 2 or 3.
Contact with the roof when the head restraint is fully extended and locked in

place will not result in any restrictions on use.

- ☑ The child restraint system must not be put under strain between the roof and the seat cushion and/or be installed facing the wrong direction. Where possible, adjust the seat cushion inclination accordingly.
- ☑ The child restraint system must not be put under strain by the head restraint. Adjust the head restraints as appropriate.

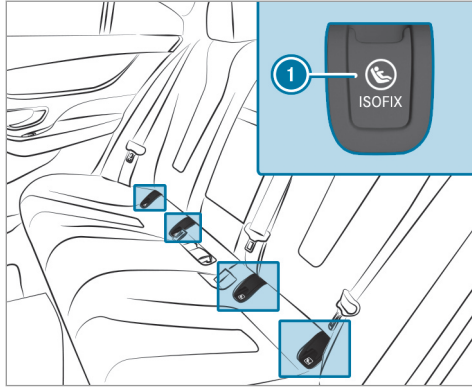

1 LATCH-type (ISOFIX) mounting bracket

Before every journey, make sure that the LATCH-type (ISOFIX) child restraint system is engaged correctly in both mounting brackets in the vehicle.

! **NOTE** Damage to the seat belt for the center seat during installation of the child restraint system

- ▶ Make sure that the seat belt is not trapped.

- ▶ Remove and store away covers 1.
- ▶ Attach the LATCH-type (ISOFIX) child restraint system to both mounting brackets in the vehicle.
- ▶ After removing the child seat, reattach covers 1.

Securing Top Tether

! **WARNING** Risk of injury or death if the rear seat backrests are not locked after Top Tether belts are installed

The rear seat backrests may fold forwards when you are driving.

As a result, child restraint systems will no longer be able to perform their intended pro-

TECTIVE function. This may also cause additional injuries.

- ▶ Always lock rear seat backrests after installing Top Tether belts.
- ▶ Observe the lock verification indicator.

If the left and right seat backrests are not engaged and locked in place, this will be shown on the multifunction display on the instrument cluster.

If the center seat backrest is not engaged and locked in place, the red lock verification indicator will be visible.

 If the child restraint system is equipped with a Top Tether belt:

The risk of injury may be reduced by Top Tether. The Top Tether belt enables an additional connection between the child restraint system attached with LATCH-type (ISOFIX) and the vehicle.

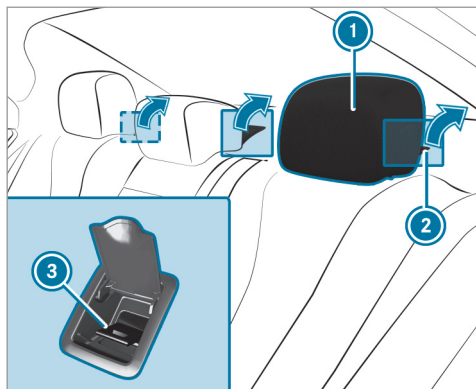

- ▶ If necessary, slide head restraint ① upwards (→ page 92).
- ▶ Fold up cover ② of Top Tether anchorage ③.
- ▶ Install the LATCH-type (ISOFIX) child restraint system with Top Tether. In doing so, comply with the child restraint system manufacturer's installation instructions.

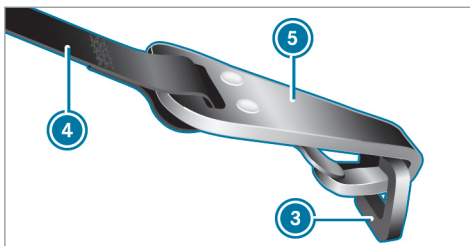

- ▶ Guide Top Tether belt ④ under head restraint ① between the two head restraint bars.
- ▶ Hook Top Tether hook ⑤ of Top Tether belt ④ into Top Tether anchorage ③ without twisting.
- ▶ Tension Top Tether belt ④. In doing so, comply with the child restraint system manufacturer's installation instructions.
- ▶ Fold down cover ② of Top Tether anchorage ③.
- ▶ If necessary, slide head restraint ① downwards (→ page 92). Make sure that you do

not interfere with the correct routing of Top Tether belt ④.

Securing the child restraint system with the seat belt

Securing the child restraint system with the seat belt on the rear seat

⚠ WARNING Risk of accident if the rear bench seat, rear seat and seat backrest are not engaged

The rear bench seat, rear seat and seat backrest may fold forwards, even when you are driving.

- As a result, the vehicle occupant will be pushed into the seat belt with increased force. The seat belt will not be able to protect as intended and could cause additional injury.
- Objects or loads in the trunk or cargo compartment will not be restrained by the seat backrest.

- ▶ Make sure that the rear bench seat, the rear seat and the seat backrest are engaged before every trip.

If the left and right seat backrests are not engaged and locked in place, this will be shown on the multifunction display on the instrument cluster.

If the center seat backrest is not engaged and locked in place, the red lock verification indicator will be visible.

When installing a belt-secured child restraint system, observe the following:

- ✔ Always comply with the manufacturer's installation and operating instructions for the child restraint system used.
- ✔ **When using a weight category 0/0+ baby car seat and a weight category I rearward-facing child restraint system on a rear seat:** adjust the front seat so that the seat does not touch the child restraint system.
- ✔ The backrest of the forward-facing child restraint system must, as far as possible, be

resting on the seat backrest of the rear seat.

- ✔ If the head restraint of the child seat cannot be fully extended when it is installed in the vehicle, this will result in restrictions on the maximum size setting for child restraint systems in weight category II or III.
Contact with the roof when the head restraint is fully extended and locked in place will not result in any restrictions on use.
- ✔ The child restraint system must not be put under strain between the roof and the seat cushion and/or be installed facing the wrong direction. Where possible, adjust the seat cushion inclination accordingly.
- ✔ The child restraint system must not be put under strain by the head restraint. Adjust the head restraints as appropriate.
- ✔ Make sure that the child's feet do not touch the front seat. If necessary, move the front seat slightly forwards.

The seat belts on the following seats are equipped with a special seat belt retractor:

- Front passenger seat
- Rear seats

When enabled, the special seat belt retractor ensures that the seat belts of the front passenger seat and rear seats do not slacken once the child restraint system is secured (→ page 54).

- ▶ Install the child restraint system.
The entire base of the child restraint system must always rest on the sitting surface of the rear seat.
- ▶ Always make sure that the shoulder belt strap is correctly routed from the seat belt outlet of the vehicle to the shoulder belt guide on the child restraint system.
The shoulder belt strap must be routed forwards and downwards from the seat belt outlet.

Notes on rearward-facing and forward-facing child restraint systems on the front passenger seat

⚠ WARNING Risk of injury or death when using a rearward-facing child restraint system while the front passenger airbag is enabled

If you secure a child in a rearward-facing child restraint system on the front passenger seat and the PASSENGER AIR BAG OFF indicator lamp is off, the front passenger airbag can deploy in the event of an accident.

The child could be struck by the airbag.

Always ensure that the front passenger airbag is disabled. The PASSENGER AIR BAG OFF indicator lamp must be lit.

NEVER use a rearward-facing child restraint system on a seat with an ENABLED FRONT AIRBAG; DEATH or SERIOUS INJURY to the CHILD can occur.

Observe the specific instructions for the rearward-facing and forward-facing child restraint systems (→ page 60).

Always observe the status of the front passenger airbag on the PASSENGER AIR BAG OFF indicator lamp:

- When using a rearward-facing child restraint system on the front passenger seat, the front passenger airbag must always be disabled. This is only the case if the PASSENGER AIR BAG OFF indicator lamp is lit continuously (→ page 46).
- If the PASSENGER AIR BAG OFF indicator lamp is off, the front passenger airbag is enabled. The front passenger airbag may deploy during an accident.

Securing the child restraint system with the seat belt on the front passenger seat

When installing a belt-secured child restraint system on the front passenger seat, always observe the following:

- ✓ Observe the notes on rearward-facing and forward-facing child restraint systems on the front passenger seat (→ page 60).
- ✓ Observe the child restraint system manufacturer's installation and operating instructions.
- ✓ When using a forward-facing child restraint system in weight category I: remove the head restraint from the respective seat, if possible.
After the child restraint system has been removed, replace the head restraints again immediately and adjust them correctly.
- ✓ The backrest of the forward-facing child restraint system must, as far as possible, be resting on the seat backrest of the front passenger seat.
- ✓ If the head restraint of the child seat cannot be fully extended when it is installed in the

vehicle, this will result in restrictions on the maximum size setting for child restraint systems in weight category II or III.

Contact with the roof when the head restraint is fully extended and locked in place will not result in any restrictions on use.

- ☑ The child restraint system must not be put under strain between the roof and the seat cushion and/or be installed facing the wrong direction.
- ☑ The child restraint system must not be put under strain by the head restraint. Adjust the head restraints as appropriate.
- ☑ Never place objects (e.g. cushions) under or behind the child restraint system.

The seat belt on the front passenger side is equipped with a special seat belt retractor.

When enabled, the special seat belt retractor ensures that the seat belt does not slacken once the child seat is secured (→ page 54).

- ▶ Set the front passenger seat as far back as possible and move the seat into the highest position if possible.
- ▶ Fully retract the seat cushion length adjustment.
- ▶ Adjust the seat cushion inclination so that the front edge of the seat cushion is in the highest position and the back edge of the seat cushion is in the lowest position.
- ▶ Set the seat backrest to the most vertical position possible.
- ▶ Install the child restraint system. The entire base of the child restraint system must always rest on the sitting surface of the front passenger seat.
- ▶ Always make sure that the shoulder belt strap is correctly routed from the seat belt outlet of the vehicle to the shoulder belt guide on the child restraint system. The shoulder belt strap must be routed forwards and downwards from the seat belt outlet.
- ▶ If necessary, adjust the seat belt outlet and the front passenger seat accordingly.

Child safety locks

Activating or deactivating the child safety lock for the rear doors

⚠ WARNING Risk of accident and injury due to children left unattended in the vehicle

If children are left unsupervised in the vehicle, they could, in particular:

- Open doors, thereby endangering other persons or road users.
- Get out and be struck by oncoming traffic.
- Operate vehicle equipment and become trapped, for example.

In addition, the children could also set the vehicle in motion, for example by:

- Releasing the parking brake.
- Changing the transmission position.
- Starting the vehicle.

- ▶ Never leave children unattended in the vehicle.
- ▶ When leaving the vehicle, always take the SmartKey with you and lock the vehicle.
- ▶ Keep the vehicle SmartKey out of reach of children.

⚠ WARNING Danger to life due to exposure to extreme heat or cold in the vehicle

If people, particularly children, are exposed to extreme temperatures over an extended period of time, there is a risk of serious injury or danger to life.

- ▶ Never leave persons, children in particular, unattended in the vehicle.

⚠ WARNING Risk of accident and injury due to children left unattended in the vehicle

If children are traveling in the vehicle, they could, in particular:

- Open doors, thereby endangering other persons or road users.
 - Get out and be struck by oncoming traffic.
 - Operate vehicle equipment and become trapped, for example.
- ▶ Always activate the installed child safety locks if children are traveling in the vehicle.
 - ▶ Never leave children unattended in the vehicle.
 - ▶ When leaving the vehicle, always take the SmartKey with you and lock the vehicle.

There are child safety locks for the rear doors and the rear passenger compartment side windows.

The child safety lock on the rear doors secures each door separately. The doors can no longer be opened from the inside.

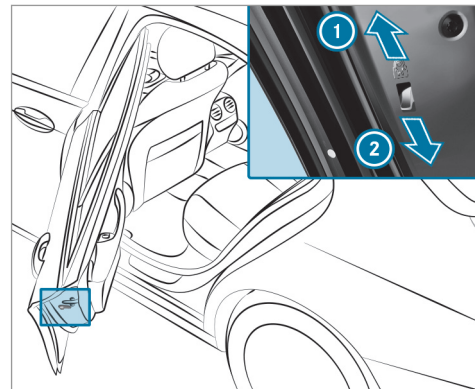

- ▶ Press the lever in direction ① (activate) or ② (deactivate).
- ▶ Make sure that the child safety locks are working properly.

Activating or deactivating the child safety lock for the rear side windows

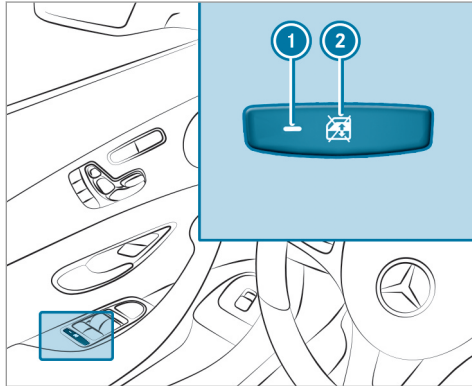

- ▶ **To activate/deactivate:** press button ②.
- The rear side window can be opened or closed in the following cases:
- Indicator lamp ① is lit: via the switch on the driver's door

- Indicator lamp ① is off: via the switch on the corresponding rear door or driver's door

Notes on pets in the vehicle

⚠ WARNING Risk of accident and injury due to animals left unsecured or unattended in the vehicle

If you leave animals in the vehicle unattended or unsecured, they could possibly press buttons or switches.

An animal may:

- Activate vehicle equipment and become trapped, for example
- Switch systems on or off and endanger other road users

Unsecured animals may be thrown around in the vehicle in the event of an accident or sudden steering and braking maneuvers and injure vehicle occupants in the process.

- ▶ Never leave animals in the vehicle unattended.
- ▶ Always correctly secure animals while driving, e.g. using a suitable animal carrier.

SmartKey

Overview of SmartKey functions

⚠ WARNING Risk of accident and injury due to children left unattended in the vehicle

If children are left unsupervised in the vehicle, they could, in particular:

- Open doors, thereby endangering other persons or road users.
- Get out and be struck by oncoming traffic.
- Operate vehicle equipment and become trapped, for example.

In addition, the children could also set the vehicle in motion, for example by:

- Releasing the parking brake.
- Changing the transmission position.
- Starting the vehicle.

▶ Never leave children unattended in the vehicle.

▶ When leaving the vehicle, always take the SmartKey with you and lock the vehicle.

▶ Keep the vehicle SmartKey out of reach of children.

! NOTE Damage to the SmartKey caused by magnetic fields

▶ Keep the SmartKey away from strong magnetic fields.

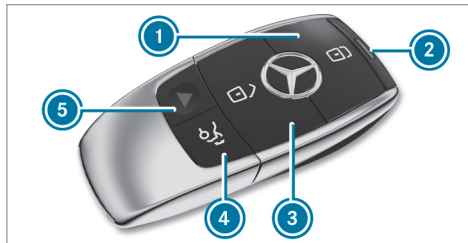

- ① Locks
- ② Indicator lamp

- ③ Unlocks
- ④ Opens/closes the trunk lid
- ⑤ Panic alarm

i If indicator lamp ② does not light up after pressing the or button, the battery is weak or possibly discharged. Replace the battery as soon as possible.

Replace the SmartKey battery (→ page 66).

The SmartKey locks and unlocks the following components:

- The doors
- The fuel filler flap
- The trunk lid

If the vehicle is not opened within approximately 40 seconds after unlocking, it locks again. Anti-theft protection is armed again.

Do not keep the SmartKey together with electronic devices or metal objects. This can affect the SmartKey's functionality.

Activating/deactivating the acoustic locking verification signal

Multimedia system:

→  » Settings » Vehicle

- ▶ Activate or deactivate **Acoustic Lock**.

Activating/deactivating the panic alarm

Requirements:

- The ignition is switched off.



- ▶ **To activate:** press button ① for approximately one second.
A visual and audible alarm is triggered.



- ▶ **To deactivate:** briefly press button ① again.
or

- ▶ Press the start/stop button on the cockpit, with the SmartKey inside the vehicle.

Changing the unlocking settings

Possible unlocking functions of the SmartKey:

- Central unlocking
- Unlocking the driver's door and fuel filler flap

- ▶ **To switch between settings:** press the  and  buttons simultaneously for approximately six seconds until the indicator lamp flashes twice.

Options if the unlocking function for the driver's door and fuel filler flap has been selected:

- **To unlock the vehicle centrally:** press the  button twice.
- **Vehicles with KEYLESS-GO:** if you touch the inner surface of the door handle on the driver's door, only the driver's door and fuel filler flap are unlocked.

Deactivating the SmartKey functions

If you do not use the vehicle or a SmartKey for an extended period of time, you can reduce the energy consumption of the respective SmartKey. To do so, deactivate the SmartKey functions.

- ▶ **To deactivate:** press the  button on the SmartKey twice in quick succession. The SmartKey indicator lamp flashes twice briefly and lights up once.
- ▶ **To activate:** press any button on the SmartKey.

- ① When the vehicle is started with the SmartKey in the storage compartment of the center console, the SmartKey functions are automatically activated (→ page 135).

Removing/inserting the emergency key

Removing the emergency key

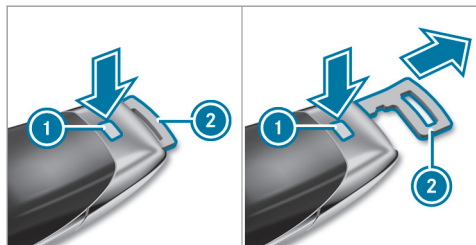

- ▶ Press release knob ①. Emergency key ② is pushed out slightly.
- ▶ Pull out emergency key ② until it engages in the intermediate position.
- ▶ Press release knob ① again and fully remove emergency key ②.

Inserting the emergency key

- ▶ Press release knob ①.
- ▶ Insert emergency key ② to the intermediate position or fully until it engages.

- ① You can use the intermediate position of emergency key ② to attach the SmartKey to a key ring.

Replacing the SmartKey battery

⚠ DANGER Serious damage to health caused by swallowing batteries

Batteries contain toxic and corrosive substances. Swallowing batteries may cause serious damage to health.

There is a risk of fatal injury.

- ▶ Keep batteries out of the reach of children.
- ▶ If batteries are swallowed, seek medical attention immediately.

🔥 ENVIRONMENTAL NOTE Environmental damage due to improper disposal of batteries



Batteries contain pollutants. It is illegal to dispose of them with the household rubbish.



Dispose of batteries in an environmentally responsible manner. Take discharged batteries to a qualified specialist workshop or to a collection point for used batteries.

Requirements:

- You require a CR 2032 3 V cell battery.

Mercedes-Benz recommends that you have the battery replaced at a qualified specialist workshop.

- ▶ Remove the emergency key (→ page 66).

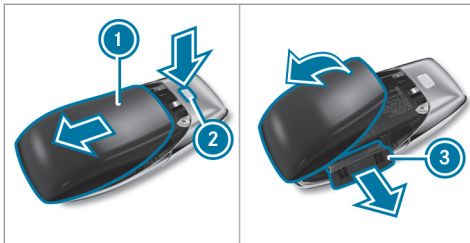

- ▶ Press release knob ② down fully and slide cover ① in the direction of the arrow.
- ▶ Fold out cover ① in the direction of the arrow and remove.
- ▶ Remove battery compartment ③ and take out the discharged battery.
- ▶ Insert the new battery into battery compartment ③. Observe the positive pole marking in the battery compartment and on the battery when doing this.
- ▶ Push in battery compartment ③.

- ▶ Re-attach cover ① and push it until it engages.

Problems with the SmartKey

You can no longer lock or unlock the vehicle

Possible causes:

- The SmartKey battery is weak or discharged.
 - The SmartKey is faulty.
- ▶ Check the battery using the indicator lamp (→ page 64).
 - ▶ Replace the SmartKey battery, if necessary (→ page 66).
 - ▶ Use the emergency key to lock or unlock (→ page 70).
 - ▶ Have the SmartKey checked at a qualified specialist workshop.

There is interference from a powerful radio signal source

The key function is impaired by, for example:

- High voltage power lines
- Mobile phones

- Electronic devices (notebooks, tablets)
- Shielding due to metal objects or induction loops for electrical gate systems or automatic barriers

- ▶ Make sure that there is a sufficient distance between the SmartKey and the potential source of interference.

You have lost a SmartKey

- ▶ Have the SmartKey deactivated at a qualified specialist workshop.
- ▶ If necessary, have the mechanical lock replaced as well.

Doors

Unlocking/opening the doors from the inside

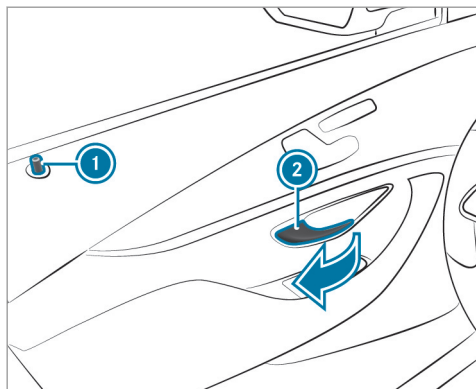

- ▶ **To unlock and open a front door:** pull door handle ②. Locking pin ① pops up when the door is unlocked.

- ▶ **To unlock a rear door:** pull the rear door handle. The locking pin pops up when the rear door is unlocked.
- ▶ **To open a rear door:** pull the rear door handle again.

Centrally locking and unlocking the vehicle from the inside

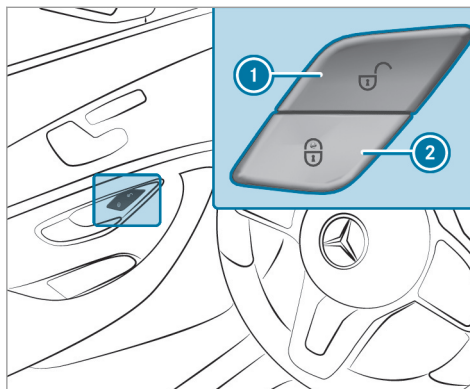

- ▶ **To unlock:** press button ①.
- ▶ **To lock:** press button ②.

This does not lock or unlock the fuel filler flap.

The vehicle is not unlocked:

- If you have locked the vehicle using the SmartKey.
- If you have locked the vehicle using KEY-LESS-GO.

Locking/unlocking the vehicle with KEY-LESS-GO

Requirements:

- The SmartKey is outside the vehicle.
- The distance between the SmartKey and the vehicle does not exceed 3 ft (1 m).
- The driver's door and the door at which the door handle is used are closed.

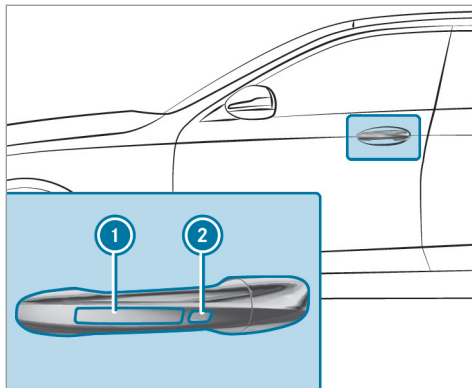

- ▶ **To unlock the vehicle:** touch the inner surface of the door handle.
- ▶ **To lock the vehicle:** touch sensor surface ① or ②.
- ▶ **Convenience closing:** touch recessed sensor surface ② until the closing process has been completed.

ⓘ Further information on convenience closing (→ page 79).

If you open the trunk lid from outside, the trunk lid is automatically unlocked.

Problems with KEYLESS-GO

You can no longer lock or unlock the vehicle using KEYLESS-GO.

Possible causes:

- The SmartKey functions have been deactivated.
 - The SmartKey battery is weak or discharged.
 - The SmartKey is faulty.
- ▶ Activate the key functions (→ page 65).
 - ▶ Check the battery using the indicator lamp (→ page 64).
 - ▶ Replace the SmartKey battery, if necessary (→ page 66).
 - ▶ Use the emergency key to lock or unlock (→ page 70).
 - ▶ Have the vehicle and SmartKey checked at a qualified specialist workshop.

There is interference from a powerful radio signal source

The KEYLESS-GO function is impaired by, for example:

- High voltage power lines
- Mobile phones
- Electronic devices (notebooks, tablets)
- Shielding due to metal objects or induction loops for electrical gate systems or automatic barriers

▶ Make sure that there is a sufficient distance between the SmartKey and the potential source of interference.

Activating/deactivating the automatic locking feature

The vehicle is locked automatically when the ignition is switched on and the wheels are turning faster than walking pace.

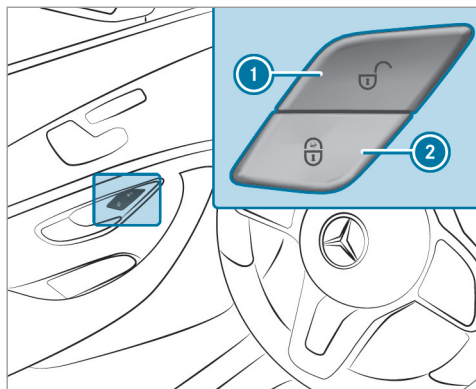

- ▶ **To activate:** press and hold button ② for approximately five seconds until an acoustic signal sounds.
- ▶ **To deactivate:** press and hold button ① for approximately five seconds until an acoustic signal sounds.

In the following situations, there is a danger of being locked out when the function is activated:

- While the vehicle is being tow started/ pushed.
- If the vehicle is being tested on a roller dynamometer.

Power closing function

⚠ WARNING Risk of becoming trapped when the doors close automatically

Body parts or objects can become trapped, causing injuries.

- ▶ Ensure that no body parts or objects are in the closing area.
- ▶ Automatic closing of the doors can be canceled by pulling the outer or inner door handle.

If you push the door into the lock to the first detent position, the power closing function will automatically pull the door into the lock.

Locking/unlocking the driver's door with the emergency key

- ① If you wish to lock the vehicle entirely using the emergency key, first press the button for locking from the inside while the driver's door is open. Then proceed to lock the driver's door using the emergency key.

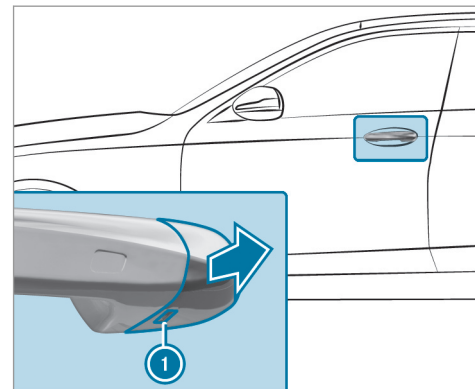

- ▶ Remove the emergency key (→ page 66).

- ▶ Insert the emergency key as far as it will go into opening ① in the cover.
- ▶ Pull and hold the door handle.
- ▶ Pull the cover on the emergency key as straight as possible away from the vehicle until it releases.
- ▶ Release the door handle.

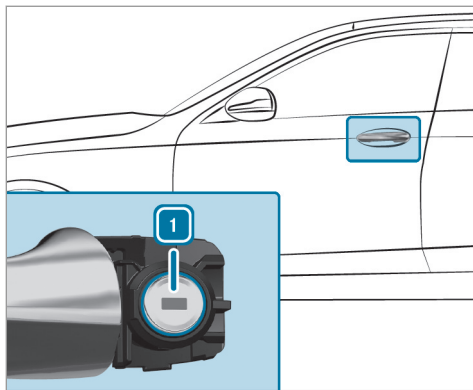

- ▶ **To unlock:** turn the emergency key counter-clockwise to position ①.
- ▶ **To lock:** turn the emergency key clockwise to position ①.
- ▶ Carefully press the cover onto the lock cylinder until it engages and is seated firmly.

Trunk

Opening the trunk lid

⚠ DANGER Risk of exhaust gas poisoning

Combustion engines emit poisonous exhaust gases such as carbon monoxide. Exhaust gases can enter the vehicle interior if the trunk lid is open when the engine is running, especially if the vehicle is in motion.

- ▶ Always switch off the engine before opening the trunk lid.
- ▶ Never drive with the trunk lid open.

! **NOTE** Damage to the trunk lid by obstacles above the vehicle

The trunk lid swings upwards when it is opened.

- ▶ Therefore, make sure that there is sufficient clearance above the trunk lid.

- ▶ With the trunk lid unlocked, press the top of the Mercedes star.

① To open, pull on the folded-out Mercedes star when the rear view camera is activated.

- ▶ **Vehicles with HANDS-FREE ACCESS:** Make a kicking movement with your foot below the bumper (→ page 74).

Vehicles with trunk lid convenience closing

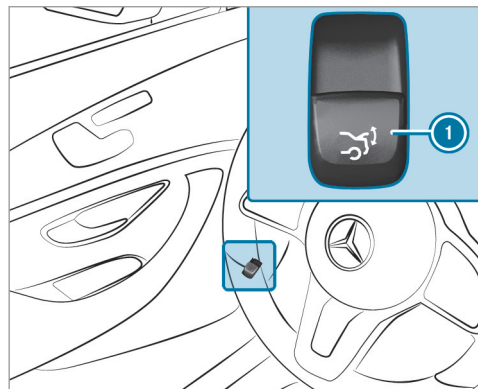

- ▶ Pull trunk lid remote operating switch ①.
- ▶ Press and hold the  button on the SmartKey.

- ▶ If the trunk lid is stopped in an intermediate position, pull it upwards. Release it as soon as it begins to open. With the trunk lid opening height restriction activated, manually pull the stopped trunk lid upwards.

If an obstacle obstructs the trunk lid during the automatic opening process, blockage detection will stop the trunk lid. The automatic blockage detection function is only an aid and is not a substitute for your attentiveness.

Closing the trunk lid

⚠ WARNING Risk of injury from unsecured items in the vehicle

If objects, luggage or loads are not secured or not secured sufficiently, they could slip, tip over or be thrown around and thereby hit vehicle occupants.

There is a risk of injury, particularly in the event of sudden braking or a sudden change in direction.

- ▶ Always stow objects in such a way that they cannot be thrown around.
- ▶ Before the journey, secure objects, luggage or loads against slipping or tipping over.

Observe the notes on loading the vehicle.

- ▶ Pull the trunk lid downwards using the handle recess and push it closed.

Vehicles with trunk lid convenience closing

⚠ WARNING Risk of becoming trapped during automatic closing of the trunk lid

Parts of the body could become trapped. There may be people in the closing area.

- ▶ Make sure that nothing is located within the vicinity of the closing area.
- ▶ Use one of the following options to stop the closing process:
 - Press the  button on the SmartKey.
 - Press or pull the remote operating switch on the driver's door.

- Press the closing or locking button on the trunk lid.
- Press the top of the star on the trunk lid.

- ▶ **Vehicles with HANDS-FREE ACCESS:** it is also possible to stop the closing process by making a kicking movement below the rear bumper.
- ▶ Pull the trunk lid downwards using the handle recess and push it closed.
- ▶ If the trunk lid is stopped in an intermediate position, push it downwards. The trunk lid will continue to close.

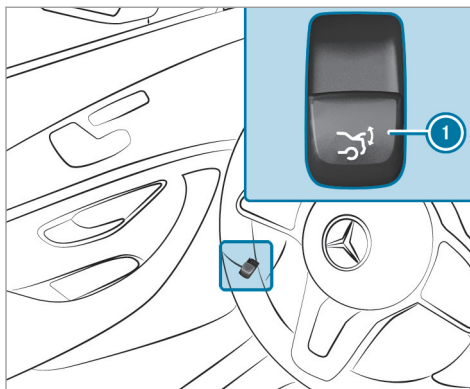

- ▶ Press trunk lid remote operating switch ①.

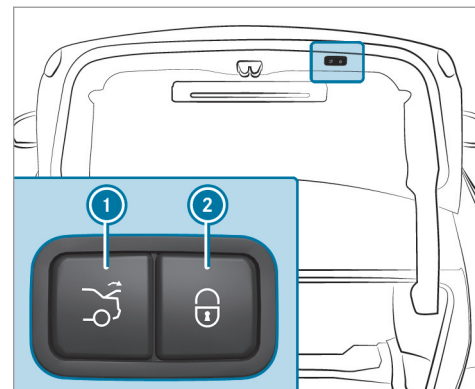

- ▶ Press closing button ① on the trunk lid.

Vehicles with KEYLESS-GO

- ▶ Press locking button ② on the trunk lid. If a SmartKey is detected outside the vehicle, the trunk lid will close and the vehicle will be locked.
- ▶ With the trunk lid completely open, press and hold the  button on the SmartKey. The

SmartKey must be in the vicinity of the vehicle.

Vehicles with HANDS-FREE ACCESS

▶ With the trunk lid completely opened, make a kicking movement with your foot below the bumper (→ page 74).

Trunk lid automatic reversing function

The trunk lid is equipped with automatic blockage detection with a reversing function. If an obstacle stops the trunk lid during the automatic closing procedure, it will automatically open again. The automatic reversing function is only an aid and is not a substitute for your attentiveness.

▶ During the closing process, make sure that no body parts are in the closing area.

⚠ WARNING Risk of becoming trapped despite reversing function

The reversing function will not react:

- to soft, light and thin objects, e.g. fingers
- towards the end of the closing procedure

In these situations in particular, the reversing function cannot prevent someone being trapped.

▶ Ensure that no body parts are in the closing area.
▶ If someone is trapped, use one of the following options:

- Press the  button on the SmartKey.
- Press the remote operating switch on the driver's door.
- Press the closing or locking button on the trunk lid.
- Press the top of the Mercedes star on the trunk lid.

HANDS-FREE ACCESS function

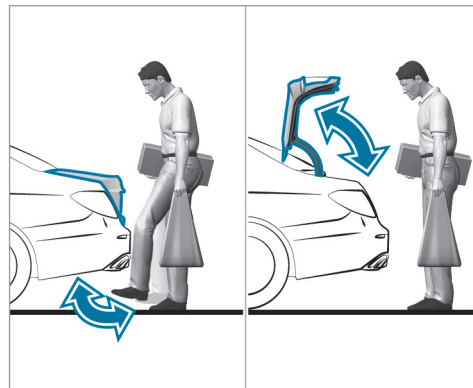

With HANDS-FREE ACCESS you can open, close or interrupt trunk lid movement by performing a kicking movement under the rear bumper.

The kicking movement triggers the opening or closing process alternately.

Observe the notes when opening (→ page 71) and closing (→ page 72) the trunk lid.

- i** A warning tone sounds while the trunk lid is opening or closing.

⚠ WARNING Risk of burns caused by a hot exhaust system

The vehicle exhaust system can become very hot. If you use HANDS-FREE ACCESS, you could burn yourself by touching the exhaust system.

- ▶ Always ensure that you only make a kicking movement within the detection range of the sensors.

! NOTE Damage to the vehicle caused by unintentionally opening the trunk lid

- When using an automatic car wash
- When using a high pressure cleaner
- ▶ Deactivate KEYLESS-GO or make sure that the SmartKey located is at least 10 ft (3 m) away from the vehicle in such situations.

When making the kicking movement, make sure that you are standing firmly on the ground. You could otherwise lose your balance, e.g. on ice.

Observe the following notes:

- The SmartKey is behind the vehicle.
- Stand at least 12 in (30 cm) away from the vehicle while performing the kicking movement.
- Do not come into contact with the bumper while making the kicking movement.
- Do not carry out the kicking movement too slowly.
- The kicking movement must be towards the vehicle and back again.

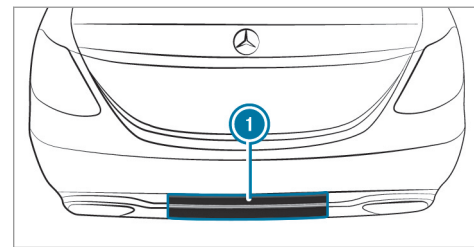

1 Detection range of the sensors

If several consecutive kicking movements are not successful, wait ten seconds.

System limits

The system may be impaired or may not function in the following cases:

- The sensors are dirty, e.g. due to road salt or snow.
- The kicking movement is made using a prosthetic leg.

76 Opening and closing

The trunk lid could be opened or closed unintentionally, in the following situations:

- A person's arms or legs are moving in the sensor detection range, e.g. when polishing the vehicle or picking up objects.
- Objects are moved or placed behind the vehicle, e.g. tensioning straps or luggage.
- Clamping straps, tarps or other coverings are pulled over the bumper.
- A protective mat with a length reaching over the trunk sill down into the detection range of the sensors is used.
- The protective mat is not secured correctly.

Deactivate the SmartKey functions (→ page 65) or do not carry the SmartKey about your person in such situations.

Switching separate trunk locking on or off

If you centrally unlock the vehicle while separate locking is activated, the trunk will remain locked.

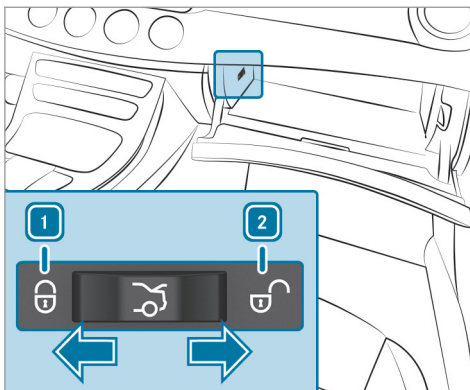

▶ **To switch on:** slide the switch to position **1**.

▶ **To switch off:** slide the switch to position **2**.

ⓘ If an accident has been detected, the trunk will unlock even if separate locking is switched on.

Unlocking and opening the trunk from inside with the emergency release

Requirements:

- The 12 V vehicle battery is connected and charged.

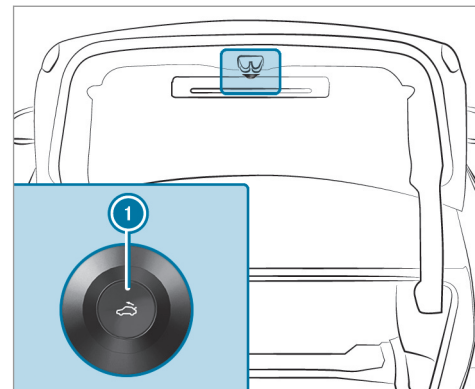

▶ Press emergency release button **1** briefly.

Side windows

Opening and closing the side windows

⚠ WARNING Risk of entrapment when opening a side window

When opening a side window, parts of the body could be drawn in or become trapped between the side window and window frame.

- ▶ When opening, make sure that nobody is touching the side window.
- ▶ If someone is trapped, release the button immediately or pull it in order to close the side window again.

⚠ WARNING Risk of becoming trapped when closing a side window

When closing a side window, body parts could be trapped in the closing area in the process.

- ▶ When closing, make sure that no body parts are in the closing area.

- ▶ If someone is trapped, release the button immediately or press the button in order to reopen the side window.

⚠ WARNING Risk of becoming trapped when children operate the side windows

Children could become trapped if they operate the side windows, particularly when unattended.

- ▶ Activate the child safety lock for the rear passenger compartment side windows.
- ▶ When leaving the vehicle, always take the SmartKey with you and lock the vehicle.
- ▶ Never leave children unattended in the vehicle.

Requirements:

- The power supply or the ignition is switched on.

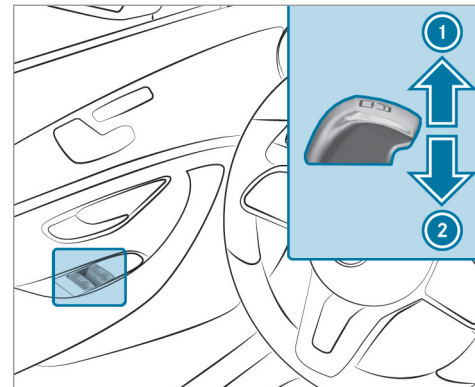

- ① To close
- ② To open

The buttons on the driver's door take precedence.

- ▶ **To start automatic operation:** press the  button beyond the point of resistance or pull and release it.

- ▶ **To interrupt automatic operation:** press or pull the  button again.

When the vehicle is switched off, you can continue to operate the side windows.

This function is available for around four minutes or until a front door is opened.

Automatic reversing function of the side windows

If an obstacle impedes a side window during the closing process, the side window will open again automatically. The automatic reversing function is only an aid and is not a substitute for your attentiveness.

- ▶ During the closing process, make sure that no body parts are in the closing area.

⚠ WARNING Risk of becoming trapped despite there being reversing protection on the side window

The reversing function does not react:

- To soft, light and thin objects, e.g. fingers.

- During resetting.

The reversing function cannot prevent someone from becoming trapped in these situations.

- ▶ During the closing process, make sure that no body parts are in the closing area.
- ▶ If someone becomes trapped, press the  button to open the side window again.

Convenience opening (ventilating the vehicle before starting a journey)

⚠ WARNING Risk of entrapment when opening a side window

When opening a side window, parts of the body could be drawn in or become trapped between the side window and window frame.

- ▶ When opening, make sure that nobody is touching the side window.

- ▶ Release the button immediately if somebody becomes trapped.

- ▶ Press and hold the  button on the SmartKey.

The following functions are performed:

- The vehicle is unlocked.
- The side windows are opened.
- The sliding sunroof is opened.
- The seat ventilation of the driver's seat is switched on.

- ▶ **To interrupt convenience opening:** release the  button.

- ▶ **To continue convenience opening:** press and hold the  button again.

Convenience closing (closing the vehicle from outside)

⚠ WARNING Risk of entrapment due to not paying attention during convenience closing

When the convenience closing feature is operating, parts of the body could become trapped in the closing area of the side window and the sliding sunroof.

▶ When the convenience closing feature is operating, monitor the entire closing process and make sure that no body parts are in the closing area.

▶ Press and hold the  button on the SmartKey.

The following functions are performed:

- The vehicle is locked.
- The side windows are closed.
- The sliding sunroof is closed.

▶ **To interrupt convenience closing:** release the  button.

ⓘ Convenience closing also functions with KEYLESS-GO (→ page 68).

Problems with the side windows

⚠ WARNING Risk of becoming trapped or fatally injured if reversing protection is not activated

If you close a side window again immediately after it has been blocked, the side window will close with increased or maximum force. The reversing function is then not active and body parts may become trapped.

- ▶ Make sure that no parts of the body are in the closing area.
- ▶ To stop the closing process, release the button or press the button again to reopen the side window.

A side window cannot be closed and you cannot see the cause.

▶ Check to see whether any objects are in the window guide.

▶ Adjust the side windows.

Adjusting the side windows

If a side window is obstructed during closing and reopens again immediately:

▶ Immediately after this, pull and hold the corresponding button again until the side window has closed and hold the button for at least one more second (re-adjustment). The side window will be closed without the automatic reversing function.

If the side window is obstructed again and reopens again immediately:

▶ Immediately after this, pull and hold the corresponding button again until the side window has closed and hold the button for at least one more second (follow-up adjustment). The side window will be closed without the automatic reversing function.

The side windows cannot be opened or closed using the convenience opening feature.

Possible cause:

- The SmartKey battery is weak or discharged.
- ▶ Check the battery using the indicator lamp (→ page 64).
 - ▶ Replace the SmartKey battery, if necessary (→ page 66).

Sliding sunroof

Opening and closing the sliding sunroof

⚠ WARNING Risk of becoming trapped when the sliding sunroof is being opened and closed

Body parts may become trapped in the range of movement.

- ▶ During opening and closing, make sure that no body parts are in the range of movement.

- ▶ Release the button immediately if somebody becomes trapped.

or

- ▶ Briefly press the button in any direction during automatic operation. The opening or closing process will be stopped.

⚠ WARNING Risk of becoming trapped if the sliding sunroof is operated by children

Children operating the sliding sunroof could get caught in the moving parts, particularly if unattended.

- ▶ Never leave children unattended in the vehicle.
- ▶ When leaving the vehicle, always take the key with you and lock the vehicle.

! NOTE Malfunction due to snow and ice

Snow and ice may cause the sliding sunroof to malfunction.

- ▶ Open the sliding sunroof only if it is free of snow and ice.

! NOTE Damage caused by protruding objects

Objects that protrude from the sliding sunroof may damage the sealing strips.

- ▶ Do not allow anything to protrude from the sliding sunroof.

! NOTE Important points to remember when a roof luggage rack is installed

When a roof luggage rack is installed, raising or opening the sliding sunroof may be limited.

- ▶ Check whether the sliding sunroof can be raised or opened when a roof luggage rack is installed.
- ▶ If in doubt, do not raise or open the sliding sunroof.

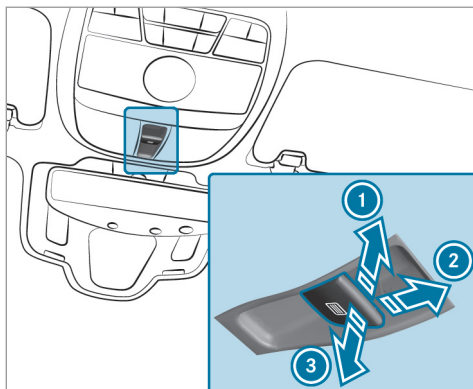

- ① To raise
- ② To open
- ③ To close/lower

▶ **To start automatic operation:** press the  button beyond the point of resistance or pull and release it.

▶ **To interrupt automatic operation:** briefly press the  button in any direction. The opening/closing process will be stopped.

Vehicles without a panorama roof with power tilt/sliding panel: The automatic opening and raising features are available only when the sliding sunroof is closed.

Automatic reversing function of the sliding sunroof

If an obstacle obstructs the sliding sunroof during the closing process, the sliding sunroof will open again automatically. The automatic reversing function is only an aid and is not a substitute for your attentiveness.

▶ During the closing process, make sure that no body parts are in the closing area.

⚠ WARNING Risk of becoming trapped despite the reversing function being active

In particular, the reversing function does not react:

- To soft, light and thin objects, e.g. fingers.
- Towards the end of the closing procedure.
- During resetting.

▶ During the closing process, make sure that no body parts are in the closing area.

▶ Release the button immediately if somebody becomes trapped.

or

▶ Briefly press the button in any direction during automatic operation. The closing process will be stopped.

Problems with the sliding sunroof

⚠ WARNING Risk of becoming trapped or fatal injuries when the sliding sunroof is closed again

If the sliding sunroof is closed again immediately after it has been blocked or reset, it will close with increased force.

- ▶ Make sure that no parts of the body are in the closing area.
- ▶ Release the button immediately if somebody becomes trapped.

or

- ▶ Briefly press the button in any direction during the automatic closing process. The closing process will be stopped.

The sliding sunroof cannot be closed and you cannot see the cause.

If the sliding sunroof is obstructed during closing and reopens again slightly:

- ▶ Immediately after automatic reversing, pull and hold the  button down again to the

point of resistance until the sliding sunroof is closed. The sliding sunroof will be closed with increased force.



If the sliding sunroof is obstructed again and reopens again slightly:

- ▶ Repeat the previous step. The sliding sunroof will be closed again with increased force.

Vehicles without a panorama roof with power tilt/sliding panel: The sliding sunroof is not operating smoothly.

- ▶ Reset the sliding sunroof.

Resetting the sliding sunroof

- ▶ Push the  button up to the point of resistance repeatedly until the sliding sunroof is fully open.
- ▶ Press the  button for another second.
- ▶ Close the sliding sunroof.

Roller sun blinds

Extending or retracting the rear-window roller sunblind

⚠ WARNING Risk of becoming trapped when extending or retracting the roller sunblind

Body parts may become trapped in the roller sunblind's range of movement.

- ▶ Ensure there are no body parts in the range of movement.
- ▶ If someone becomes trapped, briefly press the button again. The opening or closing process will briefly be stopped. The roller sunblind will then return to its starting position.

! NOTE Damage caused by objects

Objects may cause the roller sunblind to malfunction.

- ▶ Do not store any objects on the parcel shelf.

- ▶ Make sure that the roller sunblind can move freely.

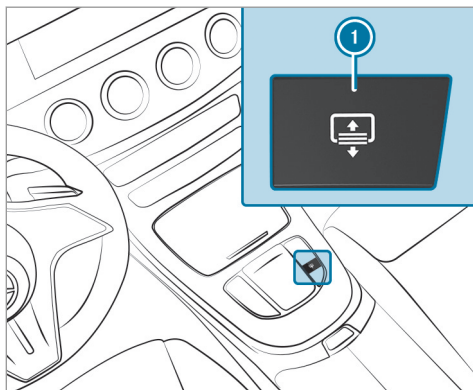

- ▶ **To extend or retract:** press button ①.

Anti-theft protection

Function of the immobilizer

The immobilizer prevents your vehicle from being started without the correct SmartKey.

The immobilizer is automatically activated when the ignition is switched off and deactivated when the ignition is switched on.

When leaving the vehicle, always take the SmartKey with you and lock the vehicle. Anyone can start the engine if a valid SmartKey has been left inside the vehicle.

- ① In the event the engine cannot be started (yet the vehicle's battery is charged), the system is not operational. Contact an authorized Mercedes-Benz Center or call 1-800-FOR-MERCEDES (in the USA) or 1-800-387-0100 (in Canada).

ATA (anti-theft alarm system)

Function of the ATA system

If the ATA system is armed, a visual and audible alarm is triggered in the following situations:

- When a door is opened
- When the trunk lid is opened
- When the hood is opened
- When the interior motion sensor is triggered (→ page 85)
- When the tow-away alarm is triggered (→ page 84)

The ATA system is armed automatically after approximately ten seconds in the following situations:

- After locking the vehicle with the SmartKey
- After locking the vehicle using KEYLESS-GO

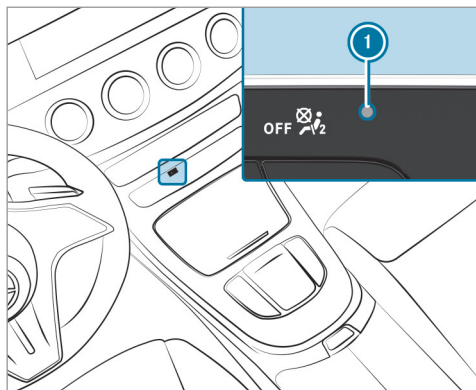

Indicator lamp ① flashes when the ATA system is armed.

The ATA system is deactivated automatically in the following situations:

- After unlocking the vehicle with the SmartKey
- After unlocking the vehicle using KEYLESS-GO

- After pressing the start/stop button with the SmartKey in the storage compartment (→ page 135)

① When the Mercedes-Benz emergency call system is active and the alarm stays on for more than 30 seconds, a message is automatically sent to the Customer Assistance Center (→ page 252).

① In the case of severe battery discharging, the anti-theft alarm system is automatically deactivated to facilitate the next engine start.

Deactivating the ATA

▶ Press the ,  or  button on the SmartKey.

or

▶ Press the start/stop button with the SmartKey in the marked space (→ page 135)

Deactivating the alarm using KEYLESS-GO

▶ Grasp the outside door handle with the SmartKey outside the vehicle.

Function of the tow-away alarm

① This function may not be available in all countries.

An audible and visual alarm is triggered if an alteration to your vehicle's angle of inclination is detected while the tow-away alarm is armed.



The tow-away alarm is automatically armed after approximately 60 seconds:

- After locking the vehicle with the SmartKey
- After locking the vehicle using KEYLESS-GO

The tow-away alarm is only armed when the following components are closed:

- The doors
- The trunk lid

The tow-away alarm is automatically deactivated:

- After pressing the  or  button on the SmartKey
- After pressing the start/stop button with the SmartKey in the storage compartment (→ page 135)

- After unlocking the vehicle using KEYLESS-GO
- When using HANDS-FREE ACCESS

Information on collision detection on a parked vehicle (→ page 160).

Arming/disarming the tow-away alarm

Multimedia system:

→  » Settings » Quick Access

▶ Arm or disarm **Tow-away Protection**.

The tow-away alarm is armed again in the following cases:

- The vehicle is unlocked again.
- A door is opened.
- The vehicle is locked again.

i If quick access is unavailable, select the **Vehicle** submenu in the **Settings** main menu to arm or disarm the tow-away alarm.

Function of the interior motion sensor

i This function may not be available in all countries.

When the interior motion sensor is activated, a visual and audible alarm is triggered if movement is detected in the vehicle interior.



The interior motion sensor is activated automatically after approximately ten seconds:

- After locking the vehicle with the SmartKey
- After locking the vehicle using KEYLESS-GO

The interior motion sensor is only activated when the following components are closed:

- The doors
- The trunk lid

The interior motion sensor is automatically deactivated:

- After pressing the  or  button on the SmartKey
- After pressing the start/stop button with the SmartKey in the storage compartment (→ page 135)

- After unlocking the vehicle using KEYLESS-GO
- When using HANDS-FREE ACCESS

The following situations can lead to a false alarm:

- Moving objects such as mascots in the vehicle interior
- When the side window is open
- When the sliding sunroof is open

Arming/deactivating the interior motion sensor

Multimedia system:

→  » Settings » Quick Access

▶ Activate or deactivate **Interior Motion Sensor**.

The interior motion sensor is activated again in the following cases:

- The vehicle is unlocked again.
- A door is opened.
- The vehicle is locked again.

86 Opening and closing

- ① If quick access is unavailable, select the **Vehicle** menu under **Settings** to activate or deactivate the interior motion sensor.

Notes on the correct driver's seat position

⚠ WARNING Risk of accident due to adjusting vehicle settings while the vehicle is in motion

You could lose control of the vehicle in the following situations in particular:

- If you adjust the driver's seat, the head restraints, the steering wheel or the mirror while the vehicle is in motion.
- If you fasten your seat belt while the vehicle is in motion.

▶ Before starting the engine: adjust the driver's seat, the head restraints, the steering wheel and the mirror and fasten your seat belt.

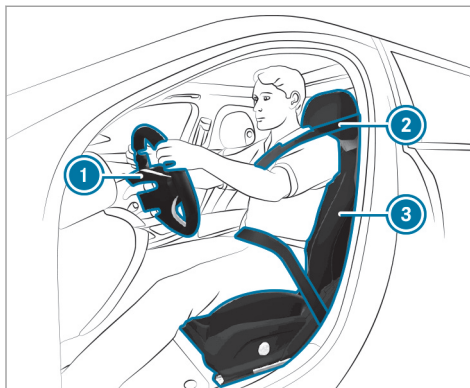

Ensure the following when adjusting steering wheel ①, seat belt ② and driver's seat ③:

- You are sitting as far away from the driver's airbag as possible, taking the following points into consideration.
- You are sitting in an upright position
- Your thighs are slightly supported by the seat cushion

- Your legs are not fully extended and you can depress the pedals properly
- The back of your head is supported at eye level by the center of the head restraint
- You can hold the steering wheel with your arms slightly bent
- You can move your legs freely
- You can see all the displays on the instrument cluster clearly
- You have a good overview of the traffic conditions
- Your seat belt sits snugly against your body and passes across the center of your shoulder and across your hips in the pelvic area

Seats

Adjusting the front seat mechanically and electrically

⚠ WARNING Risk of becoming trapped if the seats are adjusted by children

Children could become trapped if they adjust the seats, particularly when unattended.

- ▶ When leaving the vehicle, always take the SmartKey with you and lock the vehicle.
- ▶ Never leave children unattended in the vehicle.

You can adjust the seats when the ignition is switched off.

⚠ WARNING Risk of becoming trapped when adjusting the seat

When you adjust a seat, you or other vehicle occupants could become trapped, e.g. on the seat guide rail.

- ▶ When adjusting a seat, make sure that no one has any part of their body within the sweep of the seat.

Observe the safety notes on "Airbags" and "Children in the vehicle".

⚠ WARNING Risk of accident due to the driver's seat not being engaged

The driver's seat may move unexpectedly while driving.

This could cause you to lose control of the vehicle.

- ▶ Always make sure that the driver's seat is engaged before starting the vehicle.

⚠ WARNING Risk of becoming trapped if the seat height is adjusted carelessly

If you adjust the seat height carelessly, you or other vehicle occupants could be trapped and thereby injured.

Children in particular could accidentally press the electrical seat adjustment buttons and become trapped.

- ▶ While moving the seats, make sure that hands or other body parts do not get under the lever assembly of the seat adjustment system.

⚠ WARNING Risk of injury due to head restraints not being installed or being adjusted incorrectly

If head restraints have not been installed or have not been adjusted correctly, there is an increased risk of injury in the head and neck area, e.g. in the event of an accident or when braking.

- ▶ Always drive with the head restraints installed.
- ▶ Before driving off, make sure for every vehicle occupant that the center of the head restraint supports the back of the head at about eye level.

Do not interchange the head restraints of the front and rear seats. Otherwise, you will not be able to adjust the height and angle of the head restraints correctly.

Adjust the head restraint fore-and-aft position so that it is as close as possible to the back of your head.

⚠ WARNING Risk of injury or death due to an incorrect seat position

The seat belt does not offer the intended level of protection if you have not moved the seat backrest to an almost vertical position.

You could slip beneath the seat belt and injure yourself.

- ▶ Adjust the seat properly before commencing your journey.
- ▶ Always ensure that the seat backrest is in an almost vertical position and that the shoulder belt is routed across the center of your shoulder.

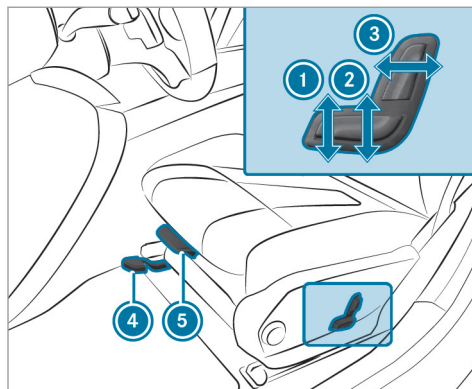

- ① Seat cushion inclination
- ② Seat height
- ③ Seat backrest inclination
- ④ Seat fore-and-aft position
- ⑤ Seat cushion length

▶ **To adjust the seat fore-and-aft position:** lift lever ④ and slide the seat into the desired position.

▶ Make sure that the seat is engaged.

▶ **To adjust the seat cushion length:** lift lever ⑤ and slide the front section of the seat cushion forwards or backwards.

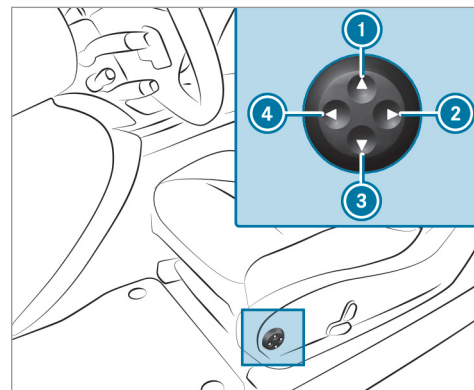

- ① Higher
- ② Softer
- ③ Lower
- ④ Firmer

▶ **To adjust the 4-way lumbar support:** using buttons ① to ④, adjust the contour of the backrest individually to suit your back.

Adjusting the front seat electrically

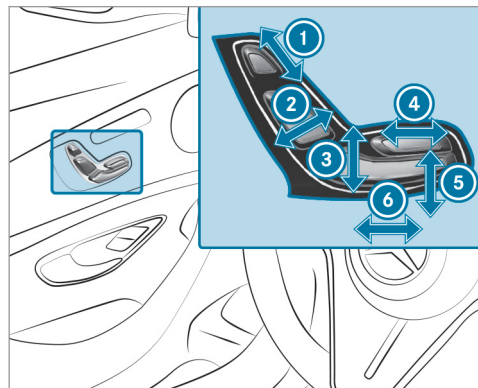

- ① Head restraint height
- ② Seat backrest inclination
- ③ Seat height

- ④ Seat cushion length
- ⑤ Seat cushion inclination
- ⑥ Seat fore-and-aft position

▶ Save the settings with the memory function (→ page 100).

Head restraints

Adjusting the front seat head restraints mechanically

⚠ WARNING Risk of accident due to adjusting vehicle settings while the vehicle is in motion

You could lose control of the vehicle in the following situations in particular:

- If you adjust the driver's seat, the head restraints, the steering wheel or the mirror while the vehicle is in motion.
- If you fasten your seat belt while the vehicle is in motion.

▶ Before starting the engine: adjust the driver's seat, the head restraints, the

steering wheel and the mirror and fasten your seat belt.

⚠ WARNING Risk of injury due to head restraints not being installed or being adjusted incorrectly

If head restraints have not been installed or have not been adjusted correctly, there is an increased risk of injury in the head and neck area, e.g. in the event of an accident or when braking.

- ▶ Always drive with the head restraints installed.
- ▶ Before driving off, make sure for every vehicle occupant that the center of the head restraint supports the back of the head at about eye level.

Do not interchange the head restraints of the front and rear seats. Otherwise, you will not be able to adjust the height and angle of the head restraints correctly.

Adjust the head restraint fore-and-aft position so that it is as close as possible to the back of your head.

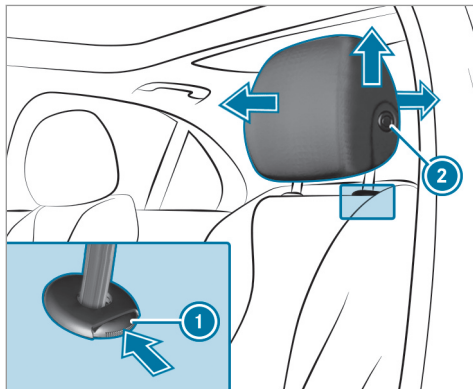

- ▶ **To raise:** pull the head restraint up.
- ▶ **To lower:** press release knob ① in the direction of the arrow and push the head restraint down.

- ▶ **To move forwards:** pull the head restraint forwards.
- ▶ **To move backwards:** press release knob ② and push the head restraint backwards.

Adjusting the front seat luxury head restraints mechanically

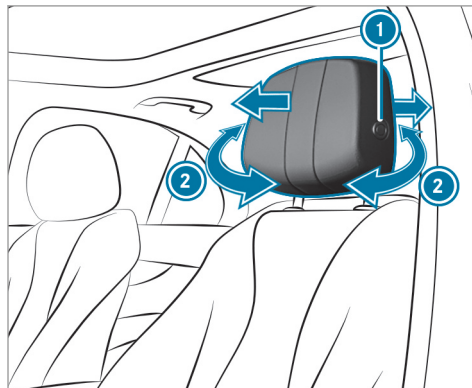

- ▶ **To adjust the side bolsters of the head restraint:** pull or push right or left-hand side bolster ②.
- ▶ **To move forwards:** pull the head restraint forwards.
- ▶ **To move backwards:** press release knob ① and push the head restraint backwards.
- ▶ Ensure that the head restraint is engaged correctly.

Adjusting the head restraints of the rear seats mechanically

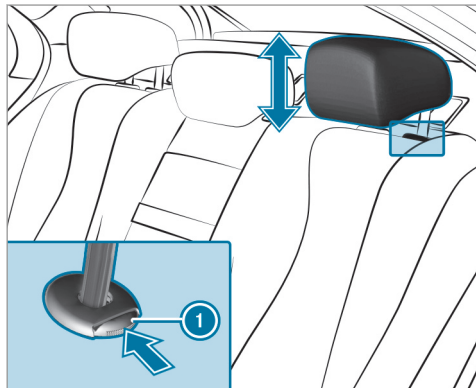

- ▶ **To raise:** pull the head restraint up.
- ▶ **To lower:** press release knob ① in the direction of the arrow and push the head restraint down.

Configuring the seat settings

Multimedia system:

→ ▶▶ Comfort ▶▶ Seat Comfort

Adjusting the backrest contour in the lumbar region of the seat backrest (lumbar)

- ▶ Select **Lumbar**.
- ▶ Select the settings for the desired seat.
- ▶ Adjust the air cushions.

Adjusting the backrest side bolsters

- ▶ Select **Side Bolsters**.
- ▶ Adjust the air cushion for the desired seat.

Setting the seat heating balance

- ▶ Select **Seat Heating Balance**.
- ▶ Adjust the heat distribution for the desired seat.

Setting automatic seat adjustment

⚠ WARNING Risk of becoming trapped during adjustment of the driver's seat after calling up a driver profile

Selecting a user profile may trigger an adjustment of the driver's seat to the position saved under the user profile. You or other vehicle occupants could be injured in the process.

- ▶ Make sure that when the position of driver's seat is being adjusted using the multimedia system, no people or body parts are in the seat's range of movement.

If there is a risk of someone becoming trapped, stop the adjustment process immediately:

- ▶ a) Tap the warning message on the media display.

or

- ▶ b) Press a memory position button or a seat adjustment switch on the driver's door. The adjustment process will be stopped.

Requirements:

- Adapting the driver's seat position to the body size: automatic seat adjustment has been switched on.

Multimedia system:

→  ▶ Settings ▶ Vehicle
▶ Automatic Seat Adjustment

Switching automatic seat adjustment on/off

When the active user profile is changed while the vehicle is stationary, the driver's seat, outside mirror and seat contour will automatically be adapted to the driver.

- ▶ Select **On** or **Off**.

- ⓘ This setting is available only for individual user profiles. For the guest profile, automatic seat adjustment cannot be switched

on or off. Further information about user profiles .

Adjusting the driver's seat position to body size

The vehicle will calculate a suitable driver's seat position on the basis of the driver's body size and set this directly.

- ▶ **To set the unit of measurement:** select **cm** or **ft/in**.
- ▶ Set the size using the scale.
- ▶ Select **Start Positioning**.
The driver's seat position will be adjusted to the body size that has been set.

- ⓘ If the driver's seat position calculated by the vehicle is not practical or comfortable, it can be changed manually at any time via the buttons.
The outside mirrors are not set via this function. Instead, they have to be set manually via the switches.
- ⓘ You can also configure these settings via the Mercedes me portal for your user profile. By synchronizing the profiles in the vehicle and

the Mercedes me connect profiles, you can carry over these settings for your vehicle. Further information about synchronizing user profiles .

Setting the easy entry and exit feature

- ▶ Activate or deactivate the function.
- ⓘ If you use an individual user profile and have set your body size, this information is carried over for the easy entry and exit feature. This causes the driver's seat to automatically move into the correct position .

Overview of massage programs

- **Hot Relaxing Back** Combination of heat and massage. It starts by massaging the back. In addition, warm pressure points become noticeable, starting in the pelvic area.
- **Hot Relaxing Shoulder** Combination of heat and massage. It starts by massaging the shoulders. In addition, warm pressure points become noticeable, starting in the pelvic area.

- **Activating Massage** Activating massage with upward-moving massage waves.
- **Classic Massage** Relaxing back massage.
- **Wave Massage** Regenerating massage via massage waves across the back and in the seat cushion.
- **Mobilizing Massage** Mobilizing Massage with upward-moving massage waves. Can promote slower, deeper respiration. This can improve the supply of oxygen to cells and the brain.
- **Active Workout, Backrest** and **Active Workout, Cushion** These programs require your cooperation. Alternating between tensing and releasing helps to improve blood flow to your muscles. Press against a pressure point as soon as you feel it.

Selecting the massage program for the front seats

Multimedia system:

Comfort **Message**

- ▶ Start the program for the desired seat .
- ▶ **To set the massage intensity:** switch **High Intensity** on or off .

Resetting seat settings

Multimedia system:

Comfort **Seat Comfort**

- ▶ Select for the desired seat.
- ▶ Confirm the prompt.

Switching the seat heating on/off

⚠ WARNING Risk of burns due to repeatedly switching on the seat heating

Repeatedly switching on the seat heating can cause the seat cushion and seat backrest padding to become very hot.

In particular, the health of persons with limited temperature sensitivity or a limited ability to react to high temperatures may be affected or they may even suffer burn-like injuries.

- ▶ Do not repeatedly switch on the seat heating.

To protect against overheating, the seat heating may be temporarily deactivated after it is switched on repeatedly.

! **NOTE** Damage to the seats caused by objects or documents when the seat heating is switched on

When the seat heating is switched on, overheating may occur due to objects or documents placed on the seats, e.g. seat cushions or child seats. This could cause damage to the seat surface.

- ▶ Make sure that no objects or documents are on the seats when the seat heating is switched on.

Requirements:

- The power supply is switched on.

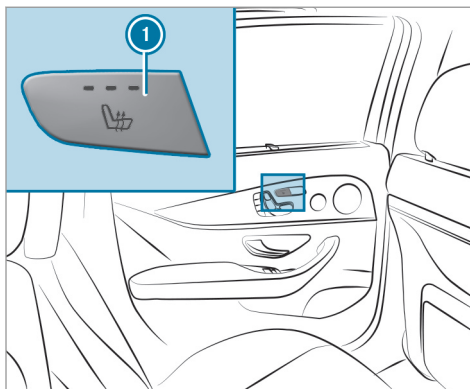
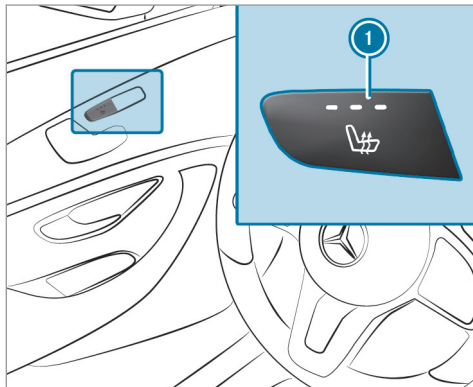

- ▶ Press button ① repeatedly until the desired heating level is set.

Depending on the heating level, up to three indicator lamps will light up. If all indicator lamps are off, the seat heating is switched off.

- ① The seat heating will automatically switch down from the three heating levels after 8,

10 and 20 minutes until the seat heating is switched off.

- ① Vehicles with the Warmth Comfort Package: you can heat the armrests in the door and the center console. You can also set the panel heating in the multimedia system (→ page 95).

Setting the panel heating

Multimedia system:

- ▶ ▶ Settings ▶ Vehicle
- ▶ Panel Heating

When the seat heating is switched on, the armrests and the center console can be heated.

- ▶ Switch the function for the desired seats on or off.

Switching the seat ventilation on/off**Requirements:**

- The power supply is switched on.

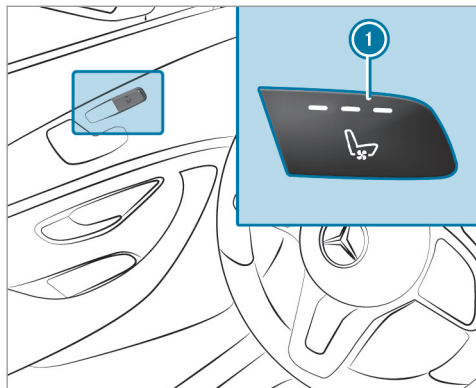

- ▶ Press button ① repeatedly until the desired blower setting has been reached. Depending on the blower setting, up to three indicator lamps will light up. If all indicator lamps are off, the seat ventilation is switched off.

Steering wheel

Adjusting the steering wheel mechanically

- ⚠ **WARNING** Risk of accident due to adjusting vehicle settings while the vehicle is in motion

You could lose control of the vehicle in the following situations in particular:

- If you adjust the driver's seat, the head restraints, the steering wheel or the mirror while the vehicle is in motion.
- If you fasten your seat belt while the vehicle is in motion.

- ▶ Before starting the engine: adjust the driver's seat, the head restraints, the steering wheel and the mirror and fasten your seat belt.

- ⚠ **WARNING** Risk of entrapment for children when adjusting the steering wheel

Children could injure themselves if they adjust the steering wheel.

- ▶ Never leave children unattended in the vehicle.
- ▶ When leaving the vehicle, always take the SmartKey with you and lock the vehicle.

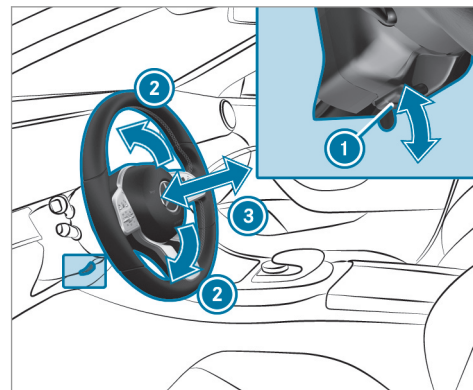

- ▶ **To unlock:** push release lever ① down as far as it will go.

- ▶ Adjust height ② and distance ③ to the steering wheel.
- ▶ **To lock:** push release lever ① up as far as it will go.
- ▶ Check and make sure that the steering column is locked by moving the steering wheel.

Adjusting the steering wheel electrically

The steering wheel can be adjusted when the power supply is disconnected.

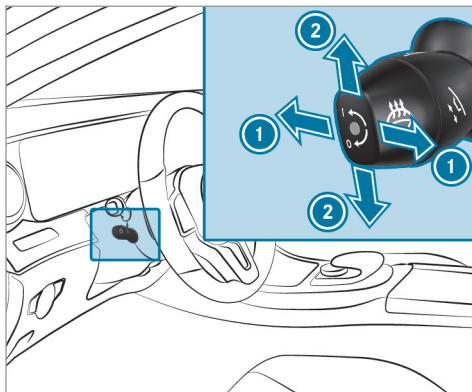

- ① To adjust the distance to the steering wheel
- ② To adjust the height
- ▶ Save the settings with the memory function (→ page 100).

Switching the steering wheel heater on or off

Requirements:

- The power supply or the ignition is switched on.

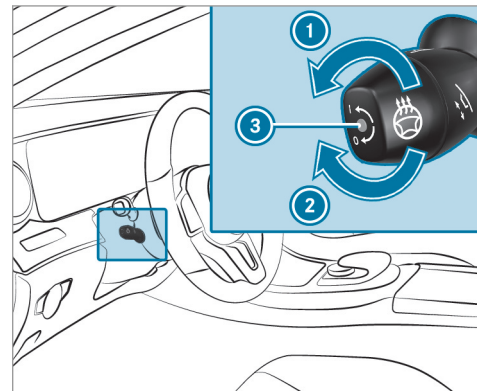

- ▶ **To switch on:** turn the lever in the direction of arrow ①. Indicator lamp ③ lights up.

- ▶ **To switch off:** turn the lever in the direction of arrow ②.
Indicator lamp ③ goes out.

When you switch the ignition off, the steering wheel heater switches off.

Easy entry and exit feature

Using the easy entry and exit feature

⚠ WARNING Risk of accident when pulling away during the adjustment process for the easy exit feature

You could lose control of the vehicle.

- ▶ Always wait until the adjustment process is complete before pulling away.

⚠ WARNING Risk of becoming trapped during adjustment of the easy entry and exit feature

You and other vehicle occupants – particularly children – could become trapped.

- ▶ Ensure that no one has a body part in the sweep of the steering wheel or driver's seat.

If there is a risk of becoming trapped by the steering wheel:

- ▶ Move the adjustment lever of the steering wheel.
The adjustment process will be stopped.

If there is a risk of becoming trapped by the driver's seat:

- ▶ Press the seat adjustment switch.
The adjustment process will be stopped.
- ▶ Never leave children unattended in the vehicle.
- ▶ When leaving the vehicle, always take the SmartKey with you and lock the vehicle.

Vehicles with memory function: You can stop the adjustment process by pressing one of the memory function position switches.

⚠ WARNING Risk of becoming trapped if children activate the easy entry and exit feature-

Children could become trapped if they activate the easy entry- and exit feature, particularly when unattended.

- ▶ Never leave children unattended in the vehicle.
- ▶ When leaving the vehicle, always take the SmartKey with you and lock the vehicle.

If the easy entry and exit feature is active, the steering wheel will move upwards and the driver's seat will move back in the following situations:

- You switch the ignition off with the driver's door open.
- You open the driver's door with the ignition switched off.

- ① The steering wheel will then move upwards only if it is not already as high as it will go. The driver's seat will then move backwards only if it is not already in the rearmost position.

The steering wheel and the driver's seat will move back to the last drive position in the following cases:

- You switch the power supply or the ignition on when the driver's door is closed
- You close the driver's door with the ignition switched on.

The last drive position will be saved when:

- You switch the ignition off.
- **Vehicles with memory function:** You call up the seat settings via the memory function.
- **Vehicles with memory function:** You save the seat settings via the memory function.

Vehicles with memory function: Press one of the memory function memory position switches to stop the adjustment process.

Setting the easy entry and exit feature

Multimedia system:

- →  → Settings → Vehicle
 → Automatic Seat Adjustment
 → Easy Entry/Exit

- ▶ Activate or deactivate the function.

Memory function

Function of the memory function

- ⚠ WARNING** Risk of an accident if the memory function is used while driving

If you use the memory function on the driver's side while driving, you could lose control of the vehicle as a result of the adjustments being made.

- ▶ Only use the memory function on the driver's side when the vehicle is stationary.

- ⚠ WARNING** Risk of entrapment when setting the seat with the memory function

When the memory function adjusts the seat, you and other vehicle occupants – particularly children – could become trapped.

- ▶ During the adjustment process of the memory function, make sure that no one has any body parts in the sweep of the seat.
- ▶ If someone becomes trapped, press a preset position button or seat adjustment switch immediately.

- ⚠ WARNING** Risk of entrapment if the memory function is activated by children

Children could become trapped if they activate the memory function, particularly when unattended.

- ▶ Never leave children unattended in the vehicle.

- ▶ When leaving the vehicle, always take the SmartKey with you and lock the vehicle.

You can use the memory function when the ignition is switched off.

Seat adjustments for up to three people can be stored and called up using the memory function.

You can save settings for the following systems:

- Seat, backrest and head restraint
- Steering wheel
- Outside mirrors
- Head-up Display

Operating the memory function

Storing

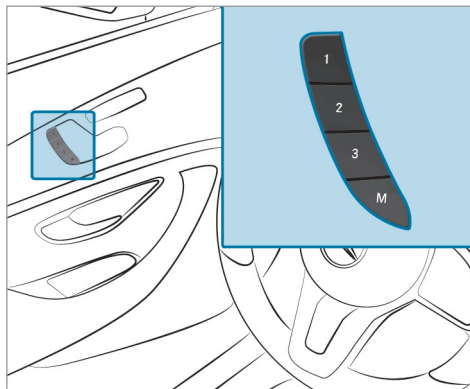

- ▶ Set the desired position for all systems.
- ▶ Briefly press the **[M]** memory button and then press preset position **[1]**, **[2]** or **[3]** within three seconds. An acoustic signal sounds. The settings are stored.

- ▶ **To call up:** press or briefly hold preset position button **[1]**, **[2]** or **[3]**. After releasing the button, all systems are moved into the stored position.

Stowage areas

Notes on loading the vehicle

⚠ DANGER Risk of exhaust gas poisoning

Combustion engines emit poisonous exhaust gases such as carbon monoxide. Exhaust gases can enter the vehicle interior if the trunk lid is open when the engine is running, especially if the vehicle is in motion.

- ▶ Always switch off the engine before opening the trunk lid.
- ▶ Never drive with the trunk lid open.

⚠ WARNING Risk of injury from unsecured items in the vehicle

If objects, luggage or loads are not secured or not secured sufficiently, they could slip,

tip over or be thrown around and thereby hit vehicle occupants.

There is a risk of injury, particularly in the event of sudden braking or a sudden change in direction.

- ▶ Always stow objects in such a way that they cannot be thrown around.
- ▶ Before the journey, secure objects, luggage or loads against slipping or tipping over.

⚠ WARNING Risk of injury due to objects being stowed incorrectly

If objects in the vehicle interior are stowed incorrectly, they can slide or be thrown around and hit vehicle occupants. In addition, cup holders, open storage spaces and mobile phone brackets cannot always retain all objects they contain.

There is a risk of injury, particularly in the event of sudden braking or a sudden change in direction.

- ▶ Always stow objects in such a way that they cannot be thrown around in such situations.
- ▶ Always make sure that objects do not protrude from storage spaces, parcel nets or storage nets.
- ▶ Close the lockable storage spaces before starting a journey.
- ▶ Always stow and secure heavy, hard, pointed, sharp-edged, fragile or bulky objects in the trunk.

⚠ WARNING - Risk of accident or injury when using the cup holder while the vehicle is moving

The cup holder cannot secure containers while the vehicle is moving.

If you use a cup holder while the vehicle is moving, the container may be flung around and liquids may be spilled. The vehicle occupants may come into contact with the liquid and if it is hot, they could be scalded. You

could be distracted from traffic conditions and you may lose control of the vehicle.

- ▶ Only use the cup holder when the vehicle is stationary.
- ▶ Only use the cup holder for containers of the right size.
- ▶ Close the container, particularly if the liquid is hot.

! NOTE Damage to the cup holder

When the rear armrest is folded back the cup holder could become damaged.

- ▶ Only fold the rear armrest back when the cup holder is closed.

! NOTE Damage to the rear armrest due to body weight

When folded out, the rear armrest can be damaged by body weight.

- ▶ Do not sit or support yourself on the rear seat armrest.

! **NOTE** Damage to the handle in the trunk floor

If the handle in the trunk is left protruding, the handle may be damaged.

- ▶ Before closing the trunk lid, detach the handle and press it down closed again.

! **NOTE** Damage to the stowage compartment under the ashtray due to intense heat

The stowage compartment under the ashtray is not heat resistant and could be damaged if you rest a lit cigarette on it.

- ▶ Make sure that the ashtray is fully engaged.

! **WARNING** - Risk of fire and injury from hot cigarette lighter

You can burn yourself if you touch the hot heating element or the socket of the cigarette lighter.

In addition, flammable materials may ignite if:

- you drop the hot cigarette lighter
 - a child holds the hot cigarette lighter to objects, for example
- ▶ Always hold the cigarette lighter by the knob.
 - ▶ Always make sure that the cigarette lighter is out of reach of children.
 - ▶ Never leave children unattended in the vehicle.

! **WARNING** Risk of burns from the tailpipe and tailpipe trims

The exhaust tailpipe and tailpipe trims can become very hot. If you come into contact with these parts of the vehicle, you could burn yourself.

- ▶ Always be particularly careful around the tailpipe and the tailpipe trims and supervise children especially closely in this area.

- ▶ Allow vehicle parts to cool down before touching them.

The driving characteristics of your vehicle are dependent on the distribution of the load within the vehicle. You should bear the following in mind when loading the vehicle:

- Never exceed the permissible gross mass or the gross axle weight rating for the vehicle (including occupants). The values are specified on the vehicle identification plate on the vehicle's B-pillar.
- The load must not protrude above the upper edge of the seat backrests.
- Always place the load behind unoccupied seats if possible.
- Secure the load using the tie-down eyes and distribute the load evenly.

Stowage spaces in the vehicle interior

Overview of the front storage compartments

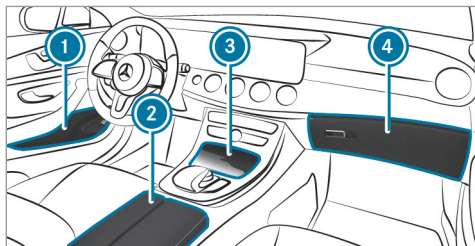

- ① Storage space in the doors
- ② Storage compartment in the armrest with USB ports and storage space, e.g. for an MP3 player
- ③ Storage compartment in the front center console with a USB port
- ④ Glove box

Through-loading feature in the rear bench seat (EASY-PACK Quickfold)

Folding the rear seat backrest forwards

⚠ WARNING Risk of becoming trapped when adjusting the seats

When you adjust a seat, you may trap yourself or a vehicle occupant.

- ▶ When adjusting a seat, make sure that no one has any body parts in the sweep of the seat.

⚠ WARNING Risk of accident and injury if the rear bench seat/rear seat and seat backrest are not engaged

Rear bench seat, rear seat and seat backrest can fold forwards.

- As a result, the vehicle occupant is pressed against the seat belt. The seat belt cannot perform its intended protective function and could cause additional injuries.

- Objects or loads in the trunk cannot be restrained by the seat backrest.
- ▶ Make sure that the rear bench seat, the rear seat and the seat backrest are engaged before every trip.

If the left seat backrest is not engaged and locked in place, this will be shown on the multi-function display on the instrument cluster. If the center seat backrest is not engaged and locked in place, the red lock verification indicator will be visible.

Always ensure that all vehicle occupants have their seat belts fastened correctly and are sitting properly. Particular attention must be paid to children.

If you no longer require the folded-down seat backrest as a loading area, fold the backrest back into place.

Requirements:

- The area into which the seat backrest is folded is clear.

104 Seats and stowing

- The rear seat backrest head restraints are fully inserted.

You can fold the center and outer seat backrests forwards separately.

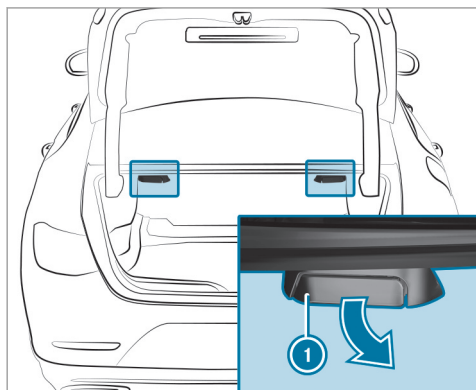

- ▶ **Vehicles with a memory function:** If at least one section of the rear seat backrest is folded forwards, the corresponding front seat

will move forwards slightly, if necessary, to avoid a collision.

- ▶ If necessary, fully insert the head restraints in the rear seat backrest.
- ▶ **To fold the left and right seat backrests forwards:** pull release lever ①. The corresponding seat backrest will fold forwards.

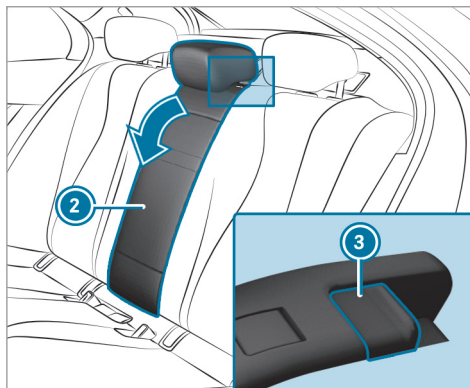

Ensure that the center seat backrest has been unlocked.

- ▶ **To fold the center seat backrest forwards:** pull release catch ③ of seat backrest ② forwards.
- ▶ Fold the corresponding seat backrest forwards.

Folding back the rear seat backrest

- ! **NOTE** Damage caused by trapping the seat belt when folding back the seat backrest

The seat belt could become trapped and thus damaged when the seat backrest is folded back.

- ▶ Make sure that the seat belt is not trapped when folding back the seat backrest.

- ▶ **Vehicles with a memory function:** If at least one section of the seat backrest is folded back, the corresponding front seat will

automatically return to the most recent original position.

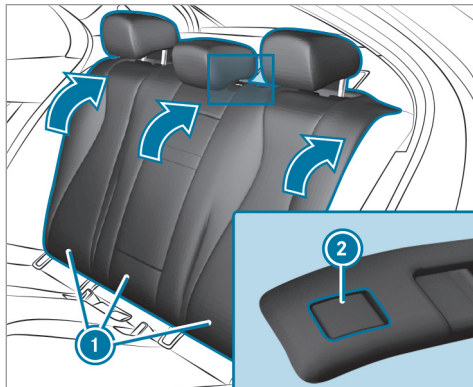

- ▶ Fold the corresponding seat backrest ① back until it engages.

Left and right seat backrests: if the seat backrest is not engaged and locked in place, this will be shown on the multifunction display on the instrument cluster.

Center seat backrest: if the seat backrest is not engaged and locked in place, red lock verification indicator ② will be visible.

Locking the release catch of the center rear seat backrest

Requirements:

- The left and center seat backrests are engaged and joined together.

You can lock the center seat backrest release catch if you want to secure the trunk against unauthorized access. The center seat backrest can then be folded forwards only together with the left seat backrest.

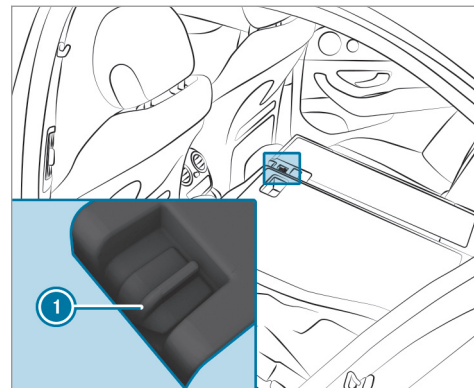

- ▶ Fold the center and left seat backrests forwards.
- ▶ **To lock or unlock:** slide catch ① up or down.

Overview of the tie-down eyes

Observe the notes on loading the vehicle (→ page 100).

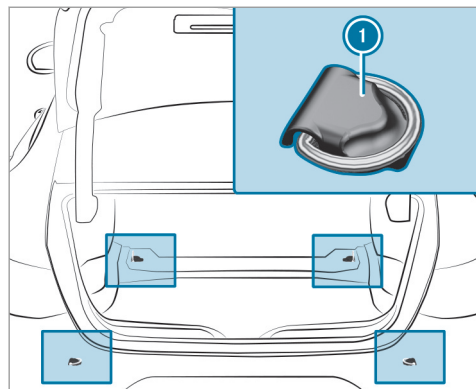

- ① Tie-down eyes (vehicles with through-loading feature in the rear bench seat)

Using the bag hooks

⚠ WARNING Risk of injury when using bag hooks with heavy objects

The bag hooks cannot restrain heavy objects or items of luggage.

Objects or items of luggage may be flung around and hit vehicle occupants.

- ▶ Only hang light objects on the bag hooks.
- ▶ Never hang hard, sharp-edged or fragile objects on the bag hooks.

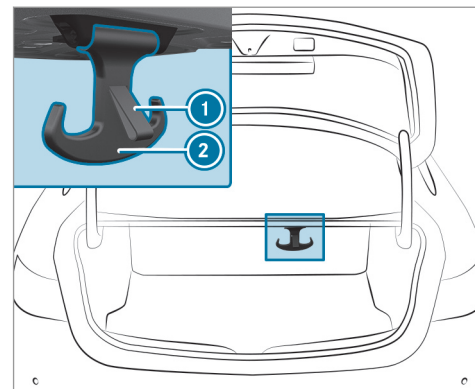

- ▶ Pull bag hook ② down by tab ①.
- ⓘ Observe the notes on loading the vehicle (→ page 100).

Attaching the parcel net

⚠ WARNING Risk of injury due to objects being stowed incorrectly

If objects in the vehicle interior are stowed incorrectly, they can slide or be thrown around and hit vehicle occupants. In addition, cup holders, open storage spaces and mobile phone brackets cannot always retain all objects they contain.

There is a risk of injury, particularly in the event of sudden braking or a sudden change in direction.

- ▶ Always stow objects in such a way that they cannot be thrown around in such situations.
- ▶ Always make sure that objects do not protrude from storage spaces, parcel nets or storage nets.
- ▶ Close the lockable storage spaces before starting a journey.

- ▶ Always stow and secure heavy, hard, pointed, sharp-edged, fragile or bulky objects in the trunk.

Observe the notes on loading the vehicle.

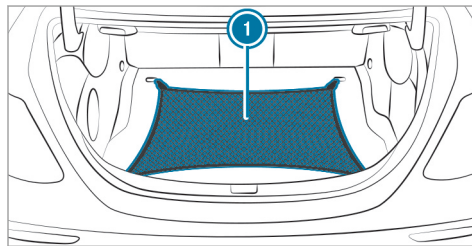

- ▶ Vehicles with through-loading feature in the rear bench seat: fold up the tie-down eyes.
- ▶ Hook parcel net ① into the front and rear tie-down eyes.
- ▶ Vehicles without a through-loading feature in the rear bench seat: hook the rings into the parcel net hooks ①.

- ▶ Place the rings into the hooks on the trunk floor.

Attaching a roof luggage rack

⚠ WARNING Risk of accident due to exceeding the maximum roof load

The vehicle center of gravity and the usual driving characteristics as well as the steering and braking characteristics alter.

If you exceed the maximum roof load, the driving characteristics, as well as steering and braking, will be greatly impaired.

- ▶ Never exceed the maximum roof load and adjust your driving style.

You will find information on the maximum roof load in the "Technical data" section.

! **NOTE** Vehicle damage from non-approved roof luggage racks

The vehicle could be damaged by roof luggage racks that have not been tested and approved for Mercedes-Benz.

- ▶ Use only roof luggage racks tested and approved for Mercedes-Benz.
- ▶ Depending on the vehicle equipment, ensure that the sliding sunroof can be fully raised when the roof luggage rack is installed.
- ▶ Depending on the vehicle equipment, ensure that the trunk lid can be fully opened when the roof luggage rack is installed.
- ▶ Position the load on the roof luggage rack in such a way that the vehicle will not sustain damage even when it is in motion.

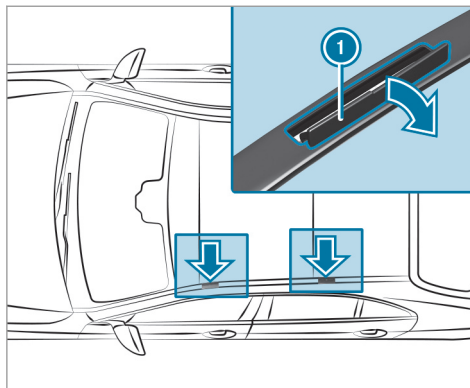

! **NOTE** Damage to the covers

The covers may be damaged and scratched when being opened.

- ▶ Do not use metallic or hard objects.

- ▶ Carefully fold covers **i** upwards in the direction of the arrow.

- ▶ Secure the roof luggage rack to the fastening points beneath covers **i**.
- ▶ Comply with the installation instructions of the roof luggage rack manufacturer.
- ▶ Secure the load on the roof luggage rack.

Sockets

Using the 12 V socket

Requirements:

- Only connect devices up to a maximum of 180 W (15 A).

Depending on the vehicle equipment, the vehicle has a 12 V socket in the storage compartment in the front center console. In addition, depending on the vehicle equipment, the vehicle has a 12 V socket in the storage compartment in the rear passenger compartment center console.

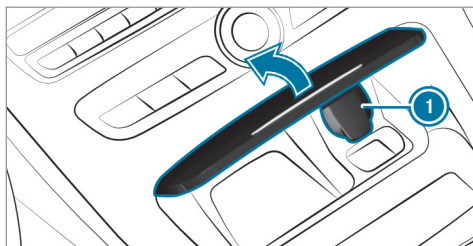

Example: 12 V socket in the storage compartment in the front center console

- ▶ Briefly press the trim element of the cover on the front.
The cover opens in the direction of the arrow.
- ▶ Lift up cap ① of the socket and insert the plug of the device.

If you have connected a device to the 12 V socket, leave the cover of the storage compartment open.

Using the 115 V socket in the rear passenger compartment

⚠ DANGER Risk of fatal injury due to damaged connecting cables or sockets

You could receive an electric shock if the connecting cable or the 115 V power socket is pulled out of the trim or is damaged or wet.

- ▶ Use only connecting cables that are dry and free of damage.
- ▶ When the ignition is switched off, make sure that the 115 V power socket is dry.
- ▶ Immediately have the 115 V power socket checked or replaced at a qualified specialized workshop if it is damaged or has been pulled out of the trim.
- ▶ Never plug the connecting cable into a 115 V power socket that is damaged or has been pulled out of the trim.

⚠ DANGER Risk of fatal injury due to incorrect handling of the socket

You could receive an electric shock in particular:

- If you reach into the socket.
 - If you insert unsuitable devices or objects into the socket.
- ▶ Do not reach into the socket.
 - ▶ Only connect suitable devices to the socket.

If the 115 V power socket is not going to be used, keep the flap closed.

Requirements:

- Devices are equipped with a suitable plug which conforms to the standards specific to the country you are in.
- A device up to a maximum of 150 W (1.3 A) is used.
- Do not use multiple socket outlets.

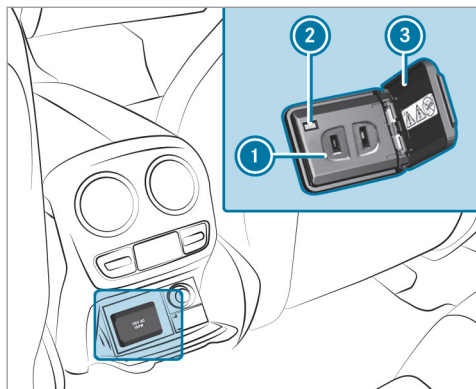

- ▶ Open flap ③.
- ▶ Insert the plug of the device into 115 V socket ①.
When the on-board electrical system voltage is sufficient, indicator lamp ② lights up.

USB port in the rear passenger compartment

① Depending on the vehicle equipment, the design of the storage compartment and the number of USB ports in the rear passenger compartment center console may vary.

If the ignition is switched on you can charge a USB device, such as a mobile phone, at the USB port using a suitable charging cable.

The devices can be charged with 5 V (up to 3 A) and when the ignition is switched on.

Wireless charging of the mobile phone and connection with the exterior antenna

Notes on wirelessly charging the mobile phone

⚠ WARNING Risk of injury due to objects being stowed incorrectly

If objects in the vehicle interior are stowed incorrectly, they can slide or be thrown around and hit vehicle occupants. In addition, cup holders, open stowage spaces and

mobile phone receptacles cannot always retain all objects within.

There is a risk of injury, particularly in the event of sudden braking or a sudden change in direction.

- ▶ Always stow objects so that they cannot be thrown around in such situations.
- ▶ Always make sure that objects do not protrude from stowage spaces, parcel nets or stowage nets.
- ▶ Close the lockable stowage spaces before starting a journey.
- ▶ Always stow and secure heavy, hard, pointed, sharp-edged, fragile or bulky objects in the trunk / cargo compartment.

Observe the notes on loading the vehicle.

⚠ WARNING Risk of fire from placing objects in the mobile phone storage compartment

Placing other objects in the mobile phone storage compartment could constitute a fire hazard.

- ▶ Apart from a mobile phone, do not place any other objects in the mobile phone storage compartment, especially those made of metal.

! NOTE Damage to objects caused by placing them in the mobile phone storage compartment

If objects are placed in the mobile phone storage compartment, they may be damaged by electromagnetic fields.

- ▶ Do not place credit cards, data storage devices, ski passes or other objects sensitive to electromagnetic fields in the mobile phone storage compartment.

! NOTE Damage to the mobile phone stowage compartment caused by liquids

If liquids enter the mobile phone stowage compartment, the compartment may be damaged.

- ▶ Ensure that no liquids enter the mobile phone stowage compartment.

The following notes on wirelessly charging the mobile phone must be observed:

- Depending on the vehicle equipment, the mobile phone is connected to the vehicle's exterior antenna via the charging module.
- The charging function and wireless connection of the mobile phone to the vehicle's exterior antenna are only available if the ignition is switched on.
- Small mobile phones may not be able to be charged in every position of the mobile phone storage compartment.
- Large mobile phones which do not rest flat in the mobile phone storage compartment may

not be able to be charged or connected with the vehicle's exterior antenna.

- The mobile phone may heat up during the charging process. This may particularly depend on the applications (apps) currently open in the background.
- To ensure more efficient charging and connection with the vehicle's exterior antenna, remove the protective cover from the mobile phone. Protective covers which are necessary for wireless charging are excluded.
- When charging, the mat should be used if possible.

Wirelessly charging a mobile phone

Requirements:

- The mobile phone is suitable for wireless charging (Qi-compatible mobile phone).
A list of Qi-compatible mobile phones can be found at: <https://www.mercedes-benz-mobile.com>

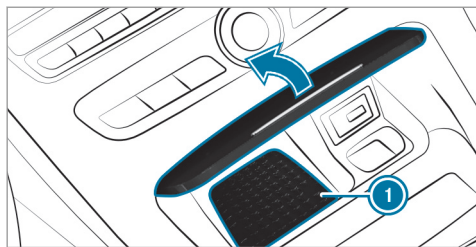

- ▶ Place the mobile phone as close to the center of mat ① as possible with the display facing upwards.

When the charging symbol is shown in the multimedia system, the mobile phone is being charged.

Malfunctions during the charging process are shown in the media display.

- ① The mat can be removed for cleaning, e.g. using clean, lukewarm water.

Installing/removing the floor mats

⚠ WARNING Risk of accident due to objects in the driver's footwell

Objects in the driver's footwell may impede pedal travel or block a depressed pedal.

This jeopardizes the operating and road safety of the vehicle.

- ▶ Stow all objects in the vehicle securely so that they cannot get into the driver's footwell.
- ▶ Always install the floor mats securely and as prescribed in order to ensure that there is always sufficient room for the pedals.
- ▶ Do not use loose floor mats and do not place floor mats on top of one another.

Installing floor mats

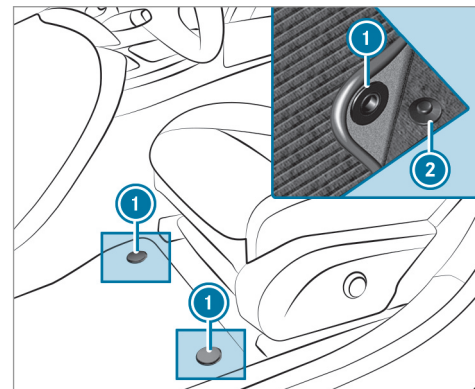

- ▶ Slide the corresponding seat backwards and lay the floor mat in the footwell.
- ▶ Press studs ① onto holders ②.
- ▶ Adjust the corresponding seat.

Removing floor mats

- ▶ **To remove:** pull the floor mat off holders ②.

- ▶ Remove the floor mat.

Exterior lighting

Information about lighting systems and your responsibility

The various lighting systems of the vehicle are only aids. The driver of the vehicle is responsible for correct vehicle illumination in accordance with the prevailing light and visibility conditions, legal requirements and traffic situation.

Light switch

Operating the light switch

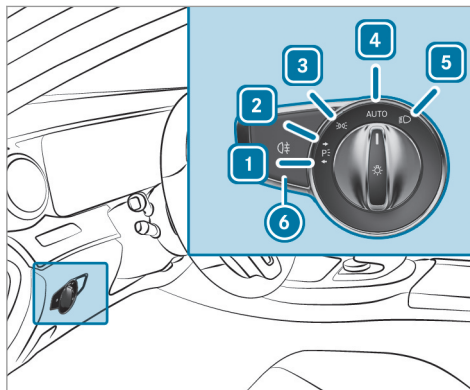

- 1 Left-hand standing lamps
- 2 Right-hand standing lamps
- 3 Parking lamps and license plate lamp
- 4 **AUTO** Automatic driving lights (preferred light switch position)

- 5 Low beam/high beam
- 6 Switches the rear fog light on/off

When low beam is activated, the indicator lamp for the parking lamps will be deactivated and replaced by the low-beam indicator lamp.

▶ Always park your vehicle safely using sufficient lighting, in accordance with the relevant legal stipulations.

! **NOTE** Battery discharging by operating the standing lights

Operating the standing lights over a period of hours puts a strain on the battery.

▶ Where possible, switch on the right or left parking light.

In the event of severe battery discharging, the standing lamps or parking lamps will be switched off automatically to facilitate the next engine start.

The exterior lighting (except standing and parking lamps) will switch off automatically when the driver's door is opened.

- Observe the notes on surround lighting (→ page 119).

Automatic driving lights function

The parking lamps, low beam and daytime running lamps are switched on automatically depending on the ignition status and the ambient light.

▲ WARNING Risk of accident when the low beam is switched off in poor visibility



When the light switch is set to **AUTO**, the low beam may not be switched on automatically if there is fog, snow or other causes of poor visibility such as spray.

- ▶ In such cases, turn the light switch to .

The automatic driving lights are only an aid. You are responsible for vehicle lighting.

Switching the rear fog lights on or off

Requirements:

- The light switch is in the  or **AUTO** position.
- ▶ Press the  button.

Please observe the country-specific laws on the use of rear fog lamps.



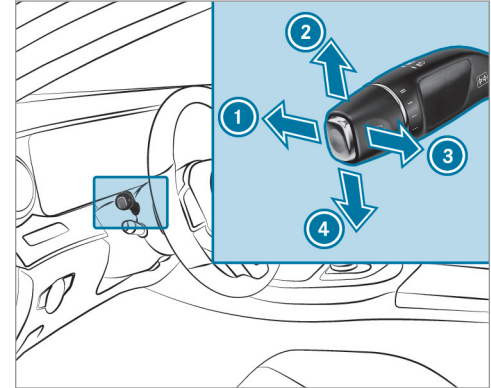

Operating the combination switch for the lights



- 1 High beam
- 2 Turn signal light, right
- 3 High-beam flasher
- 4 Turn signal light, left

- ▶ Use the combination switch to activate the desired function.

Switching on high beam

- ▶ Turn the light switch to the  or **AUTO** position.
- ▶ Push the combination switch beyond the point of resistance in the direction of arrow . When the high beam is activated, the  indicator lamp for low beam will be deactivated and replaced by the  indicator lamp for high beam.



Switching off high beam



- ▶ Move the combination switch back to its starting position.

High-beam flasher

- ▶ Pull the combination switch in the direction of arrow .

Turn signal light

- ▶ **To indicate briefly:** push the combination switch briefly to the point of resistance in the direction of arrow  or . The corresponding turn signal light will flash three times.

- ▶ **To indicate permanently:** push the combination switch beyond the point of resistance in the direction of arrow  or .

Vehicles with Active Lane Change Assist:

- A turn signal indicator activated by the driver may continue to operate for the duration of the lane change.
- If the driver indicated directly beforehand but a lane change was not immediately possible, the turn signal indicator may activate automatically.

Activating/deactivating the hazard warning lights

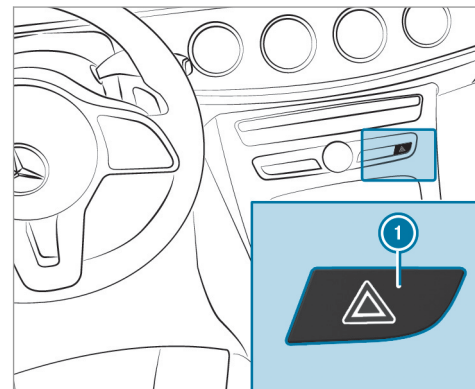

- ▶ Press button .

The hazard warning lights will switch on automatically if:

- The airbag has been deployed.

Cornering light

Cornering light function

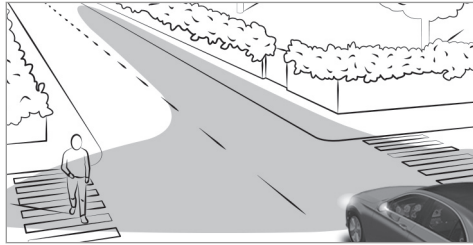

The cornering light improves the illumination of the road over a wide angle in the turning direction, enabling better visibility on tight curves, for example. It can be activated only when the low beam is switched on.

The function is active in the following cases:

- At speeds below 25 mph (40 km/h) when the turn signal light is switched on or the steering wheel is turned

- At speeds between 25 mph (40 km/h) and 43 mph (70 km/h) and when the steering wheel is turned

Roundabout and intersection function: the cornering light will be activated on both sides based on an evaluation of the vehicle's current GPS position. It will remain active until after the vehicle has left the roundabout or the intersection.

Adaptive Highbeam Assist

Adaptive Highbeam Assist function

⚠ WARNING Risk of accident despite Adaptive Highbeam Assist

Adaptive Highbeam Assist does not react to:

- Road users without lights, e.g. pedestrians
- Road users with poor lighting, e.g. cyclists
- Road users whose lighting is obstructed, e.g. by a barrier

On very rare occasions, Adaptive Highbeam Assist may fail to recognize other road users with their own lighting, or may recognize them too late.

In these, or in similar situations, the automatic high beam will not be deactivated or will be activated despite the presence of other road users.

- ▶ Always observe the road and traffic conditions carefully and switch off the high beam in good time.

Adaptive Highbeam Assist cannot take into account road, weather or traffic conditions.

Detection may be restricted in the following cases:

- In poor visibility, e.g. fog, heavy rain or snow
- If there is dirt on the sensors or the sensors are obscured

Adaptive Highbeam Assist is only an aid. You are responsible for adjusting the vehicle's lighting to the prevailing light, visibility and traffic conditions.

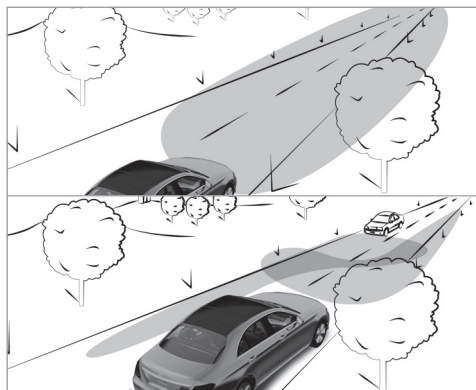

Adaptive Highbeam Assist automatically switches between the following types of light:

- Low beam
- High beam

At speeds greater than 19 mph (30 km/h):

- If no other road users are detected, the high beam will be switched on automatically.

The high beam will switch off automatically in the following cases:

- At speeds below 16 mph (25 km/h)
- If other road users are detected
- If street lighting is sufficient

The system's optical sensor is located behind the windshield near the overhead control panel.

Switching Adaptive Highbeam Assist on/off

Switching on

- ▶ Turn the light switch to the **AUTO** position.
- ▶ Switch on the high beam using the combination switch.
If Adaptive Highbeam Assist is activated, the  indicator lamp will light up on the multifunction display.

Switching off

- ▶ Switch off the high beam using the combination switch.

Switching the daytime running lamps on/off

Multimedia system:

- ▶  **Settings** **Light**
Daytime Run. Lights

- ▶ Switch the function on or off.

Setting the exterior lighting switch-off delay time

Requirements:

- The light switch is in the **AUTO** position.

Multimedia system:

- ▶  **Settings** **Light**
Exterior Lighting Delay

- ▶ Set the switch-off delay time.
When the vehicle engine is switched off, the exterior lighting will be activated for the set time.

Switching the surround lighting on/off

Multimedia system:

-  ➤ Settings ➤ Light
- Locator Lighting

When **Locator Lighting** is active, the exterior lighting lights up for 40 seconds after the vehicle is unlocked. When you start the vehicle, the surround lighting is deactivated and the automatic driving lights are activated.





- ▶ Activate or deactivate the function.

Interior lighting

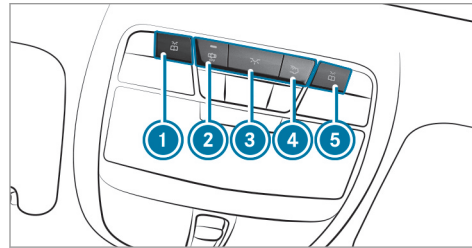
Adjusting the interior lighting

Front overhead control panel



- ①  Front left reading lamp
- ②  Automatic interior lighting control
- ③  Front interior lighting
- ④  Rear interior lighting
- ⑤  Front right reading lamp

- ▶ **To switch on/off:** press button ① - ⑤ accordingly.

Control panel in the grab handle

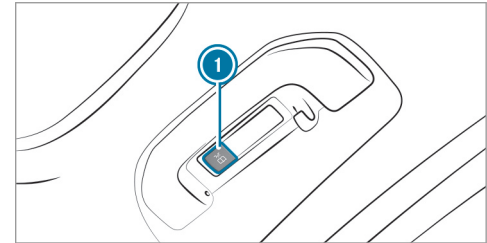

- ①  Rear reading lamp

- ▶ **To switch on/off:** press button ①.

Adjusting the ambient lighting

Multimedia system:

-  ➤ Comfort ➤ Ambient Lighting

Setting the color

- ▶ Select **Color**.
- ▶ Set the desired color.

Adjusting the brightness

- ▶ Select **Brightness**.
- ▶ Adjust the brightness.

Activating the brightness for zones

- ▶ Select **Brightness**.
- ▶ Select **Brightness Zones**.
- ▶ Activate or deactivate the function.

or

- ▶ Set the brightness for the desired zones.

Activating multi-color lighting

- ▶ Select **Color**.
- ▶ Select **Multi-color**.
- ▶ Select a color combination.

Activating multi-color animation

- ▶ Select **Color**.
- ▶ Select **Multi-color Animation**.
The chosen color combination will change at predefined intervals.

Activating welcome lighting

- ▶ Select **Color**.
- ▶ Select **Welcome**.
When the vehicle is unlocked, a special ambient lighting sequence will run.

Activating dependency on air conditioning settings

- ▶ Select **Color**.
- ▶ Select **Climate**.
If changes are made to the temperature setting in the vehicle, the color of the ambient lighting will change briefly.

Switching the interior lighting switch-off delay time on/off

Multimedia system:

- ▶  ▶ Settings ▶ Light
- ▶ ▶ Interior Lighting Delay

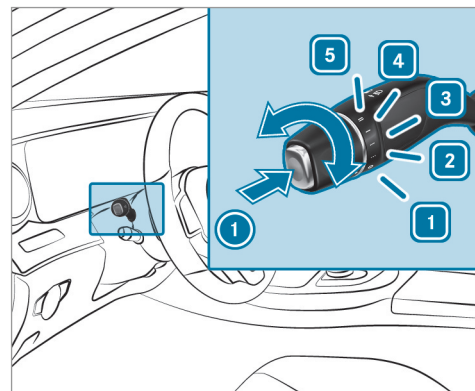

- ▶ Switch the switch-off delay time on or off.
When this function is active, the interior lighting lights up for a short time after the vehicle is locked.

Windshield wiper and windshield washer system**Switching the windshield wipers on/off**

- | | | |
|----------|-------------|-------------------------------|
| 1 | 0 | Windshield wiper off |
| 2 | ... | Intermittent wiping, normal |
| 3 | | Intermittent wiping, frequent |

4  Continuous wiping, slow

5  Continuous wiping, fast

- ▶ Turn the combination switch to the corresponding position **1** - **5**.
- ▶ **Single wipe/washing:** push the button on the combination switch in the direction of arrow **1**.
 -  Single wipe
 -  Wipes with washer fluid

Replacing the windshield wiper blades

⚠ WARNING Risk of becoming trapped if the windshield wipers are switched on while wiper blades are being replaced

If the windshield wipers begin to move while you are changing the wiper blades, you can be trapped by the wiper arm.

- ▶ Always switch off the windshield wipers and the ignition before changing the wiper blades.

Moving the wiper arms into the replacement position

- ▶ Switch the ignition on and then off again immediately.
- ▶ Within around 15 seconds, press and hold the  button on the combination switch for approximately three seconds (→ page 120). The wiper arms will move into the replacement position.

Removing the wiper blades

- ▶ Fold the wiper arms away from the windshield.

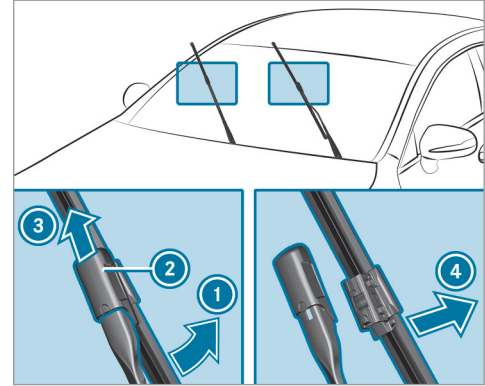

- ▶ Hold the wiper arm with one hand. With the other hand, turn the wiper blade away from the wiper arm in the direction of arrow **1** as far as it will go.
- ▶ Slide catch **2** in the direction of arrow **3** until it engages in the removal position.
- ▶ Remove the wiper blade from the wiper arm in the direction of arrow **4**.

Installing the wiper blades

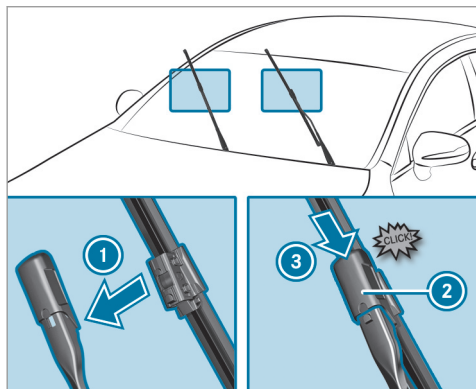

- ▶ Insert the new wiper blade into the wiper arm in the direction of arrow ①.
- ▶ Slide catch ② in the direction of arrow ③ until it engages in the locking position.
- ▶ Make sure that the wiper blade is seated correctly.

- ▶ Fold the wiper arms back onto the windshield.
- ▶ Switch on the ignition.
- ▶ Press the  button on the combination switch (→ page 120). The wiper arms will return to the original position.
- ▶ Switch the ignition off.

Maintenance display

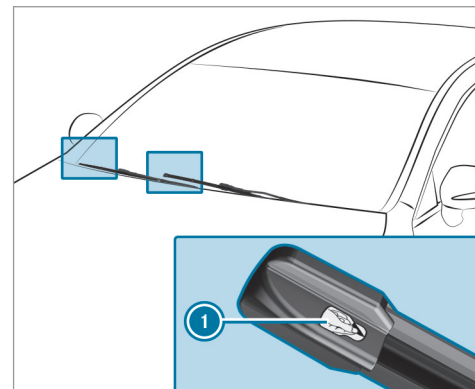

- ▶ Remove protective film ① from the maintenance display on the tip of the newly installed wiper blades.

When the color of the maintenance display changes from black to yellow, the wiper blades should be replaced.

- ⓘ The duration until the color changes varies depending on the usage conditions.

Mirrors

Operating the outside mirrors

⚠ WARNING Risk of accident due to adjusting vehicle settings while the vehicle is in motion

You could lose control of the vehicle in the following situations in particular:

- If you adjust the driver's seat, the head restraints, the steering wheel or the mirror while the vehicle is in motion.
 - If you fasten your seat belt while the vehicle is in motion.
- ▶ Before starting the engine: adjust the driver's seat, the head restraints, the steering wheel and the mirror and fasten your seat belt.

⚠ WARNING Risk of accident due to misjudgment of distance when using the front-passenger mirror

The outside mirror on the front passenger side reflects objects on a smaller scale. The objects in view are in fact closer than they appear.

- ▶ Therefore, always look over your shoulder in order to ensure that you are aware of the actual distance between you and the road users driving behind you.

Folding the outside mirrors in/out

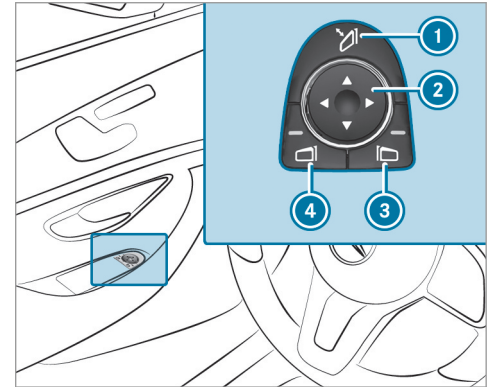

- ▶ Briefly press button ①.

Resetting the outside mirrors

- ⓘ If the battery has been disconnected or completely discharged, the outside mirrors must be reset. Only then will the automatic mirror folding function work properly.
- ▶ Briefly press button ①.

Adjusting the outside mirrors

- ▶ Press button ③ or ④ to select the outside mirror to be adjusted.
- ▶ Press button ② to adjust the position of the mirror glass.

Engaging the outside mirrors

- ▶ Vehicles without electrically folding outside mirrors: manually move the outside mirror into the correct position.
- ▶ Vehicles with electrically folding outside mirrors: press and hold button ①. You will hear a click and the mirror will audibly click into place. The outside mirror will now be set to the correct position.

Automatic anti-glare mirrors function

⚠ WARNING Risk of acid burns and poisoning due to the anti-glare mirror electrolyte

Electrolyte may escape if the glass in an automatic anti-glare mirror breaks.

The electrolyte is hazardous to health and causes irritation. It must not come into contact with your skin, eyes, respiratory organs or clothing or be swallowed.

- ▶ If you come into contact with electrolyte, observe the following:
 - Immediately rinse the electrolyte from your skin with water and seek medical attention.
 - If electrolyte comes into contact with your eyes, immediately rinse them thoroughly with clean water and seek medical attention.
 - If the electrolyte is swallowed, immediately rinse your mouth out thoroughly. Do not induce vomiting. Seek medical attention immediately.
 - Immediately change out of clothing which has been contaminated with electrolyte.
 - If an allergic reaction occurs, seek medical attention immediately.

The inside rearview mirror and the outside mirror on the driver's side will automatically go into anti-glare mode if light from a headlamp hits the sensor on the inside rearview mirror.

System limits

The system will not go into anti-glare mode if:

- The engine is switched off.
- Reverse gear is engaged.
- The interior lighting is switched on.

Front-passenger outside mirror parking position function

The parking position makes parking easier.

The front-passenger outside mirror will swivel downwards in the direction of the rear wheel on the front passenger's side when:

- The parking position is stored (→ page 125).
- The front-passenger mirror is selected.
- Reverse gear is engaged.

The front-passenger outside mirror will move back to its original position when:

- You shift the transmission to another transmission position.
- You are traveling at a speed greater than 9 mph (15 km/h).
- You press the button for the outside mirror on the driver's side.

Storing the parking position of the front-passenger outside mirror using reverse gear

Storing

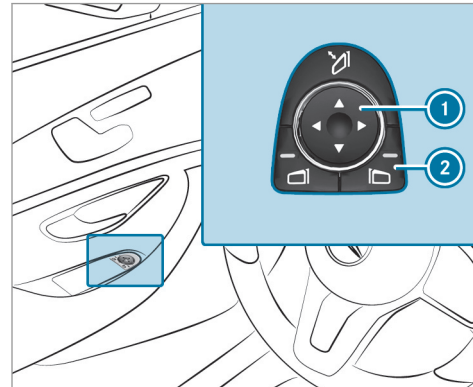

- ▶ Select the front-passenger outside mirror using button ②.
- ▶ Engage reverse gear.
- ▶ Move the front-passenger outside mirror into the desired parking position using button ①.

Calling up

- ▶ Select the front-passenger outside mirror using button ②.
- ▶ Engage reverse gear. The front-passenger outside mirror will move to the stored parking position.

Activating/deactivating the automatic mirror folding function

Multimedia system:

- ▶ ▶ Settings ▶ Vehicle
- ▶ Switch Automatic Folding on or off.

Area permeable to radio waves on the windshield

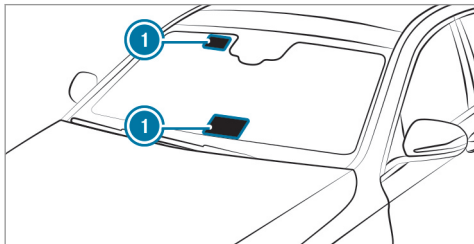

Radio-controlled equipment, such as toll systems, can be mounted only on areas ① of the windshield that are permeable to radio waves.

Areas permeable to radio waves ① are best visible from outside the vehicle when the windshield is illuminated with an external light source.

Note this position for vehicles with:

- Windshield heating
- Infrared reflective windshield

Infrared-reflective windshield function

The infrared-reflective windshield is coated and reduces the build-up of heat in the vehicle interior.

The coating shields the vehicle interior from radio waves.

Overview of climate control systems

Notes on climate control

An interior air filter in combination with the pre-filter in the engine compartment must always be used so that the air conditioning system, pollution level monitoring and the air filtration work correctly. Make sure that the filter is installed correctly and the filter housing in the engine compartment is closed correctly using the cap and always tightly sealed when in operation. Use filters recommended and approved by Mercedes-Benz. Always have service work carried out at a qualified specialist workshop.

Overview of the air conditioning control panel

The indicator lamps on the buttons indicate that the corresponding function is activated.

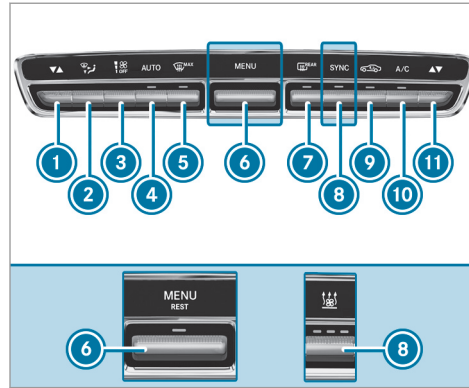

Control panel for dual-zone automatic climate control with/without stationary heater (example)

- ① Sets the temperature, left
- ② Sets the air distribution
- ③ Sets the airflow or switches off climate control
- ④ **AUTO** Sets climate control to automatic (→ page 128)
- ⑤ Defrosts the windshield

- ⑥ Vehicles with control panel for dual-zone automatic climate control (without stationary heater): **MENU** calls up the air conditioning menu



Vehicles with control panel for dual-zone automatic climate control (with stationary heater) or 3-zone automatic climate control (with/without stationary heater): **MENU REST** calls up the air conditioning menu, switches residual heat on/off (→ page 130)

- ⑦ Switches the rear window heater on/off
- ⑧ Vehicles with control panel for dual-zone automatic climate control without stationary heater: **SYNC** switches synchronization on/off (→ page 129)

Vehicles with control panel for 3-zone automatic climate control without stationary heater: **A/C** switches the A/C function on/off (→ page 128)

Vehicles with a stationary heater: switches the stationary heater on/off

- ⑨ Switches air-recirculation mode on/off (→ page 130)

- ⑩ Vehicles with control panel for dual-zone automatic climate control:  switches the A/C function on/off (→ page 128)
- Vehicles with control panel for 3-zone automatic climate control:  adjusts the air distribution, right
- ⑪  Sets the temperature, right

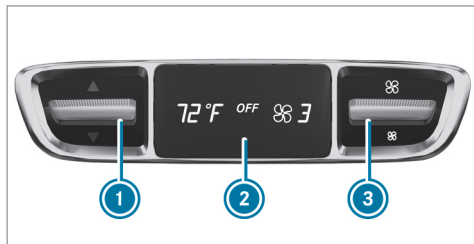

Rear operating unit in vehicles with control panel for 3-zone automatic climate control



- ① Sets the temperature
- ② Display
- ③ Sets the airflow

Operating the climate control system

Switching climate control on/off

- ▶ **To switch on:** set the airflow to level 1 or higher using the  button.
- ▶ **To switch off:** set the airflow to level 0 using the  button.

If climate control is switched off, the windows may fog up more quickly. Switch climate control off only briefly.

Switching the A/C function on/off using the air conditioning control panel

The A/C function heats, cools and dehumidifies the vehicle's interior air.

- ▶ Press the  button.

Switch off the A/C function only briefly; otherwise, the windows may fog up more quickly.

Condensation may drip from the underside of the vehicle when cooling mode is active. This is not indicative of a malfunction.

Calling up the air conditioning menu

Calling up the air conditioning menu using the multimedia system

- ▶ Select one of the temperature displays at the lower edge of the media display.

Activating/deactivating the A/C function via the multimedia system



The A/C function heats, cools and dehumidifies the vehicle's interior air.

- ▶ Call up the air-conditioning menu (→ page 128).
- ▶ Select **First Row of Seats**.
- ▶ Select **A/C**.

Setting climate control to automatic mode

In automatic mode, the set temperature is controlled and maintained at a constant level by the air supply.

- ▶ Press the  button.

- ▶ **To switch to manual mode:** press the  or  button.

Climate style

Climate style function





The following climate styles are available in automatic mode:

- **FOCUS:** high airflow, slightly cooler setting
- **MEDIUM:** medium airflow, standard setting
- **DIFFUSE:** low airflow, slightly warmer and draft-free setting

Adjusting the climate mode settings

- ▶ Call up the air conditioning menu (→ page 128).
- ▶ Select **First Row of Seats** or **Second Row of Seats**.
- ▶ Call up the **CLIMATE MODE** menu.
- ▶ Select a climate style.

Setting the air distribution

- ▶ Call up the air conditioning menu (→ page 128).
- ▶ Select a row of seats.
- ▶ **To set the air distribution:** select ,  or .
- ▶ Set the airflow.
- ⓘ Several air distribution options can be selected at the same time, for example to set the climate control for the windshield and the footwells simultaneously. The  climate control for the windshield can only be selected for the first seat row.

Activating/deactivating the climate control synchronization function via the air conditioning control panel

Climate control can be set centrally using the synchronization function. The temperature and air distribution settings for the driver's side will be adopted automatically for the front passenger side.

- ▶ Press the **SYNC** button.

The synchronization function will be deactivated if the settings for one of the other climate control zones are changed.

Activating/deactivating the climate control synchronization function via the multimedia system

Climate control can be set centrally using the synchronization function. The driver's settings for temperature, air quantity and air distribution are adopted automatically for all climate zones.

- ▶ Call up the air conditioning menu (→ page 128).
- ▶ Select **First Row of Seats**.
- ▶ Select **SYNC**.

Removing condensation from the windows

Windows fogged up on the inside

- ▶ Press the **AUTO** button.

130 Climate control

- ▶ If the windows continue to fog up: press the  button.

Windows fogged up on the outside

- ▶ Switch on the windshield wipers.
- ▶ Press the  button.

Switching air-recirculation mode on/off

- ▶ Press the  button.
The interior air will be recirculated.

Air-recirculation mode automatically switches to fresh air mode after some time.

- ⓘ If air-recirculation mode is switched on, the windows may fog up more quickly. Switch on air-recirculation mode only briefly.

Switching the residual heat on or off

Requirements:

- The vehicle is parked.

It is possible to make use of the residual heat from the engine to continue heating or ventilat-

ing the front compartment of the vehicle for approximately 30 minutes.

- ▶ **To switch on:** press the  button.

Residual heat is switched off automatically.

Activating/deactivating ionization

Ionization improves the quality of the vehicle's interior air. Ionization of the interior air is odorless.

- ▶ Call up the air conditioning menu (→ page 128).
- ▶ Select **Air Quality**.
- ▶ Select **IONIZATION**.

Fragrance system

Setting the fragrance system

Requirements:

- Automatic climate control is activated.
- The glove box is closed.

The fragrance system distributes a pleasant fragrance throughout the vehicle interior from a flacon located in the glove box.

- ▶ Call up the climate control menu (→ page 128).
- ▶ Select **Air Quality**.
- ▶ Select **AIR FRESHENER**.
- ▶ Keep pressing until the desired intensity is reached.

Inserting or removing the flacon of the fragrance system

 **WARNING** Risk of injury from liquid perfume

If children open the flacon, they could drink the liquid perfume or it could come into contact with their eyes.

- ▶ Do not leave children unattended in the vehicle.
- ▶ Consult a doctor immediately if liquid perfume has been drunk.

- ▶ If liquid perfume comes into contact with your eyes or skin, rinse your eyes with clean water.
- ▶ If symptoms continue, consult a doctor.

 **ENVIRONMENTAL NOTE** Environmental damage due to improper disposal of full flacons



Full flacons must not be disposed of with household waste.



Full flacons must be taken to a harmful substance collection point.

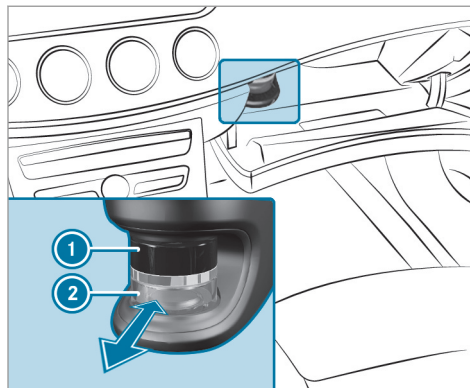

- ① Cap
- ② Flacon

- ▶ **To insert:** slide the flacon into the holder as far as it will go.
- ▶ **To remove:** pull out the flacon.

If you do not use genuine Mercedes-Benz interior perfumes, observe the manufacturers' safety notices on the perfume packaging.

Dispose of the genuine Mercedes-Benz interior perfume flacon when it is empty and do not refill it.

Refillable flacon

- ▶ Unscrew the cap of the empty flacon.
- ▶ Fill the flacon with a maximum of 0.5 fl. oz. (15 ml).
- ▶ Screw the cap back on to the flacon.

Always refill the empty refillable flacon with the same perfume. Observe the separate information sheet with the flacon.

Information on the windshield heater

The windshield heater is switched on automatically if the  button is activated.

After the vehicle is started, the windshield heater is switched on automatically as required.

Air vents

Adjusting the front air vents

⚠ WARNING Risk of burns and frostbite due to being too close to the air vents

Very hot or very cold air can flow from the air vents.

- ▶ Make sure that all vehicle occupants always maintain a sufficient distance from the air vents.
- ▶ If necessary, direct the airflow to another area of the vehicle interior.

To guarantee the flow of fresh air through the air vents into the vehicle interior, comply with the following:

- Always keep the vents and vent grilles in the vehicle interior free.
- Keep the air inlet free of residue build-up (→ page 269).

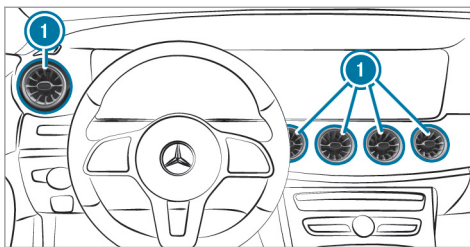

- ▶ **To open or close:** hold the air vent ① in the center and turn it to the left or right as far as it will go.
- ▶ **To set the airflow direction:** hold air vent ① in the center and move it up or down or to the left or right.

Adjusting the rear air vents

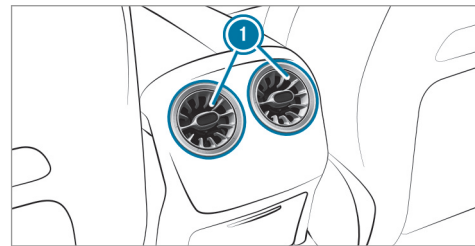

- ▶ **To open or close:** hold air vent ① in the center and turn it to the left or right as far as it will go.
- ▶ **To set the airflow direction:** hold air vent ① in the center and move it up or down or to the left or right.

Driving

Notes on Mercedes-AMG vehicles

Observe the notes on the following topics in the Supplement, otherwise you may fail to recognize dangers.

- ① The availability of certain functions depends on the equipment and model of the vehicle.
- Emotion Start
- AMG Performance exhaust system
- AMG ceramic high-performance composite brake system
- AMG adaptive sport suspension system +
- AMG steering-wheel buttons

Switching on the power supply or ignition

▲ WARNING Risk of accident and injury due to children left unattended in the vehicle

If children are left unsupervised in the vehicle, they could, in particular:

- Open doors, thereby endangering other persons or road users.
- Get out and be struck by oncoming traffic.
- Operate vehicle equipment and become trapped, for example.

In addition, the children could also set the vehicle in motion, for example by:

- Releasing the parking brake.
- Changing the transmission position.
- Starting the vehicle.

▶ Never leave children unattended in the vehicle.

- ▶ When leaving the vehicle, always take the SmartKey with you and lock the vehicle.
- ▶ Keep the vehicle SmartKey out of reach of children.

Requirements:

- The SmartKey is in the vehicle and is recognized.
- The brake pedal is not depressed.

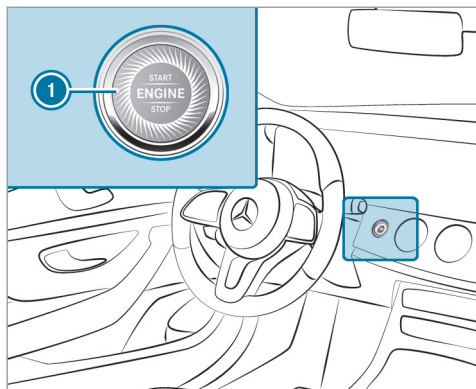

- ▶ **To switch on the power supply:** press button ❶ once. You can activate the windshield wipers, for example.

The power supply is switched off again if the following conditions are met:

- You open the driver's door.
- You press button ❶ twice more.

- ▶ **To switch on the ignition:** press button ❶ twice. The indicator lamps in the instrument cluster light up.

The ignition is switched off again if one of the following conditions is met:

- You do not start the vehicle within 15 minutes and the transmission is in position **P** or the electric parking brake is applied.
- You press button ❶ once.

Starting the vehicle

Starting the vehicle with the start/stop button

⚠ DANGER Risk of death caused by exhaust gases

Combustion engines emit poisonous exhaust gases such as carbon monoxide. Inhaling these exhaust gases is hazardous to health and leads to poisoning.

- ▶ Never leave the engine or, if present, the auxiliary heating running in an enclosed space without sufficient ventilation.

⚠ WARNING Risk of fire due to flammable material in the engine compartment or the exhaust system

Flammable materials may ignite.

- ▶ Therefore, check regularly that there are no flammable materials in the engine compartment or on the exhaust system.

Requirements:

- The SmartKey is in the vehicle and is recognized.
- ▶ Shift the transmission to position **P** or **N**.
- ▶ Depress the brake pedal and press button ❶ once.
- ▶ If the vehicle does not start: switch off non-essential consumers and press button ❶ once.

- ▶ If the vehicle still does not start and the **Place the Key in the Marked Space See Operator's Manual** display message also appears in the multifunction display: start the vehicle with the SmartKey in the marked space (emergency operation mode) (→ page 135).

- ⓘ You can switch off the engine while driving by pressing button ❶ for about three seconds or by pressing button ❶ three times within three seconds. Be sure to observe the safety notes under "Driving tips" (→ page 138).

Starting the vehicle with the SmartKey in the marked space (emergency operation mode)

If the vehicle does not start and the **Place the Key in the Marked Space See Operator's Manual** message appears in the multifunction display, you can start the vehicle in emergency operation mode.

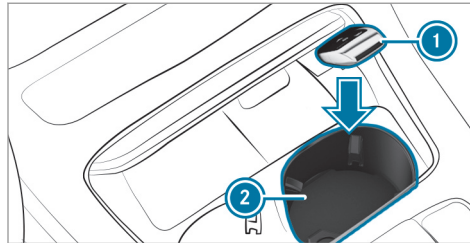

- ▶ Make sure that marked space ❷ is empty.
 - ▶ Remove SmartKey ❶ from the key ring.
 - ▶ Place SmartKey ❶ in marked space ❷. The vehicle will start after a short time.
- If you remove SmartKey ❶ from marked space ❷ the engine continues running. For further vehicle starts however, SmartKey ❶ must be located in marked space ❷ during the entire journey.
- ▶ Have SmartKey ❶ checked at a qualified specialist workshop.

If the vehicle does not start:

- ▶ Place SmartKey ❶ in marked space ❷ and leave it there.
- ▶ Depress the brake pedal and start the vehicle using the start/stop button.
- ⓘ You can also switch on the power supply or the ignition with the start/stop button.

Starting the vehicle via Remote Online services

Cooling or heating the vehicle interior before commencing your journey

Ensure the following before starting the engine:

- The legal stipulations in the area where your vehicle is parked allow engine starting via smartphone.
- It is safe to start and run the engine where your vehicle is parked.
- The fuel tank is sufficiently full.
- The starter battery is sufficiently charged.

Charging the starter battery before starting the journey

If the vehicle battery is discharged, you can receive a message on your smartphone. You can then start the vehicle with the smartphone to charge the battery. The vehicle is automatically switched off after ten minutes.

Ensure the following before starting the engine:

- The legal stipulations in the area where your vehicle is parked allow engine starting via smartphone.
- It is safe to start and run the engine where your vehicle is parked.
- The fuel tank is sufficiently full.

Starting the vehicle (Remote Online)

⚠ WARNING Risk of crushing or entrapment due to unintentional starting of the engine

Limbs could be crushed or trapped if the engine is started unintentionally during service or maintenance work.

▶ Always secure the engine against unintentional starting before carrying out maintenance or repair work.

Requirements:

- Park position **P** is selected.
- The anti-theft alarm system is not activated.
- The panic alarm is not activated.
- The hazard warning light system is switched off.
- The hood is closed.
- The doors are closed and locked.
- The windows and sliding sunroof are closed.

▶ Start the vehicle using the smartphone. After every engine start, the engine runs for ten minutes.

You can carry out a maximum of two consecutive starting attempts. You must start the vehicle once with the SmartKey before trying to start the engine again with the smartphone. you can stop the vehicle again at any time.

ⓘ Further information can be found in the smartphone app.

Securing the engine against starting before carrying out maintenance or repair work:

- ▶ Switch on the hazard warning light system.
or
- ▶ Unlock the doors.
or
- ▶ Open a side window or the sliding sunroof.

Breaking-in notes

To preserve the engine during the first 1000 miles (1500 km):

- Drive at varying road speeds and engine speeds.
- Do not drive at speeds greater than 85 mph (140 km/h).
- Drive the vehicle in drive program **C** or **E**.
- Shift to the next highest gear at the very latest when the needle reaches the last third before the red area in the tachometer.

- Do not shift down a gear manually in order to brake.
- Avoid overstraining the vehicle, e.g. driving at full throttle.
- Do not depress the accelerator pedal past the pressure point (kickdown).
- Only increase the engine speed gradually and accelerate the vehicle to full speed after 1000 miles (1500 km).

This also applies when the engine or parts of the drivetrain have been replaced.

Please also observe the following breaking-in notes:

- In certain driving and driving safety systems, the sensors adjust automatically while a certain distance is being driven after the vehicle has been delivered or after repairs. Full system effectiveness is not reached until the end of this teach-in process.
- Brakepads, brake discs and tires that are either new or have been replaced only achieve optimum braking effect and grip after several hundred kilometers of driving. Com-

pensate for the reduced braking effect by applying greater force to the brake pedal.

Notes on optimized acceleration

If all necessary requirements and activation conditions are fulfilled, the best possible acceleration can be achieved from a standstill.

Do not use the optimized acceleration on public roads. Individual wheels could spin and you could lose control of the vehicle. There is an increased risk of skidding and/or accident.

Be sure to observe the safety notes and information on ESP® (→ page 163).

Pulling away with optimized acceleration

⚠ WARNING Risk of skidding and having an accident from wheels spinning

When you use optimized acceleration, individual wheels could spin and you could lose control of the vehicle.

If ESP® is deactivated, there is a risk of skidding and accident.

- ▶ Make sure that no persons or obstacles are in the close vicinity of your vehicle.

Requirements:

- The vehicle has been broken in (→ page 136).
- The vehicle and tires are in good condition.
- You are on a high-grip roadway.
- The engine and transmission are at normal operating temperature.

! **NOTE** Increased wear due to optimized acceleration

When pulling away with optimized acceleration, all components of the drivetrain are subjected to a very high load.

This can lead to increased component wear.

- ▶ Do not always pull away with optimized acceleration.

- ▶ Engage the **[D]** drive position (→ page 149).

- ▶ Move the steering wheel to the straight-ahead position.
- ▶ Select the sportiest available drive program **S** or **S** (→ page 146).
- ▶ Deactivate ESP® (→ page 165).
- ▶ Depress and hold the brake pedal firmly with your left foot.
- ▶ With your right foot, fully depress the accelerator pedal.
- ▶ After no more than five seconds, take your left foot quickly off the brake, but keep the accelerator pedal depressed. The vehicle pulls away at maximum acceleration.
- ▶ Switch on ESP® once the acceleration procedure is complete.

Ending optimized acceleration

- ▶ Remove your foot from the accelerator pedal.
- ▶ Reactivate the ESP®.
- ⓘ After you pull away with optimized acceleration, components of the drivetrain can become very hot, which means that opti-

mized acceleration values may be reached again only after a few minutes.

Notes on driving

⚠ WARNING Risk of accident due to objects in the driver's footwell

Objects in the driver's footwell may impede pedal travel or block a depressed pedal.

This jeopardizes the operating and road safety of the vehicle.

- ▶ Stow all objects in the vehicle securely so that they cannot get into the driver's footwell.
- ▶ Always install the floor mats securely and as prescribed in order to ensure that there is always sufficient room for the pedals.
- ▶ Do not use loose floor mats and do not place floor mats on top of one another.

⚠ WARNING Risk of accident due to incorrect footwear

Incorrect footwear includes, for example:

- Shoes with platform soles
- Shoes with high heels
- Slippers

- ▶ Always wear suitable footwear so that you can operate the pedals safely.

⚠ WARNING Risk of accident if the ignition is switched off while driving

If you switch off the ignition while driving, safety functions are restricted or no longer available.

You will need to use considerably more force to steer and brake, for example.

- ▶ Do not switch off the ignition while driving.

⚠ DANGER Risk of death caused by exhaust gases

Combustion engines emit poisonous exhaust gases such as carbon monoxide. Inhaling these exhaust gases is hazardous to health and leads to poisoning.

- ▶ Never leave the engine or, if present, the auxiliary heating running in an enclosed space without sufficient ventilation.

⚠ WARNING Risk of skidding and of an accident due to shifting down on slippery road surfaces

If you shift down on slippery road surfaces to increase the engine braking effect, the drive wheels may lose traction.

- ▶ Do not shift down on slippery road surfaces to increase the engine braking effect.

⚠ DANGER Risk of fatal injury due to poisonous exhaust gases

If the tailpipe is blocked or sufficient ventilation is not possible, poisonous exhaust gases such as carbon monoxide may enter the vehicle. This is the case when the vehicle becomes stuck in snow, for example.

- ▶ Keep the tailpipe and the area around the vehicle free from snow when the engine or the stationary heater are running.
- ▶ Open a window on the side of the vehicle facing away from the wind to ensure an adequate supply of fresh air.

⚠ WARNING Risk of accident and injury due to being under the influence of alcohol and drugs while driving

Drinking and driving and/or taking drugs and driving are very dangerous combinations. Even a small amount of alcohol or drugs can affect your reflexes, perceptions and judgment.

The possibility of a serious or even fatal accident are greatly increased when you drink or take drugs and drive.

- ▶ Do not drink or take drugs and drive or allow anyone to drive who has been drinking or taking drugs.

⚠ WARNING Risk of accident due to the brake system overheating

If you leave your foot on the brake pedal when driving, the brake system may overheat.

This increases the braking distance and the brake system may even fail.

- ▶ Never use the brake pedal as a footrest.
- ▶ Do not depress the brake pedal and the accelerator pedal at the same time while driving.

! **NOTE** Engine damage due to excessively high engine speeds

The engine will be damaged if you drive with the engine in the overrevving range.

- ▶ Do not drive with the engine in the overrevving range.

! **NOTE** Wearing out the brake linings by continuously depressing the brake pedal

- ▶ Do not depress the brake pedal continuously whilst driving.
- ▶ To use the braking effect of the engine, shift to a lower gear in good time.

! **NOTE** Damage to the drivetrain and engine when pulling away

- ▶ Do not warm up the engine while the vehicle is stationary. Pull away immediately.
- ▶ Avoid high engine speeds and driving at full throttle until the engine has reached its operating temperature.

! **NOTE** Damage to the catalytic converter due to non-combusted fuel

The engine is not running smoothly and is misfiring.

Non-combusted fuel may get into the catalytic converter.

- ▶ Only depress the accelerator pedal slightly.
- ▶ Have the cause rectified immediately at a qualified specialist workshop.

Notes on driving on salt-treated roads

The braking effect is limited on salt-treated roads.

Therefore, observe the following notes:

- Due to salt build-up on the brake discs and brakepads, the braking distance can increase considerably or result in braking only on one side
- Maintain a much greater safe distance to the vehicle in front

To remove salt build-up:

- Brake occasionally while paying attention to the traffic conditions
- Carefully depress the brake pedal at the end of the journey and when starting the next journey

Notes on hydroplaning

Hydroplaning can take place once a certain amount of water has accumulated on the road surface.

Observe the following notes during heavy precipitation or in conditions in which hydroplaning may occur:

- Reduce speed
- Avoid tire ruts
- Avoid sudden steering movements
- Brake carefully

i Also observe the notes on regularly checking wheels and tires (→ page 296).

Notes on driving through water on the road surface

Water which has entered into the vehicle can damage the engine, electrics and transmission.

Water can also enter the air intake of the engine and cause engine damage.

Observe the following if you must drive through water:

- The water, when calm, may only reach the lower edge of the vehicle body.
- Drive at a maximum speed of 6 mph (10 km/h); water can otherwise enter the vehicle interior or engine compartment.
- Vehicles traveling in front, or oncoming vehicles, can create waves which may exceed the maximum permissible depth of the water.

The braking effect of the brakes is reduced after fording. Brake carefully while paying attention to the traffic conditions until braking power has been fully restored.

ECO start/stop function

Operation of the ECO start/stop function

- ⓘ The ECO start/stop function is not available in all drive programs, depending on the engine. Observe the status display in the multifunction display for this.

The engine is switched off automatically in the following situations if all vehicle conditions for an automatic engine stop are met:

- You brake the vehicle to a standstill in transmission position **D** or **N**.
- **Vehicles with a 48 V on-board electrical system:** you depress the brake pedal when traveling at a low speed.

If the system has detected one of the following situations, the engine will not stop:

- You stop at a stop sign and there is no vehicle in front of you.
- The vehicle that stopped in front of you starts up again.
- You maneuver, turn the steering wheel sharply or engage reverse gear.





- ⓘ If the system detects an intelligent stop inhibitor, e.g. a stop sign, the engine will not stop.

If you activate the HOLD function or engage the park position **P**, the engine can be switched off in spite of an intelligent stop inhibitor.

The engine is restarted automatically if:

- You engage transmission position **D** or **R**.
- You depress the accelerator pedal.
- An automatic engine start is required by the vehicle.
- You release the brake pedal.
- **Vehicles with a 48 V on-board electrical system:**
 - You release the brake pedal on a downhill gradient and the vehicle does not roll.
 - The vehicle rolls on a downhill gradient and does not automatically enter glide mode at 15 mph (20 km/h).

ECO start/stop function symbols in the multifunction display:

- The  symbol (green) appears when the vehicle is at a standstill: the engine was switched off by the ECO start/stop function.
- The  symbol (yellow) appears when the vehicle is at a standstill: not all vehicle conditions for an engine stop have been met.
- Neither the  nor  symbol appears when the vehicle is at a standstill: an intelligent stop inhibitor was detected, e.g. a stop sign.
- The  symbol appears: the ECO start/stop function is deactivated or there is a malfunction.

If the engine was switched off by the ECO start/stop function and you leave the vehicle, a warning tone sounds and the engine is not restarted. In addition, the following display message appears in the multifunction display:

Vehicle Ready to Drive Switch the Ignition Off Before Exiting

If you do not switch off the ignition, it is automatically switched off after three minutes.

Deactivating or activating the ECO start/stop function

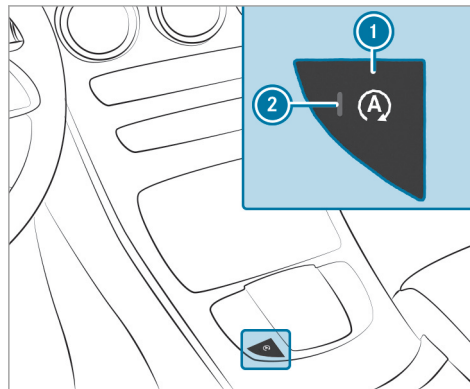

- ▶ Press button .
- If indicator lamp  lights up, the ECO start/stop function is activated.

-  Depending on the model and the vehicle equipment, the button may also be located at a different position in the center console.

ECO display function

The ECO display summarizes your driving characteristics from the start of the journey to its completion and assists you in achieving the most economical driving style.

You can influence consumption by doing the following:

- Drive with particular care
- Follow the gearshift recommendations

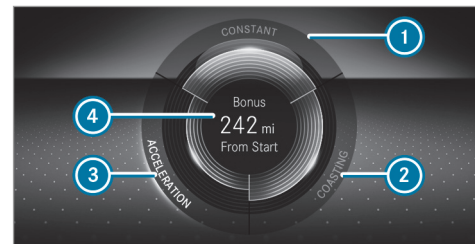

The lettering in the segment will light up brightly, the outer edge will light up and the segment will fill up when the following driving style is adopted:

- ① Steady speed
- ② Gentle deceleration and rolling
- ③ Moderate acceleration

The lettering in the segment will be gray, the outer edge will be dark and the segment will empty when the following driving style is adopted:

- ① Fluctuations in speed
- ② Heavy braking
- ③ Sporty acceleration

The ECO display will show you when you have driven economically:

- The three segments will fill up completely at the same time
- The edges around all three segments will light up

The additional range achieved as a result of your driving style in comparison with a driver with a very sporty driving style will be shown in the center of display ④. The range displayed does not indicate a fixed reduction in consumption.

ECO Assist function

Vehicles with a 48 V on-board electrical system (EQ Boost technology):

ECO Assist analyzes data for the vehicle's expected route. This allows the system to optimally adjust the driving style for the route ahead, save fuel and recuperate. If the system detects an event ahead, e.g. a speed limit or a roundabout, it will appear on the multifunction display. The following symbols can be displayed:

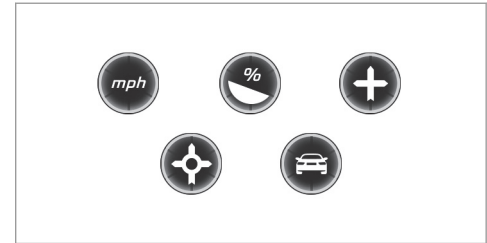

Examples of an event ahead

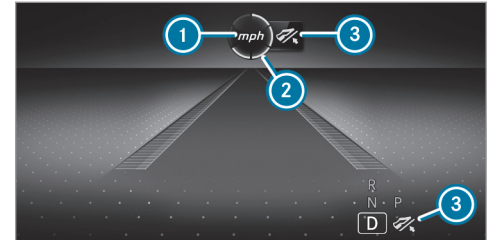

- ① Event ahead
- ② Distance display for the event ahead
- ③ "Foot off the accelerator" prompt

The segments of distance display ② show the distance to the event ahead as follows:

- A few segments light up: the event ahead is near.
- Many segments light up: the event ahead is further away.

When the vehicle nears the event, ECO Assist will calculate the optimal speed for maximum fuel economy and recuperative energy based on the distance, speed and gradient. The **Foot off the Accelerator** message ③ appears on the multifunction display. The first segments in front of the vehicle will turn green. The remaining segments will initially stay white. If the driver takes their foot off the accelerator pedal in good time, the remaining segments on the display will successively turn green until the event shown is reached. The drivetrain will be set for maximum fuel economy. Recuperation will charge the battery. Recuperation will be adapted to the selected drive program.

The event will be shown for a short time after it has been passed. If there is no response to the

Foot off the Accelerator prompt, the segments will remain white.

If the event involves a vehicle in front, all segments will immediately turn green once there is a response to the **Foot off the Accelerator** prompt.

For active ECO Assist in drive program [E], symbol ③ will appear on the multifunction display and on the Head-up Display beside transmission position [D]. Symbol ③ will also appear when the assistant display is not selected.

If the system does not intervene during the event ahead, nothing will be displayed. The system will be passive.

ECO Assist is active only in drive programs [E] and [C].

System limits

ECO Assist can function even more precisely if the route is adhered to when route guidance is active. The basic function is also available without active route guidance. Not all information and traffic situations can be foreseen. The quality depends on the map data.

ECO Assist is only an aid. The driver is responsible for keeping a safe distance from the vehicle in front, for vehicle speed and for braking in good time. The driver must be ready to brake at all times irrespective of whether the system intervenes.

The system may be impaired or may not function in the following situations:

- If visibility is poor, e.g. due to insufficient illumination of the road, highly variable shade conditions, rain, snow, fog or heavy spray.
- If there is glare, e.g. from oncoming traffic, direct sunlight or reflections.
- If there is dirt on the windshield in the area of the multifunction camera or the camera is fogged up, damaged or obscured.
- If traffic signs are hard to discern, e.g. due to dirt, snow or insufficient lighting, or because they are obscured.
- If the information on the navigation system's digital map is incorrect or out of date.
- If signs are ambiguous, e.g. traffic signs in roadworks or in adjacent lanes.

Displaying ECO Assist

On-board computer:

- ↳ DriveAssist
- ▶ Select ECO Assist.

DYNAMIC SELECT switch

Function of the DYNAMIC SELECT switch

! NOTE Mercedes-AMG vehicles

- ▶ Observe the notes in the Supplement. You could otherwise fail to recognize dangers.

i Depending on the engine and equipment, the vehicle has different drive programs.

Use the DYNAMIC SELECT switch to change between the following drive programs.

The drive program selected appears in the multi-function display of the on-board computer.

I* Individual

- Individual settings

S+ Sport+

- Particularly sporty driving
- Emphasizes the vehicle's own oversteering and understeering characteristics for a more active driving style
- Only suitable for good road conditions, a dry road surface and a clear stretch of road

S Sport

- Continues to offer stability but with a sporty setup
- Allows the sporty driver a more active driving style
- Only suitable for good road conditions, a dry road surface and a clear stretch of road

C Comfort

- Comfortable and economical driving
- Balance between traction and stability
- Recommended for all road conditions

E Eco

- Particularly economical driving

- Balance between traction and stability
- Recommended for all road conditions

Depending on the drive program, the following systems change their characteristics:

- Drive:
 - Engine and transmission management
 - Active Distance Assist DISTRONIC
- ESP®
- **Vehicles with AIR BODY CONTROL or DYNAMIC BODY CONTROL:** suspension
- Electric power steering

Selecting the drive program

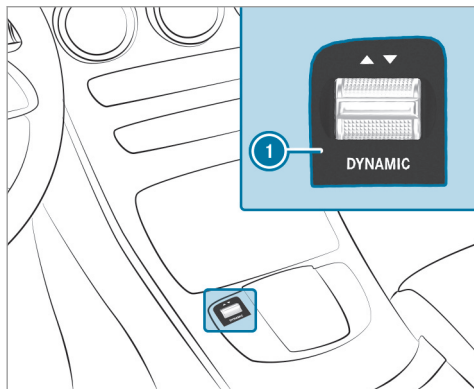

- ▶ Press DYNAMIC SELECT switch ① forwards or backwards. The drive program selected appears in the multifunction display.

Configuring DYNAMIC SELECT (multimedia system)

Multimedia system:

- ▶ Home ▶ Settings ▶ Vehicle
- ▶ DYNAMIC SELECT

Setting drive program I

- ▶ Select **Individual Configuration**.
- ▶ Select and set a category.

Switching the restoration display on or off

- ▶ Switch **Request at Start** on or off.

Function on: the next time the vehicle is started a prompt appears asking whether the last active drive program should be restored. If the ECO start/stop function was deactivated, an additional prompt appears asking if the function should remain deactivated.

- ① The prompt appears only if the previously active settings deviate from the standard settings.

Function off: the next time the vehicle is started the **[C]** drive program is set automatically.

The ECO start/stop function is activated automatically.

- ① This function must be activated for each user profile separately. Only when this function is activated will the drive program and Eco start/stop setting for the previous journey be saved for the respective user profile.

Displaying vehicle data

Multimedia system:

- ▶ Home ▶ Info
- ▶ Select **Vehicle**. The vehicle data is displayed.

Displaying engine data

Multimedia system:

- ▶ Home ▶ Info
- ▶ Select **Engine**. The engine data is displayed.

- i** The actual (maximum) values that can be achieved for engine output and engine torque may deviate from the certified values within the country-specific guidelines for permissible tolerances (basis: UN-ECE No. 85 or country-specific guidelines). Factors that can influence this are, for example:
- Sea level
 - Fuel grade
 - Outside temperature
 - Operating temperature of the engine
- i** The values displayed serve only as orientation. The values for engine output and engine torque shown in the media display may deviate from the actual values.

Calling up the consumption indicator

Multimedia system:



- ▶ Select **Consumption**. The current and average consumption is displayed.

Automatic transmission

DIRECT SELECT lever

Function of the DIRECT SELECT lever

- ⚠ WARNING** Risk of accident due to incorrect gearshifting

If the engine speed is higher than the idle speed and you engage the transmission position **D** or **R**, the vehicle may accelerate sharply.

- ▶ If you engage the transmission position **D** or **R** when the vehicle is at a standstill, always depress the brake pedal firmly and do not accelerate at the same time.

- ⚠ WARNING** Risk of accident and injury due to children left unattended in the vehicle

If children are left unsupervised in the vehicle, they could, in particular:

- Open doors, thereby endangering other persons or road users.
- Get out and be struck by oncoming traffic.
- Operate vehicle equipment and become trapped, for example.

In addition, the children could also set the vehicle in motion, for example by:

- Releasing the parking brake.
 - Changing the transmission position.
 - Starting the vehicle.
- ▶ Never leave children unattended in the vehicle.
 - ▶ When leaving the vehicle, always take the SmartKey with you and lock the vehicle.

- ▶ Keep the vehicle SmartKey out of reach of children.

Use the DIRECT SELECT lever to switch the transmission position. The current transmission position is displayed in the multifunction display.

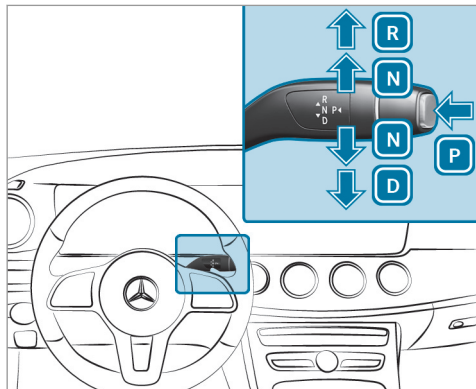

- P** Park position
- R** Reverse gear

- N** Neutral
- D** Drive position

Engaging reverse gear R

- ▶ Depress the brake pedal and push the DIRECT SELECT lever upwards past the first point of resistance.

Engaging neutral N

- ▶ Depress the brake pedal and push the DIRECT SELECT lever up or down to the first point of resistance.

- i** To shift into neutral **N** with the ignition on, push the selector lever up or down for several seconds to the first point of resistance.

Subsequently releasing the brake pedal will allow you to move the vehicle freely, e.g. to push it or tow it away.

Proceed as follows if you want the automatic transmission to remain in neutral **N, even if the ignition is switched off or the driver's door is opened:**

- ▶ Depress the brake pedal and engage neutral **N** when the vehicle is at a standstill.

- ▶ Release the brake pedal.
- ▶ Switch the ignition off.

- i** If you then exit the vehicle leaving the SmartKey in the vehicle, the automatic transmission remains in neutral **N**.

Engaging park position P

- ▶ Observe the notes on parking the vehicle (→ page 154).

- ▶ Depress the brake pedal until the vehicle is at a standstill.

- ▶ When the vehicle is at a standstill, press button **P**.

When the transmission position display shows **P**, the park position is engaged. If no transmission position display **P** appears, secure the vehicle to prevent it from rolling away.

- i** Depending on the situation, it may take a short time until **P** is engaged. Therefore, always pay attention to the transmission position display.

Park position **P** is engaged automatically if one of the following conditions is met:

- You switch off the ignition when the vehicle is stationary and the transmission position is **D** or **R**.
 - You open the driver's door when the vehicle is at a standstill or when driving at a very low speed and the transmission position is **D** or **R**.
- i** To maneuver with an open driver's door, open the driver's door while at a standstill and engage transmission position **D** or **R** again.

Engaging drive position D

- ▶ Depress the brake pedal and push the DIRECT SELECT lever down past the first point of resistance.

When the automatic transmission is in transmission position **D**, it shifts the gears automatically. This depends, among other things, on the following factors:

- The selected drive program
- The position of the accelerator pedal

- The driving speed

Problems with the transmission

The transmission has a faulty gear shift

Possible cause:

- The transmission is losing oil.
- ▶ Have the transmission checked at a qualified specialist workshop immediately.

The acceleration characteristics get worse, and the transmission no longer shifts.

Possible cause:

- The transmission is in emergency operation mode: it is only possible to shift to one gear and reverse gear.
- ▶ Pull over and stop the vehicle safely as soon as possible, paying attention to road and traffic conditions.
 - ▶ Shift the transmission to position **P**.
 - ▶ Switch off the engine.
 - ▶ Wait at least ten seconds.

- ▶ Try to start the engine again.
- ▶ Shift the transmission to position **D** or **R**. If **D** is selected, the transmission only shifts to one gear; if **R** is selected, the transmission shifts to reverse gear.
- ▶ Have the transmission checked at a qualified specialist workshop immediately.

Manual gearshifting

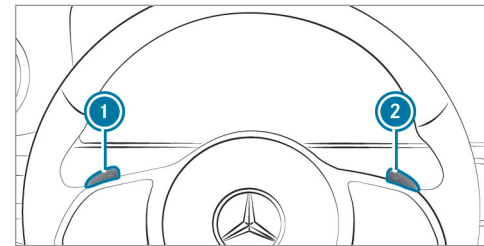

When the automatic transmission is shifted to position **D**, you can manually shift it with the steering wheel gearshift paddle. If permitted, the automatic transmission shifts to a higher or

lower gear depending on the steering wheel gearshift paddle being pulled.

You have two options to manually shift the automatic transmission:

- Temporary setting
- Permanent setting

The gears shift automatically when manual gearshifting is deactivated.

Temporary setting:

- ▶ **To activate:** pull steering wheel gearshift paddle ① or ②.
Manual gearshifting is activated for a short time. The transmission position display shows **M** and the current gear.

- ① How long the manual gearshifting stays activated is dependent on various factors.

Manual gearshifting can be automatically deactivated in the following cases:

- Changing the drive program
- Restarting the vehicle
- When the transmission position **D** is engaged again

- Driving style

- ▶ **To shift up:** pull steering wheel gearshift paddle ②.
- ▶ **To shift down:** pull steering wheel gearshift paddle ①.
- ▶ **To deactivate:** pull steering wheel gearshift paddle ② and hold it in place.
The transmission position display shows **D**.

Permanent setting:

- ▶ Change to drive program **I*** (→ page 146).
- ▶ Select drive setting **M** (→ page 146).

Gearshift recommendation

The gearshift recommendation assists you in adopting an economical driving style.

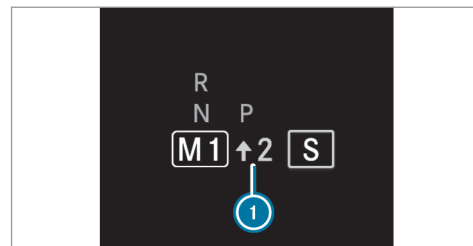

- ▶ If gearshift recommendation ① appears next to the transmission position display, shift to the recommended gear.

Using kickdown

- ▶ **Maximum acceleration:** depress the accelerator pedal beyond the pressure point.

To protect against engine overrev, the automatic transmission shifts up to the next gear when maximum engine speed has been reached.

Glide mode function

! NOTE Mercedes-AMG vehicles

- ▶ Observe the notes in the Supplement. You could otherwise fail to recognize dangers.

With an anticipatory driving style, glide mode helps you to reduce fuel consumption.

Glide mode is characterized by the following:

- The combustion engine is disconnected from the drivetrain and continues to run in neutral.
- The transmission position display **D** is shown in green.
- **Vehicles with 48 V on-board electrical system (EQ-Boost technology):** the combustion engine can be switched off. All of the vehicle functions remain active.

Glide mode is activated if the following conditions are met:

- Drive program **E** is selected.
- The speed is within a suitable range.

- The road's course is suitable, e.g. no steep uphill or downhill inclines or tight curves.
- you do not depress the accelerator or brake pedal (except for light brake applications).
- ① Glide mode can also be activated if you have selected the "Eco" setting for the drive in the drive program **IV**.

Glide mode is deactivated again if one of the conditions is no longer met.

Glide mode can also be prevented by the following parameters:

- Incline
- Downhill gradient
- Temperature
- Height
- Speed
- Operating status of the engine
- Traffic situation

Function of the 4MATIC

4MATIC ensures that all four wheels are driven. Together with ESP® and 4ETS, 4MATIC improves the traction of your vehicle whenever a driven wheel spins due to insufficient traction.

If you fail to adapt your driving style, 4MATIC can neither reduce the risk of an accident nor override the laws of physics. 4MATIC cannot take account of road, weather and traffic conditions. 4MATIC is only an aid. You are responsible especially for maintaining a safe distance from the vehicle in front, for vehicle speed, for braking in good time and for staying in lane.

- ① In wintry road conditions, the maximum effect of 4MATIC can be achieved only if you use winter tires (M+S tires), with snow chains if necessary.

Refueling

Refueling the vehicle

⚠ WARNING Risk of fire or explosion from fuel

Fuels are highly flammable.

- ▶ Fire, open flames, smoking and creation of sparks must be avoided.
- ▶ Switch off the ignition and, if available, the stationary heater, before and while refueling the vehicle.

⚠ WARNING Risk of injury from fuels

Fuels are poisonous and hazardous to your health.

- ▶ Do not swallow fuel or let it come into contact with skin, eyes or clothing.
- ▶ Do not inhale fuel vapor.
- ▶ Keep children away from fuel.
- ▶ Keep doors and windows closed during the refueling process.

If you or other people come into contact with fuel, observe the following:

- ▶ Immediately rinse fuel off your skin with soap and water.
- ▶ If fuel comes into contact with your eyes, immediately rinse them thoroughly with clean water. Seek medical attention immediately.
- ▶ If you swallow fuel, seek medical attention immediately. Do not induce vomiting.
- ▶ Change immediately out of clothing that has come into contact with fuel.

⚠ WARNING Risk of fire and explosion due to electrostatic charge

Electrostatic charge can ignite fuel vapor.

- ▶ Before you open the fuel filler cap or take hold of the pump nozzle, touch the metallic vehicle body.

- ▶ To avoid creating another electrostatic charge, do not get into the vehicle again during the refueling process.

! NOTE Damage caused by the wrong fuel

Vehicles with a gasoline engine:

Even small amounts of the wrong fuel could result in damage to the fuel system, the engine and the emission control system.

- ▶ Only refuel with low-sulfur gasoline.

This fuel may contain up to 10% ethanol. Your vehicle is suitable for use with E10 fuel.

Never refuel with one of the following fuels:

- Diesel
- Gasoline with more than 10% ethanol by volume, e.g. E15, E85, E100
- Gasoline with more than 3% methanol by volume, e.g. M15, M30, M85, M100
- Gasoline with additives containing metal

If you have accidentally refueled with the wrong fuel:

- ▶ Do not switch the ignition on.
- ▶ Consult a qualified specialist workshop.

! **NOTE** Do not use diesel to refuel vehicles with a gasoline engine

If you have accidentally refueled with the wrong fuel:

- Do not switch the ignition on. Otherwise fuel can enter the engine.
Even small amounts of the wrong fuel could result in damage to the fuel system and the engine. The repair costs are high.
- ▶ Consult a qualified specialist workshop.
- ▶ Have the fuel tank and fuel lines drained completely.

! **NOTE** Damage to the fuel system caused by overfilled fuel tanks

- ▶ Only fill the fuel tank until the pump nozzle switches off.

Requirements:

- The vehicle is unlocked.
- ⓘ Do not get into the vehicle again during the refueling process. Otherwise, electrostatic charge could build up again.

Observe the notes on operating fluids and fuel. Only refuel with fuel that has at least the octane number specified in the information label in the fuel filler flap. Otherwise, engine output can be reduced and fuel consumption increased.

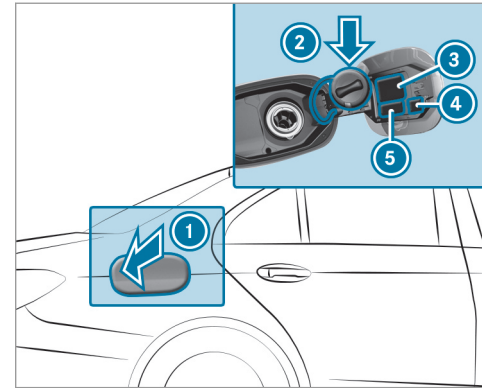

- ① Fuel filler flap
- ② Bracket for fuel filler cap
- ③ Tire pressure table
- ④ QR code for rescue card
- ⑤ Fuel type

- ▶ Press on the back area of fuel filler flap ①.
- ▶ Turn the fuel filler cap counter-clockwise and remove it.

- ▶ Insert the fuel filler cap from above into bracket ②.
- ▶ Completely insert the pump nozzle into the tank filler neck, hook in place and refuel.
- ▶ Only fill the fuel tank until the pump nozzle switches off.
- ▶ Replace the cap on the filler neck and turn clockwise until it engages audibly.
- ▶ Close fuel filler flap ①.

Parking

Parking the vehicle

⚠ WARNING Risk of accident and injury caused by an insufficiently secured vehicle rolling away

If the vehicle is not securely parked sufficiently, it can roll away in an uncontrolled way even at a slight downhill gradient.

- ▶ On uphill or downhill gradients, turn the front wheels so that the vehicle rolls towards the curb if it starts moving.

- ▶ Apply the parking brake.
- ▶ Switch the transmission to position **P**.

⚠ WARNING Risk of fire caused by hot exhaust system parts

Flammable materials such as leaves, grass or twigs may ignite.

- ▶ Park the vehicle so that no flammable material can come into contact with hot vehicle components.
- ▶ In particular, do not park on dry grass-land or harvested grain fields.

⚠ WARNING Risk of accident and injury due to children left unattended in the vehicle

If children are left unsupervised in the vehicle, they could, in particular:

- Open doors, thereby endangering other persons or road users.

- Get out and be struck by oncoming traffic.
- Operate vehicle equipment and become trapped, for example.

In addition, the children could also set the vehicle in motion, for example by:

- Releasing the parking brake.
- Changing the transmission position.
- Starting the vehicle.
- ▶ Never leave children unattended in the vehicle.
- ▶ When leaving the vehicle, always take the SmartKey with you and lock the vehicle.
- ▶ Keep the vehicle SmartKey out of reach of children.

! NOTE Damage to the vehicle due to it rolling away

- ▶ Always secure the vehicle against rolling away.

! **NOTE** Damage due to the vehicle lowering

Vehicles with AIR BODY CONTROL or level control: The vehicle can lower because of temperature differences or longer non-operational times. This can cause damage to parts of the body.

- ▶ When stopping the vehicle and when driving off, make sure that there are no obstacles such as curbs under or in the immediate vicinity of the body.

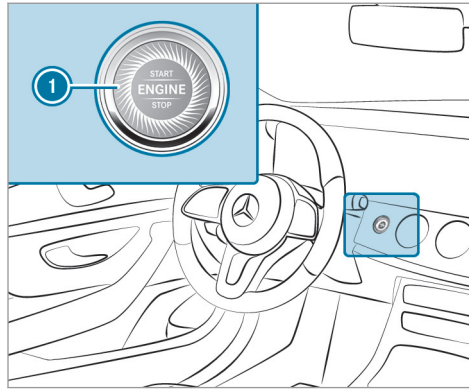

- ▶ Bring the vehicle to a standstill by pressing the brake pedal.
- ▶ On gradients, turn the front wheels so that the vehicle will roll towards the curb if it starts moving.
- ▶ Apply the electric parking brake.

- ▶ Engage transmission position **P** in a stationary vehicle with the brake pedal applied (→ page 148).
- ▶ Switch off the engine and the ignition by pressing button **1**.
- ▶ Release the service brake slowly.
- ▶ Get out of the vehicle and lock it.
- i** When you park the vehicle, you can still operate the side windows and the sliding sunroof for approximately four minutes if the driver's door is closed.

Garage door opener

Programming buttons for the garage door opener

! **DANGER** Risk of death caused by exhaust gases

Combustion engines emit poisonous exhaust gases such as carbon monoxide. Inhaling these exhaust gases is hazardous to health and leads to poisoning.

- ▶ Never leave the engine or, if present, the auxiliary heating running in an enclosed space without sufficient ventilation.

⚠ WARNING Risk of injury when opening or closing a door with the garage door opener

When you operate or program the door with the integrated garage door opener, persons in the range of movement of the door may become trapped or be struck by the door.

- ▶ Always make sure that nobody is within the range of movement of the door.

Only operate the following doors using the garage door opener:

- Doors with a safety stop and reversing feature
- Doors which conform to the current U.S. safety standards

Requirements:

- The vehicle has been parked outside the garage or outside the range of movement of the door.
 - The engine is switched off.
 - The ignition is switched on.
- i** The garage door opener function is always available when the ignition is switched on.

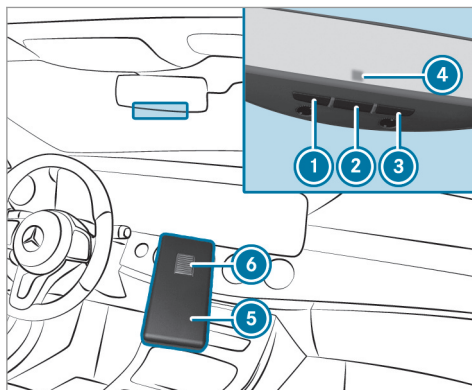

- ▶ Check if the transmitter frequency of the remote control has the frequency range of 280 to 868 MHz.

Radio equipment approval number:

- NZLMUAHL5 (USA)
- 4112A-MUAHL5 (Canada)

- ▶ Press and hold button **1**, **2** or **3** that you wish to program. Indicator lamp **4** flashes yellow.

i It can take up to 20 seconds before the indicator lamp flashes yellow.

- ▶ Release the previously pressed button. Indicator lamp **4** continues to flash yellow.

- ▶ Point remote control **5** from a distance of 0.4 in (1 cm) to 3 in (8 cm) towards button **1**, **2** or **3**.

- ▶ Press and hold button **6** of remote control **5** until one of the following signals appears:

- Indicator lamp **4** lights up green continuously. Programming is complete.
- Indicator lamp **4** flashes green. Programming was successful. Additionally,

synchronization of the rolling code with the door system must also be carried out.

- ▶ If indicator lamp ④ does not light up or flash green: repeat the procedure.
- ▶ Release all of the buttons.
- ⓘ The remote control for the door drive is not included in the scope of delivery of the garage door opener.

Synchronizing the rolling code

Requirements:

- The door system uses a rolling code.
 - The vehicle must be within range of the garage door or door drive.
 - The vehicle as well as persons and objects are located outside the range of movement of the door.
- ▶ Press the programming button on the door drive unit.
Initiate the next step within approximately 30 seconds.

- ▶ Press previously programmed button ①, ② or ③ repeatedly until the door closes. When the door closes, programming is completed.

- ⓘ Please also read the operating instructions for the door drive.

Troubleshooting when programming the remote control

- ▶ Check if the transmitter frequency of remote control ⑤ is supported.
- ▶ Replace the batteries in remote control ⑤.
- ▶ Hold remote control ⑤ at various angles from a distance of 0.4 in (1 cm) to 3 in (8 cm) front of the inside rearview mirror. You should test every position for at least 25 seconds before trying another position.
- ▶ Hold remote control ⑤ at the same angles at various distances in front of the inside rearview mirror. You should test every position for at least 25 seconds before trying another position.

- ▶ On remote controls that transmit only for a limited period, press button ⑥ on remote control ⑤ again before transmission ends.

- ▶ Align the antenna line of the door opener unit with the remote control.

- ⓘ Support and additional information on programming:

- On the toll free HomeLink® Hotline on 1-800-355-3515
- On the Internet at <https://www.homelink.com/mercedes>

Opening or closing the garage door

Requirements:

- The corresponding button is programmed to operate the door.
- ▶ Press and hold buttons ①, ② or ③ until the door opens or closes.
- ▶ If indicator lamp ④ flashes yellow after approximately 20 seconds: press and hold the previously pressed button again until the door opens or closes.

Clearing the garage door opener memory

- ▶ Press and hold buttons ① and ③.
Indicator lamp ④ lights up yellow.
- ▶ If indicator lamp ④ flashes green: release buttons ① and ③.
The entire memory has been deleted.

Electric parking brake

Function of the electric parking brake (applying automatically)

⚠ WARNING Risk of accident and injury due to children left unattended in the vehicle

If children are left unsupervised in the vehicle, they could, in particular:

- Open doors, thereby endangering other persons or road users.
- Get out and be struck by oncoming traffic.
- Operate vehicle equipment and become trapped, for example.

In addition, the children could also set the vehicle in motion, for example by:

- Releasing the parking brake.
 - Changing the transmission position.
 - Starting the vehicle.
- ▶ Never leave children unattended in the vehicle.
 - ▶ When leaving the vehicle, always take the SmartKey with you and lock the vehicle.
 - ▶ Keep the vehicle SmartKey out of reach of children.

The electric parking brake is applied if the transmission is in position **P** and one of the following conditions is fulfilled:

- The engine is switched off.
 - The seat belt tongue is not inserted in the seat belt buckle of the driver's seat and the driver's door is opened.
- i** To prevent application: pull the handle of the electric parking brake.

In the following situations, the electric parking brake is also applied:

- Active Distance Assist DISTRONIC is bringing the vehicle to a standstill.
- The HOLD function is keeping the vehicle stationary.
- Active Parking Assist is keeping the vehicle stationary.

This is the case if one of the following conditions is also fulfilled:

- The engine is switched off.
- The seat belt tongue is not inserted in the seat belt buckle of the driver's seat and the driver's door is opened.
- There is a system malfunction.
- The power supply is insufficient.
- The vehicle is stationary for a lengthy period.

When the electric parking brake is applied, the red **PARK** (USA) or **(P)** (Canada) indicator lamp lights up in the instrument cluster.

The electric parking brake is not automatically applied if the engine is switched off by the ECO start/stop function.

Electric parking brake function (releasing automatically)

The electric parking brake is released when the following conditions are fulfilled:

- The driver's door is closed.
- The engine is running.
- The transmission is in position **D** or **R** and you depress the accelerator pedal or you shift from transmission position **P** to **D** or **R** when on level ground with the driver's door closed.
- If the transmission is in position **R**, the trunk lid must be closed.
- The seat belt tongue is inserted into the seat belt buckle of the driver's seat.

If the seat belt tongue is not inserted into the seat belt buckle of the driver's seat, one of the following conditions must be fulfilled:

- You shift from transmission position **P**.

- You have previously driven at speeds greater than 2 mph (3 km/h).

When the electric parking brake is released, the red **PARK** (USA) or **(P)** (Canada) indicator lamp in the instrument cluster goes out.

Applying/releasing the electric parking brake manually

Applying

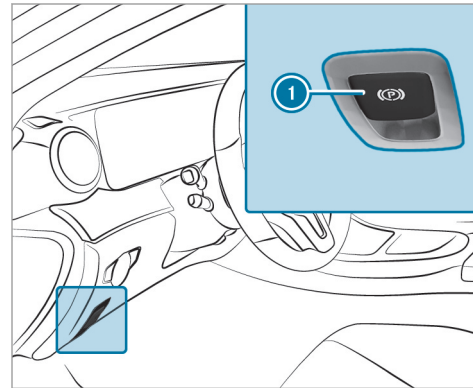

- ▶ Push handle **1**.
The red **PARK** (USA) or **(P)** (Canada) indicator lamp lights up in the instrument cluster.

- ⓘ The electric parking brake is only securely applied if the indicator lamp is lit continuously.

Releasing

- ▶ Switch on the ignition.
- ▶ Pull handle **1**.
The red **PARK** (USA) or **(P)** (Canada) indicator lamp in the instrument cluster goes out.

Emergency braking

- ▶ Press and hold handle **1**.
As long as the vehicle is driving, the **Please Release Parking Brake** message is displayed and the red **(P)** indicator lamp flashes.

When the vehicle has been braked to a standstill, the electric parking brake is applied. The red **PARK** (USA) or **(P)** (Canada) indicator lamp lights up in the instrument cluster.

Information on collision detection on a parked vehicle

If a collision is detected when the tow-away alarm is armed on a locked vehicle, you will receive a notification in the multimedia system when you switch on the ignition.

You will receive information about the following points:

- The area of the vehicle that may have been damaged.
- The force of the impact.

The following situations can lead to inadvertent activation:

- The parked vehicle is moved, e.g. in a two-story garage.
- ① Deactivate the tow-away alarm in order to prevent inadvertent activation. If you deactivate the tow-away alarm, collision detection will also be deactivated.
- ① If the battery is severely discharged, the function for detecting a collision on a parked

vehicle is automatically deactivated to facilitate the next engine start.

System limits

Detection may be restricted in the following situations:

- The vehicle is damaged without impact, e.g. if an outside mirror is torn off or the paint is damaged by a SmartKey
- An impact occurs at low speed
- The electric parking brake is not applied

Notes on parking the vehicle for an extended period

If you leave the vehicle parked for longer than six weeks, it may suffer damage through disuse.

The 12 V battery may also be impaired or damaged by heavy discharging.

- ① Further information can be obtained at a qualified specialist workshop.

Standby mode (extension of the starter battery's period out of use)

Standby mode function

① This function is not available for all models. If standby mode is activated, energy loss will be minimised during extended periods of non-operation.

Standby mode is characterised by the following:

- The starter battery is preserved.
- The maximum non-operational time appears in the media display.
- The connection to online services is interrupted.
- The ATA (anti-theft alarm system) is not available.
- The interior motion sensor and tow-away alarm functions are not available.
- The function for detecting collisions on a parked vehicle is not available.

If the following conditions are fulfilled, standby mode can be activated or deactivated using the multimedia system:

- The engine is switched off.
- The ignition is switched on.

Exceeding the vehicle's displayed non-operational time may cause inconvenience, i.e. it cannot be guaranteed that the starter battery will reliably start the engine.

The starter battery must be charged first in the following situations:

- The vehicle's non-operational time must be extended.
 - The **Battery Charge Insufficient for Standby Mode** message appears in the media display.
- i** Standby mode is automatically deactivated when the ignition is switched on.

Activating/deactivating standby mode (parking the vehicle for an extended period)

Requirements:

- The engine is switched off.

Multimedia system:

→  >> Settings >> Vehicle

- ▶ Activate or deactivate **Standby Mode**.
- ▶ Select **Yes**.

Driving and driving safety systems

Driving systems and your responsibility

Your vehicle is equipped with driving systems which assist you in driving, parking and maneuvering the vehicle. The driving systems are only aids. They are not a substitute for your attention to the surroundings and do not relieve you of your responsibility pertaining to road traffic law. The driver is always responsible for maintaining a safe distance to the vehicle in front, for vehicle speed, for braking in good time and for staying in lane. Pay attention to the traffic conditions at all times and intervene when necessary. Be aware of the limitations regarding the safe use of these systems.

Driving systems can neither reduce the risk of accident if you fail to adapt your driving style nor override the laws of physics. They cannot always

take into account road, weather or traffic conditions.

Information on vehicle sensors and cameras

Some driving and driving safety systems use cameras as well as radar or ultrasonic sensors to monitor the area in front of, behind or next to the vehicle.

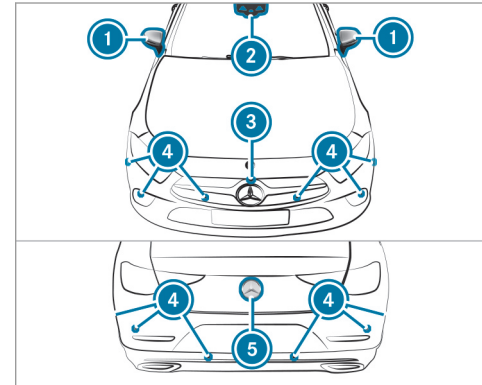

162 Driving and parking

- i The radar sensors are integrated behind the bumpers and/or behind the Mercedes star.
- 1 Cameras in the outside mirrors
- 2 Multifunction camera
- 3 Front camera
- 4 Ultrasonic sensors
- 5 Rear view camera

⚠ WARNING Risk of accident due to restricted detection performance of vehicle sensors and cameras

If the area around vehicle sensors or cameras is covered, damaged or dirty, certain driving and safety systems cannot function correctly. There is a risk of an accident.

- ▶ Keep the area around vehicle sensors or cameras clear of any obstructions and clean.
- ▶ Have damage to the bumper, radiator grille or stone chipping in the area of the front and rear windows repaired at a qualified specialist workshop.

Particularly, keep the areas around the sensors and cameras free of dirt, ice or slush (→ page 272). The sensors and cameras may not be covered and the detection ranges around them must be kept free. Do not attach additional license plate brackets, advertisements, stickers, foils or foils to protect against stone chippings in the detection range of the sensors and cameras. Make sure that there are no overhanging loads protruding into the detection range.

If there is damage to a bumper or the radiator grille, or after an impact, have the function of the sensors checked at a qualified specialist workshop. Have damage or stone chipping in the area of the cameras on the windshield and rear window repaired at a qualified specialist workshop.

Overview of driving systems and driving safety systems

- ABS (**A**nti-**l**ock **B**raking **S**ystem) (→ page 163)
- BAS (**B**rake **A**ssist **S**ystem) (→ page 163)

- ESP® (**E**lectronic **S**tability **P**rogram) (→ page 163)
- ESP® Crosswind Assist (→ page 165)
- EBD (**E**lectronic **B**rakeforce **D**istribution) (→ page 165)
- STEER CONTROL (→ page 165)
- HOLD function (→ page 166)
- Hill Start Assist (→ page 167)
- ATTENTION ASSIST (→ page 167)
- Cruise control (→ page 169)
- Traffic Sign Assist (→ page 187)
- DYNAMIC BODY CONTROL (→ page 196)
- AIR BODY CONTROL (→ page 196)

Driving Assistance package

The following functions are part of the Driving Assistance Package. Certain functions are only available in some countries. Some functions are also available without the Driving Assistance Package, albeit with restricted functionality.

- Active Distance Assist DISTRONIC (→ page 171)

- Active Speed Limit Assist (country-dependent) (→ page 175)
- Route-based speed adaptation (country-dependent) (→ page 176)
- Active Brake Assist (→ page 182)
- Active Steering Assist (country-dependent) (→ page 178)
- Active Emergency Stop Assist (country-dependent) (→ page 180)
- Active Lane Change Assist (country-dependent) (→ page 181)
- Active Stop-and-Go Assist (country-dependent) (→ page 177)
- Blind Spot Assist and Active Blind Spot Assist with exit warning (→ page 191)
- Active Lane Keeping Assist (→ page 194)

Parking Package

- Parking Assist PARKTRONIC (→ page 203)
- Rear view camera (→ page 198)
- Surround view camera (→ page 201)
- Active Parking Assist (country-dependent) (→ page 208)

Function of ABS

The Anti-lock Brake System (ABS) regulates the brake pressure in critical driving situations:

- During braking, e.g. at full brake application or insufficient tire traction, the wheels are prevented from locking.
- Vehicle steerability while braking is ensured.

If ABS intervenes when braking, you will feel a pulsing in the brake pedal. The pulsating brake pedal can be an indication of hazardous road conditions and can serve as a reminder to take extra care while driving.

Function of BAS

The Brake Assist System (BAS) supports your emergency braking situation with additional brake force.

If you depress the brake pedal quickly, BAS is activated:

- BAS automatically boosts the brake pressure.
- BAS can shorten the braking distance.

- ABS prevents the wheels from locking.

The brakes will function as usual once you release the brake pedal. BAS is deactivated.

Function of ESP® (Electronic Stability Program)

⚠ WARNING Risk of skidding if ESP® is deactivated

If you deactivate ESP®, ESP® cannot carry out vehicle stabilization.

- ▶ ESP® should only be deactivated in the following situations.

! NOTE Mercedes-AMG vehicles

- ▶ Observe the notes in the Supplement. You could otherwise fail to recognize dangers.

ESP® can monitor and improve driving stability and traction in the following situations, within physical limits:

- When pulling away on a wet or slippery road.
- When braking.

If the vehicle deviates from the direction desired by the driver, ESP® can stabilize the vehicle by intervening in the following ways:

- One or more wheels are braked.
- The engine output is adapted according to the situation.

When ESP® is deactivated, the  warning lamp lights up continuously:

- Driving stability will no longer be improved.
- The drive wheels could spin.
- ETS/4ETS traction control is still active.

 When ESP® is deactivated, you are still assisted by ESP® when braking.

When the  warning lamp flashes, one or several wheels has reached its grip limit:

- Adapt your driving style to suit the current road and weather conditions.
- Do not deactivate ESP®.
- Only depress the accelerator pedal as far as is necessary when pulling away.

Deactivate ESP® in the following situations to improve traction:

- When using snow chains.
- In deep snow.
- On sand or gravel.

 Spinning the wheels results in a cutting action, which enhances traction.

If the  ESP® warning lamp lights up continuously, ESP® is not available due to a malfunction.

Observe the following information:

- Warning and indicator lamps (→ page 387)
- Display messages (→ page 340)

ETS/4ETS (Electronic Traction System)

ETS/4ETS traction control is part of ESP® and makes it possible to pull away and accelerate on a slippery road.

ETS/4ETS can improve the vehicle's traction by intervening in the following ways:

- The drive wheels are braked individually if they spin.
- More drive torque is transferred to the wheel or wheels with traction.

Influence of drive programs on ESP®

The drive programs enable ESP® to adapt to different weather and road conditions as well as the driver's preferred driving style. Depending on the selected drive program, the appropriate ESP® mode will be activated. You can select the drive programs using the DYNAMIC SELECT switch (→ page 146).

Function of ESP® Crosswind Assist

ESP® Crosswind Assist detects sudden gusts of side wind and helps the driver to keep the vehicle in the lane:

- ESP® Crosswind Assist is active at vehicle speeds between approx. 47 mph (75 km/h) and 125 mph (200 km/h) when driving straight ahead or cornering slightly.
- The vehicle is stabilized by means of individual brake application on one side.

Activating/deactivating ESP® (Electronic Stability Program)

Multimedia system:

 **Settings** **Quick Access**

- ⓘ ESP® can only be activated/deactivated using quick access when at least one other function is available in quick access. ESP® can otherwise be found in the [Assistance](#) menu.

NOTE Mercedes-AMG vehicles

- ▶ Observe the notes in the Supplement. You could otherwise fail to recognize dangers.

- ▶ Select **ESP**.
- ▶ Select **On** or  **Off**.

ESP® is deactivated if the  ESP® OFF warning lamp lights up continuously in the instrument cluster.

Observe the information on warning lamps and display messages which may be shown in the instrument cluster.

Function of EBD

Electronic Brakeforce Distribution (EBD) is characterized by the following:

- Monitoring and regulating the brake pressure on the rear wheels.
- Improved driving stability when braking, especially on bends.

Function of STEER CONTROL

STEER CONTROL helps you by transmitting a noticeable steering force to the steering wheel in the direction required for vehicle stabilization.

This steering recommendation is given in the following situations:

- Both right wheels or both left wheels are on a wet or slippery road surface when you brake
- The vehicle starts to skid

System limits

STEER CONTROL may be impaired or may not function in the following situations:

- ESP® is deactivated.
- ESP® is malfunctioning.
- The steering is malfunctioning.

If ESP® is malfunctioning, you will be assisted further by the electric power steering.

HOLD function

HOLD function

The HOLD function holds the vehicle at a standstill without requiring you to depress the brake pedal, e.g. while waiting in traffic.

The HOLD function is only an aid. The responsibility for the vehicle safely standing still remains with the driver.

System limits

The HOLD function is only intended to provide assistance when driving and is not a sufficient means of safeguarding the vehicle against rolling away when stationary.

- The incline must not be greater than 30%.

Activating/deactivating the HOLD function

⚠ WARNING Risk of an accident due to the HOLD function being active when you leave the vehicle

If the vehicle is only braked with the HOLD function it could, in the following situations, roll away:

- If there is a malfunction in the system or in the power supply.
 - If the HOLD function is deactivated by depressing the accelerator pedal or brake pedal, e.g. by a vehicle occupant.
- ▶ Always secure the vehicle against rolling away before you leave it.

Requirements:

- The vehicle is stationary.
- The driver's door is closed or the seat belt on the driver's side is fastened.
- The engine is running or has been automatically switched off by the ECO start/stop function.

- The electric parking brake is released.
- Active Distance Assist DISTRONIC is deactivated.
- The transmission is in position **D**, **R** or **N**.

Activating the HOLD function

- ▶ Depress the brake pedal, and after a short time quickly depress further until the **HOLD** display appears in the multifunction display.
- ▶ Release the brake pedal.

Deactivating the HOLD function

- ▶ Depress the accelerator pedal to pull away.
- or
- ▶ Depress the brake pedal until the **HOLD** display disappears from the multifunction display.

The HOLD function is deactivated in the following situations:

- Active Distance Assist DISTRONIC is activated.
- The transmission is shifted to position **P**.

- The vehicle is secured with the electric parking brake.

In the following situations, the vehicle is held by transmission position **P** and/or by the electric parking brake:

- The seat belt is unfastened and the driver's door is opened.
- The vehicle is switched off.
- There is a malfunction in the system or the power supply is insufficient.

Function of Hill Start Assist

Hill Start Assist holds the vehicle for a short time when pulling away on a hill under the following conditions:

- The transmission is in position **D** or **R**.
- The electric parking brake is released.

This gives you enough time to move your foot from the brake pedal to the accelerator pedal and depress it before the vehicle begins to roll away.

⚠ WARNING Risk of accident and injury due to the vehicle rolling away

After a short time, Hill Start Assist no longer holds the vehicle.

- ▶ Swiftly move your foot from the brake pedal to the accelerator pedal. Do not leave the vehicle when it is being held by Hill Start Assist.

ATTENTION ASSIST

Function of ATTENTION ASSIST

ATTENTION ASSIST assists you on long, monotonous journeys, e.g. on highways and trunk roads. If ATTENTION ASSIST detects indicators of fatigue or increasing lapses in concentration on the part of the driver, it suggests taking a break.

ATTENTION ASSIST is only an aid. It cannot always detect fatigue or lapses in concentration in time. The system is not a substitute for a well-rested and attentive driver. On long journeys, take regular breaks in good time that allow for adequate recuperation.

You can choose between two settings:

- **Standard:** normal system sensitivity.
- **Sensitive:** higher system sensitivity. The driver is warned earlier and the attention level detected by ATTENTION ASSIST is adapted accordingly.

If drowsiness or increasing lapses in concentration are detected, the **ATTENTION ASSIST: Take a Break!** warning appears in the Instrument Display. You can acknowledge the message and take a break where necessary. If you do not take a break and ATTENTION ASSIST continues to detect increasing lapses in concentration, you will be warned again after a minimum of 15 minutes.



You can have the following status information for ATTENTION ASSIST displayed in the assistance menu of the on-board computer:

- The length of the journey since the last break.
- The attention level determined by ATTENTION ASSIST:
 - The fuller the circle, the higher the attentional level determined
 - As your attention wanes, the circle in the center of the display becomes smaller

If ATTENTION ASSIST is unable to calculate the attention level and cannot issue a warning, the **System Suspended** message appears.

If a warning is given in the Instrument Display, the multimedia system offers to search for a rest area. You can select a rest area and start navigation to this rest area. This function can be activated and deactivated in the multimedia system.

If ATTENTION ASSIST is deactivated, the  symbol appears in the assistance graphic in the Instrument Display when the engine is running. ATTENTION ASSIST is activated automatically when the engine is re-started. The last selected sensitivity level remains stored.

System limits

ATTENTION ASSIST is active in the 37 mph (60 km/h) to 124 mph (200 km/h) speed range.

Particularly in the following situations, ATTENTION ASSIST only functions in a restricted manner and warnings may be delayed or not occur:

- If you have been driving for less than approximately 30 minutes.

- If the road condition is poor (uneven road surface or potholes).
- If there is a strong side wind.
- If you adopt a sporty driving style (high cornering speeds or high rates of acceleration).
- If the Steering Assist function of Active Distance Assist DISTRONIC is active.
- If the time has been set incorrectly.
- If you change lanes and vary your speed frequently in active driving situations.

The ATTENTION ASSIST drowsiness or alertness assessment is reset and restarted when continuing the journey in the following situations:

- If you switch off the engine.
- If you unfasten your seat belt and open the driver's door (e.g. to change drivers or take a break).

Setting ATTENTION ASSIST

Multimedia system:

→  » Settings » Assistance
» Attention Assist

Setting options

▶ Select **Standard**, **Sensitive** or **Off**.

Suggesting a rest area

- ▶ Select **Suggest Rest Area**.
- ▶ Activate or deactivate the function. If ATTENTION ASSIST detects fatigue or increasing lack of attention, it suggests a rest area in the vicinity.
- ▶ Select the suggested rest area. You are guided to the selected rest area.

Speed control cruise control**Function of cruise control**

Cruise control regulates the speed to the value selected by the driver.

If you accelerate to overtake, for example, the stored speed is not deleted. If you remove your



foot from the accelerator pedal after overtaking, cruise control will resume speed regulation back to the stored speed.

You can store any speed above 15 mph (20 km/h) up to the maximum design speed.

Observe the notes on driving systems and your responsibility; you may otherwise fail to recognize dangers (→ page 161).

Mercedes-AMG vehicles: Cruise control is available up to a maximum speed of 155 mph (250 km/h).

Displays on the multifunction display

-  (gray): cruise control is selected but not yet activated.
-  (green): cruise control is active.

A stored speed appears along with the  display.

i The segments between the stored speed and the end of the segment display light up in the speedometer.

System limits

Cruise control may be unable to maintain the stored speed on uphill gradients. The stored speed is resumed when the gradient evens out.

Change into a lower gear in good time on long and steep downhill gradients. Take particular note of this when driving a laden vehicle. By doing so, you will make use of the engine's braking effect. This relieves the load on the brake system and prevents the brakes from overheating and wearing too quickly.

Do not use cruise control in the following situations:

- In traffic situations which require frequent changes of speed, e.g. in heavy traffic, on winding roads.
- On slippery roads. Accelerating can cause the drive wheels to lose traction and the vehicle could then skid.
- If you are driving when visibility is poor.

Operating cruise control

⚠ WARNING Risk of accident due to stored speed

If you call up the stored speed and this is lower than your current speed, the vehicle decelerates.

- ▶ Take into account the traffic situation before calling up the stored speed.

Requirements:

- ESP® must be activated, but not intervening.
- The vehicle speed is at least 15 mph (20 km/h).
- The transmission is in position **D**.

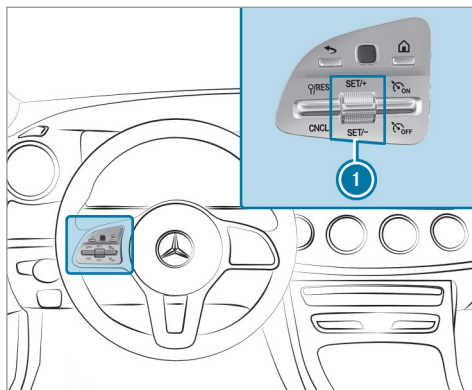

Operating cruise control

- ▶ Press the rocker switches on the steering wheel control panel up or down to the desired position.

Activating cruise control

- ▶ Select **RES/ON** with the right rocker switch.

Activating cruise control

- ▶ Press rocker switch **1** up **SET+** or down **SET-**.
The current speed is stored and maintained by the vehicle.

or

- ▶ Select **RES/ON** with the left rocker switch.
The last stored speed is called up and maintained by the vehicle.

If the last stored speed has previously been deleted, the current vehicle speed is stored.

- i** When you switch off the vehicle, the last speed stored is deleted.

Increasing or decreasing the stored speed

- ▶ 1 mph (1 km/h): press rocker switch **1** up **SET+** or down **SET-** to the pressure point.

or

- ▶ 5 mph (10 km/h): press rocker switch **1** up **SET+** or down **SET-** beyond the pressure point.

or

- ▶ Accelerate the vehicle to the desired speed and press rocker switch **1** up **SET+**.

Adopting a detected speed

- ▶ Activate cruise control.
- ▶ If a traffic sign has been detected and is displayed in the instrument cluster: select  with the left rocker switch. The maximum permissible speed shown by the traffic sign is stored and the vehicle maintains or does not exceed this speed.

Deactivating cruise control

- ▶ Select  with the left rocker switch.

Switching off cruise control

- ▶ Select  with the right rocker switch.
- ⓘ If you brake, deactivate ESP® or if ESP® intervenes, cruise control is deactivated.

Active Distance Assist DISTRONIC

Function of Active Distance Assist DISTRONIC

Active Distance Assist DISTRONIC maintains the set speed on free-flowing roads. If vehicles in front are detected, the set distance is maintained, if necessary, until the vehicle comes to a

halt. The vehicle accelerates or brakes depending on the distance to the vehicle in front and the set speed. The speed and distance to the vehicle in front are set and saved using the steering wheel.

Available speed range:

- **Vehicles without Driving Assistance Package:** 15 mph (20 km/h) - 120 mph (200 km/h)
- **Vehicles with Driving Assistance Package:** 15 mph (20 km/h) - 130 mph (210 km/h)

Other features of Active Distance Assist DISTRONIC:

- Adjusts the driving style depending on the selected drive program (fuel-saving, comfortable or dynamic)
- Initiates acceleration to the stored speed if the turn signal indicator is switched on to change to the overtaking lane
- **Vehicles with Driving Assistance Package:**

- Reacts to stationary vehicles detected in urban speed ranges (except bicycles and motorcycles)
- Takes one-sided overtaking restrictions into account on highways or on multi-lane roads with separate roadways (country-dependent)

Vehicles with Driving Assistance Package and Parking Assist PARKTRONIC:

if the vehicle has been braked to a standstill on multi-lane, separate roadways by Active Distance Assist DISTRONIC, it can automatically follow the vehicle in front when driving off again within 30 seconds. If a critical situation is detected when driving off, a visual and acoustic warning is given indicating that the driver must now take control of the vehicle. The vehicle is not accelerated any further.

Observe the notes on driving systems and your responsibility; you may otherwise fail to recognize dangers (→ page 161).

Active Distance Assist DISTRONIC displays in the instrument cluster

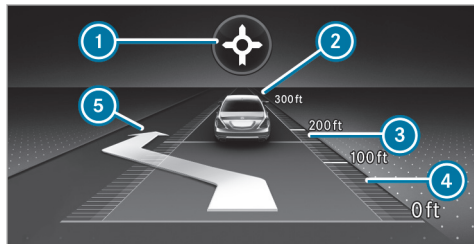

Assistant display

- ① Route-based speed adaptation: type of route event (→ page 176)
- ② Vehicle in front
- ③ Distance indicator
- ④ Set specified distance
- ⑤ Active Lane Change Assist lane change display

Permanent status display of Active Distance Assist DISTRONIC

- (white): Active Distance Assist DISTRONIC selected, specified distance set
- (white vehicle, green speedometer): Active Distance Assist DISTRONIC active, specified distance set and vehicle detected
- (green): Active Distance Assist DISTRONIC active, specified distance set and vehicle detected
- : Route-based speed adaptation active (→ page 176).

The stored speed is shown along with the permanent status display and highlighted on the speedometer. When Active Distance Assist DISTRONIC is passive, the speed is grayed out.

- ① On highways or high-speed major roads, the green vehicle symbol is displayed cyclically when the vehicle is ready to pull away.
- ② If you depress the accelerator pedal beyond the setting of the Active Distance Assist DISTRONIC, the system is switched to pas-

sive mode. The **Suspended** message appears in the multifunction display.

Display on the speedometer

The stored speed is highlighted on the speedometer. If the speed of the vehicle in front or the speed adjustment is less than the stored speed due to the route event ahead, the segments in the speedometer light up. Deactivation of Active Distance Assist DISTRONIC, as well as alterations to the speed due to manual or automatic adoption of the maximum permissible speed, are displayed in the control feedback of the multifunction display on a single line.

System limits

The system may be impaired or may not function in the following situations, for example:

- In snow, rain, fog, heavy spray, if there is glare, in direct sunlight or in greatly varying ambient light.
- The windshield in the area of the camera is dirty, fogged up, damaged or covered.
- If the radar sensors are dirty or covered.

- In parking garages or on roads with steep uphill or downhill gradients.
- If there are narrow vehicles in front, such as bicycles or motorcycles.

In addition, on slippery roads, braking or accelerating can cause one or several wheels to lose traction and the vehicle could then skid.

Do not use Active Distance Assist DISTRONIC in these situations.

⚠ WARNING Risk of accident from acceleration or braking by Active Distance Assist DISTRONIC

Active Distance Assist DISTRONIC may accelerate or brake in the following cases, for example:

- If the vehicle pulls away using Active Distance Assist DISTRONIC.
- If the stored speed is called up and is considerably faster or slower than the currently driven speed.

- If Active Distance Assist DISTRONIC no longer detects a vehicle in front or does not react to relevant objects.

- ▶ Always carefully observe the traffic conditions and be ready to brake at all times.
- ▶ Take into account the traffic situation before calling up the stored speed.

⚠ WARNING Risk of accident due to insufficient deceleration by Active Distance Assist DISTRONIC

Active Distance Assist DISTRONIC brakes your vehicle with up to 50% of the possible deceleration. If this deceleration is not sufficient, Active Distance Assist DISTRONIC alerts you with a visual and acoustic warning.

- ▶ Adjust your speed and maintain a suitable distance from the vehicle in front.
- ▶ Brake the vehicle yourself and/or take evasive action.

⚠ WARNING Risk of accident if detection function of Active Distance Assist DISTRONIC is impaired

Active Distance Assist DISTRONIC does not react or has a limited reaction:

- when driving on a different lane or when changing lanes
- to pedestrians, animals, bicycles or stationary vehicles, or unexpected obstacles
- to complex traffic conditions
- to oncoming vehicles and crossing traffic

As a result, Active Distance Assist DISTRONIC may neither give warnings nor intervene in such situations.

- ▶ Always observe the traffic conditions carefully and react accordingly.

Operating Active Distance Assist DISTRONIC

Requirements:

- The electric parking brake is released.
- ESP® is activated and is not intervening.

- The transmission is in position **D**.
- The driver's door is closed.
- Check of the radar sensor system has been successfully completed.
- Parking Assist PARKTRONIC is not being used to park the vehicle or to exit from a parking space.

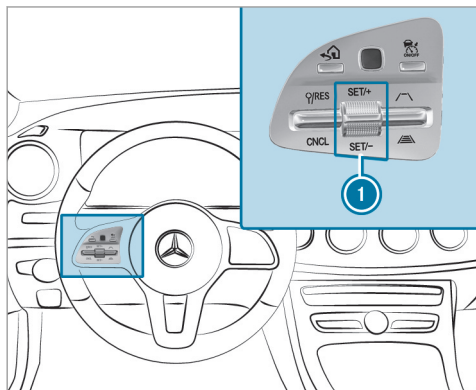

- ▶ **To operate Active Distance Assist DISTRONIC:** press the rocker switches on the steering wheel control unit up or down to the desired position.

Activating/deactivating Active Distance Assist DISTRONIC

- ▶ Press the  button.

Activating Active Distance Assist DISTRONIC

- ▶ **To activate without a stored speed:** press rocker switch  up **SET+** or down **SET-**, or select **RES/Ⓟ** with the left rocker switch.

or

- ▶ **To activate with a stored speed:** select **RES/Ⓟ** with the left rocker switch.
- ▶ Remove your foot from the accelerator pedal. The current speed is stored and maintained by the vehicle.

Adopting a detected speed limit

- ▶ Activate Active Distance Assist DISTRONIC.

- ▶ If a traffic sign has been detected and is displayed in the instrument cluster: select **RES/Ⓟ** with the left rocker switch. The maximum permissible speed on the traffic sign is adopted as the stored speed. The vehicle adapts its speed to that of the vehicle in front, but only up to the stored speed.

Pulling away with Active Distance Assist DISTRONIC

- ▶ Activate Active Distance Assist DISTRONIC and remove your foot from the brake pedal.
- ▶ Select **RES/Ⓟ** with the left rocker switch.

or

- ▶ Depress the accelerator pedal briefly and firmly. The functions of Active Distance Assist DISTRONIC continue to be carried out.

Deactivating Active Distance Assist DISTRONIC

⚠ WARNING Risk of an accident due to Active Distance Assist DISTRONIC being active when you leave the driver's seat

If you leave the driver's seat while the vehicle is being braked by Active Distance Assist DISTRONIC only, the vehicle can roll away.

- ▶ Always deactivate Active Distance Assist DISTRONIC and secure the vehicle to prevent it from rolling away before you leave the driver's seat.

- ▶ Select **[CNCL]** with the left rocker switch.

- ⓘ If you brake, deactivate ESP® or if ESP® intervenes, Active Distance Assist DISTRONIC is deactivated.

Increasing or decreasing the speed

- ▶ 1 mph (1 km/h): press rocker switch **①** up **[SET+]** or down **[SET-]** to the pressure point.



or

- ▶ 5 mph (10 km/h): press rocker switch **①** up **[SET+]** or down **[SET-]** beyond the pressure point.

or

- ▶ Accelerate the vehicle to the desired speed and press rocker switch **①** up **[SET+]**.

Changing the specified distance to the vehicle in front

- ▶ **To reduce the specified distance:** press the right rocker switch up (.
- ▶ **To increase the specified distance:** press the right rocker switch down (.

Function of Active Speed Limit Assist

If speed limit change between 12 mph (20 km/h) and 80 mph (130 km/h) is detected and the automatic adoption of speed limits is active, it will be automatically adopted as the stored speed (→ page 188).

The driven speed is adjusted when the vehicle is level with the traffic sign at the latest. In the case of signs indicating entry into an urban area, the speed is adapted according to the speed permitted within the urban area. The speed limit display in the Instrument Display is always updated when the vehicle is level with the traffic sign.

If there is no speed restriction on an unlimited stretch of road (e.g. on a freeway), the recommended speed is automatically adopted as the stored speed. The system uses the speed stored on an unlimited stretch of road as the recommended speed. If you do not alter the stored speed on an unlimited stretch of road, the recommended speed is 80 mph (130 km/h).

If Active Distance Assist DISTRONIC has been put into passive mode by pressing the accelerator pedal, only speed limits which are higher than the set speed are adopted.

Observe the notes on driving systems and your responsibility; you may otherwise fail to recognize dangers (→ page 161).

System limits

The system limits of Traffic Sign Assist apply to the detection of traffic signs (→ page 187).

Speed limits below 12 mph (20 km/h) are not automatically adopted by the system as the stored speed. Temporary speed restrictions (e.g. for a certain time or due to weather conditions) cannot be properly detected by the system. The

maximum permissible speed applying to a vehicle with a trailer is not detected by the system. Adjust the speed in these situations.

⚠ WARNING Risk of accident due to Active Speed Limit Assist adapting the vehicle's speed

The speed adopted by Active Speed Limit Assist may be too high or incorrect in some individual cases, such as:

- at speed limits below 12 mph (20 km/h)
- in wet conditions or in fog
- when towing a trailer

- ▶ Ensure that the driven speed complies with traffic regulations.
- ▶ Adjust the driving speed to suit current traffic and weather conditions.

Function of route-based speed adaptation

When Active Distance Assist DISTRONIC is activated, the vehicle speed will be adapted accordingly to the route events ahead. Depending on the drive program selected, the vehicle negoti-

ates a route event ahead in an economical, comfortable or dynamic manner. When the route event has been passed, the vehicle accelerates again to the stored speed. The set distance to the vehicle in front, vehicles detected ahead and speed restrictions ahead are taken into account.

You can activate and deactivate route-based speed adaptation in the multimedia system (→ page 177).

The following route events are taken into account:

- Curves
- T-intersections, roundabouts and toll stations
- Turns and exits
- Traffic jams ahead (only with Live Traffic Information)

i When the toll station is reached, Active Distance Assist DISTRONIC adopts the speed as the stored speed.

Also, the speed is reduced if the turn signal indicator to change lanes is switched on and one of the following situations is detected:

- Turning off at intersections

- Driving on slowing-down lanes
- Driving on lanes adjacent to slowing-down lanes

The driver is responsible for choosing the right speed and observing other road users. This applies in particular to intersections, roundabouts and traffic lights, as route-based speed adaptation does not brake the vehicle to a standstill.

When route guidance is active, the first speed adjustment is carried out automatically. If the turn signal indicator is switched on, the selected route is confirmed and further speed adjustment is activated.

Speed adaptation is canceled in the following cases:

- If the turn signal indicator is switched off before the route event.
- If the driver depresses the accelerator or brake pedal during the process.

System limits

Route-based speed adaptation does not take right of way regulations into account. The driver

is responsible for complying with road traffic regulations and driving at a suitable speed.

The speed adaptation made by the system may not always be suitable, particularly in the following situations:

- The road's course not clearly visible
- Road narrowing
- Varying maximum permissible speeds in individual lanes
- Wet road surfaces, snow or ice

In these situations the driver must intervene accordingly.

⚠ WARNING Risk of accident in spite of route-based speed adaptation

Route-based speed adaptation can malfunction or be temporarily unavailable in the following situations:

- If the driver does not follow the calculated route
- If map data is not up-to-date or available

- In the event of roadworks
 - In bad weather or road conditions
 - If the accelerator pedal is depressed
 - In the event of electronically displayed speed limitations
- ▶ Adapt the speed to the traffic situation.

Setting route-based speed adaptation

Requirements:

- Active Distance Assist DISTRONIC is activated.
- ECO Assist is active.

Multimedia system:

→  ▶ Settings ▶ Assistance
▶▶ Route-based Speed

- ▶ Activate or deactivate the function. When the function is active, the vehicle speed is adjusted depending on the route events ahead.
- ① Further information on the route-based speed adaptation (→ page 176).

Function of Active Stop-and-Go Assist

Active Stop-and-Go Assist helps you when in traffic jams on multi-lane roads with separate roadways by automatically pulling away within 60 seconds and with moderate steering maneuvers. It orients itself using the vehicle in front and lane markings. Active Stop-and-Go Assist automatically maintains a safe distance from the vehicle in front and vehicles cutting in.

Active Stop-and-Go Assist requires you, as the driver, to keep your hands on the steering wheel at all times so that you are able to intervene at any time to correct the course of the vehicle and keep it in lane. Observe the notes on driving systems and your responsibility; you may otherwise fail to recognize dangers (→ page 161).

Active Stop-and-Go Assist activates automatically as soon as all of the requirements are met: The  status display appears in the instrument cluster when the function is active.

Requirements:

- You are in a traffic jam on a freeway or high-speed major road.

- Active Distance Assist DISTRONIC is activated and active (→ page 173).
- Active Brake Assist is available (→ page 182).
- Active Steering Assist is activated and active (→ page 180).
- Active Stop-and-Go Assist is activated (→ page 178).
- You are traveling no faster than 35 mph (60 km/h).

System limits

The system limitations of Active Distance Assist DISTRONIC and Active Steering Assist apply to Active Stop-and-Go Assist (→ page 178).

Activating/deactivating Active Traffic Jam Assist

Multimedia system:

→  ▶ Settings ▶ Quick Access

▶ Select .

Active Steering Assist



Function of Active Steering Assist





Active Steering Assist is only available up to a speed of 130 mph (210 km/h). The system helps you to stay in the center of the lane by means of moderate steering interventions. Depending on the speed driven, Active Steering Assist uses the vehicles ahead and lane markings as a reference.

- ⓘ Depending on the country, in the lower speed range Active Steering Assist can use the surrounding traffic as a reference. If necessary, Active Steering Assist can then also provide assistance when driving outside the center of the lane, for example, to form a rescue lane.

If the detection of lane markings and vehicles ahead is impaired, Active Steering Assist switches to passive mode. The system provides no support in this case.

Status display of Active Steering Assist in the multifunction display

-  (gray): activated and passive
-  (green): activated and active

-  (red): system limits detected
-  (white, red hands): "hands on the steering wheel" prompt
- ⓘ During the transition from active to passive status, the  symbol is shown as enlarged and flashing. Once the system is passive, the  symbol is shown as gray in the multifunction display.
- ⓘ Depending on the selected vehicle settings, Active Steering Assist may be unavailable.

Steering and touch detection

The driver is required to keep their hands on the steering wheel at all times and be able to intervene at any time to correct the course of the vehicle and keep it in lane. The driver must expect a change from active to passive mode or vice versa at any time.



If the system detects that the driver has not steered the vehicle for a considerable period of time or has removed their hands from the steering wheel, display ❶ appears. If the driver still does not steer the vehicle, a warning tone sounds in addition to the visual warning message.

If the driver does not react to this warning for a considerable period, an emergency stop is initiated (→ page 180).

The warning is not issued or is stopped when the driver gives confirmation to the system:

- The driver steers the vehicle.

- **Depending on the country:** the driver presses a steering wheel button or operates Touch Control

If Active Steering Assist detects that a system limit has been reached, a visual warning is issued and a warning tone sounds.

Observe the notes on driving systems and your responsibility; you may otherwise fail to recognize dangers (→ page 161).

System limits

Active Steering Assist has a limited steering torque for lateral guidance. In some cases, the steering intervention is not sufficient to keep the vehicle in the lane or to drive through exits.

The system may be impaired or may not function in the following instances:

- There is poor visibility, e.g. due to snow, rain, fog, heavy spray, greatly varying ambient light or strong shadows on the road.
- There is glare, e.g. from oncoming traffic, direct sunlight or reflections.
- Insufficient road illumination.

- The windshield is dirty, fogged up, damaged or covered in the vicinity of the camera, e.g. by a sticker.
- No, or several, unclear lane markings are present for one lane, or the markings change quickly, for example, in a construction area or at intersections.
- The lane markings are worn away, dark or covered up, e.g. by dirt or snow.
- If the distance to the vehicle in front is too short and thus the lane markings cannot be detected.
- The road is narrow and winding.
- There are obstacles on the lane or projecting out into the lane, such as object markers.

The system does not provide assistance in the following conditions:

- On tight curves and when turning.
- When crossing intersections.
- At roundabouts or toll plazas.
- When the tire pressure is too low.

⚠ WARNING Risk of accident if Active Steering Assist unexpectedly stops functioning

If the system limits of Active Steering Assist are reached there is no guarantee that the system will remain active or will keep the vehicle in lane.

- ▶ Always keep your hands on the steering wheel and observe the traffic carefully.
- ▶ Always steer the vehicle paying attention to traffic conditions.

⚠ WARNING Risk of accident if Active Steering Assist unexpectedly intervenes

The detection of lane markings and objects may malfunction and cause unexpected steering interventions.

- ▶ Steer according to traffic conditions.

Activating/deactivating Active Steering Assist

Requirements:

- ESP® is activated, but is not intervening.
- Active Distance Assist DISTRONIC is activated.

Multimedia system:

➔  ➔ Settings ➔ Quick Access

▶ Select  Steering Assist.

Function of Active Emergency Stop Assist



If the system detects that the driver has not steered the vehicle for a considerable period of time or has removed their hands from the steering wheel, display  appears in the multifunction display. If the driver still does not steer the vehicle, or gives no confirmation to the system, a warning tone sounds in addition to the visual warning message.

If the driver still does not respond to the warning, the **Beginning Emergency Stop** message appears in the multifunction display. If the driver still does not respond, Active Distance Assist DISTRONIC reduces the speed. The vehicle is decelerated in stages to a standstill.

Depending on the country, at speeds below 40 mph (60 km/h) the hazard warning lights switch on automatically.

When the vehicle is stationary, the following actions are carried out:

- The vehicle is secured with the electric parking brake.
- Active Distance Assist DISTRONIC is ended
- The vehicle is unlocked.

- If possible, an emergency call is placed to the Mercedes-Benz emergency call center

The driver can cancel the deceleration at any time by performing one of the following actions:

- Steering
- Braking or accelerating
- Deactivating Active Distance Assist DISTRONIC

Active Lane Change Assist



Function of Active Lane Change Assist

Active Lane Change Assist supports the driver when changing lanes by applying steering torque if the driver operates a turn signal indicator.

Observe the notes on driving systems and your responsibility; you may otherwise fail to recognize dangers (→ page 161).

Assistance when changing lanes is provided if all the following conditions are met:

- You are driving on a freeway or road with multiple lanes in the direction of travel.
- The neighboring lane is separated by a broken lane marking.
- No vehicle is detected in the adjacent lane.
- The vehicle speed is between 50 mph (80 km/h) and 110 mph (180 km/h).
- Active Lane Change Assist is switched on in the multimedia system.
- Active Steering Assist is activated and active.

If no vehicle is detected in the adjacent lane and a lane change is permitted, the lane change begins after the driver has activated the turn signal indicator. This is shown to the driver with a green arrow next to the  steering wheel symbol. The **Lane Change to the Left** message, for example, also appears. If Active Lane Change Assist has been activated with the turn signal indicator but a lane change is not immediately possible, a gray arrow appears next to the  steering wheel symbol, which remains green.

When the lane change assistance starts, the turn signal indicator is automatically activated along with the display in the multifunction display.

If a lane change is not possible, the arrow is faded out after a few seconds and a new lane change must be initiated. An immediate lane change is only possible on freeway sections without speed limits.

If the system is impaired, Active Lane Change Assist may be canceled. The **Lane Change Canceled** message appears in the multifunction display.

In addition, a warning tone may sound, depending on the situation.

⚠ WARNING Risk of accident when changing lane to an occupied adjacent lane

Lane Change Assist cannot always clearly detect if the adjacent lane is free.

The lane change might be initiated although the adjacent lane is not free.

- ▶ Before changing lanes, make sure that the neighboring lane is free and there is no danger to other road users.
- ▶ Monitor the lane change.

⚠ WARNING Risk of accident if Lane Change Assist unexpectedly stops functioning

If the system limitations for Lane Change Assist have been reached, there is no guarantee that the system will remain active.

Lane Change Assist cannot then assist you by applying steering torque.

- ▶ Always monitor the lane change and keep your hands on the steering wheel. Observe the traffic conditions and steer and/or brake if necessary.

System limits

The system limitations of Active Steering Assist apply to Active Lane Change Assist (→ page 178).

The system may also be impaired or may not function in the following situations:

- The sensors in the rear bumper are dirty, damaged or covered by a sticker or ice and snow, for example.
- The exterior lighting shows a defect.

- ⓘ The Active Lane Change Assist sensors adjust automatically while a certain distance is being driven after the vehicle has been delivered. Active Lane Change Assist is unavailable or only partially available during this teach-in process; no arrow appears next to the  Active Steering Assist symbol when the turn signal indicator is activated.

Activating/deactivating Active Lane Change Assist

Multimedia system:

- ➔  ➔ [Settings](#) ➔ [Assistance](#)
- ➔ [Active Lane Change Assist](#)
- ▶ Activate or deactivate the function.

Active Brake Assist

Function of Active Brake Assist

Active Brake Assist consists of the following functions:

- Distance warning function
- Autonomous braking function
- Situation-dependent braking assistance

- **Vehicles with Driving Assistance Package:** Evasive Steering Assist and cornering function

Active Brake Assist can help you to minimize the risk of a collision with vehicles, cyclists or pedestrians or to reduce the effects of such a collision.

If Active Brake Assist has detected a risk of collision, a warning tone sounds and the  distance warning lamp lights up in the instrument cluster.

Vehicles with PRE-SAFE®: depending on the country, an additional haptic warning occurs in the form of slight, repeated tensioning of the seat belt.

If you do not react to the warning, autonomous braking can be initiated in critical situations.

In especially critical situations, Active Brake Assist can initiate autonomous braking directly. In this case, the warning lamp and warning tone occur simultaneously with the braking application.

If you apply the brake yourself in a critical situation or apply the brake during autonomous braking, situation-dependent braking assistance occurs. The brake pressure increases up to maximum full-stop braking if necessary.

Observe the notes on driving systems and your responsibility; you may otherwise fail to recognize dangers (→ page 161).



If autonomous braking or situation-dependent braking assistance has occurred, display ① appears in the multifunction display and then automatically goes out after a short time.

If the autonomous braking function or the situation-dependent braking assistance is triggered,

additional preventive measures for occupant protection (PRE-SAFE®) may also be initiated.

⚠ WARNING Risk of an accident caused by limited detection performance of Active Brake Assist

Active Brake Assist cannot always clearly identify objects and complex traffic situations.

- ▶ Always pay careful attention to the traffic situation; do not rely on Active Brake Assist alone. Active Brake Assist is only an aid. The driver is responsible for maintaining a sufficiently safe distance to the vehicle in front, vehicle speed and for braking in good time.
- ▶ Be prepared to brake or swerve if necessary.

Also observe the system limits of Active Brake Assist.

The individual subfunctions are available in various speed ranges:

The distance warning function can issue a warning in the following situations:

- From approximately 4 mph (7 km/h), if your vehicle is critically close to a vehicle, cyclist or pedestrian, you will hear an intermittent warning tone and the  distance warning lamp lights up in the instrument cluster.

Vehicles with PRE-SAFE®: depending on the country, an additional haptic warning occurs in the form of slight, repeated tensioning of the seat belt.

Brake immediately or take evasive action, provided it is safe to do so and the traffic situation allows this.

Distance warning function (vehicles without Driving Assistance Package)

The distance warning function can aid you in the following situations with an intermittent warning tone and a warning lamp:

- At speeds up to approximately 155 mph (250 km/h) when approaching vehicles ahead
- At speeds up to approximately 50 mph (80 km/h) when approaching stationary vehicles, pedestrians walking in the direction of travel and cyclists ahead
- At speeds up to approximately 37 mph (60 km/h) when approaching crossing pedestrians

Distance warning function (vehicles with Driving Assistance Package)

The distance warning function can aid you in the following situations with an intermittent warning tone and a warning lamp:

- At speeds up to approximately 155 mph (250 km/h) when approaching vehicles ahead

- At speeds up to approximately 62 mph (100 km/h) when approaching stationary vehicles
- At speeds up to approximately 50 mph (80 km/h) when approaching moving pedestrians and cyclists ahead
- At speeds up to approximately 43 mph (70 km/h) when approaching stationary pedestrians, crossing vehicles and stationary and crossing cyclists

Autonomous braking function (vehicles without Driving Assistance Package)

If the vehicle is traveling at speeds above approximately 4 mph (7 km/h), the autonomous braking function may intervene in the following situations:

- At speeds up to approximately 124 mph (200 km/h) when approaching vehicles ahead
- At speeds up to approximately 50 mph (80 km/h) when approaching cyclists ahead

- At speeds up to approximately 37 mph (60 km/h) when approaching stationary vehicles or moving pedestrians

Autonomous braking function (vehicles with Driving Assistance Package)

If the vehicle is traveling at speeds above approximately 4 mph (7 km/h), the autonomous braking function may intervene in the following situations:

- At speeds up to approximately 155 mph (250 km/h) when approaching vehicles ahead
- At speeds up to approximately 62 mph (100 km/h) when approaching stationary vehicles
- At speeds up to approximately 50 mph (80 km/h) when approaching cyclists ahead
- At speeds up to approximately 43 mph (70 km/h) when approaching stationary and moving pedestrians, crossing vehicles and stationary and crossing cyclists

Situation-dependent braking assistance (vehicles without Driving Assistance Package)

The situation-dependent braking assistance can intervene from a speed of approximately 4 mph (7 km/h) in the following situations:

- At speeds up to approximately 155 mph (250 km/h) when approaching vehicles ahead
- At speeds up to approximately 50 mph (80 km/h) when approaching stationary vehicles and vehicles ahead
- At speeds up to approximately 37 mph (60 km/h) when approaching moving pedestrians

Situation-dependent braking assistance (vehicles with Driving Assistance Package)

The situation-dependent braking assistance can intervene from a speed of approximately 4 mph (7 km/h) in the following situations:

- At speeds up to approximately 155 mph (250 km/h) when approaching vehicles ahead

- At speeds up to approximately 62 mph (100 km/h) when approaching stationary vehicles
- At speeds up to approximately 50 mph (80 km/h) when approaching cyclists ahead
- At speeds up to approximately 37 mph (60 km/h) when approaching stationary and moving pedestrians, crossing vehicles and stationary and crossing cyclists

Canceling a brake application of Active Brake Assist

You can cancel a brake application of Active Brake Assist at any time by:

- Sharply depressing the accelerator pedal or with kickdown
- Releasing the brake pedal

Active Brake Assist may cancel the brake application when one of the following conditions is fulfilled:

- You maneuver to avoid the obstacle.
- There is no longer a risk of collision.

- An obstacle is no longer detected in front of your vehicle.

Evasive Steering Assist (only vehicles with Driving Assistance Package)

Evasive Steering Assist has the following characteristics:

- The ability to detect stationary or moving pedestrians.
- Assistance through power-assisted steering if it detects a swerving maneuver.
- Activation by an abrupt steering movement during a swerving maneuver.
- Assistance during swerving and straightening of the vehicle.
- Reaction from a speed of approximately 12 mph (20 km/h) up to a speed of approximately 43 mph (70 km/h).

You can prevent the assistance at any time by actively steering.

Cornering function (only vehicles with Driving Assistance Package)

If a danger of collision from an oncoming vehicle is detected when turning across an oncoming lane, autonomous braking can be initiated at speeds below 9 mph (15 km/h) before you have left the lane in which you are driving.

⚠ WARNING Risk of accident despite Evasive Steering Assist

Evasive Steering Assist cannot always recognize objects or complex traffic situations clearly.

Moreover, the steering support provided by Evasive Steering Assist is not sufficient to avoid a collision.

- ▶ Always pay careful attention to the traffic situation; do not rely on Evasive Steering Assist alone.
- ▶ Be prepared to brake or swerve if necessary.
- ▶ End the support by actively steering in non-critical situations.

- ▶ Drive at an appropriate speed if there are pedestrians close to the path of your vehicle.

System limits

Full system performance is not available for a few seconds after switching on the ignition or after driving off.

If Active Brake Assist is impaired or inoperative due to a malfunction, the  warning lamp appears in the multifunction display.

The system may be impaired or may not function, particularly in the following situations:

- In snow, rain, fog, heavy spray, if there is glare, in direct sunlight or in greatly varying ambient light.
- If the sensors are dirty, fogged up, damaged or covered.
- If the sensors are impaired due to interference from other radar sources, e.g. strong radar reflections in parking garages.
- If a loss of tire pressure or a faulty tire has been detected and displayed.

- In complex traffic situations where objects cannot always be clearly identified.
- If pedestrians or vehicles move quickly into the sensor detection range.
- If pedestrians are hidden by other objects.
- If the typical outline of a pedestrian cannot be distinguished from the background.
- If a pedestrian is not detected as such, e.g. due to special clothing or other objects.
- If the driver's seat belt is not fastened.
- On bends with a tight radius.

- ⓘ The Active Brake Assist sensors adjust automatically while a certain distance is being driven after the vehicle has been delivered. Active Brake Assist is unavailable or only partially available during the teach-in process.

Setting Active Brake Assist

Requirements:

- The ignition is switched on.

Multimedia system:

→ [Home] ▶ Settings ▶ Assistance
▶ Active Brake Assist

- ▶ Select the desired setting.
The setting is retained when the drive system is next started.

Deactivating Active Brake Assist

- ❶ It is recommended that you always leave Active Brake Assist activated.
- ▶ Select **Off**.
The distance warning function, the autonomous braking function and the Evasive Steering Assist are deactivated.
When the vehicle is next started, the middle setting is automatically selected.
- ❷ If Active Brake Assist is deactivated, the  symbol appears in the status bar of the multifunction display.

Traffic Sign Assist

Function of Traffic Sign Assist

Traffic Sign Assist detects traffic signs with the multifunction camera (→ page 161). It assists you by displaying detected speed limits and overtaking restrictions in the instrument cluster.

Observe the notes on driving systems and your responsibility; you may otherwise fail to recognize dangers (→ page 161).

Since Traffic Sign Assist also uses the data stored in the navigation system, it can update the display in the following situations without detecting traffic signs.

The camera also detects traffic signs with a restriction indicated by an additional sign (e.g. when wet). These are only displayed if a restriction applies or if the system cannot clearly determine whether the restriction applies.

Warning when the maximum permissible speed is exceeded

The system can warn you if you unintentionally exceed the maximum permissible speed. To do this, you can specify in the multimedia system by how much the maximum permissible speed

can be exceeded before a warning is issued. You can specify whether the warning is to be just a visual warning or an acoustic one as well.

Display in the Instrument Display

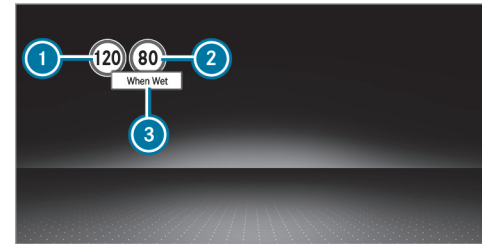

Instrument Display in the Widescreen Cockpit

- ❶ Maximum permissible speed
- ❷ Maximum permissible speed when there is a restriction
- ❸ Additional sign with restriction

i Vehicles with a standard Instrument Display: a + symbol next to a traffic sign in the Instrument Display indicates that additional traffic signs have been detected. These can also be displayed in the media display and optionally in the Head-up Display.

If Traffic Sign Assist cannot determine the maximum permissible speed (e.g. due to missing signs), the following display appears in the Instrument Display:



This is displayed continuously if the vehicle is in a country where Traffic Sign Assist is not supported. Traffic Sign Assist is not available in all countries.

i Also observe the information on display messages in Traffic Sign Assist (→ page 340).

System limits

The system may be impaired or may not function particularly in the following situations:

- If there is poor visibility, e.g. due to insufficient illumination of the road, if there are highly variable shade conditions or in rain, snow, fog or heavy spray.
- If there is glare, e.g. from oncoming traffic, direct sunlight or reflections.
- If the windshield in the area of the multifunction camera is dirty, or if the camera is fogged up, damaged or covered.
- If the traffic signs are hard to detect, e.g. due to dirt or snow, because they are covered, or due to insufficient lighting.
- If the information in the navigation system's digital map is incorrect or out-of-date.
- If the signs are ambiguous, e.g. traffic signs on construction sites or in adjacent lanes.
- If you turn sharply when passing traffic signs outside the camera's field of vision.

Setting Traffic Sign Assist

Requirements:

- **Only vehicles with Driving Assistance Package:**

Active Distance Assist DISTRONIC and ECO Assist must be activated for the automatic adoption of speed limits.

Multimedia system:

→ » Settings » Assistance
» Traffic Sign Assist

Activating or deactivating automatic adoption of speed limits (only vehicles with Driving Assistance Package)

- ▶ Select **Limit Adoption**.
- ▶ Activate or deactivate the function.
The speed limits detected by Traffic Sign Assist are automatically adopted by Active Distance Assist DISTRONIC.

- i** If one of the following systems is activated, the detected speed can be manually adopted as the speed limit:
- Active Distance Assist DISTRONIC

- Cruise control
- Variable limiter

Further information (→ page 173).

Displaying detected traffic signs in the media display

- ▶ Select [Display in Central Display](#).
- ▶ Activate or deactivate the function.

Setting the type of warning

- ▶ Select [Visual & Audible](#), [Visual](#) or [Off](#).

Setting the warning threshold

This value determines the speed at which a warning is issued when exceeded.

- ▶ Select [Warning Threshold](#).
- ▶ Set the desired speed.

Overview of the traffic light data service

⚠ WARNING Risk of an accident or injury due to distraction, incorrect or missing data

The traffic light information display is an aid and cannot replace the observation of the actual driving situation.

- ▶ Keep the actual traffic situation constantly in view when approaching a traffic light and when changing lanes.
- ▶ Avoid prolonged viewing of the Instrument Display and Head-up Display.

The Instrument Display and Head-up Display (if available) show the traffic light and remaining time **1** until the next green phase as a countdown.



Example representation in the Instrument Display

The display is hidden about five seconds before the traffic lights change to green.

- i** The display also goes out in the following cases:
 - When turning off before the intersection into a cross or side street
 - When turning before the intersection
- i** The direction arrows are displayed depending on the following functions:
 - A turn signal is set
 - A lane is recommended during active route guidance

If neither function is active, the remaining time until the next green phase for the lane straight ahead is displayed.

- ① Use of the traffic light information service requires the regular transmission of vehicle positions and driving directions to Mercedes-Benz. The data is immediately anonymized by Mercedes-Benz and forwarded to the provider of the traffic light information service. The vehicle positions and driving directions are deleted after a very short time (a few seconds) and are not permanently saved.

If you do not want to transmit the vehicle positions and driving directions, you have the following options:

- You deactivate the service in the Mercedes me Portal.
- You have the service deactivated at an authorized Mercedes-Benz Center.
- You deactivate the service in the **Assistance** menu in the multimedia system (→ page 191).

- ① This traffic light data service is only available in cities and regions countries.

The function is supported under the following conditions:

- The vehicle is equipped with a multimedia system featuring navigation and a communication module with an activated, integrated SIM card.
- You have a user account for the Mercedes me Portal.
- The vehicle has been connected with the user account.
- The navigation services option is available, subscribed to and activated in the Mercedes me Portal.
- The traffic light data service is within the scope of the navigation service.

The current vehicle position and the direction of travel are transmitted via the communication module and aligned with the data from the traffic light data service provider. The provider gathers data from traffic lights which transmit their changing phases. When the vehicle approaches

an intersection with networked traffic lights, data is transmitted to the vehicle.

A set turn signal left or right and lane recommendations during active route guidance are taken into account for the display.

The service is for information purposes only and is not linked to any other vehicle functions, systems or components. Please note that the displayed data is not available in all traffic areas and may be incorrect.

Certain light signal systems automatically adapt their switching times to the current traffic situation. This can lead to a sudden change in the countdown display.

The information in the Instrument Display is shown after selecting the display contents in the **Assistance** menu. If another menu is selected, the traffic light countdown is not displayed.

In addition, observe the following information:

- Select a speed adapted to the traffic, surroundings and weather conditions
- Observe actual traffic signs

- Observe applicable traffic rules and regulations

Observe the notes on driving systems and your responsibility; you may otherwise fail to recognize dangers.

System limits

The display does not appear in the following situations, for example:

- There is no traffic light data available.
- The time remaining until the next green phase is less than ten seconds.
- Emergency vehicles or local public transport are located in the vicinity of the intersection.
- The data transmission from the vehicle has been interrupted.
- Light signal systems are located in a construction site area or are being maintained.
- The light signal system is malfunctioning.
- The subscription to the service has expired.

Switching the traffic light information display on or off

Multimedia system:

 **▶▶ Settings ▶▶ Assistance**

 Switch **Traffic Light Information** on  or off .



Blind Spot Assist and Active Blind Spot Assist with exit warning

Function of Blind Spot Assist and Active Blind Spot Assist with exit warning

Blind Spot Assist and Active Blind Spot Assist use two lateral, rear-facing radar sensors to monitor the area up to 130 ft (40 m) behind and 10 ft (3 m) next to your vehicle.

If a vehicle is detected at speeds above approximately 8 mph (12 km/h) and this vehicle subsequently enters the monitoring range directly next to your vehicle, the warning lamp in the outside mirror lights up red.

Permanent status display in the instrument cluster:

-  (gray): system is activated but inoperative
-  (green): system is activated and operational

If a vehicle is detected close to your vehicle and you switch on the turn signal indicator in the corresponding direction, a double warning tone sounds and the red warning lamp in the outside mirror flashes. If the turn signal indicator remains switched on, all other detected vehicles are indicated only by the flashing of the red warning lamp.

If you overtake a vehicle quickly, no warning is given.

WARNING Risk of accident despite Blind Spot Assist

Blind Spot Assist does not react to vehicles approaching and overtaking you at a greatly different speed.

Blind Spot Assist cannot warn drivers in this situation.

- ▶ Always pay careful attention to the traffic situation and maintain a safe distance at the side of the vehicle.

Observe the notes on driving systems and your responsibility; you may otherwise fail to recognize dangers (→ page 161).

Exit warning

The exit warning is an additional function of Blind Spot Assist and can warn vehicle occupants about approaching vehicles when leaving the vehicle when stationary.

▲ WARNING Risk of accident despite exit warning

The exit warning neither reacts to stationary objects nor to vehicles approaching you at a greatly differing speed.

The exit warning cannot warn drivers in these situations.

- ▶ Always pay particular attention to the traffic situation when opening the doors and make sure there is sufficient clearance.

If there is a vehicle in the monitoring range, this is indicated in the outside mirror. If a vehicle occupant opens the door on the side with the warning, a warning tone sounds and the warning lamp in the outside mirror starts to flash.

This additional function is only available when Blind Spot Assist is active. When the exit warning is activated, it can warn vehicle occupants for up to three minutes after switching the ignition off. The exit warning is no longer available once the warning lamp in the outside mirror flashes three times.

The exit warning is only an aid and not a substitute for the attention of vehicle occupants. The responsibility for opening and closing the doors and for leaving the vehicle remains with the vehicle occupants.

System limits

Blind Spot Assist and Active Blind Spot Assist may be limited in the following situations, in particular:

- If there is dirt on the sensors or the sensors are obscured
- In poor visibility, e.g. due to fog, heavy rain or snow
- If there are narrow vehicles, e.g. bicycles or motorbikes
- If the road has very wide or narrow lanes
- If vehicles are not driving in the middle of their lane

Warnings may be issued in error when driving close to crash barriers or similar continuous lane borders. Always make sure that there is sufficient distance to the side for other traffic or obstacles.

Warnings may be interrupted when driving alongside long vehicles, for example trucks, for a prolonged time.

Blind Spot Assist is not operational when reverse gear is engaged.

The exit warning may be limited in the following situations:

- When the sensors are covered by adjacent vehicles in narrow parking spaces
- When people approach the vehicle
- In the event of stationary or slowly moving objects

Function of brake application (Active Blind Spot Assist)

If Active Blind Spot Assist detects a risk of a side impact in the monitoring range, a course-correcting brake application is carried out. This is designed to help you avoid a collision.

The course-correcting brake application is available in the speed range between approximately 20 mph (30 km/h) and 125 mph (200 km/h).

⚠ WARNING Risk of accident despite brake application of Active Blind Spot Assist

A course-correcting brake application cannot always prevent a collision.

- ▶ Always steer, brake or accelerate yourself, especially if Active Blind Spot Assist warns you or makes a course-correcting brake application.
- ▶ Always maintain a safe distance at the sides.

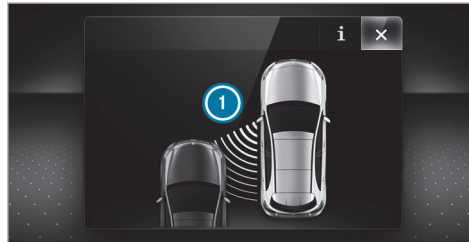

If a course-correcting brake application occurs, the red warning lamp flashes in the outside mirror and a warning tone sounds. In addition, display ① indicating the danger of a side collision appears in the multifunction display.

In rare cases, the system may make an inappropriate brake application. This brake application

may be interrupted at any time if you steer slightly in the opposite direction or accelerate.

System limits

Note the system limitations of Active Blind Spot Assist; you may otherwise not recognize the dangers (→ page 191).

Either a course-correcting brake application appropriate to the driving situation, or none at all, may occur in the following situations:

- Vehicles or obstacles, e.g. crash barriers, are located on both sides of your vehicle.
- A vehicle approaches too closely on the side.
- You have adopted a sporty driving style with high cornering speeds.
- You brake or accelerate significantly.
- A driving safety system intervenes, e.g. ESP® or Active Brake Assist.
- ESP® is deactivated.
- A loss of tire pressure or a faulty tire is detected.

Activating/deactivating Blind Spot Assist or Active Blind Spot Assist

Multimedia system:

→  ► Settings ► Assistance

▶ Activate or deactivate [Blind Spot Assist](#).

or

▶ Activate or deactivate [Act. Blind Spot Assist](#).

Active Lane Keeping Assist

Function of Active Lane Keeping Assist



Active Lane Keeping Assist monitors the area in front of your vehicle by means of the multifunction camera (→ page 161). It serves to protect you against unintentionally leaving your lane. You will be warned by vibration pulses in the steering wheel and guided by a course-correcting brake application back into your lane.

Active Lane Keeping Assist is available in the speed range between 37 mph (60 km/h) and 124 mph (200 km/h).

Active Lane Keeping Assist can neither reduce the risk of an accident if you fail to adapt your driving style nor override the laws of physics. It

cannot take into account road, weather or traffic conditions. Active Lane Keeping Assist is only an aid. You are responsible for maintaining a safe distance to the vehicle in front, for vehicle speed, for braking in good time and for staying in lane.

The status of Active Lane Keeping Assist is displayed in the on-board computer:

-  (green): Active Lane Keeping Assist is active and operating.
-  (gray): Active Lane Keeping Assist is active but not operating.
-  (OFF): Active Lane Keeping Assist is deactivated or there is a malfunction.

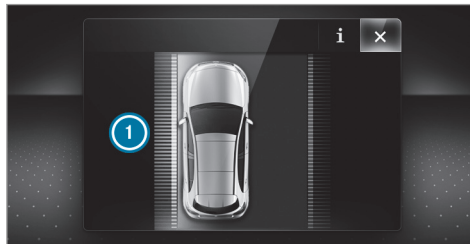

If a lane-correcting brake application occurs, display  appears in the multifunction display.

The system does not apply the brake if you activate the turn signal indicator.

Vehicles with Driving Assistance Package: if the system detects an obstacle, such as another vehicle in the adjacent lane, it will apply the brake regardless of the turn signal indicator.

You are warned by vibrations in the steering wheel in the following circumstances:

- Active Lane Keeping Assist detects a lane marking.
- A front wheel drives over this lane marking.

Conditions for a course-correcting brake application (vehicles without Driving Assistance Package)

Lane markings were detected on both sides of the lane. The front wheel drives over a continuous lane marking.

-  A brake application may be interrupted at any time if you steer slightly in the opposite direction.

Conditions for a course-correcting brake application (vehicles with Driving Assistance Package)

- A continuous lane marking was detected and driven over with the front wheel.
- A lane marking and an approaching vehicle, an overtaking vehicle or vehicles driving parallel to your vehicle were detected in the adjacent lane. The front wheel drives over the lane marking.

 A brake application may be interrupted at any time if you steer slightly in the opposite direction.

System limits

No lane-correcting brake application occurs in the following situations:

- You clearly and actively steer, brake or accelerate.
- If a driving safety system intervenes, such as ESP®, Active Brake Assist or Active Blind Spot Assist.
- You have adopted a sporty driving style with high cornering speeds or high rates of acceleration.
- When ESP® is deactivated.
- If a loss of tire pressure or a faulty tire has been detected and displayed.

If you deactivate the Active Lane Keeping Assist warning and the lane markings cannot be clearly detected, it is possible that no lane correcting brake application takes place (→ page 196).



The system may be impaired or may not function particularly in the following situations:

- If there is poor visibility, e.g. due to insufficient illumination of the road, if there are highly variable shade conditions or in rain, snow, fog or heavy spray.
- If there is glare, e.g. from oncoming traffic, the sun or reflections.
- If the windshield in the area of the multifunction camera is dirty, or if the camera is fogged up, damaged or covered.

- If there are no lane markings, or several unclear lane markings are present for one lane, e.g. around roadworks.
- If the lane markings are worn, dark or covered.
- If the distance from the vehicle in front is too short and thus the lane markings cannot be detected.
- If the lane markings change quickly, e.g. lanes branch off, cross one another or merge.
- If the road is very narrow and winding.
- **Vehicles with Driving Assistance Package:** if the radar sensors in the rear bumper are dirty or covered in snow and an obstacle is detected in your lane, no lane-correcting brake application takes place.

Activating/deactivating Active Lane Keeping Assist

Multimedia system:

-   [» Settings](#) [» Quick Access](#)
[» Active Lane Keeping Assist](#)
 Activate or deactivate the function.

Setting Active Lane Keeping Assist

Multimedia system:

-  » Settings » Assistance
- » Active Lane Keeping Assist

Activating or deactivating the haptic warning

- ▶ Select **Warning**.
Activate or deactivate the function.

DYNAMIC BODY CONTROL function

DYNAMIC BODY CONTROL continuously adjusts the characteristics of the suspension dampers to the current operating and driving conditions.

The damping is tuned individually for each wheel and is affected by the following factors:

- The road surface conditions
- Vehicle load
- The drive program selected
- The driving style

The drive program can be adjusted using the DYNAMIC SELECT switch.

AIR BODY CONTROL

AIR BODY CONTROL function

! NOTE Mercedes-AMG vehicles

- ▶ Observe the notes in the Supplement. You could otherwise fail to recognize dangers.

AIR BODY CONTROL is an air suspension system with variable damping for improved driving comfort. The all-round level control system ensures the best possible suspension and constant ground clearance, even with a laden vehicle. When driving at speed, the vehicle is lowered automatically to improve driving safety and to reduce fuel consumption. You also have the option of manually adjusting the vehicle level.

AIR BODY CONTROL includes the following components and functions:

- Air suspension with variable spring rate
- Automatic level control system
- Speed-dependent lowering to reduce fuel consumption

- Manually selectable high-level setting for greater ground clearance
- ADS PLUS (Adaptive Damping System with constant damping force adjustment)
- DYNAMIC SELECT switch and level button

Suspension setting and vehicle level per drive program

Drive program **C**:

- The suspension setting is comfortable.
- The vehicle is set to the normal level.
- When driving at speeds of approximately 78 mph (125 km/h) or above, the vehicle is lowered.
- When driving at speeds below approximately 50 mph (80 km/h), the vehicle is raised again.

Drive program **E**:

- The suspension setting is comfortable.
- The vehicle is set to low level -1.
- The vehicle is not lowered any further if you are traveling at higher speeds.

Drive program **[S]**:

- The suspension setting is firmer.
- The vehicle is set to low level -1.
- The vehicle is not lowered any further if you are traveling at higher speeds.

Drive program **[S]**:

- The suspension setting is even firmer.
- The vehicle is set to low level -1.
- The vehicle is not lowered any further if you are traveling at higher speeds.

Individual suspension settings can be called up in drive program **[L]** (→ page 146).

Setting the vehicle level

⚠ WARNING Risk of accident because vehicle level is too high

Driving characteristics may be impaired. The vehicle can drift outwards, for example, when steering or cornering.

- ▶ Choose a vehicle level which is suited to the driving style and the road surface conditions.

⚠ WARNING Risk of entrapment from vehicle lowering

When lowering the vehicle, people could become trapped if their limbs are between the vehicle body and the tires or underneath the vehicle.

- ▶ Make sure no one is underneath the vehicle or in the immediate vicinity of the wheel arches when the vehicle is being lowered.

⚠ WARNING Risk of becoming trapped due to the vehicle lowering

Vehicles with AIR BODY CONTROL or level control system: when you unload luggage or leave the vehicle, the vehicle first rises slightly and then returns to the set level shortly afterwards.

You or anyone else in the vicinity of the wheel arches or the underbody could thus become trapped.

The vehicle can also be lowered after being locked.

- ▶ When leaving the vehicle, make sure that nobody is in the vicinity of the wheel arches or the underbody.

! NOTE Damage due to vehicle lowering

Parts of the body could be damaged when the vehicle is lowered.

- ▶ Make sure that there are no obstacles such as curbs underneath or in the immediate vicinity of the body when the vehicle is being lowered.

! NOTE Mercedes-AMG vehicles

- ▶ Observe the notes in the Supplement. You could otherwise fail to recognize dangers.

Requirements:

- The vehicle has been started.
- The vehicle must not be moving faster than 37 mph (60 km/h).

Raising the vehicle

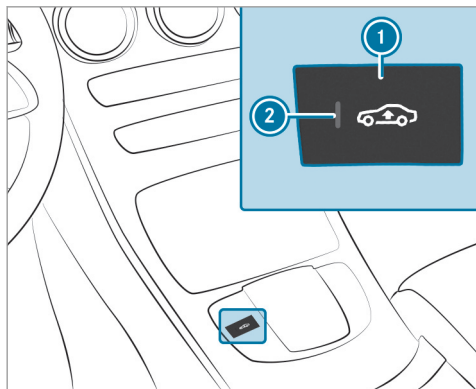

- ▶ Press button ①.
Indicator lamp ② lights up.
The vehicle is set to the high level.

Your selection is saved.

The vehicle is lowered again in the following situations:

- When driving faster than 50 mph (80 km/h).
- When driving between 37 mph (60 km/h) and 50 mph (80 km/h) for approximately three minutes.
- After changing a drive program using the DYNAMIC SELECT switch.

The vehicle is adjusted to the height of the last active drive program.

Lowering the vehicle

- ▶ Press button ①.
Indicator lamp ② goes out. The vehicle is adjusted to the height of the active drive program.

Operation with a trailer or bicycle rack

If the electrical connection has been correctly established to the trailer or bicycle rack:

- Up to approximately 18.7 mph (30 km/h): the high level can be selected regardless of the drive program.

- From approx. 18.7 mph (30 km/h): the vehicle is adjusted to normal level, regardless of drive program.

Rear view camera

Function of the rear view camera

When you engage reverse gear, the image from the rear view camera is shown in the media display. Dynamic guide lines show the path the vehicle will take with the current steering angle. This helps you to orient yourself and to avoid obstacles when backing up.

The rear view camera is only an aid. It is not a substitute for your attention to the surroundings. The responsibility for safe maneuvering and parking remains with you. Make sure that there are no persons, animals or objects etc., in the maneuvering area while maneuvering and parking.

- ⓘ You can open the cover of the rear view camera manually (→ page 203).

The guide lines in the media display show the distances to your vehicle. The distances displayed only apply to road level.

Depending on the vehicle equipment, you can select from the following views:

- Normal view
- Wide-angle view

The area behind the vehicle is displayed as a mirror image, as in the inside rearview mirror.

Vehicles without Parking Assist PARKTRONIC

The following camera views are available in the multimedia system:

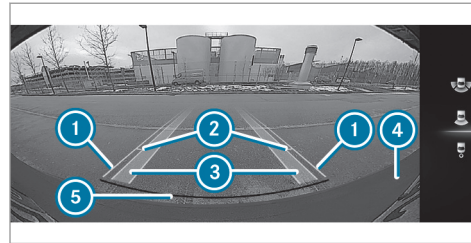

Normal view

- ① Yellow guide line, vehicle width (driven surface) depending on the current steering angle (dynamic)
- ② Yellow guide line at a distance of approximately 3.3 ft (1.0 m) from the rear area
- ③ Yellow lanes marking the course the tires will take with the current steering angle (dynamic)
- ④ Bumper
- ⑤ Red guide line at a distance of approximately 1.0 in (0.3 m) from the rear area

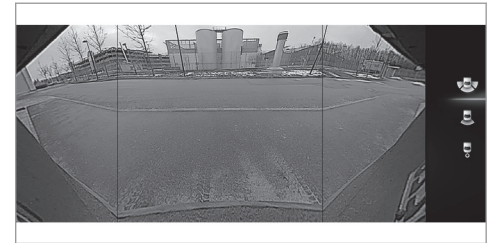

Wide-angle view

Vehicles with Parking Assist PARKTRONIC

The following camera views are available in the multimedia system:

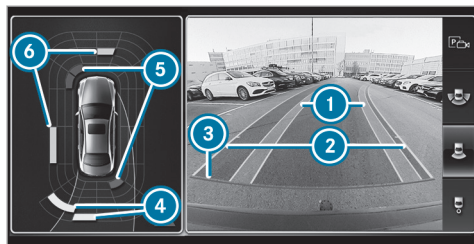

Normal view

- ① Yellow lanes marking the course the tires will take with the current steering angle (dynamic)
- ② Yellow guide line, vehicle width (driven surface) depending on the current steering angle (dynamic)
- ③ Red guide line at a distance of approximately 1.0 in (0.3 m) from the rear area
- ④ Yellow warning indicator of Parking Assist PARKTRONIC: obstacles at a distance between approximately 2.0 ft (0.6 m) and 3.3 ft (1.0 m)

- ⑤ Red warning display of Parking Assist PARKTRONIC: obstacles are very close (approximately 1.0 ft (0.3 m) or less)
- ④ Orange warning display of Parking Assist PARKTRONIC: obstacles are a medium distance away (between approximately 1.0 ft (0.3 m) and 2.0 ft (0.6 m))



Wide-angle view

System failure

If the rear view camera is not operational, the following display appears in the multimedia system.



System limits

The rear view camera will not function or will only partially function in the following situations:

- The trunk lid is open.
 - There is heavy rain, snow or fog.
 - The ambient light conditions are poor, e.g. at night.
 - Cameras, or vehicle components in which the cameras are installed, are damaged, dirty or covered. Observe the information on vehicle sensors and cameras (→ page 161).
- ⓘ Do not use the rear view camera in these types of situations. You could otherwise injure others or collide with objects when parking the vehicle.
 - ⓘ The contrast of the display may be impaired by direct sunlight or by other light sources, e.g. when driving out of a garage. In this case, pay particular attention.

- ❗ Have the display repaired or replaced if, for example, pixel errors considerably restrict its use.

360° camera

Function of the surround view camera

The surround view camera is a system that consists of four cameras. The cameras cover the immediate vehicle surroundings. The system assists you when you are parking or at exits with reduced visibility, for example.

The views of the surround view camera are always available when driving forwards up to a speed of approx. 10 mph (16 km/h) and when backing up.

The surround view camera is only an aid and may show a distorted view of obstacles, show them incorrectly or not show them at all. It is not a substitute for your attention to the surroundings. The responsibility for safe maneuvering and parking remains with you. Make sure that there are no persons, animals or objects etc., in the maneuvering area while maneuvering and parking.

The system evaluates images from the following cameras:

- Rear view camera
- Front camera
- Two side cameras in the outside mirrors

- ❗ You can open the cover of the rear view camera manually (→ page 203).

Views of the surround view camera

You can select from different views:

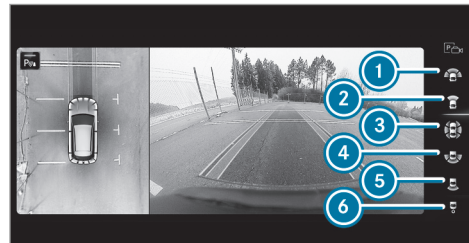

- ❶ Wide-angle view, front
- ❷ Top view with image from the front camera

- ❸ Top view with images from the side cameras in the outside mirrors
- ❹ Wide-angle view, rear
- ❺ Top view with image from the rear view camera
- ❻ Top view with trailer view (vehicles with a trailer hitch)

Top view

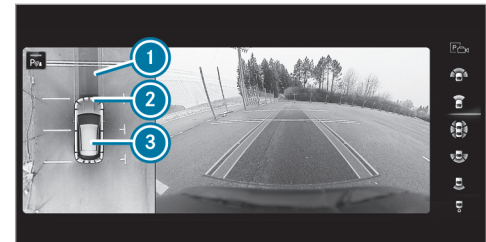

- ❶ Lane indicating the route the vehicle will take at the current steering wheel angle
- ❷ Warning display of Parking Assist PARKTRONIC
- ❸ Your vehicle from above

The color of the individual segments of warning display ② is based on the distance to the detected obstacle:

- **Yellow segments:** obstacles at a distance between approx. 2.0 ft (0.6 m) and 3.3 ft (1.0 m)
- **Orange segments:** obstacles at a distance between approx. 1.0 ft (0.3 m) and 2.0 ft (0.6 m)
- **Red segments:** obstacles at a very short distance of approx. 1.0 ft (0.3 m) or less

When Parking Assist PARKTRONIC is operational and no object is detected, the segments of the warning display are shown in gray.

Guide lines

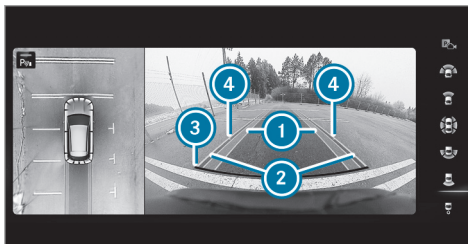

- ① Yellow lane marking the course the tires will take at the current steering wheel angle (dynamic)
 - ② Yellow guide line, vehicle width (driven surface) depending on the current steering wheel angle (dynamic)
 - ③ Red guide line at a distance of approximately 1.0 in (0.3 m) from the rear area
 - ④ Mark at a distance of approx. 3.3 ft (1.0 m)
- ① When Active Parking Assist is active, lane markings ① are displayed in green.

The guide lines in the media display show the distances to your vehicle. The distances apply to road level.

Side view of the mirror cameras

The sides of the vehicle can be seen in this view.

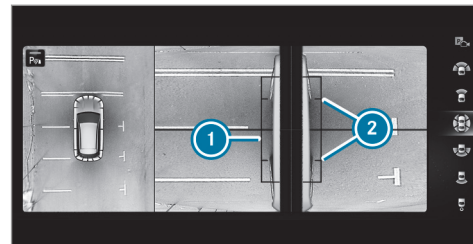

- ① Guide line of external vehicle dimensions with outside mirrors folded out
- ② Marker of the wheel contact points

System failure

If the system is not ready for operation, the following message appears in the media display:



System limits

The surround view camera will not function or will only partially function in the following situations:

- The doors are open.
 - The outside mirrors are folded in.
 - The trunk lid is open.
 - There is heavy rain, snow or fog.
 - The ambient light conditions are poor, e.g. at night.
 - Cameras, or vehicle components in which the cameras are installed, are damaged, dirty or covered. Observe the information on vehicle sensors and cameras (→ page 161).
- i** Do not use the surround view camera under such circumstances. You could otherwise injure others or collide with objects when parking the vehicle.

For technical reasons, the standard height of the vehicle may be altered if the vehicle is carrying a heavy load and can result in inaccuracies in the guide lines and in the display of the generated images.

- i** The contrast of the display may be impaired by abrupt, direct sunlight or by other light sources, e.g. when driving out of a garage. In this case, pay particular attention.
- i** Have the display repaired or replaced if, for example, pixel errors considerably restrict its use.

See the notes on cleaning the surround view camera (→ page 272).

Calling up the view of the surround view camera using reverse gear

- ▶ Shift to reverse gear.
- ▶ Select the desired view in the multimedia system (→ page 201).
- ▶ If, after shifting to reverse gear, the image of the rear view camera is not shown: switch off the ignition, press and hold the  button, switch on the ignition and engage reverse gear again.

Opening the camera cover of the rear view camera

Multimedia system:

→  ▶ Settings ▶ Assistance
▶ Camera & Parking

▶ Select **Open Camera Cover**.

- i** The camera cover closes automatically after some time or after an ignition cycle.

Parking Assist PARKTRONIC

Function of Parking Assist PARKTRONIC

Parking Assist PARKTRONIC is an electronic parking assistance system with ultrasound. It monitors the area around your vehicle using multiple sensors on the front bumper and on the rear bumper. Parking Assist PARKTRONIC shows you the distance between your vehicle and a detected obstacle visually and audibly.

Parking Assist PARKTRONIC is only an aid. It is not a substitute for your attention to the surroundings. The responsibility for safe maneuvering and parking remains with you. Make sure that there are no persons, animals or objects in

the maneuvering area while maneuvering and parking in/exiting parking spaces.

In the standard setting, an intermittent warning tone sounds from a distance of approximately 1.0 ft (0.3 m) to an obstacle in front and approximately 3.3 ft (1.0 m) to an obstacle behind. A continuous warning tone sounds from a distance of approximately 0.7 ft (0.2 m). Using the **Warn Early All Around** setting in the multimedia system, the warning tones for front and side impact protection can be set to sound at a greater distance of approximately 3.3 ft (1.0 m) in front and 2.0 ft (0.6 m) on the sides (→ page 208).

- ① The **Warn Early All Around** setting is always active at the rear of the vehicle.

Parking Assist PARKTRONIC display in the multimedia system

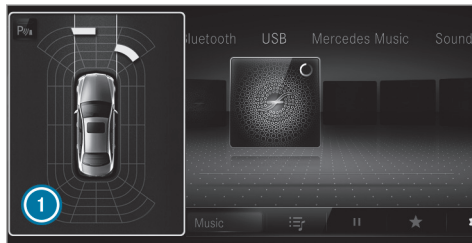

Vehicles without surround view camera

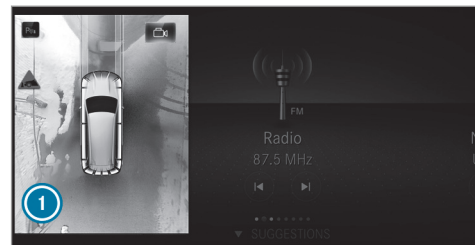

Vehicles with surround view camera

If you have not selected the **Camera & Parking** menu and an obstacle is detected in the path of the vehicle, a pop-up window for Parking Assist PARKTRONIC ① appears in the multimedia system at speeds below 6 mph (10 km/h).

The color of the individual segments of the warning display is based on the distance to the detected obstacle:

- **Yellow segments:** obstacles at a distance between approx. 2.0 ft (0.6 m) and 3.3 ft (1.0 m)

- **Orange segments:** obstacles at a distance between approx. 1.0 ft (0.3 m) and 2.0 ft (0.6 m)
- **Red segments:** obstacles at a very short distance of approx. 1.0 ft (0.3 m) or less

Display of Parking Assist PARKTRONIC in the Head-up Display

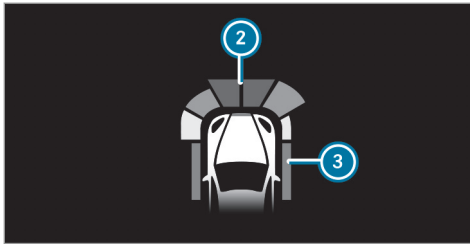

Optionally, obstacles detected by Parking Assist PARKTRONIC from a distance of approximately 3.3 ft (1.0 m) in front ② and 2.0 ft (0.6 m) on the sides ③ can also be displayed in the Head-up Display.

System limits

Parking Assist PARKTRONIC does not necessarily take into account the following obstacles:

- Obstacles below the detection range, e.g. persons, animals or objects.
- Obstacles above the detection range, e.g. overhanging loads, overhangs or loading ramps of trucks.

The sensors must be free of dirt, ice and slush. Otherwise, they may not function correctly. Clean the sensors regularly, taking care not to scratch or damage them (→ page 161).

Problems with Parking Assist PARKTRONIC

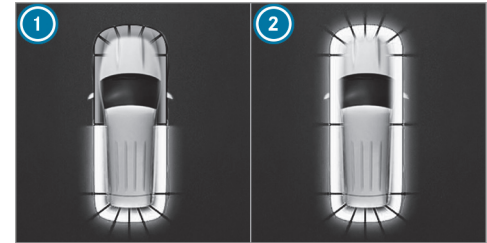

Example: vehicles with surround view camera

When rear segments ① or all-round segments ② light up red and the  symbol appears in the multifunction display, Parking Assist PARKTRONIC may have been deactivated due to signal interference. Start the vehicle again and check if Parking Assist PARKTRONIC is working at a different location.

If a warning tone also sounds for approximately two seconds every time the vehicle is started, it may be due to one of the following causes:

- **The sensors are dirty:** clean the sensors and observe the notes on care of vehicle parts (→ page 272).
- **Parking Assist PARKTRONIC has been deactivated due to a malfunction:** restart the vehicle. If the problem persists, consult a qualified specialist workshop.

Function of the passive side impact protection

Passive side impact protection is an additional Parking Assist PARKTRONIC function which warns the driver about obstacles at the side of the vehicle. A warning is issued when obstacles are detected between the front and rear detection range. In order for an object on the side to be detected, the sensors in the front and rear bumper must first detect the object while you are driving past it.

During the parking procedure or when maneuvering, objects are detected as the vehicle drives past. If you steer in the direction of a detected

obstacle and there is a risk of a lateral collision, a warning is issued and the segments light up in color in the display.

The segment color changes depending on the distance to the detected obstacle:

- **Yellow:** approximately 1.0 - 2.0 ft (30 - 60 cm)
- **Red:** less than approximately 1.0 ft (30 cm)

In order for lateral front or rear segments to be displayed, the vehicle must first travel a distance of at least half of the vehicle length. Once the vehicle has traveled the length of the vehicle, all of the lateral front and rear segments can be displayed.

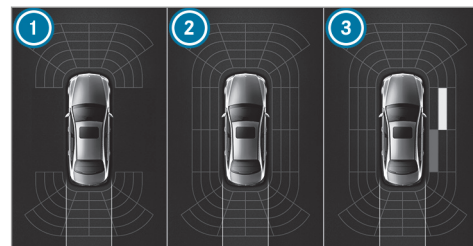

Parking Assist PARKTRONIC display: vehicles without a surround view camera

- ① Operational front and rear
- ② Operational front, rear and sides
- ③ Obstacle detected at the front right (yellow) and rear (red)

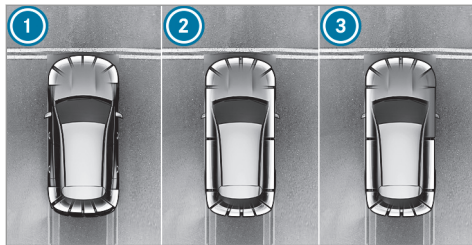

Parking Assist PARKTRONIC display: vehicles with a surround view camera

- ① Operational front and rear
- ② Operational front, rear and sides
- ③ Obstacles detected at the front right (red)

Saved obstacles on the sides are deleted in the following situations, for example:

- You park the vehicle and switch off the ignition.
- You open the doors.

After the engine is restarted, obstacles on the sides must be detected again before a new warning can be issued.

System limits

The system limits for Parking Assist PARKTRONIC apply to passive side impact protection.

The following objects are not detected, for example:

- Pedestrians who approach the vehicle from the side
- Objects placed next to the vehicle

Activating/deactivating Parking Assist PARKTRONIC

! **NOTE** Risk of an accident from objects at close range

Parking Assist PARKTRONIC may not detect certain objects at close range.

- ▶ When parking or maneuvering the vehicle, pay particular attention to any objects which are above or below the sensors, e.g. flower pots or drawbars. The vehicle or other objects could otherwise be damaged.

▶ Vehicles without AIR BODY CONTROL:

press the button in the center console.

- ① **Vehicles with AIR BODY CONTROL:** you can activate or deactivate Parking Assist PARKTRONIC in the multimedia system (→ page 207).

If the indicator lamp in the button is not lit, Parking Assist PARKTRONIC is active. If the indicator lamp is lit or the symbol appears in the instrument cluster, Parking Assist PARKTRONIC is not active.

- ① Parking Assist PARKTRONIC is automatically activated when the vehicle is started.

Activating/deactivating Parking Assist PARKTRONIC using the multimedia system

! **NOTE** Risk of an accident from objects at close range

Parking Assist PARKTRONIC may not detect certain objects at close range.

- ▶ When parking or maneuvering the vehicle, pay particular attention to any objects which are above or below the

sensors, e.g. flower pots or drawbars. The vehicle or other objects could otherwise be damaged.

Requirements:

- The camera menu is open.
- Or: Active Parking Assist is active.
- Or: the PARKTRONIC pop-up window appears.

▶ Tap  in the media display.

If the indicator lamp is lit, Parking Assist PARKTRONIC is active. If the indicator lamp is not lit or the  symbol appears in the instrument cluster, Parking Assist PARKTRONIC is not active.

 Parking Assist PARKTRONIC is automatically activated when the vehicle is started.

Alternatively, Parking Assist PARKTRONIC can be activated or deactivated in the quick access menu.

Setting the warning tones of Parking Assist PARKTRONIC

Multimedia system:

▶  ▶  ▶ Settings ▶ Assistance
▶ ▶ Camera & Parking

Adjusting the volume of the warning tones

- ▶ Select [Warning Tone Volume](#).
- ▶ Set a value.

Adjusting the pitch of the warning tones

- ▶ Select [Warning Tone Pitch](#).
- ▶ Set a value.

Specifying the starting point for the warning tones

You can specify whether the Parking Assist PARKTRONIC warning tones should commence when the vehicle is further away from an obstacle.

- ▶ Select [Warn Early All Around](#).
- ▶ Activate or deactivate the function.

Activating/deactivating audio fadeout

You can specify whether the volume of a media source in the multimedia system is to be reduced when Parking Assist PARKTRONIC sounds a warning tone.

- ▶ Select [Audio Fadeout During Warning Tones](#).
- ▶ Activate or deactivate the function.

Active Parking Assist

Function of Active Parking Assist

Active Parking Assist is an electronic parking assistance system, which uses ultrasound with the assistance of the rear view camera and surround view camera. When you are driving forwards up to approximately 22 mph (35 km/h), the system automatically measures parking spaces on both sides of the vehicle.

As soon as all requirements are met for searching for parking spaces, the  display appears in the multifunction display.

When Active Parking Assist has detected parking spaces, the  display appears in the multifunction display. The arrows show on which side

of the road detected parking spaces are located. They are then shown in the media display.

The parking space can be selected as desired. Depending on the location of the parking space, the parking direction (rearwards or forwards) can also be selected as desired.

When Active Parking Assist is activated, the turn signal indicators are activated based on the calculated path of your vehicle.

When you are entering or exiting a parking space, the procedure is assisted by acceleration, braking, steering and gear changes.

Active Parking Assist is only an aid. It is not a substitute for your attention to the surroundings. The responsibility for safe maneuvering and parking remains with you. Make sure that no persons, animals or objects etc. are in the maneuvering range.

Active Parking Assist will be canceled in the following situations:

- Parking Assist PARKTRONIC is deactivated.
- You begin steering.
- You apply the parking brake.

- You engage transmission position **P**.
- ESP® intervenes.
- You open the doors or the trunk lid while driving.

System limits

If the exterior lighting is malfunctioning, Active Parking Assist is not available.

Objects located above or below the detection range of the sensors, e.g. overhanging loads, overhangs or loading ramps of trucks, or the borders of parking spaces, are not detected during measurement of the parking space. These are also then not taken into account when calculating the parking procedure. In some circumstances, Active Parking Assist may therefore guide you into the parking space incorrectly.

⚠ WARNING Risk of accident due to objects located above or below the detection range of Active Parking Assist

If there are objects above or below the detection range, the following situations may arise:

- Active Parking Assist may steer too early.
- The vehicle may not stop in front of these objects.

This could cause a collision.

▶ In these situations, do not use Active Parking Assist.

Extreme weather conditions, such as snow or heavy rain, may lead to a parking space being measured inaccurately. Parking spaces that are partially occupied by trailer drawbars might not be identified as such or be measured incorrectly. Only use Active Parking Assist on level, high-grip ground.

210 Driving and parking

Do not use Active Parking Assist in the following situations:

- In extreme weather conditions such as ice, packed snow or in heavy rain.
- When transporting a load that protrudes beyond the vehicle.
- On steep uphill or downhill gradients of more than approximately 15%.
- When snow chains are installed.
- Directly after a tire change or when spare tires are installed.
- If the tire pressure is too low or too high.
- If the suspension is out of alignment, e.g. after bottoming out on a curb.

Active Parking Assist may also display parking spaces that are not suitable for parking, such as:

- Parking spaces where parking is prohibited.
- Parking spaces on unsuitable surfaces.

Parking with Active Parking Assist

- i** Depending on the vehicle's equipment, the button may also be located at a different position in the center console.

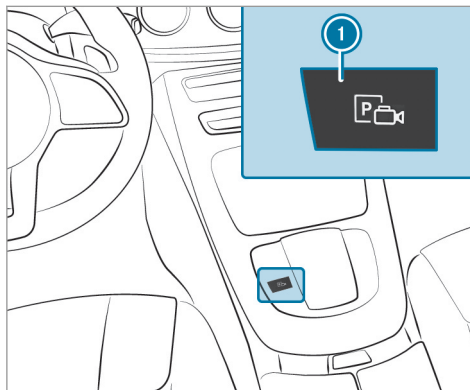

- ▶ Press button **1**.

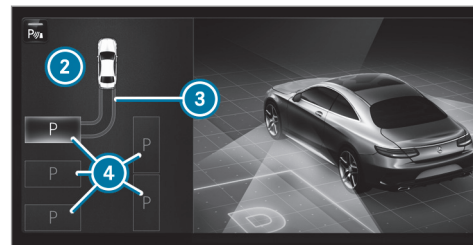

The media display shows the view of Active Parking Assist. Area **2** displays detected parking spaces **4** and vehicle path **3**.

- i** Vehicle path **3** shown on the media display may differ from the actual vehicle path.

- ▶ If a parking space is displayed: stop the vehicle.
- ▶ Select desired parking space **4** and confirm.
- ▶ If necessary, select the parking direction: forwards or reverse, and confirm. Vehicle path **3** is shown, depending on selected parking space **4** and the parking direction.

- ① The turn signal indicator is switched on automatically when the parking procedure begins.

You are responsible for selecting the turn signal indicator in accordance with the traffic conditions. If necessary, select the turn signal indicator accordingly.

⚠ WARNING Risk of accident due to vehicle swinging out while parking or pulling out of a parking space

While parking or exiting a parking space, the vehicle swings out and can drive onto areas of the oncoming lane.

This could cause you to collide with objects or other road users.

- ▶ Pay attention to objects and other road users.
- ▶ Where necessary, stop the vehicle or cancel the parking procedure with Active Parking Assist.

- ▶ If, for example, the **Please Engage Reverse Gear** message appears in the media display:

select the corresponding transmission position.
The vehicle drives into the selected parking space.

- ① During the parking procedure with Active Parking Assist, the lane markings are displayed in green in the camera image.

On completion of the parking procedure, the  **Parking Assist Finished, Take Control of Vehicle** display message appears. Further maneuvering may still be necessary.

- ▶ After completion of the parking procedure, safeguard the vehicle against rolling away. When required by legal requirements or local conditions: turn the wheels towards the curb.
- ① You can stop the vehicle and change the transmission position during the parking procedure. The system then calculates a new vehicle path. If no new vehicle path is available, the system can change the transmission position again or cancel the parking procedure.

Exiting a parking space with Active Parking Assist

Requirements:

- The vehicle has been parked with Active Parking Assist.
- ① Depending on the vehicle's equipment, the button may also be located at a different position in the center console.

Please note that you are responsible for the vehicle and surroundings during the entire parking procedure.

- ▶ Start the vehicle.

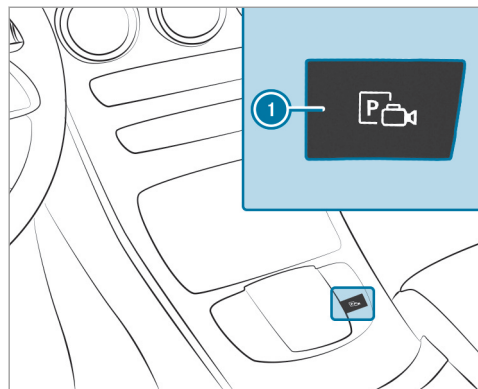

- ▶ Press button ①. The media display shows the view of Active Parking Assist.

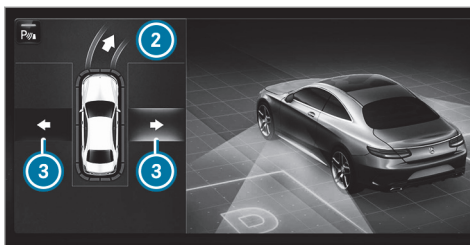

- ▶ If the vehicle has been parked perpendicular to the direction of travel: in area ②, select direction of travel ③ **Left** or **Right**.

① The vehicle path shown on the media display may differ from the actual vehicle path.

- ▶ Confirm direction of exit ③ to drive out of the parking space.

① The turn signal indicator is switched on automatically when the exiting procedure begins.

You are responsible for selecting the turn signal indicator in accordance with the traffic conditions. If necessary, select the turn signal indicator accordingly.

⚠ WARNING Risk of accident due to vehicle swinging out while parking or pulling out of a parking space

While parking or exiting a parking space, the vehicle swings out and can drive onto areas of the oncoming lane.

This could cause you to collide with objects or other road users.

- ▶ Pay attention to objects and other road users.
- ▶ Where necessary, stop the vehicle or cancel the parking procedure with Active Parking Assist.

- ▶ If, for example, the **Please Engage Forward Gear** message appears in the media display: select the corresponding transmission position.

The vehicle moves out of the parking space. The turn signal indicator is switched off automatically.

After the parking space has been exited, a warning tone and the  **Parking Assist Finished**,

Take Control of Vehicle message prompt you to take control of the vehicle.

The vehicle is not automatically braked and can roll away. You have to accelerate, brake, steer and change gear yourself again.

Maneuvering assistance

Function of Drive Away Assist

Drive Away Assist can reduce the severity of an impact when pulling away. If an obstacle is detected in the direction of travel, the vehicle's speed is briefly reduced to approx. 1 mph (2 km/h). If a critical situation is detected, the  symbol appears in the media display.

-  You can cancel an intervention by Drive Away Assist at any time by deactivating Parking Assist PARKTRONIC (→ page 207).

⚠ WARNING Risk of accident caused by limited detection performance of Drive Away Assist

Drive Away Assist cannot always clearly identify objects and traffic situations.

- ▶ Always pay careful attention to the traffic situation; do not rely on Drive Away Assist alone.
- ▶ Be prepared to brake or swerve as necessary, provided the traffic situation permits and that it is safe to take evasive action.

Drive Away Assist is only an aid. It is not a substitute for your attention to the surroundings. The responsibility for safe maneuvering and parking remains with you. Make sure that no persons, animals or objects etc. are in the maneuvering range.

A risk of a collision may arise in the following situations, for example:

- If the accelerator and brake pedals are mixed up.
- If an incorrect transmission position is engaged.

Drive Away Assist is active under the following conditions:

- If Parking Assist PARKTRONIC is activated.

- If you shift the transmission position to **R** or **D** when the vehicle is stationary.
- If the detected obstacle is less than approx. 3.3 ft (1.0 m) away.
- If the maneuvering assistance function is activated in the multimedia system.

System limits

The performance of Drive Away Assist is limited on inclines.

-  Also observe the system limits of Parking Assist PARKTRONIC (→ page 203).

Function of Cross Traffic Alert

-  Cross Traffic Alert is only available for vehicles with Blind Spot Assist or Active Blind Spot Assist.

Cross Traffic Alert can warn drivers of any crossing traffic when backing up and maneuvering out of a parking space. The radar sensors in the bumper also monitor the area adjacent to the vehicle. If a critical situation is detected, the  symbol appears in the media display and the vehicle can be braked automatically.

214 Driving and parking

If the radar sensors are obstructed by vehicles or other objects, detection is not possible.

Cross Traffic Alert is active under the following conditions:

- If the vehicle is backing up at walking pace.
 - Maneuvering assistance is activated (→ page 214).
-  Also observe the instructions on Blind Spot Assist and Active Blind Spot Assist (→ page 191).

System limits

Cross Traffic Alert is not available on inclines.

Activating/deactivating the maneuvering assistant

Multimedia system:

   Settings  Assistance

 Camera & Parking

 Switch [Maneuvering Assistance](#) on or off.

-  The maneuvering assistant must be active for the function of Drive Away Assist (→ page 213) and Cross Traffic Alert (→ page 213).

Vehicle towing instructions

The vehicle is not suitable for the use of tow bar systems that are used for flat towing or dinghy towing, for example. Attaching and using tow bar systems can lead to damage on the vehicle.

When you are towing a vehicle with tow bar systems, safe driving characteristics cannot be guaranteed for the towing vehicle or the towed vehicle. The vehicle-trailer combination may swerve from side to side. Comply with the permitted towing methods (→ page 288) and the instructions for towing with both axles on the ground (→ page 289).

Notes on the Instrument Display and on-board computer

⚠ WARNING Risk of accident due to an Instrument Display malfunction

If the Instrument Display has failed or malfunctioned, the function restrictions applying to safety relevant systems are not visible.

The operating safety of your vehicle may be impaired.

- ▶ Drive on carefully.
- ▶ Have the vehicle checked immediately at a qualified specialist workshop.

⚠ WARNING Risk of distraction from information systems and communications equipment

If you operate information and communication equipment integrated in the vehicle when driving, you will be distracted from the traffic situation. This could also cause you to lose control of the vehicle.

- ▶ Only operate this equipment when the traffic situation permits.
- ▶ If you cannot be sure of this, stop the vehicle whilst paying attention to road and traffic conditions and operate the equipment with the vehicle stationary.

! NOTE Mercedes-AMG vehicles

- ▶ Observe the notes in the Supplement. You could otherwise fail to recognize dangers.

You must observe the legal requirements for the country in which you are currently driving when operating the on-board computer.

The on-board computer shows only display messages and warnings from specific systems on the multifunction display. You must therefore ensure that your vehicle is always reliable.

If the operating safety of your vehicle is impaired, park the vehicle immediately and safely. Contact a qualified specialist workshop.

Instrument Display overview

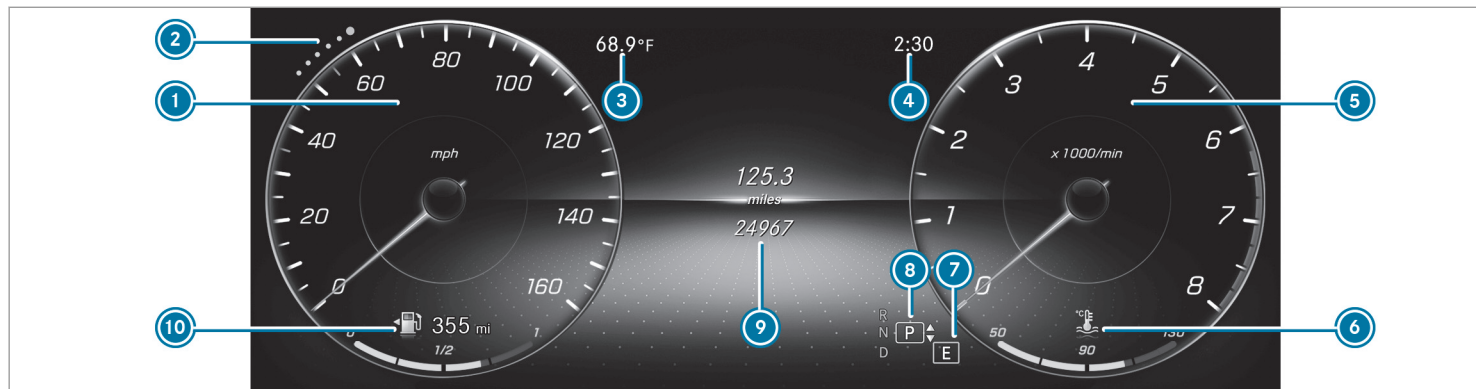

- ① Speedometer
The segments on the speedometer indicate the statuses of the following systems: cruise control/limiter/Active Distance Assist DISTRONIC
- ② Index points
- ③ Outside temperature

- ④ Time
- ⑤ Area for additional values (example: tachometer)/navigation/ECO display/consumption/G-meter/date
The fuel supply will be interrupted to protect the engine when the red mark on the tachometer (overrevving range) is reached.
- ⑥ Coolant temperature display



- ⑦ Selected drive program
- During normal operation, the coolant temperature display is permitted to rise to 248°F (120°C).
Vehicles with 48 V on-board electrical system: POWER and CHARGE display (electrical drive support and recuperation power of the electric motor)

- ⑧ Selected transmission position
- ⑨ Multifunction display (example: standard display for a trip): assistance/telephone/navigation/trip/media/radio/styles and displays/service/possible settings for Head-up Display
- ⑩ Fuel level and fuel filler flap location indicator

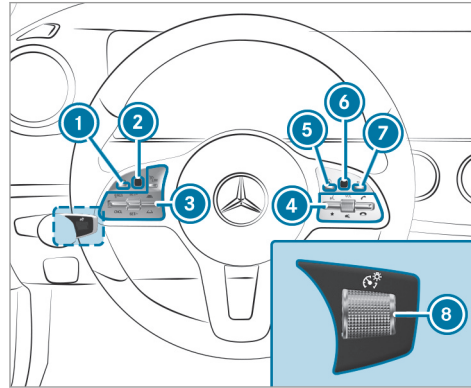
Overview of the buttons on the steering wheel



- ①  Back/Home button (press and hold), on-board computer
- ② Touch Control, on-board computer
- ③ Control panel for cruise control or Active Distance Assist DISTRONIC

- ④ Control panel for the MBUX multimedia system (→ page 222)
 -  Voice Control System
 - ⑤  To call up the home screen of the multimedia system
 - ⑥ Touch Control multimedia system
 - ⑦  Back button (multimedia system)
 - ⑧ Brightness control to adjust the lighting in the Instrument Display and in the control elements of the vehicle interior

Operating the on-board computer

Observe the legal requirements for the country in which you are currently driving when operating the on-board computer.



The on-board computer is operated using the left-hand Touch Control and the left-hand back/home button.

When the on-board computer is being operated, different acoustic signals will sound as operating feedback, e.g. when the end of a list is reached or when you are scrolling through a list.

The following menus are available:

- Assistance
- Phone
- Navigation
- Trip
- Radio

- Media
- Service
- Vehicles with an Instrument Display in the Widescreen Cockpit: [Designs](#)

i You can find information about the possible settings and selections on the menus in the Digital Operator's Manual.

▶ To call up the menu bar: press the left-hand back button until the menu bar is displayed.

i **Vehicles without Active Distance Assist DISTRONIC:** press the  button to call up the menu bar of the on-board computer.

▶ To scroll in the menu bar: swipe left or right on the left-hand Touch Control.

▶ To call up a menu, submenu or possible settings on the menu, or confirm a selection or setting: press the left-hand Touch Control.

▶ To scroll through displays or lists on the menu, or select display content, a function, an entry or a display: swiping up or down on the left-hand Touch Control.

▶ To switch between displays: swiping up or down on the left-hand Touch Control.

▶ To exit a submenu: press the left-hand back button.

Selecting the Head-up Display

▶ To switch on the Head-up Display: switch on the Head-up Display via the multimedia system or activate it in the menu bar by swiping upwards on the left-hand Touch Control. The Head-up Display menu will be selected on the Head-up Display.

▶ To switch to the Head-up Display: press the left-hand Touch Control or swipe upwards on the left-hand Touch Control.

▶ To set the three display ranges of the Head-up Display: swiping up or down on the left-hand Touch Control.

Full-screen menus

You can display the following menus full-screen on the Instrument Display:







- Assistance
- Trip





- **Navigation**

- ▶ On the corresponding menu, use the left-hand Touch Control to scroll to the end of the list.
- ▶ Press the left-hand Touch Control. The selected menu will be displayed full-screen.

Overview of displays on the multifunction display

Displays on the multifunction display

-  Active Parking Assist activated (→ page 210)
-  Parking Assist PARKTRONIC deactivated (→ page 207)
-  Cruise control (→ page 169)
-  Active Distance Assist DISTRONIC (→ page 171)
-  Active Brake Assist (→ page 186)
-  Active Steering Assist (→ page 178)
-  Active Traffic Jam Assist (→ page 177)

-  Active Lane Keeping Assist (→ page 194)
-  Active Lane Change Assist (→ page 181)
-  ECO start/stop function (→ page 141)
-  HOLD function (→ page 166)
-  Adaptive Highbeam Assist (→ page 117)

Vehicles with Traffic Sign Assist: Detected instructions and traffic signs (→ page 187).

For an overview of the indicator and warning lamps, see (→ page 387).

Head-up Display

Function of the Head-up Display

NOTE Mercedes-AMG vehicles

- ▶ Observe the notes in the Supplement. You could otherwise fail to recognize dangers.

The Head-up Display projects the following information into the driver's field of vision above the cockpit, for example:

- The vehicle speed

- Information from the navigation system
- Information from the driving systems and driving safety systems
- Some warning messages

Depending on the vehicle's equipment, different content can be shown in the three areas of the Head-up Display (→ page 220).

Display content

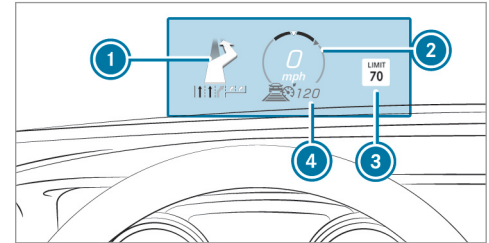

- ① Navigation instructions
- ② Current speed

- ③ Detected instructions and traffic signs
- ④ Set speed in the driving system (e.g. cruise control)

System limits

The visibility of the displays will be affected by the following conditions:

- Seat position
 - Image position setting
 - Ambient light conditions
 - Wet road
 - Objects on the display cover
 - Polarization in sunglasses
- ① In extreme sunlight, sections of the display may appear washed out. You can correct this by switching the Head-up Display off and on again.

Setting the Head-up Display using the on-board computer

On-board computer:



The following Head-up Display settings or displays can be selected or shown:

- Position
- Brightness
- Messages
- Assistance status
- Telephone
- Audio
- Voice Control System

- ▶ **To select the Settings menu:** swipe to the right on the left-hand Touch Control. The Settings menu ⑤ will be selected.
- ▶ **To call up the Settings menu:** press the left-hand Touch Control.
- ▶ **To adjust the position:** swiping up or down on the left-hand Touch Control.

- ▶ **To adjust the brightness:** swipe to the left or right on the left-hand Touch Control.

Setting messages, assistance status, telephone, audio and the Voice Control System

- ▶ Press the left-hand Touch Control. The list of setting options will be displayed.
- ▶ Swipe upwards or downwards on the left-hand Touch Control and select a setting by pressing the left-hand Touch Control.

Selecting what the Head-up Display shows

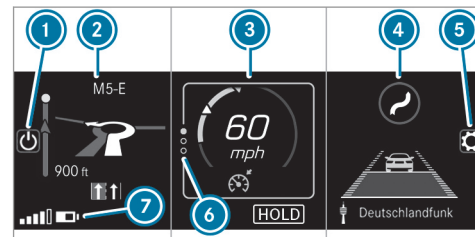

(Example)

- ① To switch the Head-up Display on/off
- ② Left display area

Navigation system
Average consumption
G-meter

- ③ Central display area
Speedometer

Set speed in the driver assistance system,
e.g. cruise control
Warnings from driver assistance systems,
e.g. distance warning

- ④ Right display area
Traffic Sign Assist
Assistant display

- ⑤ To adjust the position, brightness and lower display area
- ⑥ Index points
- ⑦ Lower display area (example: left display area)

Display areas ② to ④ that are not required can be hidden.

- ⓘ In audio mode, the station name or track will be shown temporarily when the audio source is being actively operated. In addition, the latest calls will be displayed when the tele-

phone list on the Instrument Display is actively operated.

- ▶ **To select a display:** swipe upwards on the left-hand Touch Control.
- ▶ Press the left-hand Touch Control.

Switching the Head-up Display on/off via the multimedia system

Multimedia system:

→  ▶ Settings ▶ Quick Access

- ▶ Select HUD.
The Head-up Display is activated.

Overview and operation

Notes on the MBUX multimedia system

⚠ WARNING Risk of distraction from information systems and communications equipment

If you operate information and communication equipment integrated in the vehicle when driving, you will be distracted from the traffic situation. This could also cause you to lose control of the vehicle.

- ▶ Only operate this equipment when the traffic situation permits.
- ▶ If you cannot be sure of this, stop the vehicle whilst paying attention to road and traffic conditions and operate the equipment with the vehicle stationary.

You must observe the legal requirements for the country in which you are currently driving when operating the multimedia system.

Overview of the MBUX multimedia system

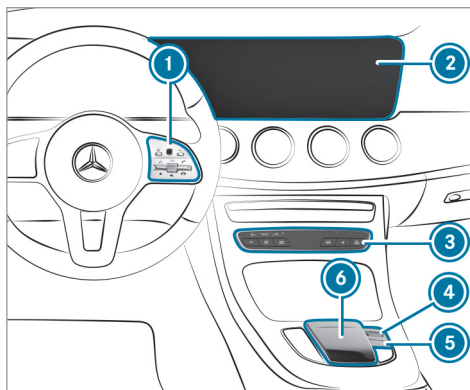

- ① Touch Control and control panel for the MBUX multimedia system
- ② Media display with touch functionality
- ③ Control panel for telephone, navigation, radio/media, vehicle functions/system settings and favourites/themes
- ④ Controller

Turn: adjusts the volume

Press: switches sound on or off

- ⑤  Switches the multimedia system or media display on or off
- ⑥ Touchpad

Further operating options:

- Conducting a voice dialog with the Voice Control System.
 - Operating functions contact-free with the MBUX Interior Assistant.
- ① You can find further information about operation as well as about applications and services in the Digital Operator's Manual.

Anti-theft protection

This device is equipped with technical provisions to protect it against theft. Further information on protection against theft can be obtained from an authorized Mercedes-Benz Center.

Home screen overview

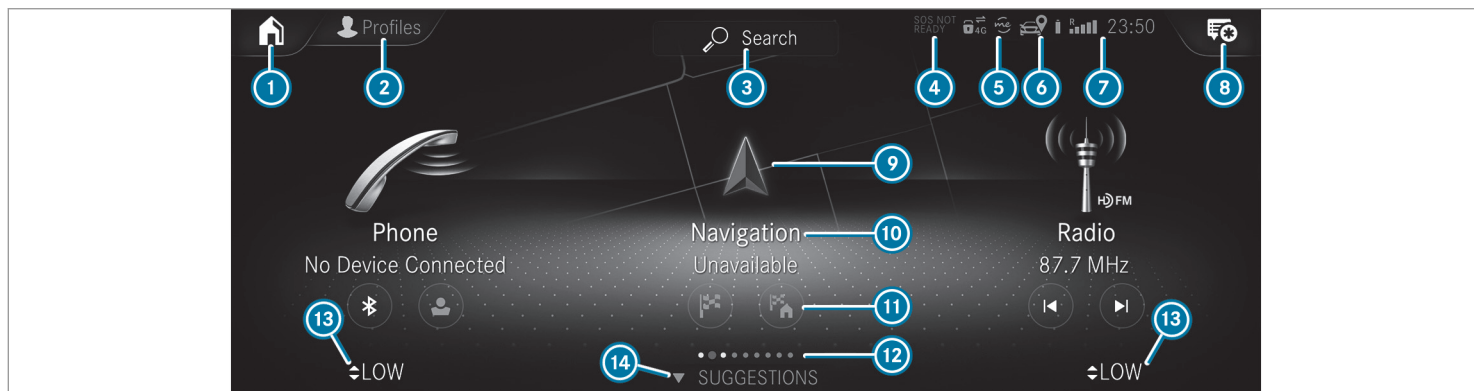

- ① Depending on the display, calls up the first three applications or the home screen
- ② Calls up the profile
- ③ Calls up the global search
- ④ SOS NOT READY (only when the Mercedes-Benz emergency call system is not available)
- ⑤ Mercedes me connect active

- ⑥ Transmission of vehicle position active
- ⑦ Signal strength of the mobile phone network, network display, battery status of the mobile phone connected, time
- ⑧ Calls up the Notifications Center
- ⑨ Calls up an application using the symbol
- ⑩ Application and current information

- ⑪ Quick-access, e.g. enter home address
- ⑫ Index points and selected display area
- ⑬ Calls up the air conditioning menu
- ⑭ Calls up **SUGGESTIONS**, **THEMES** and **FAVORITES**

- i** If Mercedes me connect is active **5**, the vehicle is linked with Mercedes me connect. Vehicle data is then transmitted to the back-end system. What data is transmitted depends on which services are activated. Further details can be found in the Mercedes me connect terms and conditions and data protection information. The function is country-dependent.
- If transmission of vehicle position is active **6**, Mercedes me connect services have been activated for this vehicle which access the vehicle's geolocation. In which instances the geolocation is transmitted depends on the particular services. Further details can be found in the Mercedes me connect terms and conditions and data protection information. The function is country-dependent.

Operating the MBUX multimedia system

Using Touch Control

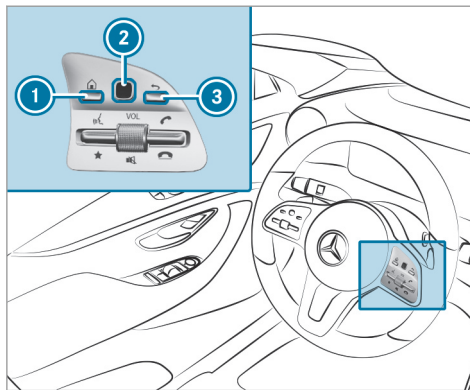

- 1** Shows the home screen
- 2** Touch Control
Swipe up, down, to the left and right (to navigate) and press (to confirm)
- 3** Returns to the previous display

Navigation through the menus is carried out with Touch Control **2** with single-finger swipes.



- ▶ **To select a menu option:** swipe and press.
- ▶ **To move the digital map:** swipe in any direction.

Using the touchscreen

- ▶ Select menu options, symbols or characters by pressing briefly.
- ▶ **To navigate in menus:** swipe up, down, left or right.
- ▶ **To use handwriting to enter characters:** write the character with one finger on the touchscreen.
- ▶ **To zoom in and out of the map:** move two fingers together or apart.
- ▶ **To call up the global menu:** press and hold on the touchscreen until the **OPTIONS** menu appears.

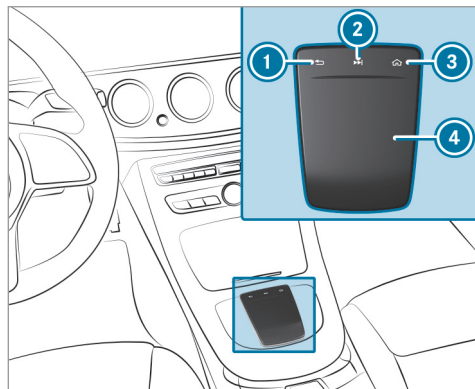
Using the touchpad





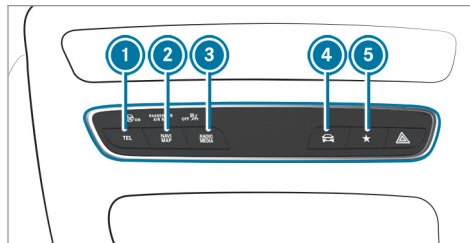

- ①  Returns to the previous display
 - ②  Calls up the audio control menu
 - ③  Calls up the home screen
 - ④ Touchpad
- ▶ **To select a menu option:** swipe and press.

- ▶ **To use handwriting recognition:** write a character on the touchpad.
- ▶ **To open or close the Notifications Center:** swipe down or up with two fingers.
- ▶ **To zoom in and out of the map:** move two fingers together or apart.

Calling up applications using buttons



- ①  button calls up the telephone
- ②  button calls up navigation
- ③  button calls up radio or media
- ④  button calls up vehicle functions
- ⑤  button

Press briefly: calls up favourites
 Press and hold: adds a favourite or creates a new theme

- ▶ Alternatively, tap  on the touchscreen.
- ▶ Call up the application (→ page 223).

Functions of the Voice Control System

With the Voice Control System, various applications in the MBUX multimedia system are operable using voice input. The Voice Control System is operational approximately thirty seconds after the ignition is switched on and is available for the driver's seat and front passenger seat.

The following multimedia system applications can be operated:

- Navigation
- Telephone
- Radio and TV
- Media player
- Messages
- Vehicle functions

Starting the Voice Control System

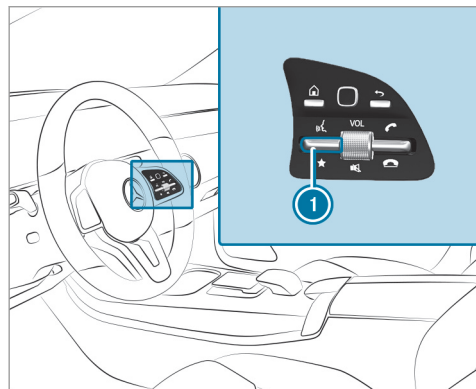

- ▶ Press rocker switch ① up.
or
- ▶ Say "Hello Mercedes".

Overview of the MBUX Interior Assistant

⚠ WARNING Risk of injury from the camera's laser radiation

This product uses a classification 1 laser system. If the housing is opened or damaged, laser radiation may damage your retina.

- ▶ Do not open the housing.
- ▶ Always have maintenance work and repairs carried out by a qualified specialist workshop.

This product complies with the requirements of the FDA 21 CFR 1040.10 and 1040.11 with exception of the variations according to the FDA Laser Notice No. 50 from 24. June 2007.

The camera is located in the overhead control panel.

If the vehicle is equipped with the MBUX Interior Assistant, selected functions of the multimedia system can be operated contact-free. The MBUX Interior Assistant can differentiate between driver and front passenger interactions and detects specific hand positions (poses).

System limits, display messages and notes for rectification

The system may be impaired or may not function in the following situations:

- The camera in the overhead control panel may heat up due to operating conditions. As a result the camera may switch off temporarily, particularly during longer periods of operation and at high outside temperatures.

Do not touch or cover the camera and wait until the camera has cooled down and is available again.

- The camera is covered or dirty, fogged up or scratched.

Wait until the camera has cooled down before cleaning the camera lens.

Clean the outside of the camera lens with a dry or damp cotton cloth. Do not use microfiber cloths. Do **not** remove the cover when cleaning.

- Recognition can be impaired by reflective clothing, an adverse color of clothing or by accessories, for example.

- Clothing being worn (hat, shawl, scarf) may be limiting the detection area of the camera.
 - The camera is not operational.
- Keep the camera's field of vision clear.
- Consult an authorized Mercedes-Benz Center.

The MBUX Interior Assistant supports the following interactions:

Interaction area	Interaction	Description
In front of the media display or above the touchpad	Proximity to the control element	The Interior Assistant recognizes the approach of the hand towards a control element. Depending on the active application, the display will be adjusted in the media display. Some functions differentiate between driver and front passenger. No specific hand position is required.
Above the center console	Defined poses	With defined poses a function is triggered depending on the application active.
Below the inside rearview mirror	Brief up and down movements	With brief vertical up and down movements below the inside rearview mirror the reading light for the driver or the front passenger is switched on and off.
Above the front passenger seat	Stretching out a hand above the front passenger seat	By stretching out a hand above the front passenger seat the search light is switched on. If you withdraw a hand from this area, the search light is switched off again.

Switching the reading light and search light and on or off

Requirements:

- **For the reading light:** the function is available when it is dark.
- The hand movement takes place in the interaction area below the inside rearview mirror.
- **For the search light:** the function is available when it is dark.
- The hand movement takes place in the interaction area above the front passenger seat.
- The seat belt on the front passenger seat must **not** be inserted in the seat belt buckle.

Switching the reading light on and off



- ▶ Briefly move a hand up or down beneath the inside rearview mirror. The reading light is switched on or off for the driver or the front passenger.

Switching the search light on and off



- ▶ **To switch on:** reach across the front passenger seat with a hand. The search light is switched on for the driver.
- ▶ **To switch off:** take a hand back away from the front passenger seat. The search light is switched off again.

Information on profiles, themes, suggestions and favourites

For electrically adjustable seats observe the following notes.

▲ WARNING Risk of becoming trapped during adjustment of the driver's seat after calling up a driver profile

Selecting a user profile may trigger an adjustment of the driver's seat to the position saved under the user profile. You or other vehicle occupants could be injured in the process.

▶ Make sure that when the position of driver's seat is being adjusted using the multimedia system, no people or body parts are in the seat's range of movement.

If there is a risk of someone becoming trapped, stop the adjustment process immediately:

▶ a) Tap the warning message on the media display.

or

▶ b) Press a memory position button or a seat adjustment switch on the driver's door.
The adjustment process will be stopped.

The driver's seat is equipped with an access preventer.

If the driver's door is open, the driver's seat will **not** be set after calling up the driver's profile.

Profiles store your vehicle settings and settings for the multimedia system. If the vehicle is used by several drivers, the driver can select their own profile without changing the stored profile settings of other drivers.

❗ Information on profiles from Mercedes me connect can be found in the Digital Operator's Manual.

Vehicle settings are, for example, driver's seat, steering wheel and mirror settings, climate control and ambient lighting. For the settings of the multimedia system, you can select, for example, radio stations, previous destinations as well as themes, suggestions and favourites.

For recurring driving situations, such as long drives on the freeway, you can save your preferred settings in a theme in the vehicle. In a theme you can save the display of the digital map, your preferred radio station and preferred drive program, for example.

The vehicle can learn the habits of the driver. It then offers suggestions for the most probable navigation destinations, media sources, radio stations or contacts. The pre-requirements for that are the selection of a profile, your consent to the recording of data and sufficient collected data.

Favourites provide quick access to applications that are used often. You can select favourites from categories or add them directly to an application.

Configuring profiles, themes and suggestions

Multimedia system:



Creating a new profile

- ▶ Select **Create Profile** .
- ▶ Select an avatar.
- ▶ Enter the name and confirm with .
- ▶ Select **Continue** .
- ▶ Select **Current Settings**.
- ▶ Select **Save**.
- ▶ Activate Bluetooth® and select **Connect Phone**, to connect a mobile phone with the user profile .
- ▶ Select **Finish**.

Selecting profile options

- ▶ Select for a profile.
- The following functions are available:
- Editing, resetting or deleting a profile
 - Resetting themes or favorites

- Configuring suggestions

Configuring suggestions

- ▶ Select for a profile.
- ▶ Select **Suggestion Settings**.
- ▶ Switch **Allow Destination Suggestions**, **Allow Music Suggestions** and **Allow Contact Suggestions** on or off.
- ▶ **To deactivate the learning function for one day:** activate **Deact. Learning for 24 h**. For 24 hours no new actions will be trained and no data recorded for the active profile. Suggestions will continue to be shown.

Example: if the option is switched on and a route to a new destination has been calculated, this destination would not be taken into account for the learning function.

Creating new themes

- ▶ Select .
- ▶ Select **THEMES**.
- ▶ Select **Create Theme**. The settings which are saved in the theme are shown.

- ▶ Select **Continue** .
- ▶ Select **Audio** and **Navigation** (Navigation) and store the active settings in the theme.
- ▶ Select **Continue** .
- ▶ Select an entry screen.
- ▶ Select **Continue** .
- ▶ Select an image.
- ▶ Enter the names into the entry field and confirm with .
- ▶ Select **Save**.

System settings

Overview of the system settings menu

In the system settings menu, you can make settings in the following menus and control elements:

- Display
 - Styles
 - Instrument lighting
 - Display brightness

- Edge lighting
- Day/night design
- Control elements
 - Keyboard language and handwriting recognition
 - Sensitivity of the touchpad
 - Sensitivity of the Touch Controls
- Voice Control System
- Sound
 - Entertainment
 - Navigation and traffic announcements
 - Telephone
 - Voice amplification to the rear compartment
- Connectivity
 - Wi-Fi, Bluetooth®, NFC
- MBUX Remote Control
 - Authorizing and deauthorizing devices
- Time & date
- Language

- Units for distance
- Software updates
- Data import/export
- PIN protection
- System Reset

Information on important system updates

Important system updates may be necessary for the security of your multimedia system's data. Install these updates, or else the security of your multimedia system cannot be ensured.

A system update consists of three steps:

- Downloading or copying of the data required for installation
 - Installation of the downloaded system update
 - Activation of the downloaded system update by restarting the system
- i** If automatic software updates are activated, the system updates will be downloaded automatically.

The multimedia system provides a message when a system update is available.

You have the following selection options:

- **Accept and Install**

The system update will be downloaded in the background.

- **Information**

Information about the pending system update is displayed.

- **Later**

The system update can be downloaded manually at a later time.

Deep system updates

Deep system updates access vehicle or system settings and can therefore only be carried out when the vehicle is stationary and the ignition is switched off.

If the download of a deep system update is completed and the downloaded system update is ready for installation, you will be informed of this after the next ignition cycle, for example.

- ⓘ Park the vehicle safely in a suitable location before starting the installation.

Requirements for the installation:

- The ignition is switched off.
- Notes and warnings have been read and accepted.
- The electric parking brake is applied.

If all requirements have been fulfilled, the downloaded system update is installed. The multimedia system cannot be operated while the downloaded system update is being installed and vehicle functions are restricted.

If errors should occur during the installation, the multimedia system automatically attempts to restore the previous version. If restoration of the previous version is not possible, a symbol appears on the media display. Consult a qualified specialist workshop to resolve the problem.

Setting up a Wi-Fi hotspot

Requirements:

- **To set up the Wi-Fi connection of the multimedia system with external hotspots:** there is no communication module installed.
- The device to be connected supports at least one of the types of connection described.

Multimedia system:

→  ► Settings ► System
►► Wi-Fi & Bluetooth

Activating/deactivating Wi-Fi

- Select **Wi-Fi**.



Connecting the multimedia system with an external hotspot using Wi-Fi

The type of connection established must be selected on the multimedia system and on the device to be connected.

- ⓘ The connection procedure may differ depending on the device. Follow the instructions that are shown in the display. Further information can be found in the manufacturer's operating instructions.

- Select **Internet Settings**.
- Select **Connect via Wi-Fi**.
- Select **Add Hotspot**.

Connecting using a security key

- Select the options  of the desired Wi-Fi network.
- Select **Connect Using Security Key**.
- Have the security key displayed on the device to be connected (see the manufacturer's operating instructions).
- Enter this security key on the multimedia system.
- Confirm the entry with .

Connecting using a WPS PIN

- Select the options  of the desired Wi-Fi network.
- Select **Connect via WPS PIN Input**. The multimedia system generates an eight-digit PIN.
- Enter this PIN on the device to be connected.
- Confirm the entry.

Connecting using a button

- ▶ Select the options  of the desired Wi-Fi network.
- ▶ Select [Connect via WPS PBC](#).
- ▶ Select "Connect via WPS PBC" in the options on the device to be connected (see the manufacturer's operating instructions).
- ▶ Press the WPS button on the device to be connected.
- ▶ Select [Continue](#) in the multimedia system.

Activating automatic connection

- ▶ Select [Connect via Wi-Fi](#).
- ▶ Select the options  of the desired Wi-Fi network.
- ▶ Activate [Permanent Internet Connection](#).

Connecting with a known Wi-Fi

- ▶ Select [Connect via Wi-Fi](#).
- ▶ Select a Wi-Fi network.
The connection is established again.

Configuring the multimedia system as a Wi-Fi hotspot for external devices

The type of connection established depends on the device to be connected. The function must be supported by the multimedia system and by the device to be connected. The type of connection established must be selected on the multimedia system and on the device to be connected.

- ▶ Select [Vehicle Hotspot](#).
- ▶ Select [Connect Device to Vehicle Hotspot](#).

Connecting using WPS PIN generation

- ▶ Select [Connect via WPS PIN Generation](#).
- ▶ Enter the PIN shown in the media display on the device to be connected and confirm.

Connecting using WPS PIN entry

- ▶ Select [Connect via WPS PIN Input](#).
- ▶ Enter the PIN that is shown on the external device's display on the multimedia system.

Connecting using a button

- ▶ Select [Connect via WPS PBC](#).

- ▶ Press the push button on the device to be connected (see the manufacturer's operating instructions).
- ▶ Select [Continue](#).

Connecting using a security key

- ▶ Select [Connect Device to Vehicle Hotspot](#).
A security key is displayed.
- ▶ Select the vehicle from the device to be connected. The vehicle is displayed with the [DIRECT-MBUX XXXXX](#) network name.
- ▶ Enter the security key which is shown in the media display on the device to be connected.
- ▶ Confirm the entry.

Connecting using NFC

- ▶ Select [Connect via NFC](#).
- ▶ Activate NFC on the mobile device (see the manufacturer's operating instructions).
- ▶ Hold the device to be connected at the vehicle's NFC interface.
- ▶ Select [Finished](#).
The mobile device is now connected to the multimedia system hotspot via NFC.

Generating a new security key

- ▶ Select **Vehicle Hotspot**.
- ▶ Select **Generate Security Key**.
A connection will be established with the newly created security key.
- ▶ **To save a security key:** select **Save**.
When a new security key is saved, all existing Wi-Fi connections are then disconnected. If the Wi-Fi connections are being re-established, the new security key must be entered.

Navigation

Notes on navigation

Route guidance with augmented reality

⚠ WARNING Risk of accident and injury as a result of distraction, incorrect depiction or wrong interpretation of the display

The camera image of the augmented reality display is not suitable as a guide for driving.

- ▶ Always keep an eye on the actual traffic situation.
- ▶ Avoid extended observation of the camera image.

⚠ WARNING Risk of accident and injury due to imprecise positioning of additional information

The additional information from the augmented reality display is not a substitute for observing the actual driving situation.

- ▶ Always keep an eye on the actual traffic situation when carrying out all driving maneuvers.

The navigation menu is hidden if route guidance is active.

- ▶ **To show:** tap on the touchscreen.
The menu is hidden automatically.

Switching navigation on

Multimedia system:

➔  ➔ **Navigation** (Navigation)

- ▶ Alternatively: press the  button.
The map shows the vehicle's current position. The navigation menu is shown.

Navigation overview

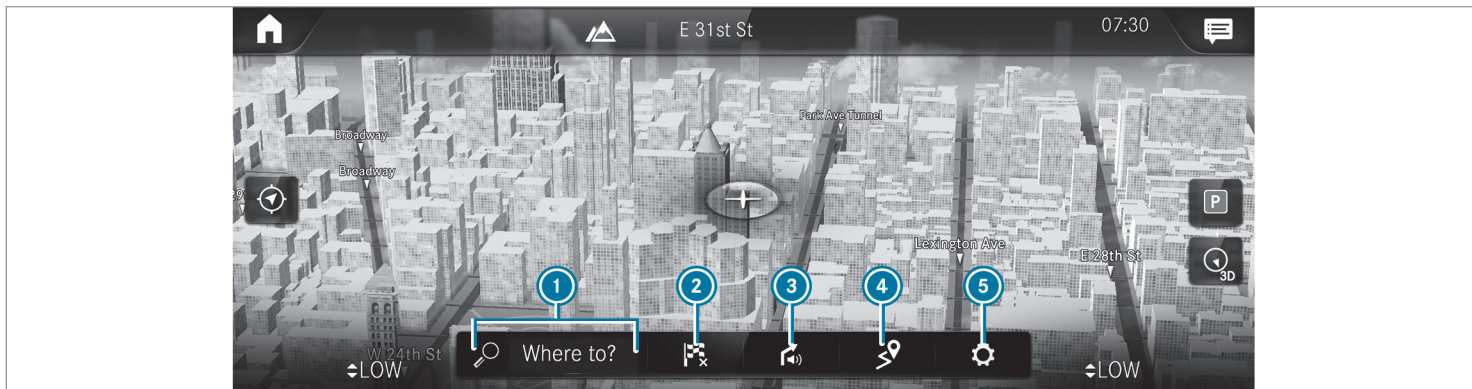

Example: digital map with navigation menu

- ① To enter a POI or address and additional destination entry options
- ② To cancel active route guidance
- ③ To repeat a navigation announcement and switch navigation announcements on or off

- ④ **ON THE WAY** menu with **Route Overview**, **Alternative Routes** and **Report Traffic Incident (Car-to-X)**
TRAFFIC menu with **Traffic Announcements**, **Area Alerts** and **Live Traffic Subscription Info**
To display **Route List**

POSITION menu with **Save Position** and **Compass**

- ⑤ Quick access for **Traffic**, **Parking** and **Highway Information** as well as options for **View**, **Announcements** and **Route via Advanced**

Entering a destination

Multimedia system:

→ Home → Navigation → Where to?

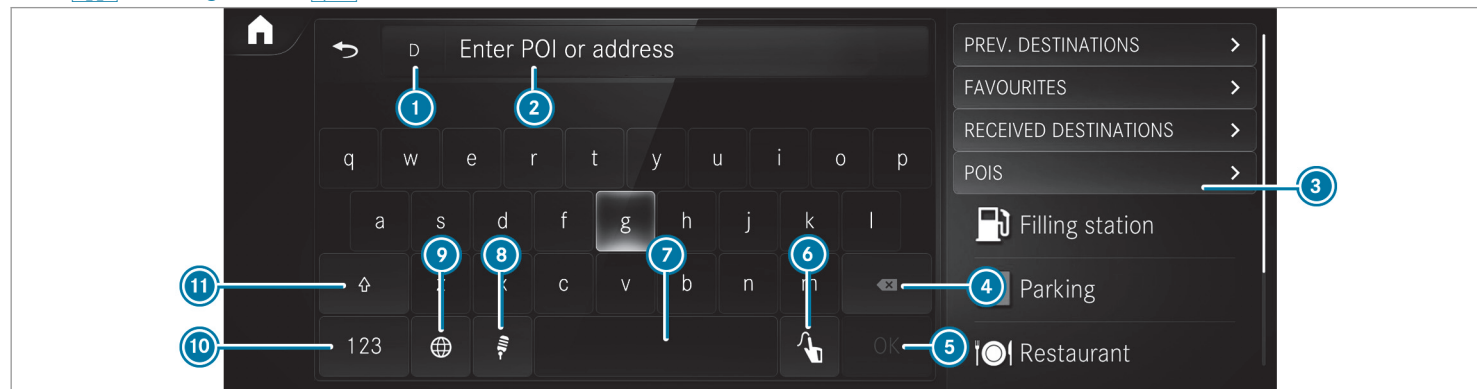

- ① The federal state or province in which the vehicle is located
- ② Entering a POI or address
- ③ List with additional destination entry options
- ④ Deletes an entry
- ⑤ **OK** Confirms an entry
- ⑥ Switches to handwriting recognition
- ⑦ Enters a space
- ⑧ Switches to voice input
- ⑨ Sets the written language
- ⑩ Switches to digits, special characters and symbols
- ⑪ Switches to upper-case or lower-case letters

- ▶ Enter the destination in ②. The entries can be made in any order.

The following entries can be made, for example:

- City, street, house number
- Street, city
- ZIP code
- POI name or POI category, e.g. [Parking](#)
- Contact name

- ▶ Select a search result in list ③.

- ▶ Calculate the route (→ page 237).

- ① You can find further information about destination entry, e.g. 3 word addresses, in the Digital Operator's Manual.

Changing country

- ▶ Select the indicator for federal state or province ①.
- ▶ Select the federal state or the province in ①.
- ▶ Enter the country indicator.
- ▶ Select the country on list ③.

- ▶ Select the federal state or the province from list ③.

Using online search

Destination entry uses online map services. If the on-board search finds no suitable destinations or if you change countries, the online search is available.

For the destination you can enter an address, a POI or a 3 word address.

- ▶ Select country indicator ①.
- ▶ Select the provider for the online service from the countries list.

or

- ▶ If the on-board search delivers no results, enter the destination in input line ②.
- ▶ Select the destination in the list. The detailed view for the route is displayed.

Calculating a route and using settings for route guidance

Requirements:



- The destination has been entered.

- The destination address is shown.

Multimedia system:

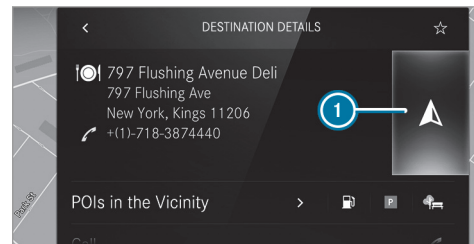
→  ▶ [Navigation](#)



- ①  No route yet.
-  A route has been mapped.

- ▶ Select . The route to the destination is calculated. Route guidance begins.

or



- ▶ Select .

- ▶ Select **Set as Waypoint**.
The destination address is set as the next intermediate destination.

or

- ▶ Select **Start New Route Guidance**.
The destination address is set as the new destination. The previous destination and the intermediate destinations are deleted. Route guidance to the new destination begins.

Selecting route settings

- ▶ Select .
- ▶ Select **Advanced**.
- ▶ Select **Route**.
- ▶ Select the route type.
- ▶ Take traffic information into consideration with **Dynamic Route Guidance** .
- ▶ Select route options with **Avoid Options**.
- ▶ Activate **Suggest Alternative Route**.
Alternative routes are calculated for every route.

- ▶ Activate **Activate Commuter Route**.
If the requirements are met, the multimedia system automatically detects that the vehicle is on a commuter route. Route guidance begins without voice output.

Activating route guidance with augmented reality

- ▶ During route guidance, tap on the camera symbol on the media display.
The camera image will be shown instead of the navigation map before a turning maneuver and will show additional information.
- ▶ **To return to the navigation map:** tap on the camera symbol again.

Displaying additional information in the camera image

- ▶ Select .
- ▶ Select **Advanced**.
- ▶ Select **Augmented Reality**.
- ▶ Activate **Street Names** and **House Numbers**.
During route guidance, street names and house numbers are shown in the camera image.

Using map functions

Multimedia system:

  **▶▶ Navigation**

Setting the map scale

- ▶ **To zoom in:** tap twice quickly with one finger on the media display.
- ▶ **To zoom out:** tap with two fingers on the media display.

Moving the map

- ▶ Move one finger in any direction on the touchscreen.
- ▶ **To reset the map to the current vehicle position:** press  briefly.

Selecting map orientation

- ▶ Tap repeatedly on the  compass symbol on the map.
The view changes in the sequence **3D**, **2D Heading Up** to **2D North Up**.

Switching freeway information on/off

- ▶ Select .

- ▶ Switch [Highway Information](#) on or off.

Using services

Requirements:

- There is an Internet connection.
- Mercedes me connect is available.
- You have set up a user account in the Mercedes me Portal.
- The vehicle is connected to a user account and you have accepted the conditions of use for the service.
Further information can be found at:
<https://www.mercedes.me>
- The service is available.
- The service has been activated at an authorized Mercedes-Benz Center.

Multimedia system:

▶  ▶▶ [Navigation](#)

Displaying the traffic situation with Live Traffic Information

- ▶ Select .

- ▶ Activate [Traffic](#).
- ▶ Select [Advanced](#).
- ▶ Select [View](#).
- ▶ Select [Map Elements](#).
- ▶ Switch on [Traffic Incidents](#), [Free Flowing Traffic](#) and [Delay](#).
If traffic information has been received, then traffic incidents such as roadworks, road blocks, local area reports (e.g. fog) and warning messages are displayed.
The traffic delay is displayed for the current route. Traffic delays lasting one minute or longer are taken into consideration.

Displaying hazard warnings with Car-to-X-Communication

If hazard warnings are available these can be shown as symbols on the map. The display depends on the settings for the [Traffic](#) and [Traffic Incidents](#) options.

- ▶ Set the options.
If [Traffic](#) is switched off and [Traffic Incidents](#) is switched on, the symbols are shown on the prospective route.

Displaying weather information and other map contents

- ▶ Select .
- ▶ Select [Advanced](#).
- ▶ Select [View](#).
- ▶ Select [Map Elements](#).
- ▶ Scroll up and show the [ONLINE MAP CONTENT](#) category.
- ▶ Switch on a service, e.g. [Weather](#).
Current weather information is displayed on the navigation map, e.g. temperature or cloud cover.

Telephone

Telephony

Notes on telephony

⚠ WARNING Risk of distraction from operating integrated communication equipment while the vehicle is in motion

If you operate communication equipment integrated in the vehicle when driving, you could be distracted from the traffic situation. This could also cause you to lose control of the vehicle.

- ▶ Only operate this equipment when the traffic situation permits.
- ▶ If you cannot be sure of this, stop the vehicle whilst paying attention to road and traffic conditions and operate the equipment with the vehicle stationary.

⚠ WARNING Risk of an accident from operating mobile communication equipment while the vehicle is in motion

Mobile communications devices distract the driver from the traffic situation. This could also cause the driver to lose control of the vehicle.

- ▶ As the driver, only operate mobile communications devices when the vehicle is stationary.
- ▶ As a vehicle occupant, only use mobile communications devices in the areas intended for this purpose, e.g. in the rear passenger compartment.

You must observe the legal requirements for the country in which you are currently driving when operating mobile communication equipment in the vehicle.

⚠ WARNING Risk of injury due to objects being stowed incorrectly

If objects in the vehicle interior are stowed incorrectly, they can slide or be thrown around and hit vehicle occupants. In addition, cup holders, open stowage spaces and mobile phone receptacles cannot always retain all objects within.

There is a risk of injury, particularly in the event of sudden braking or a sudden change in direction.

- ▶ Always stow objects so that they cannot be thrown around in such situations.
- ▶ Always make sure that objects do not protrude from stowage spaces, parcel nets or stowage nets.
- ▶ Close the lockable stowage spaces before starting a journey.
- ▶ Always stow and secure heavy, hard, pointed, sharp-edged, fragile or bulky objects in the trunk/cargo compartment.

Observe the additional information on stowing mobile communications devices correctly:

- Loading the vehicle (→ page 100)

Bluetooth® connection:

The menu view and the available functions in the telephone menu are in part dependent on the Bluetooth® profile of the connected mobile phone. Full functionality is only available if the mobile phone supports both of the following Bluetooth® profiles:

- PBAP (Phone Book Access Profile)
 - The contacts on the mobile phone are shown automatically on the multimedia system.
- MAP (Message Access Profile)
 - The mobile phone message functions can be used on the multimedia system.

Irrespective of this, Bluetooth® audio functionality can be used with any mobile radio unit.

For information on the range of functions of the mobile radio unit to be connected, see the manufacturer's operating instructions.

Network connection:

The following cases can lead to the call being disconnected while the vehicle is in motion:

- You switch into a transmission/reception station, in which no communication channel is free.
- The SIM card used is not compatible with the network available
- A mobile phone with "Twincard" is logged into the network with the second SIM card at the same time

The multimedia system supports calls in HD Voice® for improved speech quality. A requirement for this is that the mobile phone and the mobile phone network provider of the person you are calling support HD Voice®.

Depending on the quality of the connection, the voice quality may fluctuate.

Further information can be obtained from an authorized Mercedes-Benz Center or at:
<https://www.mercedes-benz.com/connect>

Telephone menu overview

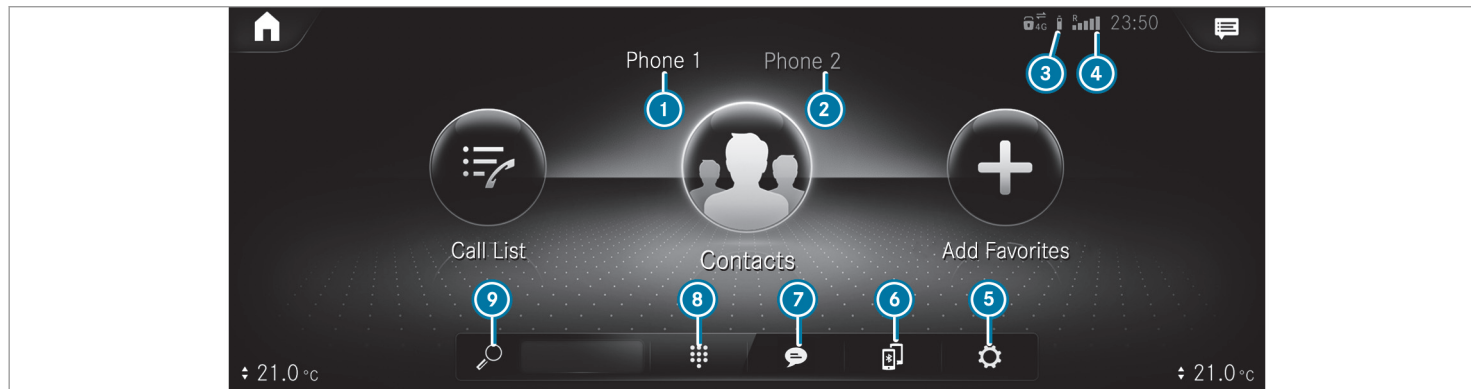

- ❶ Bluetooth® device name of the currently connected mobile phone/of the mobile phone
- ❷ Bluetooth® device name of the currently connected mobile phone/of the mobile phone (two phone mode)
- ❸ Battery status of the connected mobile phone

- ❹ Signal strength of the mobile phone network
- ❺ Options
- ❻ Device manager
- ❼ Messages
- ❽ Numerical pad
- ❾ Contact search

Telephony operating modes overview

Depending on your equipment, the following telephony operating modes are available:

- A mobile phone is connected to the multimedia system via Bluetooth®.

- Two mobile phones are connected with the multimedia system via Bluetooth® (two phone mode).
 - You can use all the functions of the multimedia system with the mobile phone in the foreground.
 - You can receive incoming calls and messages with the mobile phone in the background.

You can interchange the mobile phone in the foreground and background.

Connecting a mobile phone

Requirements:

- Bluetooth® is activated on the mobile phone (see the manufacturer's operating instructions).
- Bluetooth® is activated on the multimedia system.

Multimedia system:



Searching for a mobile phone

- ▶ Select .
- ▶ Select [Connect New Device](#).



Connecting a mobile phone

Authorization follows using secure simple pairing.

- ▶ Select a mobile phone.
A code is displayed in the multimedia system and on the mobile phone.
- ▶ If both codes match, confirm the code on the mobile phone.

Functions in the telephony menu

In the telephony menu you have the following functions, for example:

- Making calls, e.g.:
 -  Accept a call
 -  [End Call](#)
 -  [Create Confer. Call](#)

- Accepting or rejecting a waiting call
- Managing contacts, e.g.:
 - Downloading mobile phone contacts
 - Managing the format of a contact's name
 - Saving a contact as a favorite
- Receiving and sending messages, e.g.:
 - Using the read-aloud function
 - Dictating a new message

Mercedes me and apps

Mercedes me connect

Information on Mercedes me connect

Mercedes me connect consists of multiple services.

You can use the following services via the multimedia system and the overhead control panel, for example:

- Accident and Breakdown Management (me button or situation-dependent display in the multimedia system)

- Mercedes-Benz emergency call system (automatic emergency call and SOS button)

The Mercedes me connect Accident and Breakdown Management and the Mercedes-Benz emergency call center are available to you around the clock.

The me button and the SOS button can be found on the vehicle's overhead control panel (→ page 245).

You can also call the Mercedes-Benz Customer Center using the multimedia system (→ page 246).

Please note that Mercedes me connect is a Mercedes-Benz service. In emergencies, first call the national emergency services using the standard national emergency service telephone numbers. In emergencies, you can also use the Mercedes-Benz emergency call system (→ page 252).

Observe the conditions of use for Mercedes me connect and other services. These can be obtained in the Mercedes me Portal: <https://me.secure.mercedes-benz.com>

Further information about Mercedes me connect services can be obtained in the Mercedes me Portal: <https://me.secure.mercedes-benz.com>

Information on Mercedes me connect Accident and Breakdown Management

The Accident and Breakdown Management can include the following functions:

- Supplement to the Mercedes-Benz emergency call system (→ page 252)
If necessary, the contact person at the Mercedes-Benz emergency call center forwards the call to Mercedes me connect Accident and Breakdown Management. Forwarding the call is however not possible in all countries.
- Breakdown assistance by a technician on location and/or the towing away of the vehicle to the nearest authorized Mercedes-Benz Center
You may be charged for these services.
- Addition to the emergency guide after automatic accident or breakdown detection (→ page 246)

In the event of a breakdown or accident, further vehicle data is sent which enables optimal support by the Mercedes-Benz Customer Center and the authorized service partner or breakdown assistance.

- Addition to the Mercedes me connect service Telediagnosics

With the Telediagnosics function, specific wear and failure reports are recorded by the service provider, in so far as these can be clearly interpreted and are available through the monitoring of components that are subject to diagnostics.

If your vehicle detects a breakdown or threat of a breakdown, you may be prompted via the multimedia system to contact the Mercedes-Benz Customer Center for further help. This prompt in the multimedia system only appears when the vehicle is stationary.

ⓘ These services are subject to technical restrictions such as the mobile phone coverage, mobile network quality and the ability of the processing systems to interpret the transferred data. In some circumstances, this can result in delays or the failure of the information to appear in the multimedia system.

More information about Mercedes me connect services can be obtained in the Mercedes me Portal: <https://me.secure.mercedes-benz.com>

Data transferred during Mercedes me connect call services

The data transferred during a Mercedes me connect call depends on:

- The reason for initiation of the call
- The service that is selected in the voice control system
- The activated Mercedes me connect services

You can find out which data is transferred when using the services in the currently valid Mercedes me connect terms of use and the data protection information for Mercedes me con-

nect. You can find these in your Mercedes me user account.

Mercedes me calls

Making a call via the overhead control panel

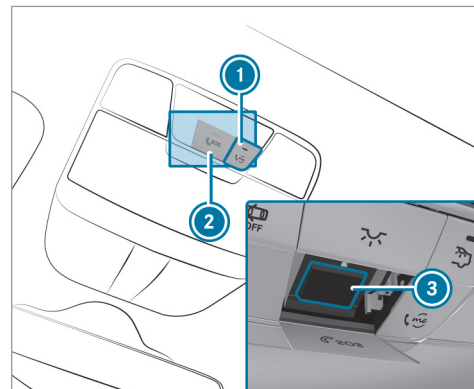



- ① me button for service or information calls
- ② SOS button cover
- ③ SOS button (emergency call system)

Making a Mercedes me call

- ▶ Press me button ①.

Making an emergency call

- ▶ To open the cover of SOS button , press it briefly.
- ▶ Press and hold SOS button  for at least one second.

If a Mercedes me call is active, an emergency call can still be triggered. This has priority over all other active calls.

Information about the Mercedes me call using the me button

A call to the Mercedes-Benz Customer Center has been initiated via the me button in the overhead control panel or the multimedia system (→ page 245).

Using the voice dialog system you access the desired service:

- Accident and Breakdown Management
- Mercedes-Benz Customer Center for general information about the vehicle

You can find information on the following topics:

- Activation of Mercedes me connect
- Operating the vehicle

- Nearest authorized Mercedes-Benz Center
- Other products and services from Mercedes-Benz

Data is transferred during the connection to the Mercedes-Benz Customer Center (→ page 247).

Calling the Mercedes-Benz Customer Center using the multimedia system

Requirements:

- Access to a GSM network is available.
- The contract partner's GSM network coverage is available in the respective region.
- The ignition must be switched on so that vehicle data can be transferred automatically.

Multimedia system:



- ▶ Call [Mercedes me connect](#). After confirmation, the multimedia system sends the required vehicle data. The data transfer is shown in the media display.

Then, you can select a service and be connected to a specialist at the Mercedes-Benz Customer Center.

Calling the Mercedes-Benz Customer Center after automatic accident or breakdown detection

Requirements:

- The vehicle has detected an accident or breakdown situation.
- The vehicle is stationary.
- The hazard warning lights are switched on.

 This function is not available in all countries. The vehicle can detect accident or breakdown situations under certain circumstances.

In the event an accident or breakdown is detected, the emergency guide shows safety notes in the multimedia system display.

After quitting the emergency guide display on the multimedia system, a prompt appears asking whether you would like to get support from the Mercedes-Benz Customer Center.

▶ Select **Call**.

- After your agreement, or if the Mercedes me connect service "Accident and Breakdown Management" is active, the vehicle data is transferred automatically (→ page 244).
- The Mercedes-Benz Customer Center takes your call and organizes the breakdown and accident assistance.

You may be charged for these services.

- ⓘ Depending on the severity of the accident, an automatic emergency call can be initiated. This has priority over all other active calls.
- ⓘ In addition, if the Mercedes me connect service "Telediagnosics" is active, a similar prompt can appear after a delay in the event of a breakdown. If you are already in contact with the Mercedes-Benz Customer Center or have already received support, this prompt can be ignored or declined.
- ⓘ If you answer the prompt for support from the Mercedes-Benz Customer Center with

Later, the message will be hidden and appear again later.

The prompt triggered by the Mercedes me connect service "Telediagnosics", can either be confirmed or declined. After being declined, this will not be shown again.

Arranging a service appointment via a Mercedes me call

If you have activated the maintenance management service, relevant vehicle data is transferred automatically to the Mercedes-Benz Customer Center. You will then receive individual recommendations regarding the maintenance of your vehicle.

Regardless of whether you have consented to the maintenance management service, the multimedia system reminds you after a certain amount of time that a service is due. A prompt appears asking if you would like to make an appointment.

▶ **To arrange a service appointment:** select **Call**.

After your agreement, the vehicle data is transferred and the Mercedes-Benz Customer

Center takes your preferred appointment date. The information is then sent to your desired service outlet.

This will contact you to confirm the appointment and if necessary consult about the details.

- ⓘ If you select **Later** after the service message appears, the message is hidden and reappears at a later time.

Transferred data during a Mercedes me call

When you make a service call via Mercedes me, data is transmitted. This enables targeted advice and a smooth service.

The following requirements must be fulfilled for the transfer of the data:

- The ignition is switched on.
- The required data transfer technology is supported by the mobile phone network provider.
- The quality of the mobile connection is sufficient.

Multi-stage transfer depends on the following factors:

- Reason for the initiation of the call
- The available mobile phone transmission technology.
- The activated Mercedes me connect services.
- The service selected in the voice control system.

Data transfer if Mercedes me connect services are not activated

If no Mercedes me connect services are activated, the following data is transferred:

- Vehicle identification number
- Time of the call
- Reason for the initiation of the call
- Country indicator of the vehicle
- Set language for the multimedia system
- Telephone number of the communication platform installed in the vehicle

If a call is made for a service appointment via the service reminder, the following data is also transmitted:

- Current mileage and maintenance data

If a call is made after automatic accident or breakdown detection using the multimedia system, the following data is also transmitted:

- Current mileage and maintenance data
- Current vehicle location

If Accident and Breakdown Management is called via the voice control system, the following data can also be called up from the vehicle by the Mercedes-Benz Customer Center:

- Current vehicle location

Data transfer if Mercedes me connect services are activated

Only if the respective service is activated will additional incident-specific data be transmitted in the second stage to enable an optimal service.

An overview of the data transmitted can be found in the respective terms of use for

Mercedes me connect services. These can be obtained in the Mercedes me portal: <https://me.secure.mercedes-benz.com>

Data processing

The data transmitted within the scope of the call is deleted from the processing system after the call is finished, in so far as this data is not being used for other activated Mercedes me connect services.

The incident-specific data is processed and stored in the Mercedes-Benz Customer Center and, if required to process the incident, forwarded to the service partner authorized by the Mercedes-Benz Customer Center. Please take note of the data protection information on the Mercedes me Internet page <https://www.mercedes.me> or in the recorded message immediately after calling the Mercedes-Benz Customer Center.

- ❗ The recorded message is not available in every country.

Overview of the Mercedes me & Apps menu

When you log in with a user account to the Mercedes me Portal, then services and offers from Mercedes-Benz will be available to you.

For more information consult an authorized Mercedes-Benz Center or visit the Mercedes me portal: <https://me.secure.mercedes-benz.com>

- ① Make sure you always keep the Mercedes me apps updated.

You can call up the menu using **Mercedes me & Apps** in the multimedia system.

In the **Mercedes me & Apps** menu, the following options can be available:

- Connecting the vehicle with the **Mercedes me** user account
- Deleting a connection between a **Mercedes me** user account and the vehicle

- Calling up the Mercedes me services
- Calling up apps such as, In-Car Office or the web browser depending on availability

Web browser overview

The web browser is started using the **Mercedes me & Apps** menu.

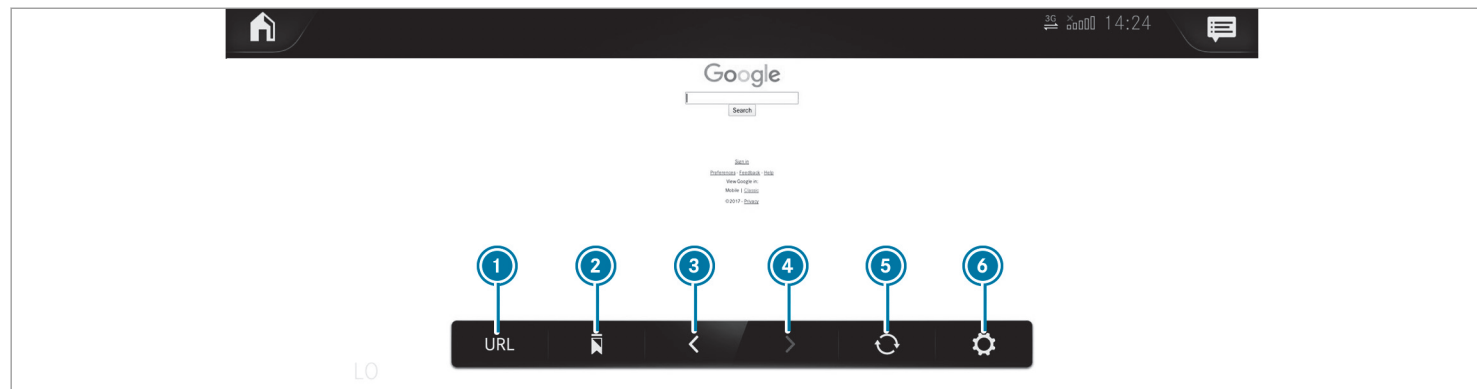

- ① URL entry
- ② Bookmarks
- ③ Web page, back
- ④ Web page, forwards
- ⑤ To refresh/stop
- ⑥ Options
- ⓘ Websites cannot be shown while the vehicle is in motion.

Overview of smartphone integration

With Smartphone Integration, you can use certain functions on your mobile phone via the multimedia system display.

Only one mobile phone at a time can be connected via Smartphone Integration to the multimedia system. Also for use with two phone mode with smartphone integration, only one additional

mobile phone can be connected using Bluetooth® with the multimedia system.

The full range of functions for Smartphone Integration is only possible with an Internet connection. The appropriate application must be downloaded on the mobile phone to use Smartphone Integration. The mobile phone must be switched on and connected to a USB port with the  symbol on the multimedia system using a suitable cable.

Apps for Smartphone Integration

- Mercedes-Benz Link (implementation of the function using the Mercedes-Benz Link control box)
- Apple CarPlay®
- Android Auto

You can start Smartphone Integration using the [Mercedes me & Apps](#) menu.

You can end Smartphone Integration by disconnecting the connecting cable between the mobile phone and multimedia system.

i Mercedes-Benz recommends disconnecting the connecting cable only when the vehicle is stationary.

Overview of transferred vehicle data

When using Smartphone Integration, certain vehicle data is transferred to the mobile phone. This enables you to get the best out of selected mobile phone services. Vehicle data is not directly accessible.

The following system information is transmitted:

- Software release of the multimedia system

- System ID (anonymized)

The transfer of this data is used to alter how content is displayed to correspond to the driving situation.

The following position data is transmitted:

- Coordinates
- Speed
- Compass direction
- Acceleration direction

This data is used by the mobile phone to improve the accuracy of the navigation (e.g. for continuation in a tunnel).

Mercedes-Benz emergency call system

Information on the Mercedes-Benz emergency call system

Your vehicle is equipped with the Mercedes-Benz emergency call system ("eCall"). This feature can help save lives in the event of an accident. eCall in no way replaces assistance provided from dialing 911.

Mercedes-Benz eCall only functions in areas where mobile phone coverage is available from the wireless service providers. Insufficient network coverage from the wireless service providers may result in an emergency call not being transmitted.

eCall is a standard feature in your Mercedes-Benz vehicle. In order to function as intended, the system relies on the transmission of data detailed in the Transmitted Data section that follows (→ page 253).

To disable eCall, a customer must visit an authorized Mercedes-Benz Service department to deactivate the vehicle's communication module.

Deactivation of this module prevents the activation of any and all Mercedes me connect services. After the deactivation of eCall, automatic emergency call and manual emergency call will not be available.

The ignition must be switched on before an automatic emergency call can be made.

i eCall is activated at the factory.

- ❶ eCall can be deactivated by an authorized Mercedes-Benz dealer. Please note that in the event ownership of the vehicle is transferred to another owner in its deactivated state, eCall will remain deactivated unless the new owner visits an authorized Mercedes-Benz dealership to reactivate the system.

Overview of the Mercedes-Benz emergency call system

eCall can help to reduce the time between an accident and the arrival of emergency services at the site of the accident. It helps locate an accident site in places that are difficult to access. However, even if a vehicle is equipped with eCall, this does not mean the system is ON. As such, eCall does not replace dialing 911 in the event of an accident.

An emergency call can be made automatically (→ page 252) or manually (→ page 253) Only make emergency calls if you or others are in need of rescue.

Only make emergency calls if you or others are in need of rescue. Do not make an emergency call in the event of a breakdown or a similar situation.

Messages on the display

SOS NOT READY: the ignition is not on or eCall not available.

During an active emergency call,  appears in the display.

You can find more information on the regional availability of eCall at: <https://www.mercedes-benz-mobile.com/extra/ecall/>

- ❶ If there is a malfunction in the Mercedes-Benz emergency call system (e.g. a fault with the speaker, microphone, airbag, SOS button), a corresponding message appears in the multifunction display of the instrument cluster.

Triggering an automatic Mercedes-Benz emergency call

Requirements:

- The ignition is switched on.

- The starter battery is sufficiently charged.

The Mercedes-Benz emergency call system triggers an emergency call automatically in the following cases:

- After activation of the restraint systems such as airbags or Emergency Tensioning Devices after an accident
- After an automatically initiated emergency stop by Active Emergency Stop Assist

The emergency call has been made:

- A voice connection is made to the Mercedes-Benz emergency call center.
- A message with accident data is transmitted to the Mercedes-Benz emergency call center. The Mercedes-Benz emergency call center can transmit the vehicle position data to one of the emergency call centers.

The SOS button in the overhead control panel flashes until the emergency call is finished.

It is not possible to immediately end an automatic emergency call.

If no connection can be made to the emergency services either, a corresponding message appears in the media display.

- ▶ Dial the local emergency number on your mobile phone.

If an emergency call has been initiated:

- Remain in the vehicle if the road and traffic conditions permit you to do so until a voice connection is established with the emergency call center operator.
- Based on the call, the operator decides whether it is necessary to call rescue teams and/or the police to the accident site.
- If no vehicle occupant answers, an ambulance is sent to the vehicle immediately.

Triggering a manual Mercedes-Benz emergency call

- ▶ **To use the SOS button in the overhead control panel:** press and hold the SOS button for at least one second (→ page 245).
- ▶ **To use voice control:** use the Voice Control System voice commands .

The emergency call has been made:

- A voice connection is made to the Mercedes-Benz emergency call center.
- A message with accident data is transmitted to the Mercedes-Benz emergency call center.

The Mercedes-Benz emergency call center can transmit the vehicle position data to one of the emergency call centers.

- Remain in the vehicle if the road and traffic conditions permit you to do so until a voice connection is established with the emergency call center operator.
- Based on the call, the operator decides whether it is necessary to call rescue teams and/or the police to the accident site.

If no connection can be made to the emergency services either, a corresponding message appears in the media display.

- ▶ Dial the local emergency number on your mobile phone.

Ending an unintentionally triggered manual Mercedes-Benz emergency call

- ▶ **Select**  on the multifunction steering wheel. Depress the button for several seconds.

Data transfer of the Mercedes-Benz emergency call system

In the event of an automatic or manual emergency call the following data is transmitted, for example:

- Vehicle's GPS position data
- GPS position data on the route (a few hundred meters)before the incident)
- Direction of travel
- Vehicle identification number
- Vehicle drive type
- Number of people determined to be in the vehicle
- Whether Mercedes me connect is available or not

254 MBUX multimedia system

- Whether the emergency call was initiated manually or automatically
- Time of the accident
- Language setting on the multimedia system

Data transmitted is vehicle information. For any questions about the collection, use and sharing of the eCall system data, please contact MBUSA's Customer Assistance Center at 800-FORMERC.

For Canada, please contact MBC's Customer Assistance Center at 1-800-387-0100.









Customer requests for covered information should be submitted via the same channels.





For accident clarification purposes, the following measures can be taken up to an hour after the emergency call has been initiated:

- The current vehicle position can be determined.
- A voice connection to the vehicle occupants can be established.

Radio & media

Overview of the symbols and functions in the media menu

Symbol	Designation	Function
	Play	Select to start or continue playback.
	Rest	Select to pause the playback.
	Repeat a track	Select to repeat the current track or the active playlist. <ul style="list-style-type: none"> • Select once: the active playlist is repeated. • Select twice: the current track is repeated. • Select three times: the function is deactivated.
	Random playback	Select to play back the tracks in random order.
	Skip forwards/back	Select to skip to the next or to the previous track.
	Options	Select to show additional options.
	Categories	Select to show or search through available categories (e.g. playback lists, albums, artists, etc.).
	Search	Select to search in the active menu. You can search for artists, genres or moods, for example.

Symbol	Designation	Function
	Settings	Select to make settings.
	Home	Select to return to the home screen.
	Messaging	Select to call up messaging.
	Full screen	Select to switch to full screen mode.

The following functions and settings are available in the media menu:

- Connecting external data storage media with the multimedia system (e.g. using USB or Bluetooth®)
- Playing back audio or video files

Authorizing a Bluetooth® audio device for media playback

Requirements:

- Bluetooth® is activated on the multimedia system and audio equipment.

- The audio equipment supports the Bluetooth® audio profiles A2DP and AVRCP.
- The audio equipment is "visible" for other devices.

Multimedia system:



With Bluetooth® audio, you can play back music files from an external data storage medium, e.g. your smartphone, using the MBUX multimedia system.

- ▶ To play back audio files using the multimedia system, authorize the external data storage medium on the MBUX multimedia system.





Authorizing a new Bluetooth® audio device





- ▶ Select **Connect New Device**.
- ▶ Select an audio device. Authorization starts. A code is displayed on the multimedia system and on the mobile phone.
- ▶ If the codes are identical, confirm on the audio equipment.
- ▶ Select **Only as Bluetooth Audio Device**. The Bluetooth® audio equipment is connected with the multimedia system.

Connecting previously authorized Bluetooth® audio equipment

- ▶ Select a Bluetooth® audio device from the list.
The connection is being established.





Overview of the symbols and functions in the radio menu

Symbol	Designation	Function
	Home	Select to return to the home screen.
	Messaging	Select to call up messaging.
	Skip forwards/back	Select to skip to the next or to the previous station.
	Settings	Select to have further options shown. Settings can be made to the following additional functions, for example: <ul style="list-style-type: none"> • Navigation and traffic announcements • Frequency fix function • Radio additional text • Emergency warnings The setting options are country-dependent.

Symbol	Designation	Function
HD	HD radio	Select to switch the HD radio function on or off. This function is not available in all countries.
	Silent function	Select to switch off the sound.
	Store radio stations	Select to save a station in the presets.
	Station list	Select to have the station list shown.
	Search	Select to search in the active menu. You can search for artists, genres or moods, for example.

Additional functions of TuneIn radio

-  A relatively large volume of data can be transmitted when using TuneIn Radio.





Symbol	Designation	Function
	Settings	The following additional settings are available in the TuneIn Radio menu: <ul style="list-style-type: none"> • Selecting stream • Logging on to or out of the TuneIn account
	Favorites	Select during playback to save the station currently set as a favorite.
	Play/Pause	Select to start, stop or continue playback.
	Browse	Select to choose a category and then a radio station.

Additional functions of the satellite radio

SIRIUS XM® satellite radio offers more than 175 digital-quality radio channels providing 100% commercial-free music, sports, news and entertainment, for example. SIRIUS XM® satellite radio employs a fleet of high-performance satel-

lites to broadcast around the clock throughout the USA and Canada. The satellite radio program is available for a monthly fee. Information about this can be obtained from a Sirius XM® Service Center and at <https://www.siriusxm.com> (USA) or <https://www.siriusxm.ca> (Canada).

 Sirius, XM and all related marks and logos are trademarks of Sirius XM Radio Inc. and its subsidiaries. All other marks, channel names and logos are the property of their respective owners. All rights reserved.

Symbol	Designation	Function
	Settings	The following additional settings are available in the satellite radio menu: <ul style="list-style-type: none"> • Activate child safety lock to lock channels with adult content • Set alarm programming for music and sport alerts • Create TuneMix lists to listen to music seamlessly
	Playback control	Select to show the timeline. Tap any point on the timeline to skip forwards or back. Navigate to the end of the timeline to return to live mode.
	Play	Select to start or continue playback.
	Rest	Select to pause the playback.

Depending on the frequency band selected, different functions are available to you.

Select the desired frequency band in the radio menu head runner.

Calling up TuneIn Radio

Requirements:

- The TuneIn Radio service is activated in the Mercedes me Portal.
 - The data volume is available.
Depending on the country, data volume may need to be purchased.
 - A fast Internet connection for data transmission free of interference.
- i** Data volume can be purchased **directly from a mobile phone network provider** via the Mercedes me Portal.
- i** The functions and services are country-dependent. For more information, consult an authorized Mercedes-Benz Center.

Multimedia system:

 **Radio**

- ▶ Select **TuneIn Radio**.

The TuneIn menu appears. The last station set starts playing.

- i** The connection quality depends on the local mobile phone reception.

Setting up satellite radio

Requirements:

- Satellite radio equipment is available.
- Registration with a satellite radio provider has been completed.
- If registration is not included when purchasing the system, your credit card details will be required to activate your account.

Multimedia system:

 **Radio** ▶ **SiriusXM**
▶  **Options**

- ▶ Select **Service Information**.

The service information screen appears showing the radio ID and the current subscription status.

- ▶ Establish a telephone connection.
- ▶ Follow the service staff's instructions. The activation process may take up to ten minutes.

- i** You can also have the satellite service activated online. To do so, please visit <https://www.siriusxm.com>

(USA) or <https://www.siriusxm.ca> (Canada).

Music and sport alerts

Multimedia system:

 **Radio** ▶ **SiriusXM** ▶ 
▶ **Alerts**

Setting music and sport alerts

This function enables you to program an alert for your favorite artists, tracks or sporting events. Music alerts can be saved whilst a track is being played and sport alerts can be saved during a live game. You can also specify sport alerts via the menu option. The system then continuously searches through all the channels.

- ▶ Set a music or sports alert, to be informed of matches in the Live program.

Activating the music information function

- ▶ Activate **Music Alerts** .

Setting a music alert

- ▶ Select **Add Alert**.

- ▶ Select [Artists](#) or [Song](#) in the dialog window. The alert is set for the current artist or track. If a match is found, a prompt appears asking whether you wish to change to the station.

Activating sports information

- ▶ Activate [Activate Sports Alerts](#) .

Setting a sport alert

- ▶ Select [Add Alert](#).
- ▶ Select the team name or league in the dialog window.

Deleting individual sports and music alerts

- ▶ Select [Manage Music Alerts](#).

or

- ▶ Select [Manage Sports Alerts](#).
- ▶ Select an artist or track.

or

- ▶ Select a team.
- ▶ Select [Delete Selected Entries](#). All highlighted alerts are deleted.

Deleting all sports and music alerts

- ▶ Select [Manage Music Alerts](#).

or

- ▶ Select [Manage Sports Alerts](#).
- ▶ Select [Delete All Entries](#). All alerts are deleted.

Sound settings

Overview of functions in the sound menu

The setting options and functions available depend on the sound system installed. You can find out which sound system is installed in your vehicle in the Digital Operator's Manual.

Standard sound system and Advanced sound system

The following functions are available:

- Equalizer:
 - Treble, mid-range and bass
- Balance and fader
- Volume:
 - Automatic adjustment

Burmester® surround sound system and Burmester® high-end 3D surround sound system

The following functions are available:

- Equalizer:
 - Treble, mid-range and bass
- Balance and fader
- Sound focus
- VIP seat (Burmester® high-end 3D surround sound system only)
- Sound profiles
- Volume:
 - Automatic adjustment

ASSYST PLUS service interval display

Function of the ASSYST PLUS service interval display

The ASSYST PLUS service interval display on the Instrument Display provides information on the remaining time or distance before the next service due date.

You can hide this service display using the back button on the left-hand side of the steering wheel.

Depending on how the vehicle is used, the ASSYST PLUS service interval display may shorten the service interval, e.g. in the following cases:

- Mainly short-distance driving
- When the engine is often left idling for long periods
- In the event of frequent cold start phases

Mercedes-Benz recommends avoiding such operating conditions.

You can obtain information concerning the servicing of your vehicle from a qualified specialist

workshop, e.g. an authorized Mercedes-Benz Center.

Displaying the service due date

On-board computer:

↳ Service ►► ASSYST PLUS

The next service due date is displayed.

► **To exit the display:** press the back button on the left-hand side of the steering wheel.

Bear in mind the following related topic:

- Operating the on-board computer (→ page 217).

Information on regular maintenance work

! **NOTE** Premature wear through failure to observe service due dates

Maintenance work which is not carried out at the right time or incompletely can lead to increased wear and damage to the vehicle.

- Adhere to the prescribed service intervals.
- Always have the prescribed maintenance work carried out at a qualified specialist workshop.

Special service requirements

The prescribed service interval is based on normal operation of the vehicle. Maintenance work will need to be performed more often if the vehicle is operated under arduous conditions or increased loads.

The ASSYST PLUS service interval display is only an aid. The driver of the vehicle bears responsibility as regards to whether maintenance work needs to be performed more often than specified based on the actual operating conditions and/or loads.

Examples of arduous operating conditions:

- regular city driving with frequent intermediate stops
- mainly short-distance driving

- frequent operation in mountainous terrain or on poor road surfaces
- when the engine is often left idling for long periods
- operation in particularly dusty conditions and/or if air-recirculation mode is frequently used

In these or similar operating conditions, have the interior air filter, engine air cleaner, engine oil and oil filter etc. changed more frequently. The tires must be checked more frequently if the vehicle is operated under increased loads. Further information can be obtained at a qualified specialist workshop.

Battery disconnection periods

The ASSYST PLUS service interval display can only calculate the service due date when the battery is connected.

- ▶ Note down the service due date displayed on the instrument display before disconnecting the battery (→ page 263).

Engine compartment

Opening and closing the hood

⚠ WARNING Risk of accident due to driving with the hood unlocked

The hood may open and block your view.

- ▶ Never release the hood when driving.
- ▶ Before every trip, ensure that the hood is locked.

⚠ WARNING Risk of accident and injury when opening and closing the hood

The hood may suddenly drop into the end position.

There is a risk of injury for anyone in the hood's range of movement.

- ▶ Open or close the hood only when there is nobody in the hood's range of movement.

⚠ WARNING Danger of burns when opening the hood

If you open the hood when the engine has overheated or during a fire in the engine compartment, you could come into contact with hot gases or other escaping operating fluids.

- ▶ Before opening the hood, allow the engine to cool down.
- ▶ In the event of a fire in the engine compartment, keep the hood closed and call the fire service.

⚠ WARNING Risk of injury due to moving parts

Components in the engine compartment may continue running or start up suddenly, even if the ignition is switched off.

Make sure of the following before performing tasks in the engine compartment:

- ▶ Switch the ignition off.

- ▶ Never reach into the danger zone surrounding moving components, e.g. the rotation area of the fan.
- ▶ Remove jewellery and watches.
- ▶ Keep items of clothing and hair away from moving parts.

⚠ WARNING Risk of injury from touching components under voltage

The ignition system and the fuel injection system work under high voltage. You could receive an electric shock.

- ▶ Never touch components of the ignition system or the fuel injection system when the ignition is switched on.

⚠ WARNING Risk of burns from hot component parts in the engine compartment

Certain component parts in the engine compartment can be very hot, e.g. the engine, the cooler and parts of the exhaust system.

- ▶ Allow the engine to cool down and only touch component parts described in the following.

⚠ WARNING Risk of injury from using the windshield wipers while the engine hood is open

When the engine hood is open and the windshield wipers are set in motion, you can be trapped by the wiper linkage.

- ▶ Always switch off the windshield wipers and ignition before opening the engine hood.

Opening the hood

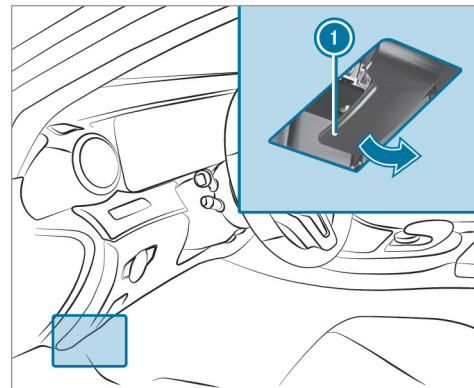

- ▶ To release the hood, pull on handle ①.

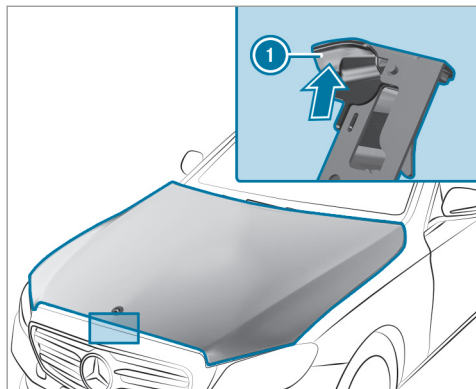

- ▶ Push handle ① of the hood catch upwards and lift the hood by approximately 15 in (40 cm).

Closing the hood

- ▶ Lower the hood to a height of around 8 in (20 cm) and then allow it to fall, applying a little force as you let it go.

- ▶ If the hood can still be lifted slightly, open the hood again and close it with a little more force until it engages correctly.

Engine oil

Checking the engine oil level using the on-board computer

Requirements:

- The engine has been warmed up.
- The vehicle is parked on a level surface.
- The engine is running at idle speed.

The engine oil level is determined during driving. Determining the engine oil level can take up to 30 minutes with a normal driving style and even longer with an active driving style.

On-board computer:

↪ Service ▶▶ Engine Oil Level

You will see one of the following messages on the multifunction display:

- **Measuring Engine Oil Level...:** measurement of the oil level is not yet possible.

- ▶ Repeat the request after a maximum of 30 minutes' driving.

- **Engine Oil Level OK** and the bar display for indicating the oil level on the multifunction display is green and is between "min" and "max": the oil level is correct.

- **Engine Oil Level Add 1,1 qts.** and the bar display for indicating the oil level on the multifunction display is orange and is below "min":

- ▶ Add 1.1 US qt (1 l) of engine oil.

- **Reduce Engine Oil Level** and the bar display for indicating the oil level on the multifunction display is orange and is above "max":

- ▶ Drain off any excess engine oil that has been added. To do so, consult a qualified specialist workshop.

- **For Engine Oil Level Switch Ignition On**

- ▶ Switch on the ignition to check the engine oil level.

- **Engine Oil Level System Inoperative:** The oil level sensor is defective or not connected.

- ▶ Consult a qualified specialist workshop.
 - **Engine Oil Level System Currently Unavail.**
- ▶ Close the hood.

Refilling engine oil

⚠ WARNING Risk of burns from hot component parts in the engine compartment

Certain component parts in the engine compartment can be very hot, e.g. the engine, the cooler and parts of the exhaust system.

- ▶ Allow the engine to cool down and only touch component parts described in the following.

⚠ WARNING Risk of fire and injury from engine oil

If engine oil comes into contact with hot component parts in the engine compartment, it may ignite.

- ▶ Make sure that no engine oil is spilled next to the filler opening.

- ▶ Allow the engine to cool off and thoroughly clean the engine oil from component parts before starting the vehicle.

ⓘ NOTE Engine damage caused by an incorrect oil filter, incorrect oil or additives

- ▶ Do not use engine oils or oil filters which do not correspond to the specifications explicitly prescribed for the service intervals.
- ▶ Follow the instructions on the service interval display for changing the engine oil and observe the prescribed change intervals.
- ▶ Do not use additives.

ⓘ NOTE Damage caused by refilling too much engine oil

Too much engine oil can damage the engine or the catalytic converter.

- ▶ Have excess engine oil removed at a qualified specialist workshop.

- ⓘ** Depending on driving style, the vehicle consumes up to 0.9 US qt (0.8 l) of oil per 600 miles (1000 km). The oil consumption may be higher than this when the vehicle is new or if you frequently drive at high engine speeds.

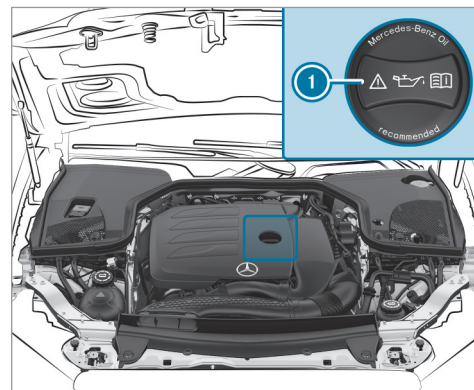

- ▶ Turn cap ❶ counter-clockwise and remove it.
- ▶ Add engine oil.
- ▶ Replace cap ❶ and turn it clockwise until it engages.
- ▶ Check the oil level again (→ page 266).

Checking the coolant level

⚠ WARNING Risk of burns from hot component parts in the engine compartment

Certain component parts in the engine compartment can be very hot, e.g. the engine, the cooler and parts of the exhaust system.

- ▶ Allow the engine to cool down and only touch component parts described in the following.

⚠ WARNING Risk of scalding from hot coolant

If you open the cap, you could be scalded.

- ▶ Let the motor cool down before opening the cap.
- ▶ When opening the cap, wear protective gloves and safety glasses.
- ▶ Open the cap slowly to release pressure.

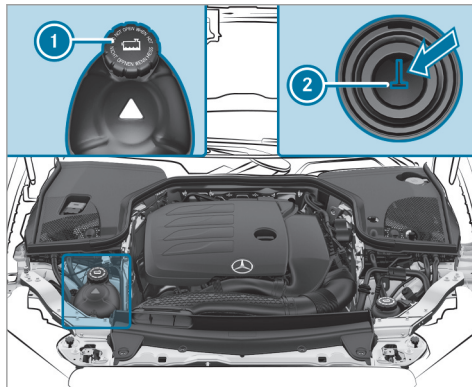

- ▶ Park the vehicle on a level surface.

- ▶ Check the coolant temperature display in the instrument cluster. The coolant temperature must be in the bottom quarter of the temperature display.
- ▶ Slowly turn cap ❶ counter-clockwise to release overpressure.
- ▶ Continue turning cap ❶ counter-clockwise and remove it.

The coolant level is correct in the following cases:

- If the engine is cold, the coolant is up to marker bar ❷.
- If the engine is warm, the coolant is up to 0.6 in (1.5 cm) over marker bar ❷.
- ▶ If necessary, add coolant that has been approved for Mercedes-Benz.
- ❶ Further information on coolant (→ page 335)

Refilling the windshield washer system

⚠ WARNING Risk of burns from hot component parts in the engine compartment

Certain component parts in the engine compartment can be very hot, e.g. the engine, the cooler and parts of the exhaust system.

- ▶ Allow the engine to cool down and only touch component parts described in the following.

⚠ WARNING - Risk of fire and injury from windshield washer concentrate

Windshield washer concentrate is highly flammable. It could ignite if it comes into contact with hot engine component parts or the exhaust system.

- ▶ Make sure that no windshield washer concentrate spills out next to the filler opening.

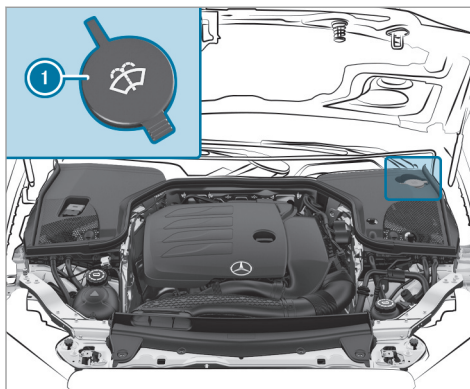

- ▶ Remove cap ① by the tab.
- ▶ Add washer fluid.

Keeping the air-water duct free

- ▶ Keep the area between the hood and the windshield free of deposits, e.g. ice, snow and leaves.

Cleaning and care

Notes on washing the vehicle in a car wash

⚠ WARNING Risk of accident due to reduced braking effect after washing the vehicle

The braking effect is reduced after washing the vehicle.

- ▶ After the vehicle has been washed, brake carefully while paying attention to the traffic conditions until the braking effect has been fully restored.

! NOTE Damage from automatic braking

If one of the following functions is switched on, the vehicle brakes automatically in certain situations:

- Active Brake Assist
- Active Distance Assist DISTRONIC
- HOLD function
- Active Parking Assist

To avoid damage to the vehicle, deactivate these systems in the following or similar situations:

- ▶ During towing
- ▶ In a car wash

! **NOTE** Damage due to unsuitable car wash

- ▶ Before driving into a car wash make sure that the car wash is suitable for the vehicle dimensions.
- ▶ Ensure there is sufficient ground clearance between the underbody and the guide rails of the car wash.
- ▶ Ensure that the clearance width of the car wash, in particular the width of the guide rails, is sufficient.

To avoid damage to your vehicle when using a car wash, ensure the following beforehand:

- Active Distance Assist DISTRONIC is deactivated.
- The HOLD function is switched off.

- The surround view camera or the rear view camera is switched off.
 - The side windows and sliding sunroof are completely closed.
 - The blower for the ventilation/heating is switched off.
 - The windshield wiper switch is in position **0**.
 - The SmartKey is at a minimum distance of 10 ft (3 m) away from the vehicle. Otherwise, the trunk lid could open unintentionally.
 - For car washes with a conveyor system: neutral **N** is engaged.
- i** In car washes with a conveyor system: if you leave the vehicle while it is being washed, make sure the SmartKey is located in the vehicle. The park position **P** is otherwise automatically engaged.
- i** If, after the car wash, you remove the wax from the windshield and wiper rubbers, this will prevent smearing and reduce wiper noise.

Notes on using a power washer

! **WARNING** Risk of an accident when using power washers with round-spray nozzles

The water jet can cause externally invisible damage.

Components damaged in this way may unexpectedly fail.

- ▶ Do not use a power washer with round-spray nozzles.
- ▶ Have damaged tires or chassis parts replaced immediately.

To avoid damage to your vehicle, observe the following when using a power washer:

- The SmartKey is at a minimum distance of 10 ft (3 m) away from the vehicle. Otherwise, the trunk lid could open unintentionally.
- Maintain a distance of at least 11.8 in (30 cm) to the vehicle.
- **Vehicles with decorative foil:** parts of your vehicle are covered with a decorative foil.

Maintain a distance of at least 27.6 in (70 cm) between the foil-covered parts of the vehicle and the nozzle of the power washer. Move the power washer nozzle around whilst cleaning. The water temperature of the power washer must not exceed 140°F (60°C).

- Observe the information on the correct distance in the implement manufacturer's operating instructions.
- Do not direct the nozzle of the power washer directly at sensitive parts, e.g. tires, gaps, electrical components, batteries, light sources and ventilation slits.

Washing the vehicle by hand

! **NOTE** Engine damage due to water ingress

- ▶ Take care not to point the water jet directly towards the air inlet grille below the hood.

Observe the legal requirements, e.g. in a number of countries, washing by hand is only permitted in specially designated wash bays.

- ▶ Use a mild cleaning agent, e.g. car shampoo.
 - ▶ Wash the vehicle with lukewarm water using a soft car sponge. When doing so, do not expose the vehicle to direct sunlight.
 - ▶ Carefully hose the vehicle off with water and dry using a chamois.
- i** Observe the notes on the care of vehicle parts (→ page 272).

Notes on paintwork/matte finish paintwork care

Observe the notes on cleaning and care to avoid damaging the paintwork.

Paint

- Insect remains: soak with insect remover and rinse off the treated areas afterwards.
- Bird droppings: soak with water and rinse off afterwards.

- Tree resin, oils, fuels and greases: remove by rubbing gently with a cloth soaked in petroleum ether or lighter fluid.
- Coolant and brake fluid: remove with a damp cloth and clean water.
- Tar stains: use tar remover.
- Wax: use silicone remover.
- Do not attach stickers, films or similar materials.
- Remove dirt immediately, where possible.

Matte finish

- Only use care products approved for Mercedes-Benz.
- Do not polish the vehicle and alloy wheels.
- Only use car washes that correspond to the latest engineering standards.
- Do not use car wash programs with a final hot wax treatment.
- Do not use paint cleaners, buffing or polishing products, gloss preservers, e.g. wax.
- Always have paintwork repairs carried out at a qualified specialist workshop.

Notes on cleaning decorative foils

Observe the notes on matte finish care in the chapter "Notes on paintwork/matte finish paintwork care" (→ page 271). They also apply to matte decorative foils.

Observe the notes on cleaning decorative foils to avoid vehicle damage.

Cleaning

- For cleaning, use plenty of water and a mild cleaning agent without additives or abrasive substances, e.g. a car shampoo approved for Mercedes-Benz.
- Remove dirt immediately, where possible, whilst avoiding rubbing too hard. There is otherwise a risk of damaging the decorative foil irreparably.
- If there is dirt on the finish or if the decorative foil is dull: use the Paint Cleaner recommended and approved for Mercedes-Benz.
- Insect remains: soak with insect remover and rinse off the treated areas afterwards.
- Bird droppings: soak with water and rinse off afterwards.

- To prevent water stains, dry a foil-wrapped vehicle with a soft, absorbent cloth after every car wash.

Avoiding damage to the decorative foil

- The service life and color of decorative foils are impaired by:
 - Sunlight
 - Temperature, e.g. hot air blower
 - Weather conditions
 - Stone chippings and dirt
 - Chemical cleaning agents
 - Oily products
- Do not use polish on matte decorative foil. Polishing will have the effect of shining the foil-wrapped surface.
- Do not treat matte or structured decorative foils with wax. Permanent stains may occur.

Scratches, corrosive deposits, areas affected by corrosion and damage caused by incorrect care cannot always be completely repaired. In such cases, visit a qualified specialist workshop.

You can obtain more information on care and cleaning products from the manufacturer.

In the case of foil-wrapped surfaces, optical differences may occur between the surfaces that were not protected by a decorative foil after removing a decorative foil.

- ⓘ Have work or repairs to decorative foils carried out at a qualified specialist workshop, e.g. at an authorized Mercedes-Benz Center.

Notes on care of vehicle parts

⚠ WARNING Risk of entrapment if the windshield wipers are switched on while the windshield is being cleaned

If the windshield wipers are set in motion while you are cleaning the windshield or wiper blades, you can be trapped by the wiper arm.

- ▶ Always switch off the windshield wipers and the ignition before cleaning the windshield or wiper blades.

▲ WARNING Risk of burns from the tailpipe and tailpipe trims

The exhaust tailpipe and tailpipe trims can become very hot. If you come into contact with these parts of the vehicle, you could burn yourself.

- ▶ Always be particularly careful around the tailpipe and the tailpipe trims and supervise children especially closely in this area.
- ▶ Allow vehicle parts to cool down before touching them.

To avoid damage to the vehicle, observe the notes on cleaning and care of the following vehicle parts:

Wheels and rims

- Use water and acid-free alloy wheel cleaners.
- Do not use acidic alloy wheel cleaners to remove brake dust. This could damage wheel bolts and brake components.
- To avoid corrosion of the brake discs and brakepads, drive the vehicle for a few

minutes after cleaning before parking it. The brake discs and brakepads warm up and dry out.

Windows

- Clean the windows inside and outside with a damp cloth and with a cleaning agent recommended for Mercedes-Benz.
- Do not use dry cloths or abrasive or solvent-based cleaning agents to clean the inside of windows.

Wiper blades

- Move the wiper arms into the replacement position (→ page 121).
- With the wiper arms folded out, clean the wiper blades with a damp cloth.
- Do not clean the wiper blades too often.

Exterior lighting

- Clean the lenses with a wet sponge and mild cleaning agent, e.g. car shampoo.
- Only use cleaning agents or cleaning cloths that are suitable for plastic lenses.

Sensors

- Clean the sensors in the front and rear bumpers with a soft cloth and car shampoo (→ page 161).
- When using a power washer, maintain a minimum distance of 11.8 in (30 cm).

Rear view camera and surround view camera

- Open the camera cover with the multimedia system (→ page 203).
- Use clean water and a soft cloth to clean the camera lens.
- Do not use a power washer.

Tailpipes

- Clean with a cleaning agent recommended for Mercedes-Benz, especially in the winter and after washing the vehicle.
- Do not use acidic cleaning agents.

Notes on care of the interior

⚠ WARNING Risk of injury from plastic parts breaking off after the use of solvent-based care products

Care and cleaning products containing solvents can cause surfaces in the cockpit to become porous. When the airbags are deployed, plastic parts may break away.

- ▶ Do not use any care or cleaning products containing solvents to clean the cockpit.

⚠ WARNING Risk of injury or death from bleached seat belts

Bleaching or dyeing seat belts can severely weaken them.

This can, for example, cause seat belts to tear or fail in an accident.

- ▶ Never bleach or dye seat belts.

To avoid damage to the vehicle, observe the following notes on cleaning and care:

Seat belts

- Clean with lukewarm and soapy water.
- Do not use chemical cleaning agents.
- Do not dry by heating them to over 176°F (80°C) or exposing them to direct sunlight.

Display

- Switch off the display and let it cool down.
- Clean the surface carefully with a microfiber cloth and a suitable display care product (TFT-LCD).
- Do not use any other agents.

Plastic trim

- Clean with a damp microfiber cloth.
- For heavy soiling: use a cleaner recommended for Mercedes-Benz.
- Do not attach stickers, films or similar materials.
- Do not allow cosmetics, insect repellent or sun cream to come in contact with the plastic trim.

Real wood and trim elements

- Clean with a microfiber cloth.

- Black piano-lacquer look: clean with a damp cloth and soapy water.
- For heavy soiling: use a cleaner recommended for Mercedes-Benz.
- Do not use solvent-based cleaning agents, polishes or waxes.

Headliner

- Clean with a brush or dry shampoo.

Carpet

- Use a carpet and textile cleaning agent recommended for Mercedes-Benz.

Steering wheel made of genuine leather or DINAMICA

! **NOTE** Damage caused by wrong cleaners

- ▶ Do not use solvent-based cleaning agents such as tar remover or wheel cleaner; neither should you use polishes or waxes. Otherwise you may damage the finish.

- Clean with a damp cloth and 1% soapy water solution and then wipe with a dry cloth.

- For heavy soiling: use a cleaner recommended for Mercedes-Benz.
- Leather care: use a leather care agent that has been recommended for Mercedes-Benz.
- Do not allow the leather to become too damp.
- Do not use a microfiber cloth.

i Leather is a natural product. It has natural surface properties, such as differences in structure, marks caused by growth and injury or subtle color differences.

Genuine leather seat covers

- Clean with a damp cloth and then wipe with a dry cloth.
- Leather care: use a leather care agent that has been recommended for Mercedes-Benz.
- Do not allow the leather to become too damp.
- Do not use a microfiber cloth.

DINAMICA seat covers

- Clean with a damp cloth.
- Do not use a microfiber cloth.

Imitation leather seat covers

- Clean with a damp cloth and 1% soapy water.
- Do not use a microfiber cloth.

Fabric seat covers

- Clean with a damp microfiber cloth and 1% soap solution and allow to dry.

Emergency

Removing the safety vest

The safety vests are located in the stowage compartments in the driver and front passenger door.

- ▶ **To remove:** pull out the safety vest bag by the loop.
- ▶ Open the safety vest bag and pull out the safety vest.

i There are also safety vest compartments in the rear door stowage compartments in which safety vests can be stored.

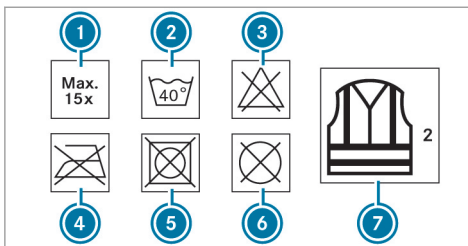

- ① Maximum number of washes
- ② Maximum wash temperature
- ③ Do not bleach
- ④ Do not iron
- ⑤ Do not tumble dry
- ⑥ Do not dry clean
- ⑦ Class 2 safety vest

The requirements defined by the legal standard are only fulfilled if the safety vest is the correct size and is fully closed.

Replace the safety vest in the following cases:

- The reflective strips are damaged or dirty.

- The maximum permissible number of washes is exceeded.
- The fluorescence has faded.

Warning triangle

Removing the warning triangle

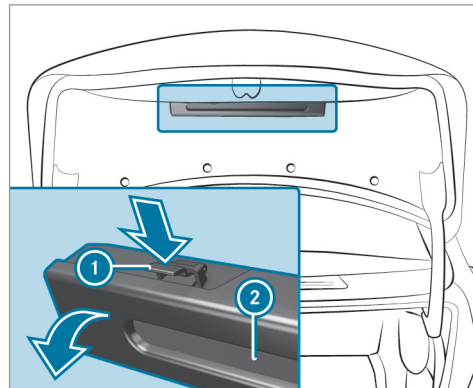

- ▶ Push both sides of warning triangle holder ① in the direction of the arrow and open it.
- ▶ Remove warning triangle ②.

Setting up the warning triangle

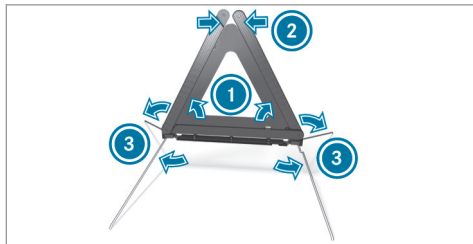

- ▶ Fold side reflectors ① upwards to form a triangle and attach at the top using upper press-stud ②.
- ▶ Fold legs ③ down and out to the side.

First-aid kit (soft-sided) overview

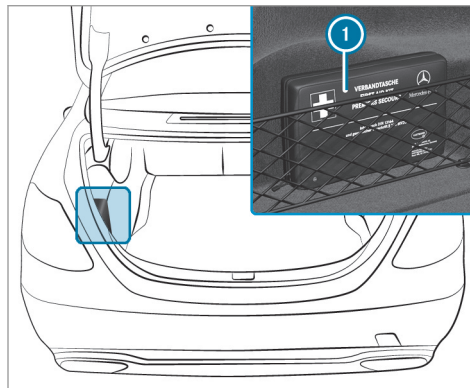

First-aid kit (soft sided) ① is in the trunk in the left-hand or right-hand storage net, depending on the model.

- ① In vehicles with a Burmester® surround sound system, the first-aid kit (soft sided) is located in the trunk when the vehicle is delivered.

Flat tire

Notes in the event of a flat tire

⚠ WARNING Risk of accident due to a flat tire

A flat tire severely affects the driving characteristics as well as the steering and braking of the vehicle.

Tires without run-flat characteristics:

- ▶ Do not drive with a flat tire.
- ▶ Change the flat tire immediately with an emergency spare wheel or spare wheel. Alternatively, consult a qualified specialist workshop.

Tires with run-flat characteristics:

- ▶ Observe the information and warning notes on MOExtended tires (run-flat tire).

In the event of a flat tire, the following options are available depending on your vehicle's equipment:

- **Vehicles with MOExtended tires:** it is possible to continue the journey for a short period of time. Make sure you observe the notes on MOExtended tires (run-flat tires) (→ page 278).
 - **Vehicles with a TIREFIT kit:** you can repair the tire so that it is possible to continue the journey for a short period of time. To do this, use the TIREFIT kit (→ page 279).
 - **Vehicles with Mercedes me connect:** you can make a call for breakdown assistance via the overhead control panel in the case of a breakdown (→ page 245).
 - **All vehicles:** change the wheel (→ page 320).
- i** The emergency spare wheel is only available in certain countries.

Notes on MOExtended tires (run-flat tires)

⚠ WARNING Risk of accident when driving in limp-home mode

When driving in emergency mode the handling characteristics are impaired.

- ▶ Do not exceed the specified maximum speed of the MOExtended tires.
- ▶ Avoid any abrupt steering and driving maneuvers as well as driving over obstacles (curbs, pot holes, off-road). This applies, in particular, to a loaded vehicle.
- ▶ Stop driving in the emergency mode if you notice:
 - Banging noise
 - Vehicle vibration
 - Smoke which smells like rubber
 - Continuous ESP® intervention
 - Cracks in the tire side walls
- ▶ After driving in emergency mode, have the rims checked by a qualified special-

ist workshop with regard to their further use.

- ▶ The defective tire must be replaced in every case.

With MOExtended tires (run-flat tires), you can continue to drive your vehicle even if there is a total loss of pressure in one or more tires. However, the tire affected must not show any clearly visible damage.

You can recognize MOExtended tires by the MOExtended marking which appears on the side wall of the tire.

Vehicles with tire pressure loss warning system: MOExtended tires may only be used in conjunction with an activated tire pressure loss warning system.

Vehicles with tire pressure monitoring system: MOExtended tires may only be used in conjunction with an activated tire pressure monitoring system.

If a pressure loss warning message appears in the multifunction display, proceed as follows:

- Check the tires for damage.
- If driving on, observe the following notes.

Driving distance possible in emergency mode after the pressure loss warning:

Load condition	Driving distance possible in emergency mode
Partially laden	50 miles (80 km)
Fully laden	19 miles (30 km)

The driving distance possible in emergency mode may vary depending on the driving style. Observe the maximum permissible speed of 50 mph (80 km/h).

If a tire has gone flat and cannot be replaced with an MOExtended tire, you can use a standard tire as a temporary measure.

TIREFIT kit storage location

The TIREFIT kit is located under the trunk floor.

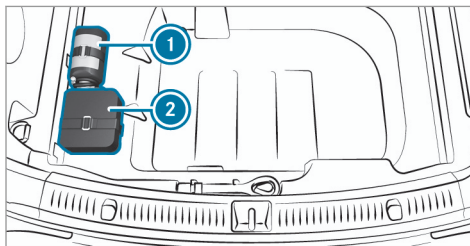

- ① Tire sealant bottle
- ② Tire inflation compressor

Depending on the model, the TIREFIT kit may also be located in other places under the trunk floor.

Using the TIREFIT kit

Requirements:

- Tire sealant bottle and tire inflation compressor (→ page 279).

- TIREFIT sticker
- Gloves (depending on the vehicle equipment)

You can use TIREFIT tire sealant to seal perforation damage of up to 0.16 in (4 mm), particularly those in the tire contact surface. You can use TIREFIT in outside temperatures down to -4°F (-20°C).

⚠ WARNING Risk of accident when using tire sealant

The tire sealant may be unable to seal the tire properly, especially in the following cases:

- There are large cuts or punctures in the tire (larger than damage previously mentioned)
 - The wheel rims have been damaged
 - After journeys with very low tire pressure or with flat tires
- ▶ Do not continue driving.
▶ Consult a qualified specialist workshop.

⚠ WARNING Risk of injury and poisoning from tire sealant

The tire sealant is harmful and causes irritation. Do not allow it to come into contact with the skin, eyes or clothing, and do not swallow it. Do not inhale tire sealant fumes. Keep the tire sealant away from children.

If you come into contact with the tire sealant, observe the following:

- ▶ Rinse off the tire sealant from your skin immediately using water.
- ▶ If tire sealant gets into your eyes, thoroughly rinse out the eyes using clean water.
- ▶ If tire sealant has been swallowed, immediately rinse out the mouth thoroughly and drink plenty of water. Do not induce vomiting and seek medical attention immediately.
- ▶ Change out of any clothes contaminated with tire sealant immediately.
- ▶ If allergic reactions occur, seek medical attention immediately.

! NOTE Overheating due to the tire inflation compressor running too long

- ▶ Do not run the tire inflation compressor for longer than ten minutes without interruption.

Comply with the manufacturer's safety notes on the sticker on the tire inflation compressor.

Have the tire sealant bottle replaced in a qualified specialist workshop every five years.

- ▶ Do not remove any foreign objects which have entered the tire.

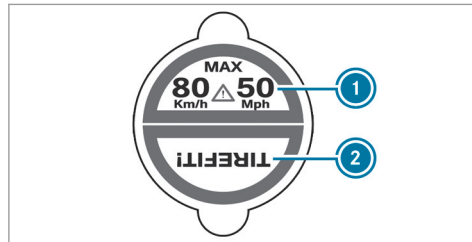

- ▶ Affix part ① of the TIREFIT sticker to the instrument cluster within the driver's field of vision.
- ▶ Affix part ② of the TIREFIT sticker near the valve on the wheel with the faulty tire.

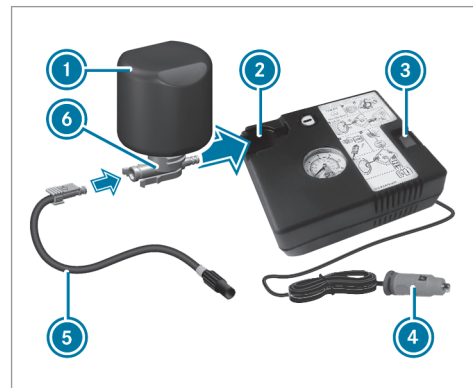

- ▶ Pull plug ④ with the cable and hose ⑤ out of the tire inflation compressor housing.

- ▶ Push the plug of hose ⑤ into flange ⑥ of tire sealant bottle ① until the plug engages.
- ▶ Place tire sealant bottle ① head downwards into recess ② of the tire inflation compressor.

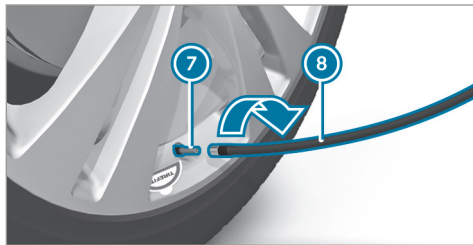

- ▶ Remove the valve cap from valve ⑦ on the faulty tire.
- ▶ Screw filling hose ⑧ onto valve ⑦.
- ▶ Insert plug ④ into a 12 V socket in your vehicle.
- ▶ Switch on the ignition.

- ▶ Switch on the tire inflation compressor using On/Off switch ③.
The tire is inflated. First, tire sealant is pumped into the tire. The pressure may briefly rise to approximately 500 kPa (5 bar/73 psi).

Do not switch off the tire inflation compressor during this phase!

- ▶ Let the tire inflation compressor run for a maximum of ten minutes.
The tire should then have attained a tire pressure of at least 200 kPa (2.0 bar/29 psi).

If tire sealant leaks out, make sure you clean the affected area as quickly as possible. It is preferable to use clean water.

If you get tire sealant on your clothing, have it cleaned as soon as possible with perchloroethylene.

If, after ten minutes, a tire pressure of 200 kPa (2.0 bar/29 psi) has not been attained:

- ▶ Switch off the tire inflation compressor.

- ▶ Unscrew the filling hose from the valve of the faulty tire.

Please note that tire sealant may leak out when unscrewing the filling hose.

- ▶ Drive forwards or in reverse very slowly for approximately 33 ft (10 m).
- ▶ Pump up the tire again.
After a maximum of ten minutes the tire pressure must be at least 200 kPa (2.0 bar/29 psi).

⚠ WARNING Risk of accident due to the specified tire pressure not being attained

If the minimum tire pressure is not reached after the specified time, the tire is too badly damaged. The tire sealant cannot repair the tire in this instance.

The braking and driving characteristics may be greatly impaired.

- ▶ Do not continue driving.
- ▶ Consult a qualified specialist workshop.

If, after ten minutes, a tire pressure of 200 kPa (2.0 bar/29 psi) has been attained:

- ▶ Switch off the tire inflation compressor.
- ▶ Unscrew the filling hose from the valve of the faulty tire.

⚠ WARNING Risk of accident from driving with sealed tires

A tire temporarily sealed with tire sealant impairs the handling characteristics and is not suitable for higher speeds.

- ▶ Adapt your driving style accordingly and drive carefully.
- ▶ Do not exceed the maximum speed limit with a tire that has been repaired using tire sealant.

- ▶ Observe the maximum permissible speed for a tire sealed with tire sealant 50 mph (80 km/h).

! **NOTE** Staining caused by leaking tire sealant

After use, excess tire sealant may leak out from the filling hose.

- ▶ Therefore, place the filling hose in the plastic bag that contained the TIREFIT kit.

🔥 ENVIRONMENTAL NOTE Environmental pollution caused by environmentally irresponsible disposal

Tire sealant contains pollutants.

- ▶ Have the tire sealant bottle disposed of professionally, e.g. at an authorized Mercedes-Benz Center.

- ▶ Store the tire sealant bottle and the tire inflation compressor.
- ▶ Pull away immediately.

- ▶ Stop driving after approximately ten minutes and check the tire pressure using the tire inflation compressor.
The tire pressure must now be at least 130 kPa (1.3 bar/ 19 psi).

⚠ WARNING Risk of accident due to the specified tire pressure not being attained

If the specified tire pressure is not reached, the tire is too badly damaged. The tire sealant cannot repair the tire in this instance.

The braking and driving characteristics may be greatly impaired.

- ▶ Do not continue driving.
- ▶ Consult a qualified specialist workshop.

In cases such as the one mentioned above, contact an authorized Mercedes-Benz Center. Or call 1-800-FOR-MERCEDES (in the USA) or 1-800-387-0100 (in Canada).

- ▶ Correct the tire pressure if it is still at least 130 kPa (1.3 bar/ 19 psi). See the Tire and Loading Information placard on the B-pillar

on the driver's side or the tire pressure table in the fuel filler flap for values.

- ▶ **To increase the tire pressure:** switch on the tire inflation compressor.

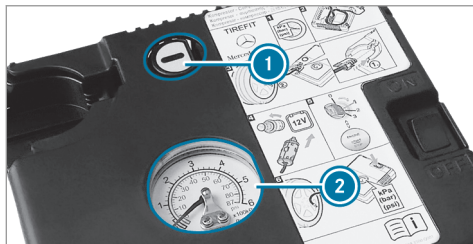

- ▶ **To reduce the tire pressure:** press pressure release button ① next to manometer ②.
- ▶ When the tire pressure is correct, unscrew the filling hose from the valve of the sealed tire.
- ▶ Screw the valve cap onto the valve of the sealed tire.

- ▶ Pull the tire sealant bottle out of the tire inflation compressor. The filling hose stays on the tire sealant bottle.
- ▶ Drive to the nearest qualified specialist workshop and have the tire, tire sealant bottle and filling hose replaced there.

Battery (vehicle)

Notes on the 12 V battery

⚠ WARNING Risk of an accident due to work carried out incorrectly on the battery

Work carried out incorrectly on the battery can, for example, lead to a short circuit. This can restrict functions relevant for safety systems and impair the operating safety of your vehicle.

You could lose control of the vehicle in the following situations in particular:

- When braking

- In the event of abrupt steering maneuvers and/or when the vehicle's speed is not adapted to the road conditions
- ▶ In the event of a short circuit or a similar incident, contact a qualified specialist workshop immediately.
- ▶ Do not drive on.
- ▶ Always have work on the battery carried out at a qualified specialist workshop.

- Further information on ABS (→ page 163)
- Further information on ESP® (→ page 163)

For safety reasons, Mercedes-Benz recommends that you only use batteries which have been tested and approved for your vehicle by Mercedes-Benz.

All vehicles except vehicles with a lithium-ion battery

⚠ WARNING Risk of explosion due to electrostatic charge

Electrostatic charge can ignite the highly explosive gas mixture in the battery.

- ▶ To discharge any electrostatic charge that may have built up, touch the metal vehicle body before handling the battery.

The highly flammable gas mixture is created while the battery is charging and during starting assistance.

⚠ WARNING Danger of chemical burns from the battery acid

Battery acid is caustic.

- ▶ Avoid contact with the skin, eyes or clothing.
- ▶ Do not lean over the battery.
- ▶ Do not inhale battery gases.

- ▶ Keep children away from the battery.
- ▶ Immediately rinse battery acid off thoroughly with plenty of clean water and seek medical attention immediately.

All vehicles

🔥 ENVIRONMENTAL NOTE Environmental damage caused by improper disposal of batteries



Batteries contain pollutants. It is illegal to dispose of them with the household rubbish.



Dispose of batteries in an environmentally responsible manner. Take discharged batteries to a qualified specialist workshop or to a collection point for used batteries.

If you have to disconnect the 12 V battery, contact a qualified specialist workshop.

Comply with safety notes and take protective measures when handling batteries.



Risk of explosion.



Fire, open flames and smoking are prohibited when handling the battery. Avoid creating sparks.



Electrolyte or battery acid is corrosive. Avoid contact with the skin, eyes or clothing. Wear suitable protective clothing, in particular gloves, an apron and a face mask. Immediately rinse electrolyte or acid splashes off with clean water. Consult a doctor if necessary.



Wear safety glasses.



Keep children away.



Observe this Operator's Manual.

Observe the following if you do not intend to use the vehicle over an extended period of time:

- Activate standby mode.
- Alternatively: connect the battery to a battery charger approved by Mercedes-Benz or consult a qualified specialist workshop to disconnect the battery.

Notes on starting assistance and charging the 12 V battery

Vehicles with a lithium-ion battery

When charging the battery and during starting assistance, always use the jump-start connection point in the engine compartment.

! **NOTE** Damage to the battery from over-voltage

When charging using a battery charger without a maximum charging voltage, the battery or the on-board electronics may be damaged.

- ▶ Only use battery chargers with a maximum charging voltage of 14.8 V.

All other vehicles

When charging the battery and during starting assistance, always use the jump-start connection point in the engine compartment.

! **NOTE** Damage to the battery from over-voltage

When charging using a battery charger without a maximum charging voltage, the battery or the on-board electronics may be damaged.

- ▶ Only use battery chargers with a maximum charging voltage of 14.8 V.

! **WARNING** Risk of explosion from hydrogen gas igniting

There is a danger of hydrogen gas igniting when charging the battery if there is a short circuit or sparks start to form.

- ▶ Make sure that the positive terminal of the connected battery does not come into contact with vehicle parts.
- ▶ Never place metal objects or tools on a battery.
- ▶ The described order of the battery clamps must be observed when connecting and disconnecting the battery.
- ▶ When giving starting assistance, always make sure that you only connect battery terminals with identical polarity.
- ▶ During starting assistance, you must observe the described order for connecting and disconnecting the jumper cable.
- ▶ Do not connect or disconnect the battery clamps while the engine is running.

▲ WARNING Risk of explosion during charging process and starting assistance

During the charging process and starting assistance, the battery may release an explosive gas mixture.

- ▶ Avoid fire, open flames, creating sparks and smoking.
- ▶ Make sure there is sufficient ventilation.
- ▶ Do not lean over a battery.

▲ WARNING Risk of explosion from a frozen battery

A discharged battery may freeze at temperatures slightly above or below freezing point.

During starting assistance or battery charging, battery gas can be released.

- ▶ Always allow a battery to thaw before charging it or performing starting assistance.

If the indicator/warning lamps in the instrument cluster do not light up at low temperatures, it is very likely that the discharged battery has frozen. In this case you may neither jump-start the vehicle nor charge the battery.

The service life of a battery that has been thawed may be dramatically shortened. The starting characteristics may be impaired, especially at low temperatures.

It is recommended that you have a thawed battery checked at a qualified specialist workshop.

All vehicles

! NOTE Damage caused by numerous or extended attempts to start the engine

Numerous or extended attempts to start the engine may damage the catalytic converter due to non-combusted fuel.

- ▶ Avoid numerous and extended attempts to start the engine.

Observe the following points during starting assistance and when charging the battery:

- Only use undamaged jumper cables/charging cables with a sufficient cross-section and insulated terminal clamps.
- Non-insulated parts of the terminal clamps must not come into contact with other metal parts while the jumper cable/charging cable is connected to the battery/jump-start connection point.
- The jumper cable/charging cable must not come into contact with any parts which may move when the engine is running.
- Always make sure that neither you nor the battery is electrostatically charged.
- Keep away from fire and open flames.
- Do not lean over the battery.

Observe the additional following points when charging the battery:

- Only use battery chargers tested and approved for Mercedes-Benz.
- Read the battery charger's operating instructions before charging the battery.

Observe the additional following points during starting assistance:

- Starting assistance may only be provided using vehicles, batteries or other jump start devices with a nominal voltage of 12 V.
- The vehicles must not touch.
- **Vehicles with a gasoline engine:** Jump start the vehicle only when the engine and exhaust system are cold.

Starting assistance and charging the 12 V battery

Requirements:

- The vehicle is secured with the electric parking brake.
- **Vehicles with automatic transmission:** The transmission is in position **P**.
- The ignition and all electrical consumers are switched off.
- The hood is open.

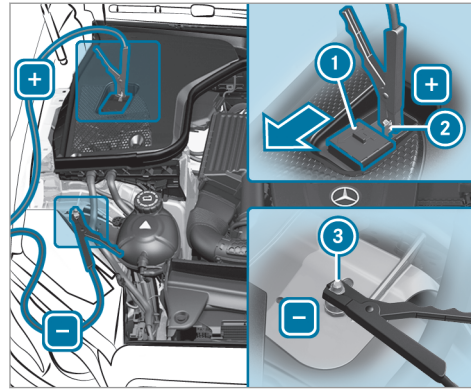

Example: engine compartment

- ▶ Slide cover **1** of positive clamp **2** on the jump-starting connection point in the direction of the arrow.
- ▶ Connect positive clamp **2** on your vehicle to the positive pole of the donor battery using the jumper cable/charging cable. Always

begin with positive clamp **2** on your own vehicle first.

- ▶ **During starting assistance:** start the engine of the donor vehicle and run at idle speed.
- ▶ Connect the negative pole of the donor battery and ground point **3** of your own vehicle by using the jumper cable/charging cable. Begin with the donor battery first.
- ▶ **During starting assistance:** start the engine of your own vehicle.
- ▶ **During the charging process:** start the charging process.
- ▶ **During starting assistance:** let the engines run for several minutes.
- ▶ **During starting assistance:** before disconnecting the jumper cable, switch on an electrical consumer in your own vehicle, e.g. the rear window heater or lighting.

When the starting assistance/charging process is complete, perform the following steps:

- ▶ First, remove the jumper cable/charging cable from ground point ③ and the negative pole of the donor battery, then from positive clamp ② and the positive pole of the donor battery. Begin each time with the contacts on your own vehicle first.
- ▶ After removing the jumper cable/charging cable, close cover ① of positive clamp ②.

Further information can be obtained at a qualified specialist workshop.

Replacing the 12 V battery

- ▶ Observe the notes on the 12 V battery (→ page 283).

Mercedes-Benz recommends that you have the 12 V battery replaced at a qualified specialist workshop, e.g. at an authorized Mercedes-Benz Center.

Observe the following notes if you want to replace the battery yourself:

- Always replace a faulty battery with a battery which meets the specific vehicle requirements.

The vehicle is equipped with an AGM technology battery (Absorbent Glass Mat) or a lithium-ion battery. Full vehicle functionality is only guaranteed with an AGM battery or lithium-ion battery. For safety reasons, Mercedes-Benz recommends that you only use batteries which have been tested and approved for your vehicle by Mercedes-Benz.

- Carry over detachable parts, such as vent hoses, elbow fitting or terminal covers from the battery being replaced.
- Make sure that the vent hose is always connected to the original opening on the side of the battery.

Install any existing or supplied cell caps.

Otherwise, gases or battery acid could escape.

- Make sure that detachable parts are reconnected in the same way.

Tow starting or towing away

Permitted towing methods

! NOTE Damage from automatic braking

If one of the following functions is switched on, the vehicle brakes automatically in certain situations:

- Active Brake Assist
- Active Distance Assist DISTRONIC
- HOLD function
- Active Parking Assist

To avoid damage to the vehicle, deactivate these systems in the following or similar situations:

- ▶ During towing
- ▶ In a car wash

Mercedes-Benz recommends transporting your vehicle in the case of a breakdown, rather than towing it away.

For towing, use a tow rope or tow bar with both axles on the ground. Do not use tow bar systems.

! **NOTE** Damage to the vehicle due to towing away incorrectly

► Observe the instructions and notes on towing away.

Vehicles with rear wheel drive

Both axles on the ground	Yes, max. 50 km at 50 km/h
Front axle raised	No
Rear axle raised	Yes, if the steering wheel is fixed in the center position with a steering wheel lock

4MATIC vehicles

Both axles on the ground	Yes, max. 50 km at 50 km/h
Front axle raised	No
Rear axle raised	No

To tow with a raised axle: towing should be performed by a towing company.

Towing the vehicle with both axles on the ground

- Observe the notes on the permitted towing methods (→ page 288).
- Make sure that the battery is connected and charged.

Observe the following points when the battery is discharged:

- The engine cannot be started

- The electric parking brake cannot be released or applied
- **Vehicles with automatic transmission:** The automatic transmission cannot be shifted to position **N** or **P**

i **Vehicles with automatic transmission:** If the automatic transmission cannot be shifted to position **N**, or the multifunction display in the instrument cluster does not show anything, have the vehicle transported away (→ page 291). A towing vehicle with lifting equipment is required for vehicle transportation.

! **NOTE** Damage due to towing away at excessively high speeds or over long distances

The drivetrain could be damaged when towing at excessively high speeds or over long distances.

- A towing speed of 30 mph (50 km/h) must not be exceeded.

- ▶ A towing distance of 30 miles (50 km) must not be exceeded.

⚠ WARNING Risk of accident when towing a vehicle which is too heavy

If another vehicle is tow-started or towed away, its weight must not exceed the permissible gross mass of your own vehicle, otherwise the following could occur:

- The towing eye may become detached.
 - The vehicle/trailer combination may swerve or even rollover.
- ▶ If another vehicle is tow-started or towed away, its weight must not exceed the permissible gross mass of your own vehicle.

If a vehicle must be tow-started or towed away, its permissible gross weight must not exceed the permissible gross weight of the towing vehicle.

- ▶ Information on the permissible gross mass of the vehicle can be found on the vehicle identification plate (→ page 329).

- ▶ **Vehicles with automatic transmission:** Do not open the driver's door or front passenger door, otherwise the automatic transmission automatically shifts to position **[P]**.
- ▶ Install the towing eye (→ page 292).
- ▶ Fasten the tow bar.

! **NOTE** Damage due to incorrect connection of the tow bar

- ▶ Only connect the tow rope or tow bar to the towing eyes.

- ▶ Deactivate the automatic locking mechanism (→ page 69).
- ▶ Do not activate the HOLD function.
- ▶ Deactivate the tow-away alarm (→ page 85).
- ▶ Deactivate Active Brake Assist (→ page 186).
- ▶ **Vehicles with automatic transmission:** Shift the automatic transmission to position **[N]**.
- ▶ Release the electric parking brake.

⚠ WARNING Risk of accident due to limited safety-related functions during the towing process

Safety-related functions are limited or no longer available in the following situations:

- The ignition is switched off.
- The brake system or power steering system is malfunctioning.
- The energy supply or the on-board electrical system is malfunctioning.

When your vehicle is then towed away, significantly more effort may be required to steer and brake than is normally required.

- ▶ Use a tow bar.
- ▶ Make sure that the steering wheel can move freely before towing the vehicle away.

! **NOTE** Damage due to excessive tractive power

If you pull away sharply, the tractive power may be too high and the vehicles could be damaged.

- ▶ Pull away slowly and smoothly.

Loading the vehicle for transport

- ▶ Observe the notes on towing away (→ page 289).
- ▶ Connect the tow bar to the towing eye in order to load the vehicle.
- ▶ **Vehicles with automatic transmission:** Shift the automatic transmission to position **N**.

i **Vehicles with automatic transmission:** The automatic transmission may be locked in position **P** in the event of damage to the electrical system. To shift to **N**, provide the on-board electrical system with power (→ page 287).

- ▶ Load the vehicle onto the transporter.
- ▶ **Vehicles with automatic transmission:** Shift the automatic transmission to position **P**.
- ▶ Use the electric parking brake to secure the vehicle against rolling away.
- ▶ Only secure the vehicle by the wheels.

Vehicles with ADS PLUS (Adaptive Damping System PLUS)

! **WARNING** Risk of an accident when transporting vehicles with Adaptive Damping System PLUS

When transporting vehicles with Adaptive Damping System PLUS, the vehicle/trailer combination may begin to rock and start to skid.

- ▶ Load the vehicle correctly onto the transporter.
- ▶ Secure the vehicle on all four wheels with suitable tensioning straps.

- ▶ Do not exceed the maximum permissible speed of 35 mph (60 km/h) when transporting.

! **NOTE** Damage to the vehicle from securing it incorrectly

- ▶ After loading, the vehicle must be secured on all four wheels. Otherwise, the vehicle could be damaged.
- ▶ A minimum distance of 8 in (20 cm) upwards and 4 in (10 cm) downwards must be kept to the transport platform.

- ▶ Secure the vehicle on all four wheels after loading.

4MATIC vehicles/vehicles with automatic transmission

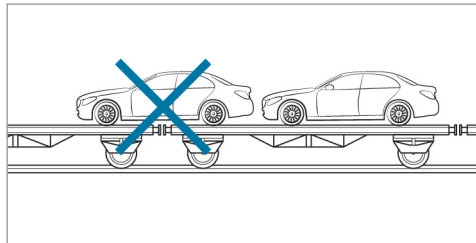

- ▶ Make sure that the front and rear axles come to rest on the same transportation vehicle.

! **NOTE** Damage to the drivetrain due to incorrect positioning

- ▶ Do not position the vehicle above the connection point of the transport vehicle.

Towing eye storage location

The towing eye is located in the stowage space under the trunk floor.

Installing the towing eye

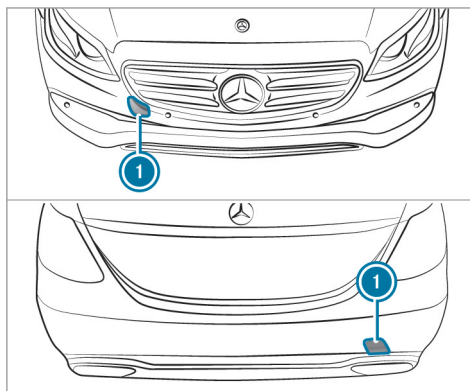

- ▶ Press the mark on cover ① inwards and remove.

- ▶ Screw in the towing eye clockwise as far as it will go and tighten.

- ① Make sure that cover ① engages in the bumper when you remove the towing eye.

! **NOTE** Damage to the vehicle due to incorrect use of the towing eye

When a towing eye is used to recover a vehicle, the vehicle may be damaged in the process.

- ▶ Only use the towing eye to tow away or tow start the vehicle.

Tow starting the vehicle (emergency engine start)

Vehicles with automatic transmission

! **NOTE** Damage to the automatic transmission due to tow starting

The automatic transmission may be damaged in the process of tow starting vehicles with automatic transmission.

- ▶ Vehicles with automatic transmission must not be tow started.

- ▶ Vehicles with automatic transmission must not be tow-started.

Electrical fuses

Notes on electrical fuses

- ⚠ **WARNING** Risk of accident and injury due to overloaded lines

If you manipulate or bridge a faulty fuse or if you replace it with a fuse with a higher amperage, the electric line could be overloaded.

This could result in a fire.

- ▶ Always replace faulty fuses with specified new fuses containing the correct amperage.

- ⚠ **NOTE** Damage due to incorrect fuses

Electrical components or systems may be damaged by incorrect fuses, or their functionality may be significantly impaired.

- ▶ Only use fuses that have been approved by Mercedes-Benz and which have the correct fuse rating.

Blown fuses must be replaced with fuses of the same rating, which you can recognize by the color and fuse rating. The fuse ratings and further information to be observed can be found in the fuse assignment diagram.

Fuse assignment diagram: on the fuse box in the trunk (→ page 295).

- ⚠ **NOTE** Damage or malfunctions caused by moisture

Moisture may cause damage to the electrical system or cause it to malfunction.

- ▶ When the fuse box is open, make sure that no moisture can enter the fuse box.
- ▶ When closing the fuse box, make sure that the seal of the lid is positioned correctly on the fuse box.

If the newly inserted fuse also blows, have the cause traced and rectified at a qualified specialist workshop.

Ensure the following before replacing a fuse:

- The vehicle is secured against rolling away.
- All electrical consumers are switched off.
- The ignition is switched off.

The electrical fuses are located in various fuse boxes:

- Fuse box in the engine compartment on the driver's side (→ page 294)
- Fuse box on the driver's side of the cockpit (→ page 295)
- Fuse box in the front passenger footwell (→ page 295)

- Fuse box in the trunk on the right-hand side of the vehicle, when viewed in the direction of travel (→ page 295)

Opening and closing the fuse box in the engine compartment

Requirements:

- A dry cloth and a screwdriver are available.

Observe the notes on electrical fuses (→ page 293).

Opening

⚠ WARNING Risk of injury from using the windshield wipers while the engine hood is open

When the engine hood is open and the windshield wipers are set in motion, you can be trapped by the wiper linkage.

- ▶ Always switch off the windshield wipers and ignition before opening the engine hood.

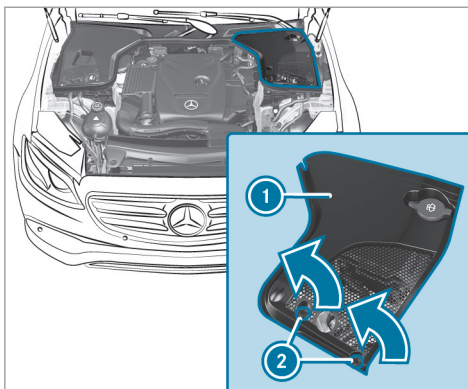

- ▶ Turn clips **2** on cover **1** counter-clockwise a quarter-turn.
- ▶ Pull cover **1** upwards in the direction of the arrow.

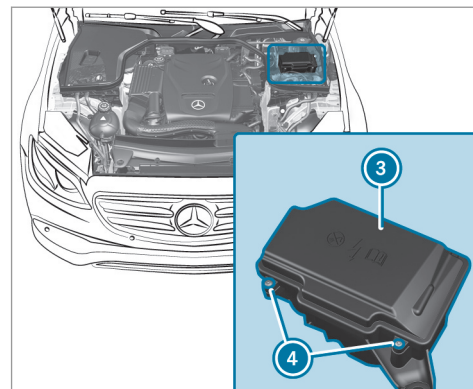

- ▶ Remove any existing moisture from the fuse box using a dry cloth.
- ▶ Loosen screws **4**, remove fuse box lid **3** from the top.

Closing

- ▶ Check whether the seal is positioned correctly in lid **3**.

- ▶ Insert lid ③ into the bracket at the rear of the fuse box.
- ▶ Fold down lid ③ of the fuse box and tighten screws ④.
- ▶ Insert cover ① on both sides.
- ▶ Turn clips ② on cover ① clockwise a quarter-turn.
- ▶ Close the hood.

Opening and closing the fuse box in the cockpit

The fuse box is on the side of the dashboard under a cover.

- ▶ Contact an authorized Mercedes-Benz Center for further information.

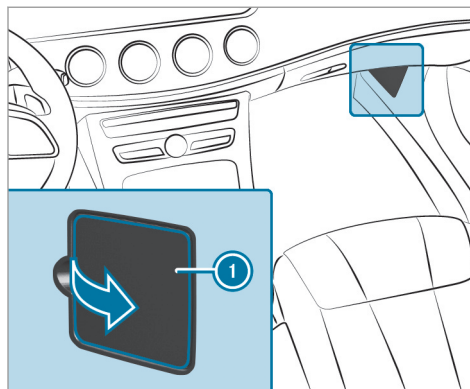

- ▶ Open cover ① in the direction of the arrow and remove it.

Opening and closing the fuse box in the trunk

Observe the notes on electrical fuses (→ page 293).

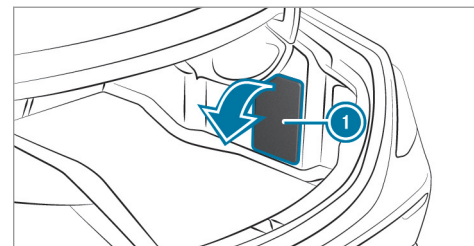

- ▶ Fold cover ① down in the direction of the arrow.

The fuse assignment diagram is in a recess on the side of the fuse box.

Notes on noise or unusual handling characteristics

Make sure there are no vibrations, noises or unusual handling characteristics when the vehicle is in motion. This may indicate that the wheels or tires are damaged. Hidden tire damage could also be causing the unusual handling characteristics.

If you suspect that a tire is malfunctioning, reduce your speed immediately and have the tires and wheels checked at a qualified specialist workshop.

Notes on regularly inspecting wheels and tires

⚠ WARNING Risk of injury through damaged tires

Damaged tires can cause tire pressure loss.

- ▶ Check the tires regularly for signs of damage and replace any damaged tires immediately.

⚠ WARNING Risk of hydroplaning due to insufficient tire tread

Insufficient tire tread will result in reduced tire grip.

In heavy rain or slush the risk of hydroplaning is increased, in particular where speed is not adapted to suit the conditions.

- ▶ Thus, you should regularly check the tread depth and the condition of the tread across the entire width of all tires.

Minimum tread depth for:

- Summer tires: $\frac{1}{8}$ in (3 mm)
- M+S tires: $\frac{1}{16}$ in (4 mm)
- ▶ For safety reasons, replace the tires before the legally-prescribed limit for the minimum tread depth is reached.

Carry out the following checks on all wheels regularly, at least once a month or as required, for example, prior to a long journey or driving off-road:

- Check the tire pressure (→ page 297).

- Visually inspect wheels and tires for damage.
- Check the valve caps.
- Visual check of the tire tread depth and the tire contact surface across the entire width.
The minimum tread depth for summer tires is $\frac{1}{8}$ in (3 mm) and for winter tires $\frac{1}{16}$ in (4 mm).

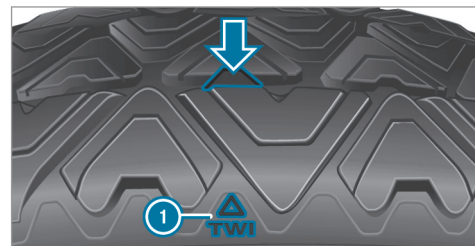

Six marks ① show where the bar indicators (arrow) are integrated into the tire tread. They are visible once a tire tread depth of approximately $\frac{1}{16}$ in (1.6 mm) has been reached.

Notes on snow chains

⚠ WARNING Risk of accident due to incorrect mounting of snow chains

If you have mounted snow chains to the front wheels, the snow chains may drag against the vehicle body or chassis components.

This could cause damage to the vehicle or the tires.

- ▶ Never mount snow chains on the front wheels.
- ▶ Only mount snow chains on the rear wheels in pairs.

Observe the following notes when using snow chains:

- Snow chains are only permissible for certain wheel/tire combinations. You can obtain information about this from an authorized Mercedes-Benz Center.
- For safety reasons, only use snow chains that have been specifically approved for your

vehicle by Mercedes-Benz, or snow chains with the same quality standard.

- If snow chains are installed, the maximum permissible speed is 30 mph (50 km/h).
 - **Vehicles with Active Parking Assist:** Do not use Active Parking Assist when snow chains are installed.
 - **Vehicles with level control:** If snow chains are installed, only drive at raised vehicle level (→ page 197).
- i** You can deactivate ESP® to pull away (→ page 165). This allows the wheels to spin, achieving an increased driving force.

Tire pressure

Notes on tire pressure

⚠ WARNING Risk of accident due to insufficient or excessive tire pressure

Tires with either too low or too high a pressure present the following hazards:

- the tires could burst
 - the tires could wear excessively and/or unevenly
 - the driving characteristics as well as steering and braking characteristics may be severely impaired
- ▶ Observe the recommended tire pressures and check the tire pressure of all tires including the spare wheel:
- monthly
 - if altering the load on the vehicle
 - prior to long journeys
 - if the operating conditions change, for example when driving off-road

- ▶ Adjust the tire pressure where necessary.

Tire pressure which is too high or too low can:

- Shorten the service life of the tires.
- Cause increased tire damage.
- Adversely affect driving characteristics and thus driving safety, e.g. due to hydroplaning.

⚠ WARNING Risk of accident due to too low a tire pressure

Tires with pressure that is too low can overheat and burst as a consequence.

In addition, they also suffer from irregular wear, which can significantly impair the braking properties and the handling characteristics.

- ▶ Avoid excessively low tire pressure.

Tire pressure which is too low can cause:

- Tire faults as a result of overheating
- Impaired handling characteristics
- Irregular wear

- Increased fuel consumption

⚠ WARNING Risk of accident due to too high a tire pressure

Tires with excessively high pressure can burst.

In addition, they also suffer from irregular wear, which can significantly impair the braking properties and the handling characteristics.

- ▶ Avoid excessively high tire pressures.

Tire pressure which is too high can cause:

- Increased braking distance
- Impaired handling characteristics
- Irregular wear
- Impaired driving comfort
- Susceptibility to damage

⚠ WARNING Risk of accident due to repeated pressure drop in the tires

The wheels, valves or tires could be damaged.

Too low a tire pressure can lead to the tires bursting.

- ▶ Examine the tires for foreign objects.
- ▶ Check whether the tire has a puncture or the valve has a leak.
- ▶ If you are unable to rectify the damage, contact a qualified specialist workshop.

You can find specifications for the tire pressure for the vehicle's factory-installed tires on the following labels:

- Tire and Loading Information placard on the B-pillar of your vehicle (→ page 304).
- Tire pressure table on the inside of the fuel filler flap (→ page 299).

Observe the maximum tire pressure (→ page 310).

Use a suitable pressure gauge to check the tire pressure. The outer appearance of a tire does not permit any reliable conclusion about the tire pressure.

Only correct tire pressure when the tires are cold. Conditions for cold tires:

- The vehicle has been parked with the tires out of direct sunlight for at least three hours.
- The vehicle has traveled less than 1 mile (1.6 km).

The vehicle's tires heat up when driving. As the temperature of the tires increases, so too does the tire pressure.

Vehicles with tire pressure monitoring system: You can also see the tire pressure in the driver's display.

The tire pressure recommended for increased load/speed in the tire pressure table can affect the ride comfort.

⚠ WARNING Risk of accident due to unsuitable accessories on tire valves

If you mount unsuitable accessories onto tire valves, the tire valves may be overloaded and malfunction, which can cause tire pressure loss.

- ▶ Only screw standard valve caps or valve caps specifically approved by Mercedes-Benz for your vehicle onto the tire valve.

Tire pressure table

The tire pressure table is on the inside of the fuel filler flap.

- ⓘ The data shown in the images is example data.

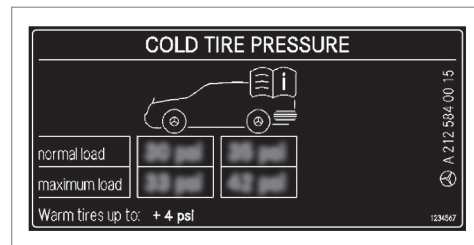

If one or more tire sizes precede a tire pressure, the following tire pressure information is only valid for those tire sizes and their respective load condition.

The load conditions "partially laden" and "fully laden" are defined in the table for different numbers of passengers and amounts of luggage. The actual number of seats may differ from this.

		kPa		psi	
R18	Front Left	230	33	230	33
	Front Right	230	33	230	33
R19	Front Left	230	33	230	33
	Front Right	230	33	230	33
M+S	Front Left	230	33	230	33
	Front Right	230	33	230	33

100 kPa = 1 bar

A 213 584 11 05

12MAY

Some tire pressure tables only show the rim diameter instead of the complete tire size, e.g. **R18**. The rim diameter is part of the tire size and can be found on the tire side wall (→ page 311).

- Tire and Loading Information placard (→ page 304)
- Maximum tire pressure (→ page 310)

Checking tire pressures manually

- ▶ Read the tire pressure for the current operating conditions from the Tire and Loading Information placard or the tire pressure table. Observe the notes on tire pressure.
- ▶ Remove the valve cap of the tire to be checked.
- ▶ Press the tire pressure gauge securely onto the valve.
- ▶ Read the tire pressure.
- ▶ If the tire pressure is lower than the recommended value, increase the tire pressure to the recommended value.
- ▶ If the tire pressure is higher than the recommended value, release air. To do so, press down the metal pin in the valve, e.g. using the tip of a pen, for example. Then check the tire pressure again using the tire pressure gauge.
- ▶ Screw the valve cap onto the valve.

Further related subjects:

- Notes on tire pressure (→ page 297)

- Tire pressure table (→ page 299)
- Tire and Loading Information placard (→ page 304)

Tire pressure monitoring system

Function of the tire pressure monitoring system

⚠ DANGER Risk of accident due to incorrect tire pressure

Each tire, including the spare (if provided), should be checked monthly when cold and then inflated to the inflation pressure recommended by the vehicle manufacturer on the vehicle placard or tire inflation pressure label. (If your vehicle has tires of a different size than the size indicated on the vehicle placard or tire inflation pressure label, you should determine the proper tire inflation pressure for these tires.)

As an added safety feature, your vehicle has been equipped with a tire pressure monitoring system (TPMS) that illuminates a low tire

pressure telltale when one or more of your tires is significantly underinflated. Accordingly, if the low tire pressure telltale illuminates, you should stop and check your tires as soon as possible, and inflate them to the proper pressure. Driving on a significantly underinflated tire causes the tire to overheat and can lead to tire failure. Underinflation also reduces fuel efficiency and tire tread life, and may affect the vehicle's handling and stopping ability. Please note that the TPMS is not a substitute for proper tire maintenance, and it is the driver's responsibility to maintain correct tire pressure, even if underinflation has not reached the level to trigger illumination of the TPMS low tire pressure telltale.

Your vehicle has also been equipped with a TPMS malfunction indicator to indicate when the system is not operating properly. The TPMS malfunction indicator is combined with the low tire pressure telltale. When the system detects a malfunction, the indicator lamp will flash for approximately a minute

and then remain continuously illuminated. This sequence will continue upon subsequent vehicle start-ups as long as the malfunction exists.

When the malfunction indicator is illuminated, the system may not be able to detect or signal low tire pressure as intended. TPMS malfunctions may occur for a variety of reasons, including the installation of incompatible replacement or alternate tires or wheels on the vehicle that prevent the TPMS from functioning properly.

Always check the TPMS malfunction telltale after replacing one or more tires or wheels on your vehicle to ensure that the replacement or alternate tires and wheels allow the TPMS to continue to function properly.

The system checks the tire pressure and the tire temperature of the tires installed on the vehicle by means of a tire pressure sensor.

The tire pressure and the tire temperature appear in the on-board computer (→ page 302).

If there is a substantial pressure loss or if the tire temperature is excessive, you will be warned in the following ways:

- via display messages (→ page 380).
- via the  warning lamp in the instrument cluster (→ page 399)

The tire pressure monitoring system is only an aid. It is the driver's responsibility to set the tire pressure to the recommended cold tire pressure suitable for the operating situation.

In most cases, the tire pressure monitoring system will automatically update the new reference values after you have changed the tire pressure. You can, however, also update the reference values by restarting the tire pressure monitoring system manually (→ page 399).

System limits

The system may be impaired or may not function particularly in the following situations:

- The tire pressure has been set incorrectly
- Sudden pressure loss caused by a foreign object penetrating the tire, for example

- There is a malfunction caused by another radio signal source

Checking the tire pressure with the tire pressure monitoring system

Requirements:

- The ignition is switched on.

On-board computer:

→ Service ► Tires

One of the following displays appears:

- Current tire pressure and tire temperature of the individual wheels:

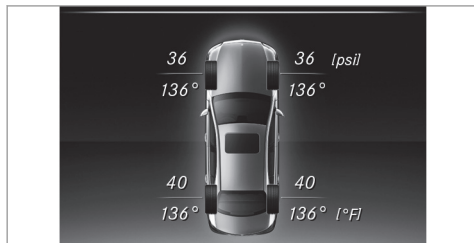

- **Tire pressure will be displayed after driving a few minutes**
- **Tire Pressure Monitor Active:** the teach-in process of the system is not yet complete. The tire pressures are already being monitored.

▶ Compare the tire pressure with the recommended tire pressure for the current operating condition (→ page 299). Observe the notes on tire temperature (→ page 297).

ⓘ The values displayed in the on-board computer may deviate from those of the tire pressure gauge as they refer to sea level. At high elevations, the tire pressure value indicated by a pressure gauge are higher than those shown by the on-board computer. In this case, do not reduce the tire pressure.

Restarting the tire pressure monitoring system

Requirements:

- The recommended tire pressure is correctly set for the respective operating status on all of the wheels (→ page 297).

Restart the tire pressure monitoring system in the following situations:

- The tire pressure has changed.
- The wheels or tires have been changed or newly installed.

On-board computer:

→ Service ► Tires

▶ Swipe downwards on Touch Control on the left-hand side of the steering wheel. The **Use Current Pressures as New Reference Values** message is shown in the multifunction display.

▶ To restart, press Touch Control on the left-hand side of the steering wheel. The **Tire Press. Monitor Restarted** message is shown in the multifunction display.

Current warning messages are deleted and the yellow  warning lamp goes out.

After you have been driving for a few minutes, the system checks whether the current tire pressures are within the specified range. The current tire pressures are then accepted as reference values and monitored.

Be sure to also pay attention to the following related topic:

- Notes on tire pressure (→ page 297)

Tire pressure loss warning system

Function of the tire pressure loss warning system

The tire pressure loss warning system warns the driver by means of display messages when there is a severe tire pressure loss.

System limits

The system may be impaired or may not function particularly in the following situations:

- Incorrectly set tire pressure
- Sudden pressure loss caused, for example, by a foreign object penetrating the tire
- Steady pressure loss in several tires

The system has a restricted or delayed function particularly in the following situations:

- Poor ground conditions, e.g. snow or gravel
- Driving with snow chains

- When adopting a very sporty driving style with high cornering speeds or sudden acceleration
- Driving with a high load

The tire pressure loss warning system is only an aid. It is the driver's responsibility to set the tire pressure to the recommended cold tire pressure suitable for the operating situation and to check it.

Be sure to also observe the following further related subjects:

- Notes on tire pressure (→ page 297)
- Display messages about the tires (→ page 380)

Restarting the tire pressure loss warning system

Requirements:

- The recommended tire pressure is correctly set for the respective operating status on all wheels.

Restart the tire pressure loss warning system in the following situations:

- The tire pressure has changed.
- The wheels or tires have been changed or newly installed.

On-board computer:

↳ [Service](#) ▶ [Tires](#)

- ▶ Swipe downwards on Touch Control on the left-hand side of the steering wheel. The [Tire Pressure Control System Active Restart](#) message is shown in the multifunction display.
- ▶ To begin restart, press Touch Control on the left-hand side of the steering wheel. The [Tire Pressure Now OK?](#) message is shown in the multifunction display.
- ▶ Select [Yes](#).
- ▶ To confirm restart, press Touch Control on the left-hand side of the steering wheel. The [Run Flat Indicator Restarted](#) message is shown in the multifunction display.

304 Wheels and tires

After you have driven for a few minutes, the tire pressure loss warning system monitors the set tire pressure of all the tires.

Be sure to also pay attention to the following related topic:

- Notes on tire pressure (→ page 297)

Loading the vehicle

Notes on Tire and Loading Information placard

⚠ WARNING Risk of accident from overloaded tires

Overloaded tires may overheat and burst as a consequence. Overloaded tires can also impair the steering and handling characteristics and lead to brake failure.

- ▶ Observe the load rating of the tires.
- ▶ The load rating must be at least half the permissible axle load of the vehicle.
- ▶ Never overload the tires by exceeding the maximum load.

The Tire and Loading Information placard is on the B-pillar on the driver's side of the vehicle.

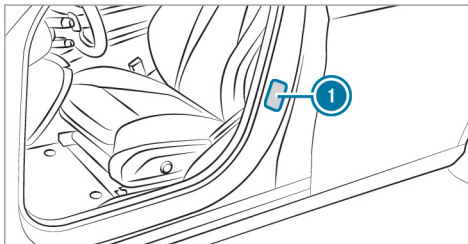

① Tire and Loading Information placard

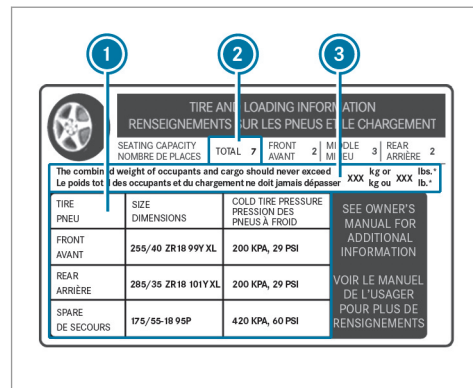

TIRE AND LOADING INFORMATION	
RENSEIGNEMENTS SUR LES PNEUS ET LE CHARGEMENT	
SEATING CAPACITY NOMBRE DE PLACES	TOTAL 7 FRONT AVANT 2 MIDDLE EU 3 REAR ARRIERE 2
The combined weight of occupants and cargo should never exceed XXX kg or XXX lbs. Le poids total des occupants et du chargement ne doit jamais dépasser XXX kg ou XXX lbs.	
TIRE PNEU	SIZE DIMENSIONS
FRONT AVANT	255/40 ZR18 99Y XL
REAR ARRIÈRE	285/35 ZR18 101Y XL
SPARE DE SECOURS	175/55-18 95P
COLD TIRE PRESSURE PRESSION DES PNEUS À FROID	
FRONT AVANT	200 KPA, 29 PSI
REAR ARRIÈRE	200 KPA, 29 PSI
SPARE DE SECOURS	420 KPA, 60 PSI
SEE OWNER'S MANUAL FOR ADDITIONAL INFORMATION VOIR LE MANUEL DE L'USAGER POUR PLUS DE RENSEIGNEMENTS	

① The data shown in the illustration is example data.

The Tire and Loading Information placard shows the following information:

- Maximum number of seats ② according to the maximum number of people permitted to travel in the vehicle.

- Maximum permissible load ③ comprises the gross weight of all vehicle occupants, load and luggage.
- Recommended tire pressure ① for cold tires. The recommended tire pressures are valid for the maximum permissible load and up to the maximum permissible vehicle speed.

Please also note:

- Information on permissible weights and loads on the vehicle identification plate (→ page 329).
- Information on tire pressure in the tire pressure table (→ page 299).

Further related subjects:

- Determining the maximum permissible load (→ page 305)
- Notes on tire pressure (→ page 297).

Steps for Determining Correct Load Limit

The following steps have been developed as required of all manufacturers under Title 49,

Code of U.S. Federal Regulations, Part 575, pursuant to the "National Traffic and Motor Vehicle Safety Act of 1966".

- ▶ (1): Locate the statement "The combined weight of occupants and cargo should never exceed XXX kg or XXX lbs." on your vehicle's placard.
- ▶ (2): Determine the combined weight of the driver and passengers that will be riding in your vehicle.
- ▶ (3): Subtract the combined weight of the driver and passengers from XXX kg or XXX lbs.
- ▶ (4): The resulting figure equals the available amount of cargo and luggage load capacity. For example, if the "XXX" amount equals 1,400 lbs. and there will be five 150 lb passengers in your vehicle, the amount of available cargo and luggage load capacity is 650 lbs. (1,400 - 750 (5 x 150) = 650 lbs.)
- ▶ (5): Determine the combined weight of luggage and cargo being loaded on the vehicle. That weight may not safely exceed the availa-

ble cargo and luggage load capacity calculated in Step 4.

- ▶ (6): If your vehicle will be towing a trailer, load from your trailer will be transferred to your vehicle. Consult this manual to determine how this reduces the available cargo and luggage load capacity of your vehicle.
- ⓘ Not all vehicles are permitted to tow a trailer. Towing a trailer is only permitted if a trailer-hitch is installed. Please consult an authorized Mercedes-Benz dealer if you have any questions about towing a trailer with your vehicle.

Even if you have calculated the total load carefully, you should still make sure that the maximum permissible gross weight and the maximum gross axle weight rating of your vehicle are not exceeded. Details can be found on the vehicle identification plate.

306 Wheels and tires

- ▶ Have your loaded vehicle – including driver, occupants and load – weighed on a vehicle weighbridge.
The measured values may not exceed the maximum permissible values stated on the vehicle identification plate.

Further related subjects:

- Calculation example for determining the maximum load (→ page 306)

- Tire and Loading Information placard (→ page 304)
- Tire pressure table (→ page 299)
- Vehicle identification plate (→ page 329)

Calculation example for determining the maximum load

The following table shows examples of how to calculate total and load capacities with varying

seating configurations and different numbers and sizes of occupants. The following examples use a maximum load of 1500 lbs (680 kg). **This is for illustration purposes only.** Make sure you are using the actual load limit for your vehicle stated on your vehicle's Tire and Loading Information placard (→ page 304).

The higher the weight of all the occupants, the smaller the maximum load for luggage.

Step 1

	Example 1	Example 2
Combined maximum weight of occupants and load (data from the Tire and Loading Information placard)	1500 lbs (680 kg)	1500 lbs (680 kg)

Step 2

	Example 1	Example 2
Number of people in the vehicle (driver and occupants)	5	1
Distribution of the occupants	Front: 2 Rear: 3	Front: 1
Weight of occupants	Occupant 1: 150 lbs (68 kg) Occupant 2: 180 lbs (82 kg) Occupant 3: 160 lbs (73 kg) Occupant 4: 140 lbs (63 kg) Occupant 5: 120 lbs (54 kg)	Occupant 1: 200 lbs (91 kg)
Total weight of all occupants	750 lbs (340 kg)	200 lbs (91 kg)

Step 3

	Example 1	Example 2
Permissible load (maximum gross vehicle weight rating from the Tire and Loading Information placard minus the gross weight of all occupants)	$1500 \text{ lbs (680 kg)} - 750 \text{ lbs (340 kg)} = 750 \text{ lbs (340 kg)}$	$1500 \text{ lbs (680 kg)} - 200 \text{ lbs (91 kg)} = 1300 \text{ lbs (589 kg)}$

Tire labeling

Overview of tire labeling

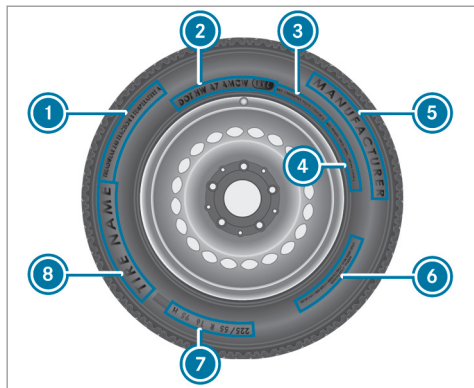

- ① Uniform Tire Quality Grading Standards (→ page 308)
- ② DOT (Department of Transportation), (TIN) Tire Identification Number (→ page 309)
- ③ Maximum tire load (→ page 310)
- ④ Maximum tire pressure (→ page 310)

- ⑤ Manufacturer
 - ⑥ Characteristics of the tire (→ page 311)
 - ⑦ Tire size designation, load-bearing capacity, speed rating and load index (→ page 311)
 - ⑧ Tire name
- ① The data shown in the illustration is example data.

Tire Quality Grading

In accordance with the US Department of Transportation's "Uniform Tire Quality Grading Standards", tire manufacturers are required to grade their tires on the basis of the following three performance factors:

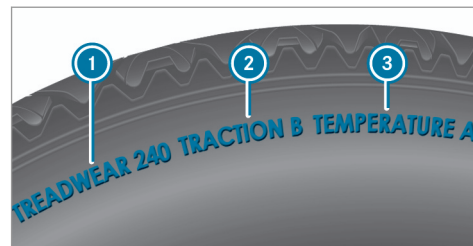

- ① Tread wear grade
 - ② Traction grade
 - ③ Temperature grade
- ① The data shown in the illustration is example data.
- ① The classification is not legally stipulated for Canada, but it is generally stated.

Tread wear grade

The treadwear grade is a comparative rating based on the wear rate of the tire when tested under controlled conditions on a specified government test course. For example, a tire graded 150 would wear one and one-half (1 1/2) times

as well on the government course as a tire graded 100.

The relative performance of tires depends upon the actual conditions of their use, however, and may depart significantly from the norm due to variations in driving habits, service practices and differences in road characteristics and climate conditions.

Traction grade

⚠ DANGER Risk of accident due to inadequate traction

The traction grade assigned to this tire is based on straight-ahead braking traction tests.

- ▶ Always adapt your driving style and drive at a speed to suit the prevailing traffic and weather conditions.

! NOTE Damage to the drivetrain from wheelspin

- ▶ Avoid wheelspin.

The traction grades, from highest to lowest, are AA, A, B and C. Those grades represent the tire's ability to stop on wet pavement as measured under controlled conditions on specified government test surfaces of asphalt and concrete. A tire marked C may have poor traction performance.

Temperature grade

⚠ WARNING Risk of accident from tire overheating and tire failure

Excessive speed, underinflation, or excessive loading, either separately or in combination, can cause excessive heat build-up and possible tire failure.

- ▶ Observe the recommended tire pressure.
- ▶ Regularly check the pressure of all the tires.
- ▶ Adjust the tire pressure, if necessary.

The temperature grades are A (the highest), B and C, representing the tire's resistance to the generation of heat and its ability to dissipate

heat when tested under controlled conditions on a specified indoor laboratory test wheel. Sustained high temperature can cause the material of the tire to degenerate and reduce tire life, and excessive temperature can lead to sudden tire failure. The grade C corresponds to a level of performance which all passenger car tires must meet under the Federal Motor Safety Standard No. 109. Grades B and A represent higher levels of performance on the laboratory test wheel than the minimum required by law.

DOT, Tire Identification Number (TIN)

US tire regulations stipulate that every tire manufacturer or retreader must imprint a TIN in or on the side wall of each tire produced.

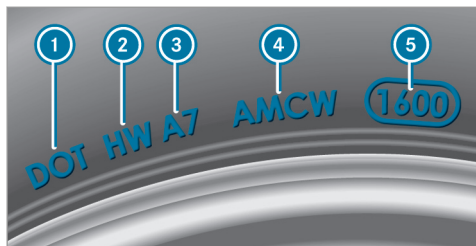

i The data shown in the image is example data.

The TIN is a unique identification number to identify tires and comprises the following:

- **DOT (Department of Transportation):** tire symbol marks **1** indicating that the tire complies with the requirements of the US Department of Transportation.
- **Manufacturer identification code:** manufacturer identification code **2** contains details of the tire manufacturer. New tires have a code with two symbols. Retreaded tires have a code with four symbols. Further information on retreaded tires (→ page 316).

- **Tire size:** identifier **3** describes the tire size.
- **Tire type code:** tire type code **4** can be used by the manufacturer as a code to describe specific characteristics of the tire.
- **Manufacturing date:** manufacturing date **5** provides information about the age of a tire. The 1st and 2nd positions represent the calendar week and the 3rd and 4th positions state the year of manufacture (e.g. "3208" represents the 32nd week of 2008).

Information on the maximum tire load

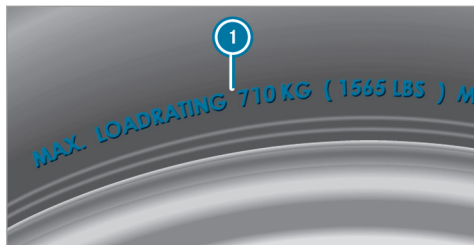

i The data shown in the image is example data.

Maximum tire load **1** is the maximum permissible weight for which the tire is approved.

Do not overload the tires by exceeding the specified load limit. The maximum permissible load can be found on the vehicle's Tire and Loading Information placard on the B-pillar on the driver's side (→ page 304).

Specifications for maximum tire pressure



i The data shown in the illustration is example data.

Never exceed maximum tire pressure ❶ specified for the tire. Always observe the recommended tire pressure for your vehicle when adjusting the tire pressure (→ page 299).

Information on tire characteristics



❶ The data shown in the image is example data.

This information describes the type of tire cord and the number of layers in side wall ❶ and under tire tread ❷.

Tire size designation, load-bearing capacity, speed rating and load index

⚠ WARNING Risk of injury through exceeding the specified tire load-bearing capacity or the permissible speed rating

Exceeding the specified tire load rating or the permissible speed rating may lead to tire damage and to the tires bursting.

- ▶ Therefore, only use tire types and sizes approved for your vehicle model.
- ▶ Observe the tire load rating and speed rating required for your vehicle.

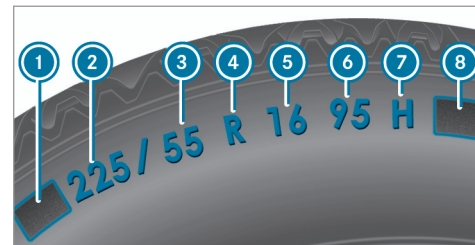

- ❶ First letter(s)
- ❷ Nominal tire width in millimeters
- ❸ Aspect ratio in %
- ❹ Tire code
- ❺ Rim diameter
- ❻ Load-bearing index
- ❼ Speed rating
- ❽ Load index

❶ The data shown in the illustration is example data.

Information about reading tire data can be obtained from any qualified specialist workshop.

First letter(s) ①:

- Without: passenger vehicle tires according to European manufacturing standards.
- "P": passenger vehicle tires according to US manufacturing standards.
- "LT": light truck tires according to US manufacturing standards.
- "T": compact emergency spare wheels with high tire pressure that are only designed for temporary use in an emergency.

Aspect ratio ④:

Ratio between tire height and tire width in percent (tire height divided by tire width).

Tire code ④ (tire type):

- "R": radial tire
- "D": bias ply tire
- "B": bias belted tires
- "ZR": radial tire with a maximum speed above 149 mph (240 km/h) (optional)

Rim diameter ⑤:

The diameter of the bead seat (not the diameter of the rim flange). The rim diameter is specified in inches (in).

Load-bearing index ⑥:

Numerical code that specifies the maximum load-bearing capacity of a tire (e.g. "91" corresponds to 1356 lbs (615 kg)).

The load-bearing capacity of the tire must be at least half the gross axle weight rating of your vehicle. Do not overload the tires by exceeding the specified load limit.

See also:

- Maximum permissible load on the Tire and Loading Information placard (→ page 304)
- Maximum tire load (→ page 310)
- Load index

Speed rating ⑦:

Specifies the approved maximum speed of the tire.

① An electronic speed limiter prevents your vehicle from exceeding a speed of 130 mph (210 km/h).

Make sure that your tires have the required speed rating. You can obtain information on the required speed rating from an authorized Mercedes-Benz Center.

Summer tires

Index	Speed rating
Q	up to 100 mph (160 km/h)
R	up to 106 mph (170 km/h)
S	up to 112 mph (180 km/h)
T	up to 118 mph (190 km/h)
H	up to 130 mph (210 km/h)
V	up to 149 mph (240 km/h)
W	up to 168 mph (270 km/h)
Y	up to 186 mph (300 km/h)

Index	Speed rating
ZR...Y ¹	up to 186 mph (300 km/h)
ZR...(..Y) ¹	over 186 mph (300 km/h)
ZR ¹	over 149 mph (240 km/h)

- Specifying the speed rating as the "ZR" index in tire code ④ is optional for tires up to 186 mph (300 km/h).
- If your tire code ④ includes "ZR" and there is no speed rating ⑦, find out what the maximum speed is from the tire manufacturer.
- If load-bearing index ⑥ and speed rating ⑦ are in brackets, the maximum speed rating of your tire is above 186 mph (300 km/h). To find out the maximum speed, ask the tire manufacturer.

¹ "ZR" stated in the tire code.

² Or "M+S"  " for winter tires.

All-weather tires and winter tires

Index	Speed rating
Q M+S ²	up to 100 mph (160 km/h)
T M+S ²	up to 118 mph (190 km/h)
H M+S ²	up to 130 mph (210 km/h)
V M+S ²	up to 149 mph (240 km/h)

Winter tires bear the  snowflake symbol and fulfill the requirements of the Rubber Manufacturers Association (RMA) and the Rubber Association of Canada (RAC) regarding the tire traction on snow.

Load index ⑧:

- No specification given: standard load (SL) tire
- "XL" or "Extra Load": extra load tire or reinforced tire
- "Light Load": light load tire

- "C", "D", "E": a load range that depends on the maximum load that the tire can carry at a certain pressure

Definition of terms for tires and loading

Tire structure and characteristics: describes the number of layers or the number of rubber-coated belts in the tire contact surface and the tire wall. These are made of steel, nylon, polyester and other materials.

Bar: metric unit for tire pressure. 14.5038 pounds per square inch (psi) and 100 kilopascal (kPa) is the equivalent of one bar.

DOT (Department of Transportation): DOT-marked tires fulfill the requirements of the US Department of Transportation.

Average weight of the vehicle occupants: the number of vehicle occupants for which the vehicle is designed, multiplied by 150 lb (68 kg).

Uniform Tire Quality Grading Standards: a uniform standard to grade the quality of tires with regard to tread quality, tire traction and temperature characteristics. The quality grading assessment is made by the manufacturer following specifications from the U.S. government. The quality grade of a tire is imprinted on the side wall of the tire.

Recommended tire pressure: the recommended tire pressure is the tire pressure specified for the tires mounted to the vehicle at the factory.

The tire and information table contains the recommended tire pressures for cold tires, the maximum permissible load and the maximum permissible vehicle speed.

The tire pressure table contains the recommended tire pressures for cold tires under various operating conditions, i.e. loading and/or speed of the vehicle.

Increased vehicle weight due to optional equipment: the combined weight of all standard and optional equipment available for the vehicle,

regardless of whether it is actually installed on the vehicle or not.

Rim: the part of the wheel on which the tire is installed.

GAWR (Gross Axle Weight Rating): the GAWR is the maximum permissible axle load. The actual load on an axle must never exceed the gross axle weight rating. The gross axle weight rating can be found on the vehicle identification plate on the B-pillar on the driver's side.

Speed rating: the speed rating is part of the tire identification. It specifies the speed range for which a tire is approved.

GVW (Gross Vehicle Weight): the gross vehicle weight comprises the weight of the vehicle including fuel, tools, the spare wheel, accessories installed, occupants, luggage and the trailer drawbar noseweight, if applicable. The gross vehicle weight must not exceed the gross vehicle weight rating GVWR as specified on the vehicle identification plate on the B-pillar on the driver's side.

GVWR (Gross Vehicle Weight Rating): the GVWR is the maximum permitted gross weight

of the fully laden vehicle (weight of the vehicle including all accessories, occupants, fuel, luggage and the trailer drawbar noseweight if applicable). The gross vehicle weight rating is specified on the vehicle identification plate on the B-pillar on the driver's side.

Maximum weight of the laden vehicle: the maximum weight is the sum of the curb weight of the vehicle, the weight of the accessories, the maximum load and the weight of optional equipment installed at the factory.

Kilopascal (kPa): metric unit for tire pressure. 6.9 kPa corresponds to 1 psi. Another unit for tire pressure is bar. 100 kilopascal (kPa) equals 1 bar.

Load index: in addition to the load-bearing index, the load index may also be imprinted on the side wall of the tire. This specifies the load-bearing capacity of the tire more precisely.

Curb weight: the weight of a vehicle with standard equipment including the maximum capacity of fuel, oil and coolant. It also includes the air conditioning system and optional equipment if

these are installed on the vehicle, but does not include passengers or luggage.

Maximum tire load: the maximum tire load is the maximum permissible weight in kilograms or lbs for which a tire is approved.

Maximum permissible tire pressure: maximum permissible tire pressure for one tire.

Maximum load on one tire: maximum load on one tire. This is calculated by dividing the maximum axle load of one axle by two.

PSI (pounds per square inch): standard unit of measurement for tire pressure.

Aspect ratio: ratio between tire height and tire width in percent.

Tire pressure: pressure inside the tire applying an outward force to every square inch of the tire. The tire pressure is specified in pounds per square inch (psi), in kilopascals (kPa) or in bar. The tire pressure should only be corrected when the tires are cold.

Cold tire pressure: the tires are cold when the vehicle has been parked for at least 3 hours

without direct sunlight on the tires or the vehicle has been driven for less than 1 mile (1.6 km).

Tire contact surface: the part of the tire that comes into contact with the road.

Tire bead: the purpose of the tire bead is to ensure that the tire sits securely on the wheel rim. There are several wire cores in the tire bead to prevent the tire from changing length on the wheel rim.

Side wall: the part of the tire between the tread and the tire bead.

Weight of optional equipment: the combined weight of the optional equipment weighing more than the replaced standard parts and more than 5 lbs (2.3 kg). This optional equipment, such as high-performance brakes, level control system, a roof luggage rack or high-performance batteries, is not included in the curb weight and the weight of the accessories.

TIN (Tire Identification Number): a unique identification number which can be used by a tire manufacturer to identify tires, for example, in a product recall, and thus identify the purchasers. The TIN is made up of the manufactur-

er's identity code, tire size, tire type code and the manufacturing date.

Load-bearing index: the load-bearing index is a code that contains the maximum load-bearing capacity of a tire.

Traction: traction is the grip resulting from friction between the tires and the road surface.

Wear indicator: narrow bars (tread wear bars) that are distributed over the tire contact surface. If the tire tread is level with the bars, the wear limit of 1/16 in (1.6 mm) has been reached.

Distribution of vehicle occupants: distribution of vehicle occupants over designated seat positions in a vehicle.

Maximum permissible payload weight: nominal load and luggage load plus 150 lb (68 kg) multiplied by the number of seats in the vehicle.

Changing a wheel

Notes on selecting, installing and replacing tires

! **NOTE** Mercedes-AMG vehicles

- ▶ Observe the notes in the Supplement. You could otherwise fail to recognize dangers.

⚠ **WARNING** Risk of accident due to incorrect dimensions of wheels and tires

If wheels and tires of the wrong size are installed, the wheel brakes or wheel suspension components may be damaged.

- ▶ Always replace wheels and tires with those that fulfill the specifications of the original part.

When replacing wheels, make sure to fit the correct:

- Designation
- Model

When replacing tires, make sure to install the correct:

- Designation
- Manufacturer
- Model

⚠ **WARNING** Risk of injury through exceeding the specified tire load-bearing capacity or the permissible speed rating

Exceeding the specified tire load rating or the permissible speed rating may lead to tire damage and to the tires bursting.

- ▶ Therefore, only use tire types and sizes approved for your vehicle model.
- ▶ Observe the tire load rating and speed rating required for your vehicle.

! **NOTE** Vehicle and tire damage through tire types and sizes that have not been approved

For safety reasons, only use tires, wheels and accessories which have been specially approved by Mercedes-Benz for your vehicle.

These tires are specially adapted to the control systems, such as ABS, ESP® and 4MATIC, and marked as follows:

- MO = Mercedes-Benz Original
- MOE = Mercedes-Benz Original Extended (run-flat tire only for certain wheels)
- MO1 = Mercedes-Benz Original (only certain AMG tires)

Certain characteristics, such as handling, vehicle noise emissions, consumption, etc. may otherwise be adversely affected. Furthermore, other tire sizes could result in the tires rubbing against the body and axle components when loaded. This could result in damage to the tire or the vehicle.

Only use tires, wheels and accessories that have been checked and recommended by Mercedes-Benz.

! **NOTE** Risk to driving safety from retreaded tires

Retreaded tires are neither tested nor recommended by Mercedes-Benz, since previous damage cannot always be detected on retreaded tires.

For this reason driving safety cannot be guaranteed.

- ▶ Do not use used tires if you have no information about their previous usage.

! **NOTE** Possible damage to wheels or tires when driving over obstacles

Large wheels have a lower tire section width. The lower the tire section width, the greater is the risk of damage to wheels or tires when driving over obstacles.

- ▶ Avoid obstacles or drive particularly carefully.

! **NOTE** Possible wheel and tire damage when parking on curbs or in potholes

Parking on curbs or in potholes may damage the wheels and tires.

- ▶ If possible, park only on flat surfaces.
- ▶ Avoid curbs and potholes when parking.

! **NOTE** Damage to electronic component parts from the use of tire-mounting tools

Vehicles with a tire pressure monitoring system: Electronic component parts are located in the wheel. Tire-mounting tools should not be used in the area of the valve.

This could otherwise damage the electronic component parts.

- ▶ Have the tires changed at a qualified specialist workshop only.

! **NOTE** Damage to summer tires at low ambient temperatures

At low ambient temperatures, tears could form when driving with summer tires, causing permanent damage to the tire.

- ▶ At temperatures below 45 °F (7 °C) use  M+S- tires.

Accessory parts that are not approved for your vehicle by Mercedes-Benz or are not being used correctly can impair the operating safety.

Before purchasing and using non-approved accessories, visit a qualified specialist workshop and inquire about:

- Suitability
- Legal stipulations
- Factory recommendations

! **WARNING** Risk of accident with high performance tires

The special tire tread in combination with the optimized tire compound means that the risk

of skidding and hydroplaning on wet roads is increased.

In addition, the tire grip is greatly reduced at a low outside temperature and tire running temperature.

- ▶ Switch on the ESP® and adapt your driving style accordingly.
- ▶ Use  M+S tires at outside temperatures of less than 50 °F (10 °C).
- ▶ Only use the tires for their intended purpose.



Observe the following when selecting, installing and replacing tires:

- Furthermore, the use of certain tire types in certain regions and areas of operation can be highly beneficial.
- Only use tires and wheels of the same type (summer tires, winter tires, MOExtended tires) and the same make.
- Only install wheels of the same size on one axle (left and right).

It is only permissible to install a different wheel size in the event of a flat tire in order to drive to the specialist workshop.

- **Vehicles with a tire pressure monitoring system:** All installed wheels must be equipped with functioning sensors for the tire pressure monitoring system.
- At temperatures below 45 °F (7 °C) use winter tires or all-season tires marked  M+S for all wheels.

Winter tires provide the best possible grip in wintry road conditions.

- For  M+S tires, only use tires with the same tread.
- Observe the maximum permissible speed for the  M+S tires installed.
If the tire's maximum speed is below that of the vehicle, this must be indicated by an appropriate label in the driver's field of vision.
- Break in new tires at moderate speeds for the first 60 miles (100 km).

- Replace the tires after six years at the latest, regardless of wear.
- **When replacing with tires that do not feature run-flat characteristics:** vehicles with MOExtended tires are not equipped with a TIREFIT kit at the factory. Equip the vehicle with a TIREFIT kit after replacing with tires that do not feature run-flat characteristics, e.g. winter tires.

For more information on wheels and tires, contact a qualified specialist workshop.

Be sure to also observe the following further related subjects:

- Notes on tire pressure (→ page 297)
- Tire and Loading Information placard (→ page 304)
- Tire size designation, load-bearing capacity, speed rating and load index (→ page 311)
- Tire pressure table (→ page 299)
- Notes on the emergency spare wheel (→ page 325)

Notes on rotating wheels

⚠ WARNING Risk of injury through different wheel sizes

Rotating the front and rear wheels can severely impair the driving characteristics. The wheel brakes or suspension components may also be damaged.

- ▶ Rotate front and rear wheels only if the wheels and tires are of the same dimensions.

The wear patterns on the front and rear wheels differ:

- Front wheels wear more on the tire shoulder
- Rear wheels wear more in the center of the tire

Do not drive with tires that have too little tread depth. This significantly reduces traction on wet roads (hydroplaning).

On vehicles that have the same size front and rear wheels, rotate the wheels according to the intervals in the tire manufacturer's warranty

book in your vehicle documents. If this is not available, rotate the tires every 3000 to 6000 miles (5000 to 10,000 km), depending on the wear. Ensure that the direction of rotation is maintained.

Observe the instructions and safety notes on "Changing a wheel" when doing so (→ page 320).

Notes on storing wheels

When storing wheels, observe the following notes:

- After removing wheels, store them in a cool, dry and preferably dark place.
- Protect the tires from contact with oil, grease or fuel.

Overview of the tire-change tool kit

! NOTE Mercedes-AMG vehicles

- ▶ Observe the notes in the Supplement. You could otherwise fail to recognize dangers.

Apart from some country-specific variants, vehicles are not equipped with a tire-change tool kit. For more information on which tire-changing tools are required and approved for performing a wheel change on your vehicle, consult a qualified specialist workshop.

You require the following tools, for example, to change a wheel:

- Jack
- Chock
- Lug wrench
- Alignment bolt

The tire-change tool kit is located under the trunk floor.

320 Wheels and tires

- i Depending on the model, the tire change tool kit may be located at other positions under the trunk floor.

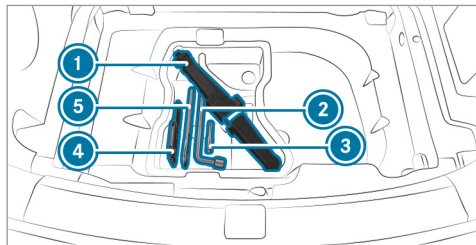

- 1 Jack
- 2 Lug wrench
- 3 Alignment bolt
- 4 Folding chock
- 5 Ratchet for jack

Preparing the vehicle for a wheel change

Requirements:

- The required tire-change tool is available. If your vehicle is not equipped with the tire-

change tool kit, consult a qualified specialist workshop to find out about suitable tools.

- The vehicle is not on a slope.
 - The vehicle is on solid, non-slippery and level ground.
- ▶ Apply the electric parking brake manually.
 - ▶ Move the front wheels to the straight-ahead position.
 - ▶ **Vehicles with automatic transmission:** Shift into position **P**.
 - ▶ **Vehicles with level control system:** Set the normal vehicle level (→ page 197).
 - ▶ Switch off the engine.
 - ▶ Make sure that the engine cannot be started.
 - ▶ Place chocks or other suitable items under the front and rear of the wheel that is diagonally opposite the wheel you wish to change.
 - ▶ Remove the hub caps if necessary (→ page 320).
 - ▶ Raise the vehicle (→ page 321).

Removing and installing the wheel trim/hub caps

Requirements:

- The vehicle is prepared for a wheel change (→ page 320).

Plastic hub cap

- ▶ **To remove:** turn the center cover of the hub cap counter-clockwise and remove the hub cap.
- ▶ **To install:** make sure that the center cover of the hub cap is turned counter-clockwise.
- ▶ Position the hub cap and turn the center cover clockwise until the hub cap engages physically and audibly.

Aluminum hub cap

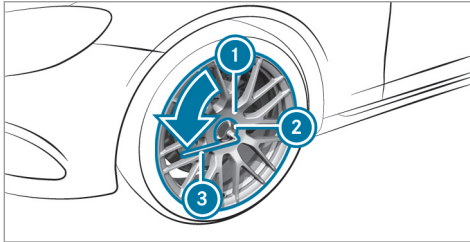

- ▶ **To remove:** position socket ② from the tire-change tool kit on hub cap ①.
 - ▶ Position wheel wrench ③ on socket ②.
 - ▶ Using wheel wrench ③, turn hub cap ① counter-clockwise and remove it.
 - ▶ **To install:** follow the instructions above in reverse order.
- i** **Specified tightening torque:** 18 lb-ft (25 Nm).

Raising the vehicle when changing a wheel

Requirements:

- There are no persons in the vehicle.
- The vehicle has been prepared for a wheel change (→ page 320).
- The wheel trims and hub caps have been removed (→ page 320).

Important notes on using the jack:

- Use only a vehicle-specific jack that has been approved by Mercedes-Benz to raise the vehicle.
- The jack is only designed for raising and holding the vehicle for a short time while a wheel is being changed and not for maintenance work under the vehicle.
- The jack must be placed on a firm, flat and non-slip surface. If necessary, use a large, flat, load-bearing, non-slip underlay.
- The foot of the jack must be positioned vertically under the jack support point.

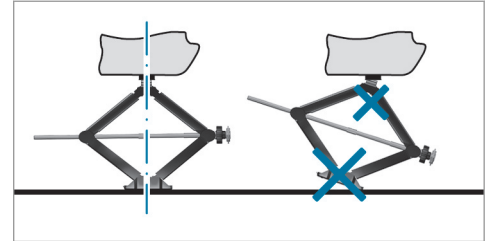

Rules of conduct when the vehicle is raised:

- Never place your hands or feet under the vehicle.
- Never lie under the vehicle.
- Do not start the engine and do not release the electric parking brake.
- Do not open or close any doors or the trunk lid.

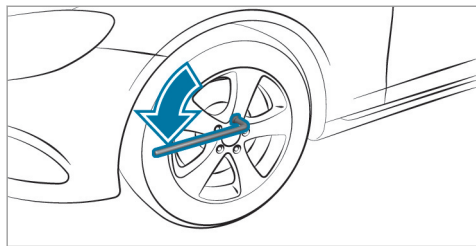

- ▶ Using the lug wrench, loosen the wheel bolts on the wheel you wish to change by about one full turn. Do not unscrew the bolts completely.

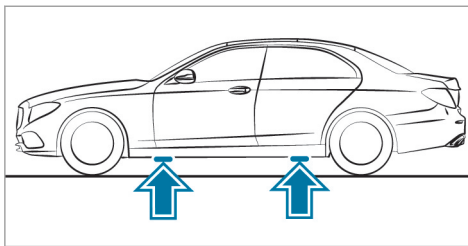

Position of jack support points

! **NOTE** Mercedes-AMG vehicles

- ▶ Observe the notes in the Supplement. You could otherwise fail to recognize dangers.

! **WARNING** Risk of injury from incorrect positioning of the jack

If you do not position the jack correctly at the appropriate jacking point of the vehicle, the jack could tip with the vehicle raised.

- ▶ Only position the jack at the appropriate jacking point of the vehicle. The base of the jack must be positioned vertically under the jacking point of the vehicle.

! **NOTE** Vehicle damage from the jack

If you do not position the jack correctly at the appropriate jack support point of the vehicle, the jack could tip over with the vehicle raised.

- ▶ The jack is designed exclusively for jacking up the vehicle at the jack support points.

- ▶ Take the ratchet out of the tire-change tool kit and place it on the hexagon nut of the jack so that the letters "AUF" are visible.

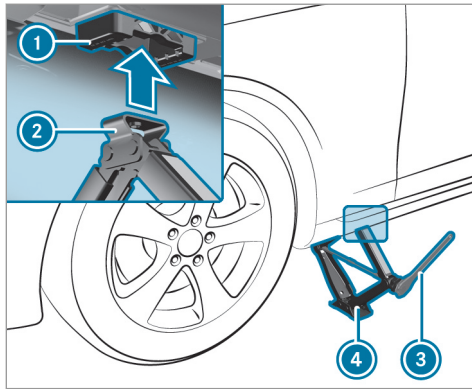

- ▶ Position support ② of jack ④ on jack support point ①.
- ▶ Turn ratchet ③ clockwise until support ② sits completely on jack support point ① and the base of the jack lies evenly on the ground.
- ▶ Turn ratchet ③ until the tire is raised a maximum of 1.2 in (3 cm) from the ground.
- ▶ Loosen and remove the wheel (→ page 323).

Removing a wheel

Requirements:

- The vehicle is raised (→ page 321).

! NOTE Mercedes-AMG vehicles

- ▶ Observe the notes in the Supplement. You could otherwise fail to recognize dangers.

When changing a wheel, avoid applying any force to the brake discs, since this could impair the level of comfort when braking.

! NOTE Damage to threading from dirt on wheel bolts

- ▶ Do not place wheel bolts in sand or on a dirty surface.

- ▶ Unscrew the uppermost wheel bolt completely.

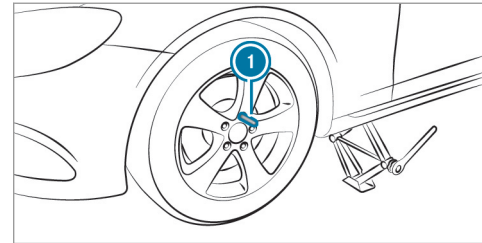

- ▶ Screw alignment bolt ① into the thread instead of the wheel bolt.
- ▶ Unscrew the remaining wheel bolts completely.
- ▶ Remove the wheel.

Mounting a new wheel

! NOTE Mercedes-AMG vehicles

- ▶ Observe the notes in the Supplement. You could otherwise fail to recognize dangers.

⚠ WARNING Risk of accident from losing a wheel

Oiled, greased or damaged wheel bolt/wheel nut threads or wheel hub/wheel mounting bolt threads can cause the wheel bolts/wheel nuts to come loose.

- ▶ Never oil or grease the threads.
- ▶ In the event of damage to the threads, contact a qualified specialist workshop immediately.
- ▶ Have the damaged wheel bolts or damaged hub threads replaced.
- ▶ Do not continue driving.

- ▶ Observe the information on the choice of tires (→ page 316).

For tires with a specified direction of rotation, an arrow on the side wall of the tire indicates the correct direction of rotation. Observe the direction of rotation when installing.

- ▶ Slide the wheel to be mounted onto the alignment bolt and push it on.

⚠ WARNING Risk of injury from tightening wheel bolts and nuts

If you tighten the wheel bolts or wheel nuts when the vehicle is raised, the jack could tip.

- ▶ Only tighten wheel bolts or wheel nuts when the vehicle is on the ground.

- ▶ Be sure to observe the instructions and safety notes on "Changing a wheel" (→ page 316).
- ▶ For safety reasons, only use wheel bolts which have been approved by Mercedes-Benz and for the wheel in question.

! NOTE Damage to paintwork of the wheel rim when screwing on the first wheel bolt

If the wheel has too much play when screwing in the first wheel bolt, the wheel rim paint can be damaged.

- ▶ Press the wheel firmly against the wheel hub when screwing on the first wheel bolt.

- ▶ Tighten the wheel bolts evenly in a diagonal pattern in the order indicated until they are finger-tight.
- ▶ Unscrew and remove the alignment bolt.
- ▶ Tighten the last wheel bolt until it is finger-tight.
- ▶ Lower the vehicle (→ page 324).

Lowering the vehicle after a wheel change

Requirements:

- The new wheel has been installed (→ page 323).
- ▶ **To lower the vehicle:** place the ratchet onto the hexagon nut of the jack so that the letters "AB" are visible and turn counter-clockwise.

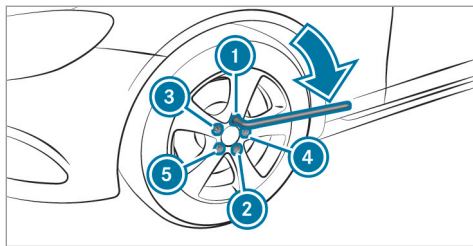

- ▶ Tighten the wheel bolts evenly in a diagonal pattern in the order indicated ① to ⑤ with an initial maximum force of 59 lb-ft (80 Nm).
- ▶ Tighten the wheel bolts evenly in a diagonal pattern in the order indicated ① to ⑤ to the specified tightening torque of 111 lb-ft (150 Nm).

⚠ WARNING Risk of accident due to incorrect tightening torque

The wheels could come loose if the wheel bolts or wheel nuts are not tightened to the prescribed torque.

- ▶ Ensure that the wheel bolts or wheel nuts are tightened to the prescribed tightening torque.
- ▶ If you are not sure, do not move the vehicle. Contact a qualified specialist workshop and have the tightening torque checked immediately.

- ▶ Check the tire pressure of the newly installed wheel and adjust it if necessary.
- ▶ **Vehicles with tire pressure loss warning system:** Restart the tire pressure loss warning system (→ page 303).
Exception: the new wheel is an emergency spare wheel.
- ▶ **Vehicles with a tire pressure monitoring system:** Restart the tire pressure monitoring system (→ page 302).
Exception: the new wheel is an emergency spare wheel.

Emergency spare wheel

Notes on the emergency spare wheel

⚠ WARNING Risk of accident caused by incorrect wheel and tire dimensions

The wheel or tire size and the tire type of the emergency spare wheel or spare wheel and the wheel to be replaced may differ. The emergency spare wheel or spare wheel can significantly impair driving characteristics of the vehicle.

To prevent hazardous situations:

- ▶ Adapt your driving style accordingly and drive carefully.
- ▶ Never install more than one emergency spare wheel or spare wheel that differs in size.
- ▶ Only use an emergency spare wheel or spare wheel of a different size briefly.
- ▶ Do not switch off ESP®.
- ▶ Have the emergency spare wheel or spare wheel of a different size replaced

at the nearest qualified specialist workshop. The new wheel must have the correct dimensions.

- i** The emergency spare wheel is secured in the emergency spare wheel bag in the trunk.

Observe the following notes on installing an emergency spare wheel:

- Check the tire pressure of the emergency spare wheel installed. Correct the pressure as necessary.
 - The maximum permissible speed with an emergency spare wheel installed is 50 mph (80 km/h).
 - Do not equip the emergency spare wheel with snow chains.
 - Replace the emergency spare wheel after six years at the latest, regardless of wear.
- i** **Vehicles with a tire pressure loss warning system:** If an emergency spare wheel is installed the tire pressure loss warning system cannot function reliably. Only restart the

system again when the emergency spare wheel has been replaced with a new wheel.

Vehicles with a tire pressure monitoring system:

If an emergency spare wheel is installed the tire pressure monitoring system cannot function reliably. For a few minutes after an emergency spare wheel is installed, the system may still display the tire pressure of the removed wheel. Only restart the system again when the emergency spare wheel has been replaced with a new wheel.

Be sure to also observe the following further related subjects:

- Notes on tire pressure (→ page 297)
- Tire and Loading Information placard (→ page 304)
- Tire pressure table (→ page 299)
- Notes on installing tires (→ page 316)

Notes on technical data

! NOTE Mercedes-AMG vehicles

- ▶ Observe the notes in the Supplement. You could otherwise fail to recognize dangers.

The data stated only applies to vehicles with standard equipment. You can obtain further information from an authorized Mercedes-Benz Center.

Vehicle electronics

Two-way radios

Notes on installing two-way radios

! WARNING Risk of accident due to improper work on two-way radios

If two-way radios are manipulated or retrofitted incorrectly, the electromagnetic radiation from the two-way radios can interfere with the vehicle electronics and jeopardize the operating safety of the vehicle.

- ▶ You should have all work on electrical and electronic components carried out at a qualified specialist workshop.

! WARNING Risk of accident due to improper operation of two-way radios

If you use two-way radios in the vehicle improperly, their electromagnetic radiation can disrupt the vehicle's electronics. This is the case in the following situations, in particular:

- The two-way radio is not connected to an exterior antenna.
- The exterior antenna is installed incorrectly or is not a low-reflection antenna.

This could jeopardize the operating safety of the vehicle.

- ▶ Have the low-reflection exterior antenna installed at a qualified specialist workshop.

- ▶ When operating two-way radios in the vehicle, always connect them to the low-reflection exterior antenna.

! NOTE Invalidation of the operating permit due to failure to comply with the instructions for installation and use

The operating permit may be invalidated if the instructions for installation and use of two-way radios are not observed.

- ▶ Only use approved frequency bands.
- ▶ Observe the maximum permissible output power in these frequency bands.
- ▶ Only use approved antenna positions.

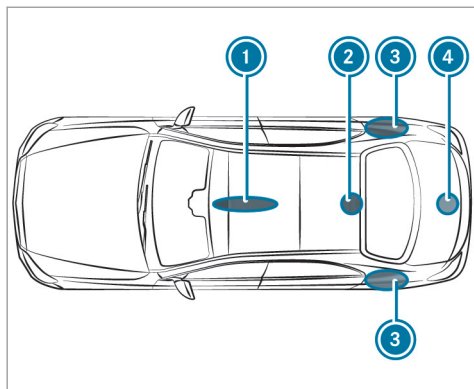

- ① Front roof area
- ② Rear roof area
- ③ Rear fenders
- ④ Trunk lid

On the rear fenders, it is recommended that you install the antenna on the side of the vehicle closest to the center of the road.

Use Technical Specification ISO/TS 21609 (Road Vehicles - "EMCs for installation of aftermarket radio frequency transmitting equipment") when retrofitting two-way radios. Comply with the legal requirements for detachable parts.

If your vehicle has installing for two-way radio equipment, use the power supply and antenna connectors provided in the pre-installation. Observe the manufacturer's supplements when installing.

Two-way radio transmission output

The maximum transmission output (PEAK) at the base of the antenna must not exceed the values in the following table.

Frequency band and maximum transmission output

Frequency band	Maximum transmission output
Short wave 3 - 54 MHz	(100 W)
4 m frequency band 74 - 88 MHz	(30 W)
2 m frequency band 144 - 174 MHz	(50 W)
Terrestrial Trunked Radio (TETRA) 380 - 460 MHz	(10 W)
70 cm frequency band 420 - 450 MHz	(35 W)
Two-way radio (2G/3G/4G)	(10 W)

The following can be used in the vehicle without restrictions:

- Two-way radios with a maximum transmission output of up to 100 mW
- RF transmitters with transmitter frequencies in the 380 - 410 MHz frequency band and a maximum transmission output of up to 2 W (TETRA)
- Mobile phones (2G/3G/4G)

There are no restrictions when positioning the antenna on the outside of the vehicle for some wavebands.

- Terrestrial Trunked Radio (TETRA)
- 70 cm frequency band
- 2G/3G/4G

Radio operating permits for vehicle components

Manufacturer information about wireless vehicle components can be found using the key phrase "Radio operating permits" in the Digital Opera-

tor's Manual in the vehicle, on the Internet and in the app.

Vehicle identification plate, VIN and engine number overview

Vehicle identification plate

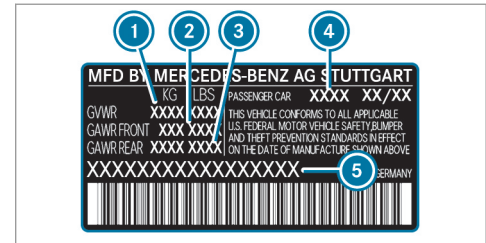
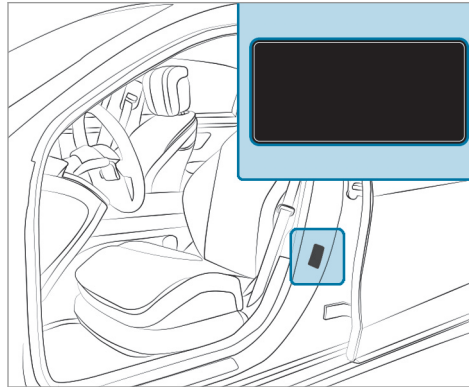

Vehicle identification plate (USA only)

- 1 Maximum permissible gross vehicle weight
- 2 Maximum permissible front axle load
- 3 Maximum permissible rear axle load
- 4 Paint code
- 5 VIN (vehicle identification number)

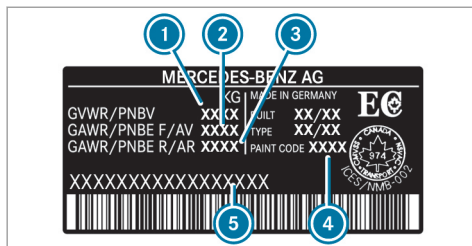

Vehicle identification plate (Canada only)

- ① Maximum permissible gross vehicle weight
- ② Maximum permissible front axle load
- ③ Maximum permissible rear axle load
- ④ Paint code
- ⑤ VIN (vehicle identification number)

The maximum permissible gross vehicle weight is made up of the vehicle weight, all vehicle occupants, the fuel and the load. The maximum gross axle weight rating is the maximum weight that can be carried on one axle (front or rear axle).

Do not exceed the maximum gross vehicle weight or the maximum gross axle weight rating for the front or rear axle.

VIN below right-hand front seat

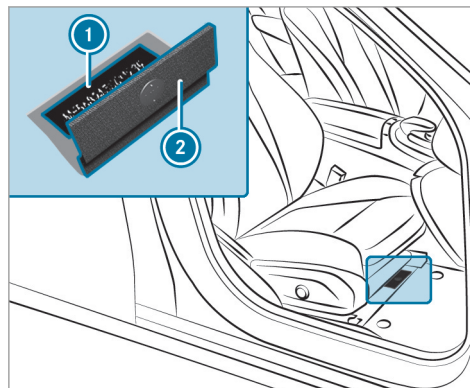

- ① Imprinted VIN (vehicle identification number)
- ② Floor covering

Additional plates

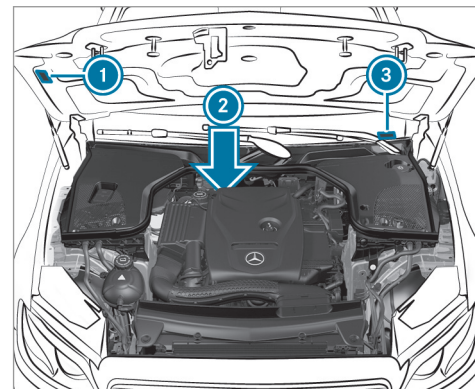

- ① Plate with information about emissions testing, including confirmation of emissions guidelines at the U.S. federal level as well as for California
- ② Engine number stamped into the crankcase
- ③ VIN (vehicle identification number) as a label at the lower edge of the windshield

Operating fluids

Notes on operating fluids

! NOTE Mercedes-AMG vehicles

- ▶ Observe the notes in the Supplement. You could otherwise fail to recognize dangers.

⚠ WARNING Risk of injury from operating fluids harmful to your health

Operating fluids may be poisonous and harmful to your health.

- ▶ Observe the text on the original containers when using, storing or disposing of operating fluids.
- ▶ Always store operating fluids sealed in their original containers.
- ▶ Always keep children away from operating fluids.



ENVIRONMENTAL NOTE Environmental pollution caused by environmentally irresponsible disposal

- ▶ Dispose of operating fluids in an environmentally responsible manner.

Operating fluids include the following:

- Fuels
- Lubricants
- Coolant
- Brake fluid
- Windshield washer fluid
- Climate control system refrigerant

Only use products approved by Mercedes-Benz. Damage caused by the use of products that have not been approved is not covered by the Mercedes-Benz warranty or goodwill gestures.

The operating fluids approved by Mercedes-Benz can be identified by the following inscriptions on the container:

- MB-Freigabe (e.g. MB-Freigabe 229.51)

- MB-Approval (e.g. MB-Approval 229.51)

Further information on approved operating fluids:

- In the Mercedes-Benz Specifications for Operating Fluids by entering the designation
 - At <https://bevo.mercedes-benz.com>
 - In the Mercedes-Benz BeVo app
- At a qualified specialist workshop

⚠ WARNING Risk of fire or explosion from fuel

Fuels are highly flammable.

- ▶ Fire, open flames, smoking and creation of sparks must be avoided.
- ▶ Switch off the ignition and, if available, the stationary heater, before and while refueling the vehicle.

⚠ WARNING Risk of injury from fuels

Fuels are poisonous and hazardous to your health.

- ▶ Do not swallow fuel or let it come into contact with skin, eyes or clothing.
- ▶ Do not inhale fuel vapor.
- ▶ Keep children away from fuel.
- ▶ Keep doors and windows closed during the refueling process.

If you or other people come into contact with fuel, observe the following:

- ▶ Immediately rinse fuel off your skin with soap and water.
- ▶ If fuel comes into contact with your eyes, immediately rinse them thoroughly with clean water. Seek medical attention immediately.
- ▶ If you swallow fuel, seek medical attention immediately. Do not induce vomiting.
- ▶ Change immediately out of clothing that has come into contact with fuel.

Fuel

Notes on fuel grades for vehicles with a gasoline engine

Observe the notes on operating fluids (→ page 331).

! NOTE Damage caused by the wrong fuel

Even small amounts of the wrong fuel could result in damage to the fuel system, the engine and the emission control system.

- ▶ Only refuel with low-sulfur gasoline.

This fuel may contain up to 10% ethanol by volume. Your vehicle is suitable for use with E10 fuel.

Never refuel with one of the following fuels:

- Diesel
- Gasoline with more than 10% ethanol by volume, e.g. E15, E85, E100
- Gasoline with more than 3% methanol by volume, e.g. M15, M30, M85, M100
- Gasoline with additives containing metal

If you have accidentally refueled with the wrong fuel:

- ▶ do not switch the ignition on.
- ▶ Consult a qualified specialist workshop.

If the available fuel is not sufficiently low in sulfur, this can produce unpleasant odors.

Only refuel with fuel that has at least the octane number specified in the information label in the fuel filler flap (→ page 152).

If you want maximum engine output: only refuel with unleaded premium grade gasoline with an octane number of at least 91 AKI/95 RON.

As a temporary measure, if the recommended fuel is not available, you may also refuel with unleaded regular gasoline with at least 87 AKI/91 RON. This may reduce engine output and increase fuel consumption.

Never refuel using gasoline with an even lower RON.

! **NOTE** Premature engine wear through unleaded regular gasoline

Impairment of the longevity and performance of the engine.

If unleaded premium grade gasoline is unavailable and you have to refuel using unleaded regular gasoline:

- ▶ Only fill the fuel tank to half full with unleaded regular gasoline and refill as soon as possible with unleaded premium grade gasoline.
- ▶ Do not drive at the maximum design speed.
- ▶ Avoid sudden acceleration and engine speeds over 3000 rpm.

Further information on fuel is available at the following locations:

- At a gas station
- At a qualified specialist workshop
- On the <https://www.mbusa.com> (USA only)

Notes on additives in gasoline

Observe the notes on operating fluids (→ page 331).

! **NOTE** Damage from use of unsuitable additives

Even small amounts of the wrong additive may lead to malfunctions occurring.

- ▶ Only add cleaning additives recommended by Mercedes-Benz to the fuel.

Mercedes-Benz recommends that you use brand-name fuels with additives.

In some countries, the fuel available may not have sufficient additives. Residue could build up in the fuel injection system as a result. In this case, in consultation with an authorized Mercedes-Benz Center, mix the fuel with the cleaning additive recommended by Mercedes-Benz. Observe the notes and mixing ratios indicated on the tank.

Tank content and reserve fuel

Model	Total capacity
All models	21.1 gal (80.0 liters)
Model	Of which reserve
All models	3.2 gal (12.0 liters)

Engine oil

Notes on engine oil

Observe the notes on operating fluids (→ page 331).



! **NOTE** Engine damage caused by an incorrect oil filter, incorrect oil or additives

- ▶ Do not use engine oils or oil filters other than those which meet the specifications necessary for the prescribed service intervals.
- ▶ Do not alter the engine oil or oil filter in order to achieve longer change intervals than prescribed.
- ▶ Do not use additives.
- ▶ Have the engine oil changed after the prescribed intervals.

Mercedes-Benz recommends that you have the oil change carried out at a qualified specialist workshop.

Quality and capacity of engine oil

Gasoline engines	MB-Freigabe or MB-Approval
All models	229.51, 229.52, 229.61 229.71*

* Recommended for lowest possible fuel consumption (lowest SAE viscosity class in each case; observe possible restrictions of the approved SAE viscosity classes).

To achieve the lowest possible fuel consumption, it is recommended to use the engine oil specifications marked in the table for the lowest SAE viscosity class. Possible restrictions of the approved SAE viscosity classes must be observed.

The following values refer to an oil change, including the oil filter.

Model	Capacity
CLS 450	10.0 US qt (9.5 liters)
CLS 450 4MATIC	9.0 US qt (8.5 liters)

Notes on brake fluid

Observe the notes on operating fluids (→ page 331).

! **WARNING** Risk of an accident due to vapor pockets forming in the brake system

The brake fluid constantly absorbs moisture from the air. This lowers the boiling point of the brake fluid. If the boiling point is too low, vapor pockets may form in the brake system when the brakes are applied hard.

This causes the braking effect to be impaired.

- ▶ Have the brake fluid renewed at the specified intervals.

Have the brake fluid regularly replaced at a qualified specialist workshop.
Only use a brake fluid approved by Mercedes-Benz according to MB-Freigabe or MB-Approval 331.0.

Coolant

Notes on coolant

Observe the notes on operating fluids (→ page 331).

⚠ WARNING - Risk of fire and injury from antifreeze

If antifreeze comes into contact with hot component parts in the engine compartment, it may ignite.

- ▶ Allow the engine to cool down before adding antifreeze.
- ▶ Make sure that no antifreeze spills out next to the filler opening.
- ▶ Thoroughly clean off any antifreeze from component parts before starting the vehicle.

! **NOTE** Damage caused by incorrect coolant

- ▶ Only use coolant that has been pre-mixed with the required antifreeze protection.

Information on coolant is available at the following locations:

- In the Mercedes-Benz Specifications for Operating Fluids 310.1
 - At <https://bevo.mercedes-benz.com>
 - In the Mercedes-Benz BeVo app
- At a qualified specialist workshop

! **NOTE** Overheating at high outside temperatures

If an inappropriate coolant is used, the engine cooling system is not sufficiently protected against overheating and corrosion at high outside temperatures.

- ▶ Always use coolant approved by Mercedes-Benz.

- ▶ Observe the instructions in the Mercedes-Benz Specifications for Operating Fluids 310.1.

Have the coolant regularly replaced at a qualified specialist workshop.

Proportion of antifreeze concentrate in the engine cooling system:

- A minimum of 50% (antifreeze protection down to approximately -35°F (-37°C))
- A maximum of 55% (antifreeze protection down to -49°F (-45°C))

Coolant capacity

Model	Capacity
All models	13.7 US qt (13.0 liters)

Notes on windshield washer fluid

Observe the notes on operating fluids (→ page 331).

⚠ WARNING - Risk of fire and injury from windshield washer concentrate

Windshield washer concentrate is highly flammable. It could ignite if it comes into contact with hot engine component parts or the exhaust system.

- ▶ Make sure that no windshield washer concentrate spills out next to the filler opening.

! NOTE Damage to the exterior lighting due to unsuitable windshield washer fluid

Unsuitable windshield washer fluid may damage the plastic surface of the exterior lighting.

- ▶ Only use windshield washer fluid which is also suitable for use on plastic surfaces, e.g. MB SummerFit or MB WinterFit.

! NOTE Blocked spray nozzles caused by mixing windshield washer fluids

- ▶ Do not mix MB SummerFit and MB WinterFit with other windshield washer fluids.

Do not use distilled or de-ionized water. Otherwise, the fill level sensor may be triggered erroneously.

Recommended windshield washer fluid:

- Above freezing point: e.g. MB SummerFit
- Below freezing point: e.g. MB WinterFit

For the correct mixing ratio, refer to the information on the antifreeze container.

Mix washer fluid with windshield washer fluid all year round.

Refrigerant

Notes on refrigerant

Observe the notes on operating fluids (→ page 331).

! NOTE Damage due to incorrect refrigerant

If a non-approved refrigerant is used, the climate control system may be damaged.

- ▶ **USA/China:** Use only R-134a refrigerant.
- ▶ **Canada:** Use only R-1234yf refrigerant.

! NOTE Damage to the climate control system due to incorrect refrigerant compressor oil

- ▶ Only use refrigerant compressor oil that has been approved by Mercedes-Benz.
- ▶ Do not mix the approved refrigerant compressor oil with a different refrigerant compressor oil.

Work on the climate control system may be carried out only by a qualified specialist workshop. All applicable regulations, as well as SAE standard J639, must be adhered to.

The information label for the climate control system regarding the refrigerant type and the refrigerant

erant compressor oil (PAG oil) is located on the inside of the hood.

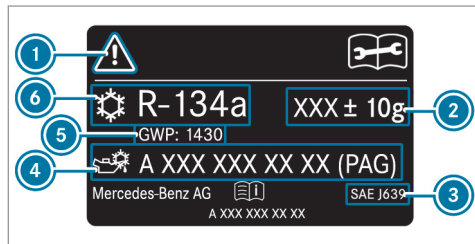

Information label (example – USA/China)

- ① Hazard and service warning symbols
- ② Refrigerant filling capacity
- ③ Applicable standards
- ④ PAG oil part number
- ⑤ GWP (global warming potential) of the refrigerant used
- ⑥ Refrigerant type

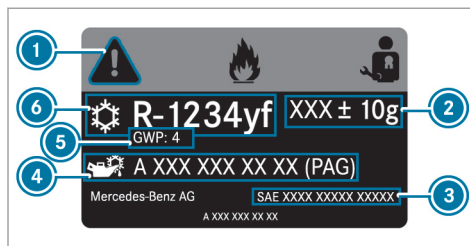

Information label (example – Canada)

- ① Hazard and service warning symbols
- ② Refrigerant filling capacity
- ③ Applicable standards
- ④ PAG oil part number
- ⑤ GWP (global warming potential) of the refrigerant used
- ⑥ Refrigerant type

Symbols ① indicate the following:

- Possible dangers
- The need to have service work carried out at a qualified specialist workshop only

Filling capacity for refrigerant and PAG oil

Model	Refrigerant
All models	22.2 ± 0.4 oz (630 ± 10 g)
Model	PAG oil
All models	2.8 ± 0.4 oz (80 ± 10 g)

Vehicle data

Vehicle dimensions

The heights specified may vary as a result of the following factors:

- Tires
- Load
- Condition of the suspension
- Optional equipment

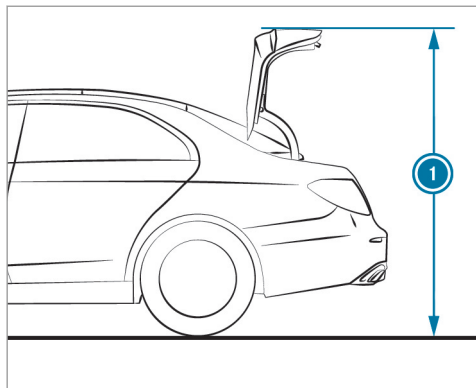

Height when opened

Model	① Height when opened
CLS 450	74.4 in (1889 mm)
CLS 450 4MATIC	74.6 in (1895 mm)

Vehicle dimensions

All models	
Vehicle length	198.8 in (5050 mm)
Vehicle width including outside mirrors	81.5 in (2069 mm)
Wheelbase	115.7 in (2939 mm)

Vehicle height

Model	Vehicle height
CLS 450	56.3 in (1430 mm)
CLS 450 4MATIC	56.5 in (1436 mm)

Turning radius

Model	Turning radius
CLS 450	38.06 ft (11.60 m)
CLS 450 4MATIC	39.04 ft (11.90 m)

Weights and loads

Please observe the following notes for the specified vehicle data:

- Items of optional equipment increase the curb weight and reduce the payload.

Model	Maximum roof load
All models	165 lb (75 kg)

Display messages

Introduction



Information about display messages

Display messages appear on the multifunction display.

Display messages with graphical symbols are simplified in the Operator's Manual and may differ from the symbols on the multifunction display. The multifunction display shows high-priority display messages in red. Certain display messages are accompanied by a warning tone.

Please act in accordance with the display messages and follow the additional notes in the Operator's Manual.

For some display messages, a symbol will also be shown:

-  Further information
-  Hide display message

With the left-hand Touch Control, you can select the respective symbol by swiping to the left or right. Press the  symbol to show further infor-

mation on the media display. Press the  symbol to hide the display message.

You can hide low-priority display messages by pressing the  back button or the left-hand Touch Control. The display messages will then be stored in the message memory.

Rectify the cause of a display message as quickly as possible.

High-priority display messages cannot be hidden. The multifunction display shows these display messages continuously until the cause of the display message has been rectified.

Calling up saved display messages

On-board computer:



 [Service](#)  [1 Message](#)

If there are no display messages, [No Messages](#) will appear on the multifunction display.

▶ Scroll through the display messages by swiping upwards or downwards on the left-hand Touch Control.

▶ **To exit the message memory:** press the back button .

Occupant safety

Display messages	Possible causes/consequences and ► Solutions
 <p data-bbox="195 384 445 433">SRS Malfunction Service Required</p>	<p data-bbox="524 291 1068 317">* The restraint system is malfunctioning (→ page 36).</p> <div data-bbox="547 332 1698 449" style="border: 1px solid gray; padding: 5px;"> <p data-bbox="565 342 1286 368">▲ WARNING Risk of injury due to malfunctions in the restraint system</p> <p data-bbox="565 381 1655 407">Components in the restraint system may be activated unintentionally or not deploy as planned in an accident.</p> <p data-bbox="565 415 1548 441">► Have the restraint system checked and repaired immediately at a qualified specialist workshop.</p> </div>
 <p data-bbox="195 563 473 612">Front Left Malfunction Service Required (example)</p>	<p data-bbox="524 470 1215 496">* The corresponding restraint system is malfunctioning (→ page 36).</p> <div data-bbox="547 511 1698 628" style="border: 1px solid gray; padding: 5px;"> <p data-bbox="565 522 1286 548">▲ WARNING Risk of injury due to malfunctions in the restraint system</p> <p data-bbox="565 560 1655 586">Components in the restraint system may be activated unintentionally or not deploy as planned in an accident.</p> <p data-bbox="565 594 1548 620">► Have the restraint system checked and repaired immediately at a qualified specialist workshop.</p> </div>
 <p data-bbox="195 742 436 815">Left Side Curtain Airbag Malfunction Service Required (example)</p>	<p data-bbox="524 649 1276 675">* The corresponding window curtain airbag is malfunctioning (→ page 36).</p> <div data-bbox="547 691 1698 828" style="border: 1px solid gray; padding: 5px;"> <p data-bbox="565 701 1493 727">▲ WARNING Risk of injury or fatal injury due to a malfunction in the window curtain airbag</p> <p data-bbox="565 739 1655 786">The window curtain airbag might be triggered unintentionally or might not be triggered at all in the event of an accident.</p> <p data-bbox="565 794 1609 820">► Have the window curtain airbag checked and repaired immediately at a qualified specialist workshop.</p> </div>

Display messages	Possible causes/consequences and ► Solutions
<p>Front Passenger Airbag Disabled See Operator's Manual</p>	<p>* The front passenger airbag and the front passenger knee airbag have been disabled even though an adult or a person of adult stature is on the front passenger seat. If additional forces are applied to the seat, the weight the system detects may be too low.</p> <div data-bbox="495 344 1646 550" style="border: 1px solid gray; padding: 5px;"><p>▲ WARNING Risk of injury or fatal injury due to a disabled front passenger airbag</p><p>If the front passenger airbag is disabled, the front passenger airbag will not be deployed in the event of an accident and cannot perform its intended protective function.</p><p>A person in the front passenger seat could then, for example, come into contact with the vehicle's interior, especially if the person is sitting too close to the cockpit.</p><p>► Make sure, both before and during the journey, that the status of the front passenger airbag is correct.</p></div> <ul style="list-style-type: none">► Stop the vehicle immediately in accordance with the traffic conditions.► Make sure that no objects are trapped under the front passenger seat.► Check the status of the automatic front passenger airbag actuation (→ page 46).► If necessary, consult a qualified specialist workshop immediately.
<p>Front Passenger Airbag Enabled See Operator's Manual</p>	<p>* The front passenger airbag and the front passenger knee airbag will be enabled while the vehicle is in motion in the following situations:</p> <ul style="list-style-type: none">• Even when a child, a small adult or an object weighing less than the system weight threshold is located on the front passenger seat• Even when the front passenger seat is not occupied

Display messages	Possible causes/consequences and ► Solutions
	<p>The system may detect objects or forces that are adding to the weight applied to the seat.</p> <div style="background-color: #f0f0f0; padding: 5px; border: 1px solid #ccc;"> <p>▲ WARNING Risk of injury or death when using a child restraint system while the front passenger airbag is enabled</p> <p>If you secure a child in a child restraint system on the front passenger seat and the front passenger airbag is enabled, the front passenger airbag can deploy in the event of an accident. The child could be struck by the airbag.</p> <ul style="list-style-type: none"> ► Ensure, both before and during the journey, that the status of the front passenger airbag is correct. <p>NEVER use a rearward facing child restraint on a seat protected by an ACTIVE AIRBAG in front of it, DEATH or SERIOUS INJURY to the CHILD can occur.</p> </div> <ul style="list-style-type: none"> ► Stop the vehicle immediately in accordance with the traffic conditions. ► Make sure that no objects are trapped under the front passenger seat. ► Check the status of the automatic front passenger airbag actuation (→ page 46). ► If necessary, consult a qualified specialist workshop immediately.
<p>PRE-SAFE Inoperative See Operator's Manual</p>	<p>* The PRE-SAFE® functions are malfunctioning.</p> <ul style="list-style-type: none"> ► Consult a qualified specialist workshop.

344 Display messages and warning/indicator lamps

Display messages	Possible causes/consequences and ► Solutions
<p>PRE-SAFE Impulse Side Inoperative See Operator's Manual</p>	<p>* The PRE-SAFE® Impulse Side system is malfunctioning or inoperative after having already been triggered.</p> <ul style="list-style-type: none">► Consult a qualified specialist workshop.

SmartKey

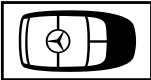
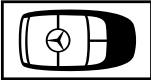

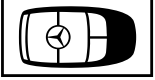
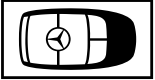
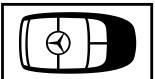
Display messages	Possible causes/consequences and ► Solutions
 <p>Obtain a New Key</p>	<p>* Have SmartKey replaced.</p> <ul style="list-style-type: none">► Consult a qualified specialist workshop.
 <p>Replace Key Battery</p>	<p>* The SmartKey battery is discharged.</p> <ul style="list-style-type: none">► Replace the battery (→ page 66).





Display messages	Possible causes/consequences and ► Solutions
 <p>Key Not Detected (white display message)</p>	<p>* The SmartKey is currently undetected.</p> <ul style="list-style-type: none"> ► Change the location of the SmartKey in the vehicle. ► If the SmartKey is still not recognized, place it in the marked space for starting with the SmartKey (→ page 135).
 <p>Key Not Detected (red display message)</p>	<p>* The SmartKey cannot be detected and may no longer be in the vehicle. The SmartKey is no longer in the vehicle and you switch off the engine:</p> <ul style="list-style-type: none"> • You can no longer start the engine. • You cannot centrally lock the vehicle. <p>► Ensure that the SmartKey is in the vehicle.</p> <p>If the SmartKey detection function has a malfunction due to a strong radio signal source:</p> <ul style="list-style-type: none"> ► Stop the vehicle immediately in accordance with the traffic conditions. ► Place the SmartKey in the marked space for starting the engine with the SmartKey (→ page 135).
 <p>Don't Forget Your Key</p>	<p>* A warning tone also sounds. This message reminds you to take your SmartKey with you when you leave the vehicle.</p>

346 Display messages and warning/indicator lamps

Display messages	Possible causes/consequences and ► Solutions
Place the Key in the Marked Space See Operator's Manual	<ul style="list-style-type: none">* SmartKey detection is malfunctioning.<ul style="list-style-type: none">► Change the location of the SmartKey in the vehicle.► Place the SmartKey in the marked space for starting the engine with the SmartKey (→ page 135).



Lights



Display messages	Possible causes/consequences and ► Solutions
 Check Left Low Beam (example)	<ul style="list-style-type: none">* The corresponding light source is faulty.<ul style="list-style-type: none">► Drive on carefully.► Consult a qualified specialist workshop immediately.ⓘ LED light sources: the display message for the corresponding light appears only when all the light-emitting diodes in the light are faulty.
 Malfunction See Operator's Manual	<ul style="list-style-type: none">* The exterior lighting is malfunctioning.<ul style="list-style-type: none">► Consult a qualified specialist workshop.



Display messages	Possible causes/consequences and ► Solutions
 <p data-bbox="195 342 473 394">Automatic Headlamp Mode Inoperative</p>	<p data-bbox="519 249 888 275">* The light sensor is malfunctioning.</p> <p data-bbox="543 283 975 309">► Consult a qualified specialist workshop.</p>
 <p data-bbox="195 512 473 564">Active Headlamps Inoperative</p>	<p data-bbox="519 419 962 445">* The active headlamps are malfunctioning.</p> <p data-bbox="543 453 975 479">► Consult a qualified specialist workshop.</p>
 <p data-bbox="195 682 417 708">Switch On Headlamps</p>	<p data-bbox="519 589 999 615">* You are driving without low-beam headlamps.</p> <p data-bbox="543 623 1086 649">► Turn the light switch to the  or AUTO position.</p>
 <p data-bbox="195 821 371 847">Switch Off Lights</p>	<p data-bbox="519 728 1166 754">* You are leaving the vehicle and the lights are still switched on.</p> <p data-bbox="543 762 999 788">► Turn the light switch to the AUTO position.</p>

Display messages	Possible causes/consequences and ► Solutions
 <p data-bbox="144 342 421 391">Intell. Light System Inoperative</p>	<ul style="list-style-type: none"> <li data-bbox="473 249 1641 301">* The Intelligent Light System is malfunctioning. The lighting system continues to function properly without the functions of the Intelligent Light System. <ul style="list-style-type: none"> <li data-bbox="495 311 925 335">► Consult a qualified specialist workshop.
<p data-bbox="144 418 421 495">Adaptive Highbeam Assist Currently Unavailable See Operator's Manual</p>	<ul style="list-style-type: none"> <li data-bbox="473 418 1604 539">* Adaptive Highbeam Assist is temporarily unavailable. The system limits have been reached (→ page 117). Once the cause of the problem is no longer present, the system will be available again. The Adaptive Highbeam Assist Now Available display message will appear. <ul style="list-style-type: none"> <li data-bbox="495 550 624 573">► Drive on.
<p data-bbox="144 587 421 636">Adaptive Highbeam Assist Inoperative</p>	<ul style="list-style-type: none"> <li data-bbox="473 587 938 646">* Adaptive Highbeam Assist is malfunctioning. <ul style="list-style-type: none"> <li data-bbox="495 625 925 649">► Consult a qualified specialist workshop.
<p data-bbox="144 659 421 708">Hazard Warning Flashers Malfunctioning</p>	<ul style="list-style-type: none"> <li data-bbox="473 659 999 718">* The hazard warning lamp switch is malfunctioning. <ul style="list-style-type: none"> <li data-bbox="495 698 925 722">► Consult a qualified specialist workshop.

Vehicle

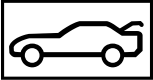

Display messages	Possible causes/consequences and ► Solutions
 <p>Vehicle Ready to Drive Switch the Ignition Off Before Exiting</p>	<ul style="list-style-type: none"> * You are leaving the vehicle when it is in a ready-to-drive state. <ul style="list-style-type: none"> ► When you leave the vehicle, switch off the ignition, secure the vehicle against rolling away and take the Smart-Key with you. ► If you do not leave the vehicle, switch off the electrical consumers, e.g. the seat heating. Otherwise, the 12 V battery may discharge and it will then be possible to start the vehicle only with the aid of a second battery (starting assistance).
 <p>Steering Malfunction Increased Physical Effort See Operator's Manual</p>	<ul style="list-style-type: none"> * The power steering assistance is malfunctioning. <div style="background-color: #f0f0f0; padding: 5px; margin-top: 10px;"> <p>⚠ WARNING Risk of an accident due to altered steering characteristics</p> <p>If the power assistance of the steering fails partially or completely, you will need to use more force to steer.</p> <ul style="list-style-type: none"> ► If safe steering is possible, drive on carefully. ► Visit or consult a qualified specialist workshop immediately. </div>
 <p>Steering Malfunction Stop Immediately See Operator's Manual</p>	<ul style="list-style-type: none"> * The steering is malfunctioning. Steering capability is significantly impaired. <div style="background-color: #f0f0f0; padding: 5px; margin-top: 10px;"> <p>⚠ WARNING Risk of accident if steering capability is impaired</p> <p>If the steering does not function as intended, the vehicle's operating safety is jeopardized.</p> </div>

Display messages	Possible causes/consequences and ► Solutions
	<ul style="list-style-type: none"> ► Pull over and stop the vehicle safely as soon as possible, paying attention to road and traffic conditions. Do not continue driving under any circumstances. ► Consult a qualified specialist workshop.
	<p>* At least one door is open.</p> <ul style="list-style-type: none"> ► Close all doors.
	<p>* The hood is open.</p> <div style="background-color: #cccccc; padding: 5px; margin-bottom: 10px;"> <p>▲ WARNING Risk of accident due to driving with the hood unlocked</p> </div> <p>The hood may open and block your view.</p> <ul style="list-style-type: none"> ► Never release the hood when driving. ► Before every trip, ensure that the hood is locked. <ul style="list-style-type: none"> ► Stop the vehicle immediately, paying attention to road and traffic conditions. ► Close the hood.
	<p>* The trunk lid is open.</p>

Display messages	Possible causes/consequences and ► Solutions
	<p>▲ DANGER Risk of exhaust gas poisoning</p> <p>Combustion engines emit poisonous exhaust gases such as carbon monoxide. Exhaust gases can enter the vehicle interior if the trunk lid is open when the engine is running, especially if the vehicle is in motion.</p> <ul style="list-style-type: none"> ▶ Always switch off the engine before opening the trunk lid. ▶ Never drive with the trunk lid open. <p>► Close the trunk lid.</p>
 <p>Rear Left Backrest Not Latched (example)</p>	<ul style="list-style-type: none"> * The seat backrest of the corresponding seat is not engaged. ► Fold the seat backrest back until it engages.
 <p>Check Washer Fluid</p>	<ul style="list-style-type: none"> * The washer fluid level in the washer fluid reservoir has dropped below the minimum. ► Add washer fluid (→ page 269).

Engine

Display messages	Possible causes/consequences and ► Solutions
<p>To switch engine off, press and hold Start/Stop button for at least 3 seconds or press 3 times.</p>	<ul style="list-style-type: none"> * You have pressed the start/stop button while the vehicle is in motion. <ul style="list-style-type: none"> ► Information about switching off the engine while driving (→ page 134).
<div data-bbox="153 418 312 503" data-label="Image"> </div> <p>Check Coolant Level See Operator's Manual</p>	<ul style="list-style-type: none"> * The coolant level is too low. <div data-bbox="500 459 1646 547" data-label="Complex-Block" style="border: 1px solid gray; padding: 5px;"> <p>! NOTE Engine damage due to insufficient coolant</p> <ul style="list-style-type: none"> ► Avoid long journeys with insufficient coolant. </div> <ul style="list-style-type: none"> ► Add coolant (→ page 268). ► Have the engine cooling system checked at a qualified specialist workshop.
<div data-bbox="153 639 312 724" data-label="Image"> </div> <p>Coolant Too Hot Stop Vehicle Turn Engine Off</p>	<ul style="list-style-type: none"> * The coolant is too hot. <ul style="list-style-type: none"> ► Pull over and stop the vehicle safely and switch off the engine, paying attention to road and traffic conditions. <div data-bbox="500 724 1646 871" data-label="Complex-Block" style="border: 1px solid gray; padding: 5px;"> <p>! WARNING Danger of burns when opening the hood</p> <p>If you open the hood when the engine has overheated or during a fire in the engine compartment, you could come into contact with hot gases or other escaping operating fluids.</p> <ul style="list-style-type: none"> ► Before opening the hood, allow the engine to cool down. </div>

Display messages	Possible causes/consequences and ► Solutions
	<ul style="list-style-type: none"> ► In the event of a fire in the engine compartment, keep the hood closed and call the fire service. ► Wait until the engine has cooled down. ► Make sure that the air supply to the radiator is not obstructed. ► Avoiding high loads on the engine, drive to the nearest qualified specialist workshop. In doing so, ensure that the coolant temperature display remains below the red marking.
	<ul style="list-style-type: none"> * The fan motor is faulty. ► Avoiding high loads on the engine, drive to the nearest qualified specialist workshop. In doing so, ensure that the coolant temperature display remains below the red marking.
 <p data-bbox="195 646 347 667">Fuel Level Low</p>	<ul style="list-style-type: none"> * The fuel supply has dropped into the reserve range. ► Refuel.
 <p data-bbox="195 788 347 809">Gas Cap Loose</p>	<ul style="list-style-type: none"> * The fuel filler cap is not closed correctly or the fuel system is leaking. ► Close the fuel filler cap. ► If the fuel filler cap was already properly closed: consult a qualified specialist workshop.

Transmission





Display messages	Possible causes/consequences and ► Solutions
Only Shift to 'P' when Vehicle is Stationary	<ul style="list-style-type: none"> * It is possible to select the park position P only if the vehicle is stationary. <ul style="list-style-type: none"> ► To stop, depress the brake pedal. ► Shift the transmission to park position P when the vehicle is stationary.
Apply Brake to Shift from 'P'	<ul style="list-style-type: none"> * You have attempted to shift the transmission out of park position P and into another transmission position. <ul style="list-style-type: none"> ► Depress the brake pedal. ► Select transmission position D, R or neutral N.
To Deselect P or N, Depress Brake and Start Engine	<ul style="list-style-type: none"> * You have attempted to shift the transmission out of park position P or neutral N and into another transmission position. <ul style="list-style-type: none"> ► Depress the brake pedal. ► Start the engine. ► Change the transmission position.
Apply Brake to Shift to D or R	<ul style="list-style-type: none"> * You have attempted to select transmission position D or R. <ul style="list-style-type: none"> ► Depress the brake pedal. ► Select transmission position D or R.
Apply Brake to Shift to 'R'	<ul style="list-style-type: none"> * You have attempted to select transmission position R. <ul style="list-style-type: none"> ► Depress the brake pedal. ► Select transmission position R.









Display messages	Possible causes/consequences and ► Solutions
Driver's Door Open & Transmission Not in P Risk of Vehicle Rolling Away	<ul style="list-style-type: none"> * The driver's door is not fully closed and transmission position D, R or neutral N is selected. <ul style="list-style-type: none"> ► Select park position P when switching off the vehicle.
N Permanently Active Risk of Rolling Away	<ul style="list-style-type: none"> * While the vehicle is rolling or while you are driving, neutral N has been engaged. <ul style="list-style-type: none"> ► To stop, depress the brake pedal. ► Shift the transmission to park position P while the vehicle is stationary. ► To continue driving, select transmission position D or R.
Service Required Do Not Shift Gears Visit Dealer	<ul style="list-style-type: none"> * The transmission is malfunctioning. The transmission position can no longer be changed. <ul style="list-style-type: none"> ► When transmission position D is selected, consult a qualified specialist workshop and do not change the transmission position. ► For all other transmission positions, park the vehicle safely. ► Consult a qualified specialist workshop or breakdown service.
Reversing Not Possible Service Required	<ul style="list-style-type: none"> * The transmission is malfunctioning. The transmission position R cannot be selected. <ul style="list-style-type: none"> ► Consult a qualified specialist workshop.
Transmission Malfunction Stop	<ul style="list-style-type: none"> * The transmission is malfunctioning. The transmission shifts to neutral N automatically. <ul style="list-style-type: none"> ► Stop the vehicle immediately in accordance with the traffic conditions. ► Depress the brake pedal. ► Engage park position P.

356 Display messages and warning/indicator lamps





Display messages	Possible causes/consequences and ► Solutions
<p>Stop Vehicle Leave Engine Running Wait Transmission Cooling</p>	<ul style="list-style-type: none">► Consult a qualified specialist workshop. <p>* The transmission is overheating. Pulling away may be temporarily impaired or not possible.</p> <ul style="list-style-type: none">► Stop the vehicle immediately in accordance with the traffic conditions. Do not continue driving.► Leave the engine running.► Wait until the display message disappears before pulling away.
<p>Auxiliary Battery Malfunction</p>	<p>* The auxiliary battery for the transmission is no longer being charged.</p> <ul style="list-style-type: none">► Consult a qualified specialist workshop.► Until then, always select park position P manually before you switch off the engine.► Before leaving the vehicle, apply the electric parking brake.



Brakes

Display messages	Possible causes/consequences and ► Solutions
<div data-bbox="205 294 362 376" data-label="Image"> </div> <p data-bbox="205 384 306 408">(USA only)</p> <div data-bbox="205 420 362 502" data-label="Image"> </div> <p data-bbox="205 510 340 534">(Canada only)</p> <p data-bbox="195 544 454 594">Parking Brake See Operator's Manual</p>	<ul style="list-style-type: none"> <li data-bbox="528 291 1360 314">* The yellow  indicator lamp is lit. The electric parking brake is malfunctioning. <p data-bbox="547 325 639 349">To apply:</p> <ul style="list-style-type: none"> <li data-bbox="547 359 1027 383">► Switch the ignition off and switch it back on. <li data-bbox="547 393 1147 417">► Apply the electric parking brake manually (→ page 159). <p data-bbox="547 444 1082 468">If it is not possible to apply the electric parking brake:</p> <ul style="list-style-type: none"> <li data-bbox="547 478 975 502">► Consult a qualified specialist workshop. <li data-bbox="547 512 1276 536">► Where necessary, also secure the parked vehicle against rolling away. <ul style="list-style-type: none"> <li data-bbox="528 547 1692 596">* The yellow  indicator lamp and the red  (USA only) or  (Canada only) indicator lamp are lit. The electric parking brake is malfunctioning. <p data-bbox="547 607 657 630">To release:</p> <ul style="list-style-type: none"> <li data-bbox="547 641 1027 665">► Switch the ignition off and switch it back on. <li data-bbox="547 675 1169 699">► Release the electric parking brake manually (→ page 159). <p data-bbox="547 709 565 733">or</p> <ul style="list-style-type: none"> <li data-bbox="547 743 1215 767">► Release the electric parking brake automatically (→ page 159). <p data-bbox="547 772 1143 796">If it is still not possible to release the electric parking brake:</p> <ul style="list-style-type: none"> <li data-bbox="547 807 1221 830">► Do not continue driving. Consult a qualified specialist workshop.

Display messages	Possible causes/consequences and ► Solutions
	<p>* The yellow  indicator lamp is lit and the red  (USA only) or  (Canada only) indicator lamp is flashing. The electric parking brake is malfunctioning. The electric parking brake could not be applied or released.</p> <ul style="list-style-type: none">► Switch the ignition off and switch it back on. <p>To apply:</p> <ul style="list-style-type: none">► Release and then apply the electric parking brake manually (→ page 159). <p>To release:</p> <ul style="list-style-type: none">► Apply and then release the electric parking brake manually. <p>If the electric parking brake cannot be applied or the red  (USA only) or  (Canada only) indicator lamp continues to flash:</p> <ul style="list-style-type: none">► Do not continue driving. Consult a qualified specialist workshop.► Where necessary, also secure the parked vehicle against rolling away. <p>* The yellow  indicator lamp is lit and the red  indicator lamp (USA only) or  indicator lamp (Canada only) flashes for approximately ten seconds after the electric parking brake has been applied or released. It then remains lit or goes out. The electric parking brake is malfunctioning.</p> <p>If the charge level is too low:</p> <ul style="list-style-type: none">► Charge the 12 V battery.



Display messages	Possible causes/consequences and ► Solutions
	<p>To apply:</p> <ul style="list-style-type: none">► Switch the ignition off. The electric parking brake will be applied automatically. <p>If you do not want the electric parking brake to be applied, e.g. at an automatic car wash or when the vehicle is being towed, leave the ignition switched on. This does not include having the vehicle towed with the rear axle raised.</p> <p>If the electric parking brake is not applied automatically:</p> <ul style="list-style-type: none">► Switch the ignition off and switch it back on.► Release and then apply the electric parking brake manually (→ page 159). <p>If it is still not possible to apply the electric parking brake:</p> <ul style="list-style-type: none">► Consult a qualified specialist workshop.► Where necessary, also secure the parked vehicle against rolling away. <p>To release:</p> <ul style="list-style-type: none">► If the conditions for automatic release are fulfilled and the electric parking brake is not released automatically, release the electric parking brake manually (→ page 159). <p>If it is still not possible to release the electric parking brake:</p> <ul style="list-style-type: none">► Do not continue driving. Consult a qualified specialist workshop.



Display messages	Possible causes/consequences and ► Solutions
 <p>(USA only)</p>  <p>(Canada only)</p> <p>Please Release Parking Brake</p>	<p>* The red  indicator lamp (USA only) or  indicator lamp (Canada only) is flashing.</p> <p>The electric parking brake is applied while you are driving:</p> <ul style="list-style-type: none">• A condition for automatic release of the electric parking brake has not been fulfilled (→ page 159).• You are performing emergency braking using the electric parking brake (→ page 159). <p>► Check the conditions for automatic release of the electric parking brake.</p> <p>► Release the electric parking brake manually.</p>



Display messages	Possible causes/consequences and ► Solutions
<div data-bbox="205 252 362 335" data-label="Image"> </div> <p data-bbox="199 342 310 368">(USA only)</p> <div data-bbox="205 381 362 464" data-label="Image"> </div> <p data-bbox="199 471 343 497">(Canada only)</p> <p data-bbox="194 505 463 557">Turn On the Ignition to Release the Parking Brake</p>	<p data-bbox="519 249 1415 311">* The red  (USA only) or  indicator lamp (Canada only) is lit. You have attempted to release the electric parking brake with the ignition switched off.</p> <ul style="list-style-type: none"> <li data-bbox="543 319 805 344">► Switch on the ignition.
<div data-bbox="205 584 362 667" data-label="Image"> </div> <p data-bbox="194 674 304 700">(USA only)</p> <div data-bbox="205 710 362 793" data-label="Image"> </div> <p data-bbox="194 800 338 826">(Canada only)</p> <p data-bbox="194 835 439 860">Check Brake Fluid Level</p>	<p data-bbox="519 581 1129 607">* There is insufficient brake fluid in the brake fluid reservoir.</p> <div data-bbox="543 622 1702 837" data-label="Complex-Block" style="border: 1px solid black; padding: 10px;"> <p data-bbox="565 632 1184 658">▲ WARNING Risk of an accident due to low brake fluid level</p> <p data-bbox="565 671 1563 697">If the brake fluid level is too low, the braking effect and the braking characteristics may be impaired.</p> <ul style="list-style-type: none"> <li data-bbox="565 705 1637 731">► Pull over and stop the vehicle safely as soon as possible, paying attention to road and traffic conditions. Do not continue driving under any circumstances. <li data-bbox="565 739 994 765">► Consult a qualified specialist workshop. <li data-bbox="565 773 827 799">► Do not add brake fluid. </div>

Display messages	Possible causes/consequences and ► Solutions
 <p data-bbox="144 342 373 391">Check Brake Pads See Operator's Manual</p>	<ul style="list-style-type: none"> * The brakepads have reached the wear limit. <ul style="list-style-type: none"> ► Consult a qualified specialist workshop.

Driving systems

Display messages	Possible causes/consequences and ► Solutions
 <p data-bbox="144 636 181 656">Off</p>	<ul style="list-style-type: none"> * The HOLD function is deactivated because the vehicle is slipping or a condition for activation is not fulfilled. <ul style="list-style-type: none"> ► Reactivate the HOLD function later or check the activation conditions for the HOLD function (→ page 166).
 <p data-bbox="144 779 417 827">ATTENTION ASSIST Inoperative</p>	<ul style="list-style-type: none"> * ATTENTION ASSIST is malfunctioning. <ul style="list-style-type: none"> ► Consult a qualified specialist workshop.

Display messages	Possible causes/consequences and ► Solutions
 <p data-bbox="195 342 473 391">ATTENTION ASSIST: Take a Break!</p>	<ul style="list-style-type: none"> * ATTENTION ASSIST has detected fatigue or an increasing lack of concentration on the part of the driver (→ page 167). <ul style="list-style-type: none"> ► If necessary, take a break.
 <p data-bbox="195 513 282 534">--- mph</p>	<ul style="list-style-type: none"> * Cruise control cannot be activated as not all activation conditions are fulfilled. <ul style="list-style-type: none"> ► Observe the activation conditions for cruise control (→ page 170).
<p data-bbox="195 560 463 581">Cruise Control Inoperative</p>	<ul style="list-style-type: none"> * Cruise control is malfunctioning. <ul style="list-style-type: none"> ► Consult a qualified specialist workshop.
<p data-bbox="195 635 380 655">Cruise Control Off</p>	<ul style="list-style-type: none"> * Cruise control has been deactivated. <p data-bbox="547 666 1572 692">If there is an additional warning tone, cruise control has been deactivated automatically (→ page 169).</p>
 <p data-bbox="195 802 282 823">--- mph</p>	<ul style="list-style-type: none"> * Active Distance Assist DISTRONIC cannot be activated as not all activation conditions are fulfilled. <ul style="list-style-type: none"> ► Comply with the activation conditions of Active Distance Assist DISTRONIC (→ page 173).

Display messages	Possible causes/consequences and ► Solutions
 <p>Suspended</p>	<p>* If you depress the accelerator pedal beyond the Active Distance Assist DISTRONIC setting, the system will switch to passive mode (→ page 171).</p>
 <p>Off</p>	<p>* Active Distance Assist DISTRONIC was deactivated. If a warning tone also sounds, Active Distance Assist DISTRONIC has deactivated automatically (→ page 173).</p>
<p>Active Distance Assist Currently Unavailable See Operator's Manual</p>	<p>* Active Distance Assist DISTRONIC is temporarily unavailable. The ambient conditions are outside the system limits (→ page 171). As soon as the ambient conditions are within the system limits, the system will become available again.</p> <p>► Drive on.</p>
<p>Active Distance Assist Inoperative</p>	<p>* Active Distance Assist DISTRONIC is malfunctioning. Other driving systems and driving safety systems may also be malfunctioning.</p> <p>► Consult a qualified specialist workshop.</p>
<p>Active Distance Assist Now Available</p>	<p>* Active Distance Assist DISTRONIC is operational again.</p> <p>► Switch on Active Distance Assist DISTRONIC (→ page 173).</p>

Display messages	Possible causes/consequences and ► Solutions
Active Steering Assist Currently Unavailable See Operator's Manual	<p>* Active Steering Assist is temporarily unavailable. The ambient conditions are outside the system limits (→ page 178). As soon as the ambient conditions are within the system limits, the system will become available again.</p> <ul style="list-style-type: none"> ► Drive on. ► Check the tire pressure if necessary.
Active Steering Assist Inoperative	<p>* Active Steering Assist is malfunctioning. Active Distance Assist DISTRONIC remains available.</p> <ul style="list-style-type: none"> ► Consult a qualified specialist workshop.
Active Steering Asst. Currently Unavailable Due to Multiple Emergency Stops	<p>* Active Steering Assist is temporarily unavailable due to multiple emergency stops.</p> <ul style="list-style-type: none"> ► Take over the steering and stop in accordance with the traffic conditions. ► Switch the ignition off and switch it back on. Active Steering Assist is available once more.
Beginning Emergency Stop	<p>* Your hands are not on the steering wheel. An emergency stop is being initiated (→ page 180).</p> <ul style="list-style-type: none"> ► Put your hands back on the steering wheel. <p>You can cancel the deceleration at any time by performing one of the following actions:</p> <ul style="list-style-type: none"> • Steering • Braking or accelerating • Deactivating Active Distance Assist DISTRONIC



Display messages	Possible causes/consequences and ► Solutions
	<p>* Active Steering Assist has reached the system limits (→ page 178). You have not steered independently for a considerable period of time.</p> <p>► Take over the steering and drive on in accordance with the traffic conditions.</p>
<p>Active Stop & Go Assist Currently Unavailable See Operator's Manual</p>	<p>* Active Stop-and-Go Assist is temporarily unavailable. Active Distance Assist DISTRONIC and Active Steering Assist are still available.</p> <p>The ambient conditions are outside the system limits (→ page 177). As soon as the ambient conditions are within the system limits, the system will become available again.</p> <p>► Drive on.</p>
<p>Active Stop & Go Assist Inoperative See Operator's Manual</p>	<p>* Active Stop-and-Go Assist is malfunctioning.</p> <p>Active Stop-and-Go Assist has been deactivated. Active Distance Assist DISTRONIC and Active Steering Assist are still available.</p> <p>► Consult a qualified specialist workshop.</p>
<p>Traffic Sign Assist Cur- rently Unavailable See Operator's Manual</p>	<p>* Traffic Sign Assist is temporarily unavailable.</p> <p>When the cause of the problem is no longer present, the system will be available again.</p> <p>► Drive on.</p>
<p>Traffic Sign Assist Inopera- tive</p>	<p>* Traffic Sign Assist is malfunctioning.</p> <p>► Stop the vehicle in accordance with the traffic conditions and restart the engine.</p> <p>► If the display message still appears, consult a qualified specialist workshop.</p>



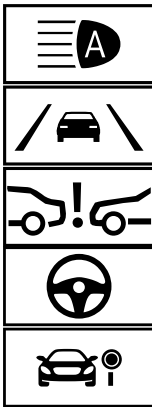

Display messages	Possible causes/consequences and ► Solutions
Blind Spot Assist Currently Unavailable See Operator's Manual	<p>* Blind Spot Assist is temporarily unavailable. The system limits have been reached (→ page 191). Once the cause of the problem is no longer present, the system will be available again.</p> <p>► Drive on. or ► If the display message does not disappear, stop the vehicle in accordance with the traffic conditions and restart the engine.</p>
Blind Spot Assist Inoperative	<p>* Blind Spot Assist is malfunctioning. ► Consult a qualified specialist workshop.</p>
Active Blind Spot Assist Currently Unavailable See Operator's Manual	<p>* Active Blind Spot Assist is temporarily unavailable. The system limits have been reached (→ page 191). Once the cause of the problem is no longer present, the system will be available again.</p> <p>► Drive on. or ► If the display message does not disappear, stop the vehicle in accordance with the traffic conditions and restart the engine.</p>
Active Blind Spot Assist Inoperative	<p>* Active Blind Spot Assist is malfunctioning. ► Consult a qualified specialist workshop.</p>

Display messages	Possible causes/consequences and ► Solutions
<p>Active Lane Keeping Assist Currently Unavailable See Operator's Manual</p>	<p>* Active Lane Keeping Assist is temporarily unavailable. The ambient conditions are outside the system limits (→ page 194). As soon as the ambient conditions are within the system limits, the system will become available again.</p> <p>► Drive on.</p>
<p>Active Lane Keeping Assist Inoperative</p>	<p>* Active Lane Keeping Assist is malfunctioning.</p> <p>► Consult a qualified specialist workshop.</p>
<div data-bbox="155 467 310 550" data-label="Image"> </div> <div data-bbox="155 553 310 636" data-label="Image"> </div> <div data-bbox="155 639 310 722" data-label="Image"> </div> <div data-bbox="155 725 310 808" data-label="Image"> </div> <p>Currently Unavailable Radar Sensors Dirty</p>	<p>* The radar sensor system is malfunctioning. Possible causes:</p> <ul style="list-style-type: none"> • Dirt on the sensors • Heavy rain or snow • Extended country driving without other traffic, e.g. in the desert <p>Driving systems and driving safety systems may be malfunctioning or temporarily unavailable. Once the cause of the problem is no longer present, the driving systems and driving safety systems will be available again.</p> <p>If the display message does not disappear:</p> <p>► Pull over and stop the vehicle safely as soon as possible, paying attention to road and traffic conditions.</p> <p>► Clean all sensors (→ page 272).</p> <p>► Restart the engine.</p>

Display messages	Possible causes/consequences and ► Solutions
 <p data-bbox="194 678 471 735">Currently Unavailable Camera View Restricted</p>	<p data-bbox="526 248 1016 274">* The camera view is restricted. Possible causes:</p> <ul data-bbox="545 279 1127 378" style="list-style-type: none"> <li data-bbox="545 279 1099 305">• Dirt on the windshield in the camera's field of vision <li data-bbox="545 310 813 336">• Heavy rain, snow or fog <li data-bbox="545 341 1127 378">• Condensation on the windshield in front of the camera <p data-bbox="545 388 1681 445">ⓘ Condensation detected on the windshield will be automatically removed with the aid of a built-in heater within approximately 12 minutes.</p> <p data-bbox="545 450 1478 481">Driving systems and driving safety systems may be malfunctioning or temporarily unavailable.</p> <p data-bbox="545 486 1700 543">Once the cause of the problem is no longer present, the driving systems and driving safety systems will be available again.</p> <p data-bbox="545 549 970 574">If the display message does not disappear:</p> <ul data-bbox="545 580 1617 647" style="list-style-type: none"> <li data-bbox="545 580 1617 611">► Pull over and stop the vehicle safely as soon as possible, paying attention to road and traffic conditions. <li data-bbox="545 616 924 647">► Clean the windshield if necessary.

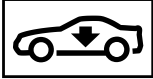
370 Display messages and warning/indicator lamps

Display messages	Possible causes/consequences and ► Solutions
 <p data-bbox="144 342 408 391">Malfunction Drive at Max. 50 mph</p>	<ul style="list-style-type: none">* AIR BODY CONTROL is functioning only to a limited extent. The vehicle's handling characteristics may be affected.<ul style="list-style-type: none">► Drive in a manner appropriate for the current level, but do not exceed 50 mph (80 km/h).► Consult a qualified specialist workshop.* DYNAMIC BODY CONTROL is malfunctioning. The vehicle's handling characteristics may be affected.<ul style="list-style-type: none">► Do not drive at speeds greater than 50 mph (80 km/h).► Consult a qualified specialist workshop.
 <p data-bbox="144 557 397 606">Stop Vehicle Vehicle Too Low</p>	<ul style="list-style-type: none">* You have pulled away despite the vehicle level being too low.<ul style="list-style-type: none">► Pull over and stop the vehicle safely as soon as possible, paying attention to road and traffic conditions. The vehicle will be raised to the selected vehicle level.► Wait until the display message disappears before pulling away. <p>If the display message does not disappear and a warning tone also sounds, AIR BODY CONTROL is malfunctioning:</p> <ul style="list-style-type: none">► Do not drive at speeds greater than 50 mph (80 km/h) and consult a qualified specialist workshop immediately. <div data-bbox="500 695 1646 837" style="border: 1px solid black; padding: 5px;"><p>! NOTE The tires on the front axle or the fenders could be damaged by large steering movements</p><ul style="list-style-type: none">► Avoid large steering movements while driving and listen for scraping sounds.► If you hear scraping sounds, pull over and stop the vehicle in accordance with the traffic conditions, and set a higher vehicle level if possible.</div>

Display messages	Possible causes/consequences and ► Solutions
	<ul style="list-style-type: none"> ► Set a higher vehicle level (→ page 197). Depending on the malfunction, the vehicle will be raised.
 <p>Lowering</p>	<ul style="list-style-type: none"> * The vehicle level may be lowered for the following reasons: <ul style="list-style-type: none"> • You have selected a different drive program. • You have exceeded the speed limit. • You have changed the vehicle level by pressing the button.
 <p>Vehicle Rising</p>	<ul style="list-style-type: none"> * Your vehicle is adjusting to the level you have selected.
 <p>Vehicle Rising Please Wait</p>	<ul style="list-style-type: none"> * The vehicle level is too low. The vehicle will be raised to the selected vehicle level. <ul style="list-style-type: none"> ► Wait until the display message disappears before pulling away.
 <p>Drive More Slowly</p>	<ul style="list-style-type: none"> * You are driving too fast for the selected vehicle level. <ul style="list-style-type: none"> ► To adjust the vehicle level, you must not drive at speeds greater than 37 mph (60 km/h).

372 Display messages and warning/indicator lamps

Display messages	Possible causes/consequences and ► Solutions
<p>Active Parking Assist and PARKTRONIC Inoperative See Operator's Manual</p>	<p>* Vehicles with Active Parking Assist: Active Parking Assist and Parking Assist PARKTRONIC are malfunctioning. Vehicles without Active Parking Assist: Parking Assist PARKTRONIC is malfunctioning.</p> <ul style="list-style-type: none">► Stop the vehicle in accordance with the traffic conditions and restart the engine.► If the display message still appears, consult a qualified specialist workshop.

Driving safety systems

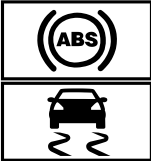
Display messages	Possible causes/consequences and ► Solutions
<div data-bbox="155 524 310 692"></div> <p>Currently Unavailable See Operator's Manual</p>	<p>* ABS and ESP® are temporarily unavailable. Other driving systems and driving safety systems (e.g. BAS) may also be temporarily unavailable. The brake system will continue to operate normally. The braking distance in an emergency braking situation can increase.</p> <div data-bbox="500 664 1646 702"><p>▲ WARNING Risk of skidding if ABS and ESP® are malfunctioning</p></div> <p>The wheels may lock during braking and ESP® does not perform any vehicle stabilization. The steerability and braking characteristics are heavily impaired and the braking distance may increase. In addition, other driving safety systems are switched off.</p> <ul style="list-style-type: none">► Drive carefully on a suitable stretch of road, making slight steering movements at a speed above 19 mph (30 km/h).

Display messages	Possible causes/consequences and ► Solutions
	<p>► If the display message does not disappear, consult a qualified specialist workshop immediately. Drive carefully.</p>
<div data-bbox="205 337 362 422" data-label="Image"> </div> <div data-bbox="205 422 362 505" data-label="Image"> </div> <p data-bbox="195 511 467 560">Inoperative See Operator's Manual</p>	<p>* ABS and ESP® are malfunctioning. Other driving systems and driving safety systems (e.g. BAS) may also be malfunctioning. The brake system will continue to operate normally. The braking distance in an emergency braking situation can increase.</p> <div data-bbox="547 474 1702 519" data-label="Section-Header"> <p>▲ WARNING Risk of skidding if ABS and ESP® are malfunctioning</p> </div> <p>The wheels may block during braking and ESP® does not perform any vehicle stabilization. The steerability and braking characteristics are heavily impaired and the braking distance may increase. In addition, other driving safety systems are switched off.</p> <p>► Drive on carefully. ► Have ABS and ESP® checked immediately at a qualified specialist workshop.</p>
<div data-bbox="205 712 362 795" data-label="Image"> </div> <p data-bbox="195 801 458 850">Currently Unavailable See Operator's Manual</p>	<p>* ESP® is temporarily unavailable. Other driving systems and driving safety systems (e.g. BAS) may also be malfunctioning.</p>

374 Display messages and warning/indicator lamps

Display messages	Possible causes/consequences and ► Solutions
	<p>▲ WARNING Risk of skidding if ESP is malfunctioning®</p> <p>If ESP® is malfunctioning, ESP® cannot carry out vehicle stabilization. In addition, other driving safety systems are switched off.</p> <ul style="list-style-type: none">► Drive carefully on a suitable stretch of road, making slight steering movements at a speed above 19 mph (30 km/h).► If the display message does not disappear, consult a qualified specialist workshop immediately. Drive carefully.
 <p>Inoperative See Operator's Manual</p>	<p>* ESP® is malfunctioning.</p> <p>Other driving systems and driving safety systems (e.g. BAS) may also be malfunctioning.</p> <p>The brake system will continue to operate normally. The braking distance in an emergency braking situation can increase.</p> <p>▲ WARNING Risk of skidding if ESP® is malfunctioning</p> <p>If ESP® is malfunctioning, ESP® cannot carry out vehicle stabilization. In addition, other driving safety systems are switched off.</p> <ul style="list-style-type: none">► Drive on carefully.► Have ESP® checked at a qualified specialist workshop.

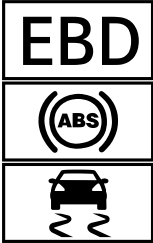
Display messages	Possible causes/consequences and ► Solutions
 <p data-bbox="195 513 469 560">Inoperative See Operator's Manual</p>	<p data-bbox="528 252 1424 311">* EBD, ABS and ESP® are malfunctioning. Other driving systems and driving safety systems (e.g. BAS) may also be malfunctioning.</p> <div data-bbox="547 329 1696 547" style="border: 1px solid gray; padding: 5px;"> <p data-bbox="565 339 1295 365">▲ WARNING Risk of skidding if EBD, ABS and ESP® are malfunctioning</p> <p data-bbox="565 381 1465 407">The wheels may block during braking and ESP® does not perform any vehicle stabilization.</p> <p data-bbox="565 417 1683 469">The steerability and braking characteristics are heavily impaired and the braking distance may increase. In addition, other driving safety systems are switched off.</p> <ul data-bbox="565 479 1387 536" style="list-style-type: none"> <li data-bbox="565 479 778 505">► Drive on carefully. <li data-bbox="565 515 1387 536">► Have the brake system checked immediately at a qualified specialist workshop. </div>
<p data-bbox="195 588 469 664">Active Brake Assist Functions Currently Limited See Operator's Manual</p>	<p data-bbox="528 588 1683 640">* Vehicles with the Driving Assistance Package: Active Brake Assist with cross-traffic function, Evasive Steering Assist or PRE-SAFE® PLUS are temporarily unavailable or only partially available.</p> <p data-bbox="547 650 1544 676">Vehicles without the Driving Assistance Package: Active Brake Assist is temporarily unavailable.</p> <ul data-bbox="547 686 1696 795" style="list-style-type: none"> <li data-bbox="547 686 1613 738">► Drive on. As soon as the ambient conditions are within the system limits, the system will become available again. <li data-bbox="547 749 1696 795">► If the display message does not disappear, stop the vehicle in accordance with the traffic conditions and restart the engine.

376 Display messages and warning/indicator lamps

Display messages	Possible causes/consequences and ► Solutions
Active Brake Assist Functions Limited See Operator's Manual	<ul style="list-style-type: none">* Vehicles with the Driving Assistance Package: Active Brake Assist with cross-traffic function, Evasive Steering Assist or PRE-SAFE® PLUS are temporarily unavailable or only partially available.Vehicles without the Driving Assistance Package: Active Brake Assist is temporarily unavailable or only partially available. <ul style="list-style-type: none">► Consult a qualified specialist workshop.



Mercedes me connect

Display messages	Possible causes/consequences and ► Solutions
Mercedes me connect Services Limited See Operator's Manual	<ul style="list-style-type: none">* The vehicle functions for fault detection are restricted. At least one of the main functions of the Mercedes me connect system is malfunctioning. <ul style="list-style-type: none">► Observe the notes on the diagnostics connection (→ page 25).► Consult a qualified specialist workshop.
 Inoperative	<ul style="list-style-type: none">* At least one of the main functions of the Mercedes me connect system or of the SOS emergency call system is malfunctioning. <ul style="list-style-type: none">► Consult a qualified specialist workshop.

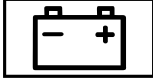
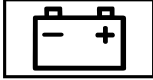
Battery

Display messages	Possible causes/consequences and ► Solutions
 <p data-bbox="194 383 443 429">12 V Battery See Operator's Manual</p>	<ul style="list-style-type: none"> * The engine is off and the charge level is too low. <ul style="list-style-type: none"> ► Switch off electrical consumers that are not required. To charge the 12 V battery: <ul style="list-style-type: none"> ► Leave the engine running for a few minutes, or drive an extended distance. * If the message appears while the engine is running, this indicates an on-board electrical system malfunction. <ul style="list-style-type: none"> ► Consult a qualified specialist workshop.
 <p data-bbox="194 611 425 637">See Operator's Manual</p>	<ul style="list-style-type: none"> * The 12 V battery is not being charged. <div style="border: 1px solid gray; padding: 5px; margin: 10px 0;"> <p>! NOTE Possible engine damage if you continue driving</p> <ul style="list-style-type: none"> ► Do not continue driving under any circumstances. ► Consult a qualified specialist workshop. </div> <ul style="list-style-type: none"> ► Pull over and stop the vehicle safely and switch off the engine, paying attention to road and traffic conditions. ► Consult a qualified specialist workshop.

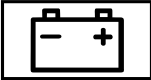
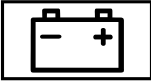

378 Display messages and warning/indicator lamps

Display messages	Possible causes/consequences and ► Solutions
 <p data-bbox="144 342 391 391">Stop Vehicle See Operator's Manual</p>	<p data-bbox="476 249 1245 273">* The 12 V battery is no longer being charged and the charge level is too low.</p> <div data-bbox="500 291 1646 412" style="border: 1px solid black; padding: 5px;"><p data-bbox="513 301 1092 325">! NOTE Possible engine damage if you continue driving</p><ul data-bbox="513 342 1045 401" style="list-style-type: none"><li data-bbox="513 342 1045 366">► Do not continue driving under any circumstances.<li data-bbox="513 373 1045 401">► Consult a qualified specialist workshop.</div> <ul data-bbox="495 428 1480 522" style="list-style-type: none"><li data-bbox="495 428 1480 452">► Stop the vehicle immediately in accordance with the traffic conditions. Do not continue driving.<li data-bbox="495 459 750 483">► Switch off the engine.<li data-bbox="495 491 925 522">► Consult a qualified specialist workshop.
 <p data-bbox="144 632 413 681">Stop Vehicle Leave Engine Running</p>	<p data-bbox="476 539 894 563">* The 12 V battery charge level is too low.</p> <ul data-bbox="495 570 1480 698" style="list-style-type: none"><li data-bbox="495 570 1480 594">► Stop the vehicle immediately in accordance with the traffic conditions. Do not continue driving.<li data-bbox="495 601 787 625">► Leave the engine running.<li data-bbox="495 632 1153 656">► Wait until the display message disappears before pulling away.<li data-bbox="495 664 1393 698">► If the display message does not disappear: consult a qualified specialist workshop.
 <p data-bbox="144 812 391 860">48 V Battery See Operator's Manual</p>	<p data-bbox="476 718 1485 742">* The 48 V on-board electrical system has function restrictions. Comfort functions may be restricted.</p> <ul data-bbox="495 750 1055 773" style="list-style-type: none"><li data-bbox="495 750 1055 773">► Consult a qualified specialist workshop immediately.

Display messages	Possible causes/consequences and ► Solutions
 <p data-bbox="195 342 463 391">Please Wait Charging 48 V Battery...</p>	<p data-bbox="524 249 1683 301">* The 48 V battery is discharged. You have switched on the ignition while the 12 V battery was being charged with a suitable charger or while another vehicle was providing starting assistance.</p> <p data-bbox="543 311 1655 363">The discharged 48 V battery is charged automatically via the voltage converter. After a few minutes, the Engine Can Now Be Started display message will be shown on the multifunction display.</p> <ul style="list-style-type: none"> <li data-bbox="543 373 750 399">► Start the engine. <li data-bbox="543 410 1655 456">► Drive the vehicle for a while to charge the 12 V battery and the 48 V battery after disconnecting the charger from the vehicle. <p data-bbox="543 482 1424 508">If the Engine Can Now Be Started display message does not appear after a few minutes:</p> <ul style="list-style-type: none"> <li data-bbox="543 519 870 544">► Try to start the engine again. <li data-bbox="543 555 1258 581">► If the engine does not start, consult a qualified specialist workshop.
<p data-bbox="195 594 445 643">Cannot Start Engine See Operator's Manual</p>	<p data-bbox="524 594 1363 620">* The charge level of the 48 V battery is too low. You can no longer start the engine.</p> <ul style="list-style-type: none"> <li data-bbox="543 630 1116 656">► Switch off electrical consumers that are not required. <li data-bbox="543 667 1696 739">► Connect a suitable charger approved for Mercedes-Benz with sufficient charge output to the jump-start connection point of the 12 V battery (→ page 287). The 48 V battery is charged via the voltage converter in the vehicle.
<p data-bbox="195 757 473 783">Engine Can Now Be Started</p>	<p data-bbox="524 757 1295 783">* The 48 V battery has been charged automatically via the voltage converter.</p> <ul style="list-style-type: none"> <li data-bbox="543 793 1548 819">► Start the engine and drive the vehicle for a while to charge the 12 V battery and the 48 V battery.

Tire pressure monitor

Display messages	Possible causes/consequences and ► Solutions
Tire Press. Monitor Currently Unavailable	<p>* There is interference from a powerful radio signal source. As a result, no signals from the tire pressure sensors are being received. The tire pressure monitoring system is temporarily unavailable. The tire pressure monitoring system will restart automatically as soon as the cause has been rectified.</p> <p>► Drive on.</p>
Tire Press. Monitor Inoperative	<p>* The tire pressure monitoring system is malfunctioning.</p> <div style="border: 1px solid gray; padding: 5px; margin: 10px 0;"> <p>⚠ WARNING There is a risk of an accident if the tire pressure monitoring system is malfunctioning</p> <p>The tire pressure monitoring system cannot issue a warning if there is pressure loss in one or more of the tires. Tires with insufficient tire pressure may impair the driving characteristics as well as steering and braking.</p> <p>► Have the tire pressure monitoring system checked at a qualified specialist workshop.</p> </div>
Tire Pressure Monitor Inoperative No Wheel Sensors	<p>* The wheels installed do not have suitable tire pressure sensors. The tire pressure monitoring system is deactivated.</p> <p>► Install wheels with suitable tire pressure sensors.</p>
 Wheel Sensor(s) Missing	<p>* There is no signal from the tire pressure sensors of one or more wheels. No pressure value is displayed for the affected tire.</p> <p>► Have the faulty tire pressure sensor replaced at a qualified specialist workshop.</p>

Display messages	Possible causes/consequences and ► Solutions
 <p data-bbox="195 342 316 365">Check Tires</p>	<p data-bbox="524 249 1548 272">* The tire pressure in one or more tires has dropped significantly. The wheel position will be displayed.</p> <div data-bbox="547 291 1698 555" style="border: 1px solid gray; padding: 5px;"> <p data-bbox="565 301 1230 324">▲ WARNING Risk of an accident due to insufficient tire pressure</p> <ul data-bbox="565 342 1467 436" style="list-style-type: none"> • The tires can burst. • The tires can wear excessively and/or unevenly. • The driving characteristics as well as the steering and braking may be greatly impaired. <p data-bbox="565 453 981 474">You could then lose control of the vehicle.</p> <ul data-bbox="565 487 1021 544" style="list-style-type: none"> ► Observe the recommended tire pressures. ► Adjust the tire pressure if necessary. </div> <ul data-bbox="547 572 1156 629" style="list-style-type: none"> ► Stop the vehicle in accordance with the traffic conditions. ► Check the tire pressure (→ page 297) and the tires.
 <p data-bbox="195 743 445 790">Please Correct Tire Pressure</p>	<p data-bbox="524 650 1646 697">* The tire pressure is too low in at least one of the tires, or the difference in tire pressure between the individual wheels is too great.</p> <ul data-bbox="547 710 1397 767" style="list-style-type: none"> ► Check the tire pressure and add air, if necessary. ► When the tire pressure is correct, restart the tire pressure monitor (→ page 302).

Display messages	Possible causes/consequences and ► Solutions
<div data-bbox="153 249 312 334" data-label="Image"> </div> <p data-bbox="144 339 399 365">Warning Tire Malfunction</p>	<p data-bbox="473 246 1471 272">* The tire pressure in one or more tires has dropped suddenly. The wheel position will be displayed.</p> <div data-bbox="513 291 1648 334" data-label="Text"> <p>▲ WARNING Risk of an accident from driving with a flat tire</p> </div> <ul data-bbox="513 339 1572 399" style="list-style-type: none"> • The tires may overheat and be damaged. • The driving characteristics as well as the steering and braking characteristics may be greatly impaired. <p data-bbox="513 415 931 441">You could then lose control of the vehicle.</p> <ul data-bbox="513 451 1609 544" style="list-style-type: none"> ► Do not drive with a flat tire. ► Do not exceed the maximum driving distance permissible in emergency mode with a flat MOExtended tire. ► Observe the notes on flat tires. <p data-bbox="491 570 953 596">Notes in the event of a flat tire (→ page 277).</p> <ul data-bbox="491 607 1110 664" style="list-style-type: none"> ► Stop the vehicle in accordance with the traffic conditions. ► Check the tires.
<p data-bbox="144 679 319 705">Tires Overheated</p>	<p data-bbox="473 679 1641 731">* At least one tire is overheating. The affected tires are displayed in red. At temperatures close to the limit value, the tires are displayed in yellow.</p> <div data-bbox="513 752 1648 795" data-label="Text"> <p>▲ WARNING Risk of an accident from driving with overheated tires</p> </div> <p data-bbox="513 800 787 826">Overheated tires can burst.</p> <ul data-bbox="513 831 972 857" style="list-style-type: none"> ► Reduce speed so that the tires cool down.

Display messages	Possible causes/consequences and ► Solutions
Decrease Speed	<p>* At least one tire is overheating. The affected tires are displayed in red. At temperatures close to the limit value, the tires are displayed in yellow.</p> <p>▲ WARNING Risk of an accident from driving with overheated tires</p> <p>Overheated tires can burst.</p> <p>► Reduce speed so that the tires cool down.</p>



Tire pressure loss warning system



Display messages	Possible causes/consequences and ► Solutions
Check Tire Pressure Soon	<p>* Canada only: The tire pressure loss warning system has detected a significant loss of pressure.</p> <p>▲ WARNING Risk of an accident due to insufficient tire pressure</p> <ul style="list-style-type: none"> • The tires can burst. • The tires can wear excessively and/or unevenly. • The driving characteristics as well as the steering and braking may be greatly impaired. <p>You could then lose control of the vehicle.</p>

384 Display messages and warning/indicator lamps

Display messages	Possible causes/consequences and ► Solutions
	<ul style="list-style-type: none">▶ Observe the recommended tire pressures.▶ Adjust the tire pressure if necessary. <ul style="list-style-type: none">▶ Stop the vehicle in accordance with the traffic conditions.▶ Check the tire pressure (→ page 297) and the tires.▶ When the tire pressure is correct, restart the tire pressure loss warning system (→ page 303).
Check Tire Pressure Then Restart Run Flat Indicator	<p>* Canada only: The tire pressure loss warning system generated a display message and has not been restarted since.</p> <ul style="list-style-type: none">▶ When the tire pressure is correct, restart the tire pressure loss warning system (→ page 303).
Run Flat Indicator Inoperative	<p>* Canada only: The tire pressure loss warning system is malfunctioning.</p> <ul style="list-style-type: none">▶ Consult a qualified specialist workshop.

Engine oil

Display messages	Possible causes/consequences and ► Solutions
 <p data-bbox="195 384 426 433">Check Engine Oil Level (Add 1 quart)</p>	<p data-bbox="528 291 1086 313">* The engine oil level has dropped to the minimum level.</p> <div data-bbox="565 332 1696 370" style="border: 1px solid gray; padding: 2px;"> <p data-bbox="565 342 1271 365">! NOTE Engine damage caused by driving with insufficient engine oil</p> </div> <div data-bbox="565 381 1696 419" style="border: 1px solid gray; padding: 2px;"> <p data-bbox="565 386 1068 409">► Avoid long journeys with insufficient engine oil.</p> </div> <p data-bbox="543 436 1252 458">► When next refueling, add 1.1 US qt (1 l) of engine oil (→ page 267).</p> <p data-bbox="543 477 892 500">Notes on engine oil (→ page 333).</p>
 <p data-bbox="195 615 469 638">Engine Oil Reduce Oil Level</p>	<p data-bbox="528 522 851 544">* The engine oil level is too high.</p> <div data-bbox="565 563 1696 601" style="border: 1px solid gray; padding: 2px;"> <p data-bbox="565 573 1230 596">! NOTE Engine damage caused by driving with excess engine oil</p> </div> <div data-bbox="565 612 1696 650" style="border: 1px solid gray; padding: 2px;"> <p data-bbox="565 617 1023 640">► Avoid long journeys with excess engine oil.</p> </div> <p data-bbox="543 667 1480 689">► Consult a qualified specialist workshop immediately and have the engine oil level reduced.</p>
 <p data-bbox="195 801 458 850">Engine Oil Level Low Stop Vehicle Turn Engine Off</p>	<p data-bbox="528 708 842 731">* The engine oil level is too low.</p> <div data-bbox="565 750 1696 788" style="border: 1px solid gray; padding: 2px;"> <p data-bbox="565 760 1271 783">! NOTE Engine damage caused by driving with insufficient engine oil</p> </div> <div data-bbox="565 798 1696 837" style="border: 1px solid gray; padding: 2px;"> <p data-bbox="565 803 1068 826">► Avoid long journeys with insufficient engine oil.</p> </div> <p data-bbox="543 853 1530 876">► Stop the vehicle immediately in accordance with the traffic conditions. Do not continue driving.</p>

Display messages	Possible causes/consequences and ► Solutions
	<ul style="list-style-type: none"> ► Switch off the engine. ► Add 1.1 US qt (1 l) of engine oil (→ page 267). ► Check the engine oil level. <p>Notes on engine oil (→ page 333).</p>
 <p>Engine Oil Pressure Stop Switch Off Engine</p>	<p>* The oil pressure is too low.</p> <div style="border: 1px solid black; padding: 5px; margin: 5px 0;"> <p>! NOTE Engine damage caused by driving with insufficient oil pressure</p> </div> <ul style="list-style-type: none"> ► Avoid driving with insufficient oil pressure. ► Stop the vehicle immediately in accordance with the traffic conditions. Do not continue driving. ► Consult a qualified specialist workshop.
 <p>Engine Oil Level Cannot Be Measured</p>	<p>* The electrical connection to the oil level sensor has been interrupted or the oil level sensor is faulty.</p> <ul style="list-style-type: none"> ► Consult a qualified specialist workshop.

Warning and indicator lamps

Overview of indicator and warning lamps





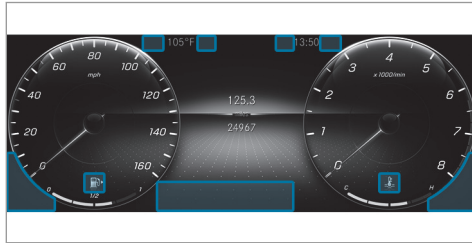

















Some systems will perform a self-test when the ignition is switched on. Some indicator and warning lamps may briefly light up or flash. This behavior is non-critical. These indicator and warning lamps indicate a malfunction only if they light up or flash after the engine has been started or during a journey.

Instrument Display





Depending on the display setting, the positions of the indicator lamps on the Instrument Display may differ from the example shown.

Indicator and warning lamps:

	Restraint system (→ page 388)		Distance warning (→ page 396)
	Seat belt (→ page 388)		AIR BODY CONTROL (→ page 396)
	Power steering (→ page 389)		DYNAMIC BODY CONTROL (→ page 396)
	Coolant temperature (→ page 390)		ABS (→ page 397)
	Check Engine (→ page 390)		ESP® (→ page 397)
	Electrical malfunction (→ page 390)		ESP® OFF (→ page 397)
	Reserve fuel with fuel filler flap location indicator (→ page 390)		Tire pressure monitoring system (→ page 399)
PARK	USA: electric parking brake (red) (→ page 393)		Parking lamps (→ page 114)
	Canada: electric parking brake (red) (→ page 393)		Low beam (→ page 114)
	USA: electric parking brake (yellow) (→ page 393)		High beam (→ page 115)
RBS	USA: Recuperative Brake System (→ page 393)		Turn signal lights (→ page 115)
	Canada: brakes (yellow) (→ page 393)		Rear fog light (→ page 114)
BRAKE	USA: brakes (red) (→ page 393)		
	Canada: brakes (red) (→ page 393)		

Occupant safety

Warning/indicator lamp	Possible causes/consequences and ► Solutions
 <p data-bbox="144 381 402 430">Restraint system warning lamp</p>	<p data-bbox="463 288 1191 337">* The red restraint system warning lamp is lit while the engine is running. The restraint system is malfunctioning (→ page 36).</p> <div data-bbox="482 358 1646 477" style="border: 1px solid gray; padding: 5px;"> <p data-bbox="513 365 1221 391">▲WARNING Risk of injury due to malfunctions in the restraint system</p> <p data-bbox="495 407 1591 430">Components in the restraint system may be activated unintentionally or not deploy as planned in an accident.</p> <ul style="list-style-type: none"> <li data-bbox="495 441 1480 465">► Have the restraint system checked and repaired immediately at a qualified specialist workshop. </div> <ul style="list-style-type: none"> <li data-bbox="476 493 694 516">► Drive on carefully. <li data-bbox="476 527 994 551">► Note the messages on the multifunction display. <li data-bbox="476 561 1036 585">► Consult a qualified specialist workshop immediately.
 <p data-bbox="144 695 376 744">Seat belt warning lamp flashes</p>	<p data-bbox="463 601 1419 651">* The red seat belt warning lamp flashes and an intermittent warning tone sounds. The driver or front passenger has not fastened his/her seat belt while the vehicle is in motion.</p> <ul style="list-style-type: none"> <li data-bbox="476 667 864 691">► Fasten your seat belt (→ page 40). There are objects on the front passenger seat. <li data-bbox="476 724 1021 747">► Remove the objects from the front passenger seat.

Warning/indicator lamp	Possible causes/consequences and ► Solutions
 <p data-bbox="195 342 426 394">Seat belt warning lamp lights up</p>	<p data-bbox="513 249 1378 275">* The red seat belt warning lamp lights up for six seconds once the engine has started.</p> <p data-bbox="528 283 1055 309">In addition, an intermittent warning tone may sound.</p> <p data-bbox="528 311 1489 337">The red seat belt warning lamp reminds the driver and front passenger to fasten their seat belts.</p> <p data-bbox="528 342 916 368">► Fasten your seat belt (→ page 40).</p> <p data-bbox="528 387 1541 413">If you have placed objects on the front passenger seat, the red seat belt warning lamp may remain lit.</p>

Vehicle

Warning/indicator lamp	Possible causes/consequences and ► Solutions
 <p data-bbox="195 645 432 697">Power steering warning lamp (red)</p>	<p data-bbox="513 552 1304 578">* The red power steering system warning lamp is lit while the engine is running.</p> <p data-bbox="528 580 1134 606">The power assistance or the steering itself is malfunctioning.</p> <div data-bbox="528 622 1703 801" style="border: 1px solid gray; padding: 5px;"> <p data-bbox="565 628 1188 654">▲WARNING Risk of accident if steering capability is impaired</p> <p data-bbox="547 670 1446 696">If the steering does not function as intended, the vehicle's operating safety is jeopardized.</p> <ul style="list-style-type: none"> <li data-bbox="547 705 1655 757">► Pull over and stop the vehicle safely as soon as possible, paying attention to road and traffic conditions. Do not continue driving under any circumstances. <li data-bbox="547 766 979 792">► Consult a qualified specialist workshop. </div> <p data-bbox="528 817 1045 843">► Note the messages on the multifunction display.</p>

Engine

Warning/indicator lamp



Coolant warning lamp (red)

Possible causes/consequences and Solutions

* The red coolant warning lamp is lit while the engine is running.

Possible causes:

- The temperature sensor is malfunctioning
- The coolant level is too low
- The air supply to the radiator is obstructed
- The radiator fan is faulty
- The engine coolant pump is faulty



If there is an additional warning tone, the coolant temperature has exceeded the maximum permissible temperature.

⚠ WARNING Danger of burns when opening the hood



If you open the hood when the engine has overheated or during a fire in the engine compartment, you could come into contact with hot gases or other escaping operating fluids.

- ▶ Before opening the hood, allow the engine to cool down.
- ▶ In the event of a fire in the engine compartment, keep the hood closed and call the fire service.

- ▶ Stop the vehicle immediately in accordance with the traffic conditions and switch off the engine. Do not continue driving under any circumstances.
- ▶ Note the messages on the multifunction display.



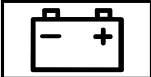

Warning/indicator lamp	Possible causes/consequences and ► Solutions
	<p>If the coolant temperature display is at the lower end of the temperature scale:</p> <ul style="list-style-type: none"> ► Consult a qualified specialist workshop. <p>If the coolant temperature display is at the upper end of the temperature scale:</p> <ul style="list-style-type: none"> ► Exit the vehicle and keep a safe distance from it until the engine has cooled down. ► Check the coolant level (→ page 268). ► Make sure that the air supply to the radiator is not obstructed. ► Avoiding high loads on the engine, drive to the nearest qualified specialist workshop. In doing so, ensure that the coolant temperature display remains below the red area.
 <p>Coolant warning lamp (yellow)</p>	<p>* The yellow coolant warning lamp is lit while the engine is running.</p> <p>Possible causes:</p> <ul style="list-style-type: none"> • The temperature sensor is malfunctioning • The charge air, transmission oil or battery cooling is faulty <ul style="list-style-type: none"> ► Avoiding high loads on the engine, drive to the nearest qualified specialist workshop.
 <p>Engine diagnosis warning lamp</p>	<p>* The yellow Check Engine warning lamp is lit while the engine is running. A malfunction has occurred in the engine, the exhaust system or the fuel system. The emission limit values may be exceeded and the engine may be in emergency mode.</p> <p>In some states, legal requirements stipulate that you must immediately consult a qualified specialist workshop as soon as the yellow Check Engine warning lamp lights up.</p>

392 Display messages and warning/indicator lamps

Warning/indicator lamp	Possible causes/consequences and ► Solutions
 <p data-bbox="144 381 428 433">Electrical malfunction warning lamp</p>	<ul style="list-style-type: none"><li data-bbox="476 249 1313 272">► Have the vehicle checked as soon as possible at a qualified specialist workshop. <p data-bbox="458 291 898 337">* The red electrical fault warning lamp is lit. There is a fault in the electrics.</p> <ul style="list-style-type: none"><li data-bbox="476 353 994 376">► Note the messages on the multifunction display.
 <p data-bbox="144 541 413 593">Fuel reserve warning lamp flashes</p>	<p data-bbox="458 452 1631 526">* The yellow fuel reserve warning lamp lights up while you are driving. There has been pressure loss in the fuel system. The fuel filler cap is not closed correctly or the fuel system is leaking.</p> <ul style="list-style-type: none"><li data-bbox="476 541 750 564">► Close the fuel filler cap. <p data-bbox="476 588 1014 611">If the fuel filler cap has already been closed correctly:</p> <ul style="list-style-type: none"><li data-bbox="476 624 911 647">► Consult a qualified specialist workshop.
 <p data-bbox="144 753 413 804">Fuel reserve warning lamp lights up</p>	<p data-bbox="458 664 1221 710">* The yellow fuel reserve warning lamp lights up while the engine is running. The fuel supply has dropped into the reserve range.</p> <ul style="list-style-type: none"><li data-bbox="476 726 583 749">► Refuel.



Brakes

Warning/indicator lamp	Possible causes/consequences and ► Solutions
<div data-bbox="203 295 360 372" data-label="Image"> </div> <p data-bbox="194 383 471 429">Electric parking brake indicator lamp (red) (USA only)</p> <div data-bbox="203 440 360 518" data-label="Image"> </div> <p data-bbox="194 528 471 606">Electric parking brake indicator lamp (red) (Canada only)</p> <div data-bbox="203 616 360 694" data-label="Image"> </div> <p data-bbox="194 704 471 751">The electric parking brake (yellow) indicator lamp</p>	<p data-bbox="517 290 1136 315">* The red electric parking brake indicator lamp flashes or is lit.</p> <p data-bbox="517 326 1450 352">The yellow electric parking brake indicator lamp also lights up in the event of a malfunction.</p> <ul data-bbox="517 352 1044 378" style="list-style-type: none"> ► Note the messages on the multifunction display.



Warning/indicator lamp	Possible causes/consequences and ► Solutions
 <p>Recuperative Brake System warning lamp (USA only)</p>  <p>Brakes warning lamp (yellow) (Canada only)</p>	<p>*The yellow  warning lamp (USA only) or the yellow  brakes warning lamp (Canada only) is lit while the engine is running.</p> <p>▲WARNING Risk of an accident due to a brake system malfunction</p> <p>If the brake system is malfunctioning, braking characteristics may be impaired.</p> <ul style="list-style-type: none">▶ Drive on carefully.▶ Have the brake system checked immediately at a qualified specialist workshop. <ul style="list-style-type: none">▶ Adjust your speed and drive on carefully, leaving a suitable distance to the vehicle in front.▶ If the multifunction display shows a display message, observe it.▶ Consult a qualified specialist workshop.



Warning/indicator lamp	Possible causes/consequences and ► Solutions
<div data-bbox="205 254 362 335" data-label="Image"> </div> <p data-bbox="195 342 452 394">Brake warning lamp (USA only)</p> <div data-bbox="205 399 362 480" data-label="Image"> </div> <p data-bbox="195 487 473 539">Brake system warning lamp (Canada only)</p>	<p data-bbox="513 249 1212 275">* The red brake system warning lamp is lit while the engine is running.</p> <p data-bbox="526 283 694 306">Possible causes:</p> <ul data-bbox="534 319 1478 377" style="list-style-type: none"> • The brake force boosting is malfunctioning and the braking characteristics may be affected. • There is insufficient brake fluid in the brake fluid reservoir. <p data-bbox="526 394 1045 420">► Note the messages on the multifunction display.</p> <div data-bbox="526 436 1703 477" data-label="Section-Header"> <p>⚠ WARNING Risk of accident and injury if brake force boosting is malfunctioning</p> </div> <p data-bbox="545 484 1670 536">If brake force boosting is malfunctioning, increased brake pedal force may be necessary for braking. The braking characteristics may be impaired. The braking distance can increase in emergency braking situations.</p> <ul data-bbox="545 547 1182 605" style="list-style-type: none"> ► Stop in a safe location immediately. Do not continue driving. ► Consult a qualified specialist workshop. <div data-bbox="526 622 1703 664" data-label="Section-Header"> <p>⚠ WARNING Risk of an accident due to low brake fluid level</p> </div> <p data-bbox="545 681 1544 707">If the brake fluid level is too low, the braking effect and the braking characteristics may be impaired.</p> <ul data-bbox="545 717 1653 838" style="list-style-type: none"> ► Pull over and stop the vehicle safely as soon as possible, paying attention to road and traffic conditions. Do not continue driving under any circumstances. ► Consult a qualified specialist workshop. ► Do not add brake fluid.

Driving systems

Warning/indicator lamp	Possible causes/consequences and ► Solutions
 <p data-bbox="144 381 426 433">Active Brake Assist warning lamp</p>	<p data-bbox="458 288 970 339">* The white Active Brake Assist warning lamp is lit. The system is switched off or unavailable.</p>
 <p data-bbox="144 539 412 591">Warning lamp for distance warning function</p>	<p data-bbox="458 449 1386 534">* The red distance warning lamp lights up while the vehicle is in motion. The distance to the vehicle in front is too small for the speed selected. If there is an additional warning tone, you are approaching an obstacle at too high a speed.</p> <ul style="list-style-type: none"> <li data-bbox="476 539 859 567">► Be prepared to brake immediately. <li data-bbox="476 572 735 600">► Increase the distance. <p data-bbox="476 617 942 645">Function of Active Brake Assist (→ page 182).</p>
 <p data-bbox="144 750 408 801">Suspension warning lamp (yellow)</p>	<p data-bbox="458 659 1099 745">* The yellow AIR BODY CONTROL warning lamp is lit. The yellow DYNAMIC BODY CONTROL warning lamp is lit. A malfunction has occurred in the AIR BODY CONTROL.</p> <p data-bbox="476 751 1099 779">A malfunction has occurred in the DYNAMIC BODY CONTROL.</p> <ul style="list-style-type: none"> <li data-bbox="476 784 997 812">► Note the messages on the multifunction display.

Driving safety systems

Warning/indicator lamp	Possible causes/consequences and ► Solutions
 <p data-bbox="195 384 380 408">ABS warning lamp</p>	<p data-bbox="513 291 1151 339">* The yellow ABS warning lamp is lit while the engine is running. ABS is malfunctioning.</p> <p data-bbox="526 350 1132 373">If there is an additional warning tone, EBD is malfunctioning.</p> <p data-bbox="526 384 1304 408">Other driving systems and driving safety systems may also be malfunctioning.</p> <ul style="list-style-type: none"> <li data-bbox="526 418 1045 442">► Note the messages on the multifunction display. <div style="border: 1px solid black; padding: 5px; margin-top: 10px;"> <p data-bbox="565 470 1278 494">⚠ WARNING There is a risk of skidding if EBD or ABS is malfunctioning</p> <p data-bbox="547 511 911 535">The wheels may lock during braking.</p> <p data-bbox="547 545 1665 594">The steerability and braking characteristics are heavily impaired and the braking distance may increase. In addition, other driving safety systems are switched off.</p> <ul style="list-style-type: none"> <li data-bbox="547 605 763 628">► Drive on carefully. <li data-bbox="547 639 1373 663">► Have the brake system checked immediately at a qualified specialist workshop. </div>
 <p data-bbox="195 785 469 809">ESP® warning lamp flashes</p>	<p data-bbox="513 695 1215 743">* The yellow ESP® warning lamp flashes while the vehicle is in motion. One or more wheels has reached its grip limit (→ page 163).</p> <ul style="list-style-type: none"> <li data-bbox="526 754 1206 778">► Adapt your driving style to suit the road and weather conditions.

Warning/indicator lamp	Possible causes/consequences and ► Solutions
 <p>ESP® warning lamp lights up</p>	<p>* The yellow ESP® warning lamp is lit while the engine is running. ESP® is malfunctioning. Other driving systems and driving safety systems (e.g. BAS) may also be malfunctioning.</p> <p>► Note the messages on the multifunction display.</p> <p>▲WARNING Risk of skidding if ESP® is malfunctioning</p> <p>If ESP® is malfunctioning, ESP® cannot carry out vehicle stabilization. In addition, other driving safety systems are switched off.</p> <ul style="list-style-type: none">► Drive on carefully.► Have ESP® checked at a qualified specialist workshop.
 <p>ESP® OFF warning lamp</p>	<p>* The yellow ESP® OFF warning lamp is lit while the engine is running. ESP® is deactivated. Other driving systems and driving safety systems may also be inoperative.</p> <p>▲WARNING Risk of skidding when driving with ESP® deactivated</p> <p>ESP® does not act to stabilize the vehicle. The availability of further driving safety systems is also limited.</p> <ul style="list-style-type: none">► Drive on carefully.► Deactivate ESP® only for as long as the situation requires.

Warning/indicator lamp	Possible causes/consequences and ► Solutions
	<p>If ESP® cannot be activated, ESP® is malfunctioning.</p> <ul style="list-style-type: none"> ► Have ESP® checked immediately at a qualified specialist workshop. <p>► Observe the notes on deactivating ESP® (→ page 163).</p>

Tire pressure monitor

Warning/indicator lamp	Possible causes/consequences and ► Solutions
 <p>Tire pressure monitoring system warning lamp flashes</p>	<p>*The yellow tire pressure monitor warning lamp (pressure loss/malfunction) flashes for approximately one minute and then remains lit. The tire pressure monitor is malfunctioning.</p> <p>▲WARNING There is a risk of an accident if the tire pressure monitoring system is malfunctioning</p> <p>The tire pressure monitoring system cannot issue a warning if there is pressure loss in one or more of the tires. Tires with insufficient tire pressure may impair the driving characteristics as well as steering and braking.</p> <ul style="list-style-type: none"> ► Have the tire pressure monitoring system checked at a qualified specialist workshop.

Warning/indicator lamp



Tire pressure monitoring system warning lamp lights up

Possible causes/consequences and ► Solutions

* The yellow tire pressure monitoring system warning lamp (pressure loss/malfunction) is lit.
The tire pressure monitoring system has detected tire pressure loss in at least one of the tires.

▲ WARNING Risk of an accident due to insufficient tire pressure

- The tires can burst.
- The tires can wear excessively and/or unevenly.
- The driving characteristics as well as the steering and braking may be greatly impaired.

You could then lose control of the vehicle.

- ▶ Observe the recommended tire pressures.
- ▶ Adjust the tire pressure if necessary.

- ▶ Stop the vehicle in accordance with the traffic conditions.
- ▶ Check the tire pressure and the tires.

1, 2, 3 ...

4MATIC	151
Function	151
12 V battery	
see Battery (vehicle)	
12 V socket	
see Socket (12 V)	
48 V on-board electrical system	
Operating safety	23
115 V socket	
see Socket (115 V)	
360° Camera	201
Function	201
Opening the camera cover (rear view camera)	203
Selecting a view	203

A

A/C function

Activating/deactivating (MBUX multimedia system)	128
Switching on/off (control panel)	128

ABS (Anti-lock Braking System) 163**Acceleration**

 see Kickdown

Accident and Breakdown Management

Mercedes me connect	244
---------------------------	-----

Acoustic locking verification signal

Activating/deactivating	65
-------------------------------	----

Active Blind Spot Assist 191

Brake application	193
Function	191
System limitations	191

Active Brake Assist

Function/notes	182
Setting	186

Active Distance Assist DISTRONIC 171

Active Emergency Stop Assist	180
Active Lane Change Assist	181
Calling up a speed	173
Function	171
Increasing/decreasing speed	173
Requirements	173
Route-based speed adaptation	176
Steering wheel buttons	173
Storing a speed	173

Switching off/deactivating	173
Switching on/activating	173
System limitations	171

Active Emergency Stop Assist 180

Active Lane Change Assist	181
Activating/deactivating	182
Function	181

Active Lane Keeping Assist 194

Activating/deactivating	195
Activating/deactivating the warning ...	196
Function	194
Setting the sensitivity	196
System limits	194

Active Parking Assist 208

Exiting a parking space	211
Function	208
Parking	210
System limitations	208

Active Service System PLUS

 see ASSYST PLUS

Active Speed Limit Assist 175

Display	175
Function	175

- Active Steering Assist** 178
 Activating/deactivating 180
 Active Emergency Stop Assist 180
 Active Lane Change Assist 181
 Function 178
 System limits 178
- Active Traffic Jam Assist**
 Activating/deactivating 178
 Function 177
- Adaptive cruise control**
 see Active Distance Assist DISTRONIC
- Adaptive Highbeam Assist**
 Function 117
 Switching on/off 118
- Additives** 333
 Engine oil 333
 Fuel 333
- Additives (engine oil)**
 see Additives
- Additives (fuel)**
 see Fuel
- ADS PLUS damping system**
 see AIR BODY CONTROL
- After-sales service center**
 see ASSYST PLUS
- Air bag**
 Reduced protection 43
- AIR BODY CONTROL** 196
 Setting 197
 Suspension 196
- Air conditioning menu**
 Calling up 128
- Air distribution**
 Setting 127
 Setting (MBUX multimedia system) 129
- Air freshener system**
 see Perfume atomizer
- Air inlet**
 see Air-water duct
- Air pressure**
 see Tire pressure
- Air suspension**
 see AIR BODY CONTROL
- Air vents** 132
 Adjusting (front) 132
 Adjusting (rear) 132
- Air vents**
 see Air vents
- Air-conditioning system**
 see Climate control
- Air-recirculation mode** 130
- Air-water duct** 269
 Keeping free 269
- Airbag** 41
 Activation 36
 Front airbag (driver, front passenger) 41
 Installation locations 41
 Knee airbag 41
 Overview 41
 PASSENGER AIR BAG indicator lamp 46
 Protection 42
 Side airbag 41
 Window curtain airbag 41
- Airflow**
 Setting 127
- Alarm**
 see Panic alarm
- Alarm system**
 see ATA (anti-theft alarm system)

- All-wheel drive**
see 4MATIC
- Ambient lighting**
Setting (multimedia system) 119
- Android Auto**
see Smartphone integration
- Animals**
Pets in the vehicle 63
- Anti-lock braking system**
see ABS (Anti-lock Braking System)
- Anti-skid chains**
see Snow chains
- Anti-theft protection**
Immobilizer 83
- Anticipatory occupant protection**
see PRE-SAFE® (anticipatory occupant protection)
see PRE-SAFE® PLUS (anticipatory occupant protection plus)
- Apple CarPlay®**
see Smartphone integration
- Assistance systems**
see Driving safety system
- ASSYST PLUS** 263
Battery disconnection periods 264
Displaying the service due date 263
Function/notes 263
Regular maintenance work 263
Special service requirements 263
- ATA (anti-theft alarm system)** 83
Activating/deactivating the interior motion sensor 85
Arming/disarming the tow-away alarm 85
Deactivating the alarm 84
Function 83
Function of the interior motion sensor .. 85
The tow-away alarm function 84
- ATTENTION ASSIST** 167, 169
Function 167
Setting 169
System limitations 167
- Attention assistant**
see ATTENTION ASSIST
- Authorized Mercedes-Benz Center**
see Qualified specialist workshop
- Authorized workshop**
see Qualified specialist workshop
- Automatic distance control**
see Active Distance Assist DISTRONIC
- Automatic driving lights** 115
- Automatic engine start (ECO start/stop function)** 141
- Automatic engine stop (ECO start/stop function)** 141
- Automatic front passenger front airbag shutoff** 44, 46
Function of the automatic front passenger front airbag shutoff 44
PASSENGER AIR BAG indicator lamp 46
- Automatic front passenger front airbag shutoff**
see Automatic front passenger front airbag shutoff
- Automatic mirror folding function**
Activating/deactivating 125
- Automatic seat adjustment**
Setting 92

Automatic transmission

DIRECT SELECT lever	147
Drive program display	146
Drive programs	145
DYNAMIC SELECT switch	145
Engaging drive position	149
Engaging neutral	148
Engaging park position	148
Engaging reverse gear	148
Kickdown	150
Manual gearshifting	149
Steering wheel paddle shifters	149
Transmission position display	147
Transmission positions	147

Automatic transmission (problem)

see Transmission (problem)

B

Bag hook	106
BAS (Brake Assist System)	163
Battery	
SmartKey	66
Battery	
see Battery (vehicle)	

Battery (vehicle)	288
Charging	287
Charging (Remote Online)	136
Notes	283
Notes (starting assistance and charging)	285
Replacing	288
Starting assistance	287

Belt

see Seat belt

Blind Spot Assist	191
Activating/deactivating	194
Function	191
System limitations	191

Blower

see Climate control

Brake Assist System

see BAS (Brake Assist System)

Brake fluid

Notes	334
-------------	-----

Brake force distribution

EBD (electronic brake force distribution)	165
---	-----

Brakes

ABS (Anti-lock Braking System)	163
Active Brake Assist	182
BAS (Brake Assist System)	163
Driving tips	138
EBD (electronic brake force distribution)	165
HOLD function	166
Limited braking effect (salt-treated roads)	138
New/replaced brakepads/brake discs	136
Notes on breaking-in a new vehicle	136

Braking assistance

see BAS (Brake Assist System)

Breakdown

Changing a wheel	320
Overview of the help functions	16
Roadside Assistance	22
Tow-starting	292
Towing away	289
Transporting the vehicle	291































Breakdown



































see Flat tire

- Buttons**
Steering wheel 217
- C**
- Calls**
Mercedes me 245
- Camera**
see 360° Camera
see Rear view camera
- Car key**
see SmartKey
- Car wash**
see Care
- Car wash (care)** 269
- Car-to-X-Communication**
Displaying hazard warnings 239
- Care** 274
Air-water duct 269
Automatic car wash 269
Carpet 274
Decorative foil 272
Display 274
Exterior lighting 272
Headliner 274
Matte finish 271
Paintwork 271
Plastic trim 274
Power washer 270
Real wood/trim elements 274
Rear view camera 272
Seat belt 274
Seat cover 274
Sensors 272
Steering wheel 274
Surround view camera 272
Tailpipes 272
Washing by hand 271
Wheels/rims 272
Windows 272
Wiper blades 272
- Cargo tie-down rings** 105
- Carpet (Care)** 274
- Change of address** 22
- Change of ownership** 22
- Changing a wheel**
Preparation 320
Raising the vehicle 321
- Changing a wheel**
see Emergency spare wheel
- Changing gears** 149
Manually 149
- Changing hub caps** 320
- Charging**
Battery (vehicle) 287
USB port 110
- Chassis level (AIR BODY CONTROL)**
Setting 197
- Child safety lock**
Rear doors 61
Rear side windows 63
- Child seat**
Attaching (notes) 54
Basic instructions 50
Front-passenger seat (notes) 60
LATCH-type (ISOFIX) (installing) 55
Notes on risks and dangers 51
Securing on the front passenger seat 60
Securing on the rear seat 58
Top Tether 57

- Children**
Avoiding dangers in the vehicle 51
Basic instructions 50
Special seat belt retractor 54
- Chock** 319
Storage location 319
- Chock**
see Chock
- Cleaning**
see Care
- Climate control** 127
Activating/deactivating 128
Activating/deactivating the A/C
function (control panel) 128
Activating/deactivating the A/C
function (MBUX multimedia system) 128
Activating/deactivating the synchro-
nization function (control panel) 129
Activating/deactivating the synchro-
nization function (MBUX multimedia
system) 129
Air-recirculation mode 130
Automatic control 128
Calling up the air conditioning menu ... 128
Climate style function 129
Control panel for 3-zone automatic
climate control 127
Control panel for dual-zone auto-
matic climate control 127
Defrosting the windshield 127
Filling capacity for PAG oil 337
Front air vents 132
Inserting/removing the flacon (fra-
grance system) 130
Ionization 130
Note 127
Rear air vents 132
Refrigerant 336
Refrigerant filling capacity 337
Removing condensation from the
windows 129
Residual heat 130
Setting (MBUX multimedia system) 128
Setting the air distribution 127
Setting the airflow 127
Setting the climate style 129
Setting the fragrance system 130
Setting the vehicle interior tempera-
ture 127
Switching the rear window heater
on/off 127
Ventilating the vehicle (convenience
opening) 78
Windshield heater 131
- Climate style**
Function 129
Setting 129
- Cockpit** 6
Overview 6
- Coffee cup symbol**
see ATTENTION ASSIST
- Collision detection (parked vehicle)** 160
- Combination switch** 115
- Computer**
see On-board computer
- Connecting the parcel net** 107
- Consumption indicator**
Calling up 147
- Convenience closing feature** 79
- Convenience opening** 78

- Coolant (engine)**
 Capacity 335
 Check level 268
 Notes 335
- Cooling**
 see Climate control
- Copyrights**
 License 34
 Trademarks 34
- Cornering light** 117
- Cross Traffic Alert** 213
- Crosswind Assist**
 Function/notes 165
- Cruise control** 169
 Activating 170
 Buttons 170
 Calling up a speed 170
 Deactivating 170
 Function 169
 Requirements: 170
 Selecting 170
 Setting a speed 170
 Storing a speed 170
 System limitations 169
- Customer Assistance Center (CAC)** 28
- Customer Relations Department** 28
- D**
- Dashboard**
 see Cockpit
- Data acquisition**
 Vehicle 29
- Data protection rights**
 Data storage 32
- Data storage**
 Data protection rights 32
 Electronic control units 29
 Online services 32
 Vehicle 29
- Daytime running lamp mode**
 see Daytime running lights
- Daytime running lights** 118
 Switching on/off 118
- Deactivating the alarm (ATA)** 84
- Dealership**
 see Qualified specialist workshop
- Declaration of conformity**
 Wireless vehicle components 25
- Decorative foil (cleaning instructions)** .. 272
- Definitions (tires and loading)** 313
- Destination entry** 236
 Entering a POI or address 236
- Detecting inattentiveness**
 see ATTENTION ASSIST
- Diagnostics connection** 25
- Digital Operator's Manual** 18
- Dinghy towing**
 see Tow-bar system
- DIRECT SELECT lever** 147
 Engaging drive position 149
 Engaging neutral 148
 Engaging park position 148
 Engaging park position automatically .. 148
 Engaging reverse gear 148
 Function 147
- Display (care)** 274
- Display (MBUX multimedia system)**
 Home screen 223

- Display (multimedia system)** 224
 Operating 224
- Display (on-board computer)**
 Displays on the multifunction display ... 219
- Display message** 340
 Calling up (on-board computer) 340
 Notes 340
- Display messages**
-  --- mph 363
 -  --- mph 363
 -  12 V Battery See Operator's Manual 377
 -  48 V Battery See Operator's Manual 378
 -  Active Headlamps Inoperative ... 347
 -  ATTENTION ASSIST Inoperative 362
 -  ATTENTION ASSIST: Take a Break! 363
 -  Automatic Headlamp Mode Inoperative 347
 -  BRAKE Check Brake Fluid Level 361
 -  Check Brake Pads See Operator's Manual 362
 -  Check Coolant Level See Operator's Manual 352
 -  Check Engine Oil Level (Add 1 quart) 385
 -  Check Left Low Beam (example) 346
 -  Check Tires 381
 -  Check Washer Fluid 351
 -  Coolant Too Hot Stop Vehicle Turn Engine Off 352
 -  Currently Unavailable Camera View Restricted 369
 -  Currently Unavailable Radar Sensors Dirty 368
 -  Currently Unavailable See Operator's Manual 372
 -  Currently Unavailable See Operator's Manual 373
 -  Don't Forget Your Key 345
 -  Drive More Slowly 371
 -  Engine Oil Level Cannot Be Measured 386
 -  Engine Oil Level Low Stop Vehicle Turn Engine Off 385
 -  Engine Oil Pressure Stop Switch Off Engine 386
 -  Engine Oil Reduce Oil Level 385
 -  Front Left Malfunction Service Required (example) 341
 -  Fuel Level Low 353
 -  Gas Cap Loose 353
 -  Inoperative See Operator's Manual 373
 -  Inoperative See Operator's Manual 374

-  **EBD Inoperative See Operator's Manual** 375
-  **Inoperative** 376
-  **Intell. Light System Inoperative** 348
-  **Key Not Detected (red display message)** 345
-  **Key Not Detected (white display message)** 345
-  **Left Side Curtain Airbag Malfunction Service Required (example)** ... 341
-  **Lowering** 371
-  **Malfunction Drive at Max. 50 mph** 370
-  **Malfunction See Operator's Manual** 346
-  **Obtain a New Key** 344
-  **Off** 364
-  **Off** 362
-  **Parking Brake See Operator's Manual** 357
-  **Please Correct Tire Pressure** 381
-  **Please Release Parking Brake** 360
-  **Please Wait Charging 48 V Battery...** 379
-  **Rear Left Backrest Not Latched (example)** 351
-  **Replace Key Battery** 344
-  **See Operator's Manual** 377
-  **SRS Malfunction Service Required** 341
-  **Steering Malfunction Increased Physical Effort See Operator's Manual** 349
-  **Steering Malfunction Stop Immediately See Operator's Manual** ... 349
-  **Stop Vehicle Leave Engine Running** 378
-  **Stop Vehicle See Operator's Manual** 378
-  **Stop Vehicle Vehicle Too Low** 370
-  **Suspended** 364
-  **Switch Off Lights** 347
-  **Switch On Headlamps** 347
-  **Turn On the Ignition to Release the Parking Brake** 361
-  **Vehicle Ready to Drive Switch the Ignition Off Before Exiting** 349
-  **Vehicle Rising Please Wait** 371
-  **Vehicle Rising** 371
-  **Warning Tire Malfunction** 382
-  **Wheel Sensor(s) Missing** 380
- Active Blind Spot Assist Currently Unavailable See Operator's Manual** 367
- Active Blind Spot Assist Inoperative** 367
- Active Brake Assist Functions Currently Limited See Operator's Manual** 375

Active Brake Assist Functions Limited See Operator's Manual	376	Active Stop & Go Assist Currently Unavailable See Operator's Manual	366	Check Tire Pressure Then Restart Run Flat Indicator	384
Active Distance Assist Currently Unavailable See Operator's Manual	364	Active Stop & Go Assist Inoperative See Operator's Manual	366	Cruise Control Inoperative	363
Active Distance Assist Inoperative	364	Adaptive Highbeam Assist Currently Unavailable See Operator's Manual	348	Cruise Control Off	363
Active Distance Assist Now Available	364	Adaptive Highbeam Assist Inoperative	348	Decrease Speed	383
Active Lane Keeping Assist Currently Unavailable See Operator's Manual	368	Apply Brake to Shift from 'P'	354	Driver's Door Open & Transmission Not in P Risk of Vehicle Rolling Away ..	355
Active Lane Keeping Assist Inoperative	368	Apply Brake to Shift to 'R'	354	Engine Can Now Be Started	379
Active Parking Assist and PARKTRONIC Inoperative See Operator's Manual	372	Apply Brake to Shift to D or R	354	Front Passenger Airbag Disabled See Operator's Manual	342
Active Steering Assist Currently Unavailable See Operator's Manual	365	Auxiliary Battery Malfunction	356	Front Passenger Airbag Enabled See Operator's Manual	342
Active Steering Assist Inoperative	365	Beginning Emergency Stop	365	Hazard Warning Flashers Malfunctioning	348
Active Steering Asst. Currently Unavailable Due to Multiple Emergency Stops	365	Blind Spot Assist Currently Unavailable See Operator's Manual	367	Mercedes me connect Services Limited See Operator's Manual	376
		Blind Spot Assist Inoperative	367	N Permanently Active Risk of Rolling Away	355
		Cannot Start Engine See Operator's Manual	379	Only Shift to 'P' when Vehicle is Stationary	354
		Check Tire Pressure Soon	383		

- Place the Key in the Marked Space
See Operator's Manual 346
- PRE-SAFE Impulse Side Inoperative
See Operator's Manual 344
- PRE-SAFE Inoperative See Operator's Manual 343
- Reversing Not Possible Service Required 355
- Run Flat Indicator Inoperative 384
- Service Required Do Not Shift Gears
Visit Dealer 355
- Stop Vehicle Leave Engine Running
Wait Transmission Cooling 356
- Tire Press. Monitor Currently Unavailable 380
- Tire Press. Monitor Inoperative 380
- Tire Pressure Monitor Inoperative No Wheel Sensors 380
- Tires Overheated 382
- To Deselect P or N, Depress Brake and Start Engine 354
- To switch engine off, press and hold Start/Stop button for at least 3 seconds or press 3 times. 352
- Traffic Sign Assist Currently Unavailable See Operator's Manual 366
- Traffic Sign Assist Inoperative 366
- Transmission Malfunction Stop 355
- Display on the windshield**
see Head-up Display
- Distance control**
see Active Distance Assist DISTRONIC
- DISTRONIC**
see Active Distance Assist DISTRONIC
- Door**
Child safety lock (rear doors) 61
Locking (emergency key) 70
Opening (from inside) 68
Power closing function 70
Unlocking (emergency key) 70
Unlocking (from inside) 68
- Door control panel** 14
- DOT, Tire Identification Number (TIN)** ... 309
- Drawbar**
see Tow-bar system
- Drinking and driving** 138
- Drive Away Assist** 213
- Drive Away Assist**
see Protection against collision
- Drive position**
Inserting 149
- Drive program display** 146
- Drive programs**
see DYNAMIC SELECT
- Driver's seat**
see Seat
- Driving safety system** 161
ABS (Anti-lock Braking System) 163
Active Brake Assist 182
BAS (Brake Assist System) 163
Cameras 161
EBD (electronic brake force distribution) 165

- ESP® Crosswind Assist 165
- Overview 162
- Radar and ultrasonic sensors 161
- Responsibility 161
- STEER CONTROL 165
- Driving system**
- DYNAMIC BODY CONTROL 196
- Driving system**
- see 360° Camera
- see Active Blind Spot Assist
- see Active Distance Assist DISTRONIC
- see Active Emergency Stop Assist
- see Active Lane Change Assist
- see Active Lane Keeping Assist
- see Active Parking Assist
- see Active Speed Limit Assist
- see Active Steering Assist
- see AIR BODY CONTROL
- see ATTENTION ASSIST
- see Blind Spot Assist
- see Cruise control
- see Driving safety system
- see HOLD function
- see Parking Assist PARKTRONIC
- see Rear view camera
- see Traffic Sign Assist
- Driving tips** 137
- Drinking and driving 138
- General driving tips 138
- Notes on breaking-in a new vehicle 136
- Optimized acceleration 137
- Drowsiness detection**
- see ATTENTION ASSIST
- DYNAMIC BODY CONTROL**
- Suspension 196
- Dynamic handling control system**
- see ESP® (Electronic Stability Program)
- DYNAMIC SELECT** 145
- Configuring drive program I 146
- Displaying engine data 146
- Displaying vehicle data 146
- Drive program display 146
- Drive programs 145
- Function 145
- Operating (DYNAMIC SELECT switch) 146
- Selecting the drive program 146

E

- E10** 332
- Easy entry feature**
- Function/notes 98
- Setting 99
- Easy exit feature**
- Function/notes 98
- Setting 99
- EBD (electronic brake force distribution)**
- Function/notes 165
- ECO Assist**
- Displaying 145
- Function/notes 143
- ECO display**
- Function 142
- ECO start/stop function** 141
- Automatic engine start 141
- Automatic engine stop 141
- Method of operation 141
- Switching off/on 142
- Electric parking brake** 158
- Applying automatically 158

- Applying or releasing manually 159
- Emergency braking 159
- Releasing automatically 159
- Electronic Stability Program**
see ESP® (Electronic Stability Program)
- Emergency**
First-aid kit (soft sided) 277
- Overview of the help functions 16
- Reflective safety vest 276
- Removing the warning triangle 276
- Setting up the warning triangle 277
- Emergency braking** 159
- Emergency braking**
see BAS (Brake Assist System)
- Emergency engine start** 292
- Emergency key**
Locking a door 70
- Unlocking a door 70
- Emergency operation mode**
Starting the vehicle 135
- Emergency release**
Trunk lid (from inside) 76
- Emergency spare wheel** 325
- Notes 325
- Emergency Tensioning Devices**
Activation 36
- Engine**
ECO start/stop function 141
- Engine number 329
- Starting (emergency operation mode) 135
- Starting (Remote Online) 136
- Starting (start/stop button) 134
- Starting assistance 287
- Switching off (start/stop button) 154
- Engine data**
Displaying 146
- Engine number** 329
- Engine oil** 267
- Additives 333
- Capacity 334
- Checking the oil level using the on-board computer 266
- MB-Freigabe or MB-Approval 334
- Quality 334
- Topping up 267
- EQ boost**
Operating safety 23
- ESC (Electronic Stability Control)**
see ESP® (Electronic Stability Program)
- ESP®**
Crosswind Assist 165
- ESP® (Electronic Stability Program)** 163
- Activating/deactivating 165
- Function/notes 163
- Exterior lighting**
see Lights
- Exterior lighting (care)** 272
- Exterior mirrors** 123, 124
- Anti-glare mode (automatic) 124
- Automatic mirror folding function 125
- Folding in/out 123
- Operating the memory function 100
- Parking position 124
- Setting 123

F

- Fatigue detection**
see ATTENTION ASSIST

First-aid kit (soft sided)	277
Flacon	
Inserting/removing	130
Flat tire	277
Changing a wheel	320
MOExtended tires	278
Notes	277
TIREFIT kit	279
Flat towing	
see Tow-bar system	
Floor mats	112
Foil covering	
Radar and ultrasonic sensors	161
Fragrance	
see Perfume atomizer	
Free software	34
Frequencies	
Two-way radio	328
Front airbag (driver, front passenger)	41
Front passenger seat	
see Seat	

Fuel	333
Additives	333
E10	332
Fuel reserve	333
Gasoline	332
Quality (gasoline)	332
Refueling	152
Sulfur content	332
Tank content	333

Function seat

 see Door control panel

Fuses	293
Before replacing a fuse	293
Dashboard fuse box	295
Fuse assignment diagram	293
Fuse box in the engine compartment ..	294
Fuse box in the front-passenger foot- well	295
Fuse box in the trunk	295
Notes	293

Fuses

 see Fuses

G**Garage door opener**

Clearing the memory	158
Opening or closing the door	157
Programming buttons	155
Resolving problems	157
Synchronizing the rolling code	157

Gasoline	332
-----------------------	-----

Gearshift recommendation	150
---------------------------------------	-----

Genuine parts	20
----------------------------	----

Genuine wood (Care)	274
----------------------------------	-----

Glide mode	151
-------------------------	-----

H**Handbrake**

 see Electric parking brake

Handling characteristics (unusual)	296
---	-----

HANDS-FREE ACCESS	74
--------------------------------	----

Hazard warning lights	116
------------------------------------	-----

Hazardous substances

Information	23
-------------------	----

- Head restraint**
 Front (adjusting mechanically) 90
 Front (luxury head restraint) 91
 Rear passenger compartment
 (adjusting) 92
- Head-up Display** 220
 Adjusting display elements (on-board
 computer) 220
 Adjusting the brightness (on-board
 computer) 220
 Function 219
 Menu (on-board computer) 220
 Operating the memory function 100
 Setting the position (on-board com-
 puter) 220
 Switching on/off 221
- Headlamps**
 see Automatic driving lights
- Headliner (care)** 274
- Heating**
 see Climate control
- Help call**
 see Mercedes-Benz emergency call system
- High beam**
 Activating/deactivating 115
- High-beam flasher** 115
- High-beam headlamps**
 Adaptive Highbeam Assist 117
- Hill start assist** 167
- HOLD function** 166
 Function/notes 166
 Switching on/off 166
- Home screen (media display)**
 Overview 223
- Hood**
 Opening/closing 264
- I**
- Identification plate**
 Engine 329
 Refrigerant 336
 Vehicle 329
- Ignition**
 Switching on (Start/Stop button) 133
- Ignition key**
 see SmartKey
- Immobilizer** 83
- Indicator lamps**
 see Warning/indicator lamps
- Individual drive program**
 Configuring 146
 Selecting 146
- Inside rearview mirror**
 see Exterior mirrors
- Inspection**
 see ASSYST PLUS
- Instrument cluster**
 Function/notes 215, 216
- Instrument Display**
 Function/notes 216
 Instrument cluster 10
 Warning/indicator lamps 387
- Instrument Display and on-board
 computer**
 Function/notes 215
- Intelligent Light System**
 Adaptive Highbeam Assist 117
 Cornering light 117

Interior lighting	119
Adjusting	119
Ambient lighting	119
Reading lamp	119
Switch-off delay time	120

Interior motion sensor	
Activating/deactivating	85
Function	85

Internet radio

see TuneIn

Ionization

Activating/deactivating (MBUX multimedia system)	130
--	-----

iPhone®

see Smartphone integration

J**Jack**

Storage location	319
------------------------	-----

Jump-start connection	287
------------------------------------	-----

General notes	285
---------------------	-----

K**KEYLESS-GO**

Locking the vehicle	68
Problem	69
Unlocking setting	65
Unlocking the vehicle	68

Kickdown	150
-----------------------	-----

Using	150
-------------	-----

Knee airbag	41
--------------------------	----

L**Labeling (tires)**

see Tire labeling

Lamp

see Interior lighting

Lamps (Instrument Display)

see Warning/indicator lamps

Lane detection (automatic)

see Active Lane Keeping Assist

Lane Keeping Assist

see Active Lane Keeping Assist

LATCH-type (ISOFIX) child seat securing system

Installing	55
------------------	----

Level control system

see AIR BODY CONTROL

Light switch

Overview	114
----------------	-----

Lighting

see Interior lighting

see Lights

Lights	114
---------------------	-----

Adaptive Highbeam Assist	117
--------------------------------	-----

Automatic driving lights	115
--------------------------------	-----

Combination switch	115
--------------------------	-----

Cornering light	117
-----------------------	-----

Hazard warning lights	116
-----------------------------	-----

High beam	115
-----------------	-----

High-beam flasher	115
-------------------------	-----

Light switch	114
--------------------	-----

Low-beam headlamps	114
--------------------------	-----

Parking lights	114
----------------------	-----

Rear fog lamp	114
---------------------	-----

Responsibility for lighting systems	114
---	-----

- Setting the exterior lighting switch-off delay time 118
 - Standing lights 114
 - Switching the surround lighting on/off 119
 - Turn signal light 115
 - Limited Warranty**
 - Vehicle 29
 - Live Traffic Information**
 - Switching the traffic information display on 239
 - Load index (tires)** 311
 - Load-bearing capacity (tires)** 311
 - Loading** 105
 - Bag hook 106
 - Cargo tie-down rings 105
 - Definitions 313
 - Notes 100
 - Roof luggage rack 107
 - Loading guidelines** 100
 - Loading information table** 304
 - Loads**
 - Securing 100
 - Locking/unlocking**
 - Activating/deactivating the automatic locking feature 69
 - Emergency key 70
 - KEYLESS-GO 68
 - Unlocking/opening the doors from the inside 68
 - Low-beam headlamps**
 - Switching on/off 114
 - Lubricant additives**
 - see Additives
 - Luggage**
 - Parcel net 107
 - Securing 100
 - Lumbar support**
 - see Lumbar support (4-way)
 - Lumbar support (4-way)** 88
- M**
- Maintenance**
 - Vehicle 22
 - Maintenance**
 - see ASSYST PLUS
 - Malfunction**
 - Restraint system 36
 - Malfunction message**
 - see Display message
 - Maneuvering assistance**
 - Activating/deactivating 214
 - Cross Traffic Alert 213
 - Drive Away Assist 213
 - Map** 238
 - Displaying online map contents 239
 - Displaying weather information 239
 - Moving 238
 - Selecting the map orientation 238
 - Setting the map scale 238
 - Switching freeway information on/off 238
 - Massage program**
 - Overview 93
 - Resetting the settings 94
 - Massage programs**
 - Selecting the front seats 94
 - Massage settings**
 - Resetting 94

- Matte finish (cleaning instructions)** 271
- Maximum load rating** 310
- Maximum permissible load**
- Calculation example 306
 - Determining 305
- Maximum tire pressure** 310
- MBUX Interior Assistant**
- Switching the reading light for the driver and front passenger on/off contact-free 228
 - Switching the search light for the driver on/off 228
- MBUX Interior Assistant (multimedia system)** 226
- Overview 226
- MBUX multimedia system** 222
- Activating/deactivating standby mode 161
 - Configuring drive program I 146
 - Notes 222
 - Overview 222
 - Setting route-based speed adaptation 177
 - Standby mode function 160
- Mechanical key**
- Inserting/removing 66
- Media**
- Overview of the functions and symbols 255
- Media mode**
- Connecting Bluetooth® audio equipment 256
- Medical aids** 27
- Memory function**
- Function 99
 - Head-up Display – Calling up stored settings 100
 - Head-up Display – Storing settings 100
 - Operating 100
 - Outside mirrors – Calling up stored settings 100
 - Outside mirrors – Storing settings 100
 - Seat – Calling up stored settings 100
 - Seat – Storing settings 100
 - Steering wheel – Calling up saved settings 100
 - Steering wheel – Saving settings 100
- Menu (on-board computer)**
- Head-up Display 220
 - Overview 217
- Mercedes me app**
- Information 249
- Mercedes me calls**
- Arranging a service appointment 247
 - Calling the Mercedes-Benz Customer Center 246
 - Calling the Mercedes-Benz Customer Center after automatic accident or breakdown detection 246
 - Information 246
 - Making a call via the overhead control panel 245
 - Transferred data 247
- Mercedes me connect**
- Accident and Breakdown Management 244
 - Information 243
 - Transferred data 245
- Mercedes-AMG vehicles**
- Notes 133

Mercedes-Benz emergency call system 251
 Automatic emergency call 252
 Information 251
 Information on data transfer 253
 Manual emergency call 253
 Overview 252

Mercedes-Benz Link
 see Smartphone integration

Message (multifunction display)
 see Display message

Message memory 340

Mirrors
 see Exterior mirrors

Mobile phone
 Wireless charging 111

Mobile phone
 see Smartphone integration
 see Telephone

Model series
 see Vehicle identification plate

MOExtended tires 278

Multifunction display
 Overview of the displays 219

Multifunction steering wheel
 Overview of buttons 217

Multifunction steering wheel
 see Steering wheel

Multimedia system
 Collision detection (parked vehicle) 160

Multimedia system
 see Display (multimedia system)
 see MBUX Interior Assistant (multimedia system)
 see MBUX multimedia system
 see Touchpad

N

Navigation
 Notes 234
 Overview 235
 Showing/hiding the menu 234
 Switching on 234

Navigation
 see Destination entry
 see Map

see Route

Neutral

Inserting 148

Notes on breaking-in a new vehicle 136

O

Occupant safety

see Airbag
 see Automatic front passenger front airbag shutoff
 see Pets in the vehicle
 see PRE-SAFE® (anticipatory occupant protection)
 see PRE-SAFE® Impulse Side
 see PRE-SAFE® PLUS (anticipatory occupant protection plus)
 see Restraint system
 see Seat belt

Oil

see Engine oil

On-board computer 217
 Displaying the service due date 263
 Head-up Display menu 220
 Multifunction display 219

- Operating 217
 - Overview of menus 217
 - On-board diagnostics interface**
see Diagnostics connection
 - Online services**
Data storage 32
 - Open-source software** 34
 - Opening the trunk lid using your foot**
HANDS-FREE ACCESS 74
 - Operating fluids**
Additives (fuel) 333
 - Brake fluid 334
 - Coolant (engine) 335
 - Engine oil 333
 - Fuel (gasoline) 332
 - Notes 331
 - Refrigerant (air conditioning system) ... 336
 - Windshield washer fluid 335
 - Operating safety**
48 V on-board electrical system 23
 - Declaration of conformity (wireless
vehicle components) 25
 - EQ boost 23
 - Information 23
 - Operating system**
see On-board computer
 - Operator's Manual**
Vehicle equipment 21
 - Operator's Manual (digital)** 18
 - Optimized acceleration** 137
Activating 137
 - Overhead control panel**
Overview 12
- P**
- Paint code** 329
 - Paintwork (cleaning instructions)** 271
 - Panel heating**
Setting 95
 - Panic alarm** 65
Activating/deactivating 65
 - Park position**
Inserting 148
 - Selecting automatically 148
 - Parking**
see Electric parking brake
 - Parking aid**
see Parking Assist PARKTRONIC
 - Parking Assist PARKTRONIC** 203
Activating 207
 - Adjusting warning tones 208
 - Function 203
 - Side impact protection 206
 - Switching off 207
 - System limitations 203
 - Parking assistance systems**
see Active Parking Assist
 - Parking brake**
see Electric parking brake
 - Parking for an extended period** 160
 - Parking lights** 114
 - Parking position**
Exterior mirrors 124
 - Storing the position of the front-
passenger outside mirror using
reverse gear 125
 - PASSENGER AIR BAG status display**
see Automatic front passenger front
airbag shutoff

- Payload**
 Calculation example 306
 Determining the maximum 305
- Perfume**
 see Perfume atomizer
- Perfume atomizer** 130
 Inserting/removing the flacon 130
 Setting 130
- Perfume vial**
 see Perfume atomizer
- Period out of use**
 Activating/deactivating standby
 mode 161
 Standby mode function 160
- Permitted towing methods** 288
- Pets in the vehicle** 63
- Plastic trim (Care)** 274
- Power closing function**
 Door 70
- Power supply**
 Switching on (Start/Stop button) 133
- Power washer (care)** 270
- Power windows**
 see Side windows
- PRE-SAFE® (anticipatory occupant protection)** 49
 Function 49
 PRE-SAFE® Sound 49
 Reversing measures 49
- PRE-SAFE® Impulse Side** 50
 Activation 36
 Function 50
- PRE-SAFE® PLUS (anticipatory occupant protection plus)** 49
 Function 49
 Reversing measures 49
- Preventative occupant protection system**
 see PRE-SAFE® (anticipatory occupant protection)
- Profile** 228
 Creating a new profile 230
 Notes 228
 Selecting profile options 230
- Programs**
 see DYNAMIC SELECT
- Protecting the environment**
 Notes 20
- Protection against collision** 213
- Pulling away**
 see Driving tips
- Q**
- QR code**
 Rescue card 29
- Qualified specialist workshop** 27
- R**
- Radar and ultrasonic sensors**
 Damage 161
- Radio**
 Overview of the functions and symbols 257
- Radio operating permits** 329
- Reading lamp**
 see Interior lighting

- Reading light**
Switching on/off with hand movements 228
- Rear doors (child safety lock)** 61
- Rear fog lamp**
Switching on/off 115
- Rear seat**
see Seat
- Rear view camera** 198
Care 272
Function 198
Opening the camera cover (360° Camera) 203
- Rear window**
Roller sunblind 82
- Rear window heater** 127
- Reflective safety vest** 276
- Refrigerant (air conditioning system)**
Notes 336
- Refueling**
Refueling the vehicle 152
- Remote Online**
Charging the starter battery 136
Cooling or heating the vehicle interior 135
Starting the vehicle 136
- Reporting safety defects** 28
- Rescue card** 29
- Reserve**
Fuel 333
- Residual heat** 130
- Restraint system** 35
Basic instructions for children 50
Function in an accident 36
Functionality 35
Malfunction 36
Protection 35
Reduced protection 35
Self-test 35
Warning lamp 35
- Reverse gear**
Inserting 148
- Rims (care)** 272
- Roadside Assistance (breakdown)** 22
- Roll away protection**
see HOLD function
- Roller sunblind**
Rear window 82
- Roof load** 338
- Roof luggage rack**
Loading 107
Securing 107
- Route** 237
Calculating 237
Selecting options 237
- Route guidance with augmented reality**
Activating 237
Displaying street names and house numbers 237
- Route-based speed adaptation**
Function 176
Setting 177
- Run-flat characteristics**
MOExtended tires 278

S

- Safety systems**
 - see Driving safety system
- Satellite radio**
 - Logging in 261
 - Setting music and sport alerts 261
- Search light**
 - Switching on/off with hand movements 228
- Seat** 87, 103
 - 4-way lumbar support 88
 - Adjusting (electrically) 90
 - Adjusting (Seat Comfort) 88
 - Automatic seat adjustment 92
 - Backrest (rear) locking 105
 - Configuring the settings 92
 - Correct driver's seat position 87
 - Folding the backrest (rear passenger compartment) back 104
 - Folding the backrest (rear) forwards 103
 - Massage program overview 93
 - Operating the memory function 100
 - Panel heating 95
 - Resetting the settings 94
 - Setting options 14
 - Workout program overview 93
- Seat belt** 37
 - Care 274
 - Protection 37
- Seat belt adjustment**
 - Activating/deactivating 41
 - Function 40
- Seat belt warning**
 - see Seat belts
- Seat belts** 41
 - Activating/deactivating seat belt adjustment 41
 - Adjusting the height 40
 - Fastening 40
 - Reduced protection 40
 - Releasing 41
 - Seat belt adjustment (function) 40
 - Warning lamp 41
- Seat cover (Care)** 274
- Seat heating**
 - Activating/deactivating 94
- Seat ventilation**
 - Activating/deactivating 95
- Selecting a gear**
 - see Changing gears
- Selector lever**
 - see DIRECT SELECT lever
- Self-test**
 - Automatic front passenger front air-bag shutoff 46
- Sensors (care)** 272
- Service center**
 - see Qualified specialist workshop
- Service interval display**
 - see ASSYST PLUS
- Setting a speed**
 - see Cruise control
- Setting the map scale**
 - see Map
- Shift paddles**
 - see Steering wheel paddle shifters
- Shifting gears**
 - Gearshift recommendation 150

- Side airbag** 41
- Side impact protection** 206
- Side windows** 77
 - Child safety lock in the rear passenger compartment 63
 - Closing 77
 - Closing using the SmartKey 79
 - Convenience closing feature 79
 - Convenience opening 78
 - Opening 77
 - Opening with the SmartKey 78
 - Problem 79
- Size designation (tires)** 311
- Sliding sunroof**
 - Closing 80
 - Closing using the SmartKey 79
 - Opening 80
 - Opening with the SmartKey 78
 - Problem 82
- SmartKey** 64
 - Acoustic locking verification signal 65
 - Battery 66
 - Energy consumption 65
 - Features 64
 - Key ring attachment 66
 - Mechanical key 66
 - Overview 64
 - Panic alarm 65
 - Problem 67
 - Unlocking setting 65
- SmartKey functions**
 - Deactivating 65
- Smartphone**
 - see Smartphone integration
 - see Telephone
- Smartphone integration** 250
 - Overview 250
- Snow chains** 297
- Socket (12 V)** 108
 - Front center console 108
- Socket (115 V)** 109
 - Rear passenger compartment 109
- Software update**
 - System updates 231
- Sound**
 - PRE-SAFE® Sound 49
 - Wheels and tires 296
- Sound menu**
 - Functions overview 262
- Spare wheel**
 - see Emergency spare wheel
- Special seat belt retractor** 54
- Specialist workshop** 27
- Speed index (tires)** 311
- Standby mode**
 - Activating/deactivating 161
 - Function 160
- Standing lights** 114
- Start-off assist**
 - see Optimized acceleration
- Start/Stop button**
 - Parking the vehicle 154
 - Starting the vehicle 134
 - Switching on the power supply or ignition 133
- Start/stop function**
 - see ECO start/stop function
- Starter battery**
 - Charging (Remote Online) 136

- Starting assistance**
see Jump-start connection
- Starting the engine**
see Vehicle
- Starting-off aid**
see Hill start assist
- STEER CONTROL**
Function/notes 165
- Steering wheel** 217
Adjusting (electrically) 97
Adjusting (manually) 96
Buttons 217
Care 274
Operating the memory function 100
Steering wheel heater 97
- Steering wheel heater**
Switching on/off 97
- Steering wheel paddle shifters** 149
- Storage areas**
see Storage compartment
- Storage compartment** 103
Armrest 103
Center console 103
Door 103
Glove box 103
- Storage compartments**
see Storage compartment
- Storage spaces**
USB ports 103
- Stowage areas**
see Loading
- Stowage compartments**
see Loading
- Suggestions**
Configuring 230
- Sulfur content** 332
- Surround lighting**
Switching on/off 119
- Surround View**
see 360° Camera
- Surround view camera**
Care 272
- Suspension**
Adjusting the chassis level (AIR
BODY CONTROL) 197
Damping characteristics 196
DYNAMIC BODY CONTROL 196
- Suspension**
see AIR BODY CONTROL
- Switch-off delay time**
Exterior 118
Interior 120
- Synchronization function**
Activating/deactivating (MBUX mul-
timedia system) 129
Switching on/off (control panel) 129
- System settings**
Overview of the system settings
menu 230
- T**
- Tailpipes (care)** 272
- Tank content**
Fuel 333
Reserve (fuel) 333
- Technical data**
Information 327
Radio operating permits 329

- Telephone** 240, 242
Connecting a mobile phone (Pass-key) 243
Connecting a mobile phone (Secure Simple Pairing) 243
Functions in the telephone menu 243
Notes 240
Operating modes 242
Telephone menu overview 242
Wireless charging (mobile phone) 111
- Telephony operating modes**
Bluetooth® Telephony 242
- Temperature**
Setting the vehicle interior temperature 127
- Temperature grade** 308
- Themes**
Fastening 230
- Through-loading feature**
see Seat
- TIN (Tire Identification Number)** 309
- Tire and Loading Information placard** ... 304
- Tire characteristics** 311
- Tire inflation compressor**
see TIREFIT kit
- Tire information table** 304
- Tire labeling** 308
Characteristics 311
DOT, Tire Identification Number (TIN) 309
Load index 311
Load-bearing capacity 311
Maximum tire load 310
Maximum tire pressure 310
Overview 308
Speed rating 311
Temperature grade 308
Tire Quality Grading 308
Tire size designation 311
Traction grade 308
Tread wear grade 308
- Tire load (maximum)** 310
- Tire pressure** 299, 300
Checking (manually) 300
Checking (tire pressure monitoring system) 302
Maximum 310
- Notes 297
Restarting the tire pressure loss warning system 303
Restarting the tire pressure monitoring system 302
Tire pressure loss warning system (function) 303
Tire pressure monitoring system (function) 300
Tire pressure table 299
TIREFIT kit 279
- Tire pressure loss warning system**
Function 303
Restarting 303
- Tire pressure monitor**
Function 300
Restarting 302
- Tire pressure monitoring system**
Checking the tire pressure 302
Checking the tire temperature 302
- Tire pressure table** 299
- Tire Quality Grading** 308

- Tire temperature**
 - Checking (tire pressure monitoring system) 302
 - Tire pressure monitoring system (function) 300
- Tire tread** 296
- Tire-change tool kit**
 - Overview 319
- TIREFIT kit** 279
 - Storage location 279
 - Using 279
- Tires**
 - Changing hub caps 320
 - Characteristics 311
 - Checking 296
 - Checking the tire pressure (manually) 300
 - Checking the tire pressure (tire pressure monitoring system) 302
 - Definitions 313
 - DOT, Tire Identification Number (TIN) 309
 - Flat tire 277
 - Installing 323
 - Load index 311
 - Load-bearing capacity 311
 - Maximum tire load 310
 - Maximum tire pressure 310
 - MOExtended tires 278
 - Noise 296
 - Notes on installing 316
 - Overview of tire labeling 308
 - Removing 323
 - Replacing 316, 320
 - Restarting the tire pressure loss warning system 303
 - Restarting the tire pressure monitoring system 302
 - Rotating 319
 - Selection 316
 - Snow chains 297
 - Speed rating 311
 - Storing 319
 - Temperature grade 308
 - Tire and Loading Information placard 304
 - Tire pressure (notes) 297
 - Tire pressure loss warning system (function) 303
 - Tire pressure monitoring system (function) 300
 - Tire pressure table 299
 - Tire Quality Grading 308
 - Tire size designation 311
 - TIREFIT kit 279
 - Traction grade 308
 - Tread wear grade 308
 - Unusual handling characteristics 296
- Toll system**
 - Windshield 126
- Tool**
 - see Vehicle tool kit
- Top Tether** 57
- Touch Control**
 - On-board computer 217
 - Operating 224
- Touchpad** 224
 - Operating 224
- Touchscreen (media display)**
 - Operating 224
- Tow-away alarm**
 - Activating/deactivating 85













- Function 84
- Tow-bar system** 214
- Tow-starting** 292
- Towing away** 289
- Towing eye**
 Installing 292
 Storage location 292
- Towing methods** 288
- Traction grade** 308
- Traffic information**
 Switching on the display 239
- Traffic light data service**
 Display in the Instrument Display 189
 Turning the display on/off 191
- Traffic Sign Assist** 187
 Function/notes 187
 Setting 188
 System limitations 187
- Transmission (problem)** 149
- Transmission position display** 147
- Transporting**
 Vehicle 291
- Tread wear grade** 308
- Trim element (Care)** 274
- Trunk lid**
 Closing 72
 Emergency release (from inside) 76
 HANDS-FREE ACCESS 74
 Locking separately 76
 Opening 71
 Opening dimensions 337
- TuneIn** 260
 Calling up 260
- Turn signal indicator** 115
- Turn signal light**
 Activating/deactivating 115
- Two-way radios**
 Frequencies 328
 Notes on installation 327
 Transmission output (maximum) 328
- U**
- Unlocking setting** 65
- Updates**
 Important system updates 231
- USB port**
 Rear passenger compartment 110
- V**
- Vehicle** 135
 Activating/deactivating standby
 mode 161
 Collision detection (parking) 160
 Correct use 27
 Data acquisition 29
 Data storage 29
 Diagnostics connection 25
 Equipment 21
 Limited Warranty 29
 Locking (automatically) 69
 Locking (from inside) 68
 Locking (KEYLESS-GO) 68
 Locking/unlocking (emergency key) 70
 Lowering 324
 Maintenance 22
 Medical aids 27
 Parking for an extended period 160
 Problem notification 28
 QR code rescue card 29
 Qualified specialist workshop 27











- Raising 321
 - Standby mode function 160
 - Starting (emergency operation mode) 135
 - Starting (Remote Online) 136
 - Starting (start/stop button) 134
 - Switching off (start/stop button) 154
 - Towing 214
 - Unlocking (from inside) 68
 - Unlocking (KEYLESS-GO) 68
 - Ventilating (convenience opening) 78
- Vehicle data**
- Displaying (DYNAMIC SELECT) 146
 - Roof load 338
 - Turning radius 337
 - Vehicle height 337
 - Vehicle length 337
 - Vehicle width 337
 - Wheelbase 337
- Vehicle data storage**
- Event data recorders 33
 - MBUX multimedia system/Mercedes me connect 33
- Vehicle dimensions** 337
- Vehicle electronics**
- Notes 327
 - Two-way radios 327
- Vehicle identification number**
- see VIN
- Vehicle identification plate** 329
- Paint code 329
 - VIN 329
- Vehicle interior**
- Cooling or heating (Remote Online) 135
- Vehicle key**
- see SmartKey
- Vehicle maintenance**
- see ASSYST PLUS
- Vehicle operation**
- Outside the USA or Canada 22
- Vehicle tool kit** 279
- TIREFIT kit 279
 - Towing eye 292
- Ventilating**
- Convenience opening 78
- Ventilation**
- see Climate control
- Vents**
- see Air vents
- VIN** 329
- Identification plate 329
 - Seat 329
 - Windshield 329
- Vision**
- Removing condensation from the windows 129
 - Windshield heater 131
- Voice Control System**
- Function 225
 - Starting 226



W

- Warning lamps**
- see Warning/indicator lamps
- Warning system**
- see ATA (anti-theft alarm system)
- Warning triangle**
- Removing 276
 - Setting up 277

Warning/indicator lamp

 ABS warning lamp	397
 Active Brake Assist warning lamp	396
 Brake system warning lamp (Canada only)	395
 Brake warning lamp (USA only) ..	395
 Brakes warning lamp (yellow) (Canada only)	394
 Coolant warning lamp (red)	390
 Coolant warning lamp (yellow)	391
 Electric parking brake indicator lamp (red) (Canada only)	393
 Electric parking brake indicator lamp (red) (USA only)	393
 Electrical malfunction warning lamp	392
 Engine diagnosis warning lamp ..	391
 ESP® OFF warning lamp	398
 ESP® warning lamp flashes	397

 ESP® warning lamp lights up	398
 Fuel reserve warning lamp flashes	392
 Fuel reserve warning lamp lights up	392
 Power steering warning lamp (red)	389
 Recuperative Brake System warning lamp (USA only)	394
 Restraint system warning lamp ..	388
 Seat belt warning lamp flashes ..	388
 Seat belt warning lamp lights up	389
 Suspension warning lamp (yellow)	396
 The electric parking brake (yellow) indicator lamp	393
 Tire pressure monitoring system warning lamp flashes	399

 Tire pressure monitoring system warning lamp lights up	400
 Warning lamp for distance warning function	396

Warning/indicator lamps	387
Overview	387
PASSENGER AIR BAG	46

Warranty	29
-----------------------	----

Washer fluid

see Windshield washer fluid

Washing by hand (care)	271
-------------------------------------	-----

Water tank

see Air-water duct

Weather information	239
----------------------------------	-----

Web browser

Overview (multimedia system)	249
------------------------------------	-----

Wheel change

Lowering the vehicle	324
Mounting a new wheel	323
Removing a wheel	323
Removing/installing hub caps	320

Wheel rotation	319
-----------------------------	-----

Wheels

Care	272
Changing hub caps	320
Checking	296
Checking the tire pressure (manually)	300
Checking the tire pressure (tire pressure monitoring system)	302
Definitions	313
DOT, Tire Identification Number (TIN)	309
Flat tire	277
Installing	323
Load index	311
Load-bearing capacity	311
Maximum tire load	310
Maximum tire pressure	310
MOExtended tires	278
Noise	296
Notes on installing	316
Overview of tire labeling	308
Removing	323
Replacing	316, 320
Restarting the tire pressure loss warning system	303

Restarting the tire pressure monitoring system	302
Rotating	319
Selection	316
Snow chains	297
Speed rating	311
Storing	319
Temperature grade	308
Tire and Loading Information placard	304
Tire characteristics	311
Tire pressure (notes)	297
Tire pressure loss warning system (function)	303
Tire pressure monitoring system (function)	300
Tire pressure table	299
Tire Quality Grading	308
Tire size designation	311
TIREFIT kit	279
Traction grade	308
Tread wear grade	308
Unusual handling characteristics	296
Wi-Fi	
Setting	232

Window curtain airbag	41
------------------------------------	----

Windows

see Side windows

Windows (care)	272
-----------------------------	-----

Windshield	121, 127
-------------------------	----------

Defrosting 127 |

Infrared reflective 126 |

Radio waves 126 |

Replacing the wiper blades 121 |

Windshield

see Windshield

Windshield heater	131
--------------------------------	-----

Windshield heating

see Windshield heater

Windshield washer fluid	335
--------------------------------------	-----

Notes 335 |

Windshield washer system

Topping up 269 |

Windshield wipers

Activating/deactivating 120 |

Replacing the wiper blades 121 |

Winter operation

Snow chains 297

Wiper blades

Care 272

Replacing 121

Wireless charging

Function/notes 110

Mobile phone 111

Wireless vehicle components

Declaration of conformity 25

Workout program

Overview 93

Workshop

see Qualified specialist workshop