



Digital – in the vehicle

Familiarize yourself with the contents of the Operator's Manual directly via the vehicle's multimedia system (menu item "Vehicle information"). Start with the quick guide or broaden your knowledge with practical tips.



Vehicle document wallet

Here you can find comprehensive information about operating your vehicle and about services and guarantees in printed form.



2975842502

Order no. P297 0525 13 Part no. 297 584 25 02
Edition D-2022

EQS

Mercedes-Benz



EQS

Operator's Manual

Mercedes-Benz



Front passenger airbag warning

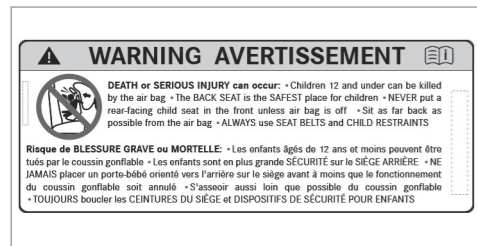
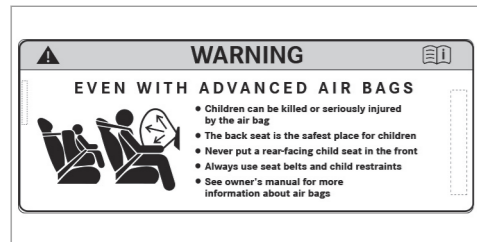

Airbag warning sticker for USA and Canada

⚠ WARNING Risk of injury or death if the co-driver airbag is enabled

If the co-driver airbag is enabled, a child on the co-driver seat may be struck by the co-driver airbag during an accident.

NEVER use a rearward-facing child restraint system on a seat with an ENABLED FRONT AIRBAG; DEATH or SERIOUS INJURY to the CHILD can occur.

Observe the chapter "Children in the vehicle".

Publication details

Internet

Further information about Mercedes-Benz vehicles and about Mercedes-Benz AG can be found on the following websites:

<https://www.mbusa.com> (USA only)

<https://www.mercedes-benz.ca> (Canada only)

Documentation team

©Mercedes-Benz AG: Not to be reprinted, translated or otherwise reproduced, in whole or in part, without written permission from Mercedes-Benz AG.

Vehicle manufacturer

Mercedes-Benz AG

Mercedesstraße 120

70372 Stuttgart

Germany

As at 16.03.21

Thank you for buying Mercedes-Benz

Before you first drive off, read this operator's manual carefully and familiarize yourself with your vehicle. For your own safety and a longer operating lifespan of the vehicle, follow the instructions and warning notices in this operator's manual. Disregarding them may lead to damage to the vehicle or injury to people.

Damage to the vehicle resulting from the disregard of the instructions is not covered by the Mercedes-Benz Limited Warranty.

The standard equipment and product description of your vehicle may vary and depends on the following factors:

- Model
- Order
- National version
- Availability

Your vehicle may therefore differ, in individual cases, from that shown in the descriptions and illustrations.

Mercedes-Benz reserves the right to introduce changes in the following areas:

- Design
- Equipment
- Technical features

The following documents are integral parts of the vehicle:

- Digital Operator's Manual
- Printed operator's manual
- Maintenance Booklet
- Equipment-dependent supplements
- Supplementary documents

Keep these documents in the vehicle at all times. Ensure that all documents are in the vehicle or passed on in the event of sale or rental.

Mercedes-Benz USA, LLC

Mercedes-Benz Canada, Inc.

A Daimler Company

2975842502



Symbols	5	Service and vehicle operation	30	Opening and closing	73
At a glance	6	Operating safety	31	SmartKey	73
Cockpit (central display)	6	Declaration of conformity for vehicle installed radio components	33	Doors	77
Cockpit (MBUX Hyperscreen)	8	Diagnostics connection	33	Cargo compartment	87
Indicator and warning lamps (standard)	10	Qualified specialist workshop	35	Side windows	92
Indicator and warning lamps (with driver camera)	14	Correct use of the vehicle	35	Sliding sunroof	95
Overhead control panel	18	Notes for persons with electronic medical aids	35	Anti-theft protection	99
Door operating unit and seat adjustment	20	Problems with your vehicle	36	Seats and stowing	102
Control settings in the rear passenger compartment	22	Reporting safety defects	36	Notes on the correct driver's seat position ..	102
Emergencies and breakdowns	24	Limited Warranty	37	Seats	102
Digital Operator's Manual	26	QR code for rescue card	37	Steering wheel	115
Calling up the Digital Operator's Manual	26	Data storage	37	Easy entry and exit feature	116
General notes	27	Copyright	42	Memory function	118
Protecting the environment	27	Occupant safety	43	Stowage areas	119
Genuine Mercedes-Benz parts	27	Restraint system	43	Cup holder	135
Operator's Manual	28	Seat belts	45	Sockets	138
Touch-sensitive controls	29	Airbags	50	Wireless charging of the mobile phone and connection with the exterior antenna	138
Mercedes me app	29	PRE-SAFE® system	57	Installing and removing the floor mats	141
		Automatic measures after an accident	58	Light and visibility	143
		Safely transporting children in the vehicle	58	Exterior lighting	143
		Notes on pets in the vehicle	72	Interior lighting	154

Windshield wiper and windshield washer system 157
 Mirrors 159
 Area permeable to radio waves on the windshield 162
 Infrared-reflective windshield function 162

Climate control 163
 Overview of climate control systems 163
 Operating the climate control system 166

Driving and parking 178
 Driving 178
 DYNAMIC SELECT button 191
 Transmission 193
 Function of the 4MATIC 195
 Charging the high-voltage battery 195
 Parking 210
 Driving and driving safety systems 217
 Vehicle towing instructions 285

Driver display 286
 Notes on the driver display 286

Notes on the range 286
 Operating the driver display 287
 Driver display menus 288
 Head-up Display 288
 Overview of status displays on the driver's display 292

MBUX multimedia system 294
 Overview and operation 294
 System settings 316
 Drive system settings 321
 Navigation and traffic 321
 Telephone 333
 Mercedes me app 336
 Mercedes-Benz emergency call system 343
 Radio & media 346
 Sound settings 352

Maintenance and care 353
 ASSYST PLUS service interval display 353
 Engine compartment 354
 Adding washer fluid to the windshield washer system 355
 Cleaning and care 356

Breakdown assistance 363
 Emergency 363
 Flat tire 364
 Battery (vehicle) 370
 Tow starting or towing away 372
 Electrical fuses 378

Wheels and tires 381
 Notes on noise or unusual handling characteristics 381
 Notes on regularly inspecting wheels and tires 381
 Notes on snow chains 382
 Activating or deactivating snow chain mode 382
 Tire pressure 383
 Loading the vehicle 388
 Tire labeling 392
 Definition of terms for tires and loading 397
 Changing a wheel 399
 Emergency spare wheel 408

Technical data 410
 Notes on technical data 410

4 Contents

Vehicle electronics	410
Regulatory radio identification and notes	412
Vehicle identification plate, VIN and engine number overview	412
Operating fluids	414
Vehicle data	418

Display messages and warning/indicator

lamps	420
Display messages	420
Warning and indicator lamps	484

Index	500
--------------------	------------

In this Operator's Manual, you will find the following symbols:

⚠ DANGER Danger due to not observing the warning notices

Warning notices draw your attention to hazards that may endanger your health or life, or the health or life of others.

▶ Observe the warning notices.

🌿 ENVIRONMENTAL NOTE Environmental damage due to failure to observe environmental notes

Environmental notes include information on environmentally responsible behavior or environmentally responsible disposal.

▶ Observe environmental notes.

! NOTE Damage to property due to failure to observe notes on material damage

Notes on material damage inform you of risks which may lead to your vehicle being damaged.

▶ Observe notes on material damage.

ⓘ These symbols indicate useful instructions or further information that could be helpful to you.

▶ Instruction

(→ page) Further information on a topic

Display Display on the central display







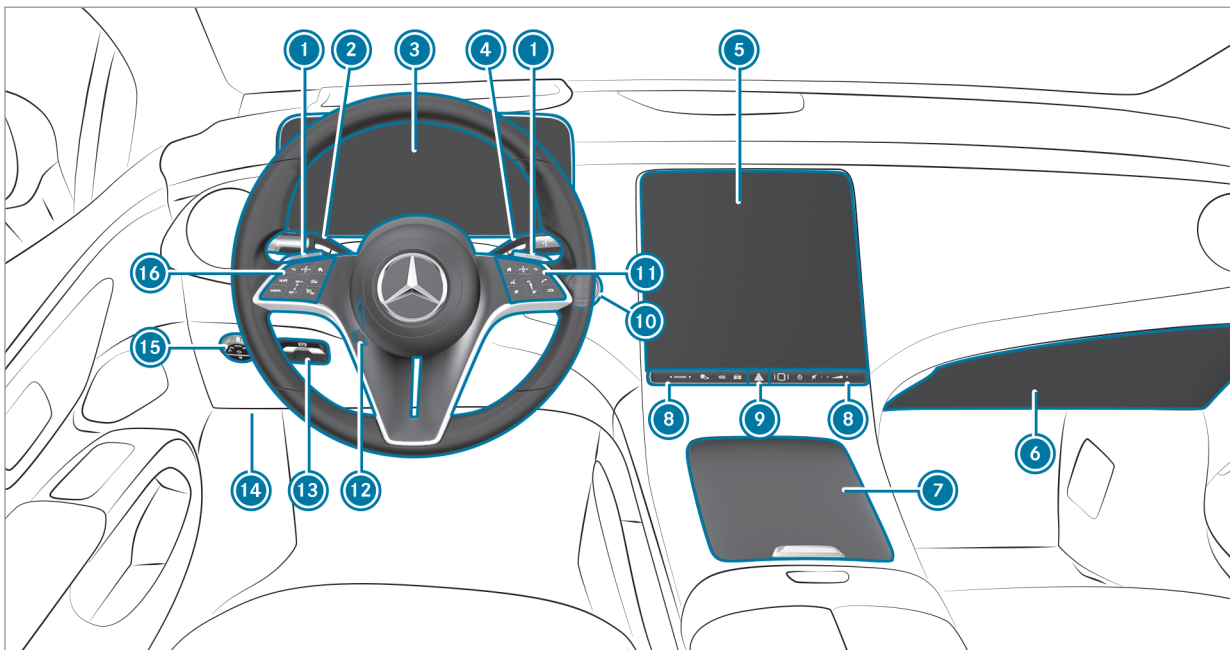





↪ Highest menu level, which is to be selected in the multimedia system

▶▶ Relevant submenus, which are to be selected in the multimedia system

* Indicates a cause







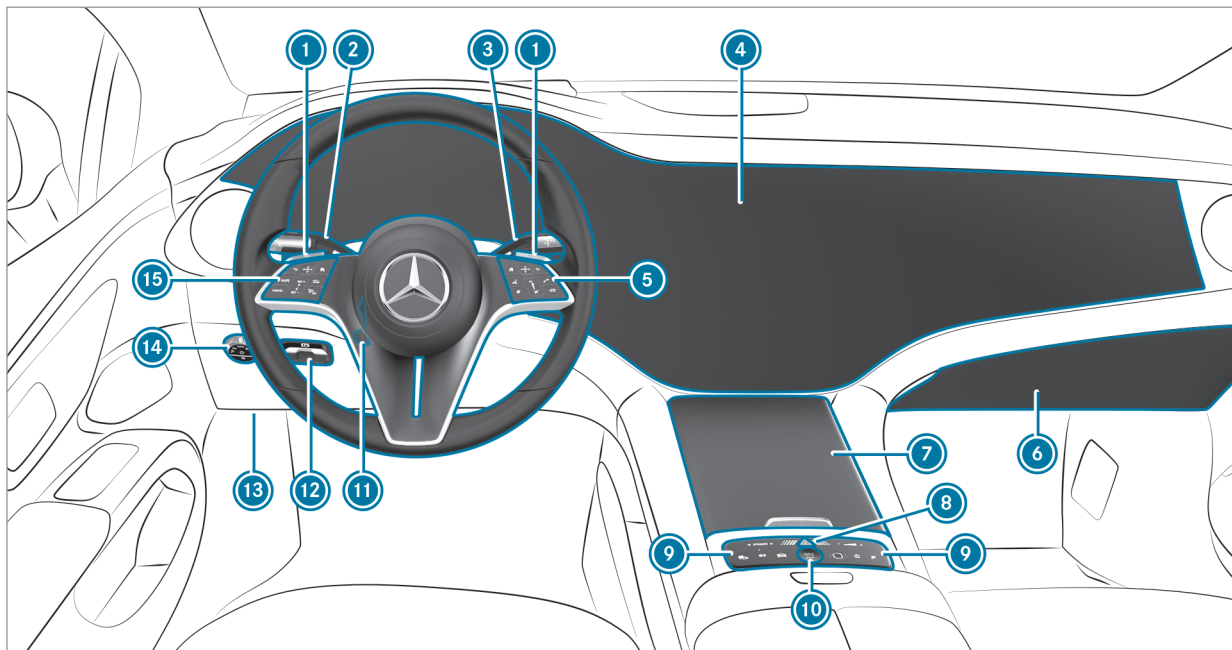







Left-hand-drive vehicles (with central display)

①	 Increases recuperation	→	187		
	 Reduces recuperation	→	187		
②	Combination switch	→	144		
③	Driver display	→	287		
④	DIRECT SELECT lever	→	193		
⑤	Central display	→	294		
⑥	Glove box	→	122		
⑦	Stowage space	→	122		
⑧	Switch panel for:				
	 DYNAMIC SELECT button	→	192		
	 Active Parking Assist	→	272		
	 Calls up the EQ menu	→	209		
	 Quick vehicle access				
	 Fingerprint sensor	→	294		
	 Switches the MBUX multimedia system on/off	→	294		
	 Switches sound on/off	→	294		
	 Adjusts the volume	→	294		
⑨	 Hazard warning light system	→	145		
⑩	Start/stop button	→	181		
⑪	Control panel for the MBUX multimedia system	→	303		
⑫	Adjusts the steering wheel	→	115		
⑬	 Electric parking brake	→	214		
⑭	Diagnostics connection	→	33		
⑮	Light switch	→	143		
⑯	Control panel:				
	Driver display	→	287		
	 Active Distance Assist DISTRONIC	→	231		









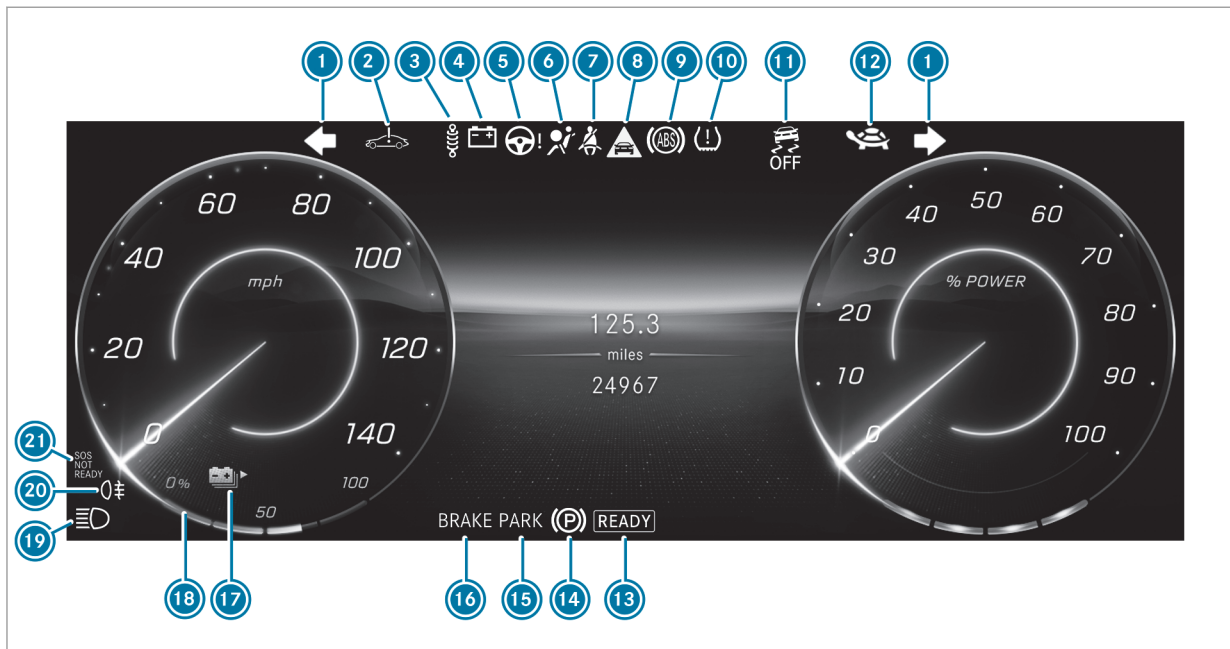

























Left-hand-drive vehicles (with MBUX Hyperscreen)

①	 Increases recuperation	→	187	 Calls up the EQ menu	→	209
	 Reduces recuperation	→	187	 Quick vehicle access		
②	Combination switch	→	144	 Fingerprint sensor	→	294
③	DIRECT SELECT lever	→	193	 Switches the MBUX multimedia system on/off	→	294
④	MBUX Hyperscreen with:			 Switches sound on/off	→	294
	Driver display	→	286	 Adjusts the volume	→	294
	Central display	→	294	⑩ Start/stop button	→	181
	Front passenger display	→	294	⑪ Adjusts the steering wheel	→	115
⑤	Control panel for the MBUX multimedia system	→	303	⑫  Electric parking brake	→	214
⑥	Glove box	→	122	⑬ Diagnostics connection	→	33
⑦	Stowage space	→	122	⑭ Light switch	→	143
⑧	 Hazard warning light system	→	145	⑮ Control panel:		
⑨	Switch panel for:			Driver display	→	287
	 DYNAMIC SELECT button	→	192	 Active Distance Assist DISTRONIC	→	231
	 Active Parking Assist	→	272			

10 At a glance - Indicator and warning lamps (standard)



Standard driver display

1		Turn signal lights	→	144	12		Reduced power	→	487
2		System error	→	487	13		Operational readiness of drive system	→	181
3		Suspension (red)	→	493	14		Electric parking brake (yellow)	→	490
		Suspension (yellow)	→	493	15		Electric parking brake (red)	→	490
4		Electrical malfunction	→	487			USA only		
5		Power steering (red)	→	488			Canada only		
		Power steering (yellow)	→	488	16		Brakes (red)	→	490
		Rear axle steering (red)	→	488			USA only		
		Rear axle steering (yellow)	→	488			Canada only		
6		Restraint system	→	485			Recuperative Brake System, USA only	→	490
7		Seat belt	→	485			Brakes (yellow), Canada only	→	490
8		Distance warning	→	493	17		Range		
9		ABS	→	495	18		Condition of charge display		
10		Tire pressure monitoring system	→	498	19		High beam	→	144
11		ESP® OFF	→	495			Low beam	→	143
		ESP®	→	495			Parking lights	→	143

12 At a glance - Indicator and warning lamps (standard)

20  Rear fog light



144

21  Mercedes-Benz emergency call system









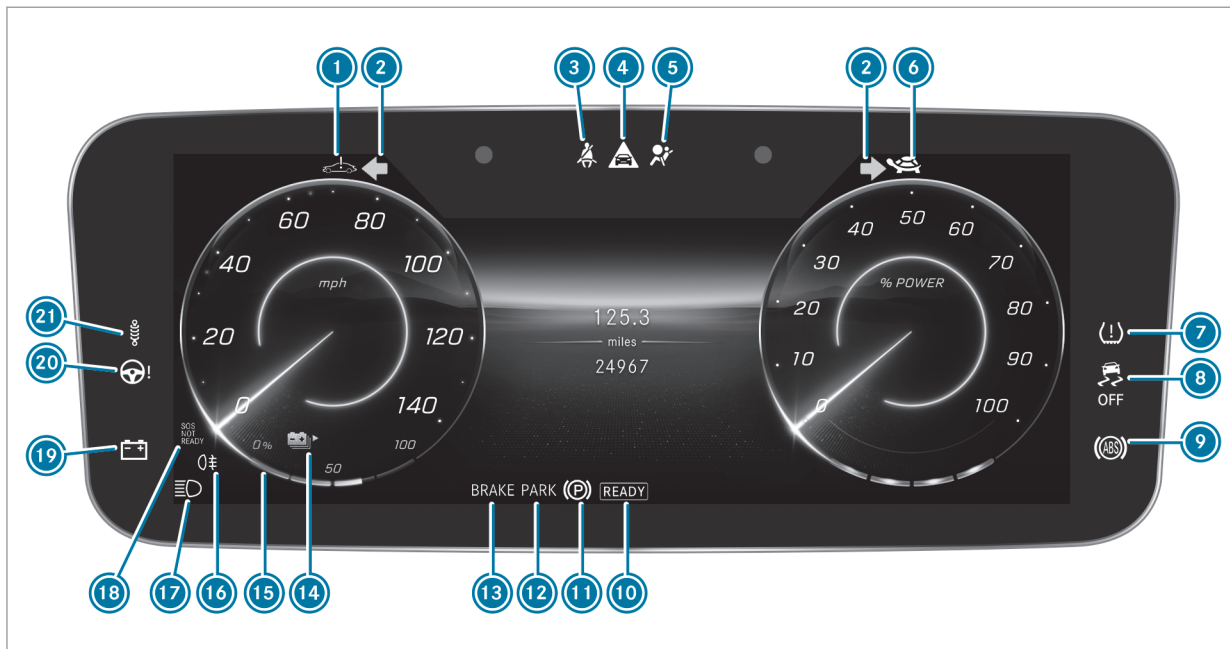

























497



14 At a glance – Indicator and warning lamps (with driver camera)



Driver display with driver camera

1		System error	→	487			
2		Turn signal lights	→	144			
3		Seat belt	→	485			
4		Distance warning	→	493			
5		Restraint system	→	485			
6		Reduced power	→	487			
7		Tire pressure monitoring system	→	498			
8		ESP® OFF	→	495			
		ESP®	→	495			
9		ABS	→	495			
10		Operational readiness of drive system	→	181			
11		Electric parking brake (yellow)	→	490			
12		Electric parking brake (red)	→	490			
		USA only					
		Canada only					
13		Brakes (red)	→	490			
		USA only					
		Canada only					
		Recuperative Brake System, USA only	→	490			
		Brakes (yellow), Canada only	→	490			
14		Range					
15		Charge level display					
16		Rear fog light	→	144			
17		High beam	→	144			
		Low beam	→	143			
		Parking lights	→	143			
18		Mercedes-Benz emergency call system	→	497			
19		Electrical malfunction	→	487			
20		Power steering (red)	→	488			
		Power steering (yellow)	→	488			
		Rear axle steering (red)	→	488			
		Rear axle steering (yellow)	→	488			

16 At a glance - Indicator and warning lamps (with driver camera)

  Suspension (red)





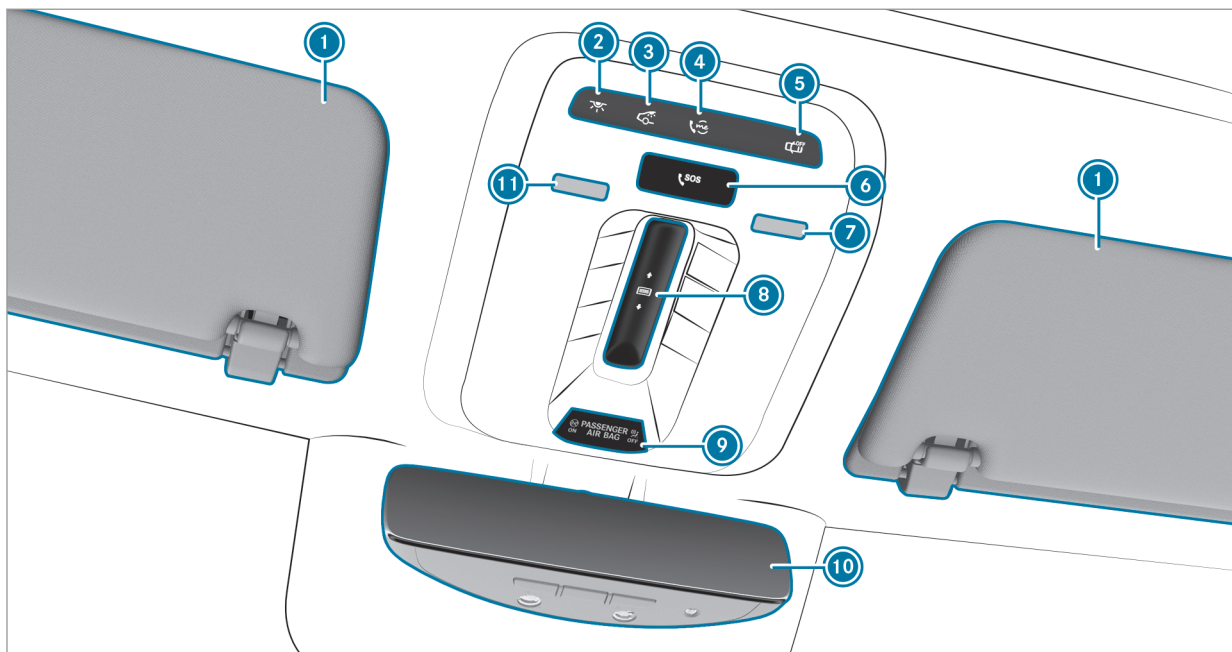

→ 493

 Suspension (yellow)









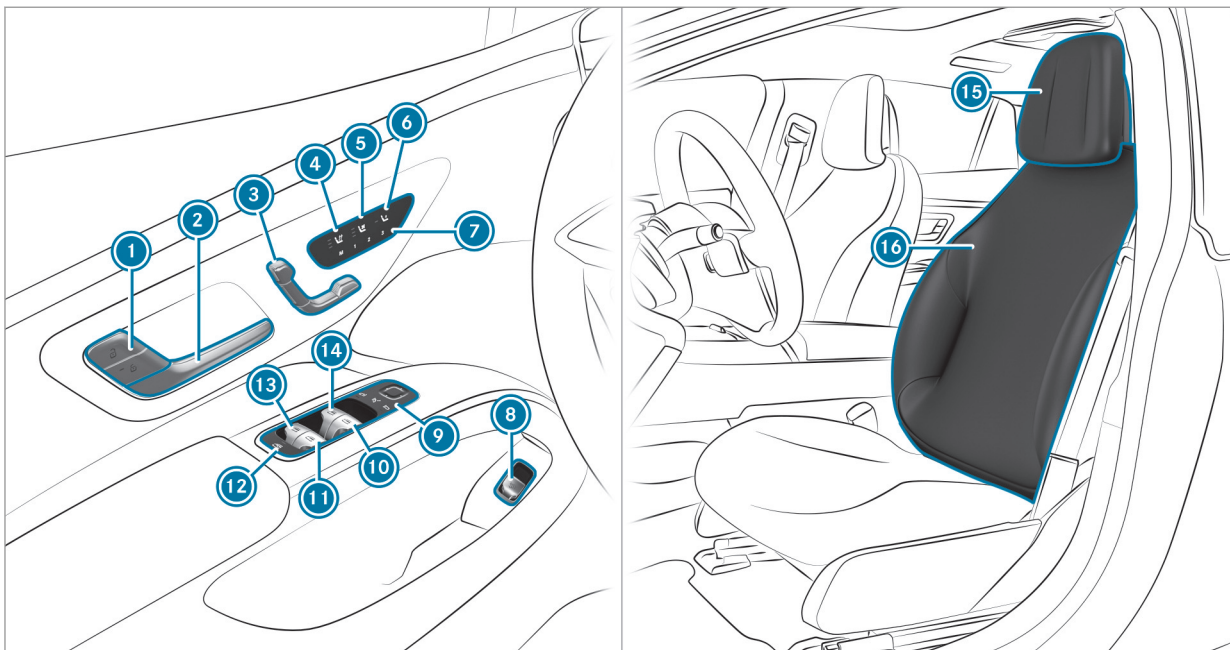



→ 493







1	Sun visors		
2	 Switches the front interior lighting on/off	→	154
3	 Switches the rear interior lighting on/off	→	154
4	 me button	→	336
5	 Switches automatic interior lighting control on/off	→	154
6	 SOS button	→	336
7	Switches the right-hand reading lamp on/off	→	154
8	 Opens/closes the panorama roof with power tilt/sliding panel	→	95
	 Opens/closes the roller sunblind the panorama roof with power tilt/sliding panel	→	95
9	PASSENGER AIR BAG indicator lamps	→	54
10	Inside rearview mirror	→	160
11	Switches the left-hand reading lamp on/off	→	154



①	 	Locks/unlocks the vehicle	→	78	⑨		Operates the outside mirrors	→	159
②		Opens the door	→	77	⑩		Opens/closes the right side window	→	92
③		Adjusts the seats electrically	→	102	⑪		Opens/closes the rear right side window	→	92
④		Switches the seat heating on/off	→	113	⑫		Child safety lock for the rear side windows	→	72
⑤		Switches the seat ventilation on/off	→	114	⑬		Opens/closes the rear left side window	→	92
⑥		Adjusts the front passenger seat from the driver's seat	→	105	⑭		Opens/closes the left side window	→	92
⑦		Operates the memory function	→	119	⑮		Adjusts the head restraints	→	108
⑧		Opens/closes the tailgate	→	87	⑯		Seat adjustment using the multimedia system	→	111

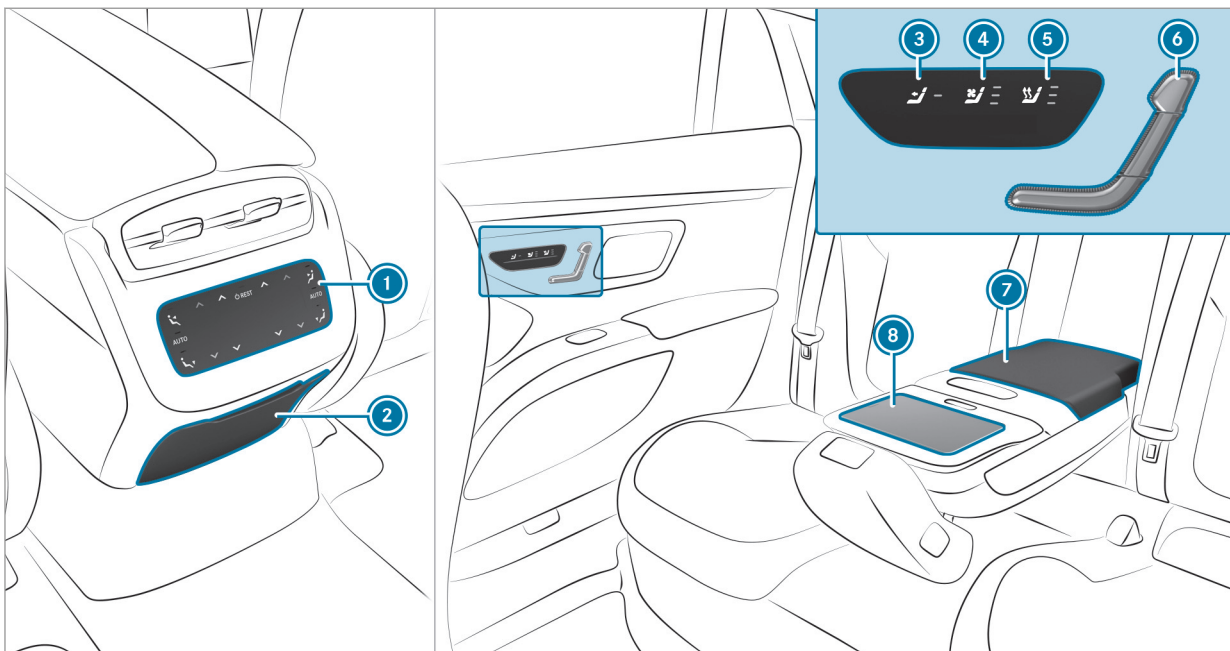

22 At a glance – Control settings in the rear passenger compartment

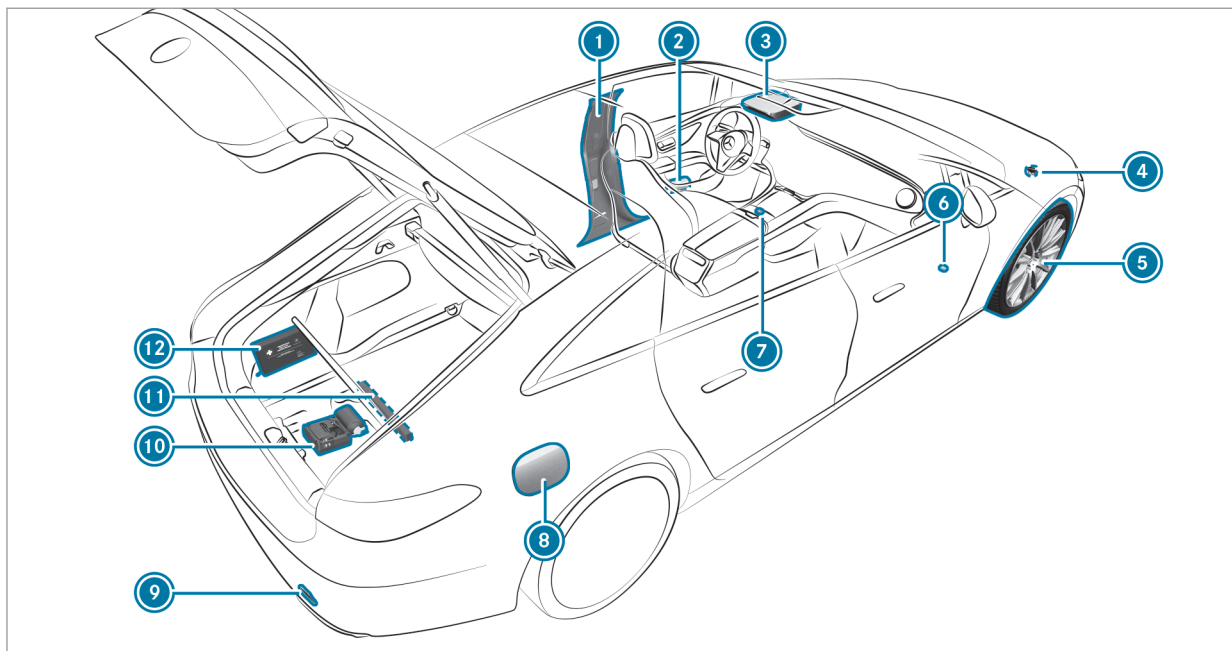

①	Climate control rear operating unit	→	165
②	Electronics compartment in the center console		
③	 Selects the front passenger seat	→	105
④	 Switches the rear seat ventilation on/off	→	114

⑤	 Switches the rear seat heating on/off	→	113
⑥	Adjusts the rear seats electrically	→	106
⑦	Stowage compartment in the rear armrest		
⑧	Charges a mobile phone wirelessly	→	140



① B-pillar with: QR code for accessing the rescue card	→	37	⑦  Hazard warning light system	→	145
② Safety vests	→	363	⑧ Socket flap with: Information label on tire pressure	→	384
③  me button	→	336	QR code for accessing the rescue card	→	37
 SOS button	→	336	⑨ Towing away	→	372
④ Towing away	→	372	⑩ TIREFIT kit	→	366
⑤ Flat tire	→	364	⑪ Warning triangle	→	363
⑥ To operate the high-voltage disconnect device	→	179	⑫ First-aid kit (soft sided)	→	364

Calling up the Digital Operator's Manual

Multimedia system:

→  » Settings » Info

» Operator's Manual

» Open Digital Operator's Manual

The Digital Operator's Manual describes the functions and operation of the vehicle and the multimedia system.

▶ Select one of the following menu items in the Digital Operator's Manual:

- **Quick start:** find the first steps towards adjusting your seat (driver's side).
- **Tips:** find information that prepares you for certain everyday situations with your vehicle.
- **Animations:** watch animations of the vehicle functions.
- **Messages:** receive additional information about the messages in the driver's display.
- **Language:** select the language for the Digital Operator's Manual.

You can search for keywords using the search field **Search**, in order to find quick answers to questions about the operation of the vehicle.

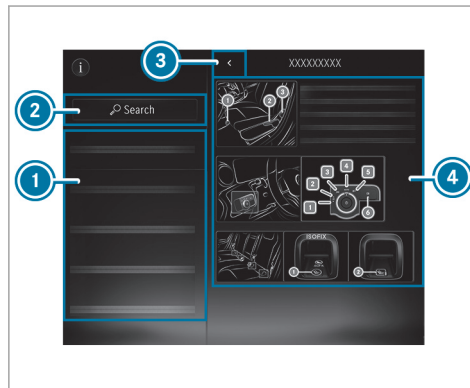

- 1 Menu
- 2 Search
- 3 Back
- 4 Contents section

Some sections in the Digital Operator's Manual, such as warning notes, can be expanded and collapsed.

Additional methods of calling up the Digital Operator's Manual:

Driver display: call up brief information as display messages in the driver's display

MBUX Voice Assistant: call up via the voice control system

Global search: call up search results for contents of the Digital Operator's Manual in the home screen

For safety reasons, the Digital Operator's Manual is deactivated while driving.

Protecting the environment

 **ENVIRONMENTAL NOTE** Environmental damage due to operating conditions and personal driving style

Operate your vehicle in an environmentally responsible manner to help protect the environment. Please observe the following recommendations on operating conditions and personal driving style.

Operating conditions:

- ▶ Make sure that the tire pressure is correct.
- ▶ Do not carry any unnecessary weight (e.g. roof luggage racks once you no longer need them).
- ▶ Monitor the energy consumption.
- ▶ Adhere to the service intervals. A regularly serviced vehicle will contribute to environmental protection.
- ▶ Always have maintenance work carried out at a qualified specialist workshop.

Personal driving style:

- ▶ Drive carefully and maintain a suitable distance from the vehicle in front.
- ▶ Avoid frequent, sudden acceleration and braking.
- ▶ Drive in a style which saves energy. Observe the ECO display for an economical driving style.

 **ENVIRONMENTAL NOTE** Environmental pollution caused by irresponsible disposal of the high-voltage battery

A high-voltage battery contains materials which are harmful to the environment.

- ▶ Dispose of defective high-voltage batteries at a qualified specialist workshop.

Environmental issues and recommendations

It is recommended that you re-use or recycle materials instead of just disposing of them.

The relevant environmental guidelines and regulations serve to protect the environment and must be strictly observed.

Genuine Mercedes-Benz parts

 **ENVIRONMENTAL NOTE** Environmental damage due to not using recycled reconditioned components

Mercedes-Benz AG offers recycled reconditioned components and parts with the same quality as new parts. The same entitlement from the Limited Warranty is valid as for new parts.

- ▶ Use recycled reconditioned components and parts from Mercedes-Benz AG.

 **NOTE** Impairment of the operating efficiency of the restraint systems from installing accessory parts or from repairs or welding

Airbags and Emergency Tensioning Devices, as well as control units and sensors for the restraint systems, may be installed in the following areas of your vehicle:

- Doors

- Door pillars
- Door sills
- Seats
- Cockpit
- Instrument cluster
- Center console
- Lateral roof frame

- ▶ Do not install accessory parts such as audio systems in these areas.
- ▶ Do not carry out repairs or welding.
- ▶ Have accessory parts retrofitted at a qualified specialist workshop.

You could jeopardize the operating safety of your vehicle if you use parts, tires and wheels as well as accessories relevant to safety which have not been approved by Mercedes-Benz. Safety-relevant systems, e.g. the brake system, may malfunction. Only use genuine Mercedes-Benz parts or parts of equal quality. Only use tires, wheels and accessory parts that have been specifically approved for your vehicle model.

Genuine Mercedes-Benz parts are subject to strict quality inspections. Each part has been specially developed, manufactured or selected for Mercedes-Benz vehicles and adapted to them. Therefore, only genuine Mercedes-Benz parts should be used.

More than 300,000 different genuine Mercedes-Benz parts are available for Mercedes-Benz models.

All authorized Mercedes-Benz Centers maintain a supply of genuine Mercedes-Benz parts for necessary service and repair work. In addition, strategically located parts delivery centers provide for quick and reliable parts service.

Always specify the vehicle identification number (VIN) (→ page 412) when ordering genuine Mercedes-Benz parts.

Operator's Manual

This Operator's Manual and the Digital Operator's Manual in the vehicle describe the following models and the standard and special equipment for your vehicle:

- The models and the standard and special equipment available at the time of this Operator's Manual going to press.
- The models and the standard and special equipment only available in certain countries.
- The models and the standard and special equipment, which will only be available at a later date.

Note that your vehicle may not be equipped with all features described. This is also the case for systems relevant to safety. Therefore, the equipment on your vehicle may differ from that in the descriptions and illustrations.

The original purchase agreement for your vehicle contains a list of the equipment in your vehicle at the time of delivery.

Should you have any questions concerning equipment and operation, please consult an authorized Mercedes-Benz Center.

The Operator's Manual, Supplement, further supplementary documents and Maintenance Booklet are important documents and should be kept in the vehicle.

Touch-sensitive controls

In addition to conventional switches and buttons, your vehicle is equipped with touch-sensitive controls.

These are located in the following areas of your vehicle:

- Roof and door control panel
- Climate control
- Steering wheel
- MBUX multimedia system

The controls have touch-sensitive user interface surfaces. The surfaces are controlled by pressing or swiping to adjust settings or to trigger functions, for example.

In the area of the touchscreen, you also receive haptic feedback in the form of a pulse or a vibration, or the surface structure changes on the touch-sensitive user interface surface, for example.

You receive haptic feedback in the following situations, for example:

- When pressing a button on the user interface surface
- When scrolling in a list or table
- When reaching a new area on the user interface surface, e.g. a pop-up window

When handling touch-sensitive user interface surfaces, observe the following points to avoid problems operating:

- Do not affix stickers or similar objects on the surfaces
- Keep the surfaces protected from moisture and wet conditions
- Keep the surfaces free of dust and dirt

Some touch-sensitive control elements have a symbol and integrated indicator lamps. When

operating, make sure to press on the symbol of the control element.

Mercedes me app

Notes about the on-demand feature

You can also activate various functions (on-demand feature) subsequently via Mercedes me after purchasing your vehicle.

Information is available at any authorized Mercedes-Benz Center.

Activating on-demand feature using Mercedes me

Requirements:

- The vehicle has GPS reception.
- The vehicle is linked to the Mercedes me user account.

Ordering and activating on-demand feature

- ▶ Add the desired on-demand feature for the vehicle to the shopping basket in the Mercedes me Store.

- ▶ Complete the order.
The on-demand feature is activated when operating the vehicle.

Speeding up activation

- ▶ Switch the vehicle off and lock it.
- ▶ After about 2 minutes, unlock the vehicle and switch on the vehicle.
The on-demand feature has been activated.
For some features, a notification also appears in the vehicle's multimedia system.

If the activation was not successful, repeat the process.

Service and vehicle operation

Vehicle operation outside the USA or Canada

When you are abroad with your vehicle, observe the following points:

- Service points or replacement parts may not be available immediately.

Some Mercedes-Benz models are available in Europe through our European Delivery Program.

For more information, please consult an authorized Mercedes-Benz Center, or write to one of the following addresses:

In the USA:

Mercedes-Benz USA, LLC
European Delivery Department
One Mercedes-Benz Drive
Sandy Springs, GA 30328

In Canada:

Mercedes-Benz Canada, Inc.
European Delivery Department
98 Vanderhoof Avenue
Toronto, Ontario M4G 4C9

Maintenance

Your customer advisor confirms the service in the service report.

Roadside Assistance

The Mercedes-Benz Roadside Assistance Program offers technical help in the case of a breakdown.

Your calls to the toll-free Roadside Assistance Hotline are answered by our agents 24 hours a day, 365 days a year.

1-800-FOR-MERCedes (1-800-367-6372) (USA)
1-800-387-0100 (Canada)

You can find further information in the Mercedes-Benz Roadside Assistance Program brochure (USA) or the "Roadside Assistance" section in the Service and Warranty booklet (Canada). You will find both in the vehicle document wallet.

Change of address or change of ownership

In the event of a change of address, please send us the "Notification of address change" in the Service and Guarantee booklet or simply call the Mercedes-Benz Customer Assistance Center (USA) on the hotline number 1-800-FOR-MERCedes (1-800-367-6372) or Customer Service (Canada) on 1-800-387-0100. We can then reach you in a timely fashion, if necessary.

If you sell your Mercedes, please leave all literature in the vehicle so that it is available to the next

owner. If you have purchased a used vehicle, please send us the "Notice of Purchase of Used Car" in the Service and Guarantee booklet or simply call the Mercedes-Benz Customer Assistance Center (USA) at the hotline number 1-800-FOR-MERCEdes (1-800-367-6372) or Customer Service (Canada) at 1-800-387-0100.

Possible danger due to substances hazardous to health

In compliance with Proposition 65 ("Prop65"), the following detachable label has been added to each vehicle sold in California:



WARNING



Operating, servicing and maintaining a passenger vehicle, pickup truck, van or off-road motor vehicle can expose you to chemicals including engine exhaust, carbon monoxide, phthalates, and lead, which are known to the State of California to cause cancer and birth defects or other reproductive harm. To minimize exposure, avoid breathing exhaust, do not idle the engine except as necessary, service your vehicle in a well-ventilated area and wear gloves or wash your hands frequently when servicing your vehicle. For more information go to www.P65Warnings.ca.gov/passenger-vehicle

A 000 817 82 02

Operating safety

⚠ WARNING Risk of accident due to malfunctions or system failures

To avoid malfunctions or system failures:

- ▶ Always have the prescribed service and maintenance work as well as any required repairs carried out at a qualified specialist workshop.

⚠ WARNING Risk of accident or injury due to incorrect modifications on electronic component parts

Modification of electronic components, their software or wiring could impair their function and/or the function of other networked component parts or safety-relevant systems.

This can endanger the operating safety of the vehicle.

- ▶ Never tamper with the wiring and electronic component parts or their software.

- ▶ You should have all work on electrical and electronic components carried out at a qualified specialist workshop.

Observe the "On-board electronics" section in "Technical data".

! NOTE Damage to the vehicle caused by driving too fast and by blows to the underbody and chassis parts

The vehicle can be damaged in the following cases in particular:

- The underside of the vehicle makes contact with the ground, e.g. on a high curb or an unpaved road.
- The vehicle drives too quickly over an obstacle, e.g. a curb, a speed bump or a pothole.
- A heavy object hits the underbody or chassis components.

In these or similar situations, the vehicle body, the underbody, chassis components, wheels or tires and parts of the high-voltage battery

could be damaged even if this is not visible. Components that have been damaged in this way can fail unexpectedly or, in the event of an accident, may not absorb the loads that arise as intended.

▶ Have the vehicle checked and repaired immediately at a qualified specialist workshop.

or

▶ If driving safety is impaired during the rest of the journey, stop immediately paying attention to the traffic situation and notify a qualified specialist workshop.

Electric vehicles have an electric motor. The electric motor's energy supply is provided by the high-voltage on-board electrical system.

⚠ DANGER Risk of death and fire due to modified and/or damaged components of the high-voltage on-board electrical system

The vehicle's high-voltage on-board electrical system is under high voltage. If you modify component parts in the vehicle's high-voltage on-board electrical system or touch damaged component parts, you may be electrocuted. In addition, modified and/or damaged components may cause a fire.

In the event of an accident or impact to the vehicle underbody, components of the high-voltage electrical system may be damaged although the damage is not visible.

- ▶ Never make any modifications to the high-voltage on-board electrical system.
- ▶ Do not switch on or use the vehicle if its high-voltage on-board electrical system components have been modified or damaged.

- ▶ Never touch damaged components of the high-voltage on-board electrical system.
- ▶ After an accident, do not touch any components of the high-voltage on-board electrical system.
- ▶ After an accident, have the vehicle transported away.
- ▶ Have the components of the high-voltage on-board electrical system checked at a qualified specialist workshop and replaced if necessary.

The components of the high-voltage on-board electrical system are marked with yellow warning stickers. The cables of the high-voltage on-board electrical system are orange.



Vehicles with an electric motor generate significantly less vehicle noise emissions than vehicles with combustion engines. As a result, your vehicle may not be heard by other road users in certain situations. This can occur, for example, when you are parking and your vehicle cannot be seen by other road users. This requires you to adopt a particularly anticipatory driving style, as it is necessary to allow for the possibility that other road users may behave unpredictably.

Declaration of conformity for vehicle installed radio components



USA: "Radio based devices of this vehicle comply with Part 15 of the FCC Rules. Operation is subject to the following two conditions: 1) These devices may not cause harmful interference, and 2) These devices must accept any interference received, including interference that may cause undesired operation. Changes or modifications not expressly approved by the party responsible for compliance could void the user's authority to operate the equipment."

Canada: "This vehicle contains licence-exempt transmitter(s)/receiver(s) that comply with Innovation, Science and Economic Development Canada's licence-exempt RSS(s). Operation is subject to the following two conditions: (1) These devices may not cause interference. (2) These devices must accept any interference, including interference that may cause undesired operation of the devices." "Les émetteurs/récepteurs dans cette

véhicule sont conforme aux CNR d'Innovation, Sciences et Développement économique Canada applicables aux appareils radio exempts de licence. L'exploitation est autorisée aux deux conditions suivantes : 1) Ces appareils ne doivent pas produire de brouillage; 2) Ces appareils doivent accepter tout brouillage radioélectrique subi, même si le brouillage est susceptible d'en compromettre le fonctionnement."

Diagnostics connection

The diagnostics connection is a technical interface in the vehicle. It is used, for example, in the context of repair and maintenance work or for reading out vehicle data at a specialist workshop. Diagnostic devices should therefore only be connected at a qualified specialist workshop.

⚠ WARNING Risk of accident due to connecting devices to the diagnostics connection

If you connect devices to the diagnostics connection of the vehicle, the function of vehicle

systems and operating safety may be impaired.

- ▶ For safety reasons, we recommend that you only use and connect products approved by your authorized Mercedes-Benz Center.

⚠ WARNING Risk of accident due to objects in the driver's footwell

Objects in the driver's footwell may impede pedal travel or block a depressed pedal.

This jeopardizes the operating and road safety of the vehicle.

- ▶ Stow all objects in the vehicle securely so that they cannot get into the driver's footwell.
- ▶ Always install the floor mats securely and as prescribed in order to ensure that there is always sufficient room for the pedals.
- ▶ Do not use loose floor mats and do not place floor mats on top of one another.

! NOTE Battery discharging from using devices connected to the diagnostics connection

Using devices at the diagnostics connection drains the battery.

- ▶ Check the charge level of the battery.
- ▶ If the charge level is low, charge the battery, e.g. by driving a considerable distance.

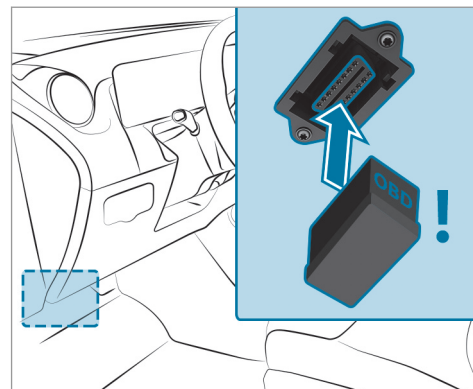

Connecting and using another device with the diagnostics connection can have the following effects:

- Malfunctions in the vehicle system
- Permanent damage to vehicle components

Please refer to the warranty terms and conditions for this matter.

Qualified specialist workshop

An authorized Mercedes-Benz Center is a qualified specialist workshop. It has the necessary special skills, tools and qualifications to correctly carry out the work required on your vehicle. This particularly applies to safety-relevant works.

For the following, always have your vehicle checked at an authorized Mercedes-Benz Center:

- Safety-relevant works
- Service and maintenance work
- Repair work
- Modifications as well as installations and conversions
- Work on electronic components

Mercedes-Benz recommends a Mercedes-Benz service center.

Correct use of the vehicle

If you remove any warning stickers, you or others could fail to recognize certain dangers. Leave warning stickers in position.

Observe the following information in particular when driving your vehicle:

- The safety notes in this Operator's Manual, vehicle-specific supplements and further supplementary documents
- Technical data for the vehicle
- Traffic rules and regulations
- Laws and safety standards pertaining to motor vehicles

Notes for persons with electronic medical aids

Mercedes-Benz AG cannot, despite carefully developing vehicle systems, completely rule out the interaction of vehicle systems with electronic medical aids such as cardiac pacemakers.

In addition, there are components installed in the vehicle that, regardless of the operating status of the vehicle, can generate magnetic fields on a par with permanent magnets. These fields can be found, for example, in the area around the multimedia and sound system or also in the area of the seats, depending on the vehicle equipment.

For this reason, the following can occur in isolated cases, depending on the aids used:

- Medical aids malfunctioning
- Adverse health effects

Observe the notes and warnings of the manufacturer of the medical aids; if in doubt, contact the device manufacturer and/or your doctor. If there is continuing uncertainty concerning the possibility of medical aids malfunctioning, Mercedes-Benz AG recommends using only few electrical vehicle systems and/or maintaining a distance from the components.

When charging the high-voltage battery, keep a distance of at least an arm's length between the medical aid and the following components:

- The power supply equipment
This includes charging stations in the form of a wallbox or a public charging point, for example.
- Vehicle components carrying live voltage
This includes the charging cable and the charging control box, for example.

Only have repairs and maintenance work in the area of the following components carried out at a qualified specialist workshop:

- Vehicle components carrying live voltage
- Transmission antenna
- Multimedia system and sound system

If you have any queries or suggestions, consult a qualified specialist workshop.

Problems with your vehicle

If you should experience a problem with your vehicle, particularly one that you believe may affect its safe operation, we urge you to contact an authorized Mercedes-Benz Center immediately to have the problem diagnosed and rectified. If the problem is not resolved to your satisfaction, please discuss the problem again with an authorized Mercedes-Benz Center or, if necessary, contact us at one of the following addresses:

In the USA:

Mercedes-Benz USA, LLC
Customer Assistance Center

One Mercedes-Benz Drive
Sandy Springs, GA 30328

In Canada:

Mercedes-Benz Canada, Inc.
Customer Relations Department
98 Vanderhoof Avenue
Toronto, Ontario M4G 4C9

Reporting safety defects

USA only:

The following text is published as required of manufacturers under Title 49, Code of U.S. Federal Regulations, Part 575 pursuant to the "National Traffic and Motor Vehicle Safety Act of 1966".

If you believe that your vehicle has a defect which could cause a crash or could cause injury or death, you should immediately inform the National Highway Traffic Safety Administration (NHTSA) in addition to notifying Mercedes-Benz USA, LLC.

If NHTSA receives similar complaints, it may open an investigation, and if it finds that a safety defect exists in a group of vehicles, it may order a recall

and remedy campaign. However, NHTSA cannot become involved in individual problems between you, your dealer, or Mercedes-Benz USA, LLC.

To contact NHTSA, you may call the Vehicle Safety Hotline toll-free at 1-888-327-4236 (TTY: 1-800-424-9153); go to the <https://www.safercar.gov/>; or write to: Administrator, NHTSA, 400 Seventh Street, SW., Washington, DC 20590.; USA.

You can also obtain other information about motor vehicle safety from: <https://www.safercar.gov>

Canada only:

The following text is published as required of manufacturers under subsection 18.4 (4) of the Motor Vehicle Safety Regulations.

If you believe that your vehicle has a defect which could cause a crash or could cause injury or death, you should immediately inform Transport Canada in addition to notifying Mercedes-Benz Canada Inc.

If Transport Canada received similar complaints, it may open an investigation, and if it finds that a safety defect exists in a group of vehicles, it may order a recall and remedy campaign. However,

Transport Canada cannot become involved in individual problems between you, your dealer or Mercedes-Benz Canada Inc.

To contact Transport Canada, you may call the Defect Investigations and Recalls Division toll-free in Canada at 1-800-333-0510 or 819-994-3328 in the Gatineau-Ottawa area or internationally; you may also go to the following websites for more information:

- English: <https://www.tc.gc.ca/recalls>
- French: <https://www.tc.gc.ca/rappels>

Limited Warranty

! **NOTE** Damage to the vehicle arising from violation of these operating instructions.

Damage to the vehicle can arise from violation of these operating instructions.

This damage is not covered either by the Mercedes-Benz implied warranty or by the New- or Used-Vehicle Warranty.

▶ Follow the instructions in these operating instructions on proper operation of

your vehicle as well as on possible vehicle damage.

QR code for rescue card

QR codes are attached in the socket flap and on the opposite side on the B-pillar. In the event of an accident, rescue services can use the QR code to quickly find the appropriate rescue card for your vehicle. The current rescue card contains the most important information about your vehicle in a compact form, e.g. the routing of the electric lines.

Further information can be obtained at <https://www.mercedes-benz.de/qr-code>

Data storage

Data processing in the vehicle

Electronic control units

Electronic control units are installed in your vehicle. Control units process data which, for example, they receive from vehicle sensors, generate themselves or exchange between themselves.

Some control units are required for the safe operation of your vehicle, some assist you when driving, such as driver assistance systems, while others enable convenience or infotainment functions.

The following provides you with general information regarding data processing in the vehicle. Additional information regarding exactly which data in your vehicle are collected, saved and transmitted to third parties, and for what purpose, can be found in the information directly related to the functional characteristics in question in their respective Operator's Manual. This information is also available online and, depending on the vehicle equipment, digitally.

Personal data

Every vehicle is identified by a unique vehicle identification number. Depending on the country, this vehicle identification number can be used by, for example, governmental authorities to determine the identity of the owner. There are other possibilities to use data collected from the vehicle to identify the owner or driver, such as the license plate number.

Therefore, data generated or processed by control units may be attributable to a person or, under certain conditions, become attributable to a person. Depending on which vehicle data are available, it may be possible to make inferences about, for example, your driving behavior, your location, your route or your use patterns.

Legal requirements regarding the disclosure of data

If legally required to do so, manufacturers are, in individual cases, legally obliged to provide governmental entities, upon request and to the extent required, data stored by the manufacturer. For example, this may be the case during the investigation of a criminal offense.

Governmental entities are themselves, in individual cases and within the applicable legal framework, authorized to read out data from the vehicle. In the case of an accident, information that can help with an investigation can, therefore, be taken from the airbag control unit, for example.

Operational data in the vehicle

This is data regarding the operation of the vehicle, which have been processed by control units.

This includes the following data, for example:

- Vehicle status information such as the speed, longitudinal acceleration, lateral acceleration, number of wheel revolutions or the fastened seat belts display
- Ambient conditions, such as temperature, rain sensor or distance sensor

Generally, the use of these data is temporary; they will not be stored beyond the period of operation and will only be processed within the vehicle itself. Control units often contain data memories for vehicle keys, for example. Their use permits the temporary or permanent documentation of technical information about the vehicle's operating state, component loads, maintenance requirements and technical events or malfunctions.

Depending on the vehicle equipment, the following data are stored:

- Operating status of system components, such as fill levels, tire pressure or battery status
- Malfunctions or faults in important system components, such as lights or brakes

- System reactions in special driving situations, such as airbag deployment or the intervention of stability control systems
- Information on events leading to vehicle damage
- Condition of charge of the high-voltage battery, estimated range

In certain cases, it may be required to store data that would have otherwise been used only temporarily. This may be the case if the vehicle has detected a malfunction, for example.

If you use services, such as repair services and maintenance work, stored operational data as well as the vehicle identification number can be read out and used. They can be read out by service network employees, such as workshops and manufacturers or third parties, such as breakdown services. The same is true in the case of warranty claims and quality assurance measures.

In general, the readout is performed via the legally prescribed port for the diagnostics connection in the vehicle. The operational data that are read out document technical states of the vehicle or of individual components and assist in the diagnosis

of malfunctions, compliance with warranty obligations and quality improvement. To that end, these data, in particular information about component loads, technical events, malfunctions and other faults may be transmitted along with the vehicle identification number to the manufacturer. Furthermore, the manufacturer is subject to product liability. For this reason the manufacturer also uses operational data from the vehicle, for example, for recalls. These data can also be used to examine the customer's warranty and guarantee claims.

Fault memories in the vehicle can be reset by a service outlet or at your request as part of repair or maintenance work.

Convenience and infotainment functions

You can store convenience settings and individual settings in the vehicle and change or reset them at any time.

Depending on the vehicle equipment, this includes the following settings, for example:

- Seat and steering wheel positions
- Suspension and climate control settings
- Individual settings, such as interior lighting

Depending on the selected equipment, you can import data into vehicle infotainment functions yourself.

Depending on the vehicle equipment, this includes the following data, for example:

- Multimedia data, such as music, films or photos for playback in an integrated multimedia system
- Address book data for use in connection with an integrated hands-free system or an integrated navigation system
- Entered navigation destinations
- Data about the use of Internet services

These data for convenience and infotainment functions may be saved locally in the vehicle or they may be located on a device which you have connected to the vehicle, such as a smartphone, USB flash drive or MP3 player. If you have entered these data yourself, you can delete them at any time.

This data is transmitted from the vehicle to third parties only at your request. This applies, in par-

ticular, when you use online services in accordance with the settings that you have selected.

Smartphone integration (e.g. Android Auto or Apple CarPlay®)

If your vehicle is accordingly equipped, you can connect your smartphone or another mobile end device to the vehicle. You can then control them by means of the control elements integrated in the vehicle. Images and audio from the smartphone can be output via the multimedia system. Certain information is simultaneously transferred to your smartphone. Depending on the type and integration, this includes position data, day/night mode and other general vehicle statuses. For more information please consult the Operator's Manual of the vehicle/infotainment system.

This integration allows the use of selected smartphone apps, such as navigation or music player apps. There is no further interaction between the smartphone and the vehicle; in particular, vehicle data is not directly accessible. The type of additional data processing is determined by the provider of the app being used. Which settings you can make, if any, depends on the specific app and the operating system of your smartphone.

Online services

Wireless network connection

If your vehicle has a wireless network connection, it enables data to be exchanged between your vehicle and additional systems. The wireless network connection is made possible by the vehicle's own transmitter and receiver or by a mobile end device that you have brought into the vehicle, for example, a smartphone. Online functions can be used via the wireless network connection. This includes online services and applications/apps provided to you by the manufacturer or by other providers.

Manufacturer's services

Regarding the manufacturer's online services, the individual functions are described by the manufacturer in a suitable place, for example, in the Operator's Manual or on the manufacturer's website, where the relevant data protection information is also given. Personal data may be used for the provision of online services. Data are exchanged via a secure connection, such as the manufacturer's designated IT systems. Any personal data which are collected, processed and

used, other than for the provision of services, is done so exclusively on the basis of legal permission. This is the case, for example, for a legally prescribed emergency call system, a contractual agreement or when consent has been given.

You can have services and functions, some of which are subject to a fee, activated or deactivated. This excludes legally prescribed functions and services, such as an emergency call system.

Third party services

If you use online services from other providers (third parties), these services are the responsibility of the provider in question and subject to that provider's data protection conditions and terms of use. As a general rule, the manufacturer has no influence on the content exchanged.

For this reason, when services are provided by third parties, please ask the service provider in question for information about the type, extent and purpose of the collection and use of personal data.

Data protection rights

Depending on your country or the equipment and range of functions of your vehicle as well as the services you use and the services on offer, you are entitled to different data protection rights. Further information on data protection and your data protection rights can either be found on the manufacturer's website or you will receive this information as part of the various services and service offers. There you will also find the contact information for the manufacturer and its data protection officers.

At a workshop, for example, with the support of a specialist and possibly for a fee, you can have data read out which is stored only locally in the vehicle.

MBUX multimedia system/Mercedes me connect

If the vehicle is equipped with the MBUX multimedia system or Mercedes me connect, additional data about the vehicle's operation, the use of the vehicle in certain situations, and the location of the vehicle may be compiled by the MBUX multimedia system or Mercedes me connect.

For additional information, please refer to the "MBUX multimedia system" section and/or the Mercedes me connect Terms and Conditions.

Event data recorders

USA only:

This vehicle is equipped with an event data recorder (EDR). The main purpose of an EDR is to record, in certain crash or near crash-like situations, such as an airbag deployment or hitting a road obstacle, data that will assist in understanding how a vehicle's systems performed. The EDR is designed to record data related to vehicle dynamics and safety systems for a short period of time, typically 30 seconds or less.

The EDR in this vehicle is designed to record such data as:

- How various systems in your vehicle were operating
- Whether or not the driver and front passenger seat belts were buckled/fastened
- How far (if at all) the driver was depressing the accelerator and/or brake pedal and

- How fast the vehicle was traveling

This data can help provide a better understanding of the circumstances in which accidents and injuries occur. NOTE: EDR data is recorded by your vehicle only if a non-trivial crash situation occurs; no data is recorded by the EDR under normal driving conditions and no personal data (e.g. name, gender, age and accident location) is recorded. However, other parties, such as law enforcement, could combine EDR data with the type of personally identifying data routinely acquired during a crash investigation.

To read data recorded by an EDR, special equipment is required, and access to the vehicle or the EDR is needed. In addition to the vehicle manufacturer, other parties that have the special equipment, such as law enforcement, can read the information by accessing the vehicle or the EDR.

EDR data may be used in civil and criminal matters as a tool in accident reconstruction, accident claims and vehicle safety. Since the Crash Data Retrieval (CDR) tool that is used to extract data from the EDR is commercially available, Mercedes-Benz USA, LLC ("MBUSA") expressly

disclaims any and all liability arising from the extraction of this information by unauthorized Mercedes-Benz personnel.

MBUSA will not share EDR data with others without the consent of the vehicle owner or, if the vehicle is leased, without the consent of the lessee. Exceptions to this representation include responses to subpoenas by law enforcement; by federal, state or local government; in connection with or arising out of litigation involving MBUSA or its subsidiaries and affiliates; or, as required by law.

Warning: The EDR is a component of the Restraint System Module. Tampering with, altering, modifying or removing the EDR component may result in a malfunction of the Restraint System Module and other systems.

State laws or regulations regarding EDRs that conflict with federal regulation are pre-empted. This means that in the event of such conflict, the federal regulation governs. As of December 2016, 17 states have enacted laws relating to EDRs.

Copyright

Free and open source software

Information on license for free and open-source software used in your vehicle can be found on the data carrier in your vehicle document wallet and with updates on the following website:

<https://www.mercedes-benz.com/opensource>

Registered trademarks

- Bluetooth® is a registered trademark of Bluetooth SIG, Inc.
- DTS™ is a registered trademark of DTS, Inc.
- Dolby® and MLP™ are registered trademarks of DOLBY Laboratories.
- ESP® and PRE-SAFE® are registered trademarks of Daimler AG.
- HomeLink® is a registered trademark of Genex Corporation.
- iPod® and iTunes® are registered trademarks of Apple Inc.
- Burmester® is a registered trademark of Burmester Audiosysteme GmbH.
- Microsoft® and Windows Media® are registered trademarks of Microsoft Corporation.
- SIRIUS® is a registered trademark of Sirius XM Radio Inc.
- HD Radio™ is a registered trademark of iBiquity Digital Corporation.
- Gracenote® is a registered trademark of Gracenote, Inc.
- ZAGAT Survey® and related brands are registered trademarks of Zagat Survey, LLC.

Restraint system

Protection provided by the restraint system

The restraint system includes the following components:

- Seat belt system
- Airbags
- Child restraint system
- Child seat securing systems

The restraint system can help prevent the vehicle occupants from coming into contact with parts of the vehicle interior in the event of an accident. In the event of an accident, the restraint system can also reduce the forces to which the vehicle occupants are subjected.

A seat belt can only provide the best level of protection if it is worn correctly. Depending on the detected accident situation, Emergency Tensioning Devices and/or airbags supplement the protection offered by a correctly worn seat belt. Emergency Tensioning Devices and/or airbags are not deployed in every accident.

In order for the restraint system to provide the intended level of protection, each vehicle occupant must observe the following information:

- Fasten seat belts correctly.
- Sit in an almost upright seat position with their back against the seat backrest.
- Sit with their feet resting on the floor, if possible.
- Always secure persons under 5 ft (1.50 m) tall in an additional restraint system suitable for Mercedes-Benz vehicles.

However, no system available today can completely eliminate injuries and fatalities in every accident situation. In particular, the seat belt and airbag generally do not protect against objects penetrating the vehicle from the outside. It is also not possible to completely rule out the risk of injury caused by the airbag deploying.

Limitations of the protection provided by the restraint system

⚠ WARNING Risk of injury or death due to modifications to the restraint system

Vehicle occupants may no longer be protected as intended if alterations are made to the restraint system.

- ▶ Never alter the parts of the restraint system.
- ▶ Never tamper with the wiring or any electronic component parts or their software.

If it is necessary to modify the vehicle to accommodate a person with disabilities, contact an authorized Mercedes-Benz Center for details.



USA only: for details, contact our Customer Assistance Center on 1-800-FOR-MERCEDES (1-800-367-6372).

Restraint system functionality

When the vehicle is switched on, a self-test is performed, during which the  restraint system warning lamp lights up. It goes out no later than a few seconds after the vehicle is started. The components of the restraint system are then functional.

Malfunctioning restraint system

A malfunction has occurred in the restraint system if:

- The  restraint system warning lamp does not light up when the vehicle is switched on
- The  restraint system warning lamp lights up continuously or repeatedly during a journey

⚠ DANGER Risk of death due to the restraint system malfunctioning

Components in the restraint system may be activated unintentionally or not deploy as intended in an accident. In the event of an accident, the high-voltage on-board electrical system may not be deactivated as intended.

You may receive an electric shock if you touch the damaged components of the high-voltage on-board electrical system.

- ▶ Have the restraint system checked and repaired immediately at a qualified specialist workshop.
- ▶ After an accident, switch off the vehicle immediately.

Function of the restraint system in an accident

How the restraint system works depends on the severity of the impact detected and the apparent type of accident:

- Frontal impact
- Rear impact
- Side impact
- Rollover

The activation thresholds for the components of the restraint system are determined based on the evaluation of the sensor values measured at various points in the vehicle. This process is pre-emptive in nature. The triggering/deployment of the

components of the restraint system must take place in good time at the start of the collision.

Factors which can only be seen and measured after a collision has occurred cannot play a decisive role in airbag deployment. Nor do they provide an indication of airbag deployment.

The vehicle may be deformed significantly without an airbag being deployed. This is the case if only parts which are relatively easily deformed are affected and the rate of vehicle deceleration is not high. Conversely, an airbag may be deployed even though the vehicle suffers only minor deformation. If very rigid vehicle parts such as longitudinal members are hit, this may result in sufficiently high levels of vehicle deceleration.

Depending on the detected deployment situation, the components of the restraint system can be activated or deployed independently of each other:

- Emergency Tensioning Device: frontal impact, rear impact, side impact, rollover
- Driver's airbag, front passenger airbag: frontal impact
- Knee airbag: frontal impact

- Side airbag: side impact
- Window curtain airbag: side impact, rollover, frontal impact
- Belt airbag: frontal impact
- PRE-SAFE® Impulse Side: side impact

The front passenger airbag can only be deployed in an accident if the PASSENGER AIR BAG OFF indicator lamp is off. If the front passenger seat is occupied, make sure, both before and during the journey, that the status of the front passenger airbag is correct (→ page 54).

⚠ WARNING Risk of burns from hot air bag components

The air bag parts are hot after an air bag has been deployed.

- ▶ Do not touch the air bag parts.
- ▶ Have a deployed air bag replaced at a qualified specialist workshop as soon as possible.

Mercedes-Benz recommends that you have the vehicle towed to a qualified specialist workshop

after an accident. Take this into account, particularly if an Emergency Tensioning Device is triggered or an airbag deployed.

If the Emergency Tensioning Devices are triggered or an airbag is deployed, you will hear a bang, and a small amount of powder may also be released:

- The bang will not generally affect your hearing.
- In general, the powder released is not hazardous to health but may cause short-term breathing difficulties to persons suffering from asthma or other pulmonary conditions.

Provided it is safe to do so, leave the vehicle immediately or open the window in order to prevent breathing difficulties.

Airbags and pyrotechnic Emergency Tensioning Devices contain perchlorate material, which may require special handling or environmental protection measures. National guidelines regarding waste disposal must be observed. In California, see <https://dtsc.ca.gov/>. Using the search function, you will find information on perchlorate, for example.

Seat belts

Protection provided by the seat belt

Always fasten your seat belt correctly before starting a journey. A seat belt can only provide the best level of protection if it is worn correctly.

⚠ WARNING Risk of injury or death due to incorrectly fastened seat belt

If the seat belt is not worn correctly, it cannot perform its intended protective function.

In addition, an incorrectly fastened seat belt can also cause injuries, for example, in the event of an accident or when braking or changing direction suddenly.

- ▶ Always ensure that all vehicle occupants have their seat belts fastened correctly and are sitting properly.

Always observe the instructions about the correct driver's seat position and adjusting the seat (→ page 102).

In order for the correctly worn seat belt to provide the intended level of protection, each vehicle occupant must observe the following information:

- The seat belt must not be twisted and must fit tightly and snugly across the body.
- The seat belt must be routed across the center of the shoulder and as low down across the hips as possible.
- The shoulder section of the seat belt should not touch your neck nor be routed under your arm or behind your back.
- Avoid wearing bulky clothing, e.g. a winter coat.
- Push the lap belt down as far as possible across your hips and pull tight with the shoulder section of the belt. Never route the lap belt across your abdomen.
Pregnant women must also take particular care with this.
- Never route the seat belt across sharp, pointed, abrasive or fragile objects.
- Only one person should use each seat belt at any one time.

- Never secure objects with a seat belt if the seat belt is also being used by one of the vehicle's occupants.

Also ensure that no objects, e.g. a cushion, are ever placed between a person and the seat.

The seat belts on the following seats are equipped with a child seat safety feature:

- Front passenger seat
- Rear seats

Activate or deactivate the child seat safety feature of the seat belt (→ page 63).

If children are traveling in the vehicle, be sure to observe the instructions and safety notes on "Children in the vehicle" (→ page 59).

Always observe the instructions for loading the vehicle when securing objects, luggage or loads (→ page 119).

Limitations of the protection provided by the seat belt

⚠ WARNING Risk of injury or death due to an incorrect seat position

The seat belt does not offer the intended level of protection if you have not moved the seat backrest to an almost vertical position.

In particular, you could slip beneath the seat-belt and become injured.

- ▶ Adjust the seat properly before beginning your journey.
- ▶ Always ensure that the seat backrest is in an almost vertical position and that the shoulder belt is routed across the center of your shoulder.

⚠ WARNING Risk of injury or death when additional restraint systems are not used for persons with a smaller stature

Persons under 5 ft (1.50 m) tall cannot wear the seat belt correctly without a suitable additional restraint system.

- ▶ Always secure persons under 5 ft (1.50 m) tall in a suitable restraint system.

⚠ WARNING Danger of injury or death due to blocked seat belt anchorage

The restraint effect of the seat belt is impaired if objects between the front seat and the door are blocking the movable seat belt anchorage on the front seat.

- ▶ Before starting a journey, make sure that there are no objects between the front seat and the door.

⚠ WARNING Risk of injury or death due to damaged or modified seat belts

Seat belts cannot provide protection in the following situations:

- The seat belt is damaged, has been modified, is extremely dirty, bleached or dyed

- The seat belt buckle is damaged or extremely dirty
- Modifications have been made to the Emergency Tensioning Device, seat belt anchorage or seat belt retractor

Seat belts may sustain non-visible damage in an accident, e.g. due to glass splinters.

Modified or damaged seat belts could tear or fail in the event of an accident, for example.

Modified Emergency Tensioning Devices could accidentally trigger or fail to function as intended.

- ▶ Never modify the seat belt system, for example the seat belt, seat belt buckle, Emergency Tensioning Device, seat belt anchorage and seat belt retractor.
- ▶ Make sure that the seat belts are undamaged, not worn and clean.
- ▶ Always have the seat belts checked immediately after an accident at a qualified specialist workshop.

Only use seat belts which have been approved for your vehicle by Mercedes-Benz.

⚠ WARNING Risk of injury or death from deployed pyrotechnic Emergency Tensioning Devices

Pyrotechnic Emergency Tensioning Devices that have been deployed are no longer operational and are unable to perform their intended protective function.

- ▶ Therefore, have deployed pyrotechnic Emergency Tensioning Devices immediately replaced at a qualified specialist workshop.

Mercedes-Benz recommends that you have the vehicle towed to a qualified specialist workshop after an accident.

! NOTE Damage caused by trapping the seat belt

If an unused seat belt is not fully retracted, it may become trapped in the door or in the seat mechanism.

- ▶ Always ensure that an unused seat belt is fully retracted.

Information on the beltbag in the rear seat belt

The BELTBAG identification indicates that a rear seat belt is equipped with a beltbag.

When activated, the beltbag increases the protected area of the vehicle occupant's ribcage.

⚠ WARNING Risk of injury or death due to use of a non-approved child restraint system

In an accident, the beltbag may damage a non-approved child restraint system or a child restraint system which has not been approved for use in conjunction with the beltbag.

- ▶ Therefore, always use LATCH or ISOFIX to fasten a child seat equipped with an integrated restraint system.
- ▶ For vehicles equipped with the optional rear seat-belt airbags ("beltbag"), only

use a Mercedes-Benz approved booster seat with integrated backrest.

- ▶ Never use an airbag equipped seat belt to fasten a front- or rear-facing child seat or a non-approved booster seat.
- ▶ Please contact an authorized Mercedes-Benz Center for information on approved child restraint systems.

Fastening and adjusting seat belts

If the seat belt is pulled quickly or sharply, the seat belt retractor locks. The seat belt strap cannot be pulled out any further.

Vehicles with illuminated design seat belt buckles: the illuminated seat belt buckle makes fastening your seat belt easier in certain situations, for example, when ambient light conditions are poor.

- ⓘ The illumination on the seat belt buckle does not indicate that the seat belt buckle is functioning correctly.

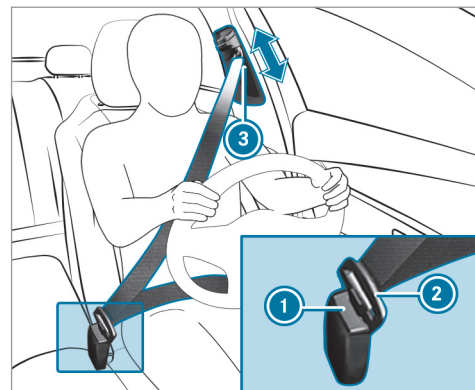

- ▶ Always engage seat belt tongue ② of the seat belt into seat belt buckle ① of the corresponding seat.
- ▶ **To adjust the seat belt height:** press and hold the belt guide release and slide seat belt outlet ③ into the desired position.
- ▶ **To engage the seat belt outlet:** let go of the belt guide release and ensure that seat belt outlet ③ locks into position.

- i** A seat belt can only provide the best level of protection if it is worn correctly. Observe the notes on fastening the seat belt (→ page 45).

! **NOTE** Deployment of components of the restraint system when the front passenger seat is unoccupied and a seat belt is buckled

When the front passenger seat is unoccupied and the seat belt tongue of the seat belt is engaged in the seat belt buckle, components of the restraint system may deploy unnecessarily on the front passenger side, e.g. the Emergency Tensioning Device.

- ▶ Only buckle the seat belts as intended.

- i** Observe the notes on stowage areas (→ page 119). Information on installing a child restraint system and on children traveling in the vehicle can be found in the "Children in the vehicle" section (→ page 62).

Seat belt adjustment function

Vehicles with PRE-SAFE®: After a front seat belt has been fastened, the automatic seat belt adjustment may apply a certain tightening force. Do not hold the seat belt tightly while it is adjusting.

You can activate and deactivate the seat belt adjustment function using the multimedia system (→ page 49).

Activating/deactivating seat belt adjustment via the multimedia system

Multimedia system:

-  ▶▶ Settings ▶▶ Vehicle
- ▶▶ Occupant Protection

- ▶ Activate or deactivate **Belt adjustment**.

Releasing seat belts

- ▶ Press the release button in the seat belt buckle and guide the seat belt back with the seat belt tongue.

Seat belt warning function for the driver and front passenger

The  seat belt warning lamp in the driver's display is a reminder that all vehicle occupants must wear their seat belts correctly.

The  seat belt warning lamp lights up for six seconds every time the vehicle is started.

In addition, a warning tone may sound.

When the driver's and front passenger's doors are closed and the driver and front passenger have fastened their seat belts, the seat belt warning goes out.

In the following cases, the seat belt warning lights up during a journey if:

- The vehicle speed exceeds 15 mph (25 km/h) and the driver's or front passenger seat belt is not fastened.
- The driver or front passenger unfastens their seat belt while the vehicle is in motion.

Airbags

Overview of airbags

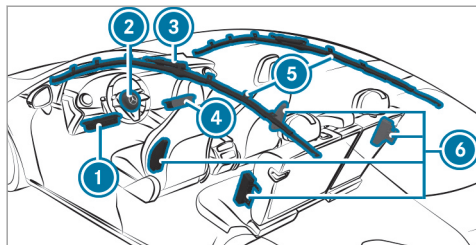

- ① Driver's knee airbag
- ② Driver's airbag
- ③ Front passenger airbag
- ④ Front passenger knee airbag
- ⑤ Window airbag
- ⑥ Side airbag

The installation location of an airbag is identified by the AIRBAG symbol. An additional arrow symbol ► indicates the installation location for certain airbags.

When enabled, an airbag can provide additional protection for the respective vehicle occupant.

Potential protection provided by each airbag:

- Knee airbag: thigh, knee and lower leg
- Driver's airbag, front passenger airbag: head and ribcage
- Side airbag: ribcage, also pelvis for front seat occupants
- Window airbag: head

Information on child restraint systems on the front passenger seat

⚠ WARNING Risk of injury or death if the co-driver airbag is enabled

If the co-driver airbag is enabled, a child on the co-driver seat may be struck by the co-driver airbag during an accident.

NEVER use a rearward-facing child restraint system on a seat with an ENABLED FRONT AIRBAG; DEATH or SERIOUS INJURY to the CHILD can occur.

When installing a child restraint system on the front passenger seat, observe the vehicle-specific information (→ page 69). Also, always observe the notes on rearward-facing or forward-facing child restraint systems on the front passenger seat (→ page 69).

Information on automatic front passenger airbag shutoff

The front passenger airbag can only be deployed in an accident if the PASSENGER AIR BAG OFF indicator lamp is off. If the front passenger seat is occupied, make sure, both before and during the journey, that the status of the front passenger airbag is correct (→ page 54).

! NOTE Deployment of components of the restraint system when the front passenger seat is unoccupied

In an accident, the components of the restraint system may deploy unnecessarily on the front passenger side if:

- There are heavy objects on the front passenger seat.

- The seat belt tongue is engaged in the seat belt buckle of the front passenger seat and the front passenger seat is unoccupied.
- ▶ Store objects in a suitable place.
- ▶ Only one person should use each seat belt at any one time.

Depending on the detected accident situation, the window airbag on the front passenger side may deploy. The airbag is deployed regardless of whether the front passenger seat is occupied.

Protection provided by the airbags

Depending on the accident situation, an airbag may supplement the protection offered by a correctly fastened seat belt.

▲ WARNING Risk of injury or death due to an incorrect seat position

If you deviate from the correct seat position, the airbag cannot perform its intended protective function.

Each vehicle occupant must make sure of the following:

- Fasten seat belts correctly. Pregnant women must take particular care to ensure that the lap belt never lies across the abdomen.
- Adopt the correct seat position and keep as far away as possible from the airbags.
- Observe the following information.
- ▶ Always make sure that there are no objects between the airbag and vehicle occupant.

To avoid the risks resulting from the deployment of an airbag, each vehicle occupant must observe the following information in particular:

- Before starting your journey, adjust your seat correctly; the driver's seat and front passenger seat should be moved as far back as possible.
When doing so, always observe the information on the correct driver's seat position (→ page 102).

- Only hold the steering wheel by the steering wheel rim. This allows the airbag to be fully deployed.
- Always lean against the seat backrest when the vehicle is in motion. Do not lean forwards or against the door or side window. You may otherwise be in the deployment area of the airbags.
- The occupants must always keep their feet on the floor. Do not put your feet on the cockpit, for example. Your feet may otherwise be in the deployment area of the airbag.
- If children are traveling in the vehicle, observe the additional notes (→ page 59).
- Always stow and secure objects correctly.

Objects in the vehicle interior may prevent an airbag from functioning correctly. Each vehicle occupant must always make sure of the following in particular:

- There are no people, animals or objects between the vehicle occupants and an airbag.
- There are no objects between the seat, door and door pillar (B-pillar).

- There are no hard objects, e.g. coat hangers, hanging on the grab handles or coat hooks.
- There are no accessories, such as mobile navigation devices, mobile phones or cup holders, within the deployment area of an airbag, e.g. on the cockpit, on the door, on the side window or on the side trim.

In addition, no connecting cables, tensioning straps or retaining straps must be routed or attached to the vehicle within the deployment area of an airbag. Always comply with the accessory manufacturer's installation instructions and, in particular, the notes on suitable places for installation.

- There are no heavy, sharp-edged or fragile objects in the pockets of your clothing. Store such objects in a suitable place.

Limitations of the protection provided by airbags

⚠ WARNING Risk of injury due to modifications to the cover of an airbag

If you modify the cover of an airbag or affix objects such as stickers to it, the airbag may no longer function correctly.

- ▶ Never modify the cover of an airbag and do not affix objects to it.

The installation location of an airbag is identified by the AIRBAG symbol (→ page 50).

Objects in the deployment area of an airbag may prevent the airbag from functioning correctly.

⚠ WARNING Risk of injury from objects in the deployment area of an airbag

Objects in the deployment area of an airbag can hinder or prevent the correct deployment of the airbag.

The airbag may then deploy in an uncontrolled manner and may even cause additional injuries to the vehicle occupants by deploying.

This may be the case in particular if the airbag is integrated into the seat.

- ▶ Always stow and secure objects correctly.
- ▶ Before commencing your journey, make sure that no objects are stowed in the deployment area of an airbag.

⚠ WARNING Risk of injury or death due to the use of unsuitable seat covers

Due to unsuitable seat covers, the airbags cannot protect vehicle occupants as intended.

In addition, the operation of the automatic front passenger airbag shutoff could be restricted.

- ▶ You should only use seat covers that have been approved for the corresponding seats by Mercedes-Benz.

⚠ WARNING Risk of injury due to malfunctioning sensors in the door

The function of the airbags can be impaired due to modifications or incorrect work performed on the doors or door trim, or if the doors are damaged.

- ▶ Never modify the doors or parts of the doors.
- ▶ Always have work on the doors or door trim carried out at a qualified specialist workshop.

⚠ WARNING Risk of injury due to deployed airbag

A deployed airbag no longer offers any protection.

- ▶ Have the vehicle towed to a qualified specialist workshop in order to have the deployed airbag replaced.

Have deployed airbags replaced immediately.

Status of the front passenger front airbag

Function of the automatic front passenger airbag shutoff

The automatic front passenger airbag shutoff is able to detect whether the front passenger seat is occupied by a person or a child restraint system. The front passenger airbag and front passenger knee airbag are enabled or disabled accordingly.

⚠ WARNING Risk of injury or death due to objects under the co-driver seat

Objects trapped under the co-driver seat can interfere with the function of the automatic co-driver airbag shutoff or damage the system.

- ▶ Do not store any objects under the co-driver seat.
- ▶ When the co-driver seat is occupied, make sure that no objects are trapped under the co-driver seat.

When installing a child restraint system on the front passenger seat, observe the vehicle-specific information (→ page 69). Also, always observe the notes on rearward-facing or forward-facing

child restraint systems on the front passenger seat (→ page 69).

A person on the front passenger seat must observe the following information:

- Fasten seat belts correctly (→ page 45).
- Sit in an almost upright seat position with their back against the seat backrest.
- Sit with their feet resting on the floor, if possible.

The front passenger airbag may otherwise be disabled by mistake, for example, in the following situations:

- The front passenger transfers their weight by supporting themselves on a vehicle armrest.
- The front passenger sits in such a way that their weight is raised from the seat surface.

⚠ WARNING Risk of injury or death due to a disabled front passenger airbag

The front passenger airbag is disabled when the PASSENGER AIR BAG OFF indicator lamp is lit.

A person in the front passenger seat could then, for example, come into contact with the vehicle interior, especially if the person is sitting too close to the cockpit.

If the front passenger seat is occupied, always ensure that:

- The classification of the person in the front passenger seat is correct and the front passenger airbag is enabled or disabled in accordance with the person in the front passenger seat.
 - The front passenger seat has been moved as far back as possible.
 - The person is seated correctly.
- Both before and during the journey, ensure that the status of the front passenger airbag is correct.

If the front passenger seat is occupied, the classification of the person or child restraint system on the front passenger seat takes place after the front passenger airbag shutoff self-test. The PASSENGER AIR BAG indicator lamps display the status of the front passenger airbag.

Always observe the notes on the function of the PASSENGER AIR BAG indicator lamps (→ page 54).

Function of the PASSENGER AIR BAG indicator lamps



Self-test of automatic front passenger airbag shutoff

When the vehicle is switched on, a self-test is performed during which the two PASSENGER AIR BAG ON and OFF indicator lamps light up simultaneously.

The status of the front passenger airbag is displayed via the PASSENGER AIR BAG indicator lamps after the self-test:

- **ON is lit:** the front passenger airbag may deploy during an accident.
The indicator lamp goes out after 60 seconds.
- **ON and OFF are not lit:** the front passenger airbag may deploy during an accident.
- **OFF is lit:** the front passenger airbag is disabled. It will then not be deployed in the event of an accident.

If the PASSENGER AIR BAG ON indicator lamp is off, only the PASSENGER AIR BAG OFF indicator lamp shows the status of the front passenger airbag. The PASSENGER AIR BAG OFF indicator lamp may be lit continuously or be off.

If the PASSENGER AIR BAG OFF indicator lamp and the  restraint system warning lamp light up simultaneously, the front passenger seat may not be used. Also in this case, do not install a child restraint system on the front passenger seat. Have the automatic front passenger airbag shutoff checked and repaired immediately at a qualified specialist workshop.

Status display

If the front passenger seat is occupied, ensure, both before and during the journey, that the status of the front passenger airbag is correct for the current situation.

After installing a rearward-facing child restraint system on the front passenger seat: PASSENGER AIR BAG OFF must be lit continuously.

⚠ WARNING Risk of injury or fatal injury when using a rearward-facing child restraint system while the co-driver airbag is enabled

If you secure a child in a rearward-facing child restraint system on the co-driver seat and the PASSENGER AIR BAG OFF indicator lamp is

off, the co-driver airbag can deploy in the event of an accident.

The child could be struck by the airbag.

- ▶ Always ensure that the co-driver airbag is disabled. The PASSENGER AIR BAG OFF indicator lamp must be lit.
- ▶ NEVER use a rearward-facing child restraint system on a seat with an ENABLED FRONT AIRBAG; DEATH or SERIOUS INJURY to the CHILD can occur.

When installing a child restraint system on the front passenger seat, observe the vehicle-specific information (→ page 69).

Depending on the child restraint system and the stature of the child, the PASSENGER AIR BAG OFF indicator lamp may be off. In this case, do not install the rearward-facing child restraint system on the front passenger seat.

Instead, install the rearward-facing child restraint system on a suitable rear seat.

After installing a forward-facing child restraint system on the front passenger seat: depending on the child restraint system and the stature of the

child, PASSENGER AIR BAG OFF may be lit continuously or be off. Always observe the following information.

⚠ WARNING Risk of injury or death due to incorrect positioning of the forward-facing child restraint system

If you secure a child in a forward-facing child restraint system on the front passenger seat that is positioned too close to the cockpit, in the event of an accident, the child could:

- come into contact with the vehicle interior if the PASSENGER AIR BAG OFF indicator lamp is lit, for example
 - be struck by the airbag if the PASSENGER AIR BAG OFF indicator lamp is off.
- ▶ Always move the front passenger seat as far back as possible and fully retract the seat cushion length adjustment. While doing so, always make sure that the shoulder belt strap is correctly routed from the seat belt outlet of the vehicle to the shoulder belt guide on the child restraint system. The shoulder belt strap

must be routed forwards and downwards from the seat belt outlet. If necessary, adjust the seat belt outlet and the front passenger seat accordingly.

- ▶ Always comply with the child restraint system manufacturer's installation instructions.

When installing a child restraint system on the front passenger seat, observe the vehicle-specific information (→ page 69).

If a person is sitting on the front passenger seat: PASSENGER AIR BAG OFF may be lit continuously or be off, depending on the person's stature.

A person on the front passenger seat must always observe the following information:

- If the front passenger seat is occupied by an adult or a person with a stature corresponding to that of an adult, the PASSENGER AIR BAG OFF indicator lamp must be off. This indicates that the front passenger airbag is enabled. If the PASSENGER AIR BAG OFF indicator lamp is lit continuously, an adult or person

with a build corresponding to that of an adult must not use the front passenger seat.

Instead, they should use a rear seat.

- If the front passenger seat is occupied by a person of smaller stature (e.g. a teenager or small adult), the PASSENGER AIR BAG OFF indicator lamp is either lit continuously or remains off, depending on the classification.
 - If the PASSENGER AIR BAG OFF indicator lamp is off: move the front passenger seat as far back as possible, or the person of smaller stature should use a rear seat.
 - If the PASSENGER AIR BAG OFF indicator lamp is lit continuously: the person of smaller stature should not use the front passenger seat.

⚠ WARNING Risk of injury or death when the PASSENGER AIR BAG OFF indicator lamp is lit

If the PASSENGER AIR BAG OFF indicator lamp remains lit after the self-test, the front passenger airbag is disabled.

If the front passenger seat is occupied, always ensure that:

- The classification of the person in the front passenger seat is correct and the front passenger airbag is enabled or disabled in accordance with the person in the front passenger seat.
- The person is seated properly with a correctly fastened seat belt.
- The front passenger seat has been moved as far back as possible.

Be sure to also observe the following further related subjects:

- Child restraint system on the front passenger seat (→ page 69)

PRE-SAFE® system

Function of PRE-SAFE® (anticipatory occupant protection)

PRE-SAFE® is able to detect certain critical driving situations and implement pre-emptive measures to protect the vehicle occupants.

PRE-SAFE® can implement the following measures independently of each other:

- Tightening the seat belts on the driver's seat and front passenger seat.
- Closing the side windows.
- **Vehicles with sliding sunroof:** closing the sliding sunroof.
- **Vehicles with memory function:** Moving the front passenger seat to a more favourable seat position.
- **Vehicles with multicontour seat:** increasing the air pressure in the seat side bolsters of the seat backrest.
- PRE-SAFE® Sound: provided that the multimedia system is switched on, generating a brief

noise signal to stimulate the innate protective mechanism of a person's hearing.

! **NOTE** Damage caused by objects in the footwell or behind the seat

The automatic adjustment of the seat position may result in damage to the seat and/or the object.

▶ Stow objects in a suitable place.

Reversing the PRE-SAFE® system measures

If an accident did not occur, the pre-emptive measures that were taken are reversed.

You will need to perform certain settings yourself.

- ▶ If the seat belt pre-tensioning is not reduced, move the seat backrest back slightly. The locking mechanism releases.

Function of PRE-SAFE® PLUS (anticipatory occupant protection plus)

PRE-SAFE® PLUS can detect certain impacts, particularly an imminent rear impact, and take pre-

emptive measures to protect the vehicle occupants. These measures cannot necessarily prevent an imminent impact.

PRE-SAFE® PLUS can implement the following measures independently of each other:

- Tightening the seat belts on the driver's seat and front passenger seat.
- Increasing brake pressure when the vehicle is stationary. This brake application is canceled automatically when the vehicle pulls away.

If an accident did not occur, the pre-emptive measures that were taken are reversed.

System limits

The system will not initiate any action in the following situations:

- When backing up

The system will not initiate any braking application in the following situations:

- Whilst driving
- or

- When entering or exiting a parking space while using Active Parking Assist

Function of PRE-SAFE® Impulse Side

If an imminent side impact is detected, PRE-SAFE® Impulse Side can pre-emptively move the front seat vehicle occupant's upper body towards the center of the vehicle. It does this by rapidly inflating an air cushion in the outer seat side bolster of the seat backrest on the side on which the impact is anticipated. This increases the distance between the door and the vehicle occupant.

If PRE-SAFE® Impulse Side has been deployed or is faulty, the **PRE-SAFE Impulse Side Inoperative** See Operator's Manual display message appears (→ page 421).

Automatic measures after an accident

Depending on the type and severity of the accident, and depending on the vehicle's equipment, the following measures can be implemented, for example:

- Automatic braking (post-collision brake)

- Activating the hazard warning lights
- Triggering an automatic emergency call (→ page 343)
- Switching off the drive system and high-voltage on-board electrical system
- Unlocking the vehicle doors
- Lowering the side windows
- Displaying the emergency guide on the central display
- Switching on the interior lighting

Function of the post-collision brake

Depending on the accident situation, the post-collision brake can minimize the severity of a further collision or even avoid it.

If an accident is detected, the post-collision brake can implement automatic braking. When the vehicle has come to a standstill, the electric parking brake is automatically applied.

The driver can cancel automatic braking by taking the following actions:

- Braking more strongly than automatic braking

- Fully depressing the accelerator pedal with force

Safely transporting children in the vehicle

Always observe when children are traveling in the vehicle

- ⓘ Also strictly observe the safety notes for the specific situation. In this way you can recognize potential risks and avoid dangers if children are traveling in the vehicle (→ page 59).

Be diligent

Bear in mind that negligence when securing a child in the child restraint system may have serious consequences. Always be diligent in securing a child carefully before every journey.

Never allow babies and children to travel sitting on the lap of another vehicle occupant.

To improve protection for children younger than 12 years old or under 5 ft (1.50 m) in height, Mercedes-Benz recommends you observe the following information:

- Always secure the child in a child restraint system suitable for this Mercedes-Benz vehicle.
- The child restraint system must be appropriate to the age, weight and size of the child.
- The vehicle seat must be suitable for installing a child restraint system.

Accident statistics show that children secured on the rear seats are generally safer than children secured on the front seats. For this reason, Mercedes-Benz strongly advises that you install a child restraint system on a rear seat.

The generic term child restraint system

The generic term child restraint system is used in this Operator's Manual. A child restraint system is, for example:

- A baby car seat
- A rearward-facing child seat
- A forward-facing child seat

- A child booster seat with a backrest and seat belt guide
Mercedes-Benz recommends using a child booster seat with a backrest.

The child restraint system must be appropriate to the age, weight and size of the child.

Observe laws and legal requirements

Always observe the legal requirements when using a child restraint system in the vehicle.

Observe standards for child restraint systems

All child restraint systems must meet the following standards:

- U.S. Federal Motor Vehicle Safety Standards 213 and 225
- Canadian Motor Vehicle Safety Standards 213 and 210.2

Confirmation that the child restraint system complies with the standards can be found on an instruction label on the child restraint system. This confirmation can also be found in the installation instructions that are included with the child restraint system.

Detecting risks, avoiding danger

Securing systems for child restraint systems in the vehicle

Only use the following securing systems for child restraint systems:

- The LATCH-type (ISOFIX) securing rings
- The vehicle's seat belt system
- The Top Tether anchorages

Installing a LATCH-type (ISOFIX) child restraint system is preferred.

Simply attaching to the securing rings on the vehicle can reduce the risk of installing the child restraint system incorrectly.

When securing a child with the integrated seat belt of the LATCH-type (ISOFIX) child restraint system, always comply with the permissible gross weight for the child and child restraint system (→ page 63).

A booster seat may be necessary to achieve proper seat belt positioning for children over 40 lbs (18 kg) in weight or until they reach a

height where a three-point seat belt can be fastened properly without a booster seat.

Mercedes-Benz recommends a suitable child booster seat with a backrest and seat belt guide.

Advantage of a rearward-facing child restraint system

It is preferable to transport a baby or a small child in a suitable rearward-facing child restraint system. In this case, the child sits in the opposite direction to the direction of travel and faces backwards.

Babies and small children have comparatively weak neck muscles in relation to the size and weight of their head. The risk of injury to the cervical spine during an accident can be reduced in a rearward-facing child restraint system.

Always secure a child restraint system correctly

⚠ WARNING Risk of injury or death due to incorrect installation of the child restraint system

The child can then not be protected or restrained as intended.

- ▶ Be sure to comply with the manufacturer's installation instructions for the child restraint system and its correct use.
- ▶ Make sure that the entire base of the child restraint system always rests on the sitting surface of the seat.
- ▶ Never place objects (e.g. cushions) under or behind the child restraint system.
- ▶ Use child restraint systems only with the original cover designed for them.
- ▶ Always replace damaged covers with genuine covers.

⚠ WARNING Risk of injury or death due to unsecured child restraint systems in the vehicle

If the child restraint system is incorrectly installed or not secured, it can come loose.

The child restraint system could be flung around and hit vehicle occupants.

- ▶ Always install child restraint systems correctly, even when not in use.
 - ▶ Always comply with the child restraint system manufacturer's installation instructions.
- Always observe the child restraint system manufacturer's installation and operating instructions as well as the vehicle-specific information:
 - Installing the LATCH-type (ISOFIX) child restraint system on the right and left rear seats (→ page 63).
 - Securing the child restraint system with the seat belt on the rear seat (→ page 67).
 - Securing the child restraint system with the seat belt on the front passenger seat (→ page 69). Observe the specific instructions for the rearward-facing and forward-facing child restraint systems (→ page 69).
- If the front passenger seat is occupied, ensure, both before and during the jour-

ney, that the status of the front passenger airbag is correct for the current situation (→ page 54).

- Observe the warning labels in the vehicle interior and on the child restraint system.
- Also secure Top Tether if present.

Do not modify the child restraint system

⚠ WARNING Risk of injury due to modifications to the child restraint system

The child restraint system can no longer function properly. This poses an increased risk of injury.

- ▶ Never modify a child restraint system.
- ▶ Only affix accessories which have been specially approved for this child restraint system by the child restraint system's manufacturer.

Only use child restraint systems which are in proper working condition

⚠ WARNING Risk of injury or death caused by the use of damaged child restraint systems

Child restraint systems or their retaining systems that have been subjected to stress in an accident may not be able to perform their intended protective function.

It may be the case that the child cannot be properly restrained.

- ▶ Always immediately replace child restraint systems that have been damaged or involved in an accident.
- ▶ Have the securing systems for the child restraint systems checked at a qualified specialist workshop before installing a child restraint system again.

Avoid direct sunlight

⚠ WARNING Risk of burns when the child seat is exposed to direct sunlight

If the child restraint system is exposed to direct sunlight or heat, parts could heat up excessively.

Children could suffer burns from these parts, particularly the metallic parts of the child restraint system.

- ▶ Always make sure that the child restraint system is not exposed to direct sunlight.
- ▶ Cover the child restraint system with a blanket, for example.
- ▶ If the child restraint system has been exposed to direct sunlight, allow it to cool before securing a child into it.
- ▶ Never leave children unattended in the vehicle.

Observe when stopping or parking

⚠ WARNING Risk of accident and injury due to children left unattended in the vehicle

If children are left unsupervised in the vehicle, they could, in particular:

- open doors, thereby endangering other persons or road users.
- get out and be struck by oncoming traffic.
- operate vehicle equipment and become trapped, for example.

In addition, the children could also set the vehicle in motion, for example by:

- releasing the parking brake.
- changing the transmission position.
- starting the vehicle.

- ▶ Never leave children unattended in the vehicle.
- ▶ When leaving the vehicle, always take the SmartKey with you and lock the vehicle.

- ▶ Keep the vehicle SmartKey out of reach of children.

⚠ WARNING Danger to life due to exposure to extreme heat or cold in the vehicle



If people, particularly children, are exposed to extreme temperatures over an extended period of time, there is a risk of serious injury or danger to life.

- ▶ Never leave persons, children in particular, unattended in the vehicle.

Overview of suitable seats in the vehicle for installing a child restraint system

Left/right rear seat

Preferred securing system:

-  LATCH-type (ISOFIX) child seat securing system
-  Also secure Top Tether if present (→ page 66).

Alternative securing system:

-  Vehicle seat belt

Also secure Top Tether if present (→ page 66).

Front passenger seat

Securing system:



-  Vehicle seat belt

Be sure to observe:

- If the front passenger seat is occupied, ensure, both before and during the journey, that the status of the front passenger airbag is correct for the current situation (→ page 54).
- Notes on automatic front passenger airbag shutoff (→ page 53).

Center rear seat

Securing system:

-  Vehicle seat belt
-  Also secure Top Tether if present (→ page 66).

Activating or deactivating the special seat belt retractor of the seat belt

⚠ WARNING Risk of injury or death if a seat belt is unfastened while the vehicle is in motion

If the seat belt is released while the vehicle is in motion, the special seat belt retractor is deactivated and the child restraint system is no longer correctly secured. The seat belt is drawn in slightly by the inertia reel and cannot be immediately closed again.

- ▶ Stop the vehicle immediately in accordance with the traffic conditions.
- ▶ Activate the special seat belt retractor again and correctly secure the child restraint system.

When enabled, the special seat belt retractor ensures that the seat belts of the front passenger seat and rear seats do not slacken once the child restraint system is secured.

The seat belts on the following seats are equipped with a special seat belt retractor:

- Front passenger seat
- Rear seats

Installing a child restraint system

- ▶ When installing a child restraint system, always observe the manufacturer's installation and operating instructions as well as the information in this Operator's Manual.
- ▶ Pull the seat belt smoothly from the seat belt outlet.
- ▶ Engage the seat belt tongue in the seat belt buckle.

Activating the special seat belt retractor

- ▶ Pull the seat belt out fully and let the inertia reel retract it again. When the special seat belt retractor is activated, you will hear a ratcheting sound.
- ▶ Push the child restraint system down until the seat belt sits tightly.

Deactivating the special seat belt retractor

- ▶ Press the release button of the seat belt buckle.
- ▶ Hold the seat belt tongue and guide back to the seat belt outlet.

Installing a LATCH-type (ISOFIX) child restraint system on the left and right rear seats

Installing a LATCH-type (ISOFIX) child restraint system on the left and right rear seats

⚠ WARNING Risk of accident if the rear bench seat, rear seat and seat backrest are not engaged

The rear bench seat, rear seat and seat backrest may fold forwards, even when you are driving.

- As a result, the vehicle occupant will be pushed into the seat belt with increased force. The seat belt will not be able to protect as intended and could cause additional injury.

- Objects or loads in the trunk or cargo compartment will not be restrained by the seat backrest.
- ▶ Make sure that the rear bench seat, the rear seat and the seat backrest are engaged before every trip.

If the rear seat backrest is not engaged and locked in place, the red lock verification indicator will be visible.

▲ WARNING Risk of injury or death if the permissible gross mass of the child and child restraint system together is exceeded.

Too much load may be placed on the LATCH-type (ISOFIX) child restraint system and the child may not be restrained correctly in the event of an accident, for example.

- ▶ If the child and the child restraint system together weigh more than the permissible gross mass of 73 lb (33 kg), only use a LATCH-type (ISOFIX) child restraint

system with which the child is secured with the vehicle seat belt.

- ▶ Also secure the child restraint system with the Top Tether belt, if available.

Always comply with the information about the mass of the child restraint system:

- In the manufacturer's installation and operating instructions for the child restraint system used
- On a label on the child restraint system, if present

Regularly check that the permissible gross mass of the child and child restraint system is still complied with.

When installing a child restraint system, observe the following:

- ☑ Always observe the correct use of the seats and consider their suitability for attaching a child restraint system.
- ☑ Always comply with the manufacturer's installation and operating instructions for the child restraint system used.

- ☑ Make sure that the child's feet do not touch the front seat. If necessary, move the front seat slightly forwards.

 When installing a LATCH-type (ISOFIX) child restraint system, also observe the following:

- ☑ **When using a baby car seat in weight group 0/0+ and a rearward-facing child restraint system in weight group I on a rear seat:**

adjust the front seat so that the seat does not touch the child restraint system.

- ☑ **When using a forward-facing child restraint system in weight group I:** remove the head restraint from the respective seat, if possible. In addition, the backrest of the child restraint system must lie as flat as possible against the backrest of the vehicle seat.

After the child restraint system has been removed, replace the head restraint immediately and adjust all head restraints correctly.

- ☑ If the head restraint of the child seat cannot be fully extended when it is installed in the vehicle, this will result in restrictions on the maximum size setting for child restraint systems in weight group II or III.

Contact with the roof when the head restraint is fully extended and locked in place will not result in any restrictions on use.

- ✓ The child restraint system must not be put under strain between the roof and the seat cushion and/or be installed facing the wrong direction. Where possible, adjust the seat cushion inclination accordingly.
- ✓ The child restraint system must not be put under strain by the head restraint. Adjust the head restraints as appropriate.
- ▶ Before every journey, make sure that the LATCH-type (ISOFIX) child restraint system is correctly engaged in both mounting brackets in the vehicle.

! **NOTE** Damage to the seat belt for the center seat during installation of the child restraint system

- ▶ Make sure that the seat belt is not trapped.

Vehicles with premium seats

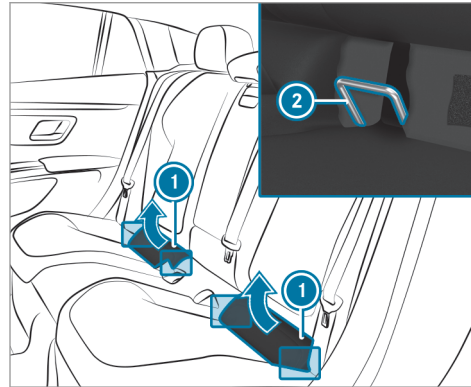

- ▶ Fold upholstered lining (1) upwards.
- ▶ Pull the tab on upholstered lining (1) upwards and position it on the support surface. Upholstered lining (1) will remain folded upwards.

- ▶ Attach the LATCH-type (ISOFIX) child restraint system to both mounting brackets (2) in the vehicle.
- ▶ To close, fold upholstered lining (1) upwards.
- ▶ Lift the tab from the support surface and slide it back into the upholstery slot between the seat backrest and seat cushion. Close the upholstery flap.

Vehicles with standard seats

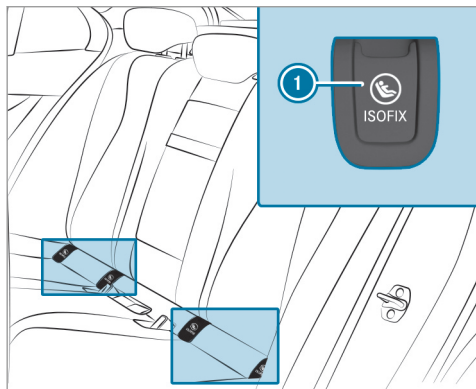

- ① LATCH-type (ISOFIX) mounting bracket
- ▶ Remove and stow away covers ①.
- ▶ Attach the LATCH-type (ISOFIX) child restraint system to both mounting brackets in the vehicle.
- ▶ After removing the child seat, reattach covers ①.

Fastening a Top Tether

⚠ WARNING Risk of injury or death if the rear seat backrests are not locked after Top Tether belts are installed

The rear seat backrests may fold forwards when you are driving.

As a result, child restraint systems will no longer be able to perform their intended protective function. This may also cause additional injuries.

- ▶ Always lock rear seat backrests after installing Top Tether belts.
- ▶ Observe the lock verification indicator.

If the rear seat backrest is not engaged and locked in place, the red lock verification indicator will be visible.

⚠ WARNING Risk of injury or death from adjusting the seat after installing a child restraint system

Vehicles with electrically adjustable rear bench seats:

The following may occur:

- The Top Tether belt may sit either too loose or too tight
- The child restraint system may be loose, incorrectly positioned or damaged and then not perform its intended protective function.
- ▶ Never adjust the seat after the child restraint system has been installed.



If the child restraint system is equipped with a Top Tether belt:

The risk of injury may be reduced by Top Tether. The Top Tether belt enables an additional connection between the child restraint system attached with LATCH-type (ISOFIX) (left and right rear seats) or the seat belt (all rear seats) and the vehicle.

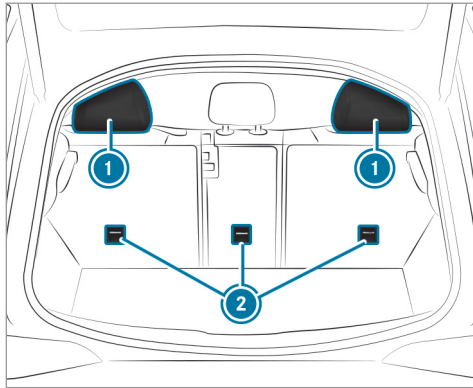

- ▶ If necessary, slide head restraint ① upwards (→ page 108).
- ▶ Install the LATCH-type (ISOFIX) or belt-secured child restraint system with Top Tether. In doing so, comply with the child restraint system manufacturer's installation instructions.

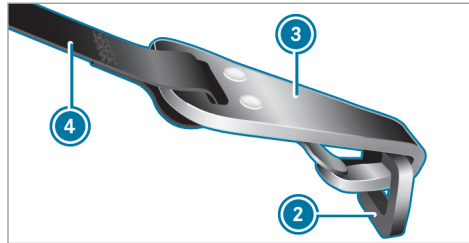

- ▶ Guide Top Tether belt ④ under head restraint ① between the two head restraint bars.

For child restraint systems with an I-strap Top Tether belt, the belt must be guided past the headrest on the left in the direction of travel.

- ▶ Hook Top Tether hook ③ into Top Tether anchorage ② without twisting.
- ▶ Tension Top Tether belt ④. In doing so, comply with the child restraint system manufacturer's installation instructions.
- ▶ If necessary, slide head restraint ① downwards (→ page 108). Make sure that you do

not interfere with the correct routing of Top Tether belt ④.

Securing the child restraint system with the seat belt

Securing the child restraint system with the seat belt on the rear seat

- ⚠ **WARNING** Risk of accident if the rear bench seat, rear seat and seat backrest are not engaged

The rear bench seat, rear seat and seat backrest may fold forwards, even when you are driving.

- As a result, the vehicle occupant will be pushed into the seat belt with increased force. The seat belt will not be able to protect as intended and could cause additional injury.
- Objects or loads in the trunk or cargo compartment will not be restrained by the seat backrest.

- ▶ Make sure that the rear bench seat, the rear seat and the seat backrest are engaged before every trip.

If the rear seat backrest is not engaged and locked in place, the red lock verification indicator will be visible.

When installing a belt-secured child restraint system, observe the following:

- ☑ Always comply with the manufacturer's installation and operating instructions for the child restraint system used.
- ☑ Also secure Top Tether if present (→ page 66).
- ☑ **When using a weight category 0/0+ baby car seat and a weight category I rearward-facing child restraint system on a rear seat:** adjust the front seat so that the seat does not touch the child restraint system.
- ☑ **When using a weight category I forward-facing child restraint system:** remove the head restraint from the respective seat, if possible.

After the child restraint system has been removed, replace the head restraint immediately and adjust all head restraints correctly.

- ☑ The backrest of the forward-facing child restraint system must, as far as possible, be resting on the seat backrest of the rear seat.
- ☑ If the head restraint of the child seat cannot be fully extended when it is installed in the vehicle, this will result in restrictions on the maximum size setting for child restraint systems in weight category II or III.
Contact with the roof when the head restraint is fully extended and locked in place will not result in any restrictions on use.
- ☑ The child restraint system must not be put under strain between the roof and the seat cushion and/or be installed facing the wrong direction. Where possible, adjust the seat cushion inclination accordingly.
- ☑ The child restraint system must not be put under strain by the head restraint. Adjust the head restraints as appropriate.

- ☑ Make sure that the child's feet do not touch the front seat. If necessary, move the front seat slightly forwards.

The seat belts on the following seats are equipped with a special seatbelt retractor:

- Front passenger seat
- Rear seats

When enabled, the special seatbelt retractor ensures that the seat belts of the front passenger seat and rear seats do not slacken once the child restraint system is secured (→ page 63).

- ▶ Install the child restraint system.
The entire base of the child restraint system must always rest on the seat surface of the rear seat.
- ▶ Always make sure that the shoulder belt strap is correctly routed from the seat belt outlet of the vehicle to the shoulder belt guide on the child restraint system.
The shoulder belt strap must be routed forward from the seat belt outlet.

Notes on rearward-facing and forward-facing child restraint systems on the front passenger seat

⚠ WARNING Risk of injury or fatal injury when using a rearward-facing child restraint system while the co-driver airbag is enabled

If you secure a child in a rearward-facing child restraint system on the co-driver seat and the PASSENGER AIR BAG OFF indicator lamp is off, the co-driver airbag can deploy in the event of an accident.

The child could be struck by the airbag.

- ▶ Always ensure that the co-driver airbag is disabled. The PASSENGER AIR BAG OFF indicator lamp must be lit.
- ▶ NEVER use a rearward-facing child restraint system on a seat with an ENABLED FRONT AIRBAG; DEATH or SERIOUS INJURY to the CHILD can occur.

Observe the specific instructions for the rearward-facing and forward-facing child restraint systems (→ page 69).

Always observe the status of the front passenger airbag on the PASSENGER AIR BAG OFF indicator lamp:

- When using a rearward-facing child restraint system on the front passenger seat, the front passenger airbag must always be disabled. This is only the case if the PASSENGER AIR BAG OFF indicator lamp is lit continuously (→ page 54).
- If the PASSENGER AIR BAG OFF indicator lamp is off, the front passenger airbag is enabled. The front passenger airbag may deploy during an accident.

Securing the child restraint system with the seat belt on the front passenger seat

When installing a belt-secured child restraint system on the front passenger seat, always observe the following:

- ☑ Observe the notes on rearward-facing and forward-facing child restraint systems on the front passenger seat (→ page 69).
- ☑ Observe the child restraint system manufacturer's installation and operating instructions.

- ☑ When using a forward-facing child restraint system in weight category I: remove the head restraint from the respective seat, if possible.

After the child restraint system has been removed, replace the head restraint immediately and adjust all head restraints correctly.

- ☑ The backrest of the forward-facing child restraint system must, as far as possible, be resting on the seat backrest of the front passenger seat.
- ☑ If the head restraint of the child seat cannot be fully extended when it is installed in the vehicle, this will result in restrictions on the maximum size setting for child restraint systems in weight category II or III.

Contact with the roof when the head restraint is fully extended and locked in place will not result in any restrictions on use.

- ☑ The child restraint system must not be put under strain between the roof and the seat cushion and/or be installed facing the wrong direction.

- ☑ The child restraint system must not be put under strain by the head restraint. Adjust the head restraints as appropriate.
- ☑ Never place objects (e.g. cushions) under or behind the child restraint system.

The seat belt on the front passenger side is equipped with a special seatbelt retractor.

When enabled, the special seatbelt retractor ensures that the seat belt does not slacken once the child seat is secured (→ page 63).

⚠ WARNING Risk of injury or death due to objects between the seat surface and the child restraint system

Objects between the seat surface and the child restraint system could affect the function of the automatic front passenger airbag shut-off.

- ▶ Do not place any objects between the seat surface and the child restraint system.
- ▶ Always make sure that the child restraint system is correctly installed.

- ▶ Set the front passenger seat as far back as possible and move the seat into the highest position if possible.
- ▶ Fully retract the seat cushion length adjustment.
- ▶ Adjust the seat cushion inclination so that the front edge of the seat cushion is in the highest position and the rear edge of the seat cushion is in the lowest position.
- ▶ Set the seat backrest to the most vertical position possible.
- ▶ Install the child restraint system. The entire base of the child restraint system must always rest on the sitting surface of the front passenger seat.
- ▶ Always make sure that the shoulder belt strap is correctly routed from the seat belt outlet of the vehicle to the shoulder belt guide on the child restraint system. The shoulder belt strap must be routed forwards and downwards from the seat belt outlet.
- ▶ If necessary, adjust the seat belt outlet and the front passenger seat accordingly.

Child-proof locks

Activating/deactivating the child safety lock for the rear doors

⚠ WARNING Risk of accident and injury due to children left unattended in the vehicle

If children are left unsupervised in the vehicle, they could, in particular:

- open doors, thereby endangering other persons or road users.
- get out and be struck by oncoming traffic.
- operate vehicle equipment and become trapped, for example.

In addition, the children could also set the vehicle in motion, for example by:

- releasing the parking brake.
- changing the transmission position.
- starting the vehicle.

- ▶ Never leave children unattended in the vehicle.

- ▶ When leaving the vehicle, always take the SmartKey with you and lock the vehicle.
- ▶ Keep the vehicle SmartKey out of reach of children.

⚠ WARNING Danger to life due to exposure to extreme heat or cold in the vehicle

If people, particularly children, are exposed to extreme temperatures over an extended period of time, there is a risk of serious injury or danger to life.

- ▶ Never leave persons, children in particular, unattended in the vehicle.

⚠ WARNING Risk of accident and injury due to children left unattended in the vehicle

If children are traveling in the vehicle, they could, in particular:

- Open doors, thereby endangering other persons or road users
- Get out and be struck by oncoming traffic

- Operate vehicle equipment and become trapped, for example
- ▶ Always activate the child safety locks installed if children are traveling in the vehicle.
- ▶ Never leave children unattended in the vehicle.
- ▶ When leaving the vehicle, always take the SmartKey with you and lock the vehicle.

There are child safety locks for the rear doors and the rear side windows. The child safety lock on the rear doors secures each door separately. The doors can no longer be opened from the inside.

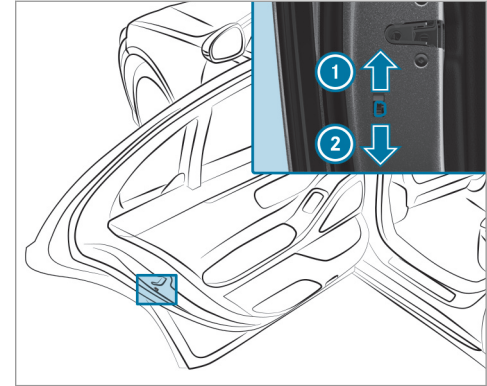

- ▶ Press the lever in direction ① (activate) or ② (deactivate).
- ▶ Make sure that the child safety locks are working properly.

Activating/deactivating the child safety lock for the rear side windows

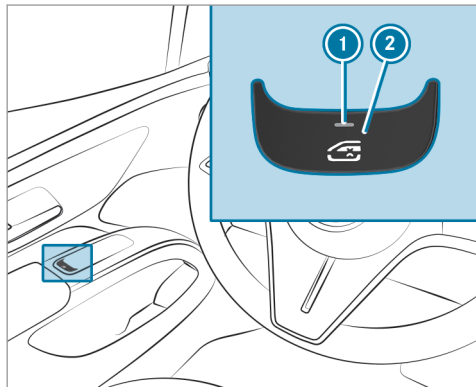

▶ **To activate/deactivate:** press button ②.

The rear side window can be opened or closed as follows:

- Indicator lamp ① is lit: via the switch on the driver's door

- Indicator lamp ① is off: via the switch on the corresponding rear door or driver's door

When the child safety lock is activated, the controls in the rear passenger compartment are disabled for:

- The rear side windows
- The adjustment of the front passenger seat from the rear passenger compartment
- The roller sunblinds in the roof

Notes on pets in the vehicle

⚠ WARNING Risk of accident and injury due to animals left unsecured or unattended in the vehicle

If you leave animals in the vehicle unattended or unsecured, they could possibly press buttons or switches.

An animal may:

- Activate vehicle equipment and become trapped, for example
- Switch systems on or off and endanger other road users

Unsecured animals may be thrown around in the vehicle in the event of an accident or sudden steering and braking maneuvers and injure vehicle occupants in the process.

- ▶ Never leave animals in the vehicle unattended.
- ▶ Always correctly secure animals while driving, e.g. using a suitable animal carrier.

SmartKey

Overview of SmartKey functions

⚠ WARNING Risk of accident and injury due to children left unattended in the vehicle

If children are left unsupervised in the vehicle, they could, in particular:

- open doors, thereby endangering other persons or road users.
- get out and be struck by oncoming traffic.
- operate vehicle equipment and become trapped, for example.

In addition, the children could also set the vehicle in motion, for example by:

- releasing the parking brake.
- changing the transmission position.
- starting the vehicle.

▶ Never leave children unattended in the vehicle.

- ▶ When leaving the vehicle, always take the SmartKey with you and lock the vehicle.
- ▶ Keep the vehicle SmartKey out of reach of children.

! NOTE Damage to the SmartKey caused by magnetic fields



- ▶ Keep the SmartKey away from strong magnetic fields.





Vehicle SmartKey with panic alarm

- ① Opens/closes the tailgate
- ② Unlocks (with embossed surface)

- ③ Locks
- ④ Indicator lamp
- ⑤ Panic alarm

ⓘ If indicator lamp ④ does not light up after pressing the  or  button, the battery is weak or possibly discharged. Replace the battery as soon as possible.

Replace the SmartKey battery (→ page 75).

ⓘ **Vehicles with convenience doors:** if you have activated the convenience doors function in the multimedia system (→ page 85), you can open or close the driver's or front passenger door by pressing the  or  button. Additional information on the convenience doors (→ page 80).

The SmartKey locks and unlocks the following components:

- Doors
- Socket flap
- Tailgate

If the vehicle is not opened within approximately 40 seconds after unlocking, it locks again. Anti-theft protection is activated again.

Do not keep the SmartKey together with electronic devices or metal objects. This can affect the SmartKey's functionality.

Activating/deactivating the acoustic locking verification signal

Multimedia system:

→  → Settings → Vehicle
 → Open/Close

▶ Activate or deactivate the **Acoustic Lock**.

Arming/disarming the panic alarm

Requirements:

- The vehicle is switched off.



▶ **To arm:** press button ① for approximately one second.

A visual and audible alarm is triggered.

▶ **To disarm:** briefly press button ① again.

or



▶ Press the start/stop button.

A SmartKey belonging to the vehicle must be detected in the vehicle.

Changing the unlocking settings

Possible unlocking functions of the SmartKey:

- Central unlocking
- Unlocking the driver's door and socket flap

▶ **To switch between settings:** press the  and  buttons simultaneously for approximately six seconds until the indicator lamp flashes twice.

Options if the unlocking function for the driver's door and socket flap has been selected:

- **To unlock the vehicle centrally:** press the  button twice.
- **Vehicles with KEYLESS-GO:** if you touch the inner surface of the door handle on the driver's door, only the driver's door and the socket flap are unlocked.

Deactivating the function of the SmartKey

Vehicles with KEYLESS-GO: if you deactivate the function of the SmartKey, the KEYLESS-GO functions are also deactivated. Access or drive authorization by KEYLESS-GO is then no longer possible with that particular SmartKey. Activate the function of the SmartKey so that all its functions will again be available.

You can also deactivate the function of the SmartKey to reduce the energy consumption of the

SmartKey if you do not use the vehicle or a SmartKey for an extended period of time.

- ▶ **To deactivate:** press the  button on the SmartKey twice in quick succession. The SmartKey indicator lamp flashes twice briefly and lights up once.
 - ▶ **To activate:** press any button on the SmartKey.
- i** When the vehicle is started with the SmartKey in the marked space of the center console, the function of the SmartKey is automatically activated (→ page 182).

Removing/inserting the emergency key

Removing the emergency key

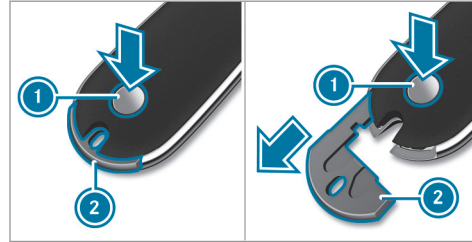

- ▶ Press release button **1**.
- ▶ Emergency key **2** is pushed out slightly.
- ▶ Fully remove emergency key **2**.

Inserting the emergency key

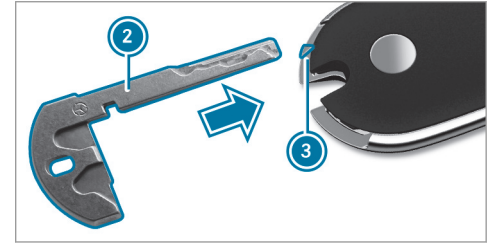

- ▶ Insert emergency key **2** at marking **3** until it engages.
- i** You can use emergency key **2** to attach the SmartKey to a key ring.

Replacing the SmartKey battery

⚠ DANGER Risk of fatal injuries due to swallowing batteries

Batteries contain toxic and corrosive substances. Swallowing batteries may cause severe internal burns to occur within two hours.

There is a risk of fatal injury.

- ▶ Keep batteries out of the reach of children.
- ▶ If the cover and/or cap of the battery compartment does not close securely, do not use the SmartKey any longer and keep out of the reach of children.
- ▶ If batteries are swallowed, seek medical attention immediately.

 **ENVIRONMENTAL NOTE** Environmental damage due to improper disposal of batteries



Batteries contain pollutants. It is illegal to dispose of them with the household rubbish.



Dispose of batteries in an environmentally responsible manner.

Take discharged batteries to a qualified specialist workshop or to a collection point for used batteries.

Requirements:

- You require a CR 2032 3 V cell battery.

Mercedes-Benz recommends that you have the battery replaced at a qualified specialist workshop.

- ▶ Remove the emergency key (→ page 75).

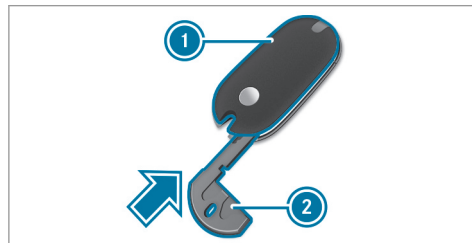

- ▶ Press emergency key ② into the opening in the SmartKey in the direction of the arrow

until cover ① opens. When doing so, do not hold cover ① closed.

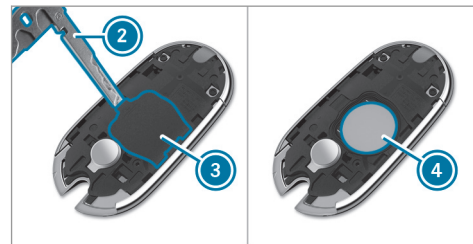

- ▶ Insert emergency key ② into the opening and lift up covering ③ and remove it.
- ▶ Repeatedly tap the SmartKey against your palm until battery ④ falls out of the SmartKey.
- ▶ Insert the new battery with the positive pole facing upwards. Use a lint-free cloth to do so.
- ▶ Make sure that the surface of the battery is free of lint, grease and other impurities.

- ▶ Insert the front tabs of covering ③ into the housing and then press on both sides to close it.
- ▶ Make sure that covering ③ is completely closed.
- ▶ Insert the front tabs of cover ① into the housing and then press until it is completely closed.
- ▶ Insert the emergency key again (→ page 75).

Problems with the SmartKey, troubleshooting

You can no longer lock or unlock the vehicle

Possible causes:

- The SmartKey battery is weak or discharged.
- ▶ Check the battery using the indicator lamp (→ page 73).
- ▶ Replace the SmartKey battery, if necessary (→ page 75).
- ▶ Use the replacement SmartKey.
- ▶ Use the emergency key to lock or unlock (→ page 86).

- ▶ Have the SmartKey checked at a qualified specialist workshop.

There is interference from a powerful radio signal source

Possible causes if the function of the SmartKey is impaired:

- High voltage power lines
- Mobile phones
- Electronic devices (notebooks, tablets)
- Shielding due to metal objects or induction loops for electrical gate systems or automatic barriers
- ▶ Make sure that there is sufficient distance between the SmartKey and the potential source of interference.

You have lost a SmartKey

- ▶ Have the SmartKey deactivated at a qualified specialist workshop.
- ▶ If necessary, have the mechanical lock replaced as well.

Doors

Unlocking/opening the doors from the inside

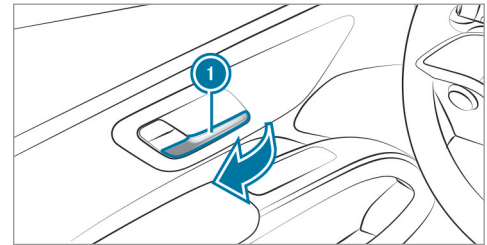

- ▶ **To unlock and open a front door:** pull door handle ①.
- ▶ **To unlock a rear door:** pull the rear door handle.
- ▶ **To open a rear door:** pull the rear door handle again.

Centrally locking and unlocking the vehicle from the inside

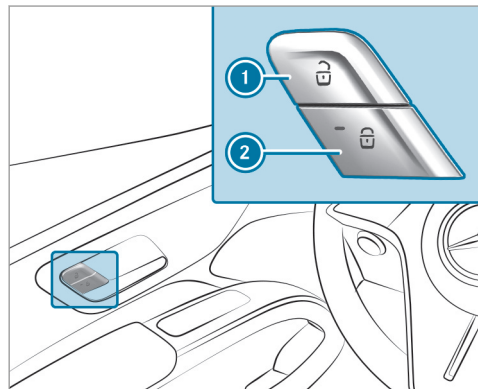

▶ **To unlock:** press button ①.

▶ **To lock:** press button ②.

The red indicator lamp on button ② lights up once the vehicle is locked.

ⓘ The buttons are also on the front passenger and rear doors.

The socket flap is also locked and unlocked. The socket flap can be opened even if a SmartKey is detected in the vehicle.

The vehicle is not unlocked:

- If you have locked the vehicle using the SmartKey
- If you have locked the vehicle using KEYLESS-GO

Locking/unlocking the vehicle with KEYLESS-GO

Requirements:

- The SmartKey is outside the vehicle.
- The distance between the SmartKey and the vehicle does not exceed 3 ft (1 m).
- The driver's door and the door on which the door handle is used are closed.

The door handles are extended when:

- The vehicle is unlocked
- The vehicle SmartKey is detected
- A door is opened

The door handles retract:

- When the vehicle is locked
- When pulling away
- After waiting for a time

! **NOTE** Vehicle damage due to unintentional opening of the tailgate or a door

- When using an automatic car wash
- When using a high pressure cleaner

▶ Deactivate the function of the SmartKey in these situations.

or

▶ Make sure that the SmartKey is at a minimum distance of 10 ft (3 m) (power washer) or 20 ft (6 m) (automatic car wash) away from the vehicle.

Observe the notes:

- On washing the vehicle in a car wash (→ page 356)
- On using a high pressure cleaner (→ page 357)

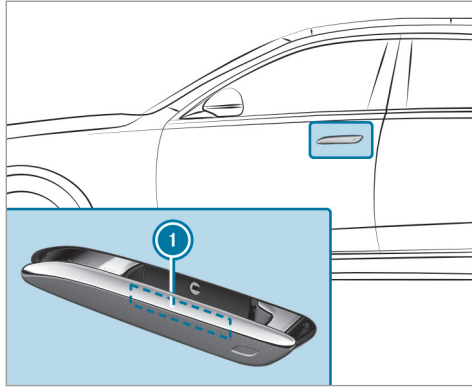

- ▶ **To unlock the vehicle:** touch the inner surface of door handle ①.

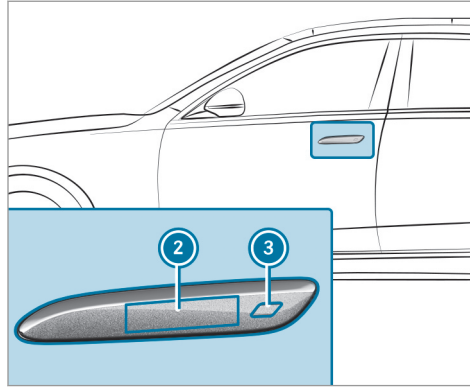

- ① If the door handle is not extended, touch sensor surface ② to unlock.
- ▶ **To lock the vehicle:** touch recessed sensor surface ③.
- ▶ **Convenience closing:** touch recessed sensor surface ③ for an extended period.
- ① Further information on convenience closing (→ page 94).

Problems with KEYLESS-GO, troubleshooting

You can no longer lock or unlock the vehicle using KEYLESS-GO

Possible causes:

- The function of the SmartKey has been deactivated.
- The SmartKey battery is weak or discharged.

- ▶ Activate the function of the SmartKey (→ page 74).
- ▶ Check the battery using the indicator lamp (→ page 73).
- ▶ Replace the SmartKey battery, if necessary (→ page 75).
- ▶ Use the replacement SmartKey.
- ▶ Use the emergency key to lock or unlock (→ page 86).
- ▶ Have the vehicle and SmartKey checked at a qualified specialist workshop.

There is interference from a powerful radio signal source

Possible causes if the function of KEYLESS-GO is impaired:

- High voltage power lines
- Mobile phones
- Electronic devices (notebooks, tablets)
- Shielding due to metal objects or induction loops for electrical gate systems or automatic barriers

▶ Make sure that there is sufficient distance between the SmartKey and the potential source of interference.

Activating or deactivating the automatic locking feature

Multimedia system:

→  ▶▶ Settings ▶▶ Vehicle

▶▶ Locking Function

 The vehicle is locked automatically when the vehicle is switched on and the wheels are turning faster than walking pace.

▶ Activate or deactivate **Automatic Door Lock**.



In the following situations, there is a danger of being locked out when the function is activated:

- The vehicle is being towed or pushed.
- If the vehicle is being tested on a roller dynamometer.

Opening and closing the convenience doors

 **WARNING** Risk of becoming trapped during automatic closing of the convenience doors

Parts of the body could become trapped. There may be people or animals in the closing area.

- ▶ Make sure that nobody is in the vicinity of the closing area.
- ▶ Use one of the following options to stop the closing process:
 - Driver's or front passenger door: press the  or  button on the SmartKey.

- Driver's door: depress the brake pedal.
- All doors: pull on the inner or outer door handles.
- All doors: push against or pull the door.
- All doors: touch the touch screen in the convenience menu in the multimedia system.

 **NOTE** When automatically opening and closing the convenience doors, please note

Your view of your surroundings may be restricted.

- ▶ Make sure that there are no persons, animals or objects in the area of the convenience doors when opening and closing.
- ▶ When opening, pay particular attention to low objects and obstacles in the side window area.

Opening or closing the convenience doors

The following functions are required to automatically open and close the convenience doors:

- KEYLESS-GO (→ page 78)
 - Power closing function (→ page 85)
 - Parking Package with surround view camera (→ page 262)
- or
- Remote Parking Assist with Mirror Package (→ page 275)
 - Active Blind Spot Assist (→ page 252)

The convenience doors can then be opened and closed automatically.

i If Active Blind Spot Assist is deactivated or unavailable, the convenience doors cannot be opened from inside.

The following options are available for opening or closing the convenience doors:



- The SmartKey (to open and close the driver's and front passenger door)
- Approaching the vehicle (to open the driver's door)

- Depressing the brake pedal (to close the driver's door)
 - The inner door handles (to open and close the doors)
 - The outer door handles (to open and close the doors)
 - The multimedia system (→ page 85)
- i** You cannot open a rear door with the door handle from inside the vehicle if it is secured by the child safety lock. Further information on the child safety lock for the rear doors (→ page 70).
You can still open the rear doors from the inside via the multimedia system (→ page 85).

Special features of the convenience doors:

- If, when closing, the door has reached the first detent position, the power closing function (→ page 85) will automatically draw the door into the lock.
- If the rear doors are closed using the convenience function, they are not automatically locked.

▶ To open the driver's or front passenger door with the SmartKey: press and hold the  button on the SmartKey until the door starts to open.

i In the multimedia system, you can set whether the driver's door, the front passenger door or no door opens when you press the  button on the SmartKey (→ page 85). If no door opens, the convenience opening function is carried out when the  button is pressed. The convenience opening function opens, for example, the side windows and the panoramic sliding sunroof. Further information on convenience opening (→ page 94).

▶ To close the driver's or front passenger door with the SmartKey: press and hold the  button on the SmartKey until the door starts to close.

All open doors close.

▶ Convenience closing with the SmartKey: press and hold the  button on the SmartKey. All open doors, side windows, and the panoramic sliding sunroof close.

- Press the  button on the SmartKey again to lock the vehicle.

To open the vehicle by approaching it:

NOTE Damage to the vehicle due to the unintentional opening of a door

- when walking past the vehicle
- when using an automatic car wash
- when using a high pressure cleaner

▶ Deactivate the function of the SmartKey in these situations.

or

▶ Make sure that the SmartKey is at a minimum distance of 20 ft (6 m) away from the vehicle.

When you approach your vehicle and the SmartKey is detected, the vehicle is unlocked and the driver's door opens automatically.

▶ Set the function in the multimedia system (→ page 85).

- A driver's door that is automatically opened by approaching the vehicle does not close again automatically.

To close the driver's door with the brake pedal:

▶ Depress the brake pedal until the door starts to close.

To open or close the convenience doors from inside:

▶ Briefly pull the door handle (→ page 77). Automatic operation is then started.

- If you pull the door handle during automatic operation, the opening or closing process is stopped. If you pull the door handle again, the process continues in reverse order.

▶ To open the convenience doors from outside: pull on the outside door handle.

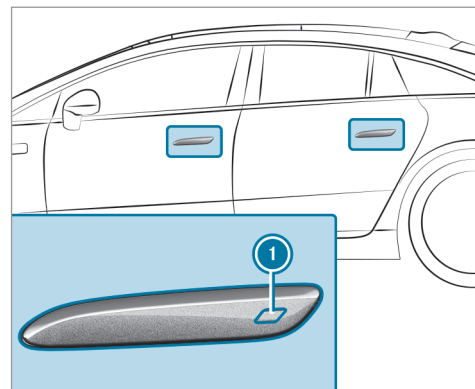

▶ To close the convenience doors from outside: touch recessed sensor surface ① on the door handle.

Object detection

Object detection uses several sensors to monitor the opening range of the convenience doors in order to detect objects. If one of the sensors detects an object, the convenience doors are

stopped and a warning is displayed in the multi-media system.

- ▶ Manually open a door stopped in an intermediate position.

Even if the convenience doors are equipped with sensors, it cannot be guaranteed that all objects are detected. Object detection is only an aid and is not a substitute for the attention of the vehicle occupants to their immediate surroundings when opening and closing the convenience doors. The vehicle occupants are always responsible for opening and closing the doors safely.

Detection range of the sensors

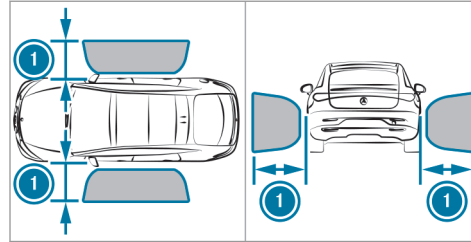

① 3 ft (Approximately 1 m)

! **NOTE** Risk of an accident from objects at close range

Object recognition may not detect certain objects at close range.

- ▶ When opening the convenience doors, pay particular attention to low objects and obstacles in the side window area. Object detection does not always detect such objects at close range, especially during movement. The vehicle or other objects could otherwise be damaged.

! **NOTE** Risk of accident due to faulty sensors

The sensors may malfunction because of snow or due to objects that absorb ultrasonic waves.

- ▶ Make sure that the convenience doors are free from dirt, ice or slush.
- ▶ Be especially careful when opening the convenience doors if other ultrasonic sources are nearby.

! **NOTE** Risk of accidents if the detection performance of the sensors in the convenience doors is restricted

If the sensors are covered, the convenience doors cannot function reliably.

- ▶ Do not apply stickers, foils or other coatings to the outside of the convenience doors. The sensors may otherwise be blocked and obstacles may not be detected or only detected to a limited extent.

Exit warning when opening the doors from inside

The exit warning of Active Blind Spot Assist is used as an additional safeguard. If an obstacle is detected, the convenience function is deactivated and the moving door will be stopped.

- ▶ Manually open a door stopped in an intermediate position.

⚠ WARNING Risk of accident despite exit warning

The exit warning neither reacts to stationary objects nor to persons or road users approaching you at a greatly differing speed.

The exit warning cannot warn drivers in these situations.

- ▶ Always pay particular attention to the traffic situation when opening the doors and make sure there is sufficient clearance.

The exit warning is only an aid and not a substitute for the attention of vehicle occupants. The responsibility for opening and closing the doors

and for leaving the vehicle remains with the vehicle occupants.

- ① Further information on Active Blind Spot Assist with exit warning (→ page 252).

Blockage detection when opening the doors

If an obstacle obstructs a door during the automatic opening process, blockage detection will stop the door. The automatic blockage detection function is only an aid and is not a substitute for your attentiveness.

- ▶ Manually open a door stopped in an intermediate position.

! NOTE Damage to the convenience doors despite blockage detection

Blockage detection may not be able to stop the automatic opening process of the doors in all cases. This can be the case in particular with light, soft objects.

- ▶ Therefore, make sure that there is sufficient clearance next to the vehicle.

Automatic reversing function when closing the doors

The doors are equipped with automatic blockage detection with a reversing function. If an obstacle stops a door during the automatic closing process, it will automatically open again. The automatic reversing function is only an aid and is not a substitute for your attentiveness.

- ▶ During the closing process, make sure that no body parts are in the closing area.



⚠ WARNING Risk of becoming trapped despite reversing function

The reversing function will not react:

- To soft, light and thin objects, e.g. fingers.
- Towards the end of the closing process.

In these situations in particular, the reversing function cannot prevent someone being trapped.

- ▶ Make sure that no body parts are in the closing area.
- ▶ If someone is trapped, use one of the following options:

- Driver's or front passenger door: press the  or  button on the SmartKey.
- Driver's door: depress the brake pedal.
- All doors: pull on the inner or outer door handles.
- All doors: push against or pull the door.
- All doors: touch the touch screen in the convenience menu in the multimedia system.

Setting convenience doors

Multimedia system:

-  » Settings » Vehicle » Comfort
- ▶ Activate or deactivate **Comfort Doors**.

Operating convenience doors

- ▶ Select .

- ▶ Select **Open door control**.
The window for operating the doors opens. The doors can be opened or closed by using the slider.
- ▶ Select **Cancel Process**.
The procedure is interrupted and the door remains in the position it has reached.
- ▶ Select **Close All**.
All doors are closed simultaneously.
- ⓘ The convenience doors can also be closed using MBUX Interior Assist. Further information on operating the convenience doors .

Setting the SmartKey function for the convenience doors

- ▶ Select .
- ▶ Select **SmartKey Assignment**.
Convenience Opening for Windows, open **Right Front Door** and open **Left Front Door** can be set separately for operation with the SmartKey.

Door opening on approach

- ▶ Activate or deactivate the function.
When the function is activated, the driver's door opens automatically when the vehicle is approached.

Warning of obstacles in the door area

- ▶ The vehicle warns you of obstacles in the door area with acoustic feedback and a graphic display.

Power closing function

⚠ WARNING Risk of becoming trapped when the doors close automatically

Body parts or objects can become trapped, causing injuries.

- ▶ Ensure that no body parts or objects are in the closing area.
- ▶ Automatic closing of the doors can be canceled by pulling the outer or inner door handle.

If you push the door into the lock to the first detent position, the power closing function will automatically pull the door into the lock.

- ❗ If the vehicle is locked from the outside, or while pulling away, an automatic closing of the doors can be triggered.

Locking/unlocking the vehicle with the emergency key

Unlocking a left-hand vehicle door with the emergency key

- ▶ Remove the emergency key (→ page 75).

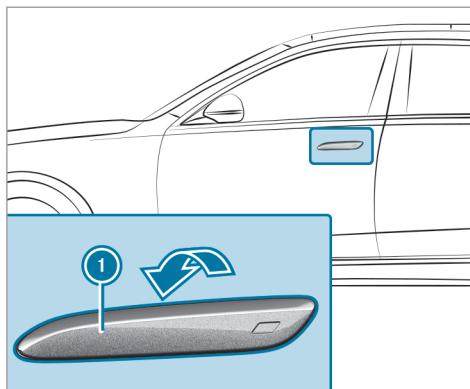

If the door handle is retracted:

- ▶ Insert a flat, non-metallic object behind door handle ❶ from above and pry it slightly outward.
- ▶ Reach behind door handle ❶ from below, pull it outward to the pressure point and hold it there.

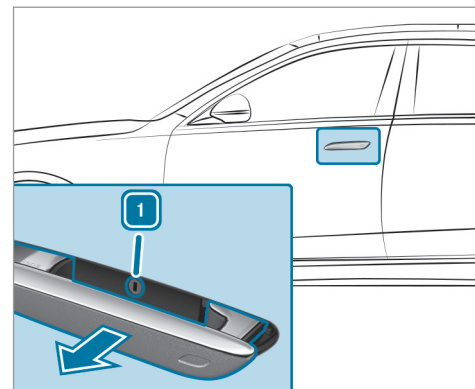

If the door handle is extended:

- ▶ Pull door handle ❶ outward to the pressure point and hold it there.
- ▶ Insert the emergency key into the lock cylinder.
- ▶ Turn the emergency key counter-clockwise to position ❶.

- ▶ Forcefully pull door handle ① outward past the pressure point.
- ▶ Remove the emergency key and release the door handle.

Locking the doors

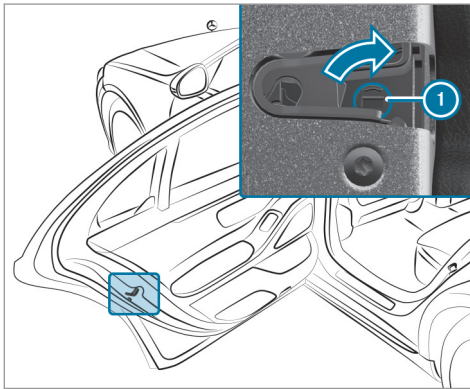

- ▶ Insert a suitable object, e.g. the emergency key, into opening ① on the door lock.

- ▶ **To lock the left-hand side of the vehicle:** turn the emergency key clockwise as far as it will go.
- ▶ **To lock the right-hand side of the vehicle:** turn the emergency key counter-clockwise as far as it will go.

If the locked door is then closed, it can no longer be opened from the outside.

Cargo compartment

Opening the tailgate

! **NOTE** Damage to the tailgate caused by obstacles above the vehicle

The tailgate swings rearwards and upwards when it is opened.

- ▶ Make sure that there is sufficient space behind and above the tailgate.

- ▶ If the tailgate is unlocked, press the top of the Mercedes star.

- ▶ **Vehicles with HANDS-FREE ACCESS:** Make a kicking movement with your foot below the bumper (→ page 90).

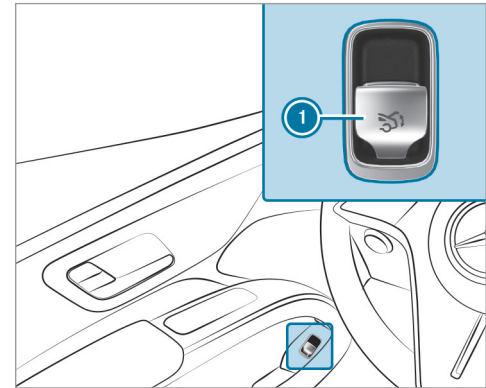

- ▶ Pull remote operating switch ① until the tailgate opens.

or

- ▶ Press and hold the  button on the Smart-Key.

- ▶ If the tailgate is stopped in an intermediate position, pull it upwards. Release it as soon as it begins to open.

If an obstacle obstructs the tailgate during the automatic opening process, blockage detection will stop the tailgate. The automatic blockage detection function is only an aid. It is not a substitute for your attentiveness.

Closing the tailgate

⚠ WARNING Risk of injury from unsecured items in the vehicle

If objects, luggage or loads are not secured or not secured sufficiently, they could slip, tip over or be thrown around and thereby hit vehicle occupants.

There is a risk of injury, particularly in the event of sudden braking or a sudden change in direction.

- ▶ Always stow objects in such a way that they cannot be thrown around.

- ▶ Before the journey, secure objects, luggage or loads against slipping or tipping over.

Observe the notes on loading the vehicle.

Notes on closing the tailgate: your vehicle is equipped with automatic key recognition. If a SmartKey belonging to the vehicle is detected in the vehicle, the tailgate will not be locked.

Note that the tailgate will not be locked in the following situation:

- You have locked the vehicle and close the tailgate while a SmartKey belonging to the vehicle is inside the vehicle.
and
- A second SmartKey belonging to the vehicle is not detected outside the vehicle.

Automatic SmartKey recognition is only an aid and is not a substitute for your attentiveness.

- ▶ Before locking, ensure that at least one SmartKey belonging to the vehicle is outside the vehicle.

- ▶ **To close the tailgate:** pull the tailgate downwards slightly. Release it as soon as it begins to close.

⚠ WARNING Risk of becoming trapped during automatic closing of the tailgate

Parts of the body could become trapped. There may be people in the closing area.

- ▶ Make sure that nobody is in the vicinity of the closing area.

Use one of the following options to stop the closing process:

- Press the  button on the SmartKey.
- Press or pull the remote operating switch on the driver's door.
- Press the closing or locking button on the tailgate.
- Press the top of the Mercedes star on the tailgate.

Vehicles with HANDS-FREE ACCESS: it is also possible to stop the closing process by making a kicking movement below the rear bumper.

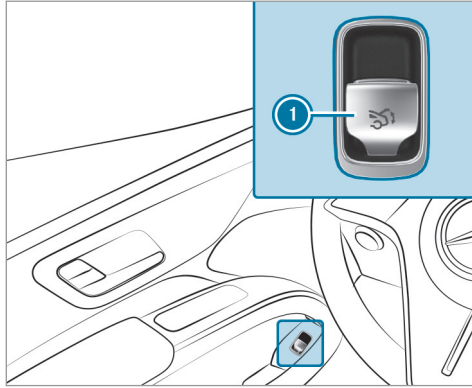

- ▶ Switch on the power supply or the vehicle.
- ▶ Push remote operating switch ① until the tailgate is fully closed.

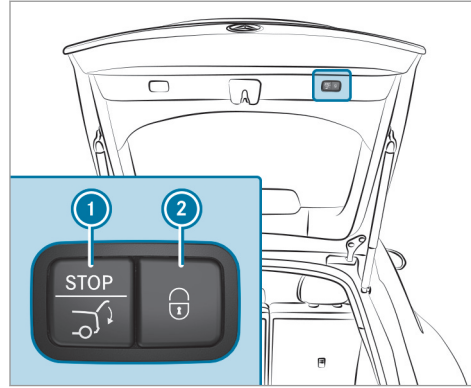

- ▶ Press closing button ① on the tailgate.

Vehicles with KEYLESS-GO

- ▶ Press locking button ② on the tailgate. If a SmartKey is detected outside the vehicle, the tailgate will close and the vehicle will be locked.

- ▶ Press and hold the  button on the SmartKey. The SmartKey must be in the vicinity of the vehicle.

Vehicles with HANDS-FREE ACCESS

- ▶ Make a kicking movement with your foot below the bumper (→ page 90).

Automatic reversing function for the tailgate

The tailgate is equipped with automatic blockage detection with a reversing function. If an obstacle obstructs the tailgate during the automatic closing process, it will automatically open again slightly. Automatic blockage detection with the reversing function is only an aid and is not a substitute for your attentiveness.

- ▶ During the closing process, make sure that no body parts are in the closing area.

⚠ WARNING Risk of becoming trapped despite reversing function

The reversing function will not react:

- To soft, light and thin objects, e.g. fingers.
- Towards the end of the closing procedure.

In these situations in particular, the reversing function cannot prevent someone being trapped.

► Make sure that no body parts are in the closing area.

If someone is trapped, either:

- Press the  button on the SmartKey.
- Press or pull the remote operating switch on the driver's door.
- Press the closing or locking button on the tailgate.
- Press the top of the Mercedes star on the tailgate.

HANDS-FREE ACCESS function

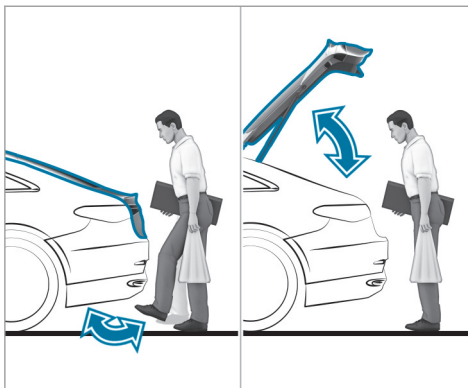

With HANDS-FREE ACCESS you can open, close or stop the closing process of the tailgate by performing a kicking movement under the rear bumper.

The kicking movement triggers the opening or closing process alternately.

Observe the notes when opening (→ page 87) and closing (→ page 88) the tailgate.

 Two warning tones sound when the tailgate is opening or closing.

 **NOTE** Vehicle damage due to unintentional opening of the tailgate or a door

- When using an automatic car wash
- When using a high pressure cleaner

► Deactivate the function of the SmartKey in these situations.

or

► Make sure that the SmartKey is at a minimum distance of 10 ft (3 m) (power washer) or 20 ft (6 m) (automatic car wash) away from the vehicle.

When making the kicking movement, make sure that you are standing firmly on the ground. You could otherwise lose your balance, e.g. on ice.

Observe the following notes:

- The SmartKey is behind the vehicle.
- Stand at least 12 in (30 cm) away from the vehicle while performing the kicking movement.

- Do not come into contact with the bumper while making the kicking movement.
- Do not carry out the kicking movement too slowly.
- The kicking movement must be towards the vehicle and back again.

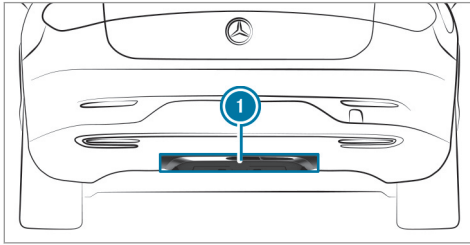

① Detection range of the sensors

If several consecutive kicking movements are not successful, wait ten seconds.

System limits

The system may be impaired or may not function in the following cases:

- The sensors are dirty, e.g. due to road salt or snow.
- The kicking movement is made using a prosthetic leg.

The tailgate can open or close unintentionally in the following situations:

- A person's arms or legs are moving in the sensor detection range, e.g. when polishing the vehicle or picking up objects.
- Objects are moved or placed behind the vehicle, e.g. a charging cable or luggage.
- Clamping straps, tarps or other coverings are pulled over the bumper.
- A protective mat with a length reaching over the trunk sill down into the detection range of the sensors is used.
- The protective mat is not secured correctly.

Deactivate the function of the SmartKey (→ page 74) or do not carry the SmartKey about your person in such situations.

Limiting the opening angle of the tailgate

Activating the opening angle limiter

You can limit the opening angle of the tailgate in the top half of its opening range up to a point shortly before the end position.

- ▶ Stop the opening procedure of the tailgate at the desired position.
- ▶ Press and hold the closing button on the tailgate until you hear a short acoustic signal. The opening angle limiter will be activated. The tailgate will then stop in the stored position when opened.

To open the tailgate fully, pull the top part of the Mercedes star on the tailgate again after it has stopped automatically.

Deactivating the opening angle limiter

- ▶ Press and hold the closing button on the tailgate until two short acoustic signals sound.

Unlocking the tailgate with the emergency key

Requirements:

- The rear seat backrest has been folded forward.
- The cargo compartment cover has been removed.

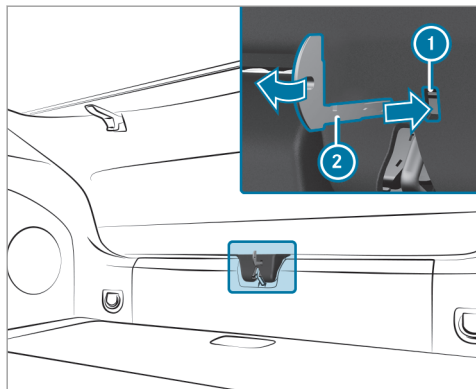

▶ Remove the emergency key (→ page 75).

- ▶ Insert emergency key ② into opening ① in the trim and push it in the direction of the arrow.
The tailgate will be unlocked.

Side windows

Opening and closing the side windows

⚠ WARNING Risk of entrapment when opening a side window

When opening a side window, parts of the body could be drawn in or become trapped between the side window and window frame.

- ▶ When opening, make sure that nobody is touching the side window.
- ▶ If someone is trapped, release the button immediately or pull it in order to close the side window again.

⚠ WARNING Risk of becoming trapped when closing a side window

When closing a side window, body parts could be trapped in the closing area in the process.

- ▶ When closing, make sure that no body parts are in the closing area.
- ▶ If someone is trapped, release the button immediately or press the button in order to reopen the side window.

⚠ WARNING Risk of becoming trapped when children operate the side windows

Children could become trapped if they operate the side windows, particularly when unattended.

- ▶ Activate the child safety lock for the rear passenger compartment side windows.
- ▶ When leaving the vehicle, always take the SmartKey with you and lock the vehicle.
- ▶ Never leave children unattended in the vehicle.

Requirements:

- The power supply or the vehicle has been switched on.

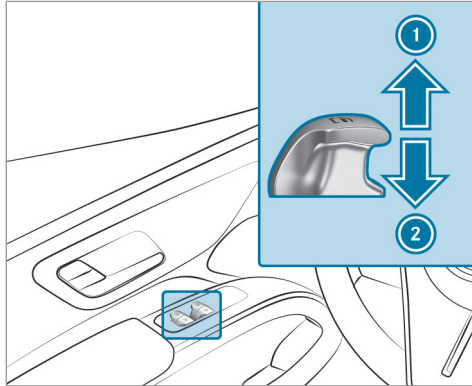

① Closes

② Opens

The buttons on the driver's door take precedence.

▶ **To start automatic operation:** press the  button beyond the point of resistance or pull and release it.

▶ **To interrupt automatic operation:** press or pull the  button again.

When the vehicle is switched off, you can continue to operate the side windows.

This function is available for around four minutes or until a front door is opened.

Automatic reversing function of the side windows

If an obstacle impedes a side window during the closing process, the side window will open again automatically. The automatic reversing function is only an aid and is not a substitute for your attentiveness.

▶ During the closing process, make sure that no body parts are in the closing area.

⚠ WARNING Risk of becoming trapped despite there being reversing protection on the side window

The reversing function does not react:

- To soft, light and thin objects, e.g. fingers.
- During resetting.

The reversing function cannot prevent someone from becoming trapped in these situations.

- ▶ During the closing process, make sure that no body parts are in the closing area.
- ▶ If someone becomes trapped, press the  button to open the side window again.

Convenience opening (ventilating the vehicle before starting a journey)

⚠ WARNING Risk of entrapment when opening a side window

When opening a side window, parts of the body could be drawn in or become trapped between the side window and window frame.

- ▶ When opening, make sure that nobody is touching the side window.
- ▶ Release the button immediately if somebody becomes trapped.

Requirements:

- The SmartKey is in the immediate vicinity of the vehicle.
 - ▶ Press and hold the  button on the SmartKey.
- The following functions are performed:
- The vehicle is unlocked.
 - The side windows are opened.
 - The panoramic sliding roof is opened.

- The seat ventilation of the driver's seat is switched on.

i If the roller sunblind of the panoramic sliding sunroof is closed, the roller sunblind is opened first.

▶ **To interrupt convenience opening:** release the  button.

▶ **To continue convenience opening:** press and hold the  button again.

Convenience closing (closing the vehicle from outside)

⚠ WARNING Risk of entrapment due to not paying attention during convenience closing

When the convenience closing feature is operating, parts of the body could become trapped in the closing area of the side window and the sliding sunroof.

- ▶ When the convenience closing feature is operating, monitor the entire closing

process and make sure that no body parts are in the closing area.

Requirements:

- The SmartKey is in the immediate vicinity of the vehicle.

▶ Press and hold the  button on the SmartKey.

The following functions are performed:

- The vehicle is locked.
- The side windows are closed.
- The panoramic sliding roof is closed.

▶ **To interrupt convenience closing:** release the  button.

▶ **To continue convenience closing:** press and hold the  button again.

i Convenience closing also functions with KEY-LESS-GO (→ page 78).

Resolving problems with the side windows

⚠ WARNING Risk of becoming trapped or fatally injured if reversing protection is not activated

If you close a side window again immediately after it has been blocked, the side window will close with increased or maximum force. The reversing function is then not active and body parts may become trapped.

- ▶ Make sure that no parts of the body are in the closing area.
- ▶ To stop the closing process, release the button or press the button again to reopen the side window.

A side window cannot be closed and you cannot see the cause.

- ▶ Check to see whether any objects are in the window guide.
- ▶ Adjust the side windows.

Adjusting the side windows

If a side window is obstructed during closing and reopens again immediately:

- ▶ Immediately after this, pull and hold the corresponding button again until the side window has closed and hold the button for at least one more second (re-adjustment).
The side window will be closed without the automatic reversing function.

If the side window is obstructed again and reopens again immediately:

- ▶ Immediately after this, pull and hold the corresponding button again until the side window has closed and hold the button for at least one more second (follow-up adjustment).
The side window will be closed without the automatic reversing function.

The side windows cannot be opened or closed using the convenience opening feature.

Possible causes:

- The SmartKey battery is weak or discharged.
- ▶ Check the battery using the indicator lamp (→ page 73).

- ▶ Replace the SmartKey battery, if necessary (→ page 75).

Sliding sunroof

Opening and closing the sliding sunroof

- ① The term "sliding sunroof" refers to the panorama roof with power tilt/sliding panel.

⚠ WARNING Risk of becoming trapped when the sliding sunroof is being opened and closed

Body parts may become trapped in the range of movement.

- ▶ During the opening and closing process, make sure that no body parts are in the sweep of the sliding sunroof.
- ▶ If someone is trapped, release the control panel immediately.

or

- ▶ Touch the control panel during automatic operation.
The opening/closing process will be stopped.

⚠ WARNING Risk of becoming trapped if the sliding sunroof is operated by children

Children operating the sliding sunroof could get caught in the moving parts, particularly if unattended.

- ▶ Never leave children unattended in the vehicle.
- ▶ When leaving the vehicle, always take the key with you and lock the vehicle.

⚠ WARNING Risk of becoming trapped when the roller sunblind is being opened and closed

Body parts may become trapped between the roller sunblind and frame or sliding roof.

- ▶ During the opening or closing process, make sure that no body parts are in the roller sunblind's range of movement.
- ▶ If someone is trapped, release the control panel immediately.

or

- ▶ Touch the control panel during automatic operation.
The opening/closing process will be stopped.

! NOTE Malfunction due to snow and ice

Snow and ice may cause the sliding sunroof to malfunction.

- ▶ Open the sliding sunroof only if it is free of snow and ice.

! NOTE Damage caused by protruding objects

Objects that protrude from the sliding sunroof may damage the seals.

- ▶ Do not allow anything to protrude from the sliding sunroof.

! NOTE Damage to panorama roof with power tilt/sliding panel caused by roof luggage rack

If the panorama roof with power tilt/sliding panel is opened when a roof luggage rack is installed, the panorama roof with power tilt/sliding panel may be damaged by the roof luggage rack.

- ▶ Do not open the panorama roof with power tilt/sliding panel if a roof luggage rack is installed.

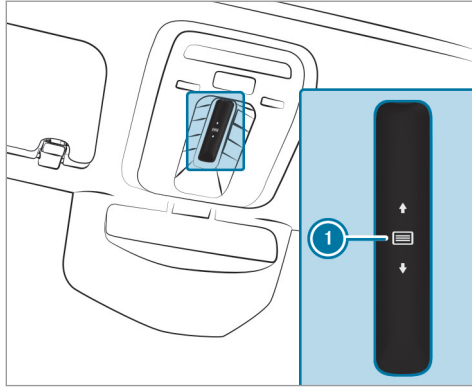

The sliding sunroof and the roller sunblind are operated using control panel ①.

The panorama roof with power tilt/sliding panel can be operated only when the roller sunblind is open.

- ▶ **To open:** swipe backwards across control panel ① and hold.

- ▶ **To close:** swipe forwards across control panel ① and hold.
- ▶ **To raise or lower:** press control panel ① briefly.
- ▶ **To start automatic operation:** swipe forwards or backwards across control panel ①.
- ▶ **To cancel automatic operation:** press control panel ① again.
The opening/closing process will be stopped.

Automatic reversing function of the sliding sunroof

If an obstacle obstructs the sliding sunroof during the closing process, the sliding sunroof will open again automatically. The automatic reversing function is only an aid and is not a substitute for your attentiveness.

- ▶ During the closing process, make sure that no body parts are in the closing area.

⚠ WARNING Risk of becoming trapped despite reversing function

The reversing function will not react:

- To soft, light and thin objects, e.g. fingers.
 - Towards the end of the closing procedure.
 - During resetting.
- ▶ During the closing process, make sure that no body parts are in the closing area.
 - ▶ If someone is trapped, release the control panel immediately.
- or
- ▶ Touch the control panel during automatic closing.
The closing process will be stopped.

Automatic reversing function of the roller sunblind

If an obstacle obstructs the roller sunblind during the closing process, the roller sunblind will open again automatically. The automatic reversing function is only an aid and is not a substitute for your attentiveness.

- ▶ When closing the roller sunblind, make sure that no body parts are in the range of movement.

⚠ WARNING Risk of becoming trapped despite reversing function

In particular, the reversing function does not react to soft, light and thin objects, e.g. fingers.

- ▶ When closing the roller sunblind, make sure that no body parts are in the range of movement.
- ▶ If someone is trapped, release the control panel immediately.

or

- ▶ Touch the control panel during automatic closing.
The closing process will be stopped.

Automatic functions of the sliding sunroof

- ① The term "sliding sunroof" refers to the panorama roof with power tilt/sliding panel.

Rain closing function when driving

Vehicles with a panorama roof with power tilt/sliding panel: If it starts to rain, the raised sliding sunroof will automatically be lowered while the vehicle is in motion.

Automatic lowering function

Vehicles with a panorama roof with power tilt/sliding panel: If the sliding sunroof is raised at the rear, it will automatically be lowered slightly at higher speeds. At low speeds, it will be raised again automatically.

⚠ WARNING Risk of becoming trapped by automatic lowering of the sliding sunroof

At higher speeds, the raised sliding sunroof will automatically be lowered slightly at the rear.

- ▶ Make sure that nobody reaches into the sliding sunroof's range of movement while the vehicle is in motion.
- ▶ If somebody becomes trapped, briefly push the sliding sunroof button forwards or backwards.

Rectifying problems with the sliding sunroof

⚠ WARNING Risk of becoming trapped or fatal injuries when the sliding sunroof is closed again

If you close the sliding sunroof again immediately after it has been blocked or reset, the sliding sunroof will close with increased or maximum force.

There is a risk of becoming trapped or even of fatal injuries!

- ▶ Make sure that no parts of the body are in the closing area.
- ▶ If someone is trapped, release the control panel immediately.

or

- ▶ Touch the control panel during automatic closing.
The closing process will be stopped.

The sliding sunroof cannot be closed and you cannot see the cause.

- ① The term "sliding sunroof" refers to the panorama roof with power tilt/sliding panel.

If the sliding sunroof is obstructed during closing and reopens again slightly:

- ▶ Immediately after automatic reversing, swipe forwards across the control panel (→ page 95) and hold until the sliding sunroof is closed. The sliding sunroof will be closed with increased force.

If the sliding sunroof is obstructed again and opens again slightly:

- ▶ Repeat the previous step. The sliding sunroof will be closed again with increased force.

The sliding sunroof or the roller sunblind is not operating smoothly.

- ▶ Reset the sliding sunroof and the roller sunblind.

Resetting the sliding sunroof and the roller sunblind

- ▶ Swipe forwards across the control panel (→ page 95) and hold repeatedly until the sliding sunroof is completely closed.

- ▶ Press and hold the control panel for another second.
- ▶ Press and hold the control panel until the front roller sunblind is completely closed.
- ▶ Press and hold the control panel for another second.
- ▶ Use automatic operation to fully open and then close the sliding sunroof.

Anti-theft protection

Function of the immobilizer

The immobilizer prevents your vehicle from being started without the correct SmartKey.

The immobilizer is automatically activated when the vehicle is switched off, and deactivated when the vehicle is switched on.

When leaving the vehicle, always take the SmartKey with you and lock the vehicle. Anyone can start the vehicle if a valid SmartKey has been left inside the vehicle.

- ⓘ In the event that the engine cannot be started (yet the vehicle's battery is charged), the sys-

tem is not operational. Contact an authorized Mercedes-Benz Center or call 1-800-FOR-MERCEdes (in the USA) or 1-800-387-0100 (in Canada).

ATA (anti-theft alarm system)

Function of the ATA system

If the ATA system is armed, a visual and audible alarm is triggered in the following situations:

- When a door is opened
- When the tailgate is opened
- When the interior motion sensor is triggered (→ page 101)
- When the tow-away alarm is triggered (→ page 100)

The ATA system is armed automatically after approximately ten seconds in the following situations:

- After locking the vehicle with the SmartKey
- After locking the vehicle using KEYLESS-GO

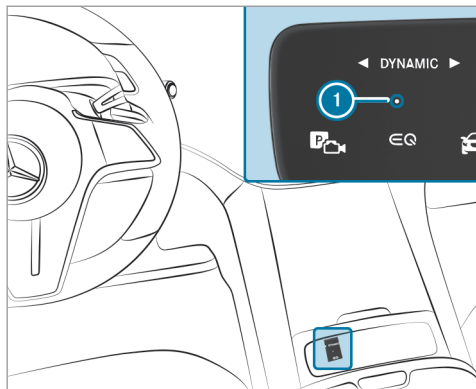



Example: with MBUX Hyperscreen

Indicator lamp  flashes when the ATA system is armed.

The ATA system is deactivated automatically in the following situations:

- After unlocking the vehicle with the SmartKey
- After unlocking the vehicle using KEYLESS-GO

- After pressing the start/stop button with the SmartKey in the marked space (→ page 182)

-  When the Mercedes-Benz emergency call system is active and the alarm stays on for more than 30 seconds, a message is automatically sent to the Customer Assistance Center (→ page 344).
-  In the case of severe battery discharging, the anti-theft alarm system is automatically deactivated to facilitate the next engine start.

Deactivating the ATA

- ▶ Press the ,  or  button on the SmartKey.

or

- ▶ Press the start/stop button with the SmartKey in the marked space (→ page 182)

Deactivating the alarm using KEYLESS-GO

- ▶ With the SmartKey outside the vehicle, touch the inner surface of the door handle.

Function of the tow-away alarm

-  This function may not be available in all countries.

An audible and visual alarm is triggered if an alteration to your vehicle's angle of inclination is detected while the tow-away alarm is armed.



The tow-away alarm is automatically armed after approximately 60 seconds:

- After locking the vehicle with the SmartKey
- After locking the vehicle using KEYLESS-GO

The tow-away alarm is only armed when the following components are closed:

- Doors
- Tailgate

The tow-away alarm is automatically deactivated:

- After pressing the  or  button on the SmartKey
- After pressing the start/stop button with the SmartKey in the marked space (→ page 182)
- After unlocking the vehicle using KEYLESS-GO
- When using HANDS-FREE ACCESS

Information on collision detection on a parked vehicle (→ page 216).

Arming/disarming the tow-away alarm

Multimedia system:

-  » Settings » Vehicle
- » Opening/closing » Vehicle Protection
- ▶ Arm or disarm [Tow-away Protection](#).

The tow-away alarm is armed again in the following cases:

- The vehicle is unlocked again.
- A door is opened.
- The vehicle is locked again.

Function of the interior motion sensor

 This function may not be available in all countries.

When the interior motion sensor is activated, a visual and audible alarm is triggered if movement is detected in the vehicle interior.



The interior motion sensor is activated automatically after approximately ten seconds:

- After locking the vehicle with the SmartKey
- After locking the vehicle using KEYLESS-GO

The interior motion sensor is only activated when the following components are closed:

- Doors
- Tailgate

The interior motion sensor is automatically deactivated:

- After pressing the  or  button on the SmartKey
- After pressing the start/stop button with the SmartKey in the marked space (→ page 182)
- After unlocking the vehicle using KEYLESS-GO
- When using HANDS-FREE ACCESS

The following situations can lead to a false alarm:

- When there are moving objects such as mascots in the vehicle interior
- When a side window is open

- When a panoramic sliding sunroof is open

Activating/deactivating the interior motion sensor

Multimedia system:

-  » Settings » Vehicle
- » Opening/closing » Vehicle Protection
- ▶ Activate or deactivate [Interior Motion Sensor](#).

The Interior motion sensor is activated again in the following cases:

- The vehicle is unlocked again.
- A door is opened.
- The vehicle is locked again.

Notes on the correct driver's seat position

⚠ WARNING Risk of accident due to adjusting the vehicle settings while the vehicle is in motion

You could lose control of the vehicle in the following situations in particular:

- If you adjust the driver's seat, the head restraint, the steering wheel or the mirror while the vehicle is in motion
 - If you fasten your seat belt while the vehicle is in motion
- Before starting the vehicle: in particular, adjust the driver's seat, head restraint, steering wheel and mirror, and fasten your seat belt.



Ensure the following when adjusting the steering wheel ①, seat belt ② and driver's seat ③:

- You are sitting as far away from the driver's airbag as possible, taking the following points into consideration:
- You are sitting in an upright position
- Your thighs are slightly supported by the seat cushion
- Your legs are not fully extended and you can depress the pedals properly
- The back of your head is supported at eye level by the center of the head restraint

- You can hold the steering wheel with your arms slightly bent
- You can move your legs freely
- You can see all the displays on the instrument cluster clearly
- You have a good overview of the traffic conditions
- Your seat belt sits snugly against your body and passes across the center of your shoulder and across your hips in the pelvic area

Seats

Adjusting the front seat electrically

⚠ WARNING Risk of becoming trapped if the seats are adjusted by children

Children could become trapped if they adjust the seats, particularly when unattended.

- When leaving the vehicle, always take the SmartKey with you and lock the vehicle.
- Never leave children unattended in the vehicle.

You can adjust the seats when the vehicle is switched off.

⚠ WARNING Risk of becoming trapped when adjusting the seat

When you adjust a seat, you or other vehicle occupants could become trapped, e.g. on the seat guide rail.

- ▶ When adjusting a seat, make sure that no one has any part of their body within the sweep of the seat.

Observe the safety notes on "Airbags" and "Children in the vehicle".

⚠ WARNING Risk of accident due to adjusting the vehicle settings while the vehicle is in motion

You could lose control of the vehicle in the following situations in particular:

- If you adjust the driver's seat, the head restraint, the steering wheel or the mirror while the vehicle is in motion

- If you fasten your seat belt while the vehicle is in motion
- ▶ Before starting the vehicle: in particular, adjust the driver's seat, head restraint, steering wheel and mirror, and fasten your seat belt.

⚠ WARNING Risk of becoming trapped if the seat height is adjusted carelessly

If you adjust the seat height carelessly, you or other vehicle occupants could be trapped and thereby injured.

Children in particular could accidentally press the electrical seat adjustment buttons and become trapped.

- ▶ While moving the seats, make sure that hands or other body parts do not get under the lever assembly of the seat adjustment system.

⚠ WARNING Risk of injury due to incorrectly adjusted head restraints

If head restraints have not been adjusted correctly, there is an increased risk of injury in the head and neck area, e.g. in the event of an accident or sudden braking.

- ▶ Before driving off, make sure for every vehicle occupant that the center of the head restraint supports the back of the head at about eye level.

Adjust the head restraint fore-and-aft position so that it is as close as possible to the back of your head.

⚠ WARNING Risk of injury or death due to an incorrect seat position

The seat belt does not offer the intended level of protection if you have not moved the seat backrest to an almost vertical position.

In particular, you could slip beneath the seat-belt and become injured.

- ▶ Adjust the seat properly before beginning your journey.
- ▶ Always ensure that the seat backrest is in an almost vertical position and that the shoulder belt is routed across the center of your shoulder.

⚠ WARNING Risk of injury or death due to objects under the co-driver seat

Objects trapped under the co-driver seat can interfere with the function of the automatic co-driver airbag shutoff or damage the system.

- ▶ Do not store any objects under the co-driver seat.
- ▶ When the co-driver seat is occupied, make sure that no objects are trapped under the co-driver seat.

! NOTE Damage to the seats when moving the seats back

The seats may be damaged by objects when moving the seats back.

- ▶ When moving the seats back, make sure that there are no objects in the footwell, under or behind the seats.

The switches for adjusting the seats do not move. You will therefore receive no direct feedback on the switch while pressing the switch. Feedback is provided only by the movement of the seat.

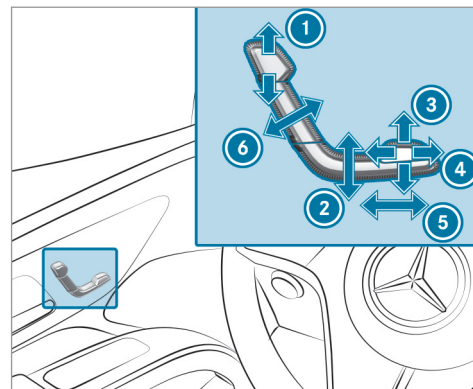

- ① Head restraint height
- ② Seat height
- ③ Seat cushion inclination
- ④ Seat cushion length
- ⑤ Seat fore-and-aft position
- ⑥ Seat backrest inclination

▶ Save the settings with the memory function (→ page 119).

- ⓘ The head restraint height will be adjusted automatically when you adjust the seat height or the seat fore-and-aft position.

Adjusting the front passenger seat electrically from the driver's seat

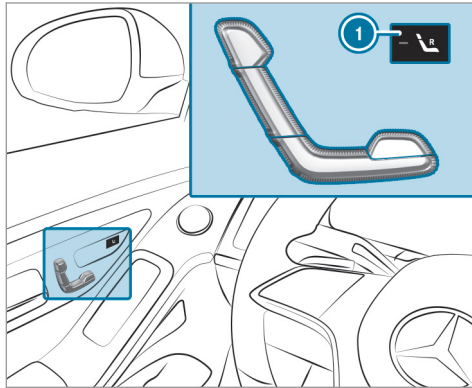

You can call up the following functions for the front passenger seat:

- Seat adjustment
- Seat heating
- Seat ventilation
- Memory function

- ▶ **To select the front passenger seat:** press button ①. When the indicator lamp lights up, the front passenger seat is selected.
- ▶ Adjust the front passenger seat using the buttons on the driver's side door operating unit.

Adjusting the front passenger seat electrically from the rear passenger compartment

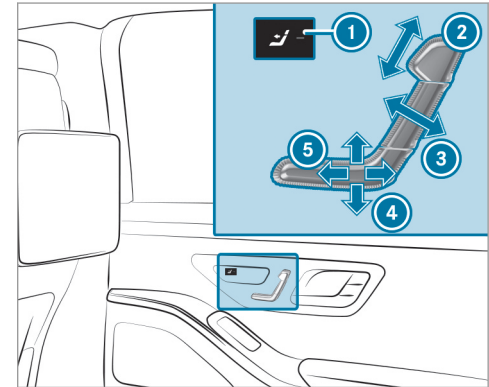

- ① Select front passenger seat
- ② Head restraint height
- ③ Seat backrest inclination
- ④ Seat height
- ⑤ Seat fore-and-aft position

- ▶ **To select the front passenger seat:** press button ①.
When the indicator lamp lights up, the front passenger seat is selected.
- ▶ Adjust the front passenger seat using the buttons on the door operating unit in the rear passenger compartment.
- ① You can use the rear passenger compartment child safety lock to disable this function (→ page 72).

Adjusting the 4-way lumbar support

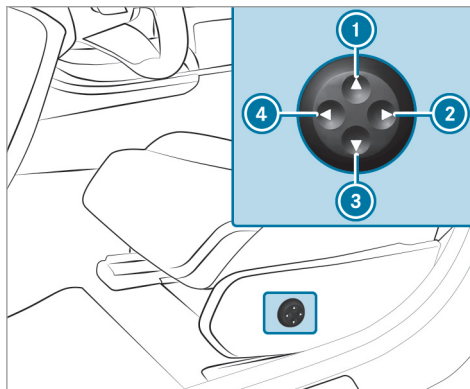

- ① Higher
- ② Softer
- ③ Lower
- ④ Firmer

- ▶ Use buttons ① to ④ to adjust the contour of the backrest.

Adjusting the rear seats electrically

⚠ WARNING Risk of injury or death due to an incorrect seat position

The seat belt does not offer the intended level of protection if you have not moved the seat backrest to an almost vertical position.

In particular, you could slip beneath the seat-belt and become injured.

- ▶ Adjust the seat properly before beginning your journey.
- ▶ Always ensure that the seat backrest is in an almost vertical position and that the shoulder belt is routed across the center of your shoulder.

The switches for adjusting the seats do not move. You will therefore receive no direct feedback on the switch while pressing the switch. Feedback is provided only by the movement of the seat.

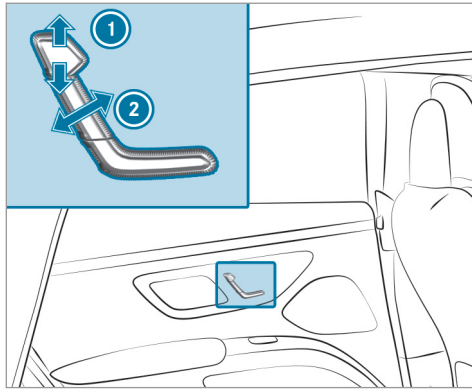

- ① Head restraint height
- ② Seat backrest inclination

▶ Make the appropriate adjustments.

Head restraints

Adjusting the head restraints on the front seats

⚠ WARNING Risk of accident due to adjusting the vehicle settings while the vehicle is in motion

You could lose control of the vehicle in the following situations in particular:

- If you adjust the driver's seat, the head restraint, the steering wheel or the mirror while the vehicle is in motion
 - If you fasten your seat belt while the vehicle is in motion
- ▶ Before starting the vehicle: in particular, adjust the driver's seat, head restraint, steering wheel and mirror, and fasten your seat belt.

⚠ WARNING Risk of injury due to incorrectly adjusted head restraints

If head restraints have not been adjusted correctly, there is an increased risk of injury in

the head and neck area, e.g. in the event of an accident or sudden braking.

- ▶ Before driving off, make sure for every vehicle occupant that the center of the head restraint supports the back of the head at about eye level.

Adjust the head restraint fore-and-aft position so that it is as close as possible to the back of your head.

Moving forward or back

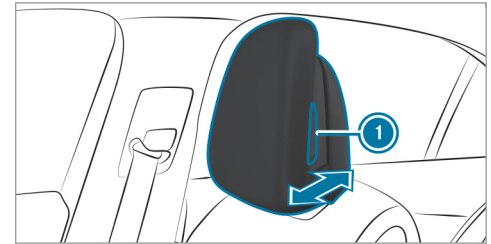

- ▶ Take hold of the head restraint on both sides and press release knob ①.

- ▶ Pull the headrest forwards or push it backwards.
- ▶ Let go of release knob ❶.
- ▶ **To raise or lower:** adjust the head restraint using the buttons on the door operating unit (→ page 102).

Adjusting the luxury head restraints on the front seats

Moving forward or back

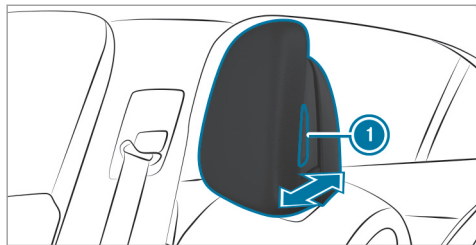

- ▶ Take hold of the head restraint on both sides and press release knob ❶.

- ▶ Pull the headrest forwards or push it backwards.
- ▶ Let go of release knob ❶.
- ▶ **To raise or lower:** adjust the head restraint using the buttons on the door operating unit (→ page 102).

Adjusting the head restraints of the rear seats mechanically (standard seats)

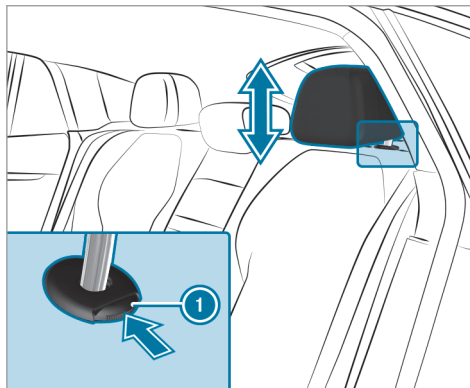

- ▶ **To set in the first position:** pull the head restraint up.
- ▶ **To raise:** push release knob ❶ in the direction of the arrow and pull the head restraint up.
- ▶ **To lower:** press release knob ❶ in the direction of the arrow and push the head restraint down.

Attaching and removing the additional cushion of the head restraint in the rear passenger compartment (standard seats)

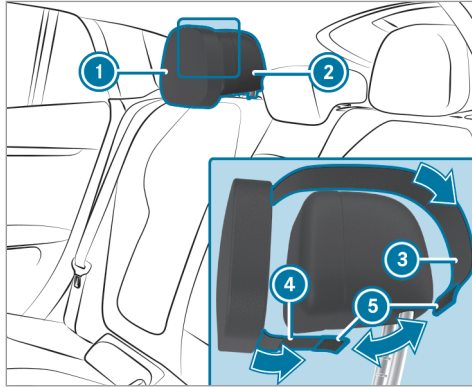

- ▶ **To attach the additional cushion:** guide long strap ③ of additional cushion ① over the back of head restraint ②.
- ▶ Guide short strap ④ of additional cushion ① under head restraint ②.

- ▶ Bring both straps ③ and ④ together on the underside of the head restraint and close Velcro fastening ⑤.
- ▶ **To remove the additional cushion:** open Velcro fastening ⑤.
- ▶ Remove additional cushion ①.

Attaching and removing the additional cushion of the head restraint in the rear passenger compartment (premium seats)

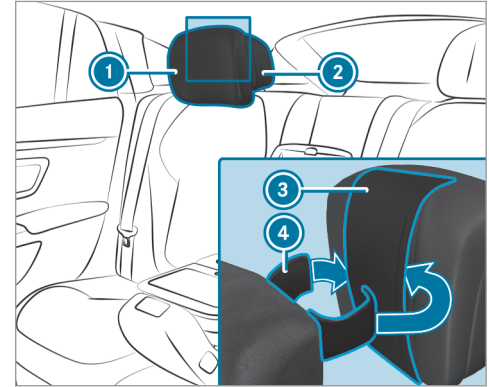

- ▶ **To attach the additional cushion:** open Velcro strip ④ on the rear of additional cushion ①.
- ▶ Guide Velcro strip ④ between head restraint ② and strip ③.
- ▶ Close Velcro strip ④.

- ▶ **To change the position of the additional cushion:** move additional cushion ① up or down.
- ▶ **To remove additional cushion:** open Velcro strip ④ of additional cushion ①.
- ▶ Remove additional cushion ①.

Attaching a heated additional cushion

- ▶ Attach the additional cushion to the head restraint as described.
- ▶ Move the head restraint to the very top.

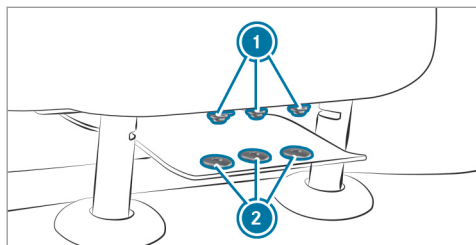

- ▶ Push press-studs ② on the additional strap into counterpieces ① on the head restraint.
- ▶ Move the head restraint to the desired height.

Switching neck heating from the additional cushion on/off

- ▶ Make sure that press-studs ② on the additional strap are correctly pushed into counterpieces ① on the head restraint.
- ▶ Ensure that the "Couple neck heating to seat heating" function is active (→ page 111) in the multimedia system.
- ▶ Activate or deactivate the seat heating (→ page 113).

Folding the center head restraint into position and folding it back manually (premium seats)

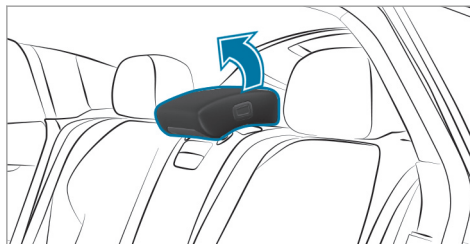

- ▶ **To fold into position:** pull the head restraint upwards until it engages.

Folding down

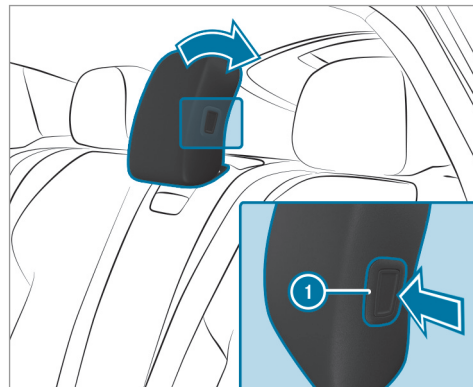

- ▶ Press button ①.
- ▶ Fold down the head restraint completely.

The center head restraint has a usage position and a non-usage position. The usage position is

the upright position in which the head restraint is locked; the non-usage position is the position in which the head restraint is folded downwards. When the center seat is used, the head restraint must be in the upright, locked usage position.

Configuring the seat settings

Multimedia system:

 >> Comfort >> Seat

Adjusting the air cushions

- ▶ On the corresponding menu, adjust the air cushions for **Lumbar**, **Shoulders** or **Side Bolsters**.

Setting the seat heating balance

- ▶ Select **Heating Settings**.
 - ▶ Select **Seat Heating Balance**.
 - ▶ Adjust the heat distribution for the desired seat.
- i** The seat heating balance can be set in the **Seat Climate Control** menu in the rear passenger compartment.

Coupling neck heat to seat heating

- ▶ Select **Additional Neck Warmer**.
- ▶ Switch the function for the desired seat on or off.
If the function is active, the neck heat of the additional cushion has been coupled to the seat heating.

Setting automatic seat adjustment

⚠ WARNING Risk of becoming trapped during adjustment of the driver's seat after calling up a driver profile

Selecting a user profile may trigger an adjustment of the driver's seat to the position saved under the user profile. You or other vehicle occupants could be injured in the process.

- ▶ Make sure that when the position of driver's seat is being adjusted using the multimedia system, no people or body parts are in the seat's range of movement.

If there is a risk of someone becoming trapped, stop the adjustment process immediately:

- ▶ a) Tap the warning message on the central display.
- or
- ▶ b) Press a memory position button or a seat adjustment switch on the driver's door.
The adjustment process will be stopped.

Multimedia system:

 >> Comfort >> Seat
>> Automatic Seat Positioning

Manually adjusting driver's seat and steering wheel position to body size

The vehicle calculates a suitable driver's seat and steering wheel position on the basis of the driver's body size and sets this directly.

- ▶ **To set the unit of measurement:** select **cm** or **ft/in**.
- ▶ Set the size using the scale.

▶ Select **Start Positioning**.

The driver's seat and steering wheel position is adjusted to the body size that has been set.

- ⓘ You can also configure these settings via the Mercedes me user account for your user profile. By synchronizing the profiles in the vehicle and the Mercedes me connect profiles, you can carry over these settings for your vehicle. Further information about synchronizing user profiles .

Automatically adjusting driver's seat and steering wheel position to body size

If the vehicle has the Interior Assistant, the driver's body size can be determined automatically using the 3D laser cameras in the overhead control panel.

- ▶ Wait until the Interior Assistant has determined the body size.

▶ Select **Start Positioning**.

The driver's seat and steering wheel position is adjusted to the body size that has been determined.

- ⓘ Further information on the Interior Assistant: (→ page 306)

- ⓘ If the driver's seat and steering wheel position calculated by the vehicle is not practical or comfortable, it can be manually adapted at any time via the control buttons. The outside mirrors are not set via this function. Instead, they have to be set manually via the operating switches.

Overview of massage programs



- ⓘ Depending on the vehicle equipment, different massage programs are available:
- **Relaxing Massage** Relaxing back massage with increasing wave motions and then soothing movements.
 - **Hot Relaxing Back** Based on hot stone massage, the program combines heat and massage. It starts by massaging the back. In addition, warm pressure points become noticeable, starting in the pelvic area.
 - **Hot Relaxing Shoulders** Combination of heat and massage. It starts by massaging the shoulders. In addition, warm pressure points become noticeable, starting in the pelvic area.

- **Activating Massage** Activating massage program with upward-moving massage waves.
- **Classic Massage** Calming back massage program.
- **Wave Massage** Regenerating massage program through massage waves across the back and in the seat cushion.
- **Mobilizing Massage** Mobilizing massage program with upward-moving massage waves. Can promote slower, deeper respiration. This can improve the supply of oxygen to cells and the brain.
- **Workout, Backrest** and **Workout, Cushion** These programs require your cooperation. Alternating between tensing and releasing helps to improve blood flow to your muscles. Press against a pressure point as soon as you feel it to activate back, abdominal and leg muscles.
- **Deep Waves** Wave-like movements in the cushion can promote blood flow and metabolic processes in the lower back and legs.
- **Deep Workout** Connect the **Workout, Backrest** to the **Workout, Cushion**. The vibrating

massage in the cushion intensifies the effectiveness of tensing and releasing muscles when you tense against the pressure point. This supports metabolic processes and blood flow in the buttocks and legs.



Selecting the massage program for the front seats

Multimedia system:

-  ➤➤ Comfort ➤➤ Massage
- ▶ Select a massage program (→ page 112).
- ▶ Start the program for the desired seat .
- ▶ **To set the massage intensity: switch Intensive on or off .**

Resetting seat settings

Multimedia system:

-  ➤➤ Comfort ➤➤ Seat
- ▶ Select **Reset**.
- ▶ Select  for the desired seat.

Switching the seat heating on/off

⚠ WARNING Risk of burns due to repeatedly switching on the seat heating

Repeatedly switching on the seat heating can cause the seat cushion and seat backrest padding to become very hot.

In particular, the health of persons with limited temperature sensitivity or a limited ability to react to high temperatures may be affected or they may even suffer burn-like injuries.

- ▶ Do not repeatedly switch on the seat heating.

To protect against overheating, the seat heating may be temporarily deactivated after it has been switched on repeatedly.

! NOTE Damage to the seats caused by objects or documents when the seat heating is switched on

When the seat heating is switched on, overheating may occur due to objects or docu-

ments placed on the seats, e.g. seat cushions or child seats. This could cause damage to the seat surface.

- ▶ Make sure that no objects or documents are on the seats when the seat heating is switched on.

Requirements:

- The power supply is switched on.

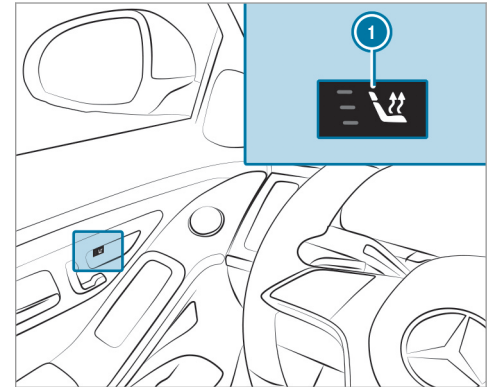

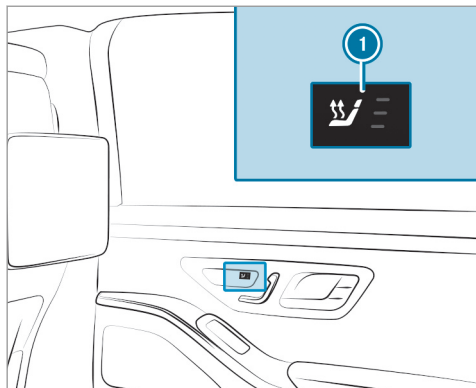

- ▶ Press button ① repeatedly until the desired heating level is set. Depending on the heating level, up to three indicator lamps will light up. If all indicator lamps are off, the seat heating is switched off.
- ① The seat heating will automatically switch down from the three heating levels after 8, 10 and 20 minutes until the seat heating switches off.

- ① If you switch the power supply off and on again within 20 minutes, the previous setting of the seat heating for the driver's seat will remain active.
- ① You can set the heat distribution of the heated sections among the seat cushions and seat backrests on the front and rear seats using the multimedia system (→ page 111).

Switching the seat ventilation on/off

Requirements:

- The power supply is switched on.

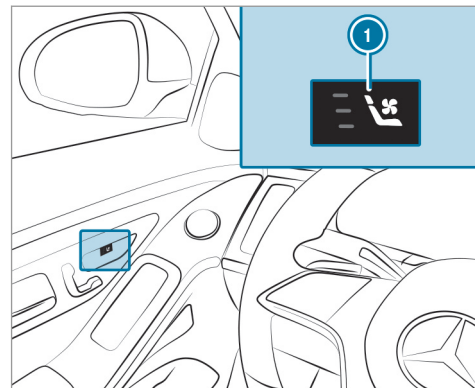

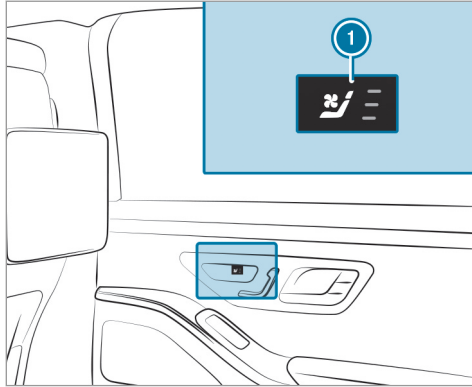

- ▶ Press button ① repeatedly until the desired blower setting has been reached. Depending on the blower setting, up to three indicator lamps will light up. If all indicator lamps are off, the seat ventilation is switched off.

① If you switch the power supply off and on again within 20 minutes, the previous seat

ventilation setting for the driver's seat will remain active.

Steering wheel

Adjusting the steering wheel electrically

⚠ WARNING Risk of accident due to adjusting the vehicle settings while the vehicle is in motion

You could lose control of the vehicle in the following situations in particular:

- If you adjust the driver's seat, the head restraint, the steering wheel or the mirror while the vehicle is in motion
- If you fasten your seat belt while the vehicle is in motion
- ▶ Before starting the vehicle: in particular, adjust the driver's seat, head restraint, steering wheel and mirror, and fasten your seat belt.

⚠ WARNING Risk of entrapment for children when adjusting the steering wheel

Children could injure themselves if they adjust the steering wheel.

- ▶ Never leave children unattended in the vehicle.
- ▶ When leaving the vehicle, always take the SmartKey with you and lock the vehicle.

The steering wheel can be adjusted when the power supply is disconnected.

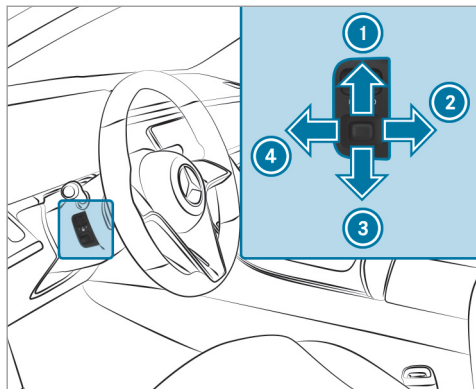

- ① To move up
- ② To move back
- ③ To move down
- ④ To move forward

▶ Save the settings with the memory function (→ page 119).

Coupling the steering wheel heater with the seat heating

Requirements:

- The power supply or the vehicle has been switched on.

Multimedia system:

→ ▶▶ Comfort ▶▶ Seat
▶▶ Heating Settings

- ▶ Tap on **Additional Steering Wheel Heating**.
The steering wheel heater will be coupled to the seat heating.

When the function has been activated, the steering wheel heater is automatically activated and deactivated when you switch the switch the seat heating on and off.

Easy entry and exit feature

Using the easy entry and exit feature

- ⚠ **WARNING** Risk of accident when pulling away during the adjustment process of the easy entry and exit feature

You could lose control of the vehicle.

- ▶ Always wait until the adjustment process is complete before driving off.

- ⚠ **WARNING** Risk of becoming trapped during adjustment of the easy entry and exit feature

You and other vehicle occupants – particularly children – could become trapped.

- ▶ Ensure that no one has a body part in the sweep of the steering wheel or driver's seat.

If there is a risk of becoming trapped by the steering wheel:

- ▶ Move the adjustment lever of the steering wheel.
The adjustment process will be stopped.

If there is a risk of becoming trapped by the driver's seat:

- ▶ Press the seat adjustment switch.
The adjustment process will be stopped.
- ▶ Never leave children unattended in the vehicle.
- ▶ When leaving the vehicle, always take the SmartKey with you and lock the vehicle.

You can stop the adjustment process by pressing one of the memory function position switches.

▲ WARNING Risk of becoming trapped if children activate the easy entry and exit feature-

Children could become trapped if they activate the easy entry- and exit feature, particularly when unattended.

- ▶ Never leave children unattended in the vehicle.
- ▶ When leaving the vehicle, always take the SmartKey with you and lock the vehicle.

In order to use the easy entry and exit feature, the automatic seat adjustment function must have been switched on (→ page 111).

When the easy entry and exit feature is active, the steering wheel and driver's seat will move as follows:

- The steering wheel will move upwards.
- The driver's seat will move forward or backward to a seat position suitable for getting out of the vehicle.

This will occur in the following situations:

- You switch off the vehicle when the driver's door is open.
- You open the driver's door when the vehicle is switched off.

i The steering wheel will then move upwards only if it is not already as high as it will go.

The driver's seat will then move backwards only if it is not already at the rear of the seat adjustment range.

The steering wheel and the driver's seat will move back to the last drive position in the following cases:

- You switch the power supply or the vehicle on when the driver's door is closed
- You close the driver's door when the vehicle is switched on.

The last drive position will be saved when:

- You switch off the vehicle.
- You call up the seat settings via the memory function.
- You save the seat settings via the memory function.

If you press one of the memory function position buttons, the adjustment process will be stopped.

Setting the easy entry and exit feature

Requirements:

- The automatic seat adjustment has been activated (→ page 111).

Multimedia system:

→  >> Settings >> Vehicle

>> Convenience >> Easy Entry And Exit Feature

- ▶ Activate/deactivate [Seat Positioning](#) or [Steering Wheel Positioning](#).

- ⓘ If you are using an individual user profile, this information is used for the easy entry and exit feature. This will cause the driver's seat and steering wheel to move into the correct position automatically .

Lowering the window

- ▶ Activate or deactivate the function.
The front windows lower to an intermediate position when the doors are opened.

Memory function

Function of the memory function

- ⚠ **WARNING** Risk of an accident if the memory function is used while driving

If you use the memory function on the driver's side while driving, you could lose control of the vehicle as a result of the adjustments being made.

- ▶ Only use the memory function on the driver's side when the vehicle is stationary.

- ⚠ **WARNING** Risk of entrapment when adjusting the seat with the memory function

When the memory function adjusts the seat, you and other vehicle occupants – particularly children – could become trapped.

- ▶ During the adjusting process of the memory function, ensure that no body

parts are in the area of movement of the seat or the steering wheel.

- ▶ If someone becomes trapped, press a preset position button or seat adjustment switch immediately.
The adjustment process is stopped.

- ⚠ **WARNING** Risk of entrapment if the memory function is activated by children

Children could become trapped if they activate the memory function, particularly when unattended.

- ▶ Never leave children unattended in the vehicle.
- ▶ When leaving the vehicle, always take the SmartKey with you and lock the vehicle.

You can use the memory function when the vehicle is switched off.

Seat adjustments for up to three people can be stored and called up using the memory function.

You can save the following settings for the front seat:

- Seat, backrest, head restraint position and contour of the seat backrest in the lumbar region
- Seat heating: distribution of the heated sections of the seat cushion and seat backrest
- Driver's side: steering wheel position and position of the outside mirrors on the driver's and front passenger sides
- Head-up Display

Operating the memory function

Storing

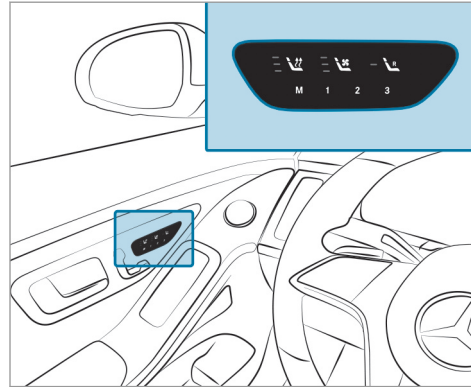

- ▶ Set the seat, the steering wheel, the head-up display and the outside mirror to the desired position.
- ▶ Press the **M** button and then release it.

- ▶ Press one of the preset position buttons **1**, **2** or **3** within three seconds. An acoustic signal sounds. The settings are stored.
- ▶ **To call up:** press the preset position button **1**, **2** or **3**. The seat is moved to the stored position. After releasing the button, the front seat, outside mirror, head-up display and steering column continue to move into the stored position automatically.

Stowage areas

Notes on loading the vehicle

⚠ WARNING Risk of injury from unsecured items in the vehicle

If objects, luggage or loads are not secured or not secured sufficiently, they could slip, tip over or be thrown around and thereby hit vehicle occupants.

There is a risk of injury, particularly in the event of sudden braking or a sudden change in direction.

- ▶ Always stow objects in such a way that they cannot be thrown around.
- ▶ Before the journey, secure objects, luggage or loads against slipping or tipping over.

⚠ WARNING Risk of injury due to objects being stowed incorrectly

If objects in the vehicle interior are stowed incorrectly, they can slide or be thrown around and hit vehicle occupants. In addition, cup holders, open storage spaces and mobile phone receptacles cannot always retain all objects within.

There is a risk of injury, particularly in the event of sudden braking or abrupt changes in direction.

- ▶ Always store objects such that they cannot be thrown around in such situations.

- ▶ Always make sure that objects do not protrude from storage spaces, parcel nets or storage nets.
- ▶ Close the lockable storage spaces before starting a journey.
- ▶ Stow and secure objects that are heavy, hard, pointed, sharp-edged, fragile or too large in the cargo compartment.

⚠ WARNING Risk of accident from objects in the driver's footwell and front-passenger footwell

Objects in the driver's footwell and front-passenger footwell may impede pedal travel or block a depressed pedal.

This jeopardizes the operating and road safety of the vehicle.

- ▶ Stow all objects in the vehicle securely so that they cannot get into the driver's footwell or front-passenger footwell.
- ▶ Always install the floor mats securely and as prescribed in order to ensure that

there is always sufficient clearance for the pedals.

- ▶ Do not use loose floor mats and do not lay multiple floor mats on top of one another.

Vehicles with automatic front passenger airbag shutoff:

Objects trapped under the front passenger seat may interfere with the function of the automatic front passenger airbag shutoff or damage the system. Please observe the notes on the function of the automatic front passenger airbag shutoff (→ page 53).

⚠ WARNING - Risk of accident or injury when using the cup holder while the vehicle is moving

The cup holder cannot secure containers while the vehicle is moving.

If you use a cup holder while the vehicle is moving, the container may be flung around and liquids may be spilled. The vehicle occupants may come into contact with the liquid and if it is hot, they could be scalded. You

could be distracted from traffic conditions and you may lose control of the vehicle.

- ▶ Only use the cup holder when the vehicle is stationary.
- ▶ Only use the cup holder for containers of the right size.
- ▶ Close the container, particularly if the liquid is hot.

! **NOTE** Damage to the cup holder

When the rear armrest is folded back the cup holder could become damaged.

- ▶ Only fold the rear armrest back when the cup holder is closed.

! **NOTE** Damage to the rear armrest due to body weight

When folded out, the rear armrest can be damaged by body weight.

- ▶ Do not sit or support yourself on the rear seat armrest.

! **WARNING** Risk of injury due to an open cargo compartment floor

If you drive with the cargo compartment floor open, objects could be flung around and hit vehicle occupants as a result. There is a risk of injury, particularly in the event of sudden braking or a sudden change in direction.

- ▶ Always close the cargo compartment floor before a journey.

! **NOTE** Damage to the stowage compartment under the ashtray due to intense heat

The stowage compartment under the ashtray is not heat resistant and could be damaged if you rest a lit cigarette on it.

- ▶ Make sure that the ashtray is fully engaged.

The driving characteristics of your vehicle are dependent on the distribution of the load within the vehicle. You should bear the following in mind when loading the vehicle:

- Never exceed the permissible gross mass or the gross axle weight rating for the vehicle (including occupants). The values are specified on the vehicle identification plate on the vehicle's B-pillar.
- the load must not protrude above the upper edge of the seat backrests.
- When transporting objects in the cargo compartment, always install the cargo compartment cover and partitioning net.
- always place the load behind unoccupied seats if possible.
- secure the load using the tie-down eyes and distribute the load evenly.

Notes on driving with a roof load

- Evenly distribute the roof load, and place heavy objects at the bottom. Also comply with the notes on loading the vehicle.

- Drive attentively, and avoid suddenly pulling away, braking and steering as well as rapid cornering.
 - When transporting roof loads and when the vehicle is fully loaded or fully occupied, select drive programs **E** and **C**. These are designed to focus on stability (→ page 191).
- i** For more information on stowage compartments and stowage areas, please refer to the Digital Operator's Manual.

Stowage spaces in the vehicle interior

Overview of the front stowage compartments

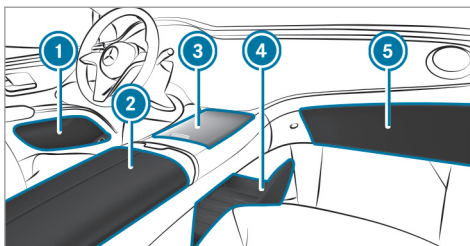

- ① Stowage spaces in the doors
- ② Stowage and telephone compartment beneath the armrest with charging module for wireless charging of mobile phones, multimedia and USB ports as well as stowage space, e.g. for an MP3 player
- ③ Stowage compartment in the front center console with cup holders, USB ports and charging module for wireless charging of mobile phones
- ④ Stowage tray below the central display of the multimedia system with USB ports
- ⑤ Glove box

- i** The rubber mat in the stowage compartment in front center console ③ can be removed for cleaning with clean, lukewarm water. Please comply with the notes on caring for the interior (→ page 360).
- i** Use the rubber strap to securely store objects in the stowage tray under the central display.

Opening and closing the stowage compartment in the front center console

⚠ WARNING Risk of injury due to objects being stowed incorrectly

If objects in the vehicle interior are stowed incorrectly, they can slide or be thrown around and hit vehicle occupants. In addition, cup holders, open storage spaces and mobile phone brackets cannot always retain all objects they contain.

There is a risk of injury, particularly in the event of sudden braking or a sudden change in direction.

- ▶ Always stow objects in such a way that they cannot be thrown around in such situations.
- ▶ Always make sure that objects do not protrude from storage spaces, parcel nets or storage nets.
- ▶ Close the lockable storage spaces before starting a journey.
- ▶ Always stow and secure heavy, hard, pointed, sharp-edged, fragile or bulky objects in the trunk.

Observe the notes on loading the vehicle.

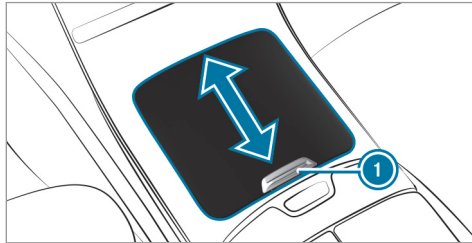

- ▶ **To open:** slide the cover of the stowage compartment in the front center console all the way forwards in the direction of the arrow using handle ①.
- ▶ **To close:** briefly push handle ① of the open cover of the stowage compartment in the front center console forwards. The cover automatically closes the stowage compartment in the front center console.

Opening and closing the glove box

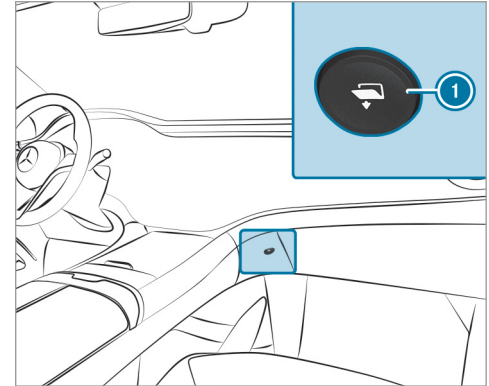

- ▶ **To open:** press button ①. The glove box is open.
- ▶ **To close:** fold the glove box upwards. The glove box is closed.

Through-loading feature in the rear bench seat (EASY-PACK Quickfold)

Folding the rear seat backrests forward

⚠ WARNING Risk of becoming trapped when adjusting the seats

When you adjust a seat, you may trap yourself or a vehicle occupant.

- ▶ When adjusting a seat, make sure that no one has any body parts in the sweep of the seat.

⚠ WARNING Risk of an accident because the seat backrest is not engaged

The seat backrest may fold forwards.

There is a risk of the following, in particular:

- The vehicle occupant may be pressed against the seat belt. The seat belt cannot protect as intended and could cause additional injury.

- A child restraint system is no longer properly supported or properly positioned and may no longer fulfill its function as intended.
- The seat backrest cannot restrain objects or goods in the trunk or cargo compartment.

Always ensure that the seat backrest is engaged, especially:

- After the seat has been adjusted.
- After the cargo compartment enlargement has been folded forwards

Make sure that the red marking of the lock verification indicator is no longer visible. Otherwise, the seat backrest will not be locked.

Always ensure that all vehicle occupants have their seat belts fastened correctly and are sitting properly. Particular attention must be paid to children.

Requirements:

- The rear seat backrest head restraints are fully inserted.

- Vehicles with a folding rear armrest: the rear armrest has been folded up.

Folding the rear seat backrests forward mechanically

You can fold the center and right seat backrests forwards separately.

The left seat backrest can be folded forwards only together with the center seat backrest.

Vehicles with a "Premium rear passenger compartment" do not have a center seat backrest.

If you no longer require the folded-down rear seat backrest as a load area, fold the backrest back into place.

- ▶ Ensure that the center seat backrest is in an upright position and engaged with the left seat backrest (→ page 128).

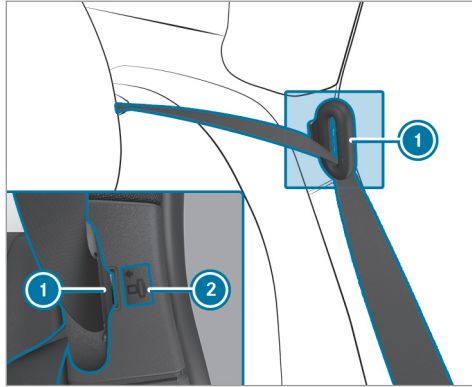

- ▶ Press the seat belt tongue of seat belt ① into marked position ②.
- ▶ Move the driver's or front passenger seat forwards, if necessary.



- ▶ Pull release lever ①.
- ▶ Fold the corresponding seat backrest forwards.

Folding the rear seat backrests forward electrically

You can fold the center and right seat backrests forwards separately.

The left seat backrest can be folded forwards only together with the center seat backrest.

Vehicles with a "Premium rear passenger compartment" do not have a center seat backrest.

If you no longer require the folded-down rear seat backrest as a load area, fold the backrest back into place.

- ▶ Ensure that the center seat backrest is in an upright position and engaged with the left seat backrest (→ page 128).

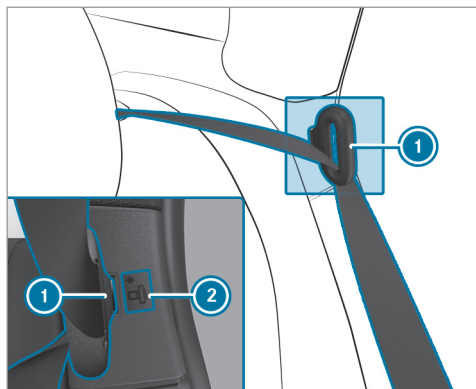

- ▶ Press the seat belt tongue of seat belt ① into marked position ②.
- ▶ If at least one section of the rear seat backrest is folded forwards, the corresponding front seat will move forwards slightly, if necessary, to avoid a collision. The rear head restraints are lowered as required.



- ▶ In the rear passenger compartment: pull release lever ①.

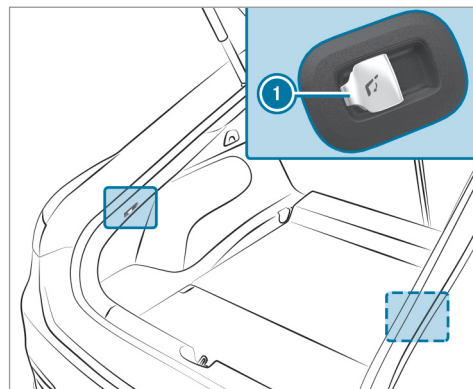

- ▶ In the cargo compartment: briefly pull one of buttons ①.
The corresponding seat backrest will be unlocked.
If the left seat backrest is not locked with the center seat backrest, this will be shown on the driver's display.
- ▶ Fold the corresponding seat backrest forwards.

Folding the center rear seat backrest forwards separately

If you no longer require the folded-down seat backrest as a loading area, fold the backrest back into place.

Vehicles with a "Premium rear passenger compartment" do not have a center seat backrest.

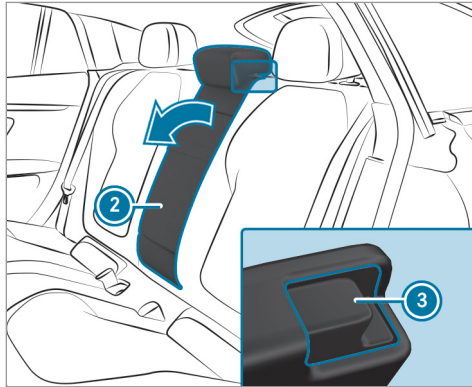

- ▶ Press release catch ③.

- ▶ Fold seat backrest ② forwards.

Folding back the rear seat backrest

! **NOTE** Damage caused by trapping the seat belt when folding back the seat backrest

The seat belt could become trapped and thus damaged when the seat backrest is folded back.

- ▶ Make sure that the seat belt is not trapped when folding back the seat backrest.

Vehicles with a "Premium rear passenger compartment" do not have a center seat backrest.

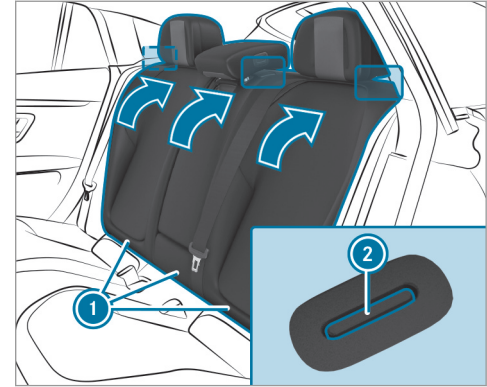

- ▶ Move the driver's or front passenger seat forwards, if necessary.
- ▶ Swing seat backrest ① back until it engages. If the seat backrest is not engaged and locked in place, red lock verification indicator ② will be visible.

Locking and releasing the release catch of the center rear seat backrest

You can lock the center seat backrest release catch if you want to secure the trunk against unauthorized access. The center seat backrest can then be folded forwards only together with the left seat backrest.

Vehicles with a "Premium rear passenger compartment" do not have a center seat backrest.

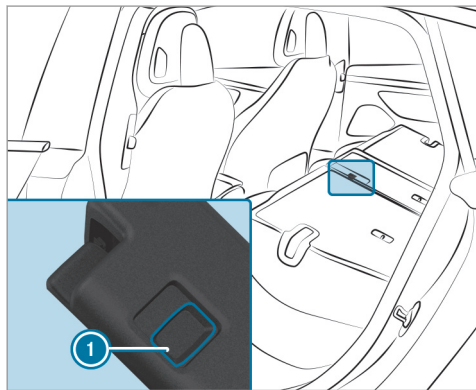

- ▶ **To lock or unlock:** slide catch ① upwards or downwards.

EASY-PACK cargo compartment cover and partitioning net cassette

Notes on the cargo compartment cover

⚠ WARNING Risk of injury or death due to poorly secured objects

The cargo compartment cover alone cannot secure or restrain heavy objects, items of luggage or heavy loads.

You could be hit by an unsecured load, particularly in the event of abrupt changes in direction, sudden braking or an accident.

- ▶ Always stow objects in such a way that they cannot be thrown around.
- ▶ Secure objects, luggage or loads against slipping or tipping over, e.g. by using tie downs, even if you are using the cargo compartment cover.

! **NOTE** Damage to the cargo compartment cover when loading the vehicle

The cargo compartment cover may be damaged when the vehicle is being loaded.

- ▶ Do not place any objects above the lower edge of the side windows or on the cargo compartment cover.

Extending/retracting the cargo compartment cover

Extending

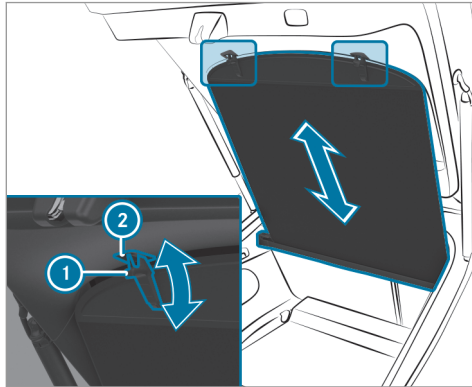

- ▶ Pull the cargo compartment cover back by both grab handles ① and hook it into brackets ② on the left and right.

Retracting

- ▶ Release the cargo compartment cover from brackets ② on the left and right.
- ▶ Guide the cargo compartment cover forwards using both grab handles ① until it is fully retracted.

Installing/removing the cargo compartment cover

Requirements:

- The cargo compartment cover is rolled up.

Removing the cargo compartment cover

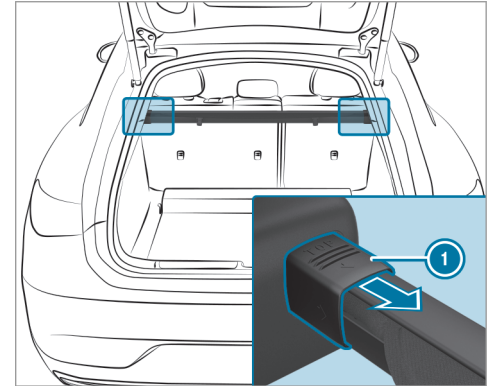

- ▶ Press end cap ① on the left or right inwards.
- ▶ Pull out the cargo compartment cover backwards.

Installing the cargo compartment cover

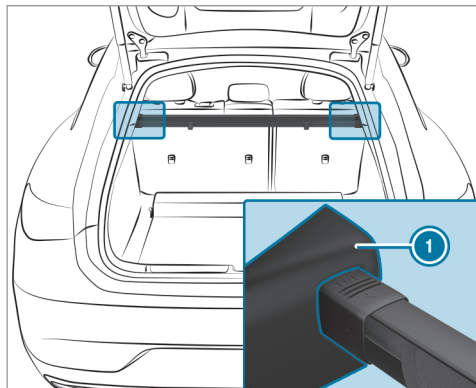

- ▶ Insert the cargo compartment cover in brackets ① on the left and right. The end caps of the cargo compartment cover will engage audibly.

Attaching/removing the partitioning net

⚠ WARNING Risk of injury or death due to poorly secured objects

The partitioning net alone cannot secure or restrain heavy objects, items of luggage or heavy loads.

You could be hit by an unsecured load, particularly in the event of abrupt changes in direction, sudden braking or an accident.

- ▶ Always stow objects in such a way that they cannot be thrown around.
- ▶ Secure objects, luggage or loads against slipping or tipping over, e.g. by using tie downs, even if you are using the partitioning net.

For safety reasons, always use a partitioning net when transporting a load.

Damaged partitioning nets can no longer fulfill their functions and must be replaced. Visit a qualified specialist workshop.

Please note that the availability of the partitioning net depends on the equipment.

Attaching

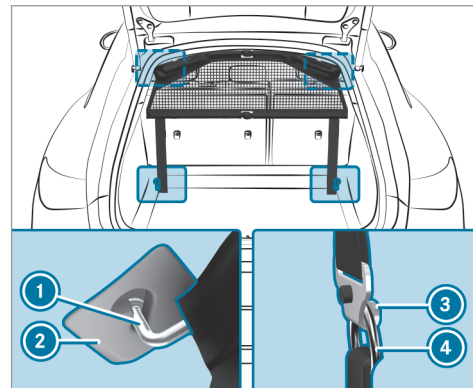

Partitioning net without cargo compartment enlargement

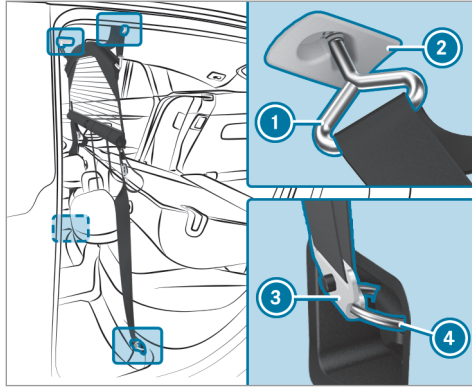

Partitioning net with cargo compartment enlargement

- ▶ Unfold the partitioning net until it audibly clicks into place.
- ▶ Hook partitioning net ① into holders ② on the left and right on the headliner.
- ▶ Engage hooks ③ in tie-down eyes ④ on the left and right.

- ▶ Pull on the loose ends of the lashing straps at the same time until partitioning net ① is tight.

Removing

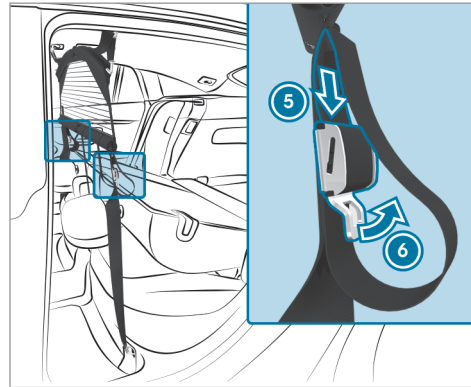

- ▶ Raise the buckle of lashing strap ⑥ in the direction of arrow.

- ▶ Slide the loose end of lashing strap ⑥ into the buckle in the direction of arrow until the lashing straps are loose.
- ▶ Remove hooks ③ from tie-down eyes ④ on the left and right.
- ▶ Remove partitioning net ① from brackets ② on the headliner on the left and right.

Stowing

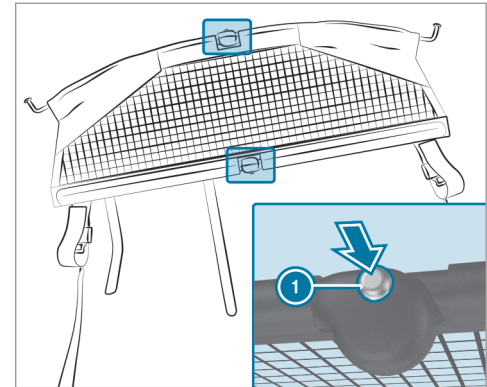

132 Seats and stowing

- ▶ Press both buttons ① and fold together the partitioning net.
- ▶ The partitioning net can be stowed in the stowage space under the cargo compartment floor.

Overview of the tie-down eyes

Observe the notes on loading the vehicle (→ page 119).

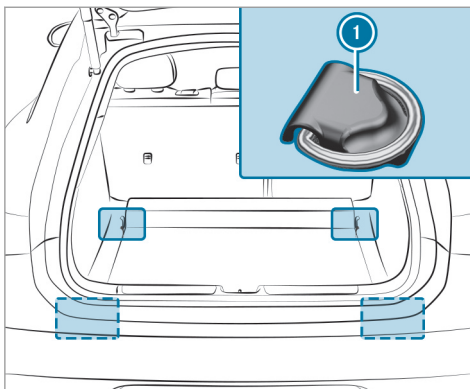

① Tie-down eyes

Overview of bag hooks

⚠ WARNING Risk of injury when using bag hooks with heavy objects

The bag hooks cannot restrain heavy objects or items of luggage.

Objects or items of luggage may be flung around and hit vehicle occupants.

- ▶ Only hang light objects on the bag hooks.
- ▶ Never hang hard, sharp-edged or fragile objects on the bag hooks.

Observe the notes on loading the vehicle (→ page 119).

Subject the bag hooks to a maximum load of 6.6 lbs (3 kg) and do not attach any goods to them.

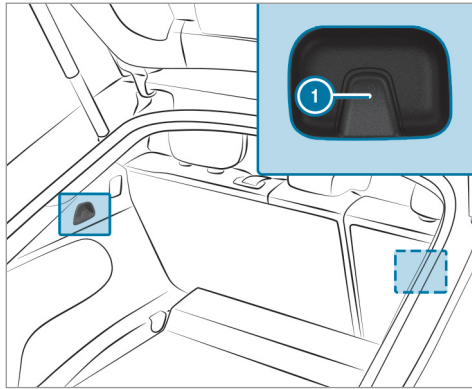

1 Bag hook

Using the clothes hooks in the rear passenger compartment

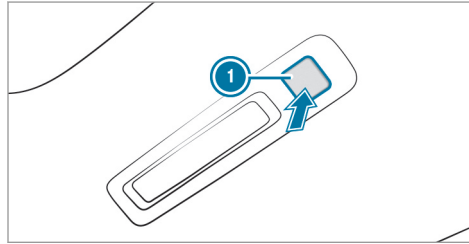

- ▶ Press clothes hook 1 at the bottom. Clothes hook 1 will extend.
- i Observe the notes on loading the vehicle (→ page 119).

Attaching a roof luggage rack

⚠ WARNING Risk of accident due to exceeding the maximum roof load

The vehicle center of gravity and the usual driving characteristics as well as the steering and braking characteristics alter.

If you exceed the maximum roof load, the driving characteristics, as well as steering and braking, will be greatly impaired.

- ▶ Never exceed the maximum roof load and adjust your driving style.

You will find information on the maximum roof load in the "Technical data" section.

! NOTE Damage to the vehicle due to not observing the maximum permitted headroom clearance

If the vehicle height is greater than the maximum permitted headroom clearance, the roof and other parts of the vehicle may be damaged.

- ▶ Observe the signposted headroom clearance.
- ▶ If the vehicle height is greater than the permitted headroom clearance, do not enter.
- ▶ Observe the changed vehicle height with add-on roof equipment.

! **NOTE** Vehicle damage from non-approved roof luggage racks

The vehicle could be damaged by roof luggage racks that have not been tested and approved by Mercedes-Benz.

- ▶ Only use roof luggage racks tested and approved for Mercedes-Benz.
- ▶ Depending on the vehicle equipment, ensure that when the roof luggage rack is installed, the tailgate can be fully opened.
- ▶ Position the load on the roof luggage rack in such a way that the vehicle will

not sustain damage even when it is in motion.

! **NOTE** Damage to panorama roof with power tilt/sliding panel caused by roof luggage rack

If the panorama roof with power tilt/sliding panel is opened when a roof luggage rack is installed, the panorama roof with power tilt/sliding panel may be damaged by the roof luggage rack.

- ▶ Do not open the panorama roof with power tilt/sliding panel if a roof luggage rack is installed.

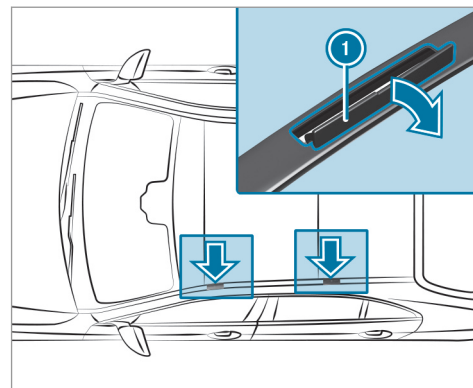

! **NOTE** Damage to the covers

The covers may be damaged and scratched when being opened.

- ▶ Do not use metallic or hard objects.

- ▶ Carefully fold covers ① upwards in the direction of the arrow.

- ▶ Secure the roof luggage rack to the fastening points beneath covers ①.
- ▶ Comply with the installation instructions of the roof luggage rack manufacturer.
- ▶ Secure the load on the roof luggage rack.

Cup holder

Installing the cup holder in or removing it from the center console

▲ WARNING - Risk of accident or injury when using the cup holder while the vehicle is moving

The cup holder cannot secure containers while the vehicle is moving.

If you use a cup holder while the vehicle is moving, the container may be flung around and liquids may be spilled. The vehicle occupants may come into contact with the liquid and if it is hot, they could be scalded. You could be distracted from traffic conditions and you may lose control of the vehicle.

- ▶ Only use the cup holder when the vehicle is stationary.
- ▶ Only use the cup holder for containers of the right size.
- ▶ Close the container, particularly if the liquid is hot.

▲ WARNING Risk of injury due to objects being stowed incorrectly

If objects in the vehicle interior are stowed incorrectly, they can slide or be thrown around and hit vehicle occupants. In addition, cup holders, open storage spaces and mobile phone brackets cannot always retain all objects they contain.

There is a risk of injury, particularly in the event of sudden braking or a sudden change in direction.

- ▶ Always stow objects in such a way that they cannot be thrown around in such situations.

- ▶ Always make sure that objects do not protrude from storage spaces, parcel nets or storage nets.
- ▶ Close the lockable storage spaces before starting a journey.
- ▶ Always stow and secure heavy, hard, pointed, sharp-edged, fragile or bulky objects in the trunk.

Requirements:

- For installation: the locking catch is pushed in the direction of the cup holder.

Installation

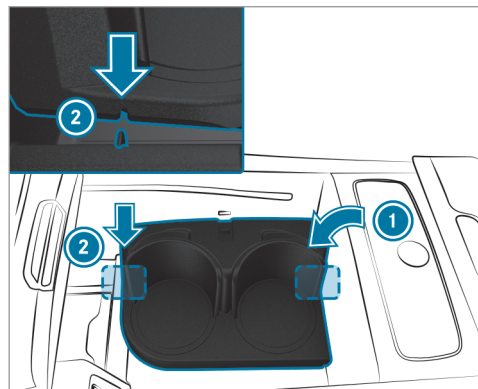

- ▶ Insert cup holder housing ① into the stowage compartment on a slight angle.
- ▶ Place cup holder housing ① with the recesses on the two hubs ② in the stowage compartment so that they fit.
- ▶ Push cup holder down.

Locking

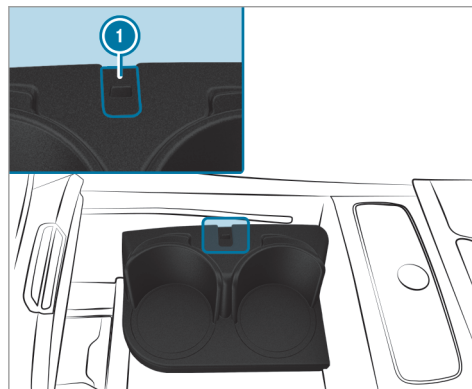

- ▶ Slide locking catch ① toward the side wall of the center console.
The cup holder is locked.

Removal

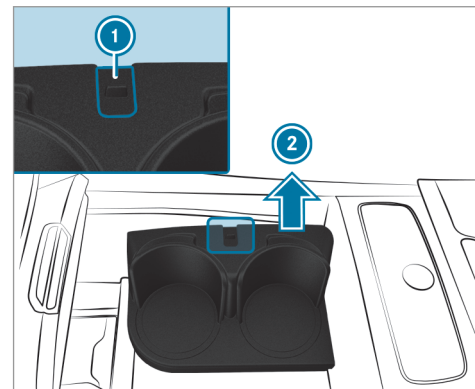

- ▶ Slide locking catch ① toward the cup holder.
The cup holder is unlocked.
- ▶ First pull the cup holder up in the direction of arrow ② and then twist it slightly to remove it from the stowage compartment.

Using the cup holder

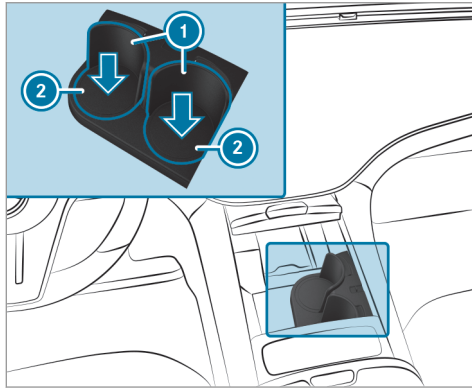

- ▶ Placing a beverage container in the cup holder. Base ② of the cup holder lowers automatically and the side walls ① of the cup holder move forward automatically.
- ⓘ The cup holder automatically adjusts to the size of the container placed in it.

The side walls of the cup holder can also be activated manually in different ways:

- Slightly press down the bottom with the beverage container.
 - Press the grooved surface on the side wall of the cup holder.
- ⓘ Check whether the beverage container is firmly held by the cup holder. Some beverage containers are not adequately secured in the cup holder due to their shape or size.

Original position

When the cup holder is not in use, the side walls of the cup holder can be retracted manually. The bracket arms of the cup holder are automatically retracted as well, and the cup holder's holding function will then no longer be available.

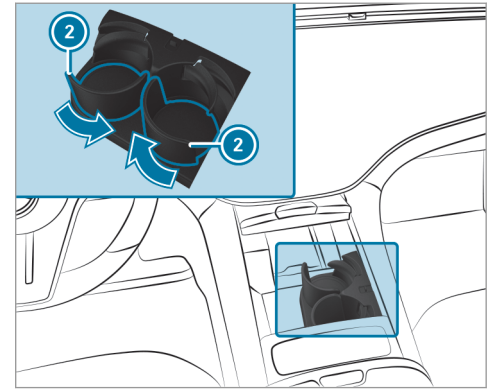

- ▶ Manually push back the side walls of cup holder ② in the direction of the arrow.

Sockets

Using the 12 V socket in the front passenger footwell

Requirements:

- Only connect devices up to a maximum of 180 W (15 A).

Depending on the vehicle equipment, the vehicle has a 12 V socket in the front passenger footwell.

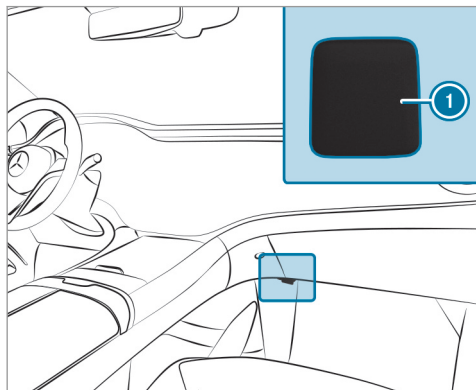

- ▶ Lift up socket cap ①.
- ▶ Insert the plug of the device.
- ▶ Make sure that no cables are running through or secured in the airbag deployment area when using the socket. Also observe the notes on airbag protection (→ page 51).

USB ports

Depending on its equipment, the vehicle has the following USB ports:

- In the storage compartment in the front center console
- In the storage compartment under the front armrest
- In front of the storage tray under the central display of the multimedia system
- In the electronics compartment in the center console of the rear passenger compartment

You can charge a USB device, such as a mobile phone, at the USB ports using a suitable charging cable. Depending on the vehicle equipment, the

devices can be charged with up to 20 V (5 A) when the vehicle is switched on.

Wireless charging of the mobile phone and connection with the exterior antenna

Notes on wirelessly charging the mobile phone

▲ WARNING Risk of injury due to objects being stowed incorrectly

If objects in the vehicle interior are stowed incorrectly, they can slide or be thrown around and hit vehicle occupants. In addition, cup holders, open stowage spaces and mobile phone receptacles cannot always retain all objects within.

There is a risk of injury, particularly in the event of sudden braking or a sudden change in direction.

- ▶ Always stow objects so that they cannot be thrown around in such situations.

- ▶ Always make sure that objects do not protrude from stowage spaces, parcel nets or stowage nets.
- ▶ Close the lockable stowage spaces before starting a journey.
- ▶ Always stow and secure heavy, hard, pointed, sharp-edged, fragile or bulky objects in the trunk/cargo compartment.

Observe the notes on loading the vehicle.

⚠ WARNING Risk of fire from placing objects in the mobile phone storage compartment

Placing other objects in the mobile phone storage compartment could constitute a fire hazard.

- ▶ Apart from a mobile phone, do not place any other objects in the mobile phone storage compartment, especially those made of metal.

! NOTE Damage to objects caused by placing them in the mobile phone storage compartment

If objects are placed in the mobile phone storage compartment, these may be damaged by electromagnetic fields.

- ▶ Do not place credit cards, storage media, ski passes or other objects sensitive to electromagnetic fields in the mobile phone storage compartment.

! NOTE Damage to the mobile phone stowage compartment caused by liquids

If liquids enter the mobile phone storage compartment, the compartment may be damaged.

- ▶ Ensure that no liquids enter the mobile phone stowage compartment.

Always observe the notes for persons with electronic medical aids (→ page 35).

- Depending on the vehicle equipment, the mobile phone is connected to the vehicle's exterior antenna via the charging module.
- The charging function and wireless connection of the mobile phone to the vehicle's exterior antenna are only available if the vehicle is switched on.
- Small mobile phones may not be able to be charged in every position of the mobile phone stowage compartment.
- Large mobile phones which do not rest flat in the mobile phone stowage compartment may not be able to be charged or connected with the vehicle's exterior antenna.
- The mobile phone may heat up during the charging process. This may also depend on the applications (apps) currently open in the background.
- To ensure more efficient charging and connection with the vehicle's exterior antenna, remove the protective cover from the mobile phone. Protective covers which are necessary for wireless charging are an exception.

Wirelessly charging a mobile phone in the front

Requirements:

- The mobile phone is suitable for wireless charging.

A list of compatible mobile phones can be found at: <https://www.mercedes-benz-mobile.com/>

Depending on the vehicle's equipment, the vehicle has the following options for wirelessly charging a mobile phone in the cockpit:

- In the front stowage compartment of the center console
- In the stowage compartment in the armrest

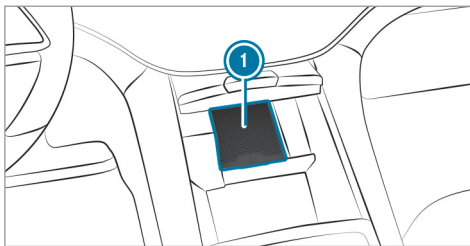

Example: wirelessly charging the mobile phone in the front stowage compartment (with MBUX Hyper-screen)

- ▶ Place the mobile phone as close to the center of mat ① as possible with the display facing upwards.

When a message is shown in the multimedia system, the mobile phone is being charged. In addition, malfunctions during the mobile phone's charging process are shown in the multimedia system display.

- ① The mat can be removed for cleaning, e.g. using clean, lukewarm water.

Wirelessly charging a mobile phone in the rear passenger compartment

Requirements:

- The mobile phone is suitable for wireless charging.

A list of compatible mobile phones can be found at: <https://www.mercedes-benz-mobile.com/>

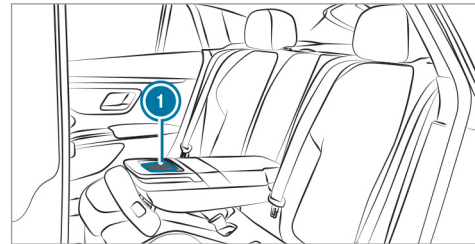

Wireless charging in the rear passenger compartment in vehicles without MBUX rear tablet

- ▶ Fold down the rear armrest.

- ▶ Place the mobile phone as close to the center of mat ① as possible with the display facing upwards. When the indicator lamp at the front of the mobile phone system lights up, the mobile phone is being charged. In addition, malfunctions during the mobile phone's charging process are shown by the indicator lamp flashing three times.

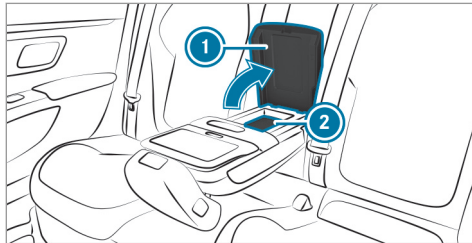

Wireless charging in the rear passenger compartment in vehicles with MBUX rear tablet

- ▶ Fold down the rear armrest.

- ▶ Open the stowage compartment in rear armrest ①.
- ▶ Place the mobile phone as close to the center of mat ② as possible with the display facing upwards. When the indicator lamp at the front of the mobile phone system lights up, the mobile phone is being charged. In addition, malfunctions during the mobile phone's charging process are shown by the indicator lamp flashing three times.

- ▶ **i** Observe the notes on loading the vehicle (→ page 119).

Installing and removing the floor mats

⚠ WARNING Risk of accident due to objects in the driver's footwell

Objects in the driver's footwell may impede pedal travel or block a depressed pedal.

This jeopardizes the operating and road safety of the vehicle.

- ▶ Stow all objects in the vehicle securely so that they cannot get into the driver's footwell.
- ▶ Always install the floor mats securely and as prescribed in order to ensure that there is always sufficient room for the pedals.
- ▶ Do not use loose floor mats and do not place floor mats on top of one another.

Installing floor mats

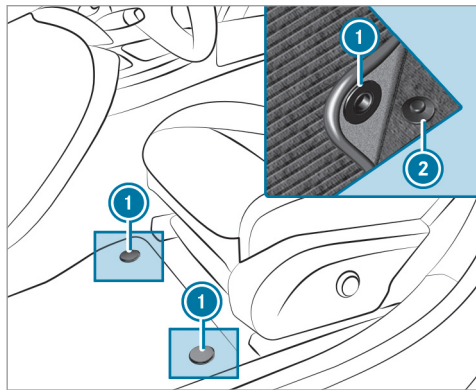

- ▶ Slide the corresponding seat backwards and lay the floor mat in the footwell with a positive fit.
- ▶ Press studs ① onto holders ②.
- ▶ Adjust the corresponding seat.

- ▶ Insert the remaining floor mats with a positive fit and, if available, attach them to the vehicle-specific securing system.

Removing floor mats

- ▶ Slide the corresponding seat backwards and pull the floor mat off holders ②.
- ▶ Adjust the corresponding seat.
- ▶ Loosen and remove the remaining floor mats from the vehicle-specific securing system, if present.

Exterior lighting

Information about lighting systems and your responsibility

The various lighting systems of the vehicle are only aids. The driver of the vehicle is responsible for correct vehicle illumination in accordance with the prevailing light and visibility conditions, legal requirements and traffic situation.

Light switch

Operating the light switch

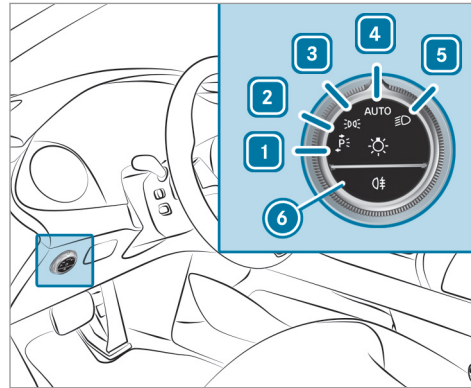

- 1 Left-hand standing lights
- 2 Right-hand standing lights
- 3 Parking lights and license plate lamp
- 4 **AUTO** Automatic driving lights (preferred light switch position)

- 5 Low beam/high beam
- 6 Switches the rear fog light on/off

When low beam is activated, the indicator lamp for the parking lights will be deactivated and replaced by the low-beam indicator lamp.

▶ Always park your vehicle safely using sufficient lighting, in accordance with the relevant legal stipulations.

! **NOTE** Battery discharging by operating the standing lights

Operating the standing lights over a period of hours puts a strain on the battery.

▶ Where possible, switch on the right or left parking light.

If the battery is insufficiently charged, the standing lights or parking lights will be switched off automatically to facilitate the next engine start.

144 Light and visibility

The exterior lighting (except standing and parking lights) will switch off automatically when the driver's door is opened.

- Observe the notes on surround lighting (→ page 154).

Automatic driving lights function

When the vehicle is switched on, the parking lamps, low beam and daytime running lamps are switched on automatically depending on the ambient light.

⚠ WARNING Risk of accident when the low beam is switched off in poor visibility



When the light switch is set to **AUTO**, the low beam may not be switched on automatically if there is fog, snow or other causes of poor visibility such as spray.

- ▶ In such cases, turn the light switch to .

The automatic driving lights are only an aid. You are responsible for vehicle lighting.

Switching the rear fog lights on or off

Requirements:

- The light switch is in the  or **AUTO** position.
- ▶ Press the  button.

Please observe the country-specific laws on the use of rear fog lamps.

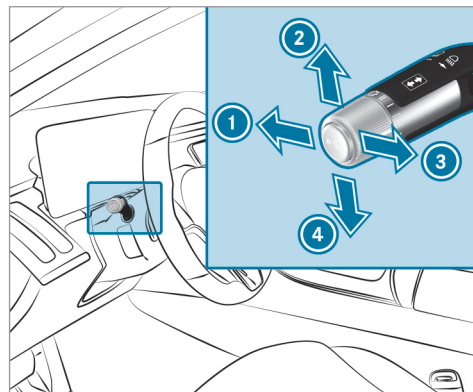

Operating the combination switch for the lights



- 1 High beam
- 2 Turn signal light, right
- 3 High-beam flasher
- 4 Turn signal light, left

- ▶ Use the combination switch to activate the desired function.

Switching on high beam

- ▶ Turn the light switch to the  or **AUTO** position.
- ▶ Push the combination switch in the direction of arrow ①.
When the high beam is activated, the  indicator lamp for low beam will be deactivated and replaced by the  indicator lamp for high beam.

Switching off high beam

- ▶ Push the combination switch in the direction of arrow ① or pull it in the direction of arrow ③.

High-beam flasher

- ▶ Pull the combination switch in the direction of arrow ③.

Turn signal light

- ▶ **To indicate briefly:** push the combination switch briefly to the point of resistance in the direction of arrow ② or ④.
The corresponding turn signal light will flash three times.

▶ **To indicate continuously:** push the combination switch beyond the point of resistance in the direction of arrow ② or ④.

Vehicles with Active Lane Change Assist:

- A turn signal indicator activated by the driver may continue to operate for the duration of the lane change.
- If the driver indicated directly beforehand but a lane change was not immediately possible, the turn signal indicator may activate automatically.

Activating/deactivating the hazard warning lights

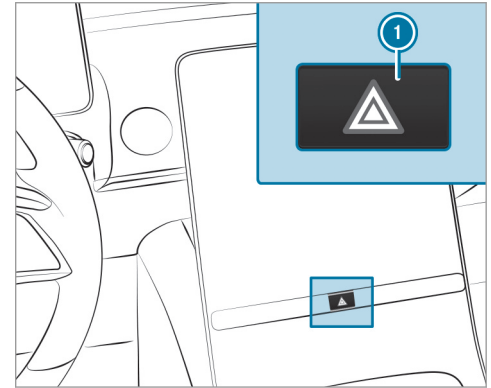

Vehicles without MBUX Hyperscreen

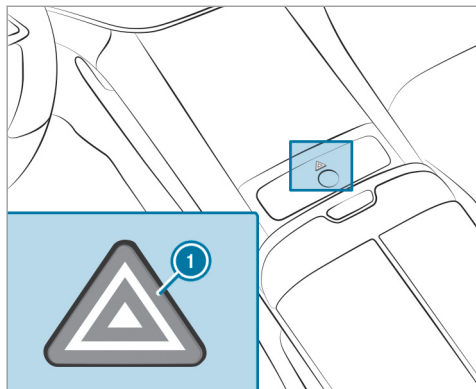

Vehicles with MBUX Hyperscreen

▶ Press button ①.

The hazard warning lights will switch on automatically if:

- The airbag has been deployed.

Adaptive functions of the DIGITAL LIGHT

Intelligent Light System function

In this system, the headlamps adapt to the driving and weather situation. It also provides extended functions for improved illumination of the road.

① The availability of the functions is dependent on the country.

The system comprises the following functions:

- Active headlamps (→ page 146)
- Cornering light (→ page 147)
- Highway mode (→ page 147)
- Enhanced fog light function (→ page 147)
- Bad weather light (→ page 148)
- City lighting (→ page 148)
- Topographical compensation (vehicles with DIGITAL LIGHT) (→ page 148)

The system is active only when it is dark.

Active headlamps function

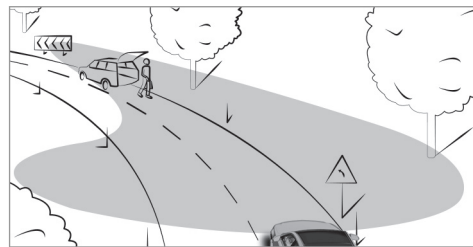

- The headlamps follow the steering movements.
- Relevant areas are better illuminated during a journey.

The functions are active when the low beam is switched on.

Depending on the vehicle's equipment, the course of the lane in which you are driving will also be evaluated and the active headlamps function will adjust the light in advance.

Cornering light function

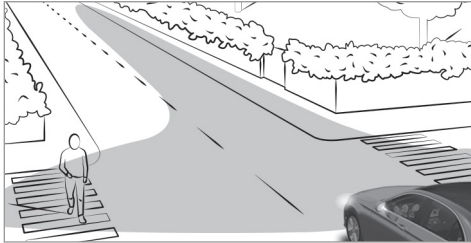

The cornering light improves the illumination of the road over a wide angle in the turning direction, enabling better visibility on tight curves, for example. It can be activated only when the low beam is switched on.

The function is active in the following cases:

- At speeds below 25 mph (40 km/h) when the turn signal light is switched on or the steering wheel is turned
- At speeds between 25 mph (40 km/h) and 43 mph (70 km/h) and when the steering wheel is turned

Roundabout and intersection function: the cornering light will be activated on both sides based on an evaluation of the vehicle's current navigation position. It will remain active until after the vehicle has left the roundabout or the intersection.

Highway mode function (Canada)

Highway mode increases the range and brightness of the cone of light, enabling better visibility.

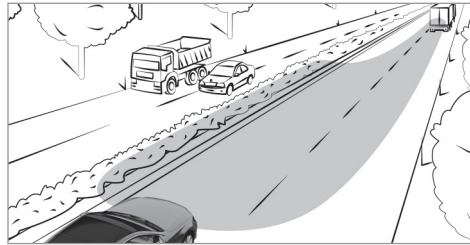

The function will be active if a freeway journey is detected by means of:

- The vehicle's speed
- The multifunction camera
- The navigation system

The function is not active in the following cases:

- at speeds below 50 mph (80 km/h)

Enhanced fog light function (Canada)

The enhanced fog light function reduces self-blinding and improves the illumination of the edge of the road.

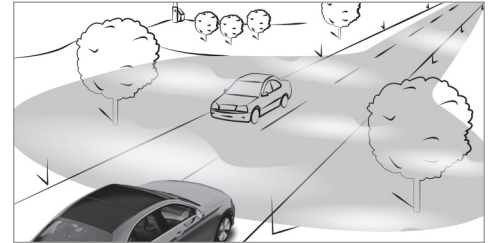

The function is automatically activated under the following conditions:

- At speeds below 43 mph (70 km/h) and when the rear fog light is switched on.

The function is automatically deactivated under the following conditions:

- When speeds greater than 62 mph (100 km/h) are reached.
- When the rear fog light is switched off.

Function of the bad weather light (Canada)

The bad weather light reduces reflections in rainy conditions by dimming individual areas of the headlamps. The driver and other road users are blinded less as a result.

The city lighting function (Canada)

City lighting improves the illumination of roadsides in urban areas using a broad distribution of light.

The function is active in the following cases:

- At low speeds
- In illuminated parts of urban areas

Function of the topographical compensation

Based on map data, the lighting system responds pre-emptively to different road heights. This means that the headlamp range remains virtually constant when you are driving on uphill or downhill gradients.

- ① Only vehicles with a multimedia system with navigation have this function.

Assistance functions of the DIGITAL LIGHT

DIGITAL LIGHT visually expands on the driver assistance systems by projecting the assistant displays in front of the vehicle while it is in motion. DIGITAL LIGHT can therefore help the driver in critical situations.

- ① The availability of the functions is dependent on the country.

The system is active in the following cases:

- The light switch is in the **AUTO** position.
- The high beam is switched on.

- ① Depending on the country in which you are currently driving, certain functions may be disabled due to different legal requirements, even if they are enabled in the multimedia system. When a border is crossed, the vehicle will automatically adapt to the valid requirements.

Spotlight

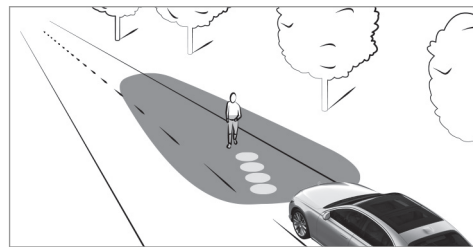

The spotlight function runs in the background and flashes the headlamps at detected persons within the lane markings in four short bursts. The driver is also made aware of the position of the person by a symbol projection.

The function is active under the following conditions:

- You are driving outside illuminated areas.
- The system detects a lane marking.

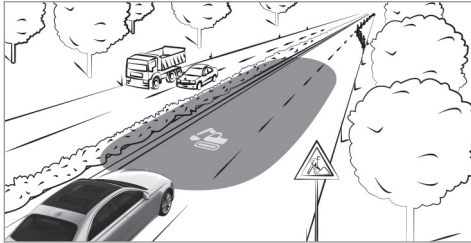
Notes

If Traffic Sign Assist detects a roadworks zone, the system will provide support as follows:

- A corresponding symbol will be projected onto the road when you enter a roadworks zone.

Observe the system limits of Traffic Sign Assist (→ page 246).

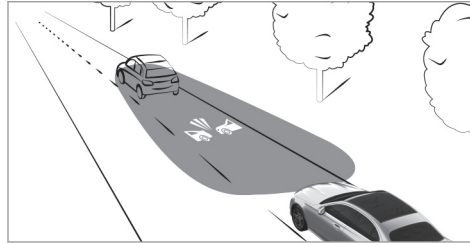
Collision warning

If you fall below the safe distance at speeds of at least 19 mph (30 km/h), a collision warning symbol will be projected onto the road.

Observe the system limitations of Active Brake Assist (→ page 242).

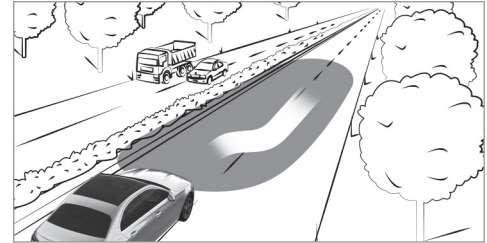
Lane change warning

During assisted lane changes at speeds of at least 19 mph (30 km/h), the course of the lane change will be brightened. This enables you to identify possible dangers in the new lane at an early stage.

Observe the system limitations of Active Lane Change Assist (→ page 239).

Lane keeping and blind spot warning

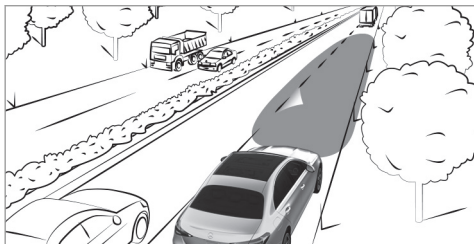

At speeds of at least 19 mph (30 km/h), a triangle that indicates a lane correction and its direction will be projected onto the road in the following cases:

- The lane is left unintentionally.
Observe the system limitations of Active Lane Keeping Assist (→ page 255).
- You switch on the turn signal light while an object or obstacle is in your blind spot.
Observe the system limitations of Active Blind Spot Assist (→ page 252).

Switching the Intelligent Light System on/off

Requirements:

- The vehicle is switched on.

Multimedia system:

→  **▶▶ Settings ▶▶ Light**
▶▶ DIGITAL LIGHT

- ▶ Activate or deactivate **Dynamic Low Beam**.

Activating or deactivating enhanced assistance functions

- ⓘ The availability of the functions is dependent on the country.
- ⓘ This function is an on-demand feature (→ page 29).
- ▶ Select **Supporting Projections**.
- ▶ Activate or deactivate the desired projection.
- ▶ Activate or deactivate **Projection when opening/closing**.
If the locator lighting or the exterior switch-off delay time is activated, a high-resolution greeting or farewell scene will be played back for a short period of time when the vehicle is

opened or locked. You can choose between the **Digital Rain** and **Flowing Lines** sequences.

- ⓘ More information on locator lighting (→ page 154)
More information on the exterior switch-off delay time (→ page 153)

Adaptive Highbeam Assist

Adaptive Highbeam Assist function

⚠ WARNING Risk of accident despite Adaptive Highbeam Assist

Adaptive Highbeam Assist does not react to:

- Road users without lights, e.g. pedestrians
- Road users with poor lighting, e.g. cyclists
- Road users whose lighting is obstructed, e.g. by a barrier

On very rare occasions, Adaptive Highbeam Assist may fail to recognize other road users with their own lighting, or may recognize them too late.

In these, or in similar situations, the automatic high beam will not be deactivated or will be activated despite the presence of other road users.

- ▶ Always observe the road and traffic conditions carefully and switch off the high beam in good time.

Adaptive Highbeam Assist cannot take into account road, weather or traffic conditions.

Detection may be restricted in the following cases:

- In poor visibility, e.g. fog, heavy rain or snow
- If there is dirt on the sensors or the sensors are obscured

Adaptive Highbeam Assist is only an aid. You are responsible for adjusting the vehicle's lighting to the prevailing light, visibility and traffic conditions.

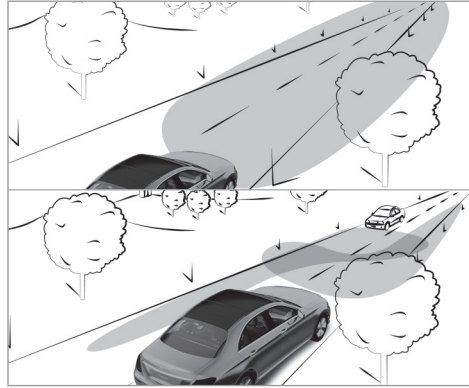

Adaptive Highbeam Assist automatically switches between the following types of light:

- Low beam
- High beam

At speeds greater than 19 mph (30 km/h):

- If no other road users are detected, the high beam will switch on automatically.

The high beam will switch off automatically in the following cases:

- At speeds below 16 mph (25 km/h)
- If other road users are detected
- If street lighting is sufficient

i The system's optical sensor is located behind the windshield near the overhead control panel.

Switching Adaptive Highbeam Assist on/off

Switching on

- ▶ Turn the light switch to the **AUTO** position.
- ▶ Switch on the high beam using the combination switch.
If Adaptive Highbeam Assist is activated, the  indicator lamp will light up on the driver display.

Switching off

- ▶ Switch off the high beam using the combination switch.

Adaptive Highbeam Assist Plus

Adaptive Highbeam Assist Plus function (Canada)

⚠ WARNING Risk of accident despite Adaptive Highbeam Assist Plus

Adaptive Highbeam Assist Plus does not react to:

- Road users without lights, e.g. pedestrians
- Road users with poor lighting, e.g. cyclists
- Road users whose lighting is obstructed, e.g. by a barrier

On very rare occasions, Adaptive Highbeam Assist Plus may fail to recognize other road users with their own lighting, or may recognize them too late.

In these, or in similar situations, the automatic high beam will not be deactivated or will be activated despite the presence of other road users.

- ▶ Always observe the road and traffic conditions carefully and switch off the high beam in good time.

Adaptive Highbeam Assist Plus cannot take into account road, weather or traffic conditions.

Detection may be restricted in the following cases:

- In poor visibility, e.g. fog, heavy rain or snow
- If there is dirt on the sensors or the sensors are obscured

Adaptive Highbeam Assist Plus is only an aid. You are responsible for adjusting the vehicle's lighting to the prevailing light, visibility and traffic conditions.



Adaptive Highbeam Assist Plus automatically switches between the following types of light:

- Low beam
- Partial high beam
- High beam
- ULTRA RANGE Highbeam

ULTRA RANGE Highbeam increases the brightness of the cone of light to the legally permitted maximum.

Partial high beam does not include other road users in the high beam area. It does not blind them but enables full high beam illumination for the driver apart from the excluded vehicles.

At speeds below 16 mph (25 km/h) or when there is sufficient street lighting:

- The partial high beam and the high beam will be switched off automatically.

At speeds greater than 19 mph (30 km/h):

- If no other road users are detected, the high beam will switch on automatically.
- If other road users are detected, the partial high beam will switch on automatically.

At speeds above 25 mph (40 km/h):

- If no other road users are detected on a straight road, ULTRA RANGE Highbeam will be switched on automatically.
- If other road users are detected, the partial high beam will switch on automatically.

- If highly reflective signs are detected, ULTRA RANGE Highbeam will be switched off automatically.

- ① The system's optical sensor is located behind the windshield near the overhead control panel.

Switching Adaptive Highbeam Assist Plus on/off (Canada)

Switching on

- ▶ Turn the light switch to the **AUTO** position.
- ▶ Switch on the high beam using the combination switch.
If Adaptive Highbeam Assist Plus is activated, the  indicator lamp will light up on the driver display. When partial high beam or high beam is active, the corresponding blue indicator lamp will also light up.

Switching off

- ▶ Switch off the high beam using the combination switch.

Switching the daytime running lights on/off

Multimedia system:

  **▶▶ Settings ▶▶ Light**
▶▶ DIGITAL LIGHT



- ▶ Switch the **Daytime Running Lights** on or off.

- ① In vehicles without DIGITAL LIGHT headlamps, the daytime running lights can be switched on or off in the **Driving Lights** menu.

- ① The availability of the function is dependent on the country.

Setting the exterior lighting switch-off delay time

Multimedia system:

  **▶▶ Settings ▶▶ Light**
▶▶ Interior/exterior lighting
▶▶ External Lighting Delay

- ▶ Set the switch-off delay time.
When the vehicle's engine is switched off, the exterior lighting will be activated for the set time.

Activating/deactivating the locator lighting

Multimedia system:

→  → Settings → Light

→ Interior/Exterior Lighting



▶ Activate or deactivate **Locator Lighting**.

When the function is activated, the exterior lighting will light up for 40 seconds after the vehicle is unlocked. When you start the vehicle, the locator lighting is switched off and automatic driving lights are activated.

Interior lighting

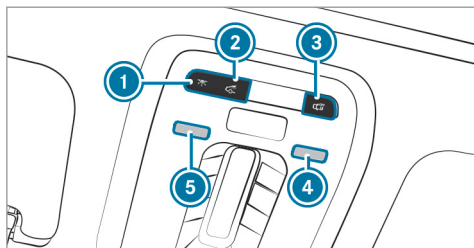
Adjusting the interior lighting





- ①  Switches the front interior lighting on/off
- ②  Switches the rear interior lighting on/off
- ③  Switches automatic interior lighting control on/off

▶ **To switch reading lamps on/off:** hold your hand under the respective reading lamp ④ or ⑤.

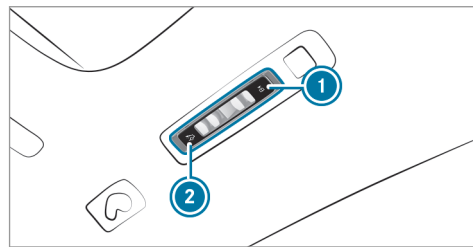
Control panel in the rear passenger compartment



- ①  Reading lamp on the respective side of the vehicle
- ②  Rear interior lighting

▶ **To switch reading lamps on:** press button ①. The reading lamp, the interior lighting above the rear door and the dome lamp on the respective side of the vehicle will light up.

▶ **To switch reading lamps off:** press button ① once or twice.

After pressing it once, the interior lighting above the rear door and the dome lamp on the respective side of the vehicle will go out.

After pressing it twice, the reading lamp on the respective side of the vehicle will go out.

- ▶ **To switch the rear interior lighting on/off:** press button ②.

The reading lamps, the interior lighting above the rear door and the dome lamps on both sides of the vehicle will light up or go out.

Adjusting the ambient lighting

Multimedia system:

-  ▶▶ Settings ▶▶ Comfort
- ▶▶ Ambient Lighting

Setting the color

- ▶ Select **Color**.
- ▶ Select **Monochrome** or **Multi-color**.
- ▶ Set the desired color or color scheme.

Energy Shine

- The interactive Energy Shine color world shows the different phases during the journey. Depending on the type of driving condition (speed, boost effect or recuperation), this is shown in color by the active ambient lighting.

Adjusting the brightness

- ▶ Select **Brightness**.
- ▶ Adjust the brightness.
- ① Depending on the ambient light, the ambient lighting will automatically switch between day and night modes.

Activating the brightness for zones

- ▶ Select **Brightness**.
- ▶ Switch off **Link Zones** .
The **Direct**, **Indirect** and **Accents** zones can be set separately.
- ① The **Light Band** zone can also be set in vehicles with active ambient lighting.

Activating effects

⚠ WARNING Risk of an accident despite activated effects of ambient lighting and active ambient lighting

To use the Warning Assistance effects, the respective functions must be activated in the driver assist menu.

- ▶ Make sure that the functions and assists are switched on.

- ① Observe the notes on driving systems and your responsibility; you may otherwise fail to recognize dangers (→ page 217).

- ▶ Select **Effects**.
- ▶ Activate the desired effect.
- ① Depending on the vehicle equipment, different effects are available.

Operating feedback effects

- **Climate:** If changes are made to the temperature setting in the vehicle, the color of the ambient lighting will change briefly.
- **Voice Assistant:** For vehicles with active ambient lighting, the voice assistant is visually animated.

Warning assistance effects

- **Warning When Exiting:** If an object is detected in the blind spot while you are getting out of the vehicle, the ambient lighting in the affected door will flash red.

Further information on the exit warning (→ page 252).

- **Active Lane Keeping Assist:** If there is a warning from Active Lane Keeping Assist, the active ambient lighting will flash red.

Further information on Active Lane Keeping Assist (→ page 255).

- **Active Brake Assist:** If there is an Active Brake Assist warning, the active ambient lighting in the center of the cockpit will flash bright red.

Further information on the Active Brake Assist (→ page 242).

- **Active Blind Spot Assist:** In vehicles with active ambient lighting, the ambient lighting on the affected side will flash red if there is a warning from Active Blind Spot Assist.

Further information on the Active Blind Spot Assist (→ page 252).

- Parking Assist **PARKTRONIC:** The information from the parking sensors during parking maneuver is displayed in color.

Further information on Parking Assist **PARKTRONIC:** (→ page 266)

Greeting

- When you get into the vehicle, a special color animation will play.

Multi-color Animation

- The chosen color combination will change at predefined intervals.

- ① In vehicles with active ambient lighting, an animation will be played.
- ① The desired operating feedback and warning assistance can be activated or deactivated via the  symbol. Depending on the equipment, different operating feedback and warning assistance effects are available.
- ① If the brightness is set to a low level, warning animations will be displayed at a higher basic brightness.

Switching the interior lighting switch-off delay time on/off

Multimedia system:

- ➔  ➔ Settings ➔ Light
- ➔ Interior/exterior lighting
- ➔ Interior Lighting Delay



- ▶ Switch **Interior Lighting Delay** on or off. When this function is active, the interior lighting will light up for a short time after the vehicle is locked.

Windshield wiper and windshield washer system

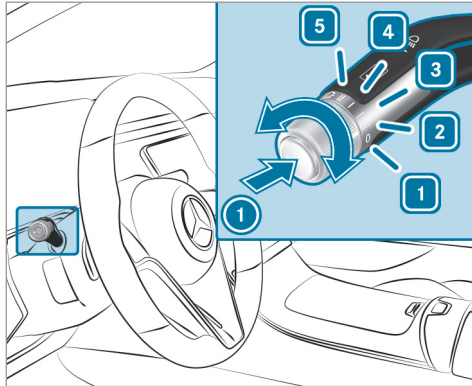
Switching the windshield wipers on/off



- 1 0 Windshield wipers off
- 2 ... Automatic wiping, normal
- 3 Automatic wiping, frequent
- 4 — Continuous wiping, slow
- 5 == Continuous wiping, fast

- ▶ Turn the combination switch to the corresponding position 1 - 5.
- ▶ **Single wipe/washing:** push the button on the combination switch in the direction of arrow
 - ① .
 -  Single wipe
 -  Wiping with washer fluid
- ① Observe the notes on washing the vehicle in a car wash (→ page 356).

Replacing the windshield wiper blades

⚠ WARNING Risk of becoming trapped if the windshield wipers are switched on while wiper blades are being replaced

If the windshield wipers begin to move while you are changing the wiper blades, you can be trapped by the wiper arm.

- ▶ Always switch off the windshield wipers and vehicle before changing the wiper blades.

Moving the wiper arms into the replacement position

- ▶ Switch the vehicle on and then off again immediately.
- ▶ Within around 15 seconds, press the  button on the combination switch for approximately three seconds (→ page 157). The wiper arms will move into the replacement position.

Removing the wiper blades

- ▶ Fold the wiper arms away from the windshield.

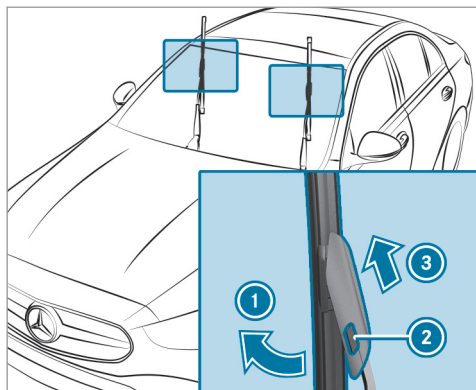

- ▶ Hold the wiper arm with one hand. With the other hand, turn the wiper blade away from the wiper arm in the direction of arrow ① as far as it will go.
- ▶ Press release knob ②.
- ▶ Remove the wiper blade from the wiper arm in the direction of arrow ③.

Installing the wiper blades

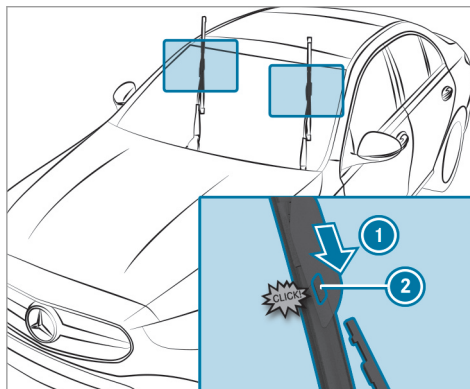

- ▶ Push the new wiper blade into the wiper arm in the direction of arrow ① until release knob ② engages.
- ▶ Make sure that the wiper blade is seated correctly.
- ▶ Fold the wiper arms back onto the windshield.
- ▶ Switch on the vehicle.

- ▶ Press the  button on the combination switch. The wiper arms will return to their original positions.
- ▶ Switch off the vehicle.

- ⓘ Check the condition of the wiper blades regularly and replace them in the event of visible damage or ongoing smearing.

Maintenance display

There is a maintenance display at the tip of the newly mounted wiper blade.

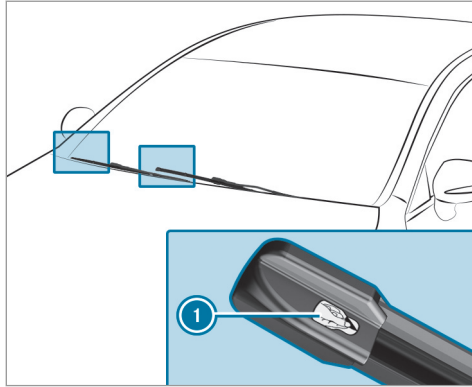

- ▶ Remove protective film ❶ from the maintenance display.

When the color of the maintenance display changes from black to yellow, the wiper blades should be replaced.

Mirrors

Operating the outside mirrors

- ⚠ **WARNING** Risk of accident due to adjusting the vehicle settings while the vehicle is in motion

You could lose control of the vehicle in the following situations in particular:

- If you adjust the driver's seat, the head restraint, the steering wheel or the mirror while the vehicle is in motion
 - If you fasten your seat belt while the vehicle is in motion
- ▶ Before starting the vehicle: in particular, adjust the driver's seat, head restraint, steering wheel and mirror, and fasten your seat belt.

- ⚠ **WARNING** Risk of accident due to misjudgment of distance when using the front-passenger mirror

The outside mirror on the front passenger side reflects objects on a smaller scale. The objects in view are in fact closer than they appear.

- ▶ Therefore, always look over your shoulder to check the actual distance between you and the road users traveling behind you.

Adjusting the outside mirrors

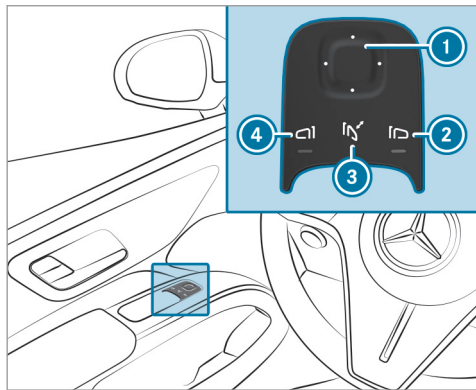

- ▶ Use button ② or ④ to select the desired mirror.

ⓘ In vehicles with MBUX Interior Assistant and driver camera, the required outside mirror can also be preselected automatically via a natural head movement to the left or right (→ page 309).

- ▶ Use button ① to adjust the position of the selected mirror.

Folding the outside mirrors in/out

- ▶ Briefly press button ③.
- ⓘ If the battery has been disconnected or has discharged, the outside mirrors must be moved briefly using button ③. Only then will the automatic mirror folding function work properly.

Engaging the outside mirrors

If an outside mirror has been forcibly disengaged, proceed as follows.

- ▶ Press and hold button ③. You will hear a click and the mirror will audibly engage. The outside mirror will now be set to the correct position.

Automatic anti-glare mirrors function

⚠ WARNING Risk of acid burns and poisoning due to the anti-glare mirror electrolyte

Electrolyte may escape if the glass in an automatic anti-glare mirror breaks.

The electrolyte is hazardous to health and causes irritation. It must not come into contact with your skin, eyes, respiratory organs or clothing or be swallowed.

- ▶ If you come into contact with electrolyte, observe the following:
 - Immediately rinse the electrolyte from your skin with water and seek medical attention.
 - If electrolyte comes into contact with your eyes, immediately rinse them thoroughly with clean water and seek medical attention.
 - If the electrolyte is swallowed, immediately rinse your mouth out thoroughly. Do not induce vomiting. Seek medical attention immediately.

- Immediately change out of clothing which has been contaminated with electrolyte.
- If an allergic reaction occurs, seek medical attention immediately.

The inside rearview mirror and the outside mirror on the driver's side will automatically go into anti-glare mode if light from a headlamp hits the sensor on the inside rearview mirror.

System limits

The system will not go into anti-glare mode if:

- The vehicle is switched off.
- Reverse gear is engaged.
- The interior lighting is switched on.

Front-passenger outside mirror parking position function

The parking position makes parking easier.

The front-passenger outside mirror will swivel downwards in the direction of the rear wheel on the front passenger's side when:

- The parking position is stored (→ page 161).
- The front-passenger mirror is selected.
- Reverse gear is engaged.

The front-passenger outside mirror will move back to its original position when:

- You shift the transmission to another transmission position.
- You are traveling at a speed greater than 9 mph (15 km/h).
- You press the button for the outside mirror on the driver's side.

Storing the parking position of the front-passenger outside mirror using reverse gear

Storing

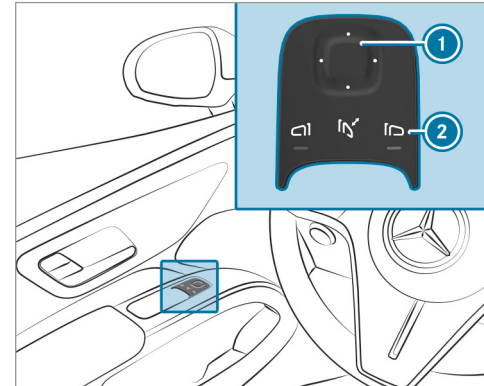

- ▶ Select the front-passenger outside mirror using button ②.
- ▶ Engage reverse gear.
- ▶ Move the front-passenger outside mirror into the desired parking position using button ①.

Calling up

- ▶ Select the front-passenger outside mirror using button ②.
- ▶ Engage reverse gear.
The front-passenger outside mirror will move into the stored parking position.

Activating/deactivating the automatic mirror folding function

Multimedia system:

- ▶  ▶ Settings ▶ Vehicle
- ▶ Opening/closing
- ▶ Switch **Automatic Mirror Folding** on or off.

Area permeable to radio waves on the windshield

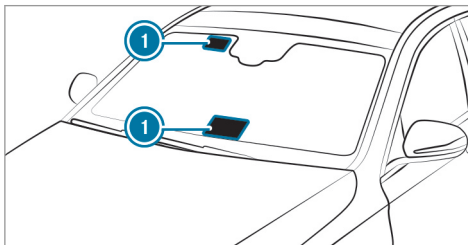

Radio-controlled equipment, such as toll systems, can be mounted only on areas ① of the windshield that are permeable to radio waves.

Areas permeable to radio waves ① are best visible from outside the vehicle when the windshield is illuminated with an external light source.

Note this position for vehicles with:

- Windshield heating
- Infrared reflective windshield

Infrared-reflective windshield function

The infrared-reflective windshield is coated and reduces the build-up of heat in the vehicle interior. The coating shields the vehicle interior from radio waves.

Overview of climate control systems

Notes on climate control

An interior air filter in combination with the prefilter in the engine compartment must always be used so that the air conditioning system, pollution level monitoring and the air filtration work correctly. Use filters recommended and approved by Mercedes-Benz. Always have maintenance work carried out at a qualified specialist workshop.

Overview of the climate bar for automatic climate control

The indicator lamps indicate that the corresponding function is activated.

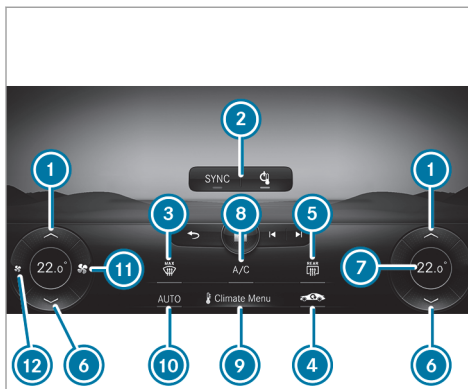

Front climate bar on the central display in vehicles without a HEPA filter (example)

- ① Increases the temperature
 - ② Upper display area of the climate bar with the examples of switching climate control on/off (→ page 166) and **SYNC** synchronization function (→ page 169)
 - ③ Defrosts the windshield (→ page 167)
 - ④ **A/C** Switches the A/C function on/off (→ page 167) or Fine particle prefilter status display (→ page 166)
 - ⑤ Switches the rear window heater on/off
 - ⑥ Reduces the temperature
 - ⑦ Depending on vehicle equipment and settings: temperature display, defrost function display, airflow, pre-entry climate control or ECO mode
 - ⑧ Switches air-recirculation mode on/off (→ page 170, 169)
 - ⑨ Calls up the air conditioning menu (→ page 166)
 - ⑩ **AUTO** Sets climate control to automatic mode (→ page 167)
 - ⑪ Increases the airflow or switches on climate control (→ page 166)
 - ⑫ Reduces the airflow or switches off climate control (→ page 166)
- ⓘ The climate bar is visible even when the vehicle is parked or the air conditioning is switched off (→ page 166).

- i** The availability of individual functions is country and equipment-dependent.

Overview of the climate bar for 3-zone automatic climate control

The indicator lamps indicate that the corresponding function is activated.

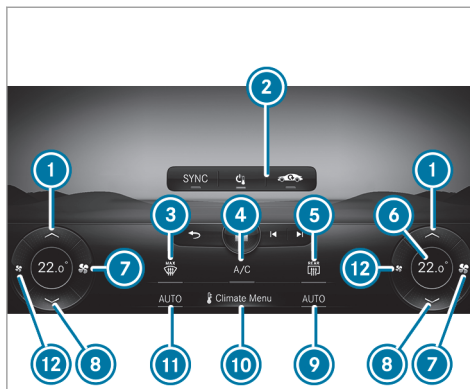

Front climate bar on the central display in vehicles without a HEPA filter (example)

- 1** Increases the temperature
- 2** Upper display area of the climate bar with the examples of switching off climate control (→ page 166), switching air-recirculation mode on/off (→ page 170, 169) and **SYNC** synchronization function (→ page 169)
- 3** Defrosts the windshield

- 4** Switches the A/C function on/off (→ page 167) or Fine particle prefilter status display (→ page 166)
 - 5** Switches the rear window heater on/off
 - 6** Depending on vehicle equipment and settings: temperature display, pre-entry climate control display or Eco mode
 - 7** Increases the airflow or switches on climate control (→ page 166)
 - 8** Reduces the temperature
 - 9** **AUTO** Sets climate control to automatic mode, right (→ page 167)
 - 10** Calls up the air conditioning menu (→ page 166)
 - 11** **AUTO** Sets climate control to automatic mode, left (→ page 167)
 - 12** Reduces the airflow or switches off climate control (→ page 166)
- i** The climate bar is visible even when the vehicle is parked or the air conditioning is switched off (→ page 166).

- i** The availability of individual functions is country and equipment-dependent.

Overview of the rear operating unit

The rear operating unit is available only for vehicles with the control panel for 3-zone automatic climate control.

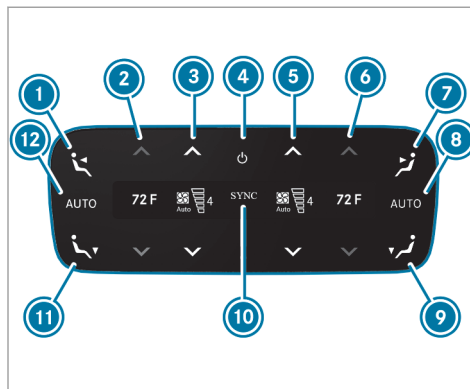

Example: USA

- ① Sets air distribution to the center and side air vents in the rear passenger compartment, left
- ② Sets the temperature in the rear passenger compartment, left
- ③ Sets the airflow in the rear passenger compartment, left, or switches climate control on/off (→ page 166)

- ④ Switches climate control on/off (→ page 166)
- ⑤ Sets the airflow in the rear passenger compartment, right, or switches climate control on/off (→ page 166)
- ⑥ Sets the temperature in the rear passenger compartment, right
- ⑦ Sets air distribution to the center and side air vents in the rear passenger compartment, right
- ⑧ Sets rear climate control to automatic mode, right
- ⑨ Sets the air distribution to the rear right footwell vents
- ⑩ Synchronization is activated (→ page 169)
- ⑪ Sets the air distribution to the rear left footwell vents
- ⑫ Sets rear climate control to automatic mode, left

The settings for the second row of seats can be configured via the rear operating unit or the multimedia system (→ page 168) depending on the vehicle's equipment.

Operating the climate control system

Switching climate control on/off

Switching on climate control

▶ Set the airflow to level 1 or higher via  on the climate bar on the central display

or

▶ Press **AUTO**, ,  or .

Switching off climate control

▶ Set the airflow to level 0 via  on the climate bar on the central display

or

▶ Press .

If climate control is switched off, the windows may fog up more quickly. Switch climate control off only briefly.

- ① If the climate control is switched off via , **OFF** will be shown on the climate bar.
- ① When the range maximization function is activated, certain climate control functions are restricted and the window and mirror heaters are switched off. This can lead to windows fogging up and reduced visibility due to

weather conditions. To quickly reactivate the climate control functions, press the  button on the climate bar on the central display.

Switching climate control on/off via the rear operating unit

Switching on

▶ Press button .

or

▶ Set the airflow to level 1 or higher using buttons  and .



or

▶ Press buttons , ,  or .

Switching off

▶ Press button .

or

▶ Set the airflow to level 0 using buttons  and .

- ① If rear climate control is switched off via button , **OFF** will be shown on the rear display.

Activating/deactivating the A/C function via the climate bar

The A/C function heats, cools and dehumidifies the vehicle's interior air.

▶ Press **A/C** on the climate bar on the central display.

- ① Switch off the A/C function only briefly; otherwise, the windows may fog up more quickly. Condensation may drip from the underside of the vehicle when cooling mode is active. This is not indicative of a malfunction.

Calling up the air conditioning menu using the climate bar

The air conditioning menu can be called up via the air conditioning line. The air conditioning line is always shown on the lower edge of the central display.

- ▶ Select the **Climate Menu** entry in the air conditioning line.
The **First Row of Seats** menu is opened.

Jumping directly to the **Air Quality** menu



- ▶ Select the  particulate pre-filter status display in the climate bar. The **Air Quality** menu is opened. An animation of the automatic air cleaning taking place is shown.
- ⓘ The particulate pre-filter status display is on the home screen next to the temperature display on the right and it informs you of the current particulate levels inside and outside of the vehicle. The measurement values are shown with the $\mu\text{g}/\text{m}^3$ units (micrograms per cubic meter).

Defrosting the windshield via the climate bar

Switching on

- ▶ Press  on the climate bar on the central display.

Switching off

- ▶ Press , **AUTO** or  on the climate bar on the central display

or

- ▶ set the airflow to 0.

- ⓘ When the defrost function is activated, some functions (e.g. the temperature setting) are automatically deactivated.

Activating/deactivating the A/C function via the air conditioning menu

Multimedia system:



↳ **Climate Menu** ▶ **First Row of Seats**

Depending on the external conditions, improved cooling and dehumidification of the interior air are supported when the A/C function is activated. If it is not possible to operate the A/C function on the climate bar on the central display, this function can be switched on and off on the climate menu on the central display.

- ▶ Select **A/C** (A/C).

Setting climate control to automatic mode via the climate bar

In automatic mode, the set vehicle interior temperature is controlled automatically and maintained at a constant level by the air supply.

- ▶ Press **AUTO** on the climate bar on the central display.
- ⓘ You can increase or reduce the airflow by pressing  on the climate bar on the central display.
- ▶ **To switch to manual operation:** switch off automatic mode or adjust an aspect of air distribution, e.g. .

Selecting climate modes via the air conditioning menu



Multimedia system:



↳ **Climate Menu** ▶ **First Row of Seats**

It is possible to switch between different climate modes on the Climate menu.



If ECO or ECO+ mode is activated, certain climate control functions will be restricted to conserve energy and extend the vehicle's range.

The following modes are available on the Climate menu:

- **Comfort:** maximum climate comfort
- **ECO:** while heating and cooling output are limited, it remains possible to operate climate control without restriction. Activating  will automatically switch the system to Comfort mode.
- **ECO+:** mode using only the blower and waste heat, if applicable. It does not allow the temperature to be set. Activating  will automatically switch the system to Comfort mode.

-  The windows may fog up when ECO mode is activated.
-  The lack of dehumidification may result in the windows fogging up more severely when ECO+ mode is activated.
-  ECO+ climate mode can also be switched on and off via the range maximization function. When the range maximization function is

deactivated, the system automatically switches to the last selected climate mode.



-  The vehicle's climate control automatically detects seat occupancy. When the system switches to ECO or ECO+ mode, the climate control functions of the unoccupied seats are further restricted. Activating  will automatically switch the system to Comfort mode.



- ▶ Tap on **ECO**.
- ▶ Select **Comfort, ECO** or **ECO+**. The selected mode will be shown on the climate bar on the central display.

Setting air distribution using the air conditioning menu

Multimedia system:

↳ Climate Menu

- ▶ Select **First Row of Seats** or **Second Row of Seats**.
- ▶ To set the air distribution: select ,  or .
- ▶ Set the airflow.

-  When the air conditioning system is switched on, at least one zone is always active. However, several air distribution options can be selected at the same time, for example to set the climate control for the interior and the footwells simultaneously. The windshield air conditioning  can only be selected for the first row of seats. When automatic mode is active, the buttons for setting the air distribution are automatically deactivated. When the air conditioning system is switched off, the buttons remain operable and the last setting is saved.

Setting rear climate control using the air conditioning menu



Multimedia system:

↳ Climate Menu



Sets the temperature

- ▶ Select **Second Row of Seats**.
- ▶ Set the temperature.

Setting the airflow

- ▶ Select **Second Row of Seats**.
- ▶ Set the air flow with  or .

Controlling the rear climate control automatically

- ▶ Select **AUTO**.
- ⓘ When the defrost function is activated, some functions (e.g. the temperature setting) are automatically deactivated. To deactivate the defrost function, either press ,  or  or set the air volume to level 0 (→ page 167).

Switching the synchronization function on/off via the air conditioning menu

Multimedia system:

↳ **Climate Menu**



Climate control can be set centrally using the synchronization function. The driver's settings for temperature, airflow and air distribution will be adopted automatically for all climate zones.

- ▶ Select **First Row of Seats**.

- ▶ Select **SYNC (SYNC)**.

Defrosting the windows

Windows fogged up on the inside

- ▶ Press  on the climate bar on the central display.
- ▶ If the windows remain fogged up: press  on the climate bar on the central display.

Windows fogged up on the outside

- ▶ Switch on the windshield wipers.
- ▶ Press  on the climate bar on the central display.

Switching the air-recirculation mode on/off via the air conditioning menu

Requirements:

- The control panel for dual-zone automatic climate control with fine particle prefilter is available.

- The control panel for 3-zone automatic climate control with or without fine particle prefilter is available.

Multimedia system:

↳ **Climate Menu** ▶ **First Row of Seats**

- ▶ Press  on the upper display area of the climate bar.
The interior air will be recirculated.

Air-recirculation mode will automatically switch to fresh air mode after a while.

- ⓘ If air-recirculation mode is switched on, the windows may fog up more quickly. Switch on air-recirculation mode only briefly.
- ⓘ By selecting the  fine particle status display on the climate bar, you can jump directly to the air quality menu.

Switching air-recirculation mode on/off via the climate bar

Requirements:

- The control panel for dual-zone automatic climate control without fine particle prefilter is available.

- ▶ Press  on the climate bar on the central display.
The interior air will be recirculated.

Air-recirculation mode will automatically switch to fresh air mode after a while.

- ⓘ If air-recirculation mode is switched on, the windows may fog up more quickly. Switch on air-recirculation mode only briefly.

Activating or deactivating ionization via the air conditioning menu

Multimedia system:

- ↳ Climate Menu ▶▶ Air Quality

Ionization improves the quality of the vehicle's interior air. Ionization of the interior air is odorless.

- ▶ Select **Ionization**.

- ⓘ The function can only be performed if the AUTO mode is activated or the air distribution is set to the side air vent. The function is restricted if the side air vent on the driver's side is closed.

Fragrance system

Activating/deactivating the fragrance system using the multimedia system

Requirements:

- Automatic climate control is activated.
- The glove box is closed.

Multimedia system:

- ↳ Climate Menu ▶▶ Air Quality

The fragrance system distributes a pleasant fragrance throughout the vehicle interior from a flacon located in the glove box.

- ▶ Navigate down until the climate control bar is active.
- ▶ Select **Air Freshener**.

- ▶ Activate or deactivate fragrancing.

Setting the fragrance system using the multimedia system

Requirements:

- A flacon is inserted.
- The glove box is closed.
- Climate control is activated.

Multimedia system:

- ↳ Climate Menu ▶▶ Air Quality

The fragrance system distributes a pleasant fragrance throughout the vehicle interior from a flacon located in the glove box.

- ▶ Select **Fragrance**.
- ▶ Keep pressing until the desired intensity is reached.

Inserting or removing the flacon of the fragrance system

⚠ WARNING Risk of injury from liquid perfume

If children open the flacon, they could drink the liquid perfume or it could come into contact with their eyes.

- ▶ Do not leave children unattended in the vehicle.
- ▶ Consult a doctor immediately if liquid perfume has been drunk.
- ▶ If liquid perfume comes into contact with your eyes or skin, rinse your eyes with clean water.
- ▶ If symptoms continue, consult a doctor.

🔥 ENVIRONMENTAL NOTE Environmental damage due to improper disposal of full flacons



Full flacons must not be disposed of with household waste.



Full flacons must be taken to a harmful substance collection point.

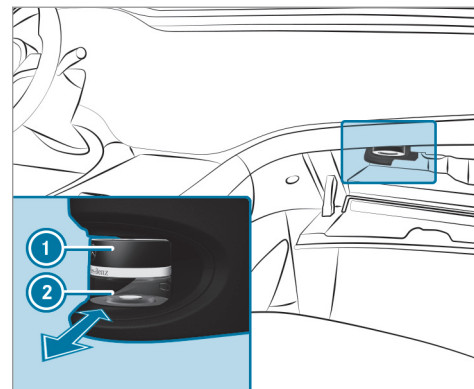

- ① Cap
- ② Flacon

▶ **To insert:** slide the flacon into the holder as far as it will go.

▶ **To remove:** after opening the glove box, wait for approximately seven seconds and pull out the flacon.

If you do not use genuine Mercedes-Benz interior perfumes, observe the manufacturers' safety notices on the perfume packaging.

Dispose of the genuine Mercedes-Benz interior perfume flacon when it is empty and do not refill it.

Refillable flacon

- ▶ Unscrew the cap of the empty flacon.
- ▶ Fill the flacon with a maximum of 0.5 fl. oz. (15 ml).
- ▶ Screw the cap back on to the flacon.

Always refill the empty refillable flacon with the same perfume. Observe the separate information sheet with the flacon.

Information on the windshield heater

⚠ WARNING Risk of burns from touching the windshield when the windshield heater is switched on

The windshield can become very hot when the windshield heater is switched on.

The health of persons with limited temperature sensitivity or a limited ability to react to high temperatures may be affected or they may even suffer burn-like injuries.

- ▶ Do not touch the windshield while the windshield heater is switched on.
- ▶ Allow the windshield to cool down before touching it.

The windshield heater will be enabled automatically if  is activated on the climate bar on the central display.

After the vehicle is started, the windshield heater will be switched on automatically as required.

i If the on-board electrical system voltage is low, the function of the windshield heater may be impaired.

Pre-entry climate control when the vehicle is unlocked

Function of pre-entry climate control when the vehicle is unlocked

The seats can be briefly pre-warmed or pre-cooled before you get into the vehicle.

Depending on the vehicle's equipment, the following functions will be activated as needed during pre-cooling:

- Automatic climate control
- Blower
- Seat ventilation

Depending on the vehicle's equipment, the following functions will be activated as needed during pre-warming:

- Automatic climate control
- Blower
- Seat heating
- Steering wheel heating
- Mirror heater
- Rear window heater

- Windshield heater

Depending on the vehicle's equipment, the following functions will also be adjusted during pre-entry climate control if they have already been switched on during regular vehicle operation:

- Fragrancing
- Ionization

Setting the pre-entry climate control on the multimedia system when the vehicle is unlocked

Multimedia system:

➔ Climate Menu ➔ Pre-entry Climate Ctrl.

- ▶ Activate or deactivate the function.

You can specify for which seat the function should be switched on or off via the seat selection.

Activating/deactivating pre-entry climate control when the vehicle is unlocked

Requirements:

- The high-voltage battery is charged sufficiently.
- The function has been activated via the multimedia system.

- ▶ **To switch on:** unlock the vehicle.

The climate control functions are activated for up to five minutes for pre-heating and pre-cooling.

Pre-entry climate control via unlocking cannot be activated more than three times in succession when the vehicle is switched off.

- ▶ **To switch off:** press  on the climate bar on the central display.

The following functions will remain active once the vehicle has been started:

- Seat heating
- Seat ventilation

Depending on the vehicle's equipment, the following functions will also be adjusted during pre-entry climate control if they have already been switched on during regular vehicle operation:

- Fragrancing
- Ionization

Pre-entry climate control for departure time

Pre-entry climate control for departure time function

⚠ WARNING Danger to life due to exposure to extreme heat or cold in the vehicle

If people, particularly children, are exposed to extreme temperatures over an extended period of time, there is a risk of serious injury or danger to life.

- ▶ Never leave persons, children in particular, unattended in the vehicle.

⚠ WARNING Risk of burns due to repeatedly switching on the seat heating

Repeatedly switching on the seat heating can cause the seat cushion and seat backrest padding to become very hot.

In particular, the health of persons with limited temperature sensitivity or a limited ability to react to high temperatures may be affected or they may even suffer burn-like injuries.

- ▶ Do not repeatedly switch on the seat heating.

To protect against overheating, the seat heating may be temporarily deactivated after it has been switched on repeatedly.

The air inside the vehicle can be heated, ventilated or cooled to the set temperature when the vehicle is parked.

When the vehicle is connected to power supply equipment, priority is given to charging the high-voltage battery to a specified minimum charge.

The running time of pre-entry climate control may be reduced under the following conditions:

- The vehicle is not connected to power supply equipment.
- The high-voltage battery is not fully charged.

With active pre-entry climate control, the charge level of the high-voltage battery may be reduced, even if the charging cable connector is connected.

If present, seat ventilation is activated in cooling and ventilation mode.

If present, the following functions are activated in heating mode:

- Seat heating
- Steering wheel heating
- Mirror heater
- Rear window heater
- Windshield heater

When the set temperature is changed, the climate control mode will automatically be updated. It will be switched from heating mode to ventilation or cooling mode, from cooling mode to ventilation or heating mode or from ventilation mode to heating or cooling mode.

Depending on the vehicle's equipment, the following functions will also be adjusted during pre-entry climate control if they have already been switched on during regular vehicle operation:

- FrAGRANCING
- Ionization

Setting pre-entry climate control for departure time via the climate bar

Multimedia system:

↳ Climate Menu ▶ Pre-entry Climate Ctrl.

Setting the departure time

- ⓘ The set departure times are used for the vehicle's pre-entry climate control and for predictions regarding the approximate state of charge and range at the time selected. Additional information on the charging settings: (→ page 209).

- ▶ Select **Edit Departure Time** .
- ▶ Select a departure time or set a new departure time.

Setting the repeat days

- ▶ Select **Edit Departure Time** .
- ▶ Set the desired departure time and select the corresponding weekdays on which this departure time is to apply.
- ▶ Press **OK** to confirm.

Selecting seats

- ▶ Select **Driver, Passenger, Rear Left** or **Rear Right**.
Pre-entry climate control will take place for the selected seats.

Activating/deactivating pre-entry climate control for departure time

Requirements:

- The high-voltage battery is charged sufficiently.
- The function has been activated via the multi-media system.

- ▶ **To activate:** set the departure time (→ page 174).
Pre-entry climate control for departure time switches on a maximum of 55 minutes before the selected departure time. It will remain active for another five minutes if the departure is delayed.
- ▶ **To deactivate the pre-entry climate control for departure time early:** press  on the climate bar on the central display or switch off

the preselection of the time in the climate menu.

If present, the following functions will remain active once the vehicle has been started:

- Seat heating
- Seat ventilation

Depending on the vehicle's equipment, the following functions will also be adjusted during pre-entry climate control if they have already been switched on during regular vehicle operation:

- Fragrancing
- Ionization

Operating immediate pre-entry climate control via the climate bar

⚠ WARNING Danger to life due to exposure to extreme heat or cold in the vehicle

If people, particularly children, are exposed to extreme temperatures over an extended period of time, there is a risk of serious injury or danger to life.

- ▶ Never leave persons, children in particular, unattended in the vehicle.

⚠ WARNING Risk of burns due to repeatedly switching on the seat heating

Repeatedly switching on the seat heating can cause the seat cushion and seat backrest padding to become very hot.

In particular, the health of persons with limited temperature sensitivity or a limited ability to react to high temperatures may be affected or they may even suffer burn-like injuries.

- ▶ Do not repeatedly switch on the seat heating.

To protect against overheating, the seat heating may be temporarily deactivated after it has been switched on repeatedly.

Air conditioning of the vehicle interior can continue for up to 50 minutes, e.g. if the journey is interrupted.

- ▶ Press the  button on the climate bar on the central display.

- ▶ Set the temperature using the arrows ▼▲ on the climate bar on the central display.

Air vents

Adjusting the front air vents

▲ WARNING Risk of burns or frostbite due to being too close to the air vents

Very hot or very cold air can flow from the air vents.

- ▶ Make sure that all vehicle occupants always maintain a sufficient distance from the air vents.
- ▶ If necessary, direct the airflow to another area of the vehicle interior.

To guarantee the flow of fresh air through the air vents into the vehicle interior, comply with the following:

- Always keep the vents and ventilation grilles in the vehicle interior clear.
- Keep the air inlet grilles free of residue build-up (→ page 355).

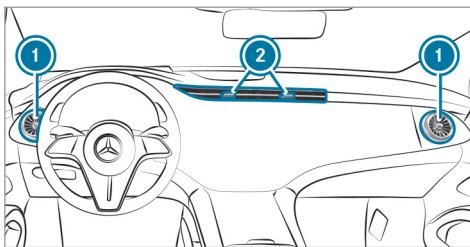

- ▶ **To open or close the side air vents:** hold the outer ring of side air vent ① and turn it to the left or right as far as it will go.
- ▶ **To open or close the center air vent:** move controller ② inwards or outwards as far as it will go.
- ▶ **To adjust the airflow direction of the side air vents:** hold the center of side air vent ① and move it up or down or to the left or right.
- ▶ **To adjust the airflow direction of the center air vent:** hold the controller of center air vent ② and move it up or down or to the left or right.

Adjusting the rear air vents

▲ WARNING Risk of burns or frostbite due to being too close to the air vents

Very hot or very cold air can flow from the air vents.

- ▶ Make sure that all vehicle occupants always maintain a sufficient distance from the air vents.
- ▶ If necessary, direct the airflow to another area of the vehicle interior.

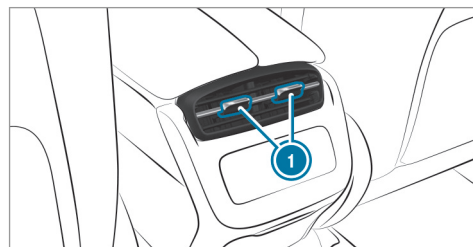

- ▶ **To open or close the rear air vents:** hold the controller of rear air vent ① and move it inwards or outwards as far as it will go.
- ▶ **To set the airflow direction of the rear air vents:** move controller ① up or down or to the left or right.

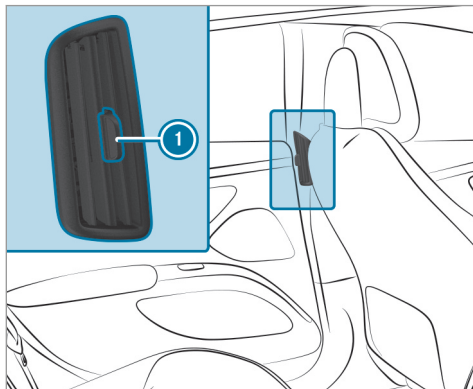

- ▶ **To open or close the side air vents in the rear passenger compartment:** hold the controller

of side air vent ① and move it up or down as far as it will go.

- ▶ **To set the airflow direction of the side air vents:** move controller ① up or down or to the left or right.

Driving

Notes on Mercedes-AMG vehicles

Observe the notes on the following topics in the Supplement, otherwise you may fail to recognize dangers.

i The availability of certain functions depends on the equipment and model of the vehicle.

- AMG Active Sound
- AMG ceramic high-performance composite brake system
- RACE START
- AMG adaptive sport suspension system +
- AMG steering-wheel buttons

Notes on electric mode

⚠ WARNING Risk of chemical burns and poisoning from damaged high-voltage battery

If the housing of the high-voltage battery has been damaged, electrolyte and gases may leak out.

- ▶ Avoid contact with the skin, eyes or clothing.
- ▶ Immediately rinse electrolyte splashes off with water and seek medical attention straight away.

⚠ DANGER Risk of explosion from excessive internal pressure of the high-voltage battery

Flammable gas may escape and ignite in the event of a vehicle fire.

- ▶ Stop the charging process immediately in case of unusual odors, smoke or burn marks.
- ▶ Leave the danger zone immediately. Secure the danger zone at a sufficient distance.
- ▶ Call the fire brigade.

Observe the following notes on vehicle noise emissions and the acoustic vehicle warning system:

- The vehicle is equipped with a purely electric drive system and develops considerably lower stationary and vehicle noise emissions than vehicles with a combustion engine.

It is for this reason that the vehicle is equipped with a sound generator, which serves as an acoustic vehicle warning system (AVAS).

- The sound generator generates speed-dependent vehicle noise emissions when driving forward or backing up at a speed of up to around 25 mph (30 km/h). This helps other road users, particularly pedestrians and cyclists, to hear your vehicle better.
- When driving at speeds above 20 mph (20 km/h) the vehicle acoustic warning system gradually switches off.
- Despite the sound generator, the vehicle still may not be heard by other road users. Adapt your driving style accordingly.

Manual disconnection of the high-voltage on-board electrical system

⚠ DANGER Risk of death and fire due to modified and/or damaged components of the high-voltage on-board electrical system

The vehicle's high-voltage on-board electrical system is under high voltage. If you modify component parts in the vehicle's high-voltage on-board electrical system or touch damaged component parts, you may be electrocuted. In addition, modified and/or damaged components may cause a fire.

In the event of an accident or impact to the vehicle underbody, components of the high-voltage electrical system may be damaged although the damage is not visible.

- ▶ Never make any modifications to the high-voltage on-board electrical system.
- ▶ Do not switch on or use the vehicle if its high-voltage on-board electrical system

components have been modified or damaged.

- ▶ Never touch damaged components of the high-voltage on-board electrical system.
- ▶ After an accident, do not touch any components of the high-voltage on-board electrical system.
- ▶ After an accident, have the vehicle transported away.
- ▶ Have the components of the high-voltage on-board electrical system checked at a qualified specialist workshop and replaced if necessary.

Requirements:

Only disconnect the high-voltage on-board electrical system manually in the following situations:

- The  restraint system warning lamp lights up in the driver display, e.g. after an accident.
- The vehicle is badly damaged, e.g. after an accident, and the restraint system components have not been triggered.

Operating the high-voltage disconnect device

Only disconnect the high-voltage on-board electrical system manually in the above-mentioned situations.

- ▶ Switch off the vehicle.
- ▶ Shift the transmission to position **P**.
- ▶ Apply the electric parking brake.
- ▶ Secure the vehicle against rolling away.

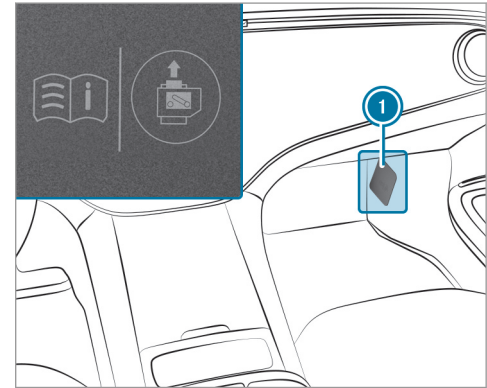

- ▶ Remove flap ① of the fuse box in the front passenger footwell.

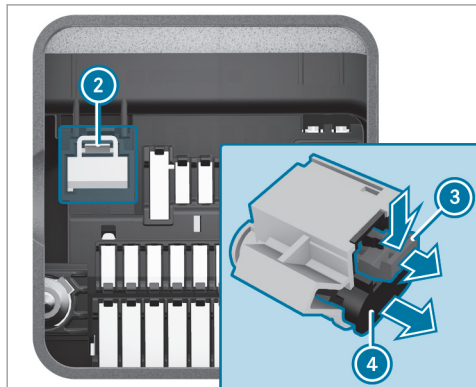

- ▶ Press release tab ③ on high-voltage disconnect device ② in the direction of the arrow and pull it out.

- ▶ Pull connector ④ in the direction of the arrow until it engages. The high-voltage on-board electrical system is switched off.

All work on the drive system (including after disconnecting the high-voltage on-board electrical system manually) may only be carried out by a qualified specialist workshop.

Switching on the power supply or the vehicle

⚠ WARNING Risk of accident and injury due to children left unattended in the vehicle

If children are left unsupervised in the vehicle, they could, in particular:

- open doors, thereby endangering other persons or road users.
- get out and be struck by oncoming traffic.
- operate vehicle equipment and become trapped, for example.

In addition, the children could also set the vehicle in motion, for example by:

- releasing the parking brake.
- changing the transmission position.
- starting the vehicle.

- ▶ Never leave children unattended in the vehicle.
- ▶ When leaving the vehicle, always take the SmartKey with you and lock the vehicle.
- ▶ Keep the vehicle SmartKey out of reach of children.

Requirements:

- The SmartKey is in the vehicle and is recognized.
- The brake pedal is not depressed.

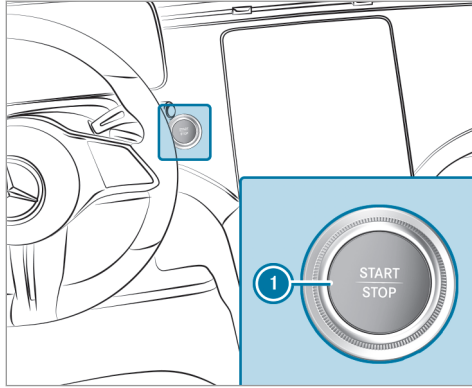

Vehicles with central display

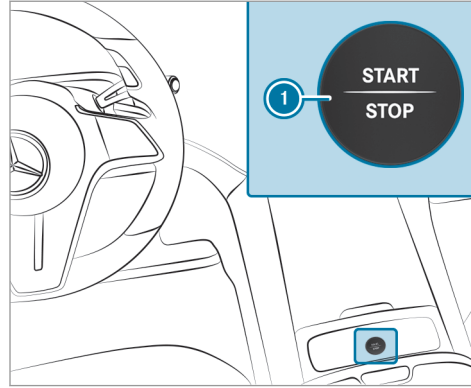

Vehicles with MBUX Hyperscreen

- ▶ **To switch on the power supply:** press button ① once. You can, for example, activate the windshield wipers.

The power supply is switched off again if the following conditions are met:

- You open the driver's door.

- You press button ① twice more.

- ▶ **To switch on the vehicle:** press button ① twice. Indicator and warning lamps go on in the driver's display.

The vehicle is switched off again if one of the following conditions is met:

- You do not start the vehicle within 15 minutes and the transmission is in position **P** or the electric parking brake is applied.
- You press button ① once.

Starting the vehicle

Starting the vehicle with the start/stop button

Requirements:

- The SmartKey is in the vehicle and is recognized.
- ▶ Shift the transmission to position **P** or **N**.
- ▶ Depress the brake pedal and press button ① once.
 - The vehicle is started.

- The display **READY** appears in the driver display: the vehicle can be driven.

- ▶ If the vehicle does not start: switch off non-essential consumers and press button ① once.
- ▶ If the vehicle still does not start and the display message **Place the Key in the Marked Space See Operator's Manual** also appears in the driver display: start the vehicle with the SmartKey in the marked space (emergency operation mode) (→ page 182).

- ① You can switch off the vehicle while driving. To do this, press button ① for about three seconds or by pressing button ① three times within three seconds. The transmission shifts to neutral **N** automatically. When you press button ① again, the vehicle starts again and you can engage drive position **D** again. Be sure to observe the safety notes under "Driving tips" (→ page 183).

Observe any information regarding display messages that can be displayed on the driver display.

Starting the vehicle with the SmartKey in the marked space (emergency operation mode)

If the vehicle does not start and the **Place the Key in the Marked Space See Operator's Manual** display message appears in the driver display, you can start the vehicle in emergency operation mode.

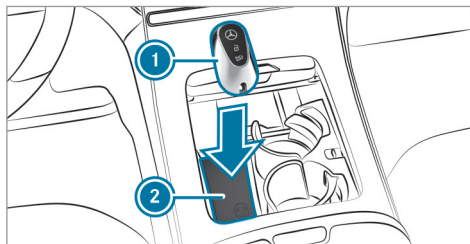

- ▶ Make sure that marked space ② is empty.
- ▶ Remove SmartKey ① from the key ring.
- ▶ Place SmartKey ① in marked space ② on the symbol.
The vehicle will start after a short time.

When you remove SmartKey ① from marked space ②, the vehicle can be driven. For further engine starts however, SmartKey ① must be located in marked space ② on the symbol during the entire journey.

- ▶ Have SmartKey ① checked at a qualified specialist workshop.

If the vehicle does not start:

- ▶ Place SmartKey ① in marked space ② and leave it there.
- ▶ Depress the brake pedal and start the vehicle using the start/stop button.
- ① You can switch on the power supply or the vehicle with the start/stop button.

Observe any information regarding display messages that can be displayed on the driver display.

Breaking-in notes

- In certain driving and driving safety systems, the sensors adjust automatically while a certain distance is being driven after the vehicle has been delivered or after repairs. Full sys-

tem effectiveness is not reached until the end of this teach-in process.

- Brakepads, brake discs and tires that are either new or have been replaced only achieve optimum braking effect and grip after several hundred kilometers of driving. Compensate for the reduced braking effect by applying greater force to the brake pedal.

Notes on acceleration increase

- ① Acceleration increase is not available for all models.
- ① This function is an on-demand feature (→ page 29).

With the activation of the function, a higher maximum power is available for the vehicle and the acceleration characteristics are improved. The maximum speed is not changed by this.

Due to the increased power, there may be changes in the electric range.

Notes on driving

- ⚠ **WARNING** Risk of accident due to objects in the driver's footwell

Objects in the driver's footwell may impede pedal travel or block a depressed pedal.

This jeopardizes the operating and road safety of the vehicle.

- ▶ Stow all objects in the vehicle securely so that they cannot get into the driver's footwell.
- ▶ Always install the floor mats securely and as prescribed in order to ensure that there is always sufficient room for the pedals.
- ▶ Do not use loose floor mats and do not place floor mats on top of one another.

- ⚠ **WARNING** Risk of accident due to incorrect footwear

Incorrect footwear includes, for example:

- Shoes with platform soles
- Shoes with high heels
- Slippers

There is a risk of an accident.

- ▶ Always wear suitable footwear so that you can operate the pedals safely.

- ⚠ **WARNING** Risk of accident if the vehicle is switched off while driving

If you switch off the vehicle while driving, safety functions are restricted or no longer available.

This may affect the power steering system and the brake force boosting, for example.

You will need to use considerably more force to steer and brake, for example.

- ▶ Do not switch off the vehicle while driving.

⚠ WARNING Risk of accident and injury due to being under the influence of alcohol and drugs while driving

Drinking and driving and/or taking drugs and driving are very dangerous combinations. Even a small amount of alcohol or drugs can affect your reflexes, perceptions and judgment.

The possibility of a serious or even fatal accident are greatly increased when you drink or take drugs and drive.

- ▶ Do not drink or take drugs and drive or allow anyone to drive who has been drinking or taking drugs.

⚠ WARNING Risk of accident due to the brake system overheating

If you leave your foot on the brake pedal when driving, the brake system may overheat.

This increases the braking distance and the brake system can even fail.

- ▶ Never use the brake pedal as a footrest.

- ▶ Do not depress the brake pedal and the accelerator pedal at the same time while driving.

! NOTE Damage to the vehicle due to not observing the maximum permitted headroom clearance

If the vehicle height is greater than the maximum permitted headroom clearance, the roof and other parts of the vehicle may be damaged.

- ▶ Observe the signposted headroom clearance.
- ▶ If the vehicle height is greater than the permitted headroom clearance, do not enter.
- ▶ Observe the changed vehicle height with add-on roof equipment.

Notes on driving with a roof load, trailer or fully laden vehicle

When driving with a loaded roof luggage rack or trailer as well as with a fully laden or fully occu-

ried vehicle, the vehicle's driving and steering characteristics change.

You should bear the following in mind:

- Do not exceed the permissible roof load and towing capacity. Also observe the technical data in the printed Operator's Manual.
- Evenly distribute the roof load, and place heavy objects at the bottom. Also comply with the notes on loading the vehicle (→ page 119).
- Drive attentively, and avoid suddenly pulling away, braking and steering as well as rapid cornering.

Notes on driving on salt-treated roads

The braking effect is limited on salt-treated roads.

Therefore, observe the following notes:

- Due to salt build-up on the brake discs and brakepads, the braking distance can increase considerably or result in braking only on one side
- Maintain a much greater safe distance to the vehicle in front

To remove salt build-up:

- Brake occasionally while paying attention to the traffic conditions
- Carefully depress the brake pedal at the end of the journey and when starting the next journey

Notes on hydroplaning

Hydroplaning can take place once a certain amount of water has accumulated on the road surface.

Observe the following notes during heavy precipitation or in conditions in which hydroplaning may occur:

- Reduce speed
- Avoid tire ruts
- Avoid sudden steering movements
- Brake carefully

i Also observe the notes on regularly checking wheels and tires (→ page 381).

Notes on driving through water on the road surface

Water which has entered the vehicle can damage the drive system, electrics and transmission.

Observe the following if you must drive through water:

- The water, when calm, may only reach the lower edge of the vehicle body.
- Drive at walking pace at most; water can otherwise enter the vehicle interior.
- Vehicles traveling in front, or oncoming vehicles, can create waves which may exceed the maximum permissible depth of the water.

The braking effect of the brakes is reduced after fording. Brake carefully while paying attention to the traffic conditions until braking power has been fully restored.

Function of rear axle steering

i This function is available on demand (→ page 29).

The rear axle steering is an electromechanical auxiliary steering on the rear axle which adjusts the steering of the rear wheels according to the position of the front wheels, depending on the speed. This results in greater maneuverability and improved driving stability, e.g. when cornering.

Rear axle steering has the following characteristics:

- Reduced steering effort and turning radius resulting in reduced parking effort
- Improved driving stability, e.g. when cornering
- More direct steering resulting in improved handling of the vehicle

Observe the notes on snow chains and snow chain mode (→ page 382).

ECO display function

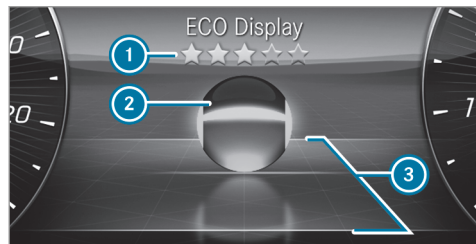

The ECO display shows an evaluation of your driving style on the driver display depending on the situation. This enables you to check the efficiency of your driving style and adjust it if necessary. The **ECO Display** menu shows a ball ② that will roll forwards or backwards on a stylized road in the direction of travel according to the driving characteristics.

Above and below the road, lines mark the area for an efficient driving style ③. Ball ② will light up in green if it is rolling within these lines. Outside the lines, the ball will light up in orange.

The ECO display assesses the following criteria for an economical driving style:

- Coasting at the right time
- Consistent speed
- Moderate acceleration

The overall assessment of your driving style "from start" is indicated using stars ①. It starts with five empty stars, which you can fill one after the other if you drive efficiently. When all five stars are filled, a glow appears in the background.

① You can call up the **ECO Display** function via the **Classic** menu (→ page 288).

Regenerative brake system

Function of the regenerative brake system

Depending on the selected recuperation level, the electric motors are operated as an alternator when in overrun mode and during braking in order to charge the high-voltage battery while driving. As soon as you release the accelerator pedal when the vehicle is in motion, recuperation in overrun mode is initiated.

The higher the recuperation, the more sharply the vehicle is braked when coasting and the more electrical energy is fed into the high-voltage battery.

The regenerative brake system has the following characteristics:

- Supports braking with electronically controlled brake force boosting
 - Converts the kinetic energy of the vehicle into electric energy
- ① If you brake hard, the mechanical brake is also used. This means that the maximum recuperative energy cannot be recovered. The more you drive and brake in an anticipatory manner, the more efficiently energy can be recuperated.

System limits

The braking effect of the electric motor during recuperation in overrun mode may be reduced or may not be available at all in the following situations:

- When the high-voltage battery condition of charge increases

- If the high-voltage battery is not yet at a normal operating temperature
- When driving at speeds close to zero
- In transmission position **N**
- During and after ESP® intervenes

In these cases, the desired deceleration is set by the brake control system. Also brake with the service brake if necessary.

Manually setting recuperative deceleration

You can use the steering wheel paddle shifters to manually adjust the intensity of recuperation in overrun mode.

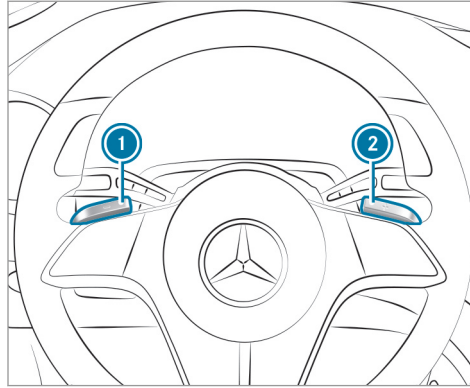

i When the vehicle is started again, the following recuperation level is set:

- **D AUTO**: if **D AUTO** was selected previously.
- **D**: if a recuperation level other than **D AUTO** was selected previously.

The following recuperation levels are available:

- **D AUTO** Intelligent and anticipatory recuperation with ECO Assist (→ page 188)
- **D +** No recuperation: the vehicle coasts, rolls freely
- **D** Normal recuperation
- **D -** Increased recuperation: increased deceleration in overrun mode

- ▶ **To increase recuperation:** briefly pull paddle shifter **1**.
- ▶ **To reduce recuperation:** briefly pull paddle shifter **2**.
- ▶ **To select **D AUTO**:** pull and hold paddle shifter **1** or **2**.

The driver's display shows the currently selected recuperation level next to the transmission position display.

ECO Assist

ECO Assist function

ECO Assist is only an aid. It is not a substitute for you paying attention to your surroundings and does not relieve you of your responsibility pertaining to road traffic law. The driver is responsible for keeping a safe distance from the vehicle in front, for vehicle speed and for braking in good time.

⚠ WARNING Risk of accident if ECO Assist does not provide sufficient deceleration

ECO Assist only brakes your vehicle when you take your foot off the gas pedal. If vehicles are detected late, e.g. after tight curves, or if you do not react immediately to the ECO Assist display, the deceleration may not be sufficient.

- ▶ React promptly to the ECO Assist recommendation and take your foot off the gas pedal.
- ▶ Adjust your speed to the driving conditions and maintain a suitable distance from the vehicle in front.

▶ Brake the vehicle yourself and/or take evasive action.

ECO Assist is active only in **D AUTO** (→ page 187).

ECO Assist analyzes data for the vehicle's expected route. This allows the system to optimally adjust the driving style for the route ahead, use minimal energy and recuperate as much as possible. If the system has detected an event ahead and the vehicle is approaching the event, ECO Assist calculates the optimized speed profile based on the distance, speed and available route information.

If ECO Assist detects a route event ahead and you release the accelerator pedal, intelligent recuperation starts in overrun mode. If ECO Assist has detected a vehicle ahead or a stationary vehicle, it can brake your vehicle to a standstill. This may be the case, for example, at the end of a traffic jam or if the detected vehicle ahead stops in front of you.

If the deceleration provided by ECO Assist is not sufficient, you must also brake with the service brake.

At a very low driving speed, e.g. in a parking garage or in play streets, there is no display and thus no adjustment.



- ① "Foot off the accelerator" recommendation
- ② Route event ahead
- ⓘ ECO Assist can also be shown in the head-up display.

If a route event that requires an adjustment of your driving style is detected ahead, correspond-

ing symbol ② and the  symbol (gray) are displayed.

If you release the accelerator pedal, the  symbol turns green and recuperation in overrun mode is initiated.

The ECO Assist display is hidden again in the following cases:

- You do not react to the ECO Assist recommendation for a long time.
- ECO Assist cannot identify any further recommendations from the route ahead.

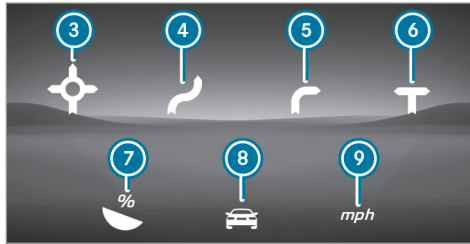

The following route events can be detected by ECO Assist, depending on the vehicle equipment:

- ③ Roundabout
- ④ S-curve
- ⑤ Sharp curve
- ⑥ T-intersection
- ⑦ Downhill gradient
- ⑧ Vehicle in front
- ⑨ Speed limit

ECO Assist also reacts to other intersections or junctions if you activate the turn signal indicator in good time.

- ① On roads with a right-hand lane, vehicles driving in the lane to your left are also recognized as vehicles ahead of you.

To enable ECO Assist to react to a speed limit or to future route events, the speed adaptation functions of Active Distance Assist must be active (→ page 235).

System limits

If the calculated route is adhered to when route guidance is active, ECO Assist will operate with

greater accuracy. The basic function is also available without active route guidance. Not all information and traffic situations can be foreseen. The quality depends on the map data.

- ① ECO Assist is available after driving off, as soon as the sensor check is completed.

The system may be impaired or may not function in the following situations:

- If there is poor visibility, e.g. due to insufficient illumination of the road, highly variable shade conditions, rain, snow, fog or heavy spray.
- If there is glare, e.g. from oncoming traffic, direct sunlight or reflections.
- If the windshield is dirty in the vicinity of the multifunction camera.
- If the multifunction camera is fogged up, damaged or obscured.
- If road signs are hard to detect, e.g. due to dirt, snow or insufficient lighting, or because they are obscured.
- If the digital road map of the navigation system has incorrect or outdated information.

- If signs are ambiguous, e.g. road signs in roadworks or in adjacent lanes.
- If the radar sensors are dirty or obscured.
- When you drive on roads with steep uphill or downhill gradients.
- If there are narrow vehicles in front, such as bicycles or motorcycles.

Activating or deactivating ECO Assist

Multimedia system:

-  » Settings » Assistance
- » Driving
- ▶ Activate or deactivate the function.

Function of the haptic accelerator pedal

The haptic accelerator pedal features an additional point of resistance to help you drive as efficiently as possible in the  drive program.

Range maximization

Range maximization function

The range maximization function enables a maximum range gain. To achieve this, the function partially or completely switches off convenience systems that are not relevant to driving and activates efficiency-enhancing driving functions.

The range maximization function controls the restrictions of the following function groups:

- **Climate control**
 - Restriction of air-conditioning functions and deactivation of windshield, rear window and mirror heaters
- **Interior**
 - Switching off ambient lighting, displays and certain charging functions
- **Seating comfort**
 - Deactivation of the steering wheel heater, seat heating and ventilation and deactivation of the massage function
- **ECO drive functions**

- Changing to the  drive program, activation of the ECO Assist and the recuperation level  **AUTO**

If necessary, you can deactivate the restrictions of individual function groups again. This reduces the maximum range gain by the value specified for the function group.

If you switch on a deactivated function while range maximization is activated, all restrictions of the corresponding function group are removed and the maximum range gain is reduced accordingly. For example, if you switch on the seat heating again, all restrictions of the "Seating comfort " function group are deactivated. If you change the drive program or the recuperation level, the maximum range gain is reduced by the range gain of the ECO drive functions.

The specified range gain for the ECO driving functions can only be achieved if you observe the driving recommendations and instructions displayed and drive without kickdown.

Activating/deactivating range maximization

Multimedia system:

→  » Settings » EQ » Range

- ▶ Activate or deactivate **Maximum Range**. All function groups concerned are activated or deactivated.

or

- ▶ Individually activate or deactivate the individual subsystems of the four function groups **Climate Control**, **Interior**, **Seat Comfort** or **ECO Driving Functions**.

DYNAMIC SELECT button**Function of the DYNAMIC SELECT button****!** NOTE Mercedes-AMG vehicles

- ▶ Observe the notes in the Supplement. You could otherwise fail to recognize dangers.

You can switch between the drive programs with the DYNAMIC SELECT button (→ page 192).

Depending on the drive program selected, the following vehicle characteristics will change:

- Drive
 - Suspension (→ page 258)
 - Suspension and damping
 - Vehicle level (speed-dependent)
 - Steering
 - ESP®
 - Sound of the drive system in the vehicle interior
 - Pressure point in the haptic accelerator pedal
- i** In drive program **[E]**, an additional pressure point is activated in the haptic accelerator pedal.
- 1st pressure point: at approx. 60% pedal travel (only in **[E]**)
 - 2nd pressure point: transition to kickdown (always available)

Available drive programs**[I]** (Individual)

- The following vehicle characteristics are individually adjustable:
 - Drive
 - Suspension
 - Steering
 - ESP®
 - Sound of the drive system in the vehicle interior

[S] (Sport)

- Sporty and dynamic driving characteristics
- Only suitable for good road conditions, a dry road surface and a clear stretch of road

[C] (Comfort)

- Comfortable driving style
- Recommended for all road conditions
- Best balance between efficiency and performance for all driving situations

E (Eco)

- Economical setting of vehicle functions
- Recommended for all road conditions
- Additional 1st pressure point in the haptic accelerator pedal indicates an efficient, economical driving style

The ESP® settings in the drive programs **E** and **C** are designed for stability. Therefore, choose one of these driving programs, especially when transporting roof loads, in trailer operation and when the vehicle is fully loaded or fully occupied.

Selecting the drive program

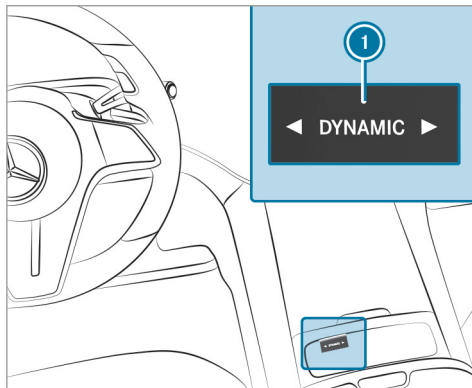

- ▶ Press the DYNAMIC SELECT button **1** on the left or right. The drive program selected appears in the driver's display .

Configuring DYNAMIC SELECT (multimedia system)

Multimedia system:

- ▶ Settings ▶ Vehicle
- ▶ DYNAMIC SELECT

Setting drive program I

- ▶ Select **I** Individual.
- ▶ Select and set a category.

Switching the reset display on/off

- ▶ Activate or deactivate **Request at Start**.
- i** This function must be activated for each user profile separately. The drive program for the respective user profile of the last driver is only stored if this function is activated.

Function on: the next time the vehicle is started a prompt appears asking whether the last active drive program should be restored.

- i** The prompt appears only if the previously active settings deviate from the standard settings.

Function off: the next time the vehicle is started the  drive program is set automatically.

Displaying vehicle data

Multimedia system:



- ▶ Select **Vehicle**.
The vehicle data is displayed.

Calling up the fuel consumption indicator

Multimedia system:



- ▶ Select **Consumption**.
The current and average fuel consumption is displayed.

Transmission

DIRECT SELECT lever

Function of the DIRECT SELECT lever

⚠ WARNING Risk of accident and injury due to children left unattended in the vehicle

If children are left unsupervised in the vehicle, they could, in particular:

- open doors, thereby endangering other persons or road users.
- get out and be struck by oncoming traffic.
- operate vehicle equipment and become trapped, for example.

In addition, the children could also set the vehicle in motion, for example by:

- releasing the parking brake.
 - changing the transmission position.
 - starting the vehicle.
- ▶ Never leave children unattended in the vehicle.

- ▶ When leaving the vehicle, always take the SmartKey with you and lock the vehicle.
- ▶ Keep the vehicle SmartKey out of reach of children.

Use the DIRECT SELECT lever to switch the transmission position. The current transmission position is displayed in the driver's display.

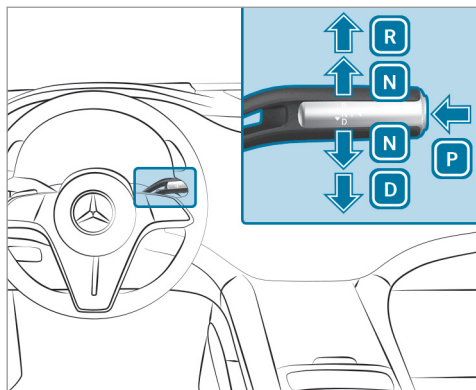

- P** Park position
- R** Reverse gear
- N** Neutral
- D** Drive position

Engaging reverse gear R

- ▶ Depress the brake pedal and push the DIRECT SELECT lever upwards past the first point of resistance.

Engaging neutral N

- ▶ Depress the brake pedal and push the DIRECT SELECT lever up or down to the first point of resistance.

Subsequently releasing the brake pedal will allow you to move the vehicle freely, e.g. to push it or tow it away.

If you want the transmission to remain in neutral N even if the vehicle is switched off:

- ▶ Start the vehicle.
 - ▶ Depress the brake pedal and engage neutral **N**.
 - ▶ Release the brake pedal.
 - ▶ Switch off the vehicle.
- i** If you then exit the vehicle leaving the Smart-Key in the vehicle, the transmission remains in neutral **N**.

Engaging park position P

- ▶ Observe the notes on parking the vehicle (→ page 210).
- ▶ Depress the brake pedal until the vehicle comes to a standstill.

- ▶ When the vehicle is stationary, press button **P**.

Park position is only engaged when the transmission position display **P** is shown in the driver's display. If no transmission position display **P** appears, secure the vehicle to prevent it from rolling away.

Park position **P** is engaged automatically if one of the following conditions is met:

- You switch the vehicle off in transmission position **D** or **R**.
 - You open the driver's door when the vehicle is at a standstill or when driving at a very low speed and the transmission is in position **D** or **R**.
- i** To maneuver with an open driver's door, open the driver's door while stationary and engage transmission position **D** or **R** again.
- i** If you have engaged park position **P** or switched off the vehicle and no transmission position display is displayed, secure the vehicle from rolling away (→ page 215).

Engaging drive position D

- ▶ Depress the brake pedal and push the DIRECT SELECT lever down past the first point of resistance.

Function of the 4MATIC

The flexible all-wheel distribution of the 4MATIC means the drive is always ideally distributed between both axles. Depending on the situation, only the front axle or only the rear axle can be driven, or the drive can be distributed continuously between both axles.

This means that recuperation can be used even more effectively and the range of the vehicle can be increased (→ page 186).

Together with ESP® and 4ETS, 4MATIC improves the traction of your vehicle whenever a driven wheel spins due to insufficient traction.

If you fail to adapt your driving style, 4MATIC can neither reduce the risk of an accident nor override the laws of physics. It cannot take into account road, weather or traffic conditions. 4MATIC is only an aid. You are responsible especially for maintaining a safe distance from the vehicle in front,

for vehicle speed, for braking in good time and for staying in lane.

- ⓘ In wintry road conditions, the maximum effect of the flexible all-wheel distribution can be achieved only if you use winter tires (M+S tires), with snow chains if necessary.

Charging the high-voltage battery

Notes on charging the high-voltage battery

- ! **NOTE** High-voltage battery damage due to leaving the vehicle idle for lengthy periods of time

Lithium-ion batteries experience a natural self-discharge.

Exhaustive discharging can therefore occur if the vehicle is idle for several months. This can damage the high-voltage battery.

- ▶ To avoid damage, please observe the following recommendations when handling the high-voltage battery.

- ! **NOTE** Accelerated aging of the high-voltage battery

As a result of its basic characteristics, the storage capacity of, and the amount of energy available from, the high-voltage battery decreases over the course of its life. Due to this, both the maximum electrical range that can be achieved by the vehicle and its maximum electrical output can be impaired.

The following factors could accelerate the aging of the high-voltage battery:

- Frequently fully charging (charge level 100%) the high-voltage battery, especially when this process is not directly followed by a journey
 - Frequent rapid charging with direct current (mode 4)
 - Leaving the vehicle idle for lengthy periods at high ambient temperatures
- ▶ To avoid accelerated aging, please observe the following recommendations when handling the high-voltage battery.

Recommendations when handling the high-voltage battery:

- Every six months, when the outside temperature is above 50 °F (10 °C), park the vehicle overnight with a condition of charge below 20%.
- Only charge the high-voltage battery with direct current (mode 4) if necessary.
- Charge the high-voltage battery on average to a condition of charge of 80%. Beyond a condition of charge of 80%, the charging time is considerably prolonged.
- If leaving the vehicle idle for extended periods, park the vehicle with the high-voltage battery condition of charge at between 30% and 50%. Do not keep the high-voltage battery continuously connected to power supply equipment.
- If leaving the vehicle idle for extended periods of time avoid, if possible, high ambient temperatures.
- Check the high-voltage battery's condition of charge every six weeks (→ page 208).

- Charge the high-voltage battery if the condition of charge is below 20%.
- Do not disconnect the 12 V battery even if the vehicle is left idle for an extended period. Otherwise, the condition of the vehicle's high-voltage battery cannot be monitored.

You can contribute to reducing the vehicle's energy consumption in the following ways:

- An anticipatory driving style (→ page 186)
- Reduced use of electrical consumers
- Having the vehicle regularly maintained

The charging time of the high-voltage battery may change over the course of its life.

You can charge the high-voltage battery with both alternating current (mode 2 or 3) and direct current (mode 4).

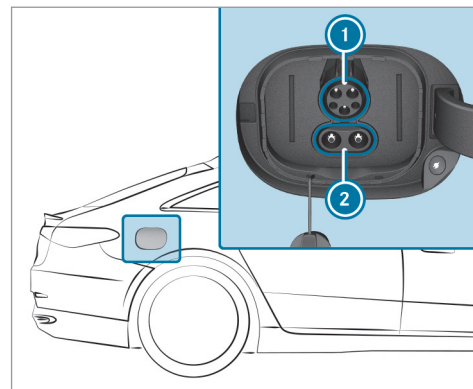

- ① Socket for charging with alternating current
- ② Socket extension for charging with direct current
- ⓘ When using a CCS (Combined Charging System) charging cable to charge with direct current, both areas of the vehicle socket are covered by the charging cable connector.

Charging options for the high-voltage battery (mode 2, 3 or 4):

- Charging through recuperation while the vehicle is in motion
- Charging with alternating current when stationary:
 - At a mains socket (mode 2)
 - At a wallbox or charging station (mode 3)
- Charging with direct current when stationary:
 - At a fast charging station (mode 4)

Depending on the country-specific vehicle equipment and your vehicle's charging cable, single phase AC charging is also possible.

Observe the different grid requirements of your current location when charging. Only use charging cables which conform to the grid requirements. Consult a qualified electrician or your local grid operator if you have any questions.

It is recommended that you charge the high-voltage battery at a wallbox or charging station due to the improved charging performance and better charging efficiency offered.

Stowing the charging cable

Always stow the vehicle charging cable in the charging cable bag provided and attach its spring hook to the tie-down eye in the trunk or the cargo compartment.

Otherwise, the charging cable is not sufficiently secured.

System limits

The power output of the high-voltage battery may be impaired by the following:

- High or low outside temperatures
- Electrical auxiliary consumers in the vehicle being switched on, e.g. operating the air conditioning system
- Extended periods without charging

The charging time of the high-voltage battery may be increased by the following:

- High or low outside temperatures
- Extended periods without charging
- The maximum available charge current of the charging facility

- The settings of the charging process in the multimedia system (→ page 209)

Notes on charging the high-voltage battery at the mains socket (mode 2)

⚠ DANGER Risk of fatal injury from incorrectly installed component parts

Connecting the charging cable to a mains socket using incorrectly installed component parts could cause a fire or an electric shock, for example.

- ▶ Only connect the charging cable to a mains socket that:
 - Has been properly installed and
 - Has been inspected by a qualified electrician
- ▶ For safety reasons, only use the charging cable supplied with the vehicle or an original Mercedes-Benz charging cable. Mercedes-Benz thoroughly tests these original charging cables for their suitability for high-voltage charging of your vehi-

cle. Purchase these parts at an authorized Mercedes-Benz Center and obtain advice there.

- ▶ Never use a damaged charging cable.
- ▶ Do not use:
 - Extension cables
 - Extension reels
 - Multiple sockets
- ▶ Never use socket adapters to connect the charging cable to the mains socket. The only exception being if the adapter has been tested and approved by the manufacturer for charging the high-voltage battery of an electric vehicle.
- ▶ Observe the safety notes in the operating instructions for the socket adapter.

Only the following charging cables may be used:

- The charging cable supplied with the vehicle.
- A charging cable that has been approved for the vehicle.

The charging process can vary depending on the power supply equipment.

Shorter charging times can be achieved in the following ways:

- Charging at a wallbox.
- Charging at a charging station.

When doing so, always observe the local information.

Do not leave the charging cable controls hanging loose from a mains socket.

Do not lift the controls by the following component parts:

- The charging cable connector.
- The mains plug.

When charging, protect the charging cable control element from excessive heat such as direct sunlight. Otherwise, the charging process may be canceled.

Notes on charging the high-voltage battery at a wallbox or charging station (mode 3)

⚠ DANGER Risk of fatal injury from incorrectly installed component parts

Connecting the charging cable to the vehicle using incorrectly installed components could cause a fire or an electric shock, for example.

- ▶ Only connect the charging cable to a wallbox if:
 - The wallbox has been properly installed
 - The wallbox has been inspected by a qualified electrician
 - The charging cable is not damaged
- ▶ Do not extend the charging cable.
- ▶ Do not use adapters.
- ▶ Observe the safety notes in the operating instructions for the wallbox.

⚠ DANGER Risk of fatal injuries due to damaged components

Connecting the charging cable to a charging station using a damaged component part could cause a fire or an electric shock, for example.

- ▶ For charging stations with a preinstalled charging cable:
 - Perform a visual check of the charging station for obvious malfunctions, such as massive damage to the housing or charging cable.
- ▶ For charging stations without a preinstalled charging cable:
 - For safety reasons, only use charging cables that have been tested and approved by the manufacturer for charging the high-voltage battery in an electric vehicle.
 - Never use damaged charging cables.
 - Do not extend the charging cable.
 - Do not use adapters.

- ▶ Make sure to observe the safety information on the charging station.

Most charging stations must be activated before the charging process, e.g. using an RFID card or via Plug & Charge. Observe the on-site operator's instructions for the charging station and the notes on Mercedes me Charge (see the vehicle's Digital Operator's Manual).

The amount of energy dispensed for the charging process, shown by the charging station, may be higher than the amount of energy actually absorbed by the high-voltage battery. This is the result of different levels of charging losses and is described as recharge efficiency. Charging losses occur, for example, due to heat that builds up when charging or from auxiliary consumers that are switched on. Further information on recharge efficiency can be obtained at a qualified specialist workshop.

Notes on charging the high-voltage battery at a fast charging station (mode 4)

⚠ DANGER Risk of fatal injuries due to damaged components

Connecting the charging cable to a charging station using a damaged component part could cause a fire or an electric shock, for example.

- ▶ For charging stations with a preinstalled charging cable:
 - Perform a visual check of the charging station for obvious malfunctions, such as massive damage to the housing or charging cable.
- ▶ For charging stations without a preinstalled charging cable:
 - For safety reasons, only use charging cables that have been tested and approved by the manufacturer for charging the high-voltage battery in an electric vehicle.
 - Never use damaged charging cables.
 - Do not extend the charging cable.

- Do not use adapters.
- ▶ Make sure to observe the safety information on the charging station.

Most charging stations must be activated before the charging process, e.g. using an RFID card or via Plug & Charge. Observe the on-site operator's instructions for the charging station and the notes on Mercedes me Charge (see the vehicle's Digital Operator's Manual).

The amount of energy dispensed for the charging process, shown by the charging station, may be higher than the amount of energy actually absorbed by the high-voltage battery. This is the result of different levels of charging losses and is described as recharge efficiency. Charging losses occur, for example, due to heat that builds up when charging or from auxiliary consumers that are switched on. Further information on recharge efficiency can be obtained at a qualified specialist workshop.

Setting the maximum permissible charging current for charging at a mains socket

! **NOTE** Overloading the mains socket due to excessive charging current

If the charging current is too high, the fuse could be tripped or the external mains supply could overheat.

- ▶ Ensure that the external mains supply has been designed to handle the charging current provided.
- ▶ For safety reasons, only use the charging cable supplied with the vehicle or an original Mercedes-Benz charging cable. Mercedes-Benz thoroughly tests these original charging cables for their suitability for high-voltage charging of your vehicle. Purchase these parts at an authorized Mercedes-Benz Center and obtain advice there.
- ▶ Check the maximum charging current using the charging capacity shown in the driver's display.

The charging cable supplied is set to a country-specific maximum charging current value. When charging abroad, the maximum value may exceed the permitted value for that country.

- ▶ Before charging at a mains socket, have the maximum permissible charging current for the relevant mains socket or the building inspected by a qualified electrician.
- ▶ When abroad, observe the country-specific laws when charging.

If you have questions concerning the charging current or if there is a malfunction, please contact a qualified specialist workshop.

Overview of the charging cable control panel

The charging cable control panel shows the current status of the charging process.

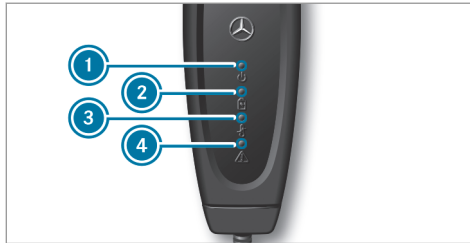

- ① Supply voltage indicator
- ② Charging process indicator
- ③ Temperature monitor indicator
- ④ Safety system indicator

Supply voltage indicator ①

Display	Meaning
Lights up white	The supply voltage is connected.

Charging process indicator ②

Display	Meaning
Flashes green	The high-voltage battery is charging.

Temperature control indicator ③

Display	Meaning
Lights up red	The green LED flashes simultaneously: overtemperature – the charging performance is reduced. The green LED does not flash: overtemperature – the charging process is stopped.
Flashes red	Overtemperature at the mains plug – the charging process is stopped.

Safety system indicator ④

Display	Meaning
Flashes red	Charging cable malfunction – cannot carry out the charging process, reset the charging cable operating unit.
Lights up red	White LED is off: power supply malfunction – cannot carry out the charging process, replace the mains socket. White LED is on: vehicle malfunction – cannot carry out the charging process, reset the charging cable operating unit.

When all four displays light up, the charging cable operating unit performs a self-test.

If temperature monitor ③ indicates a malfunction, it may help to protect the charging cable from direct sunlight.

To reset the charging cable operating unit: if safety system ④ indicates a charging cable malfunction or a vehicle malfunction, first reset the charging cable operating unit. To do this, disconnect the charging cable from the vehicle and from the mains socket and wait for approximately five seconds. If the malfunction persists after the charging cable is reconnected, charging at the mains socket is not possible. The charging cable must be replaced or the vehicle plug must be checked at a qualified specialist workshop, depending on the indicator.

Functions of the indicator lamp on the vehicle socket

The socket flap is centrally locked and unlocked together with the vehicle.

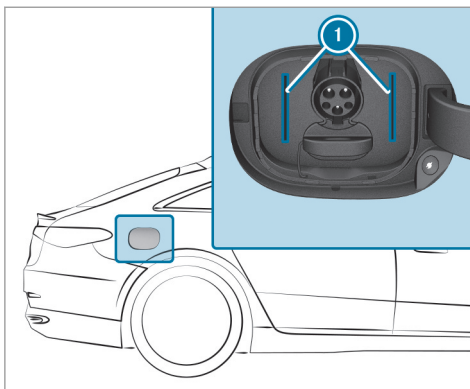

The color and signaling of status display ① have the following meanings:

Locking status

- Lights up white: vehicle socket unlocked; insert or remove charging cable
- Flashes white: disconnection or malfunction during locking or unlocking

Condition of charge

- Lights up blue: charging process completed
- Flashes blue: charging; active energy flow
- Lights up orange: charging paused
- Flashes orange: connection is being established
- Flashes red (for approx. 90s): malfunction in vehicle; charging not possible

i Vehicles with active ambient lighting: when the charging sequence is activated, the condition of charge is also accompanied by ambient lighting (→ page 155).

Starting the alternating current charging process (mode 2/3)

⚠ DANGER Risk of death when charging at a damaged socket

The charging process uses high voltage.

If the charging cable, the vehicle socket or the mains socket are damaged, you could receive an electric shock.

- ▶ Only use an undamaged charging cable.
- ▶ Avoid mechanical damage such as crushing, abrading or driving over the cable.
- ▶ Have a damaged vehicle socket replaced at a qualified specialist workshop as soon as possible.
- ▶ Never connect the charging cable to a damaged vehicle socket.

! **NOTE** Damage due to overheating of charging cable and charging cable connector

During the charging process, the charging cable and charging cable connector can heat up within their permissible limit values.

The permissible limit values are influenced by the following factors:

- The power supply system and the charging cable are not damaged
- The instructions for handling the charging cable and the control element on the charging cable have been observed

- ▶ If the charging cable or charging cable connector becomes too hot, have the power supply system checked.

! **NOTE** Damaged or dirty vehicle socket when the socket flap is open

- ▶ Always keep the socket cover and the socket flap closed when there is no charging cable connected. This protects the vehicle socket from dirt and damage.
- ▶ Make sure that the socket cover is closed properly before closing the socket flap. This can otherwise result in damage which may prevent the socket flap from being opened again.

! **NOTE** Damage to the vehicle socket or the charging cable connector due to incorrect handling

Do not use excessive force (maximum 67.4 lbf (300 N)) to insert the charging cable connector into the vehicle socket to the stop. You

may otherwise damage the vehicle socket, the charging cable connector or their contacts.

- ▶ If you feel there is increased resistance, pull the charging cable connector out of the socket and reinsert it.

Requirements:

- The transmission is in position **P**.
- The vehicle is unlocked or the distance between the SmartKey and the vehicle does not exceed 3 ft (1 m).
- The vehicle has not been started. The **READY** display in the driver's display is off.
- The charging cable is not taut.

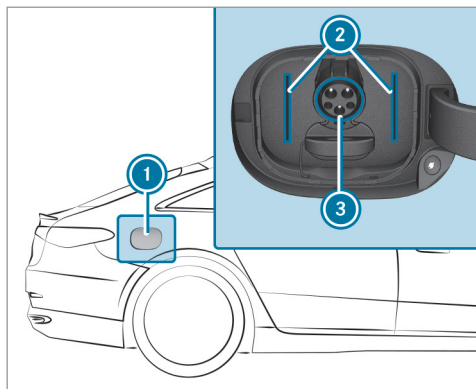

▶ Open socket flap ① via the EQ module of the multimedia system (→ page 298).

or

▶ Press the center of the rear section of socket flap ①.
Socket flap ① swings open and status display ② lights up white.

ⓘ When the vehicle is started (the **READY** display is lit in the driver's display), socket flap ① cannot be opened.

ⓘ Only upper connection ③ is required for the charging cable connector.

▶ To charge at a mains socket, insert the mains plug into the mains socket of the external power source as far as it will go.

▶ Insert the charging cable connector into vehicle socket connection ③ to the stop. If the wallbox/charging station is not equipped with a charging cable, insert the plug of the vehicle's charging cable into the wallbox/charging station socket to the stop.

Make sure that the charging cable is not taut when inserted.

Status display ② flashes orange and, as soon as the high-voltage battery is charged, blue.

ⓘ When the charging sequence for the ambient lighting is activated, the ambient lighting lights up for approximately 30 seconds as with status display ② (→ page 155).

When Sound Experience is activated, different situations, for example the charging cable

connector being inserted and removed or the beginning of the charging process, is accompanied by selected sounds. For information on Sound Experience, please refer to the Digital Operator's Manual.

When the charging cable is connected to the vehicle, the vehicle cannot be started or moved.

At the start of the charging process, the condition of charge display is shown in the driver's display with a charging prediction. The charging prediction refers to the time at which the high-voltage battery will be fully charged.

ⓘ When the vehicle is switched on, a lightning symbol appears next to the condition of charge display in the driver's display during the charging process.

ⓘ Depending on the temperature, the fan and battery cooling system may audibly switch on during the charging process.

ⓘ If the vehicle is idle for lengthy periods and connected to the mains supply, the high-voltage battery will be recharged automatically as needed or when electrical consumers are activated (e.g. the pre-entry climate control).

Ending the alternating current charging process (mode 2/3)

Requirements:

- The distance between the SmartKey and the vehicle does not exceed 3 ft (1 m).

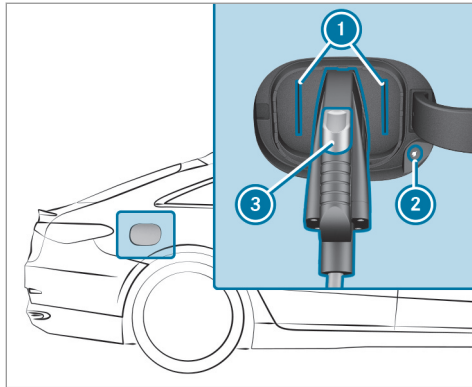

- ▶ Press charging interruption button ②. The charging process is ended. Status display ① lights up white. The vehicle socket is unlocked.
- ▶ Press and hold button ③ on the charging cable connector and remove the charging cable connector from the vehicle socket.
- ⓘ If you cannot remove the charging cable connector, repeat the unlocking procedure. If the charging cable connector is still locked, contact a qualified specialist workshop.
- ⓘ Status display ① indicator lamp remains lit for some time after charging cable connector has been removed and then goes out.
- ▶ Close the socket flap.
- ▶ Remove the charging cable connector from the mains socket, or from the socket on the wallbox/charging station, and stow the vehicle's charging cable safely in the vehicle (→ page 195).

Starting the direct current charging process (mode 4)

⚠ DANGER Risk of death when charging at a damaged socket

The charging process uses high voltage.

If the charging cable, the vehicle socket or the mains socket are damaged, you could receive an electric shock.

- ▶ Only use an undamaged charging cable.
- ▶ Avoid mechanical damage such as crushing, abrading or driving over the cable.
- ▶ Have a damaged vehicle socket replaced at a qualified specialist workshop as soon as possible.
- ▶ Never connect the charging cable to a damaged vehicle socket.

! **NOTE** Damage due to overheating of charging cable and charging cable connector

During the charging process, the charging cable and charging cable connector can heat up within their permissible limit values.

The permissible limit values are influenced by the following factors:

- The power supply system and the charging cable are not damaged
- The instructions for handling the charging cable and the control element on the charging cable have been observed

▶ If the charging cable or charging cable connector becomes too hot, have the power supply system checked.

! **NOTE** Damaged or dirty vehicle socket when the socket flap is open

▶ Always keep the socket cover and the socket flap closed when there is no

charging cable connected. This protects the vehicle socket from dirt and damage.

▶ Make sure that the socket cover is closed properly before closing the socket flap. This can otherwise result in damage which may prevent the socket flap from being opened again.

! **NOTE** Damage to the vehicle socket or the charging cable connector due to incorrect handling

Do not use excessive force (maximum 67.4 lbf (300 N)) to insert the charging cable connector into the vehicle socket to the stop. You may otherwise damage the vehicle socket, the charging cable connector or their contacts.

▶ If you feel there is increased resistance, pull the charging cable connector out of the socket and reinsert it.

Requirements:

- The transmission is in position **P**.

- The vehicle is unlocked or the distance between the SmartKey and the vehicle does not exceed 3 ft (1 m).
- The vehicle has not been started. The **READY** display in the driver's display is off.
- The charging cable is not taut.

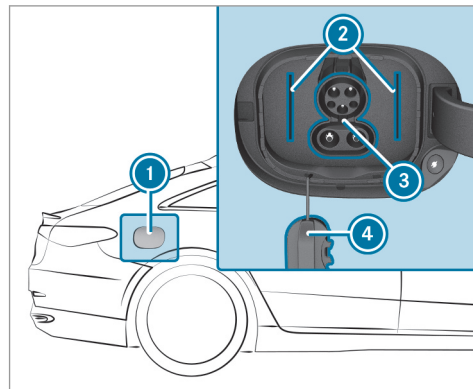

▶ Open socket flap **1** via the EQ module of the multimedia system (→ page 298).

or

- ▶ Press the center of the rear section of socket flap ①.
Socket flap ① swings open and status display ② lights up white.
 - ⓘ When the vehicle is started (the **READY** display is lit in the driver's display), socket flap ① cannot be opened.
 - ▶ Remove socket cover ④ from the lower connection of vehicle socket ③.
 - ⓘ The CCS charging cable connector requires both vehicle socket connections ③.
 - ▶ Insert the charging cable connector into vehicle socket ③ to the stop.
Make sure that the charging cable is not taut when inserted.
- Status display ② flashes orange and, as soon as the high-voltage battery is charged, blue.
- ⓘ When the charging sequence for the ambient lighting is activated, the ambient lighting lights up for approximately 30 seconds as with status display ② (→ page 155).

When Sound Experience is activated, different situations, for example the charging cable connector being inserted and removed or the beginning of the charging process, are accompanied by selected sounds. For information on Sound Experience, please refer to the Digital Operator's Manual.

When the charging cable is connected to the vehicle, the vehicle cannot be started or moved.

At the start of the charging process, the condition of charge display is shown in the driver's display with a charging prediction. The charging prediction refers to the time at which the high-voltage battery will be fully charged.

- ⓘ When the vehicle is switched on, a lightning symbol appears next to the condition of charge display in the driver's display during the charging process.
- ⓘ Depending on the temperature, the fan and battery cooling system may audibly switch on during the charging process.
- ⓘ If the vehicle is idle for lengthy periods and connected to the mains supply, the high-voltage battery will be recharged automatically as

needed or when electrical consumers are activated (e.g. the pre-entry climate control).

Ending the direct current charging process (mode 4)

Requirements:

- The distance between the SmartKey and the vehicle does not exceed 3 ft (1 m).

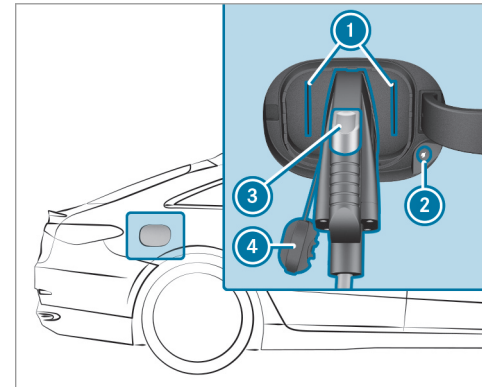

- ▶ Press charging interruption button **2**. The charging process is ended. Status display **1** lights up white. The vehicle socket is unlocked.
- ▶ Press and hold button **3** on the charging cable connector and remove the charging cable connector from the vehicle socket.

- i** If you cannot remove the charging cable connector, unlock the vehicle and repeat the procedure. If the charging cable connector is still locked, contact a qualified specialist workshop.
- i** Status display **1** indicator lamp remains lit for some time after charging cable connector has been removed and then goes out.

- ▶ Insert socket cover **4** into the lower vehicle socket connection.
- ▶ Close the socket flap.

Function of the condition of charge display in the driver's display

- i** The data shown in the illustration is example data.

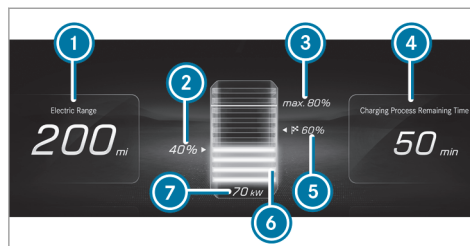

- 1** Range at current condition of charge
- 2** Current condition of charge of the high-voltage battery
- 3** Maximum condition of charge (depending on the setting)
- 4** Time remaining until completely charged (until the selected maximum condition of charge is reached)
- 5** Condition of charge recommended by Range Assistant to reach the next destination
- 6** Dynamic condition of charge display
- 7** Current charging capacity

- i** Specified remaining range **1** may vary due to different factors, e.g. driving style or topography.

When the vehicle is connected to the mains supply and is switched off, the driver's display shows the condition of charge display for approximately two minutes.

- i** The value of current charging capacity **7** can differ from the display on the charging station. At a charging capacity of 10 kW or higher, the value in the condition of charge display is rounded off and shown without a decimal place.

The value in **4** varies depending on the setting of the charging process. It displays the charging prediction, e.g. the time at which the selected condition of charge will be reached or the condition of charge at the pre-selected departure time.

Configuring the charging settings

Multimedia system:

  **EQ**  **Charging Options**

Setting the charging program

- ▶ Select **Home**, **Work** or **Standard**.

Unlocking the charging cable (mode 3 or 4)

When the function is active, the charging cable is unlocked when the maximum charge level is reached.

- ▶ Select **Home** or **Work**.
- ▶ Activate or deactivate **Unlock Charging Cable**.

Activating or deactivating location-based charging

- ▶ Select **Charge at Home** or **Charge at Work**.
- ▶ Activate or deactivate **Select Based on Location**.

When the function is activated, the vehicle's current position is saved as one of the selected options. When the address is reached again, the charging program is automatically switched over as soon as parking position P is engaged.

Activating or deactivating ECO charging

- ▶ Activate or deactivate the function.

The **ECO Charging** function limits the charging voltage at charging stations to conserve the vehicle's battery.

Setting the departure time

The set departure times are used for the vehicle's pre-entry climate control and for predictions regarding the approximate state of charge and range at the time selected. The charging process always starts immediately, irrespective of the next departure time.

- ▶ Select **Departure Time**.

The following charging times can be selected:

- Individual charging times
- One **Week Profile**

Setting an individual departure time

- ▶ Select **Add New Time** and set a new departure time.

or

- ▶ Select  and adapt an existing departure time.

Setting the repeat days

- ▶ Select **Add New Time** and set a new departure time.
- ▶ Mark the relevant weekdays for which the departure time will apply and confirm with **OK**.



or

- ▶ Select  and edit existing repeat days.

Setting a break in the charging process

Up to four breaks in the charging process can be set during which the vehicle is not charged, even if it is connected to a charging station.

- ▶ Select **Charging Pauses**.
- ▶ Select **Add New Time** and then set and save the times for the beginning and end of the break.
- ▶ Activate or deactivate the charging breaks that have been set.

Set charging breaks can be edited with the  button or deleted with the  button.

Parking

Parking the vehicle

⚠ WARNING Risk of accident and injury caused by an insufficiently secured vehicle rolling away

If the vehicle is not securely parked sufficiently, it can roll away in an uncontrolled way even at a slight downhill gradient.

- ▶ On uphill or downhill gradients, turn the front wheels so that the vehicle rolls towards the curb if it starts moving.
- ▶ Apply the parking brake.
- ▶ Switch the transmission to position **P**.

⚠ WARNING Risk of accident and injury due to children left unattended in the vehicle

If children are left unsupervised in the vehicle, they could, in particular:

- open doors, thereby endangering other persons or road users.

- get out and be struck by oncoming traffic.
- operate vehicle equipment and become trapped, for example.

In addition, the children could also set the vehicle in motion, for example by:

- releasing the parking brake.
 - changing the transmission position.
 - starting the vehicle.
- ▶ Never leave children unattended in the vehicle.
- ▶ When leaving the vehicle, always take the SmartKey with you and lock the vehicle.
- ▶ Keep the vehicle SmartKey out of reach of children.

! NOTE Damage to the vehicle due to it rolling away

- ▶ Always secure the vehicle against rolling away.

! NOTE Damage due to the vehicle lowering

The vehicle can lower because of temperature differences or longer non-operational times. This can cause damage to parts of the body.

- ▶ When stopping the vehicle and when driving off, make sure that there are no obstacles such as curbs under or in the immediate vicinity of the body.

i If you park the vehicle for a long period, observe the following notes:

- Make sure the high-voltage battery has a sufficient state of charge, especially at very low outside temperatures. In this way you can avoid any problems when the vehicle is subsequently started.
- If possible, avoid parking spaces in direct sunlight.

Observe the notes on charging the high-voltage battery (→ page 195).

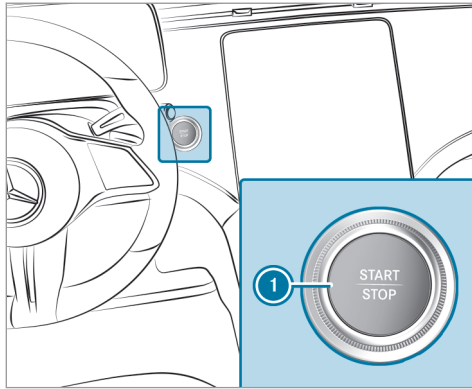

Vehicles with central display

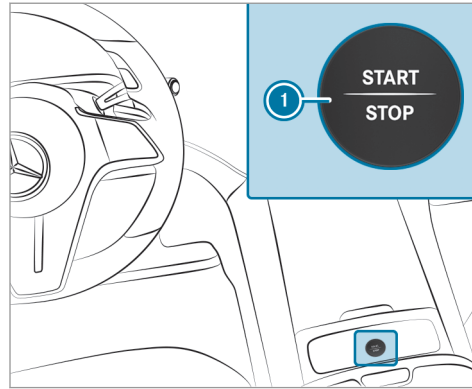

Vehicles with MBUX Hyperscreen

- ▶ Bring the vehicle to a standstill by pressing the brake pedal.
- ▶ On gradients, turn the front wheels so that the vehicle will roll towards the curb if it starts moving.
- ▶ Apply the electric parking brake.

- ▶ Engage transmission position **P** in a stationary vehicle with the brake pedal applied (→ page 194).
 - ▶ Switch off the vehicle by pressing button ①.
 - ▶ Release the service brake slowly.
 - ▶ Get out of the vehicle and lock it.
- ① When you park the vehicle, you can still operate the side windows and the panoramic sliding sunroof for approximately four minutes if the driver's door is closed.

Garage door opener

Programming buttons for the garage door opener

⚠ WARNING Risk of injury by becoming trapped when opening and closing a garage door

When you operate or program a garage door with an integrated garage door opener, persons can become trapped or struck by the garage door if they stand within its range of movement.

- ▶ Always make sure that nobody is within the range of the garage door's movement.

Only operate the following doors using the garage door opener:

- Doors with a safety stop and reversing feature
- Doors which conform to the current U.S. safety standards

Before programming the garage door opener, park the vehicle outside the garage. Make sure that the vehicle is switched on but not started.

Requirements:

- The vehicle has been parked outside the garage or outside the range of movement of the door.
- The vehicle is switched on.
- The vehicle has not been started.

- ⓘ The garage door opener function is always available when the vehicle is switched on.

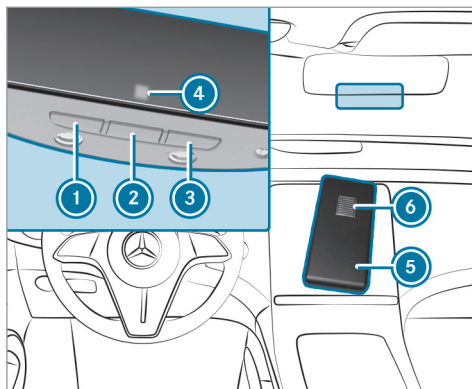

- ▶ Check if the transmitter frequency of the remote control has the frequency range of 280 to 868 MHz.

Radio equipment approval number:

- NZLMUAHL5 (USA)
- 4112A-MUAHL5 (Canada)

- ▶ Press and hold button ①, ② or ③ that you wish to program. Indicator lamp ④ flashes yellow.

- ⓘ It can take up to 20 seconds before the indicator lamp flashes yellow.

- ▶ Release the previously pressed button. Indicator lamp ④ continues to flash yellow.

- ▶ Point remote control ⑤ from a distance of 0.4 in (1 cm) to 3 in (8 cm) towards button ①, ② or ③.

- ▶ Press and hold button ⑥ of remote control ⑤ until one of the following signals appears:

- Indicator lamp ④ lights up green continuously. Programming is complete.
- Indicator lamp ④ flashes green. Programming was successful. Additionally, synchronization of the rolling code with the door system must be carried out.

- ▶ If indicator lamp ④ does not light up or flash green: repeat the procedure.

- ▶ Release all of the buttons.

- i** The remote control for the door drive is not included in the scope of delivery of the garage door opener.

Synchronizing the rolling code

Requirements:

- The door system uses a rolling code.
- The vehicle must be within range of the garage door or door drive.
- The vehicle as well as persons and objects are located outside the range of movement of the door.

- ▶ Press the programming button on the door drive unit. Initiate the next step within approximately 30 seconds.
- ▶ Press previously programmed button **1**, **2** or **3** repeatedly until the door closes. When the door closes, programming is completed.
- i** Please also read the operating instructions for the door drive.

Troubleshooting when programming the remote control

- ▶ Check if the transmitter frequency of remote control **5** is supported.
- ▶ Replace the batteries in remote control **5**.
- ▶ Hold remote control **5** at various angles from a distance of 0.4 in (1 cm) to 3 in (8 cm) front of the inside rearview mirror. You should test every position for at least 25 seconds before trying another position.
- ▶ Hold remote control **5** at the same angles at various distances in front of the inside rearview mirror. You should test every position for at least 25 seconds before trying another position.
- ▶ On remote controls that transmit only for a limited period, press button **6** on remote control **5** again before transmission ends.
- ▶ Angle the antenna line of the garage door opener unit towards the remote control.
- i** It is possible that older garage doors cannot be operated using the remote control in the inside rearview mirror even after you have successfully performed the measures descri-

bed above. If this is the case, contact the HomeLink® Hotline.

- i** Support and additional information on programming:
- On the toll free HomeLink® Hotline on 1-800-355-3515
 - On the Internet at <https://www.homelink.com/mercedes>



Opening or closing the garage door

Requirements:

- The corresponding button is programmed to operate the door.
- ▶ Press and hold buttons **1**, **2** or **3** until the door opens or closes.
- ▶ If indicator lamp **4** flashes yellow after approximately 20 seconds: press and hold the previously pressed button again until the door opens or closes.

Clearing the garage door opener memory

- ▶ Press and hold buttons **1** and **3**. Indicator lamp **4** lights up yellow.

- ▶ If indicator lamp  flashes green: release buttons  and .
- The entire memory has been deleted.

Electric parking brake

Function of the electric parking brake (applying automatically)

 **WARNING** Risk of accident and injury due to children left unattended in the vehicle

If children are left unsupervised in the vehicle, they could, in particular:

- open doors, thereby endangering other persons or road users.
- get out and be struck by oncoming traffic.
- operate vehicle equipment and become trapped, for example.

In addition, the children could also set the vehicle in motion, for example by:

- releasing the parking brake.
- changing the transmission position.

- starting the vehicle.
- ▶ Never leave children unattended in the vehicle.
- ▶ When leaving the vehicle, always take the SmartKey with you and lock the vehicle.
- ▶ Keep the vehicle SmartKey out of reach of children.

The electric parking brake is applied if the transmission is in position  and one of the following conditions is fulfilled:



- The vehicle is switched off.
- The seat belt tongue is not inserted in the seat belt buckle of the driver's seat and the driver's door is opened.

 To prevent application: pull the handle of the electric parking brake (→ page 215).

In the following situations, the electric parking brake is also applied:

- The HOLD function is keeping the vehicle stationary.

- Active Parking Assist is keeping the vehicle stationary.
- Active Distance Assist DISTRONIC is bringing the vehicle to a standstill.
- **In addition, one of the following conditions must be fulfilled:**
 - The vehicle is switched off.
 - The seat belt tongue is not inserted in the seat belt buckle of the driver's seat and the driver's door is opened.
 - There is a system malfunction.
 - The power supply is insufficient.
 - The vehicle is stationary for a lengthy period.

When the electric parking brake is applied, the red  (USA) or  (Canada) indicator lamp lights up in the driver's display.

Function of the electric parking brake (releasing automatically)

The electric parking brake is released when the following conditions are fulfilled:

- The driver's door is closed.

- The vehicle has been started.
- The transmission is in position **D** or **R** and you depress the accelerator pedal or you shift from transmission position **P** to **D** or **R** when on level ground.
- If the transmission is in position **R**, the tailgate must be closed.
- The seat belt tongue is inserted into the seat belt buckle of the driver's seat.
If the seat belt tongue is not inserted into the seat belt buckle of the driver's seat, one of the following conditions must be fulfilled:
 - You shift from transmission position **P**.
or
 - You have previously driven at speeds greater than 2 mph (3 km/h).

When the electric parking brake is released, the red **PARK** (USA) or **(P)** (Canada) indicator lamp in the driver's display goes out.

Applying/releasing the electric parking brake manually

Applying

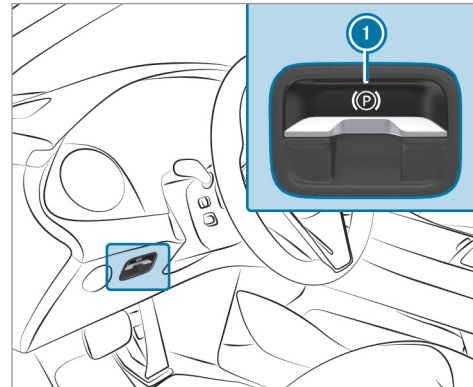

- ▶ Push handle **1**.
The red **PARK** (USA) or **(P)** (Canada) indicator lamp lights up in the driver's display.

- i** The electric parking brake is only securely applied if the red **PARK** (USA) or **(P)** (Canada) indicator lamp is lit continuously.

Releasing

- ▶ Switch on the vehicle.
- ▶ Pull handle **1**.
The red **PARK** (USA) or **(P)** (Canada) indicator lamp in the driver's display goes out.

Emergency braking

- ▶ Press and hold handle **1**.
As long as the vehicle is driving, the **Please Release Parking Brake** message is displayed and the red **PARK** (USA) or **(P)** (Canada) indicator lamp flashes.
When the vehicle has been braked to a standstill, the electric parking brake is applied. The red **PARK** (USA) or **(P)** (Canada) indicator lamp lights up in the driver display.

Information on collision detection on a parked vehicle

If a collision is detected when the tow-away alarm is armed on a locked vehicle, you will receive a notification in the multimedia system when you switch the vehicle on.

You will receive information about the following points:

- The area of the vehicle that may have been damaged.
- The force of the impact.

The following situation can lead to inadvertent activation:

- The parked vehicle is moved, for example, in a two-story garage.

- ① Disarm the tow-away alarm in order to prevent inadvertent activation. If you disarm the tow-away alarm, collision detection will also be deactivated. You can permanently deactivate collision detection via the multimedia system (→ page 216).

- ① If the battery is severely discharged, the function for detecting a collision on a parked vehicle is automatically deactivated to facilitate the next engine start.

System limits

Detection may be restricted in the following situations:

- The vehicle is damaged without impact, for example, if an outside mirror is torn off or the paint is damaged by a key
- An impact occurs at low speed
- The electric parking brake is not applied

Setting collision detection on a parked vehicle

Multimedia system:

→  » Settings » Vehicle
» Open/Close » Vehicle Protection

- ▶ Activate or deactivate the function via **Collision Notification**.

- ① A maximum of three incidents can be registered. Up to 15 photos are taken for every incident. In the event of another incident, the

photos of the first incident will be overwritten if they have not been deleted already.

Activating or deactivating the collision photos function

Note possible legal restrictions in some countries regarding automatic recording of the vehicle surroundings.

- ▶ Activate or deactivate **Take photos**.

Transferring the collision photos with the Mercedes me app

- ▶ Select **Upload to Mercedes me**.
- ▶ Select **Upload Automatically**.
- ▶ Scan the generated QR code on the central display with the Mercedes me App. The encrypted collision photos will then be uploaded to Mercedes me.

- ① Any device that can scan QR codes can be used to view the collision photos in the Mercedes me App.

Copying the collision photos to a USB flash drive

- ▶ Connect a USB flash drive .

- ▶ Select **Manage Collision Photos**.
- ▶ Select **Copy (USB)**.
All collision photos are copied to the USB flash drive.
- ⓘ To ensure secure operation, only use with FAT32 or exFAT formatted USB storage devices.

Deleting collision photos

- ▶ Select **Manage Collision Photos**.
- ▶ Select **Delete**.
All collision photos will be deleted.

Driving and driving safety systems

Driving systems and your responsibility

Your vehicle is equipped with driving systems which assist you in driving, parking and maneuvering the vehicle. The driving systems are only aids. They are not a substitute for your attention to the surroundings and do not relieve you of your responsibility pertaining to road traffic law. The driver is always responsible for maintaining a safe distance to the vehicle in front, for vehicle speed,

for braking in good time and for staying in lane. Pay attention to the traffic conditions at all times and intervene when necessary. Be aware of the limitations regarding the safe use of these systems.

Driving systems can neither reduce the risk of accident if you fail to adapt your driving style nor override the laws of physics. They cannot always take into account road, weather or traffic conditions.

Information on vehicle sensors and cameras

Some driving and driving safety systems use cameras as well as radar or ultrasonic sensors to monitor the area in front of, behind or next to the vehicle.

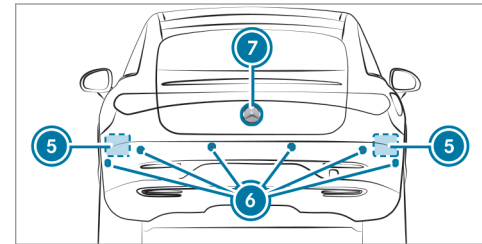
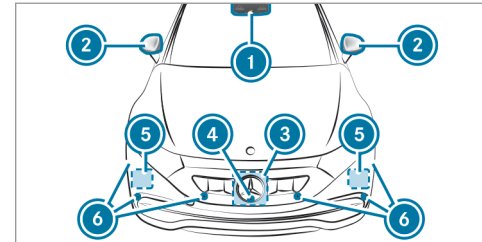

- ① Multifunction camera
- ② Cameras in the outside mirrors
- ③ Front radar
- ④ Front camera

- 5 Corner radars
- 6 Ultrasonic sensors
- 7 Rear view camera

⚠ WARNING Risk of accident due to restricted detection performance of vehicle sensors and cameras

If the area around vehicle sensors or cameras is covered, damaged or dirty, certain driving and safety systems cannot function correctly. There is a risk of an accident.

- ▶ Keep the area around vehicle sensors or cameras clear of any obstructions and clean.
- ▶ Have damage to the bumper, radiator grille or stone chipping in the area of the front and rear windows repaired at a qualified specialist workshop.

Particularly, keep the areas around the sensors and cameras free of dirt, ice or slush (→ page 359). The sensors and cameras must not be covered and the detection ranges around them must be kept free. Do not attach additional

license plate brackets, advertisements, stickers, foils or foils to protect against stone chippings in the detection range of the sensors and cameras. Make sure that there are no overhanging loads protruding into the detection range.

If there is damage to a bumper or the radiator grille, or after an impact, have the function of the sensors checked at a qualified specialist workshop. Have damage or stone chipping in the area of the cameras on the windshield and rear window repaired at a qualified specialist workshop.

- ⓘ The rear view camera can extend and retract automatically for the purpose of calibration, even though there is no camera image in the display.

Overview of driving systems and driving safety systems

- ABS (→ page 219)
- BAS (→ page 219)
- ESP® (→ page 220)
- ESP® Crosswind Assist (→ page 221)
- EBD (→ page 221)

- STEER CONTROL
- HOLD function (→ page 221)
- Hill Start Assist (→ page 223)
- Valet service mode (→ page 223)
- Beginner driver mode (→ page 224)
- ATTENTION ASSIST (→ page 224)
- Traffic Sign Assist (→ page 246)
- Traffic light view (→ page 250)
- AIRMATIC (→ page 258)

Driving Assistance package

- ⓘ The availability of some functions or sub-functions of the Driving Assistance Package is equipment- or country-specific. The functions of your Driving Assistance Package may differ from the functions listed here. Active Distance Assist DISTRONIC, Active Blind Spot Assist, Active Brake Assist, Active Lane Keeping Assist and Active Emergency Stop Assist are also available without the Driving Assistance Package, albeit with restricted functionality.

- Active Distance Assist DISTRONIC (→ page 228)
- Active Speed Limit Assist (→ page 233)
- Route-based speed adaptation (→ page 234)
- Active Brake Assist (→ page 242)
- Active Steering Assist (→ page 236)
- Active Emergency Stop Assist (→ page 238)
- Active Lane Change Assist (→ page 239)
- Active Stop-and-Go Assist (→ page 235)
- Active Blind Spot Assist with exit warning (→ page 252)
- Active Lane Keeping Assist (→ page 255)
- PRE-SAFE® Impulse Side (→ page 58)

Parking Package

- i** The availability of individual functions is country and equipment-dependent.
- Rear view camera (→ page 260)
 - Surround view camera (→ page 262)
 - Parking Assist PARKTRONIC (→ page 266)
 - Active Parking Assist (→ page 270)

- Remote Parking Assist (→ page 275)
- Memory Parking Assist (country-dependent) (→ page 282)

Functions of ABS

The Anti-lock Brake System (ABS) regulates the brake pressure in critical driving situations:

- During braking, for instance, at maximum full-stop braking or if there is insufficient tire traction, the wheels are prevented from locking.
- Vehicle steerability while braking is ensured.

If ABS intervenes when braking, you will feel a pulsing in the brake pedal. The pulsating brake pedal can be an indication of hazardous road conditions and can serve as a reminder to take extra care while driving.

System limits

- ABS is active from speeds of approx. 3 mph (5 km/h).
- ABS may be impaired or may not function if a malfunction has occurred and the yellow  ABS warning lamp lights up continuously in

the instrument cluster after the vehicle is started.

Function of BAS

⚠ WARNING Risk of an accident caused by a malfunction in BAS (Brake Assist System)

If BAS is malfunctioning, the braking distance in an emergency braking situation is increased.

▶ Depress the brake pedal with full force in emergency braking situations. ABS prevents the wheels from locking.

The Brake Assist System (BAS) supports your emergency braking situation with additional brake force.

If you depress the brake pedal quickly, BAS is activated:

- BAS automatically boosts the brake pressure.
- BAS can shorten the braking distance.
- ABS prevents the wheels from locking.

The brakes will function as usual once you release the brake pedal. BAS is deactivated.

Function of ESP®

⚠ WARNING Risk of skidding if ESP® is deactivated

If you deactivate ESP®, ESP® cannot carry out vehicle stabilization.

▶ ESP® should only be deactivated in the following situations.

! NOTE Mercedes-AMG vehicles

▶ Observe the notes in the Supplement. You could otherwise fail to recognize dangers.

The Electronic Stability Program (ESP®) can monitor and improve driving stability and traction in the following situations within physical limits:

- When pulling away on wet or slippery roads.
- When braking.

- In strong side winds when you are driving faster than 50 mph (80 km/h).

If the vehicle deviates from the direction desired by the driver, ESP® can stabilize the vehicle by intervening in the following ways:

- One or more wheels are braked.
- The drive system output is adapted according to the situation.

ESP® is deactivated if the  ESP® OFF warning lamp lights up continuously on the driver display:

- Driving stability will no longer be improved.
- **Vehicles with trailer hitch:** Stabilization of the vehicle/trailer combination is no longer active.
- Crosswind Assist is no longer active.
- The drive wheels could spin.
- ETS/4ETS traction control is still active.

i When ESP® is deactivated, you are still assisted by ESP® when braking.

If the  ESP® warning lamp flashes on the driver display, one or several wheels has reached its grip limit:

- Adapt your driving style to suit the current road and weather conditions.
- Do not deactivate ESP®.
- Only depress the accelerator pedal as far as is necessary when pulling away.

Deactivate ESP® in the following situations to improve traction:

- When using snow chains.
- In deep snow.
- On sand or gravel.

i Spinning the wheels results in a cutting action, which enhances traction.

If the  ESP® warning lamp lights up continuously, ESP® is not available due to a malfunction.

Observe the following information:

- Indicator and warning lamps (→ page 484)
- Display messages (→ page 420)

ETS/4ETS (Electronic Traction System)

ETS/4ETS traction control is part of ESP® and makes it possible to pull away and accelerate on a slippery road.

ETS/4ETS can improve the vehicle's traction by intervening in the following ways:

- The drive wheels are braked individually if they spin.
- More drive torque is transferred to the wheel or wheels with traction.

Influence of drive programs on ESP®

The drive programs enable ESP® to adapt to different weather and road conditions as well as the driver's preferred driving style. Depending on the selected drive program, the appropriate ESP® mode will be activated. You can select the drive programs using the DYNAMIC SELECT button (→ page 192).

Function of ESP® Crosswind Assist

ESP® Crosswind Assist detects sudden gusts of side wind and helps the driver to keep the vehicle in the lane:

- ESP® Crosswind Assist is active at vehicle speeds above approx. 50 mph (80 km/h) when driving straight ahead or cornering slightly.
- The vehicle is stabilized by means of individual brake application on one side.

Activating/deactivating ESP® (Electronic Stability Program)

Multimedia system:



! NOTE Mercedes-AMG vehicles

- ▶ Observe the notes in the Supplement. You could otherwise fail to recognize dangers.

- ▶ Select **ESP**.

- ▶ Select **On** or  **Off**.

ESP® is deactivated if the  ESP® OFF warning lamp lights up continuously in the driver display.

Observe any information on warning lamps and display messages which may be shown in the driver display.

Function of EBD

Electronic Breakforce Distribution (EBD) is characterized by the following:

- Monitoring and regulating the brake pressure on the rear wheels.
- Improved driving stability when braking, especially on bends.

HOLD function

HOLD function

The HOLD function holds the vehicle at a standstill without requiring you to depress the brake pedal, e.g. while waiting in traffic.

222 Driving and parking

The HOLD function is only an aid. The responsibility for the vehicle safely standing still remains with the driver.

System limits

The HOLD function is only intended to provide assistance when driving and is not a sufficient means of safeguarding the vehicle against rolling away when stationary.

- The incline must not be greater than 30%.

Activating/deactivating the HOLD function

▲ WARNING Risk of an accident due to the HOLD function being active when you leave the vehicle

If the vehicle is only braked with the HOLD function it could, in the following situations, roll away:

- If there is a malfunction in the system or in the power supply.
- If the HOLD function is deactivated by depressing the accelerator pedal or brake pedal, e.g. by a vehicle occupant.

▶ Always secure the vehicle against rolling away before you leave it.

Requirements:

- The vehicle is stationary.
- The driver's door is closed or the seat belt on the driver's side is fastened.
- The vehicle has been started.
- The electric parking brake is released.
- Active Distance Assist DISTRONIC is deactivated.
- The transmission is in position **[D]**, **[R]** or **[N]**.

Activating the HOLD function

- ▶ Depress the brake pedal, and after a short time quickly depress further until the **[HOLD]** display appears in the driver's display.
- ▶ Release the brake pedal.

Deactivating the HOLD function

- ▶ Depress the accelerator pedal to pull away.
- or

- ▶ Depress the brake pedal until the **[HOLD]** display disappears from the driver's display.

The HOLD function is deactivated in the following situations:

- Active Distance Assist DISTRONIC is activated.
- The transmission is shifted to position **[P]**.
- The vehicle is secured with the electric parking brake.

In the following situations, the vehicle is held by transmission position **[P]** and/or by the electric parking brake:

- The seat belt is unfastened and the driver's door is opened.
- The vehicle is switched off.
- There is a system malfunction.
- The power supply is insufficient.

In addition, the **Brake Immediately** message may appear in the driver's display and a horn tone may sound at regular intervals.

- ▶ Immediately depress the brake pedal firmly until the warning message disappears. The HOLD function is deactivated.
- ▶ Additionally secure the vehicle against rolling away.

Function of Hill Start Assist

Hill Start Assist holds the vehicle for a short time when pulling away on a hill under the following conditions:

- The transmission is in position **D** or **R**.
- The electric parking brake is released.

This gives you enough time to move your foot from the brake pedal to the accelerator pedal and depress it before the vehicle begins to roll away.

⚠ WARNING Risk of accident and injury due to the vehicle rolling away

After a short time, Hill Start Assist no longer holds the vehicle.

- ▶ Swiftly move your foot from the brake pedal to the accelerator pedal. Do not

leave the vehicle when it is being held by Hill Start Assist.

Valet service mode

Function of the valet service mode

In valet service mode, the vehicle acceleration is limited to reduce the risk of damage to and improper use of the vehicle when it is handed over to third parties.

Valet service mode is characterized by the following:

- The maximum speed that can be driven is limited to 50 mph (80 km/h).
- Drive programs **S*** and **I*** are not available.
- ESP® cannot be deactivated.
- Profiles that are still logged in are logged out and unprotected profiles are secured.

Activating or deactivating valet service mode

Requirements:

- For activation: the vehicle is stationary.

- For deactivation: park position **P** is engaged.

Multimedia system:

→  **» Apps » Valet service mode**

- ▶ Activate or deactivate the function. If valet service mode is activated, an indicator lamp in the driver's display lights up.
- ⓘ Alternatively, valet service mode can be activated or deactivated via the Mercedes me connect App. Further information on Mercedes me connect (→ page 339)
- ⓘ Valet service mode is protected from deactivation by third parties only in combination with Mercedes me connect. If the vehicle is connected to Mercedes me connect, only the profile that activated the mode or the established main user can deactivate it again.
- ⓘ Valet service mode remains active even following a change of profile or after the vehicle is switched on or off, and must be deliberately deactivated by the authorized user.

Beginner driver mode

Function of the beginner driver mode

In beginner driver mode, the vehicle acceleration is limited to increase safety for inexperienced drivers.

Beginner driver mode is characterized by the following:

- The maximum speed that can be driven is limited to 75 mph (120 km/h).
- Drive programs **S** and **I** are not available.
- ESP® cannot be deactivated.

Activating or deactivating beginner driver mode

Requirements:

- For activation: the vehicle is stationary.
- For deactivation: park position **P** is engaged.

Multimedia system:

→  >> Apps >> Beginner driver mode

- ▶ Activate or deactivate the function.
If beginner driver mode is activated, an indicator lamp in the driver's display lights up.

- ⓘ Alternatively, beginner driver mode can be activated or deactivated via the Mercedes me connect app.
Further information on Mercedes me connect (→ page 339)
- ⓘ Beginner driver mode is protected from deactivation by third parties only in combination with Mercedes me connect. If the vehicle is connected to Mercedes me connect, only the profile that activated the mode or the established main user can deactivate it again.
- ⓘ Beginner driver mode remains active even following a change of profile or after the vehicle is switched on or off, and must be deliberately deactivated by the authorized user.

ATTENTION ASSIST

Function of ATTENTION ASSIST with microsleeep detection

- ⓘ The microsleeep detection subfunction is only available in combination with the driver camera.

ATTENTION ASSIST assists you on long, monotonous journeys, e.g. on highways and trunk roads. If indicators of fatigue or increasing lapses in concentration on the part of the driver are detected, the system suggests taking a break.

ATTENTION ASSIST is only an aid. It cannot always detect fatigue or lapses in concentration in time. The system is not a substitute for a well-rested and attentive driver. On long journeys, take regular breaks in good time that allow for adequate recuperation.

You can choose between two settings:

- **Standard:** normal system sensitivity.
- **Sensitive:** higher system sensitivity. The driver is warned earlier and the attention level detected by ATTENTION ASSIST is adapted accordingly.

If drowsiness or increasing lapses in concentration are detected, the **ATTENTION ASSIST: Take a Break!** warning appears in the driver's display. You can acknowledge the message and take a break where necessary. If you do not take a break and ATTENTION ASSIST continues to detect

increasing lapses in concentration, you will be warned again after a minimum of 15 minutes.



The following information is displayed in the driver's display:

- The length of the journey since the last break
- The attention level determined by ATTENTION ASSIST:
 - The more segments ② of the circle displayed, the higher the detected attention level.
 - Fewer segments ② are displayed in the circle as the attention level decreases.
- Microsleep detection ① status:
 - Deactivated: display ① is hidden.
 - Activated but not operational: display ① is gray.
 - Activated and operational: display ① is green.

If ATTENTION ASSIST is unable to calculate the attention level and cannot issue a warning, the **System Suspended** message appears.

If the system, which uses the driver camera, detects indicators of microsleep, the **ATTENTION ASSIST Nodding Off Take a Break!** warning message appears in the driver's display and a warning tone sounds simultaneously. This warning message must be confirmed by Touch Control. It is recommended that you take a break immediately.

If a warning is given in the driver's display, the multimedia system offers to search for a rest area. You can select a rest area and start navigation to this rest area.

If you restart the vehicle, ATTENTION ASSIST with microsleep detection is automatically activated. The last selected sensitivity level remains stored.

System limits

ATTENTION ASSIST is active in the 37 mph (60 km/h) to 124 mph (200 km/h) speed range.

The microsleep detection function is available at a speed of 12.5 mph (20 km/h) and above.

Particularly in the following situations, ATTENTION ASSIST only functions in a restricted manner and warnings may be delayed or not occur:

- If you have been driving for less than approximately 30 minutes.
- If the road condition is poor (uneven road surface or potholes).
- If there is a strong side wind.
- If you adopt a sporty driving style (high cornering speeds or high rates of acceleration).
- If the Steering Assist function of Active Distance Assist DISTRONIC is active.
- If the clock is set to the incorrect time.
- If you change lanes and vary your speed frequently in active driving situations.

Microsleep detection also does not function when the driver camera cannot detect the driver's eyes, for example as a result of the following factors:

- The driver's eyes are covered due to the steering column position, for example.
- Poor ambient light.
- Some types of eyeglasses or sunglasses.
- The driver's line of vision is outside the driver camera's field of vision.

Also observe any information regarding display messages that can be displayed in the driver's display.

The tiredness and alertness assessment of ATTENTION ASSIST with microsleep detection is reset and restarted when continuing the journey in the following situations:

- You switch off the vehicle.
- If you unfasten your seat belt and open the driver's door (e.g. to change drivers or take a break).

Setting ATTENTION ASSIST

Multimedia system:

   Settings  Assistance
 Assistance  ATTENTION ASSIST

Setting the sensitivity

- ▶ Tap the current setting.
- ▶ Select **Standard** or **Sensitive**.

Activating/deactivating the microsleep warning

- ▶ Activate/deactivate **Microsleep Warning**.

Speed control cruise control

Function of cruise control

Cruise control regulates the speed to the value selected by the driver.

If you accelerate to overtake, for example, the stored speed is not deleted. If you remove your foot from the accelerator pedal after overtaking, cruise control will resume speed regulation back to the stored speed.



You can store any speed above 15 mph (20 km/h) up to the maximum design speed, or

up to the speed recommended by Range Assistant.

Observe the notes on driving systems and your responsibility; you may otherwise fail to recognize dangers (→ page 217).

Mercedes-AMG vehicles: Cruise control is available up to a maximum speed of 155 mph (250 km/h).

Displays in the driver's display

-  (gray): cruise control is selected but not yet active, or temporarily passive.
-  (green): cruise control is active.

A stored speed appears under the  display and is indicated in the speedometer.

System limits

Cruise control may be unable to maintain the stored speed on uphill gradients. The stored speed is resumed when the gradient evens out.

Increase recuperation in good time on long and steep downhill gradients. Take particular note of this when driving a laden vehicle. By doing so, you will make use of the electric motor's braking

effect to charge the high-voltage battery. This relieves the load on the brake system and prevents the brakes from overheating and wearing too quickly.

Do not use cruise control in the following situations:

- In traffic situations which require frequent changes of speed, e.g. in heavy traffic, on winding roads
- On slippery roads. Accelerating can cause the drive wheels to lose traction and the vehicle could then skid.
- When visibility is poor

Operating cruise control

⚠ WARNING Risk of accident due to stored speed

If you call up the stored speed and this is lower than your current speed, the vehicle decelerates.

- ▶ Take into account the traffic situation before calling up the stored speed.

Requirements:

- Cruise control is selected.
- ESP® must be activated, but not intervening.
- The vehicle speed is at least 15 mph (20 km/h).
- The transmission is in position **D**.

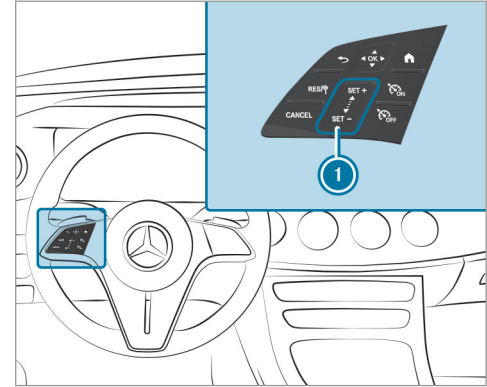

Steering wheel control panel for cruise control

- RES+** Adopts the stored/detected speed
- CANCEL** Deactivates cruise control
- ON** Activates cruise control
- OFF** Deactivates cruise control
- 1** Control panel to increase/decrease speed

Activating cruise control

- ▶ Press **ON**.

Activating cruise control

▶ Press **SET/+** or **SET/-** on control panel ①.
The current speed is stored and maintained by the vehicle.

or

▶ Press **RES/Ⓢ**.
The last stored speed is called up and maintained by the vehicle.

If the last stored speed has previously been deleted, the current vehicle speed is stored.

① When you switch off the vehicle, the last speed stored is deleted.

Increasing/decreasing the stored speed

▶ To increase the stored speed: swipe upwards from the bottom of control panel ①.

- The stored speed is increased by 1 mph (1 km/h).

▶ To decrease the stored speed: swipe downwards from the top of control panel ①.

- The stored speed is decreased by 1 mph (1 km/h).

or

▶ Briefly press **SET/+** or **SET/-** on control panel ①.

The stored speed is increased or decreased to the following values depending on the unit:

- **mph:** the next value ending in 5
- **km/h:** the next value ending in 0

or

▶ Accelerate the vehicle to the desired speed.

▶ Press **SET/+** on control panel ①.

Adopting a detected speed

If cruise control is activated and Traffic Sign Assist has detected a speed restriction sign with a maximum permissible speed and this is displayed in the driver display:

▶ Press **RES/Ⓢ**.

The maximum permissible speed shown by the traffic sign is stored and the vehicle maintains this speed.

Deactivating cruise control

▶ Press **CANCEL**.

Deactivating cruise control

▶ Press **ESP OFF**.

① If you brake, deactivate ESP® or if ESP® intervenes, cruise control is deactivated.

Active Distance Assist DISTRONIC

Function of Active Distance Assist DISTRONIC

Active Distance Assist DISTRONIC maintains the set speed on free-flowing roads. If vehicles in front are detected, the set distance is maintained, if necessary, until the vehicle comes to a halt. The vehicle accelerates or brakes depending on the distance to the vehicle in front and the set speed. The speed and distance to the vehicle in front are set and saved using the steering wheel.

Available speed range:

- **Vehicles without Driving Assistance Package:**
15 mph (20 km/h) – 100 mph (160 km/h)
- **Vehicles with Driving Assistance Package:**
15 mph (20 km/h) – 130 mph (210 km/h)

The adjustable set speed can vary due to the following factors:

- The stored speed limit (e.g. winter tire limit)

- The maximum speed recommended by range monitoring

Other features of Active Distance Assist DISTRONIC:

- Adjusts the driving style depending on the selected drive program (energy-saving, comfortable or dynamic) (→ page 191)
- Initiates acceleration to the stored speed if the turn signal indicator is switched on to change to the overtaking lane
- **Vehicles with Driving Assistance Package:**
 - Reacts to stationary vehicles detected in urban speed ranges (except bicycles and motorcycles)
 - Takes one-sided overtaking restrictions into account on highways or on multi-lane roads with separate roadways (country-dependent)

i In the DYNAMIC SELECT menu, the driving style of Active Distance Assist DISTRONIC can be set. Depending on which drive program is selected, the driving characteristics can be geared towards energy economy, com-

fort or dynamic performance. In the Active Distance Assist menu, the driving style can be permanently set to Comfort or Dynamic (→ page 235).

Vehicles with Active Parking Assist and Driving Assistance Package:

if Active Distance Assist DISTRONIC has braked the vehicle to a standstill, it can automatically follow the vehicle in front when driving off again within 30 seconds. If a critical situation is detected in the surrounding area when driving off, such as a person in the vehicle path, a visual and acoustic warning is given indicating that the driver must now take control of the vehicle. The vehicle is not accelerated any further. Observe the notes on driving systems and your responsibility; you may otherwise fail to recognize dangers (→ page 217).

Display in the driver display in the Assistance menu

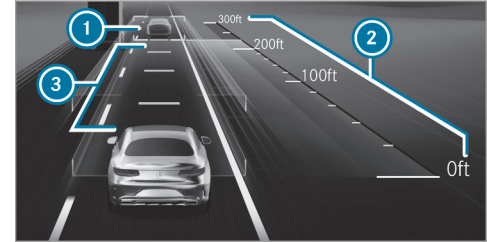



- 1 Vehicle in front
- 2 Distance indicator
- 3 Set specified distance

Vehicle detected in front **1** is highlighted in green. It may also be in the lane to the left of your vehicle in situations where it is not permitted to overtake on the right, for example on highways.

Permanent status display



-  (gray): Active Distance Assist DISTRONIC selected but not yet active

-  (green speedometer, white vehicle): Active Distance Assist DISTRONIC active, speed set
-  (green): Active Distance Assist DISTRONIC active and vehicle detected

The stored speed is shown under the permanent status display and highlighted on the speedometer. When Active Distance Assist DISTRONIC is passive, the status display is grayed out.

If the speed of the vehicle in front or the speed adjustment is less than the stored speed due to the route event ahead, the segments in the speedometer light up.

When the set specified distance is increased or decreased, the  display briefly appears under the vehicle in the permanent status display.

-  On highways or high-speed major roads, the green  vehicle symbol is displayed cyclically when the vehicle is ready to pull away.
-  If you depress the accelerator pedal beyond the setting of the Active Distance Assist DISTRONIC, the system is switched to passive

mode. The  **Suspended** message appears in the driver display.

System limits

The system may be impaired or may not function in the following situations, for example:

- In snow, rain, fog, heavy spray, if there is glare, in direct sunlight or in greatly varying ambient light.
- The windshield in the area of the camera is dirty, fogged up, damaged or covered.
- If the radar sensors are dirty or covered.
- In parking garages or on roads with steep uphill or downhill gradients.
- If there are narrow vehicles in front, such as bicycles or motorcycles.

In addition, on slippery roads, braking or accelerating can cause one or several wheels to lose traction and the vehicle could then skid.

Do not use Active Distance Assist DISTRONIC in these situations.

⚠ WARNING Risk of accident from acceleration or braking by Active Distance Assist DISTRONIC

Active Distance Assist DISTRONIC may accelerate or brake in the following cases, for example:

- If the vehicle pulls away using Active Distance Assist DISTRONIC.
 - If the stored speed is called up and is considerably faster or slower than the currently driven speed.
 - If Active Distance Assist DISTRONIC no longer detects a vehicle in front or does not react to relevant objects.
- ▶ Always carefully observe the traffic conditions and be ready to brake at all times.
- ▶ Take into account the traffic situation before calling up the stored speed.

⚠ WARNING Risk of accident due to insufficient deceleration by Active Distance Assist DISTRONIC

Active Distance Assist DISTRONIC brakes your vehicle with up to 50% of the possible deceleration. If this deceleration is not sufficient, Active Distance Assist DISTRONIC alerts you with a visual and acoustic warning.

- ▶ Adjust your speed and maintain a suitable distance from the vehicle in front.
- ▶ Brake the vehicle yourself and/or take evasive action.

⚠ WARNING Risk of accident if detection function of Active Distance Assist DISTRONIC is impaired

Active Distance Assist DISTRONIC does not react or has a limited reaction:

- when driving on a different lane or when changing lanes

- to pedestrians, animals, bicycles or stationary vehicles, or unexpected obstacles
- to complex traffic conditions
- to oncoming vehicles and crossing traffic

As a result, Active Distance Assist DISTRONIC may neither give warnings nor intervene in such situations.

- ▶ Always observe the traffic conditions carefully and react accordingly.

Operating Active Distance Assist DISTRONIC

Requirements:

- The electric parking brake is released.
- ESP® is activated and is not intervening.
- The transmission is in position **D**.
- All the doors are closed.
- Check of the radar sensor system has been successfully completed.
- Snow chain mode is not active (→ page 382).

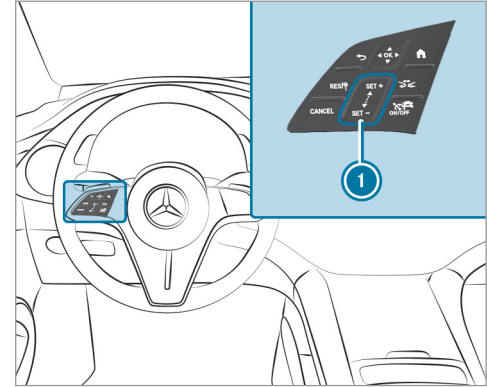



- Adopts the stored /detected speed
- Deactivates Active Distance Assist DISTRONIC
- 1** Increases/decreases the speed
- Increases/decreases the specified distance
- Activates/deactivates Active Distance Assist DISTRONIC

- ▶ To operate Active Distance Assist DISTRONIC: press the respective button with only one finger or swipe on the control panel.

Activating/deactivating Active Distance Assist DISTRONIC

- ▶ Press .

Activating Active Distance Assist DISTRONIC

- ▶ To activate without a stored speed: on control panel ① press  on the upper section or  on the lower section or . Remove your foot from the accelerator pedal.



or

- ▶ To activate with a stored speed: press . Remove your foot from the accelerator pedal. The last stored speed is called up and maintained by the vehicle.
If the stored speed has been deleted, the current vehicle speed is stored.

Increasing or reducing the speed

- ▶ To increase the stored speed: swipe upwards from the bottom of control panel ①.
 - The stored speed is increased by 1 mph (1 km/h).
- ▶ To decrease the stored speed: swipe downwards from the top of control panel ①.
 - The stored speed is decreased by 1 mph (1 km/h).

or

- ▶ Briefly press  on the upper section or  on the lower section of control panel ①.
The stored speed is increased or reduced by 5 mph (10 km/h).

or

- ▶ Accelerate the vehicle to the desired speed.
- ▶ Press  on the upper section of control panel ①.

Adopting the limit speed shown in the driver's display

- ▶ Activate Active Distance Assist DISTRONIC.

- ▶ Press .
The limit speed displayed in the driver's display is adopted as the stored speed. The vehicle adapts its speed to that of the vehicle in front, but only up to the stored speed.



Pulling away with Active Distance Assist DISTRONIC

- ▶ Activate Active Distance Assist DISTRONIC and remove your foot from the brake pedal.
- ▶ Press .

or

- ▶ Depress the accelerator pedal briefly and firmly.
The functions of Active Distance Assist DISTRONIC continue to be carried out.

Reducing or increasing the specified distance from the vehicle in front

- ▶ Press .
The  display appears. The specified distance is reduced by one level.
If the lowest level is already selected, the selection jumps to the highest level.

Deactivating Active Distance Assist DISTRONIC

⚠ WARNING Risk of an accident due to Active Distance Assist DISTRONIC being active when you leave the driver's seat

If you leave the driver's seat while the vehicle is being braked by Active Distance Assist DISTRONIC only, the vehicle can roll away.

- ▶ Always deactivate Active Distance Assist DISTRONIC and secure the vehicle to prevent it from rolling away before you leave the driver's seat.

▶ Press **CANCEL**.

i If you brake, deactivate ESP® or if ESP® intervenes, Active Distance Assist DISTRONIC is deactivated.

Function of Active Speed Limit Assist

If a change in the speed limit of 12 mph (20 km/h) or more is detected and automatic adoption of speed limits is activated, the new speed limit is automatically adopted as the stored speed (→ page 235).

The driven speed is adjusted when the vehicle is level with the traffic sign at the latest. In the case of signs indicating entry into an urban area, the speed is adapted according to the speed permitted within the urban area. The speed limit display in the driver display is always updated when the vehicle is level with the traffic sign.

If you are driving on German highways and there is no speed limit, the system uses the speed stored for a stretch of road with no speed limit as the set speed. If you do not alter the stored speed on a stretch of road with no speed limit, the recommended speed of 80 mph (130 km/h) is adopted.

If Active Distance Assist DISTRONIC has been put into passive mode by pressing the accelerator pedal, only speed limits which are higher than the set speed are adopted.

The maximum permissible speed does not take the road condition and current weather and traffic conditions into account. Adjust your speed accordingly, when necessary.

Observe the notes on driving systems and your responsibility; you may otherwise fail to recognize dangers (→ page 217).

System limits

The system limits of Traffic Sign Assist apply to the detection of traffic signs (→ page 246).

Speed limits below 12 mph (20 km/h) are not automatically adopted by the system as the stored speed. Temporary speed restrictions (e.g. for a certain time or due to weather conditions) cannot be properly detected by the system. The maximum permissible speed applying to a vehicle with a trailer is not detected by the system.

Adjust the speed in these situations.

⚠ WARNING Risk of accident due to Active Speed Limit Assist adapting the vehicle's speed

The speed adopted by Active Speed Limit Assist may be too high or incorrect in some individual cases, such as:

- at speed limits below 12 mph (20 km/h)

- in wet conditions or in fog
 - when towing a trailer
- ▶ Ensure that the driven speed complies with traffic regulations.
- ▶ Adjust the driving speed to suit current traffic and weather conditions.

Function of route-based speed adaptation

When Active Distance Assist DISTRONIC is activated, the vehicle speed will be adapted accordingly to the route events ahead. Depending on the drive program selected, the vehicle negotiates a route event ahead in an energy-saving, comfortable or dynamic manner. When the route event has been passed, the vehicle accelerates again to the stored speed. The set distance to the vehicle in front, vehicles detected ahead and speed restrictions ahead are taken into account.

Route-based speed adaptation can be activated in the multimedia system (→ page 235).

The following route events are taken into account:

- Curves
- Roundabouts

- T-intersections
- Turns and exits
- Traffic jams ahead (only with Live Traffic)

Also, the speed is reduced if the turn signal indicator is switched on and one of the following situations is detected:

- Turning off at intersections
- Driving on slowing-down lanes
- Driving on lanes adjacent to slowing-down lanes

The driver is responsible for choosing the right speed and observing other road users. This applies in particular to intersections, roundabouts and traffic lights, as route-based speed adaptation does not brake the vehicle to a standstill.

If a corresponding route event is detected while route guidance is active, the first speed adjustment is carried out automatically. If the turn signal indicator is switched on, the selected route is confirmed and further speed adjustment is activated.

Speed adaptation is canceled in the following cases:

- If the turn signal indicator is switched off before the route event and it is therefore assumed that the route event is not relevant to the driver.
- If the driver depresses the accelerator or brake pedal during the process.

System limits

Route-based speed adaptation does not take right of way regulations into account. The driver is responsible for complying with road traffic regulations and driving at a suitable speed.

In difficult conditions, the speed selection made by the system may not always be suitable. This applies to the following situations, for example:

- Unclear roads
- Road narrowing
- Varying maximum permissible speeds in individual lanes, for example at toll stations
- Wet road surfaces, snow or ice

In these situations the driver must intervene accordingly.

⚠ WARNING Risk of accident in spite of route-based speed adaptation

Route-based speed adaptation can malfunction or be temporarily unavailable in the following situations:

- If the driver does not follow the calculated route
 - If map data is not up-to-date or available
 - In the event of roadworks
 - In bad weather or road conditions
 - If the accelerator pedal is depressed
 - In the event of electronically displayed speed limitations
- ▶ Adapt the speed to the traffic situation.

Setting Active Distance Assist DISTRONIC driving styles

Requirements:

- Active Distance Assist DISTRONIC is activated.

Multimedia system:

→  ▶ Settings ▶ Assistance
▶▶ Driving ▶▶ Active Distance Assist

Selecting a driving style

▶ Select **DYNAMIC SELECT based**, **Dynamic** or **Comfort**.

Setting speed adaptation

▶ Select **For curves etc..**

When these functions are active, the vehicle speed is adjusted depending on the route events ahead.

- i** When one of the following systems is active, the detected speed can be manually adopted as the speed limit:
- Active Distance Assist DISTRONIC
 - Cruise control

- Variable limiter

Further information about Active Distance Assist DISTRONIC (→ page 231).

- i** Further information on speed adaptation (→ page 234).

Function of Active Stop-and-Go Assist

Active Stop-and-Go Assist helps you when in traffic jams on multi-lane roads with separate roadways by automatically pulling away within up to 60 seconds and with moderate steering maneuvers. It orients itself using the vehicle in front and lane markings. Active Stop-and-Go Assist automatically maintains a safe distance from the vehicle in front and vehicles cutting in.

Active Stop-and-Go Assist requires you, as the driver, to keep your hands on the steering wheel at all times so that you are able to intervene at any time to correct the course of the vehicle and keep it in lane.

Observe the notes on driving systems and your responsibility; you may otherwise fail to recognize dangers (→ page 217).

Active Stop-and-Go Assist activates automatically when all of the following conditions are met:

- You are in a traffic jam on a freeway or high-speed major road.
- Active Distance Assist DISTRONIC is activated and active (→ page 231).
- Active Steering Assist is activated and active (→ page 238).
- You are traveling no faster than 35 mph (60 km/h).

When Active Stop-and-Go Assist is active the  status display appears in the driver display.

System limits

The system limitations of Active Distance Assist DISTRONIC and Active Steering Assist apply to Active Stop-and-Go Assist (→ page 236).

Active Steering Assist

Function of Active Steering Assist



Active Steering Assist is only available up to a speed of 130 mph (210 km/h). The system helps you to stay in the center of the lane by means of

moderate steering interventions. Depending on the speed driven, Active Steering Assist uses the vehicles ahead and lane markings as a reference.

- ① Depending on the country, in the lower speed range Active Steering Assist can use the surrounding traffic as a reference. If necessary, Active Steering Assist can then also provide assistance when driving away from the center of the lane.

If the detection of lane markings and vehicles ahead is impaired, Active Steering Assist switches to passive mode. The system provides no support in this case.

Permanent status display in the driver display

-  **Gray:** activated and passive
-  **Green:** activated and active
-  **Red, flashing:** prompt to the driver to actively confirm or transition from active to passive status, system limit detected

- ① During the transition from active to passive status, the  symbol is shown as enlarged and flashing. Once the system is passive, the

 symbol is shown as gray in the driver display.

Contact detection

The driver is required to keep their hands on the steering wheel at all times and be able to intervene at any time to correct the course of the vehicle and keep it in lane. The driver must expect a change from active to passive mode or vice versa at any time.



If the system detects that the driver has not steered the vehicle for a considerable period of time or has removed their hands from the steering wheel, an optical warning is given first. Display ① appears in the driver display. If the driver still does

not steer the vehicle, or gives no confirmation to the system, a warning tone sounds in addition to the visual warning message.

If the driver does not react to this warning for a considerable period, an emergency stop is initiated (→ page 238).

The warning is not issued or is stopped as soon as the system detects that the driver has touched the steering wheel.

Touch detection may be limited or inoperative in the following situations:

- The driver is wearing gloves.
- There is a steering wheel cover on the steering wheel.

If Active Steering Assist detects that a system limit has been reached, a visual warning is issued and a warning tone sounds.

Observe the notes on driving systems and your responsibility; you may otherwise fail to recognize dangers (→ page 217).

System limits

Active Steering Assist has a limited steering torque for lateral guidance. In some cases, the steer-

ing intervention is not sufficient to keep the vehicle in the lane.

The system may be impaired or may not function in the following instances:

- There is poor visibility, e.g. due to snow, rain, fog, heavy spray, greatly varying ambient light or strong shadows on the road.
- There is glare, e.g. from oncoming traffic, direct sunlight or reflections.
- Insufficient road illumination.
- The windshield is dirty, fogged up, damaged or covered in the vicinity of the camera, e.g. by a sticker.
- No, or several, unclear lane markings are present for one lane, or the markings change quickly, for example, in a construction area or intersections.
- The lane markings are worn away, dark or covered up, e.g. by dirt or snow.
- If the distance to the vehicle in front is too short and thus the lane markings cannot be detected.
- The road is narrow and winding.

- There are obstacles on the lane or projecting out into the lane, such as object markers.

The system does not provide assistance in the following conditions:

- On very tight curves and when turning.
- When crossing intersections.
- At roundabouts or toll stations.
- When actively changing lane without switching on the turn signal indicator.
- When the tire pressure is too low.

⚠ WARNING Risk of accident if Active Steering Assist unexpectedly stops functioning

If the system limits of Active Steering Assist are reached there is no guarantee that the system will remain active or will keep the vehicle in lane.

- ▶ Always keep your hands on the steering wheel and observe the traffic carefully.
- ▶ Always steer the vehicle paying attention to traffic conditions.

⚠ WARNING Risk of accident if Active Steering Assist unexpectedly intervenes

The detection of lane markings and objects may malfunction and cause unexpected steering interventions.

- ▶ Steer according to traffic conditions.

Activating/deactivating Active Steering Assist

Requirements:

- ESP® is activated, but is not intervening.
- Active Distance Assist DISTRONIC is activated.

Multimedia system:

- ▶ Settings ▶ Assistance
- ▶ Driving
- ▶ Select  Act. Steering Asst. .

Function of Active Emergency Stop Assist

Depending on vehicle equipment, Active Emergency Stop Assist uses touch sensors or detects steering movements when monitoring the steering

wheel. If the system detects that the driver is no longer holding the steering wheel, it can initiate an emergency stop, if necessary.

Vehicles without Driving Assistance Package: the accelerator and brake pedal are monitored as well as the steering wheel.

Vehicles with Driving Assistance Package and Active Steering Assist: if Active Steering Assist is deactivated, the accelerator and brake pedal are monitored as well as the steering wheel.

A warning is issued when the steering wheel is not being held or when a pedal is not depressed, and the vehicle is in danger of leaving the lane.



If the system detects that the driver has not steered the vehicle for a considerable period of time or has removed their hands from the steering wheel, visual warning ① is issued. If the driver still does not steer the vehicle, or gives no confirmation to the system, a warning tone sounds in addition to the visual warning message.

Also observe the instructions on the contact detection of Active Steering Assist (→ page 236).

Active Emergency Stop Assist issues the following warnings in order:

- Display message ① appears in the driver display.
- In addition to display ① a warning tone sounds.
- The **Beginning Emergency Stop** message appears in the driver display, a continuous warning tone sounds, the vehicle no longer accelerates, and there is a slight, repeated tensioning of the seat belt.
- The vehicle speed is reduced in increments until it is at a standstill. Sharp brake impulses are also produced.

Vehicles with Driving Assistance Package and Active Steering Assist: depending on the country, a lane change to the adjacent right-hand lane is carried out, if possible.

i It is only possible to change across one lane and only into the right-hand lane, and not onto the hard shoulder.

When automatic braking is initiated, Active Distance Assist DISTRONIC is deactivated. Depending on the country, the hazard warning light system is switched on.

When the vehicle is stationary, the following actions are carried out:

- The vehicle is secured with the electric parking brake.
- The vehicle is unlocked.
- If possible, an emergency call is placed to the Mercedes-Benz emergency call center.

Before automatic braking is initiated, you can cancel Active Emergency Stop Assist by steering.

You can cancel the intervention by Active Emergency Stop Assist after automatic braking is initiated by one of the following actions:

- Accelerating or braking: the emergency stop is canceled, but the warning message, warning tone and power steering remain active
- Steering: power-assisted steering is canceled, the warning message and warning tone remain active and the vehicle continues to be braked
- i** Active Emergency Stop Assist can initiate an emergency stop a maximum of three times within one driving cycle. Subsequently, Active Steering Assist and Active Emergency Stop Assist are deactivated for that driving cycle.

System limits

Vehicles without Driving Assistance Package:

Active Emergency Stop Assist is inactive in the following cases:

- Active Lane Keeping Assist has reached a system limit.
- Active Lane Keeping Assist is not operational (gray status display) or deactivated (white status display) (→ page 255).

Vehicles with Driving Assistance Package and Active Steering Assist: if Active Lane Keeping Assist does not detect lane markings, Active Emergency Stop Assist is not active.

For the detection of vehicles and other obstacles, observe the system limits of the following functions:

- Active Distance Assist DISTRONIC (→ page 228)
- Active Steering Assist (→ page 236)
- Active Lane Change Assist (→ page 239)

Active Lane Change Assist

Function of Active Lane Change Assist

Active Lane Change Assist supports the driver when changing lanes and is activated by indicating briefly.

For this, the following conditions must be fulfilled:



- You are on a freeway or high-speed major road.
- The vehicle speed is between approximately 45 mph (70 km/h) and 110 mph (180 km/h).

- The neighboring lane is separated by a broken lane marking.
- No vehicle or obstacle is detected in the adjacent lane.
- Active Lane Change Assist is selected in the multimedia system.
- Active Distance Assist DISTRONIC and Active Steering Assist are switched on and active.

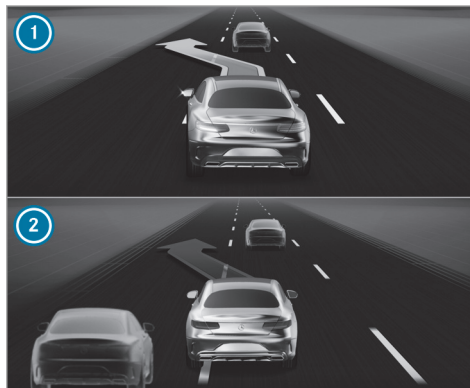
Display in the driver display in the **Assistance** menu



- ① Green arrow: lane change initiated
- ② Red arrow: lane change canceled

When Active Lane Change Assist is available, the  display appears along with green arrows in the driver display. If the system has been activated but is not currently available, the  display

appears along with gray arrows in the driver display.

If no vehicle or obstacle is detected in the adjacent lane and a lane change is permitted, the lane change begins after the driver has indicated briefly. The lane change is shown to the driver with a flashing green arrow next to the  steering wheel symbol. Green arrow ① is displayed in the appropriate adjacent lane in the **Assistance** menu in the driver display. The **Lane Change to the Left** message, for example, also appears.

If a lane change is not possible directly after the driver has activated the turn signal indicator because an obstacle has been detected, for example, the arrow will also flash in green next to the  steering wheel symbol and the neighboring lane will continue to be monitored. When the lane becomes free, a lane change will be carried out and the **Lane Change to the Left** message, for example, appears in the driver display. If the green arrows stop flashing, the lane change must be activated again.

Active Lane Change Assist can be canceled in various situations, including the following:

- Change in the surrounding conditions (e.g. detected obstacle).
- The driver steers with too much force or in the opposite direction.
- The driver moves the turn signal indicator in the opposite direction.
- Active Distance Assist DISTRONIC or Active Steering Assist is deactivated.
- The vehicle cannot make the lane change as planned.

Cancellation of Active Lane Change Assist is displayed as follows:

- The arrow in the selected direction of travel turns red.
- A corresponding message will also appear in the driver display.
- In certain circumstances a warning tone sounds.

⚠ WARNING Risk of accident when changing lane to an occupied adjacent lane

Lane Change Assist cannot always clearly detect if the adjacent lane is free.

The lane change might be initiated although the adjacent lane is not free.

- ▶ Before changing lanes, make sure that the neighboring lane is free and there is no danger to other road users.
- ▶ Monitor the lane change.

⚠ WARNING Risk of accident if Lane Change Assist unexpectedly stops functioning

If the system limitations for Lane Change Assist have been reached, there is no guarantee that the system will remain active.

Lane Change Assist cannot then assist you by applying steering torque.

- ▶ Always monitor the lane change and keep your hands on the steering wheel. Observe the traffic conditions and steer and/or brake if necessary.

System limits

The system limitations of Active Steering Assist apply to Active Lane Change Assist (→ page 236).

The system may also be impaired or may not function in the following situations:

- The sensors are damaged, covered or dirty (→ page 217).
 - The exterior lighting shows a defect.
 - The system does not detect a suitable road, for example, in tight curves.
 - The vehicle is on a construction site.
- i** The Active Lane Change Assist sensors adjust automatically while a certain distance is being driven after the vehicle has been delivered. Active Lane Change Assist is unavailable or only partially available during this teach-in process, and no arrows are displayed next to the  Active Steering Assist symbol.

Observe the notes on driving systems and your responsibility; you may otherwise fail to recognize dangers (→ page 217).

Selecting Active Lane Change Assist

Multimedia system:

→  ► Settings ► Assistance
► Driving

► Select the function.

Active Brake Assist

Function of Active Brake Assist

Active Brake Assist consists of the following functions:

- Collision warning
- Autonomous braking function
- Situation-dependent braking assistance
- **Vehicles with Driving Assistance Package and Active Steering Assist:** Evasive Steering Assist

Active Brake Assist can help you to minimize the risk of a collision with vehicles, cyclists or pedestrians or to reduce the effects of such a collision.

If Active Brake Assist has detected a risk of collision, a warning tone sounds and the  distance warning lamp lights up.

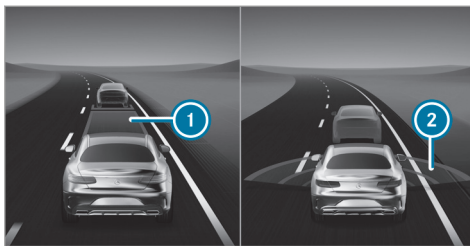

In the **Assistance** menu, an insufficient distance ① to the vehicle in front is displayed in red. If you further reduce the distance, the vehicle in front is also highlighted in red. When the system detects a risk of collision, red radar waves ② appear in front of the vehicle.

- ① **Vehicles with PRE-SAFE®:** depending on the country, an additional haptic warning occurs in the form of slight, repeated tensioning of the seat belt.
- ② **Vehicles with active ambient lighting:** if **Warning Support** is activated, the Active Brake Assist warning is also accompanied by ambient lighting (→ page 155).

If you do not react to the warning, autonomous braking can be initiated in critical situations.

In particularly critical situations, Active Brake Assist can also initiate autonomous braking directly. In this case, the warning lamp and warning tone occur simultaneously with the braking application.

If you apply the brake yourself in a critical situation or apply the brake during autonomous braking, situation-dependent braking assistance occurs. The brake pressure increases up to maximum full-stop braking if necessary.



If autonomous braking or situation-dependent braking assistance has occurred, pop up ①

appears in the driver display and then automatically goes out after a short time.

If the autonomous braking function or the situation-dependent braking assistance is triggered, additional preventive measures for occupant protection (PRE-SAFE®) may also be initiated.

⚠ WARNING Risk of an accident caused by limited detection performance of Active Brake Assist

Active Brake Assist cannot always clearly identify objects and complex traffic situations.

In such cases, Active Brake Assist might:

- Give a warning or brake without reason
- Not give a warning or not brake

Active Brake Assist is only an aid. The driver is responsible for maintaining a sufficiently safe distance to the vehicle in front, vehicle speed and for braking in good time.

- ▶ Always pay careful attention to the traffic situation; do not rely on Active Brake Assist alone.

- ▶ Be prepared to brake or swerve if necessary.

The individual subfunctions are available in the following speed ranges:

Collision warning

Collision warning can assist you in the following situations from approximately 4 mph (7 km/h) with an intermittent warning tone and the  warning lamp.

Vehicles without Driving Assistance Package:

- At speeds up to approximately 155 mph (250 km/h) when approaching vehicles ahead.
- At speeds up to approximately 50 mph (80 km/h) when approaching stationary vehicles, pedestrians walking in the direction of travel and cyclists ahead.
- At speeds up to approximately 43 mph (70 km/h) when approaching crossing pedestrians and cyclists.

- At speeds up to approximately 37 mph (60 km/h) when approaching stationary pedestrians and cyclists.

Vehicles with Driving Assistance Package:

- At speeds up to approximately 155 mph (250 km/h) when approaching vehicles ahead.
- At speeds up to approximately 75 mph (120 km/h) when approaching crossing vehicles, pedestrians and cyclists.
- At speeds up to approximately 62 mph (100 km/h) when approaching stationary vehicles.
- At speeds up to approximately 50 mph (80 km/h) when approaching cyclists ahead.
- At speeds up to approximately 43 mph (70 km/h) when approaching stationary pedestrians and cyclists.

Autonomous braking function

If the vehicle is traveling at speeds above approximately 4 mph (7 km/h), the autonomous braking function may intervene in the following situations:

Vehicles without Driving Assistance Package:

- At speeds up to approximately 155 mph (250 km/h) when approaching vehicles ahead.
- At speeds up to approximately 50 mph (80 km/h) when approaching cyclists ahead, pedestrians walking in the direction of travel and stationary vehicles.
- At speeds up to approximately 43 mph (70 km/h) when approaching crossing pedestrians and cyclists.

Vehicles with Driving Assistance Package:

- At speeds up to approximately 155 mph (250 km/h) when approaching vehicles ahead.
- At speeds up to approximately 75 mph (120 km/h) when approaching crossing vehicles, pedestrians and cyclists.
- At speeds up to approximately 62 mph (100 km/h) when approaching stationary vehicles.
- At speeds up to approximately 50 mph (80 km/h) when approaching cyclists ahead.

- At speeds up to approximately 43 mph (70 km/h) when approaching stationary pedestrians and cyclists.

Situation-dependent braking assistance

If the vehicle is traveling at speeds above approximately 4 mph (7 km/h), situation-dependent braking assistance may intervene in the following situations.

Vehicles without Driving Assistance Package:

- At speeds up to approximately 155 mph (250 km/h) when approaching vehicles ahead.
- At speeds up to approximately 50 mph (80 km/h) when approaching cyclists ahead, pedestrians walking in the direction of travel and stationary vehicles.
- At speeds up to approximately 43 mph (70 km/h) when approaching crossing pedestrians and cyclists.
- At speeds up to approximately 37 mph (60 km/h) when approaching stationary pedestrians and cyclists.

Vehicles with Driving Assistance Package:

- At speeds up to approximately 155 mph (250 km/h) when approaching vehicles ahead.
- At speeds up to approximately 75 mph (120 km/h) when approaching crossing vehicles, pedestrians and cyclists.
- At speeds up to approximately 62 mph (100 km/h) when approaching stationary vehicles.
- At speeds up to approximately 50 mph (80 km/h) when approaching cyclists ahead.
- At speeds up to approximately 43 mph (70 km/h) when approaching stationary pedestrians and cyclists.

Canceling a brake application of Active Brake Assist

You can cancel a brake application of Active Brake Assist at any time by:

- Fully depressing the accelerator pedal or with kickdown.
- Releasing the brake pedal.

Active Brake Assist may cancel the brake application when one of the following conditions is fulfilled:

- You maneuver to avoid the obstacle
- There is no longer a risk of collision
- An obstacle is no longer detected in front of your vehicle

Reaction to oncoming road users (only vehicles with Driving Assistance Package)

Active Brake Assist can also react to detected oncoming road users:

- Reaction up to speeds of approximately 62 mph (100 km/h)
- Warning for oncoming road users through acoustic warning and warning lamp
- Autonomous braking application in order to reduce the severity of an accident

Evasive Steering Assist

⚠ WARNING Risk of accident despite Evasive Steering Assist

Evasive Steering Assist cannot always recognize objects or complex traffic situations clearly.

Moreover, the steering support provided by Evasive Steering Assist is not sufficient to avoid a collision.

- ▶ Always pay careful attention to the traffic situation; do not rely on Evasive Steering Assist alone.
- ▶ Be prepared to brake or swerve if necessary.
- ▶ End the support by actively steering in non-critical situations.
- ▶ Drive at an appropriate speed if there are pedestrians close to the path of your vehicle.

Evasive Steering Assist has the following characteristics:

- Detection of pedestrians, cyclists and vehicles.
- Assistance through power-assisted steering if it detects a swerving maneuver.
- Activation by an abrupt steering movement during a swerving maneuver.
- Assistance during swerving and straightening of the vehicle.
- Reaction from a speed of approximately 12 mph (20 km/h) up to a speed of approximately 68 mph (110 km/h).

The steering support of Evasive Steering Assist can be canceled at any time by counter steering.

System limits

Full system performance is not yet available for a short time after switching on the vehicle or after driving off. As long as the functions are restricted, the  warning lamp can also be shown in the driver display. Depending on the environmental conditions, it may take a few minutes before full system performance is available.

If Active Brake Assist is deactivated or the functions are restricted, e.g. due to activation of another driving system, the  display message appears in the driver display.

If the system is unavailable due to dirty or damaged sensors or due to a malfunction, or if the functions are restricted, the  warning lamp appears in the driver display.

The system may be impaired or may not function, particularly in the following situations:

- In snow, rain, fog, heavy spray, if there is glare, in direct sunlight or in greatly varying ambient light.
- If the sensors are dirty, fogged up, damaged or covered. (→ page 217)
- If the sensors are impaired due to interference from other radar sources, e.g. strong radar reflections in a parking garage.
- If a loss of tire pressure or a malfunctioning tire has been detected and displayed.
- In complex traffic situations where objects cannot always be clearly identified.

- If pedestrians, cyclists or vehicles move quickly into the sensor detection range.
- If road users are hidden by other objects or are located close to other objects.
- If the typical outline of a pedestrian or cyclist cannot be distinguished from the background.
- If a pedestrian or cyclist is not detected as such, e.g. due to special clothing or other objects.
- If the driver's seat belt is not fastened.
- On curves with a tight radius.

Setting Active Brake Assist

Requirements:

- The vehicle is switched on.

Multimedia system:

  **» Settings** **» Assistance**
» Collision Avoidance **» Active Brake Assist**

- ▶ Select the desired setting.



Deactivating Active Brake Assist

-  It is recommended that you always leave Active Brake Assist activated.

- ▶ Select **Off**.

The distance warning function, the autonomous braking function and Evasive Steering Assist are deactivated.

The system is switched on again the next time the vehicle is started.

-  If Active Brake Assist is deactivated, the  symbol appears in the status bar of the multifunction display.

Traffic Sign Assist

Function of Traffic Sign Assist

-  This function is available on demand (→ page 29).

Traffic Sign Assist detects traffic signs with the multifunction camera and compares this with information in the digital navigation map. It assists you by displaying detected speed limits and overtaking restrictions in the driver's display and in the head-up display. The system can issue a warning when you exceed the maximum permissible speed.

In some countries, the system can provide you with further functions and can warn you when you are approaching pedestrian crossings or when you are about to drive past stop signs or red lights unintentionally.

The camera also detects and analyzes traffic signs with a restriction indicated by an additional sign (e.g. when wet).

Traffic Sign Assist portrays only selected signs in the driver's display. Actual traffic signs and speed limits have priority over traffic signs and speed limits shown in the driver's display.

Also observe the following information:

- Select a speed adapted to the traffic, surroundings and weather conditions
- Observe actual traffic signs
- Observe applicable traffic rules and regulations

Observe the notes on driving systems and your responsibility; you may otherwise fail to recognize dangers (→ page 217).

Displays in the driver's display

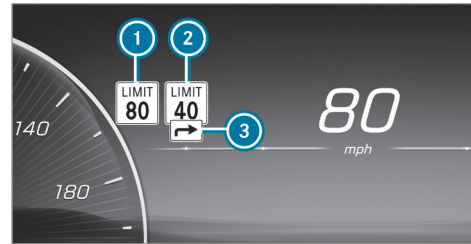

- 1 Permissible speed
- 2 Permissible speed when there is a restriction
- 3 Additional sign with restriction

The system can show up to two traffic signs in the driver's display simultaneously. The system always prioritizes displaying speed limits. Up to one traffic sign with a maximum permissible speed can be shown in the head-up display. If two speed signs are shown in the driver's display, for example when speed limits are detected, the value of left-hand speed limit 1 is transmitted to the limiter, cruise control or Active Distance Assist

DISTRONIC for adoption and is shown in the head-up display.

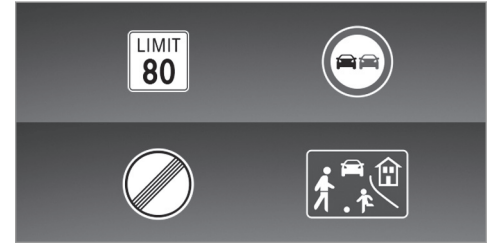

Examples of traffic signs which can be displayed

Traffic Sign Assist can detect and display following traffic signs 1:

- Speed limits
- End of the speed limit
- Overtaking restrictions
- Play streets
- Recommended speeds

Traffic Sign Assist can detect following additional signs  and, if necessary, analyze the relevance of the restrictions using other vehicle sensors:

- When wet
- Slippery road surfaces
- In fog
- Temporary restrictions
- Exits
- Restrictions for vehicle/trailer combinations

Traffic Sign Assist also uses data from the digital street map in the navigation system. When you leave or enter a municipality or change roads, on a freeway access or exit road for example, or after you turn at an intersection, the display in the driver's display can thus be updated without a traffic sign having been detected.

Depending on vehicle equipment and country, the system can also display speed restrictions up to 550 yds (500 m) ahead in the driver's display and in the head-up display. The driver's display can also show the distance to an upcoming lower limit speed. For this purpose, information from the digital road map of the navigation system is used. The

Assistance menu can also display a dynamic visualization of the speed limits ahead.

If Traffic Sign Assist cannot determine the currently applicable maximum permissible speed (e.g. due to missing signs), the following display appears in the driver's display:



Traffic Sign Assist is not available in all countries. If the vehicle is in a country where Traffic Sign Assist is not supported, this is displayed continuously.

 Also observe the information on display messages in Traffic Sign Assist (→ page 420).

Warning when the maximum permissible speed is exceeded

The system can warn you if you unintentionally exceed the maximum permissible speed. To do this, you can specify in the multimedia system by how much the maximum permissible speed can be exceeded before a warning is issued. You can set the warning to visual only (the traffic sign

flashes three times in the driver's display) or visual and acoustic, including a warning tone.

Additional functions of Traffic Sign Assist (country-specific)

Warning for no-entry signs: Traffic Sign Assist can warn you if you drive the wrong way down a section of road, for example on freeway access roads or one-way streets.

Warning at pedestrian crossings: if you approach pedestrian crossings, provided that pedestrians are in the danger zone or are moving towards it, Traffic Sign Assist can warn you up to a speed of approximately 44 mph (70 km/h).

Warning at stop signs: Traffic Sign Assist can warn you up to a speed of approximately 44 mph (70 km/h) if you are about to drive past a stop sign unintentionally. For this to be possible, the signs must be clear, for example if the system detects more than one stop sign, or a stop sign can be confirmed using the digital navigation map. No warning can be issued if several different signs are detected.

Warning at red lights: Traffic Sign Assist can warn you up to a speed of approximately 44 mph

(70 km/h) if you are about to drive through a red light unintentionally.

The following conditions must be fulfilled:

- Several traffic lights have been detected.
 - All traffic lights detected are red.
 - At least one of the red traffic lights detected is on the front passenger side beside the vehicle's own lane.
 - The traffic lights are in the following sequence (from top to bottom): red, yellow, green.
- i** If the function is available, you can activate or deactivate the warnings at pedestrian crossings, stop signs and red lights in the Traffic Sign Assist menu under [Further Warnings](#) (→ page 249).

System limits

The system may be impaired or may not function particularly in the following situations:

- If visibility is poor, e.g. due to insufficient illumination of the road, highly variable shade conditions, rain, snow, fog, swirling dust or heavy spray.
- If there is glare, e.g. from oncoming traffic, direct sunlight or reflections.
- If the windshield in the area of the multifunction camera is dirty, or if the camera is fogged up, damaged or covered.
- If traffic signs are difficult to detect, e.g. because they are dirty, covered, faded, covered with ice, damaged, badly positioned, poorly lit or twisted.
- Active traffic signs with LED displays may not be detected correctly or at all due to technical factors, such as transmission frequency.
- If the information on the navigation system's digital map is incorrect, incomplete or out of date.
- If signs or the road layout is ambiguous, e.g. traffic signs in roadworks, at exits and ramps, in neighboring lanes or parallel roads.
- If signs do not conform to the standard.
- If signs or road layouts are specific to the country and deviate from the route guidance in the navigation system, e.g. at or beyond construction sites.
- After sharp turns and tight curves, when traffic signs are outside the camera's field of vision.
- If you overtake vehicles with traffic signs which are affixed or attached to them.

Setting Traffic Sign Assist

Multimedia system:

  **» Settings » Assistance**
» Assistance » Traffic Sign Assist

Activating or deactivating the speed warning

 Activate or deactivate [Speed Limit Warning](#).

Activating or deactivating further functions of Traffic Sign Assist

 Switch [Further Warnings](#) or [Additional Acoustic Warning](#) on or off.

Setting the warning threshold

This value determines the speed at which a warning is issued when exceeded.

 Set the desired speed under [Warning Threshold](#).

Traffic light view

Information about the traffic light view

The traffic light view supports the driver when waiting in front of a red light by displaying the camera image on the central display. The camera image is displayed when the driver is the first vehicle in front of the red light and faded out when the vehicle drives off.

Displaying traffic light view

Requirements:

- The **Traffic Light View** option is switched on.
- A traffic light view is available.



Multimedia system:

→ →  → Settings → Assistance
→ Assistance → Traffic Light View

 This function is not available in all countries.

If the vehicle is in first position at a traffic light, the camera image with traffic light view is shown on the central display.

When the vehicle pulls away, the camera image is faded out.

- ▶ Activate  or deactivate  **Traffic Light View**.

Using other available functions

- ▶ Select .
- ▶ Select **On Request** or **Automatic**.

If **On Request** is set and a traffic light view is available, the **Tap Here for Traffic Light View** message is displayed. The camera image is shown after confirmation of the message.

When **Automatic** is set, the camera image is automatically displayed when the traffic light view is available.

Traffic Light Information service

 **WARNING** Risk of an accident or injury due to distraction, incorrect or missing data

The traffic light information display is an aid and cannot replace the observation of the actual driving situation.

- ▶ Keep the actual traffic situation constantly in view when approaching a traffic light and when changing lanes.
- ▶ Avoid looking at the Instrument Display and Head-up Display for a long time.

The traffic light icon and countdown of remaining time 1 until the next green phase are shown in the driver display.



Example view on the driver display

The display is hidden about five seconds before the traffic lights change to green.

- ① The display also goes out in the following cases:
 - When turning off before the intersection into a cross or side street
 - When turning before the intersection
- ① The direction arrows are displayed depending on the following functions:
 - A turn signal is set
 - A lane is recommended during active route guidance

If neither function is active, the remaining time until the next green phase for the lane straight ahead is displayed.

- ① Use of the traffic light information service requires the regular transmission of vehicle positions and driving directions to Mercedes-Benz. The data is immediately anonymized by Mercedes-Benz and forwarded to the provider of the traffic light information service. The vehicle positions and driving directions are deleted after a very short time (a few seconds) and are not permanently saved.

If you do not want to transmit the vehicle positions and driving directions, you have the following options:

- You deactivate the service in the Mercedes me portal.
 - You have the service deactivated at an authorized Mercedes-Benz Center.
- ① This traffic light information service is only available in certain cities and regions.
- The function is supported under the following conditions:
- The vehicle is equipped with a multimedia system featuring navigation and a communication module with an activated, integrated SIM card.
 - You have a user account for the Mercedes me Portal.
 - The vehicle has been connected with the user account.
 - The navigation services option is available, subscribed to and activated in the Mercedes me Portal.
 - The traffic light data service is within the scope of the navigation service.

The current vehicle position and the direction of travel are transmitted via the communication module and aligned with the data from the traffic light data service provider. The provider gathers data from traffic lights which transmit their changing phases. When the vehicle approaches an intersection with networked traffic lights, data is transmitted to the vehicle.

A set turn signal left or right and lane recommendations during active route guidance are taken into account for the display.

The service is for information purposes only and is not linked to any other vehicle functions, systems or components. Please note that the displayed data is not available in all traffic areas and may be incorrect.

Certain light signal systems automatically adapt their switching times to the current traffic situation. This can lead to a sudden change in the countdown display.

The driver display is shown after selecting the **Assistance** menu . If another menu is selected, the traffic light countdown is not displayed.

Also observe the following notes:

- Select a speed adapted to the traffic, surroundings and weather conditions
- Observe actual traffic signs
- Observe applicable traffic rules and regulations

Please observe the notes on driving systems and your responsibility. You could otherwise fail to recognize dangers.

System limits

The display does not appear in the following situations, for example:

- There is no traffic light data available.
- The time remaining until the next green phase is less than ten seconds.
- Emergency vehicles or local public transport are located in the vicinity of the intersection.
- The data transmission from the vehicle has been interrupted.
- Light signal systems are located in a construction site area or are being maintained.

- The light signal system is malfunctioning.
- The subscription to the service has expired.

Blind Spot Assist and Active Blind Spot Assist

Function of Blind Spot Assist and Active Blind Spot Assist with exit warning

Blind Spot Assist and Active Blind Spot Assist use radar sensors to monitor the area up to 130 ft (40 m) behind and 10 ft (3 m) next to your vehicle.

The system can detect vehicles traveling from speeds of approximately 8 mph (12 km/h) and issue a warning if they move into the monitoring range.

Status display in the driver display



Gray: the system is activated but inoperative.



Green: the system is activated and operational.

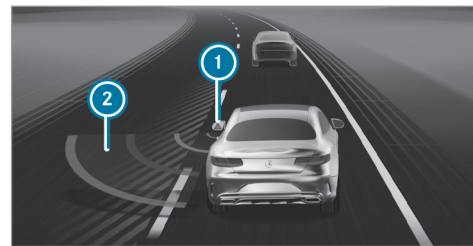

Driver display in the [Assistance](#) menu

If a vehicle is detected at speeds above approximately 8 mph (12 km/h) and this vehicle enters the monitoring range immediately afterwards, the warning lamp in the corresponding outside mirror lights up red. In the [Assistance](#) menu, the lamp in outside mirror ① also lights up red, and the lane in which the vehicle is detected is hatched out.

If a vehicle is detected in the monitoring range and you switch on the turn signal indicator in the corresponding direction, a double warning tone sounds once and the warning lamp flashes red in the corresponding outside mirror. Red radar

waves ② are displayed next to your vehicle in the assistance graphic.

If the turn signal indicator remains on, the display in the outside mirror flashes for all other detected vehicles, but no further warning tone sounds. If you overtake a vehicle quickly, no warning is given.

Observe the notes on driving systems and your responsibility; you may otherwise fail to recognize dangers (→ page 217).

⚠ WARNING Risk of accident despite Blind Spot Assist

Blind Spot Assist does not react to vehicles approaching and overtaking you at a greatly different speed.

Blind Spot Assist cannot warn drivers in this situation.

- ▶ Always pay careful attention to the traffic situation and maintain a safe distance at the side of the vehicle.

Exit warning

The exit warning is an additional function of Blind Spot Assist and Active Blind Spot Assist and can warn vehicle occupants attempting to leave a stationary vehicle about approaching vehicles.

⚠ WARNING Risk of accident despite exit warning

The exit warning neither reacts to stationary objects nor to persons or road users approaching you at a greatly differing speed.

The exit warning cannot warn drivers in these situations.

- ▶ Always pay particular attention to the traffic situation when opening the doors and make sure there is sufficient clearance.

If a vehicle is detected in the monitoring range, the red warning lamp lights up in the corresponding outside mirror.

If a vehicle occupant pulls the door handle on the side of the warning, a warning tone sounds twice and the ambient lighting in the respective door

and the warning lamps in the corresponding outside mirror flash red.

Vehicles with MBUX Interior Assistant: the visual warning begins as soon as the hand of a vehicle occupant moves in to the area of the door.

i Vehicles with ambient lighting: the **Warning Support** of the ambient lighting can be activated and deactivated (→ page 155).

i The warning assistance can differ depending on the equipment and may vary according to the setting.

The exit warning is only available when Blind Spot Assist is activated and up to a maximum of three minutes after the vehicle has been switched off. The exit warning is no longer available once the warning lamp in the outside mirror flashes three times.

The exit warning is only an aid and not a substitute for the attention of vehicle occupants. The responsibility for opening and closing the doors and for leaving the vehicle remains with the vehicle occupants.

System limits

Blind Spot Assist and Active Blind Spot Assist may be limited in the following situations, in particular:

- If there is dirt on the sensors or the sensors are obscured
- In poor visibility, e.g. due to fog, heavy rain or snow
- If there are narrow vehicles, e.g. bicycles or motorbikes
- If the road has very wide or narrow lanes
- If vehicles are not driving in the middle of their lane

Warnings may be issued in error when driving close to crash barriers or similar continuous lane borders. Always make sure that there is sufficient distance to the side for other traffic or obstacles.

Warnings may be interrupted when driving alongside long vehicles, for example trucks, for a prolonged time.

Blind Spot Assist and Active Blind Spot Assist are not operational when reverse gear is engaged.

Additionally, the exit warning may be limited in the following situations:

- When the sensors are covered by adjacent vehicles in narrow parking spaces
- When people approach the vehicle
- In the event of stationary or slowly moving objects

Function of the brake application of Active Blind Spot Assist

- ① The brake application function is only available for vehicles with a Driving Assistance Package.

If Active Blind Spot Assist detects a risk of a side impact in the monitoring range, a course-correcting brake application is carried out. This is designed to help you avoid a collision.

The course-correcting brake application is available in the speed range between approximately 20 mph (30 km/h) and 125 mph (200 km/h).

⚠ WARNING Risk of accident despite brake application of Active Blind Spot Assist

A course-correcting brake application cannot always prevent a collision.

- ▶ Always steer, brake or accelerate yourself, especially if Active Blind Spot Assist warns you or makes a course-correcting brake application.
- ▶ Always maintain a safe distance at the sides.

⚠ WARNING Risk of accident despite Active Blind Spot Assist

Active Blind Spot Assist does not react in the following situations:

- If you overtake vehicles at a high speed.
- If vehicles approach and overtake you at a greatly different speed.

Active Blind Spot Assist may not give warnings or intervene in such situations.

- ▶ Always pay careful attention to the traffic situation and maintain a safe distance at the side of the vehicle.



If a course-correcting brake application occurs, the red warning lamp flashes in the outside mirror and a warning tone sounds. In addition, display **1** indicating the danger of a side collision appears in the driver's display.

In rare cases, the system may make an inappropriate brake application. This brake application may be interrupted at any time if you steer slightly in the opposite direction or accelerate.

System limits

Either a course-correcting brake application appropriate to the driving situation, or none at all, may occur especially in the following situations:

- Vehicles or obstacles, e.g. crash barriers, are located on both sides of your vehicle.
- A vehicle approaches too closely on the side.
- You have adopted a sporty driving style with high cornering speeds.
- You brake or accelerate significantly.
- A driving safety system intervenes, e.g. ESP® or Active Brake Assist.
- ESP® is deactivated.
- A loss of tire pressure or a faulty tire is detected.

Activating/deactivating Blind Spot Assist or Active Blind Spot Assist

Multimedia system:

▶ ▶ Settings ▶ Assistance
▶ Collision Avoidance

- ▶ Select **Blind Spot Assist** or **Active Blind Spot Assist**.
- ▶ Select **On** or **Off**.

Active Lane Keeping Assist

Function of Active Lane Keeping Assist

Active Lane Keeping Assist monitors the area in front of your vehicle by means of the multifunction camera (→ page 217) and can warn you before you leave your lane unintentionally. The system can guide you back into your lane through a course-correcting steering intervention and additionally warns you with vibration pulses in the steering wheel. Active Lane Keeping Assist is available in the speed range between 37 mph (60 km/h) and 124 mph (200 km/h).

The system can intervene in the following situations:

- Active Lane Keeping Assist detects a lane marking.
- One of your front wheels goes over a lane marking.

If you activate the turn signal indicator, a steering intervention does not occur on the corresponding side.

If you leave the lane without activating the turn signal indicator, but danger of a collision with a moving obstacle is detected in your lane, a steering intervention does not occur.

Vehicles with Blind Spot Assist or Driving Assistance Package: if the system detects an obstacle, such as another vehicle in the adjacent lane, a steering intervention will occur regardless of the turn signal indicator.



Display ① will appear in the driver display and a warning tone will sound in the following situations:

- A steering intervention by Active Lane Keeping Assist lasts longer than approximately ten seconds.
- The system carries out two or more steering interventions within approximately three minutes without any steering intervention from the driver.

In the Active Lane Keeping Assist settings, you can set the sensitivity of the system and set the level of support. Additionally, you can set whether the system should react to discontinuous lane

markings or only continuous lane markings (→ page 258).

Status displays for Active Lane Keeping Assist



White: Active Lane Keeping Assist is deactivated.



Yellow: there is a malfunction. Please also observe the display messages.



Gray: Active Lane Keeping Assist is activated, but not operating.



Green: Active Lane Keeping Assist is activated and operating. If the system is operational on only one side, the lane marking is shown in green on the corresponding side.



Red: Active Lane Keeping Assist has guided you back into your lane with a course-correcting steering intervention. The status display will flash if there is also a haptic warning in the steering wheel. The lane marking is shown in red only on the side for which there is a warning.

Vehicles without Driving Assistance Package: if both lane markings are simultane-

ously shown in red in the status display, Active Lane Keeping Assist has initiated an emergency stop (→ page 238).

Active Lane Change Assist display in the "Assistance" menu



If the front wheel of the vehicle drives over a detected lane marking, this will be highlighted red in the **Assistance** menu in the driver display.

i Vehicles with active ambient lighting: if **Warning Support** is activated, the Active Lane Keeping Assist warning is also accompanied by ambient lighting (→ page 155).

System limits

In the following situations, no lane-correcting steering intervention occurs but rather a warning in the steering wheel, depending on the situation:

- You clearly and actively steer, brake or accelerate.
- If a driving safety system intervenes, such as ESP®, Active Brake Assist or Active Blind Spot Assist.
- You have adopted a sporty driving style with high cornering speeds or high rates of acceleration.
- When ESP® is deactivated.
- If transport equipment, for example a trailer or bicycle rack, is attached to the trailer hitch and the electrical connection has been correctly established.
- If a loss of tire pressure or a malfunctioning tire has been detected and displayed.

The system may be impaired or may not function particularly in the following situations:

- If there is poor visibility, e.g. due to insufficient illumination of the road, highly variable shade conditions, rain, snow, fog or heavy spray.
- If there is glare, e.g. from oncoming traffic, the sun or reflections.
- If the windshield in the area of the multifunction camera is dirty, or if the camera is fogged up, damaged or covered.
- If there is dirt on the bumper in the area of the radar sensors, or if they are damaged or covered.
- If there are no lane markings, or several unclear lane markings are present for one lane, e.g. around roadworks.
- If the lane markings are worn, dark or covered.
- If the distance to the vehicle in front is too short and thus the lane markings cannot be detected.
- If the lane markings change quickly, e.g. lanes branch off, cross one another or merge.

- If the road is very narrow and winding.

Observe the notes on driving systems and your responsibility; you may otherwise fail to recognize dangers (→ page 217).

Activating/deactivating Active Lane Keeping Assist

Multimedia system:

-  » Settings » Assistance
- » Collision avoidance
- » Active Lane Keeping Assist

- ▶ Switch the function on or off.

Alternatively, Active Lane Keeping Assist can be activated and deactivated via quick-access.

- ① After starting the vehicle, the settings are country-specific.

Setting Active Lane Keeping Assist

Multimedia system:

-  » Settings » Assistance
- » Collision avoidance
- » Active Lane Keeping Assist

Setting the sensitivity

- ▶ Select .
- ▶ Select **Early**, **Med.** or **Late**.

The last selected setting will be adopted the next time the vehicle is started.

- ① The standard setting for this function is dependent on the country.

Activating or deactivating assistance on discontinuous lane markings

- ▶ Select **Advanced Support**.

The last selected setting will be adopted the next time the vehicle is started.

- ① The standard setting for this function is dependent on the country.

- ① This function must be activated in vehicles without Driving Assistance Package, so that Emergency Stop Assist is fully available. Further information on Emergency Stop Assist (→ page 238)

AIRMATIC

Function of AIRMATIC

AIRMATIC is an air suspension system with variable damping for improved driving comfort. The all-round level control system ensures the best possible suspension and constant ground clearance, even with a laden vehicle. When driving at speed, the vehicle is lowered automatically to improve driving safety and to reduce energy consumption. You also have the option of manually adjusting the vehicle level.

AIRMATIC includes the following components and functions:

- Air suspension with automatic all-round level control
- ADS PLUS (Adaptive Damping System with constant damping force adjustment)

- A comfortable suspension setting in drive programs **C** and **E**
- A firmer, sporty suspension setting in drive program **S**
- Lowering the vehicle above 75 mph (120 km/h) in order to reduce energy consumption
When driving at speeds below 50 mph (80 km/h), the vehicle is raised again to the normal level.
- Increased vehicle level for greater ground clearance, selected via the multimedia system

Setting the vehicle level

⚠ WARNING Risk of accident because vehicle level is too high

Driving characteristics may be impaired.

The vehicle can drift outwards, for example, when steering or cornering.

- ▶ Choose a vehicle level which is suited to the driving style and the road surface conditions.

⚠ WARNING Risk of entrapment from vehicle lowering

When lowering the vehicle, people could become trapped if their limbs are between the vehicle body and the tires or underneath the vehicle.

- ▶ Make sure no one is underneath the vehicle or in the immediate vicinity of the wheel arches when the vehicle is being lowered.

⚠ WARNING Risk of becoming trapped due to the vehicle lowering

Vehicles with AIRMATIC or level control: when you unload luggage or leave the vehicle, the vehicle first rises slightly and then returns to the set level shortly afterwards.

You or anyone else in the vicinity of the wheel arches or the underbody could thus become trapped.

The vehicle can also be lowered after being locked.

- ▶ When leaving the vehicle, make sure that nobody is in the vicinity of the wheel arches or the underbody.

! NOTE Damage due to vehicle lowering

Parts of the body could be damaged when the vehicle is lowered.

- ▶ Make sure that there are no obstacles such as curbs underneath or in the immediate vicinity of the body when the vehicle is being lowered.

Requirements:

- The vehicle has been started.
- The vehicle is not moving faster than 25 mph (40 km/h).
- When the trailer socket is contacted (trailer/bicycle rack): the vehicle is not moving faster than 19 mph (30 km/h).

Multimedia system:



Raising the vehicle

- ▶ Select .
The indicator lamp lights up continuously.
The vehicle is raised to high level +1.

Your selection is saved. High level +1 set remains stored even after the vehicle has been switched off.

The vehicle is lowered again in the following situations:

- When driving faster than 31 mph (50 km/h).
- When the trailer socket is contacted (trailer/bicycle rack): the vehicle is moving faster than 19 mph (30 km/h).

GPS-based raising

If the function is activated, it is possible to save the vehicle position when the vehicle level is raised.

- ▶ Confirm the prompt.
The position of the vehicle is stored. When the previously stored position is reached again, a

prompt appears in the Zero Layer as to whether the vehicle level should be raised again.

- ① Settings for GPS-based raising (→ page 260)

Lowering the vehicle

- ▶ Select .
The indicator lamp goes out.
The vehicle is adjusted to the normal level.

- ① Use the normal level in trailer operation. High level driving is not permitted in trailer operation on public roads.

Setting GPS-based raising of the vehicle

Multimedia system:



- ▶ Select **Store Positions on Request, Always Save Positions** or **Delete All Saved Positions**.

Rear view camera

Function of the rear view camera

The rear view camera monitors the area behind your vehicle. When you engage reverse gear, the image from the rear view camera is automatically shown in the central display.

The rear view camera is only an aid. It is not a substitute for your attention to the surroundings. The responsibility for safe maneuvering and parking remains with you. Make sure that there are no persons, animals or objects etc., in the maneuvering area while maneuvering and parking.

- ① The area behind the vehicle is displayed as a mirror image, as in the inside rearview mirror.

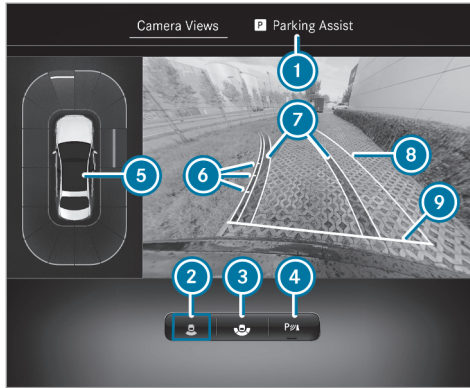

Camera Views menu (top view)

- ① Parking Assistance menu
- ② Rear view camera with top view
- ③ Wide-angle view
- ④ Activates/deactivates Parking Assist PARKTRONIC (→ page 269)
- ⑤ Warning display of Parking Assist PARKTRONIC (→ page 266)

- ⑥ Guide lines at a distance of approximately 1.6 ft (0.5 m), 3.3 ft (1.0 m), 5 ft (1.5 m) and 9.9 ft (3.0 m) from the rear area
- ⑦ Path marking the course the tires will take with the current steering wheel angle (dynamic)
- ⑧ Driven surface depending on the current steering wheel angle (dynamic)
- ⑨ Guide line at a distance of approximately 1.0 ft (0.3 m) from the rear area
- ⑩ When Active Parking Assist is active, lanes are displayed in green (→ page 270).



Wide-angle view

System limits

If the system is not ready for operation, the **System Inoperative** message appears in the central display.

The rear view camera will not function or will only partially function in the following situations:

- You are driving forwards at a speed greater than approximately 10 mph (16 km/h).
- The tailgate is open.
- The weather conditions are poor, e.g. heavy rain, snow, fog, storm or spray.
- The ambient light conditions are poor, e.g. at night or if light is shining into the camera.
- The camera lens is obstructed, dirty or fogged up. Observe the notes on cleaning the rear view camera (→ page 359).
- The camera or rear of your vehicle is damaged. In this case, have the camera and its position and setting checked at a qualified specialist workshop.
- The detection range is limited by additional vehicle attachments at the rear, such as a license plate bracket or bicycle rack.

Also observe the information on vehicle sensors and cameras (→ page 217).

- ⓘ Do not use the rear view camera in these types of situations. You could otherwise injure

others or collide with objects when parking the vehicle.

- ⓘ The contrast of the display may be impaired by direct sunlight or by other light sources, e.g. when driving out of a garage. In this case, pay particular attention.
- ⓘ Have the display repaired or replaced if, for example, pixel errors considerably restrict its use.

360° camera

Function of the surround view camera

The surround view camera is a system that consists of four cameras which cover the immediate surroundings of the vehicle. The cameras assist you when you are parking, for example, or at exits with reduced visibility.

The surround view camera includes the following cameras and evaluates their images:

- Rear view camera
- Front camera
- Two side cameras in the outside mirrors

The cameras are only an aid and may show a distorted view of obstacles, show them incorrectly or not show them at all. They are not a substitute for your attention to the surroundings. The responsibility for safe maneuvering and parking remains with you. Make sure that there are no persons, animals or objects etc., in the maneuvering area while maneuvering and parking.

Menu overview Camera Views

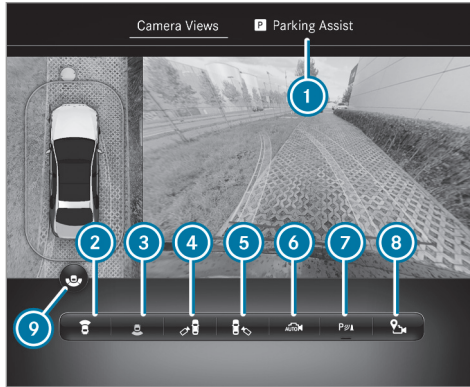

- ① Menu **Parking Assistance**
- ② Top view with image from the front camera
- ③ Top view with image from the rear view camera
- ④ 3D view, left-hand side of the vehicle
- ⑤ 3D view, right-hand side of the vehicle
- ⑥ 3D auto view

- ⑦ To activate/deactivate Parking Assist PARKTRONIC (→ page 269)
- ⑧ To set the GPS activation point (→ page 266)
- ⑨ To switch between standard and wide-angle view
- ⓘ In all views, the Parking Assist PARKTRONIC warning display is shown (→ page 266).

Function of the guide lines

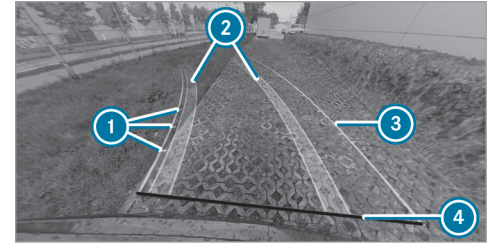

- ① Guide lines at a distance of approximately 1.6 ft (0.5 m), 3.3 ft (1.0 m), 5 ft (1.5 m) and 9.9 ft (3.0 m) from the rear area
- ② Path marking the course the tires will take with the current steering wheel angle (dynamic)
- ③ Driven surface depending on the current steering wheel angle (dynamic)
- ④ Guide line at a distance of approximately 1.0 ft (0.3 m) from the rear area

- ① When Active Parking Assist is active, lanes and guide lines are displayed in green instead of yellow (→ page 270).

Top view with image from the front or rear view camera

If you have activated the function, the image from the rear view camera is automatically displayed on the central display when reverse gear is selected .

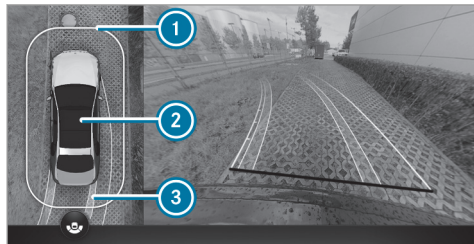

- ① Warning display of Parking Assist PARKTRONIC (→ page 266)
- ② Your vehicle from above
- ③ Lane indicating the route the vehicle will take at the current steering angle

3D view, left-/right-hand side of the vehicle

! **NOTE** Risk of accident due to objects being severely distorted in the display or not displayed at all

Due to the projection of the cameras, objects in the 3D views may be severely distorted when displayed or not displayed at all.

▶ Make sure that there are no persons, animals or objects etc. in the maneuvering area while maneuvering and parking.



- ① Display of Parking Assist PARKTRONIC (→ page 266)

In the 3D view, left-/right-hand side of the vehicle, the virtual camera moves to the respective side of the vehicle. When you change the transmission position, the view is automatically adapted.

3D auto view

- ① The area behind the vehicle is **not** displayed as a mirror image as is usual in the 3D views.

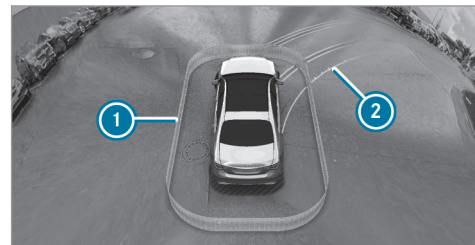

- ① Display of Parking Assist PARKTRONIC (→ page 266)
- ② Guide lines

In the 3D auto view, the virtual camera moves to the standard perspective, facing forward from the

rear above the roof. The view changes automatically when approaching obstacles.

If you touch the touchscreen, the view changes to 3D view with free rotation. You can turn, tilt and zoom the views by touch.

Wide-angle view



- 1 Display of Parking Assist PARKTRONIC (→ page 266)
- 2 To switch between standard and wide-angle view

System limits

If the system is not ready for operation, the **System Inoperative** message appears on the central display.

The surround view camera will not function or will only partially function in the following situations:

- You are driving forwards at a speed greater than approximately 10 mph (16 km/h).
- The doors are open.
- An outside mirror is not completely folded out.
- The tailgate is open.
- The weather conditions are poor, e.g. heavy rain, snow, fog, storm or spray.
- The ambient light conditions are poor, e.g. at night or if light is shining into the camera.
- The camera lens is obstructed, dirty or fogged up.
- If cameras or vehicle components in which the cameras are installed are damaged. In this event, have the cameras, their positions and their setting checked at a qualified specialist workshop.

- i Do not use the surround view camera under such circumstances. You could otherwise injure others or collide with objects when parking the vehicle.

For technical reasons, the standard height of the vehicle may be altered if the vehicle is carrying a heavy load and can result in inaccuracies in the guide lines and in the display of the generated images.

The field of vision and other functions of the camera system may be restricted due to additional attachments on the vehicle (e.g. license plate bracket, bicycle rack).

- i The contrast of the display may be impaired by abrupt, direct sunlight or by other light sources, e.g. when driving out of a garage. In this case, pay particular attention.
- i Have the display repaired or replaced if, for example, pixel errors considerably restrict its use.

See the notes on cleaning the surround view camera (→ page 359).

Calling up the surround view camera views using the button

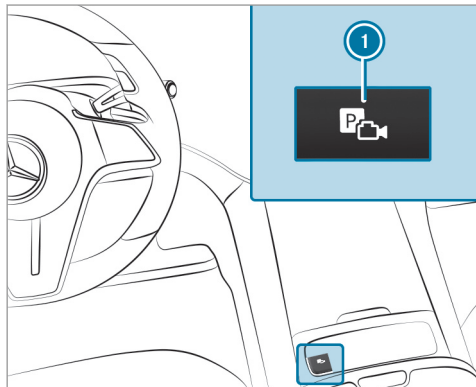

i Depending on the vehicle's equipment, button **1** may also be located at a different position in the center console.

- ▶ Press button **1**.
- ▶ Select the **Camera Views** menu.

- ▶ In the multimedia system, select the desired view (→ page 262).

Selecting a view for the surround view camera (reverse gear)

- ▶ Engage reverse gear.
- ▶ Select the desired view in the multimedia system (→ page 262).

Surround view camera with GPS - managing activation positions

Multimedia system:

- ▶ ▶ Settings ▶ Assistance
- ▶ ▶ Camera

Renaming an activation position

- i** You can determine activation positions in the **Camera Views** menu. (→ page 262)
- ▶ Select an activation position.
- ▶ Select .
- ▶ Enter a name and confirm.
The activation position is saved under the new name.

Deleting an activation position

- ▶ Select **Manage Activation Positions**.
- ▶ Select an activation position.
- ▶ Select .
- ▶ Confirm the prompt.
The activation position is deleted.

Opening the camera cover of the reversing camera

Multimedia system:

- ▶ ▶ Settings ▶ Assistance
- ▶ ▶ Camera
- ▶ Select **Open Camera Cover**.

i The camera cover closes automatically after some time or after the vehicle is switched on or off.

Parking Assist PARKTRONIC

Function of Parking Assist PARKTRONIC

Parking Assist PARKTRONIC is an electronic parking assistance system which monitors the area surrounding your vehicle and shows you the dis-

tance between the vehicle and a detected obstacle visually and audibly.

The passive side impact protection also warns you of obstacles to the side. These must be detected beforehand by the sensors in the front or rear bumper while driving by them. If you steer in the direction of a detected obstacle and there is a risk of a lateral collision, a warning is issued. The passive side impact protection can be activated and deactivated via the multimedia system.

In order for front or rear obstacles to the side to be displayed, the vehicle must first travel a distance of at least half a vehicle length. Once the vehicle has traveled one vehicle length, obstacles on all sides can be shown.

Parking Assist PARKTRONIC is only an aid. It is not a substitute for your attention to the surroundings. The responsibility for safe maneuvering and parking remains with you. Make sure that there are no persons, animals or objects in the maneuvering area while maneuvering and parking in/ exiting parking spaces.

Displays in the central display

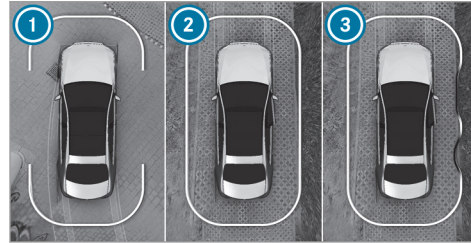

Vehicles with surround view camera

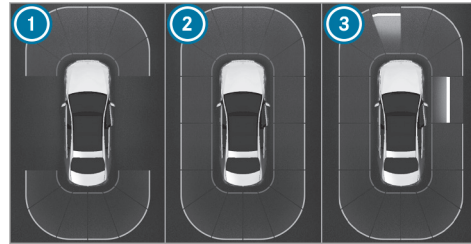

Vehicles with rear view camera

As soon as Parking Assist PARKTRONIC is operational, the respective areas of the display are shown in blue.

- ① Operational, front and rear
- ② Operational, all around
- ③ Operational, all around and obstacle detected

The color of the display changes depending on the distance to the detected obstacle:

- **Blue:** > 3.3 ft (1 m) (no obstacles detected)
- **Yellow:** approx. 3.3 ft (1 m) - 2.2 ft (0.7 m)
- **Orange:** approx. 2.2 ft (0.7 m) - 1.2 ft (0.4 m)
- **Red:** < 1.2 ft (0.4 m)

Vehicles with surround view camera: the boundary line shifts dynamically depending on the position and distance of the obstacles detected.

Depending on the distance to the obstacle detected, an intermittent warning tone also sounds. You can set the timing of the warnings in the multimedia system. In the **Warn Early** setting, the system warns you from a distance of 3.3 ft (1 m), in the standard setting only from 1.2 ft (0.4 m).

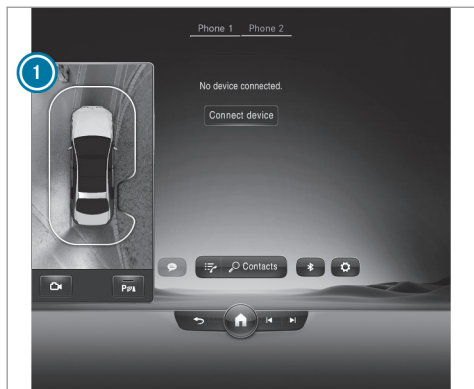

Vehicles with surround view camera



Vehicles with rear view camera

If you are not in the **Camera & Parking** menu and an obstacle in the vehicle path is detected, pop-up window ① appears in the driver's display:

- **Vehicles without Active Parking Assist:** when driving no faster than 8 mph (12 km/h).
- **Vehicles with Active Parking Assist:** when driving no faster than 11 mph (18 km/h).

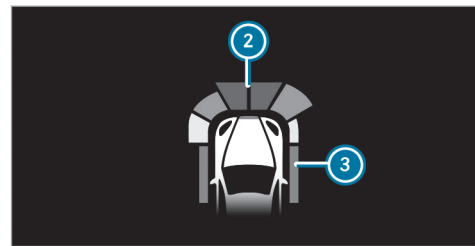

Optionally, obstacles detected by Parking Assist PARKTRONIC from a distance of approximately 3.3 ft (1.0 m) in front ② and 2.2 ft (0.7 m) on sides ③ can also be displayed in the head-up display.

Vehicles with active ambient lighting and Parking Package with remote parking functions

When **Warning Support** is activated, the Parking Assist PARKTRONIC display is also accompanied by ambient lighting. If an obstacle is detected, the ambient lighting lights up in the same color as the display in the central display.

The ambient lighting which accompanies the Parking Assist PARKTRONIC display is only intended to

accentuate the display in the central display and does not replace it.

More information on ambient lighting:
(→ page 155)

- ❗ A display message for the ambient lighting does not occur in the area of the driver's display or in the rear passenger compartment.
- ❗ Depending on the selected setting, other functions may supersede the ambient lighting effects of Parking Assist PARKTRONIC. In this case, the ambient lighting effects of Parking Assist PARKTRONIC do not occur.

System limits

Parking Assist PARKTRONIC does not necessarily take into account the following obstacles:

- Obstacles below the detection range, e.g. persons, animals or objects.
- Obstacles above the detection range, e.g. overhanging loads, overhangs or loading ramps of trucks.
- Pedestrians or animals approaching the vehicle from the side.
- Objects placed next to the vehicle.

Obstacles on the sides are not shown in the following situations, for example:

- You park the vehicle and switch it off.
- You open the doors.

After the engine is restarted, obstacles must be detected again by driving past them before a new warning can be issued.

Also observe the system limits of the following systems:

- Rear view camera (→ page 260)
- Surround view camera (→ page 262)

Observe the information on vehicle sensors and cameras; the system otherwise cannot function properly (→ page 217).

Problems with Parking Assist PARKTRONIC

If the Parking Assist PARKTRONIC display lights up red for approximately three seconds then goes out, and the  symbol appears in the driver's display, the system may have been deactivated due to signal interference. Start the vehicle again and check if Parking Assist PARKTRONIC is working at a different location.

If a warning tone also sounds, it may be due to one of the following causes:

- **The sensors are dirty:** clean the sensors and observe the notes on care of vehicle parts (→ page 359).
- **Parking Assist PARKTRONIC has been deactivated due to a malfunction:** restart the vehicle. If the problem persists, consult a qualified specialist workshop.

Activating/deactivating Parking Assist PARKTRONIC

! **NOTE** Risk of an accident from objects at close range

Parking Assist PARKTRONIC may not detect certain objects at close range.

- ▶ When parking or maneuvering the vehicle, pay particular attention to any objects which are above or below the sensors, e.g. flower pots or drawbars. The vehicle or other objects could otherwise be damaged.

Requirements:

- The camera menu is open.
- Or: Active Parking Assist is active.
- Or: the PARKTRONIC pop-up window appears.

▶ Press **P/Off** in the central display.

If the indicator lamp is lit, Parking Assist PARKTRONIC is active. If the indicator lamp is not lit or the **P/Off** symbol appears in the instrument cluster, Parking Assist PARKTRONIC is not active.

① Parking Assist PARKTRONIC is automatically activated when the vehicle is started.

Alternatively, Parking Assist PARKTRONIC can be activated or deactivated in the quick access menu.

Setting the warning tones of Parking Assist PARKTRONIC

Multimedia system:

▶   ▶ Settings ▶ Assistance
▶ Parking

Setting the volume or pitch of the warning tones

▶ Set the desired level under **Volume** or **Tone Pitch**.

Activating/deactivating audio fadeout

▶ Select **Audio Fadeout**.
The volume of the currently playing media source is reduced during a Parking Assist PARKTRONIC warning tone.

or

▶ Switch **Audio Fadeout When in R** on or off.
The volume of the currently playing media source is reduced when reverse gear is engaged.

Setting the time of the warnings

▶ Select **Time of Warning**.
▶ Set the time for the warning.

Active Parking Assist**Function of Active Parking Assist**

Active Parking Assist is an electronic parking assistance system, which uses ultrasound with the assistance of the rear view camera and surround view camera. When you are driving forwards up to approximately 22 mph (35 km/h), the system automatically measures parking spaces on both sides of the vehicle.

Active Parking Assist offers the following functions:

Vehicles with rear view camera



- Parking in parking spaces parallel to the road
- Backing up into parking spaces perpendicular to the road

Vehicles with surround view camera

- Parking in parking spaces parallel to the road
- Parking in parking spaces perpendicular to the road (optionally either forwards or reverse)
- Parking in parking spaces that can only be detected as such due to markings (for example at the roadside)

- Exiting a parking space parallel to the road
- Exiting a parking space perpendicular to the road (optionally either left or right)



Active Parking Assist is only an aid. It is not a substitute for your attention to the surroundings. The responsibility for safe maneuvering and parking remains with you. Make sure that no persons, animals or objects etc. are in the maneuvering range.

If Active Parking Assist is available, the  message appears in the driver display. When the system detects parking spaces,  appears. The arrows show on which side of the road free parking spaces are located. These are then shown on the central display.

When Active Parking Assist is activated, the turn signal indicators are activated based on the calculated path of your vehicle. When you are entering or exiting a parking space, the procedure is assisted by acceleration, braking, steering and gear changes.

To start the parking procedure, press the  button (→ page 272).

Active Parking Assist will be canceled in the following situations:

- You deactivate Parking Assist PARKTRONIC.
- You press the  button again.
- You begin steering.
- You engage transmission position .
- ESP® intervenes.
- You open the driver's door.

System limits

If the exterior lighting is malfunctioning, Active Parking Assist is not available.

Also observe the system limits of the following systems:

- Rear view camera (→ page 260)
- Surround view camera (→ page 262)

Objects located above or below the detection range of Active Parking Assist, such as overhanging loads, overhangs or loading ramps of trucks or the borders of parking spaces, are not detected during measurement of the parking space. These are also then not taken into account when calculating the parking procedure. In some circumstan-

ces, Active Parking Assist may therefore guide you into the parking space prematurely or brake too late.

Certain environmental conditions, such as snowfall or heavy rain, may lead to a parking space being measured inaccurately. Parking spaces that are partially occupied by trailer drawbars might not be identified as such or be measured incorrectly. Only use Active Parking Assist on level, high-grip ground.

 **WARNING** Risk of accident due to objects located above or below the detection range of Active Parking Assist

If there are objects above or below the detection range, the following situations may arise:

- Active Parking Assist may steer too early.
- The vehicle may not stop in front of these objects.

There is a danger of collision!

-  In these situations, do not use Active Parking Assist.

Active Parking Assist can also display unsuitable parking spaces, e.g. parking spaces in which parking is not permitted or parking spaces on unsuitable surfaces.

Do not use Active Parking Assist in the following situations:

- In extreme weather conditions such as ice, packed snow or in heavy rain.
- When transporting a load that protrudes beyond the vehicle.
- If the parking space is on a steep downhill or uphill gradient.
- When snow chains are installed.
- Directly after a tire change or when spare tires are installed.
- If the tire pressure is too low or too high.
- If the suspension is out of alignment, e.g. after bottoming out on a curb.
- On steep inclines of more than approximately 15%.

Parking with Active Parking Assist

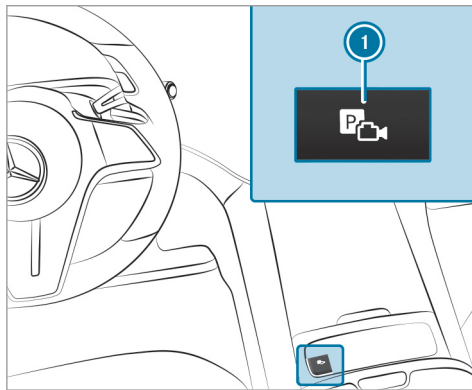

i Depending on the vehicle's equipment, button **1** may also be located at a different position in the center console.

▶ Press button **1**.

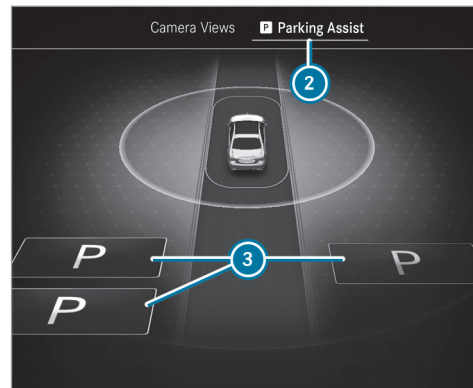

▶ Select **Parking Assistance** menu **2**.

Parking spaces **3** detected by the system are shown in the central display.

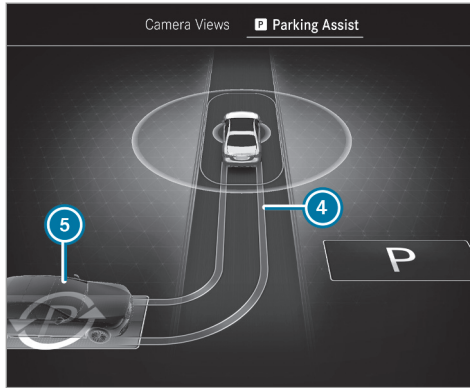

When the vehicle is stationary, indicated vehicle path ④ into currently selected parking space ⑤ also appears.

- ▶ If a parking space is displayed: stop the vehicle.
- ▶ If necessary, select another parking space.

- ▶ **Vehicles with surround view camera:** to change the parking direction, tap the selected parking space again.
- ▶ **To start the parking procedure:** press button ① again.
The vehicle drives into the selected parking space.

The turn signal indicator is switched on automatically when the parking procedure begins. You are responsible for selecting the turn signal indicator in accordance with the traffic conditions. If necessary, select the turn signal indicator accordingly.

⚠ WARNING Risk of accident due to vehicle swinging out while parking or pulling out of a parking space

While parking or exiting a parking space, the vehicle swings out and can drive onto areas of the oncoming lane.

This could cause you to collide with objects or other road users.

- ▶ Pay attention to objects and other road users.

- ▶ Where necessary, stop the vehicle or cancel the parking procedure with Active Parking Assist.

On completion of the parking procedure, the **Active Parking Assist Finished** display message appears.

- ▶ Secure the vehicle against rolling away. When required by legal requirements or local conditions: turn the wheels towards the curb.
- ① You can stop the vehicle and change the transmission position during the parking procedure. The system then calculates a new vehicle path. If no new vehicle path is available, the transmission position can be changed again, or the process can be canceled.

Immediate parking via the **Camera Views** menu



- ▶ Select the **Camera Views** menu.
- ▶ When the vehicle is stationary and in transmission position **[R]**, and symbol **6** appears in the camera image: press button **1** again. The parking procedure is initiated for the detected parking space.
- i** The parking space and parking direction cannot be changed in immediate parking.
- i** This function can be deactivated in the **Parking** menu.

Exiting a parking space with **Active Parking Assist**

Requirements:

- The vehicle is equipped with a surround view camera.
- The vehicle has been parked with Active Parking Assist.

- ▶ Start the vehicle.
- ▶ Press button **1**.



- ▶ Select **Parking Assistance** menu **2**.
- ▶ If necessary, change direction of exit **3**.
- ▶ **To start exiting the parking space:** press button **1** again.
- ▶ If necessary, change the transmission position. Observe any messages displayed in the driver display and central display. The vehicle moves out of the parking space.

The turn signal indicator is automatically switched on when exiting a parking space begins and switched off when it is completed. You are responsible for selecting the turn signal indicator in accordance with the traffic conditions. If necessary, select the turn signal indicator accordingly.

After the parking space has been exited, a warning tone and the  **Active Parking Assist Finished: Take Control of Vehicle** message prompt you to take control of the vehicle. You have to accelerate, brake, steer and change gear yourself again.

If you do not react to the prompt to take control of the vehicle, the system will brake the vehicle to a standstill.

Pausing Active Parking Assist

You can interrupt the parking or exiting procedure of Active Parking Assist by performing one of the following actions, for example:

- ▶ Depressing the brake pedal
- ▶ Opening the front passenger door, a rear door or the cargo compartment

▶ Applying the electric parking brake or activating the HOLD function

▶ **To resume the parking or exiting procedure:** gently depress the accelerator pedal.

- ⓘ If the electric parking brake was applied before Active Parking Assist was activated, depress the accelerator pedal lightly to start the parking or exiting procedure.

Check the area around your vehicle again before resuming a paused parking procedure. Make sure that persons, animals or objects are no longer in the maneuvering range. Also observe the system limitations of Active Parking Assist.

Automatic braking function of Active Parking Assist

Persons or objects detected in the maneuvering range could cause the vehicle to brake sharply and interrupt the parking or exiting procedure. The vehicle will then be held at a standstill. If you depress the accelerator pedal, the parking or exiting procedure is resumed.

Check the area around your vehicle again before resuming the parking or exiting procedure. Make sure that persons, animals or objects are no longer

in the maneuvering range. Also observe the system limitations of Active Parking Assist.

Remote Parking Assist

Function of Remote Parking Assist

- ⓘ Remote Parking Assist is an additional function of Active Parking Assist. Comply with local traffic laws and regulations when using Remote Parking Assist on public roads. If it is required to turn the wheels toward the curb, you cannot use Remote Parking Assist. Please note that you can only use Remote Parking Assist if you have a valid driving license and are in a fit state to drive.

Remote Parking Assist parks your vehicle or exits the parking space while you are outside of your vehicle. You can monitor the maneuvering and parking procedure on your mobile phone.

With Remote Parking Assist, you can carry out all the parking procedures of Active Parking Assist. You can also position the vehicle directly in front of a garage or a driveway entrance and then use Remote Parking Assist to enter or exit a parking space.

Remote Parking Assist manages pulling away, braking and steering. While Remote Parking Assist is active, the vehicle is locked.

Remote Parking Assist is only an aid. It is not a substitute for your attention to the surroundings. The responsibility for safe maneuvering and parking remains with you. Interrupt or terminate the parking procedure if necessary. Make sure that no persons, animals or objects etc. are in the maneuvering range. Make sure to also pay attention to other vehicles.

System limits

If the system detects a malfunction or a system limit during the maneuvering or parking procedure, the procedure will be canceled:

- The vehicle is brought to a standstill.
- Transmission position **P** is selected and the electric parking brake is applied automatically.
- The vehicle is switched off.
- The vehicle remains locked.

If the parking maneuver is canceled, a corresponding message is displayed on the mobile phone.

Depending on the situation, you can then take control of the procedure, maneuver the vehicle back to the starting position or manually take control of the vehicle.

The system limits of Active Parking Assist apply (→ page 270).

Certain environmental conditions, such as snowfall or heavy rain, may lead to a parking space being measured inaccurately or to connection problems with the mobile phone. Only use Remote Parking Assist on level, high-grip ground.

During the parking procedure, you should not stand more than approx. 10 ft (3.0 m) away from the vehicle. At greater distances, the procedure will be interrupted and a corresponding message will be displayed on the mobile phone. If you move closer to the vehicle, you will be able to continue the procedure.

Operating Remote Parking Assist

Requirements:

For the Remote Parking Assist function, you require a mobile phone and the current Remote Parking Assist App for your vehicle type.

 A list of compatible mobile phones can be found at: <https://www.mercedes-benz-mobile.com/>

The following operating systems are supported:

- Android™
- Apple® iOS

WARNING Danger due to insufficient view of the vehicle surroundings

If you maneuver, park or exit a parking space with the vehicle using Remote Parking Assist, observe the following:

- ▶ Make sure that you have the best view possible of the vehicle and the vehicle's surroundings.
- ▶ Make sure that no persons, animals or objects are in the path of your vehicle.
- ▶ Make sure that you maintain a suitable distance to the vehicle and that neither you nor other road users could be endangered.

- ▶ Be aware of the vehicle's surroundings at all times and identify possible dangers.
- ▶ If necessary, cancel the parking procedure.

No persons or pets are permitted to remain in the vehicle during the parking procedure. Observe the system limits at all times. If necessary, cancel the parking procedure. Always make sure that others can access their vehicles.

- ▶ Activate the "Remote Parking Assist" service e.g. via the Mercedes me homepage.
- ▶ Authorize the mobile phone using the Remote Parking Assist App in the vehicle (→ page 279).

Selecting the parking maneuver in advance while inside the vehicle

- ▶ Stop the vehicle and select transmission position **P**.

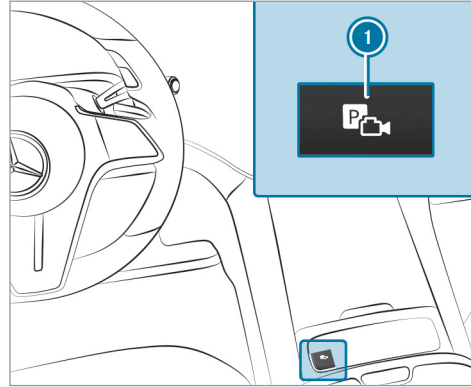

- ▶ Depending on the vehicle's equipment, button ① may also be located at a different position in the center console.
- ▶ Press button ①.

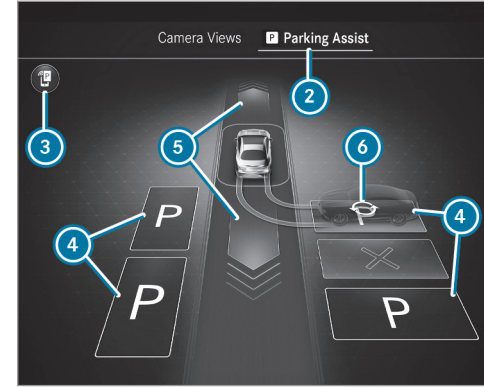

- ▶ Select **Parking Assistance** menu ②.
- ▶ For further information on Remote Parking Assist: select ③.
- ▶ If necessary, select another parking space ④ or select ⑤ to drive straight ahead into a garage, for example.
- ▶ If necessary, change parking direction ⑥.

- Alternatively, you can begin parking with Active Parking Assist (→ page 272) and continue with the Remote Parking Assist from any vehicle position. To do this, stop the vehicle during the parking procedure and select transmission position **P**.

- Switch off the vehicle and exit it with the SmartKey.

Starting the parking procedure without selecting in advance

- Stop the vehicle and select transmission position **P**.
- Switch off the vehicle and exit it with the SmartKey.

Starting the parking procedure while outside the vehicle

- Unlock the vehicle.

Carrying out a parking procedure with Remote Parking Assist

- Keep the vehicle key with you during the parking procedure. You can cancel the parking

procedure and bring the vehicle to a standstill by pressing a button on the SmartKey.

- On completion of the parking procedure, the vehicle is locked.

If you have started the parking procedure as described above, the vehicle is ready to connect to your mobile phone for a limited time.

- Start the Remote Parking Assist App on the mobile phone and connect to the vehicle.
- Follow the instructions of the Remote Parking Assist App.

- The turn signal indicator is automatically switched on when starting parking and switched off when it is completed.
- If the connection between the vehicle and the mobile phone is interrupted while a parking maneuver is being performed, the maneuver can be continued if the connection is re-established within a short time.

⚠ WARNING Risk of accident due to vehicle swinging out while parking or pulling out of a parking space

While parking or pulling out of a parking space, the vehicle swings out and can drive onto areas of the oncoming lane.

This could cause you to collide with objects or other road users.

- Pay attention to objects and other road users.
- Where necessary, stop the vehicle or cancel the parking procedure with Remote Parking Assist.

- After ending the parking procedure, ensure that all vehicle doors, windows and the trunk are closed. Secure the vehicle against rolling away.

Canceling the parking procedure

You can cancel the parking procedure of Remote Parking Assist at any time and bring the vehicle to a standstill.

- ▶ Cancel the parking procedure in the Remote Parking Assist app.
- or
- ▶ Press a button on the vehicle SmartKey.
- or
- ▶ Pull a door handle.

Authorizing/de-authorizing a mobile phone for Remote Parking Assist

Multimedia system:

- ▶  ▶ Settings ▶ Assistance
- ▶ Parking

Authorizing a new mobile phone

In order to be able to use the Remote Parking Assist function, you must authorize your mobile phone. You can authorize up to ten mobile phones.

- ▶ Select **Remote Parking Assist**.
- ▶ Select **Authorize a New Device**.
Remote Parking Assist is ready to connect.
- ▶ Start the Remote Parking Assist app and additionally start the authorization process.
A connection prompt is displayed.

- ▶ Scan the QR code on the central display.
The mobile phone is authorized.

De-authorizing mobile phones

- ▶ Select **Remote Parking Assist**.
- ▶ Select **Deauthorize Devices**.
- ▶ **To de-authorize a mobile phone:** select a mobile phone.
The mobile phone is deleted from the device list.
- ▶ **To de-authorize all mobile phones:** select **Deauthorize All Devices**.
All mobile phones are deleted from the device list.

Maneuvering assistance

Function of Drive Away Assist

Drive Away Assist can reduce the severity of an impact when pulling away. If the system detects an obstacle in the direction of travel, the vehicle's speed is briefly reduced to approximately 1 mph (2 km/h).

A risk of collision may occur in the following situations, for example:

- If the driver mixes up the accelerator and brake pedals.
- If the driver engages an incorrect gear.
- If the driver depresses the accelerator pedal with too much force.

Drive Away Assist is active under the following conditions:

- If the vehicle was stationary and the transmission position was changed to **R** or **D**.
- If the vehicle has rolled less than approximately 3.3 ft (1.0 m) since being at a standstill.
- If the detected obstacle is less than approx. 3.3 ft (1.0 m) away.

Drive-away Assist can be deactivated or activated in the **Maneuvering Assistance** menu (→ page 282).

If a critical situation is detected, the following symbol appears in red in the selected view in the **Camera & Parking** menu:



- i** If Drive Away Assist is not available, the same symbol appears in gray. If the **Camera & Parking** menu is not open on the central display, the symbol and pop-up of Parking Assist PARKTRONIC both appear.

Drive Away Assist is only an aid. It is not a substitute for your attention to the surroundings. The responsibility for safe maneuvering and parking remains with you. Make sure that no persons, animals or objects etc. are in the maneuvering range.

⚠ WARNING Risk of accident caused by limited detection performance of Drive Away Assist

Drive Away Assist cannot always clearly identify objects and traffic situations.

- ▶ Always pay careful attention to the traffic situation; do not rely on Drive Away Assist alone.

- ▶ Be prepared to brake or swerve as necessary, provided the traffic situation permits and that it is safe to take evasive action.

System limits

The system limits of Active Parking Assist apply (→ page 270).

On uphill gradients, the performance of Drive Away Assist is restricted.

Function of cross traffic warning

The cross traffic warning can warn you of crossing traffic when you are exiting a parking space. The radar sensors in the bumper also monitor the area adjacent to the vehicle.

The cross traffic warning is active under the following conditions:

- **Warning for Cross Traffic, Rear:** the vehicle is driving in reverse at a speed slower than approx. 6 mph (10 km/h).
- **Warning for Cross Traffic, Front:** the vehicle is driving forwards at a speed slower than approx. 6 mph (10 km/h) and the camera

image is shown in the central display (→ page 266).

The **Warning for Cross Traffic, Front** can be deactivated or activated in the **Maneuvering Assistance** menu (→ page 282).

If a critical situation is detected, the following symbol appears in red in the selected view in the **Camera & Parking** menu:



Warning for Cross Traffic, Rear: the vehicle can be automatically braked if cross traffic is detected.

- i** If the cross traffic warning is not available, the  symbol appears in gray. If the **Camera & Parking** menu is not opened in the central display, the symbol and pop-up of Parking Assist PARKTRONIC both appear.

The cross traffic warning is only an aid and not a substitute for your attention to the surroundings. The responsibility for safe maneuvering and park-

ing remains with you. Make sure that no persons, animals or objects etc. are in the maneuvering range.

▲ WARNING Risk of accident caused by limited detection performance of the cross traffic warning

The cross traffic warning cannot always clearly identify objects and traffic situations.

- ▶ Always pay careful attention to the traffic situation; do not rely on the cross traffic warning alone.
- ▶ Be prepared to brake or swerve as necessary, provided the traffic situation permits and that it is safe to take evasive action.

System limits

The system limits of Active Parking Assist apply (→ page 270).

If the radar sensors are obstructed by vehicles or other objects, detection is not possible.

In the following situations, the cross traffic warning is not available:

- On inclines

Maneuvering brake function

The maneuvering brake function can prevent collisions with pedestrians when the vehicle is backing up at slow speeds. If the rear view camera detects a person in the vehicle path, the vehicle can be braked to a standstill.

The maneuvering brake function can intervene under the following conditions:

- The vehicle is backing up at a speed slower than 6 mph (10 km/h).
- The camera image is shown in the central display (→ page 266).

Depending on the country, you can activate and deactivate the maneuvering brake function in the **Maneuvering Assistance** menu (→ page 282).

If the maneuvering brake function is triggered, the following symbol appears in red in the selected view in the **Camera & Parking** menu:



- i** If the maneuvering brake function is not available, the same symbol appears in gray.

The maneuvering brake function is only an aid. It is not a substitute for your attention to the surroundings. The responsibility for safe maneuvering and parking remains with you. Make sure that no persons, animals or objects etc. are in the maneuvering range.

▲ WARNING Risk of accident caused by limited detection by the maneuvering brake function

The maneuvering brake function cannot always clearly detect people. Other obstacles are not detected by the function.

In these cases, the function may brake unnecessarily or not brake at all.

- ▶ Always pay careful attention to the traffic situation; do not rely on the maneuvering brake function alone.
- ▶ Be ready to brake.

System limits

Observe the system limits of the following functions:

- Active Parking Assist (→ page 270)
- Surround view camera (→ page 262)
- Rear view camera (→ page 260)

The maneuvering brake function is not available in the following situations:

- On inclines

Activating/deactivating the maneuvering assistant

Multimedia system:

→  ▶ Settings ▶ Assistance
▶ Parking

- ⓘ This function is available on demand (→ page 29).
- ▶ Select **Maneuvering Assistance**.

- ▶ Activate or deactivate the desired maneuvering assistant.

Memory Parking Assist

Function of Memory Parking Assist

Memory Parking Assist can park your vehicle using a previously stored parking space. You can store parking procedures with a total distance of up to 550 yds (500 m) (110 yds (100 m) per parking or exiting procedure).

During parking or exiting, the system can travel a previously stored path of up to approximately 110 yds (100 m) to or out of the desired parking space, for example, from the driveway entrance into the garage.

Within a radius of approx. 165 yds (150 m), only one parking or exiting procedure can be recorded.

Only use Memory Parking Assist on private property. Use on public roads, e.g. in public parking spaces, is not permitted.

Memory Parking Assist is only an aid. It is not a substitute for your attention to the surroundings. The responsibility for safe maneuvering and park-

ing remains with you. Make sure that no persons, animals or objects etc. are in the maneuvering range.

System limits

Observe the system limitations of Active Parking Assist (→ page 270).

⚠ WARNING Risk of accident due to objects located above or below the detection range of Memory Parking Assist

If there are objects above or below the detection range, the following situations may arise:

- Memory Parking Assist may steer too early.
- The vehicle may not stop in front of these objects.

This result in a collision.

- ▶ In these situations, do not use Memory Parking Assist.

Objects located above or below the detection range of Memory Parking Assist may not be detected during the parking procedure.

Drawbars of parked trailers, among other objects, that protrude into the parking space may not be detected.

Do not use Memory Parking Assist in the following situations, for example:

- In extreme weather conditions such as ice, packed snow or in heavy rain.
- When transporting a load that protrudes beyond the vehicle.
- If the parking space is on a steep downhill or uphill gradient.
- When snow chains are installed.

Recording a parking procedure using Memory Parking Assist

Requirements:

- The entire route is, for example, within your own property and not on public roads.
- The system needs reference points in the surroundings to orient itself, such as fences, walls or trees. Therefore, after starting the vehicle, a certain distance must first be driven. If not enough reference points are

detected in the surrounding area, no new route can be recorded.

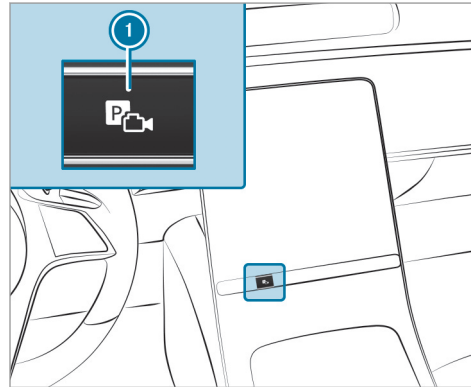

- ① Depending on the vehicle's equipment, button ① may also be located at a different position in the center console.
- ▶ Press button ①. The **Camera & Parking** view opens in the central display.



- ▶ Select **Memory Parking Assist** menu ②.
- ▶ Brake the vehicle to a standstill at the desired starting point of the assisted parking procedure, e.g. a driveway entrance.
- ▶ **To start recording:** press ③.
- ① If not all conditions for a recording are met, symbol ③ is grayed out.

▶ Park the vehicle in the desired parking space. Do not exceed 5 mph (8 km/h).

▶ **To end recording:** stop the vehicle and press ③ again.

The recording is stored.

① In the Memory Parking Assist settings you can delete and rename stored parking procedures.

Parking with Memory Parking Assist

Requirements:

- A parking procedure has been recorded.

▶ Press button ①.

The **Camera & Parking** view opens on the central display.



▶ Select the **Memory Parking Assist** menu ②.

▶ Brake the vehicle to a standstill at the starting point of the stored parking procedure.

▶ **To start the parking procedure:** press .

▶ Select the stored parking procedure from the list.

▶ Follow the instructions on the central display. The vehicle drives into the selected parking space.

① The turn signal indicator is not switched on automatically. You are responsible for selecting the turn signal indicator in accordance with the traffic conditions.

▶ After completion of the parking procedure, safeguard the vehicle against rolling away.

Exiting a parking space with Memory Parking Assist

Requirements:

- The exiting procedure was recorded together with the respective parking procedure and stored separately within one driving cycle.
- The vehicle was parked using Memory Parking Assist.

▶ Press button ①.

The **Camera & Parking** view opens in the central display.

▶ Select **Memory Parking Assist** menu ②.

Starting the exiting procedure

- ▶ Press .
 - ▶ Confirm the saved exiting procedure.
 - ▶ Follow the instructions on the central display. The vehicle drives the recorded route.
- i** The turn signal indicator is not switched on automatically. You are responsible for selecting the turn signal indicator in accordance with the traffic conditions.
- ▶ Take control of the vehicle after the exiting procedure has been completed.

Setting Memory Parking Assist

Multimedia system:

-  ▶▶ Settings ▶▶ Assistance
- ▶▶ Camera & Parking ▶▶ Parking Assistance
- ▶▶ Memory Parking Assist

Renaming a recording

- ▶ Select **Manage Lanes**.
- ▶ Select  next to the desired recording.
- ▶ Enter a name and confirm with OK.

Deleting a recording

- ▶ Select **Manage Lanes**.
- ▶ Select  next to the desired recording.
- ▶ Confirm the message prompt with **Yes**.

Deleting all recordings

- ▶ Select **Manage Lanes**.
 - ▶ Select **Delete All Lanes**.
- i** Alternatively, you can delete all data in Memory Parking Assist by resetting the multimedia system (→ page 320).

Vehicle towing instructions

The vehicle is not suitable for the use of tow bar systems that are used for flat towing or dinghy towing, for example. Attaching and using tow bar systems can result in damage to the vehicle. When you are towing a vehicle with tow bar systems, safe driving characteristics cannot be guaranteed for the towing vehicle or the towed vehicle. The vehicle-trailer combination may swerve from side to side.

Observe the following information:

- Permitted towing methods (→ page 372)
- The notes on towing the vehicle with both axles on the ground (→ page 373)

Notes on the driver display

⚠ WARNING Risk of accident if the driver display fails

If the driver display has failed or is malfunctioning, function restrictions in systems relevant to safety cannot be detected.

The operating safety of your vehicle may be impaired.

- ▶ Drive on carefully.
- ▶ Have the vehicle checked immediately at a qualified specialist workshop.

! NOTE Mercedes-AMG vehicles

- ▶ Observe the notes in the Supplement. You could otherwise fail to recognize dangers.

If the operating safety of your vehicle is impaired, park the vehicle immediately and safely. Contact a qualified specialist workshop.

The driver display shows the following basic information:

- Speed and power meter level
- Range according to average consumption, personal driving style or high-consumption driving style
- Condition of charge of the high-voltage battery
- Warning and indicator lamps

Additional functions available to you include the following:

- Different menus, e.g. for assistance and navigation
- Status displays for the driving systems
- Display messages

The menu contents and settings can be individually adapted and set.

Notes on the range

The range in general

- All ranges shown are assumptions based on various calculation bases. The actual range achieved may differ from the range displayed.
- Outside temperatures, climate control settings, vehicle interior temperatures, road conditions, driving style etc. directly influence the achievable range.
- Pay attention to the charging prompts at all times.

Range according to personal driving style

- Your previous individual consumption will be taken into account when the range is being calculated.
- While the navigation system or commuter route is active, additional information about the route ahead can be included in the range calculation.
- When the trip computer **From Reset** is reset, the data on the previous driving style will also be deleted and calculated afresh from this point on.

Range with low consumption

- The maximum range shows the range potential when consumption is low, e.g. as a result of economical driving or having the air conditioning system turned off.

Range with high consumption

- The minimum range shows the range when consumption is high, e.g. as a result of a sporty driving style or having the air conditioning system turned on.
- This range is determined based on past and current consumption figures.
- When the trip computer **From Reset** is reset, the data on the previous driving style will also be deleted and calculated afresh from this point on.

Electrical consumption

- The consumption figures **From Start** and **From Reset** take into account all active consumer equipment when it comes to the drive system's operational readiness **READY**.

Operating the driver display

⚠ WARNING Risk of distraction due to information systems and communications equipment

If you operate information systems and communications equipment integrated in the vehicle when driving, you could be distracted from the traffic situation. This could also cause you to lose control of the vehicle.

- ▶ Only operate this equipment when the traffic situation permits.
- ▶ If you cannot be sure of this, stop the vehicle in accordance with the traffic conditions and operate the equipment with the vehicle stationary.

Observe the legal requirements for the country in which you are currently driving when operating the driver display.

Scrolling on the menu bar

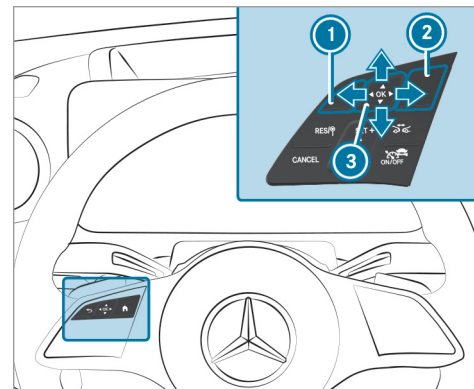

- 1 Back button
- 2 Main menu button
- 3 Touch Control

The content on the driver display is controlled using the control elements on the left side of the steering wheel. Touch Control **3** is used to navigate in a vertical and horizontal direction by swip-

ing with one finger. Confirm the selection by pressing the Touch Control.

i To operate Touch Control **3** in the most effective way, use the tip of your thumb if possible. You can also set the sensitivity of the Touch Control on the central display .

▶ Briefly press main menu button **2** .

▶ Select a menu by swiping to the left or right on Touch Control **3** .

▶ Press Touch Control **3** to confirm.

Driver display menus

Notes on menus on the driver display

⚠ WARNING Risk of distraction due to information systems and communications equipment

If you operate information systems and communications equipment integrated in the vehicle when driving, you could be distracted from the traffic situation. This could also cause you to lose control of the vehicle.

▶ Only operate this equipment when the traffic situation permits.

▶ If you cannot be sure of this, stop the vehicle in accordance with the traffic conditions and operate the equipment with the vehicle stationary.

Observe the legal requirements for the country in which you are currently driving when operating the driver display.

The following menus can be called up via the menu bar on the driver display:

- Understated
- Sport
- Classic
- Navigation
- Assistance
- Service

In some of these menus, you can choose between different display content on the center display area.

In most of the menus, you can use **Options** to configure further settings for the menu-specific display content.

i You can find further information about the possible settings and selections in the menus in the Digital Operator's Manual.

Head-up Display

Function of the Head-up Display

The Head-up Display projects various content into the driver's field of vision, for example.

You can use the Head-up Display menu bar to select different contexts, e.g.:

- Minimal
- Sport
- Standard
- Augmented reality
- ECO display
- Settings
- Head-up Display on/off

- i** Depending on the equipment, the functions may differ from the description and images in this Operator's Manual. For example, route guidance with augmented reality is not available in all equipment variants.

The following image shows an example of the Head-up Display. You can choose what content is displayed (→ page 291).

Head-up Display content with navigation (9x3°)

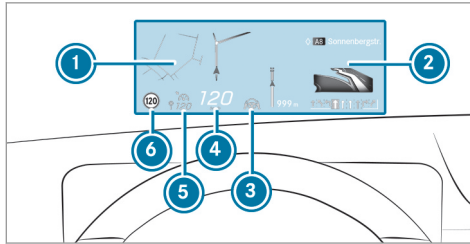

- 1 Navigation instructions
- 2 Navigation instructions (distance to the next route event)
- 3 Steer Assist status

- 4 Current speed
- 5 Set speed in the driving system (e.g. cruise control)
- 6 Detected traffic signs (Traffic Sign Assist)

When you receive a call, the  **Call Waiting** message will appear on the Head-up Display and the driver display.

Head-up Display with navigation and augmented reality (10x5°)

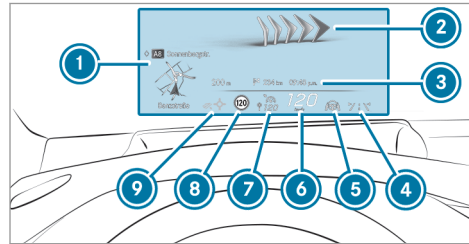

- 1 Navigation instructions
- 2 Augmented reality navigation instructions

- 3 Navigation status displays, such as remaining distance to the destination, expected time of arrival
- 4 Active Lane Keeping Assist status
- 5 Steer Assist status
- 6 Current speed
- 7 Set speed in the driving system (e.g. Active Distance Assist DISTRONIC)
- 8 Detected traffic signs (Traffic Sign Assist)
- 9 ECO Assist

When you receive a call, the  **Call Waiting** message will appear on the Head-up Display and the driver display.

System limits

Visibility is particularly influenced by the following conditions:

- Seat position
- Image position setting
- Ambient light
- Wet road surfaces
- Objects on the display cover

- Polarization in sunglasses

Function of the Head-up Display with augmented reality

- ① Augmented reality is only available in connection with the 10x5° Head-up Display.

The Head-up Display with augmented reality projects content into the driver's field of vision, such as:

- Information from and visualization of the navigation system
- Information from and visualization of the driver assistance systems, e.g. Active Distance Assist DISTRONIC
- Information from the menus of the driver display



Head-up Display with augmented reality (example)

- ① Marker of the detected vehicle in front (Active Distance Assist DISTRONIC)
- ② Change-of-direction arrows for the route (navigation)
- ③ Status line for driver assistance systems

The marker of the detected vehicle in front and the change-of-direction arrows for the route are dynamic displays. The vehicle marker stays with the vehicle in front, and Active Distance Assist regulates your speed based on this. The change-of-direction arrows point the way calculated by the navigation system.

System limits

The marker of the detected vehicle in front may be inaccurate or may not be applied to the correct vehicle in some situations. Always pay attention to the actual driving situation.

Route guidance with augmented reality is not available in some situations, e.g. in the event of poor satellite reception or roads that have not been digitized.

Visibility is influenced by conditions including the following:

- Driver camera and multifunction camera recording
- The extent to which the windshield in the area of the multifunction camera is dirty, or if the camera is fogged up, damaged or obscured

Further system limits of the Head-up Display (→ page 288).

Operating the Head-up Display

Selecting display content of the Head-up Display via the menu bar of the driver display

- ▶ Press the main menu button  on the left.
- ▶ **To select the menu bar of the Head-up Display:** swipe upwards on the left-hand Touch Control.



Switching between display contents on the Head-up Display



- ▶ Swipe right or left on the left-hand Touch Control.
The Head-up Display shows a preview of the selected display contents after each swipe.

- ▶ Press the  button to confirm the desired content.

Switching back to the driver display

- ▶ Press the  or  button.

Setting the position and brightness

- ▶ On the menu bar of the Head-up Display, select **Settings** by swiping to the left or right.
- ▶ Press the left-hand Touch Control. The current position and brightness settings will be displayed graphically on the Head-up Display as well as on the driver display.
- ▶ **To adjust the position:** swipe upwards or downwards on the left-hand Touch Control.
- ▶ **To adjust the brightness:** swipe to the right or left on the left-hand Touch Control. The settings configured for position and brightness will be saved automatically.
- ▶ Press the  or  button to exit the settings.
- ▶ **Information:** **Vehicles with augmented reality function:** when the position is adjusted, the status bar will be moved upwards and the display sec-

tion reduced. This may slightly affect the area on which the augmented reality content is displayed.

Selecting the Head-up Display with augmented reality

- ▶ Press the main menu button  on the left.
- ▶ **To select the menu bar of the Head-up Display:** swipe upwards on the left-hand Touch Control.
- ▶ **To select the Head-up Display with augmented reality:** swipe to the left or right on the left-hand Touch Control to activate the desired content.

Switching the Head-up Display on/off

Driver display:



Switching on

- ▶ Swipe upwards on the left-hand Touch Control.

292 Driver display

- ▶ Press **OK** on the left-hand Touch Control.

Switching off

- ▶ Swipe upwards on the left-hand Touch Control.
- ▶ Select **Head-up Display** by swiping on the left-hand Touch Control.
- ▶ Press **OK** on the left-hand Touch Control.

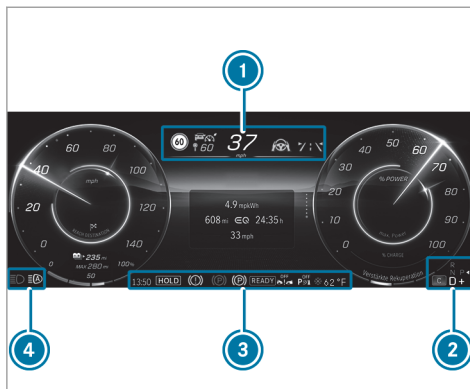

Overview of status displays on the driver's display

The status displays for the driving and driving safety systems can be found in display sections ① to ④.



- ① The number, position and presentation of the status indicators on the driver's display depend on which systems are activated or deactivated.
- ④ Pedestrian detection (only on assistant display)
- ② Active Parking Assist available (→ page 272)

- ③ Active Parking Assist has detected a parking space (→ page 272)
- ④ Parking Assist PARKTRONIC deactivated (→ page 269)
- ③ Cruise control (→ page 226)
- ④ Active Distance Assist DISTRONIC (→ page 228)
- ④ Specified distance for Active Distance Assist DISTRONIC (→ page 228)
- ④ Active Brake Assist switched off (→ page 246)
- ④ Active Brake Assist impaired or not functioning (→ page 246)
- ④ Active Steering Assist (→ page 236)
- ④ Active Lane Change Assist (→ page 239)
- ④ Active Lane Keeping Assist (→ page 255)
- ④ Active Blind Spot Assist (only on assistant display) (→ page 254)
- ④ Haptic accelerator pedal (→ page 188, 190)
- ④ HOLD function (→ page 221)

-  Adaptive Highbeam Assist (→ page 150)
Adaptive Highbeam Assist Plus
(→ page 152)
-  Active Stop-and-Go Assist (→ page 235)
-  Slippery road surface warning

Vehicles with Traffic Sign Assist: Detected instructions and traffic signs (→ page 246)

-  Acoustic presence indicator inoperative
(→ page 432)

Overview and operation

Notes on the MBUX multimedia system

⚠ WARNING Risk of distraction due to information systems and communications equipment

If you operate information systems and communications equipment integrated in the vehicle when driving, you could be distracted from the traffic situation. This could also cause you to lose control of the vehicle.

- ▶ Only operate this equipment when the traffic situation permits.
- ▶ If you cannot be sure of this, stop the vehicle in accordance with the traffic conditions and operate the equipment with the vehicle stationary.

You must observe the legal requirements for the country in which you are currently driving when operating the multimedia system. Depending on the equipment, the scope of function and product designation of your MBUX multimedia system may differ from the description and

images in this Operator's Manual. For example, route guidance with augmented reality is not available in all equipment variants.

! NOTE Increased surface temperature due to direct sunlight on the central display

The surface of the central display is very dark. If the display is exposed to direct sunlight, the surface can become very hot.

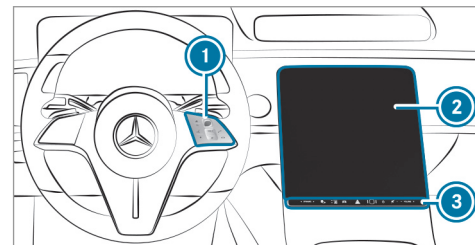

- ▶ If the central display has been exposed to direct sunlight, allow it to cool down before touching it for a long time.

Overview of the MBUX multimedia system





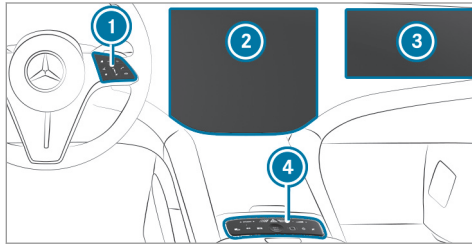

Vehicles with central display

- ① Touch Control and control panel for the MBUX multimedia system
MBUX stands for Mercedes-Benz User Experience.
 - Operating Touch Control
- ② Central display with touch functionality
 - Home screen overview
 - Operating the touchscreen
- ③ Control panel with:
 - ▣ Fingerprint sensor

-  Switches the MBUX multimedia system on or off
-  Switches sound on or off
-  Adjusts the volume



Vehicles with MBUX Hyperscreen

- ① Touch Control and control panel for the MBUX multimedia system
 - Operates Touch Control
- ② Central display with touch functionality for the driver
 - Home screen overview
 - Operates the touchscreen
- ③ Front passenger display with touch functionality
 - Home screen overview
 - Operates the touchscreen
- ④ Control panel with:
 -  Fingerprint sensor
 -  Switches the MBUX multimedia system on or off
 -  Switches sound on or off
 -  Adjusts the volume

Further operating options:

- Conducting a dialog with the MBUX Voice Assistant.
- Operating functions contact-free with the MBUX Interior Assistant.
The interaction then follows intelligently, reactively or with hand or head movements.
- If the vehicle is equipped with a driver camera, functions can be triggered via "Look & Answer".

- ① You can find further information about operation as well as about applications and services in the Digital Operator's Manual.

Anti-theft protection

This device is equipped with technical provisions to protect it against theft. Further information on protection against theft can be obtained at an authorized Mercedes-Benz Center.

Zero Layer

Function of the Zero Layer

The Zero Layer provides you with dynamic content from the MBUX multimedia system and is used to quickly access and control the applications you use. When you select  on the central display, the digital map with the applications appears in the lower display area. Compared to the home screen with a classic menu, the steps required to call up the applications are reduced. You can switch between the Zero Layer and the home screen with a classic menu.

The applications can be hidden from the display area and shown again.

The Zero Layer provides the following modules and applications:

- EQ module and navigation module

The EQ module is always shown on the digital map. In the expanded view, charging settings and navigation functions are offered.

- Entertainment (media, radio) and telephone
When the lower display area is shown, the entertainment sources are always displayed.

A mobile phone must be connected to the MBUX multimedia system for the phone to be displayed.

- Active applications

The lower display area shows an active message program, for example.

- Suggestions

Suggestions are displayed on the lower display area based on context and your user behavior. These are, for example, dialed phone numbers, active message programs or vehicle functions.

- Online voice applications

In the lower display area, context-dependent services that can be executed via voice are available for direct access.

The applications are first displayed in a reduced view. By tapping on them, you can operate them or open the associated menu (expanded view).

A long press on a suggestion opens a context menu in which further functions are available.

The suggestion function can be switched on and off completely or for individual options

Overview of the Zero Layer

Digital map and user-specific applications (example)

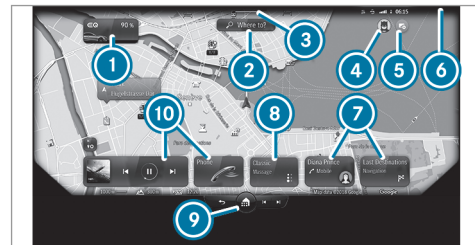

- ① EQ module (reduced view)
- ② Enters a destination
- ③ Calls up the Control Center
- ④ Calls up user profile settings
- ⑤ Content sharing menu
- ⑥ Status line
- ⑦ Suggestions
Requirement: suggestions are activated (→ page 313).
- ⑧ Active application, e.g. message program



Press briefly: displays all applications and the global search (→ page 298)

Press and hold: calls up the home screen with classic menu

- 10 Entertainment sources (media, radio) and telephone

Requirement for phone: the mobile phone is connected to the MBUX multimedia system.

The Zero Layer shows the digital map and the user-specific applications.

The following user-specific applications are displayed in the lower display area:

- Suggestions 7
- Active applications 8
- Entertainment sources and telephone 10
- Online voice applications

The lower display area can be hidden and shown (→ page 298).

Information about entertainment sources

You can operate the applications in the reduced view or in the menu (expanded view) (→ page 298).

Examples:

- Control a media source, e.g. pause/play, next track, set a station
- Select tracks from the current playlist or stations from the station list
- Select a media source

The media source must be connected to the MBUX multimedia system.

If **Entertainment** is activated in the suggestions, suggestions are offered for the currently played media source. Suggestions are also made for online digital services, e.g. Spotify or TuneIn Radio, as well as for categories, e.g. genre, artist and mood.

The selections depend on the suggested application.

Information about the telephone

To use the functions, your mobile phone must be connected with the MBUX multimedia system.

Requirement for suggestions: the **Calls & Messages** and **In-Car Office** options are activated in the suggestions.

Examples:

- Answer a call and calling a missed call
The missed calls are displayed for the mobile phone currently connected to the MBUX multimedia system.
- Display contacts and call list and calling a contact
- Use voice functions
- Suggest contacts
The contacts are suggested for the mobile phone connected to the MBUX multimedia system. No contacts are suggested for a mobile phone that is linked to another user profile.
- Write messages to contacts (suggestion)
- Connect a device via the device manager (suggestion)
- In-Car Office Call to-do list (suggestion)

In-Car Office can also remind you of birthdays, for example.

Information about active applications

The following functions are available:

- Operating message programs
- Operating an ENERGIZING COMFORT program
- Making heating settings
- Raising or lowering the vehicle level

Suggestions for convenience and vehicle functions as well as navigation

Requirement: the **Comfort, Vehicle** and **Navigation** options are activated in the suggestions.

- Operating message programs
For example, the multimedia system suggests a program at a certain time.
- Operating an ENERGIZING COMFORT program
- Opening and closing the tailgate
Requirement: the vehicle is equipped with trunk lid convenience closing.
- Opening and closing the convenience doors

Requirement: the vehicle is equipped with convenience doors.

- Setting the vehicle level
- Activating/deactivating Parking Assist PARKTRONIC
- Selecting previous destinations and destinations from favorites

Information on online voice applications

Requirement: the **Online Voice Services** option is activated in the suggestions.

The suggested voice applications are made available online and are based on your previous voice inputs.

Examples:

- What will the weather be like tomorrow?
- Play the messages.
- Start Geoquiz.
- Open the garage door.

Calling up and operating the Zero Layer

Calling up the Zero Layer



When the vehicle has been switched on, the Zero Layer is displayed with the digital map. Navigation is active.

▶ **From another application:** press the  button on the right side of the steering wheel.

or

▶ Tap on .

Operating applications in the reduced view (examples)

▶ **Media:** to play the previous or next track, tap  or .

▶ **To answer a call or call a missed call:** tap on the contact.



After the connection has been established, the call functions are available.

▶ **To end a call:** tap on the contact again.

▶ **To answer a message:** tap on a message and write the message or dictate via voice recognition.

- ▶ **To start a massage program:** tap on the application and start the massage program.
- ▶ **To select a previous destination:** tap on the application and select one of the previous destinations.
- ▶ **To select a destination from the favorites:** tap on the application and select the destination.

Hiding and showing the display area with applications

- ▶ **To hide:** pull the applications down.
 - ▶ **To show:** pull the bar above  upwards.
- or
- ▶ Select .
- or
- ▶ Press the  button on the steering wheel on the right.

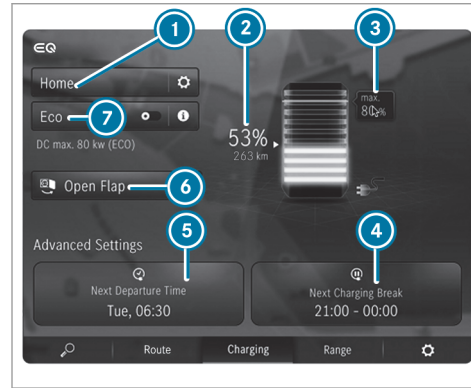

EQ module (expanded view)



- ① Sets the charging program (→ page 209)
- ② Current condition of charge of the high-voltage battery
- ③ Maximum condition of charge (depending on the setting)
- ④ Sets the next charging break (to use a less expensive tariff)

- ⑤ Sets the departure time
- ⑥ Opens the socket flap
- ⑦ Activates or deactivates ECO charging

▶ Tap on the EQ module (→ page 296). The charging settings are displayed. Additional EQ and navigation functions are available in the lower menu bar:

- Symbol 
 - Enters a destination
- **Route**
 - Shows charging stops and the destination
- **Range**
 - Switches range maximization on or off (→ page 191).
- Symbol 
 - Makes settings for [View, Messages & Acoustic Signals](#) and [Route](#)

▶ **To close the menu:** select .

Navigation module (expanded view)



Example: navigation module with active route guidance

- 1 Arrival time at charging stop, type of charging station

- 2 Charging stop shows the charging time recommended by the navigation with Electric Intelligence as well as charge levels on arrival and onward journey for an optimal travel time
 - 3 Distance from current vehicle position and remaining driving time
 - 4 Searches for an additional charging station
- ▶ Tap on the EQ module (→ page 296).
 - ▶ Select **Route** in the lower menu bar.

Operating a menu in the lower display area (example: active message program)



- 1 Selects a message program
- 2 Starts/stops a message program for the driver
- 3 Starts/stops a message program for the front passenger
- 4 Sets the message program intensity for the driver or front passenger

- ▶ Tap on the application. The expanded view of the application is displayed.
- ▶ **To close the menu:** select .

Opening and closing the context menu for a suggestion

- ▶ Press and hold on a suggestion. The context menu opens and shows the **No Longer Suggest** option, for example.
- ▶ **To close:** swipe downwards.

Removing a suggestion from the display area



- ▶ Swipe the suggestion upwards.

Showing all applications



- ▶ Press  briefly. Available applications ① are displayed. The global search is available.



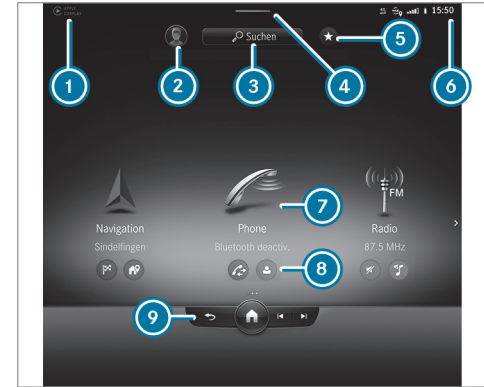

Switching between Zero Layer and home screen with classic menu

- ▶ Long press on . The home screen with classic menu is shown.
- ▶ **To return to the Zero Layer:** press and hold on .

Home screen overview



- ① Status line
- ② Calls up user profile settings and switches user
- ③ Uses the global search
- ④ Calls up the Control Center (pull down)
- ⑤ Calls up favorites
- ⑥ Displays in the status line

- 7 Calls up applications
- 8 Quick-access to application
- 9 Global menu
 -  Calls up previous menu
 -  Press and hold: switches between home screen and Zero Layer
 -  Previous track or previous radio station
 -  Next track or next radio station
- i** During a telephone call, the call duration is displayed in global menu **9**.

The following functions are called up in the Control Center:

- Notifications Center
- Content sharing menu
- Favorites
- Vehicle quick-access

Content sharing menu in the Control Center

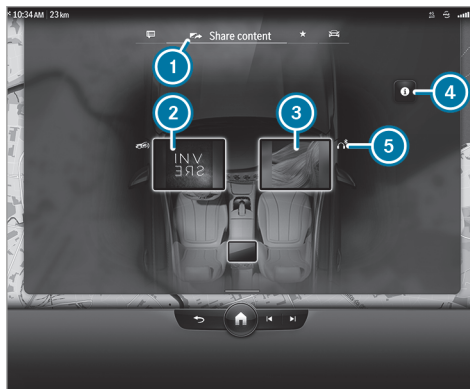

Example: Content sharing menu

- 1** Calls up a menu
- 2** Central display with active content (cover display)
- 3** Front passenger display

- 4** Displays animation for content sharing
- 5**  Bluetooth® headphones connected to the front passenger display on the right

To share content, drag a display and drop it over another display.

To control media playback, tap a display.

- i** If the vehicle is equipped with the MBUX high-end Rear Seat Entertainment System and MBUX rear tablet, the following is displayed under **2** and **3**:
 - The rear display
 - The MBUX rear tablet

Operating the MBUX multimedia system

Using Touch Control

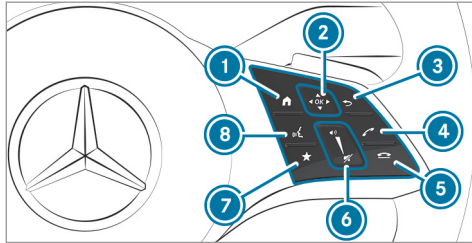

- ① Shows the home screen
- ② Touch Control
 - swipe in the direction of the arrow (navigate)
 - Press (confirm)
- ③ Returns to the previous display
- ④ Makes or accepts a call
- ⑤ Rejects or ends a call
- ⑥ Increase volume: swipe upwards
Reduce volume: swipe down

- ⑦ Switches off the sound: press
- ⑦ Calls up favorites (press briefly) or adds favorites (press and hold)
- ⑧ Starts the MBUX Voice Assistant

You can navigate through menus and lists via the touch-sensitive surface of Touch Control ② using a **single-finger swipe**, for example:

- ▶ **To enter a character:** select a character using the keyboard and press on Touch Control ②.
- ▶ **To select a menu option:** scroll in a list and press Touch Control ②.
- ▶ **To move the digital map:** swipe in any direction.

Using the touchscreen

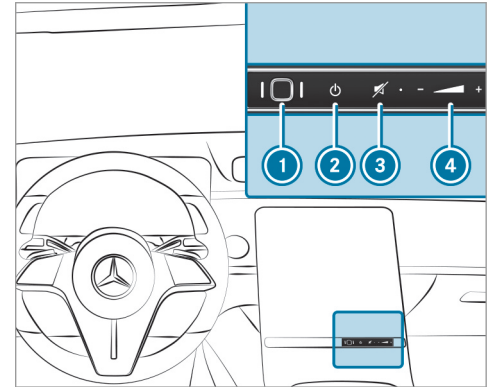

Example: control elements for vehicles with a central display

- ① Fingerprint sensor
- ② Switches the MBUX multimedia system on or off
- ③ Switches the mute function on/off

- ④ Adjusts the volume
Press **-** or **+** or swipe over the button

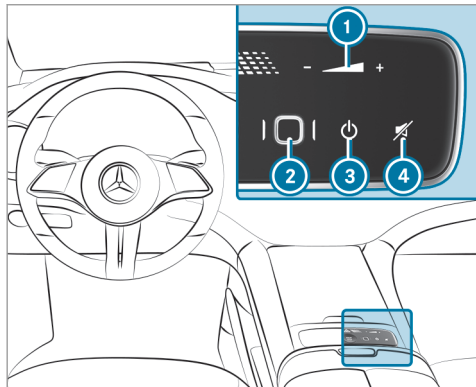

Example: control elements for vehicles with an MBUX Hyperscreen

- ① Adjusts the volume
Press **-**, or **+**.
- ② Fingerprint sensor

- ③ Switches the MBUX multimedia system on or off
- ④ Switches the mute function on/off

- ▶ **To select a menu item or entry:** tap on a symbol or an entry.
- ▶ **To increase the map scale:** tap twice quickly with one finger.
- ▶ **To reduce the map scale:** tap with two fingers.
- ▶ **To enter characters with the keypad:** tap on a button.
- ▶ **To navigate in menus:** swipe up, down, left or right.
- ▶ **To use handwriting to enter characters:** write the character with one finger on the touchscreen.
- ▶ **To zoom in and out of the map:** move two fingers together or apart.
- ▶ **To enlarge or reduce the size of a section of a website:** move two fingers together or apart.
- ▶ **To turn the digital map:** turn counter-clockwise or clockwise using two fingers.

- ▶ **To move the digital map:** touch the touchscreen and move your finger in any direction.
- ▶ **To save the destination in the digital map:** touch the touchscreen and hold until a message is shown.
- ▶ **To call up the home screen:** swipe up with three fingers in an application.
- ▶ **To set the volume on a scale:** touch the touchscreen and move the finger to the left or right.
- ▶ **To call up a global menu in the applications:** touch the touchscreen and hold until the **Options** menu appears.

Function of the MBUX Voice Assistant

⚠ WARNING Risk of distraction due to information systems and communications equipment

If you operate information systems and communications equipment integrated in the vehicle when driving, you could be distracted from

the traffic situation. This could also cause you to lose control of the vehicle.

- ▶ Only operate this equipment when the traffic situation permits.
- ▶ If you cannot be sure of this, stop the vehicle in accordance with the traffic conditions and operate the equipment with the vehicle stationary.

For your own safety, always observe the following points when operating mobile communications equipment and especially your voice control system:

- Observe the legal requirements for the country in which you are driving.
- If you use the voice control system in an emergency your voice can change and your telephone call, e.g. an emergency call, can thereby be unnecessarily delayed.
- Familiarize yourself with the voice control system functions before starting the journey.

Using the MBUX Voice Assistant, vehicle functions and various areas of the MBUX multimedia system can be operated by voice input. The MBUX

Voice Assistant is operational approximately half a minute after switching on the ignition and can be operated from all seats. Further information and examples of voice commands can be found in the Digital Operator's Manual.

You can use the MBUX Voice Assistant to operate the following functions depending on the vehicle equipment:

- Telephone
- Text message and e-mail
- Navigation
- Radio, media, TV
- Vehicle functions
- Online functions

Full functionality of the voice control system is only available for you with activation of online voice control.

Conducting a dialog

Starting a dialog

- ▶ Say "Hey Mercedes" to activate the MBUX Voice Assistant. Voice activation must be switched on in the multimedia system.

or

- ▶ Press the  button on the multifunction steering wheel. A blue line appears in the MBUX multimedia system. The dialog can be started.

For the dialog with the MBUX Voice Assistant, you can use complete sentences of colloquial language as voice commands. Voice activation can also be directly combined with a voice command, e.g. "Hey Mercedes, how fast can I drive?".

Calling up help

- ▶ **For information about the MBUX Voice Assistant:** say "Hey Mercedes, what can you do?"
- ▶ **Digital Operator's Manual:** "Show me the Operator's Manual". The full extent of the Digital Operator's Manual is available when the vehicle is stationary.

Operating functions (examples)

- ▶ **To operate the navigation:** "Search for an Asian restaurant, but not Japanese, in South London."
- ▶ **To operate the phone:** "Call my father."
- ▶ **To change the system language to English (short command):** "Change language to English".
- ▶ **To operate the radio:** "Show me the list of radio stations."
- ▶ **To operate media:** "Switch on random playback."
- ▶ **To operate vehicle functions:** "Switch the seat heating to level 2."
- ▶ **To operate online functions:** "What's the time in Sydney?"
- ▶ **To ask a question about the vehicle:** "Do I have Blind Spot Assist?"

Overview of the MBUX Interior Assistant

⚠ WARNING Risk of injury from the camera's laser radiation

This product uses a classification 1 laser system. If the housing is opened or damaged, laser radiation may damage your retina.

- ▶ Do not open the housing.
- ▶ Always have maintenance work and repairs carried out by a qualified specialist workshop.

This product complies with the requirements of the FDA 21 CFR 1040.10 and 1040.11 with exception of the variations according to the FDA Laser Notice No. 50 from 24. June 2007.

- ① The camera records image data for the applications, for example body, head and hand detection. The camera converts the image data directly into meta data. No image data is saved in the process. The data is only processed in the vehicle and is not transmitted from the vehicle.

- ① The MBUX Interior Assistant is automatically activated whenever the engine is started. You can set the functions individually or switch the Interior Assistant on or off. The most recently active settings are stored in your user profile. If you switch off the Interior Assistant, for example, this setting will be adopted in your user profile. However you do not change any other active user profile in which the Interior Assistant is switched on.

The MBUX Interior Assistant detects the presence of the front vehicle occupants using a 3D laser camera. The Assistant interprets natural hand, head and body movements contextually or upon the explicit request of the vehicle occupants. The Assistant can thus automatically trigger vehicle interior functions and assist appropriately to the situation.

The Assistant recognizes driver and front passenger interactions.

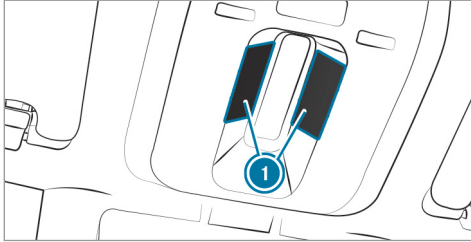

Cameras ❶ are located in the overhead control panel.

The Assistant supports vehicle and infotainment functions at three interaction levels:

- INTELLIGENT
The Assistant recognizes vehicle occupants automatically and activates functions.
- REACTIVE
The Assistant recognizes the natural body language of a vehicle occupant and carries out functions automatically, appropriate to the situation.
- CONTACTLESS

The vehicle occupant actively requests a function using a hand movement or pose.

The Assistant offers functions for the following:

- SAFETY
The Assistant supports vehicle occupants with the use of restraint systems.
- COMFORT
The Assistant enhances comfort by automating functions inside the vehicle and supporting natural interaction with the vehicle.
- INFOTAINMENT
Operating options or information are highlighted and/or shown on the central display as your hand approaches. The vehicle occupants can carry out a favorite function with a hand pose.

System limits, display messages and notes for rectification

The error messages are shown on the central display.

The system may be impaired or may not function in the following situations:

- The camera in the overhead control panel may heat up due to operating conditions. As a result the camera may switch off temporarily, particularly during longer periods of operation and at high outside temperatures.

Do not touch or cover the camera. Wait until the camera has cooled down and is available again.

The [Interior Assistant Unavailable Further Information to Follow](#) message appears.

You receive a message when the camera is available again.

- The camera is covered, dirty, fogged up or scratched.

Wait until the camera has cooled down before cleaning the camera cover.

The [Currently Unavailable See Operator's Manual](#) message appears.

Clean the outside of the camera cover with a dry or damp cotton cloth. Do not use micro-

fiber cloths. Do **not** remove the cover when cleaning.

- A vehicle occupant is very large. Clothing being worn (gloves, hat, scarf, color of clothing) or objects carried on a person, for example a watch with a large face, are affecting the camera view. Or the detection range of the camera is restricted.

The **Interior Assistant availability for the driver is limited**, see **Operator's Manual** message appears.

Keep the camera's field of vision clear.

Objects in the detection range of the camera can restrict the camera view. Please make sure, that no objects hang on the inside rearview mirror, for example.

- The MBUX Interior Assistant is faulty. The **Interior Assistant Not Available. Please contact your Mercedes-Benz dealer.** message appears. Consult an authorized Mercedes-Benz Center.

Anticipatory exit warning (SAFETY/reactive)

Requirements:

- The vehicle is equipped with Active Blind Spot Assist with exit warning.
 - Active Blind Spot Assist is activated (→ page 255).
 - The vehicle is equipped with active ambient lighting or ambient lighting.
- ⓘ Observe the information on the system limits of Active Blind Spot Assist with exit warning (→ page 252).

The function can warn vehicle occupants about a possible collision with an approaching vehicle or bicycle when they exit the vehicle.

As soon as the driver or front passenger moves their hand towards the door handle, depending on the vehicle equipment, the following warnings are issued:

- The active ambient lighting or ambient lighting flashes red.
- The warning lamp in the outside mirror also flashes red for one of the front doors.

- When the door is opened, a warning tone sounds.

- ⓘ The visual warning is thus already given **before** the door is opened.
- ⓘ Further information on Active Blind Spot Assist with exit warning (→ page 252) and on ambient lighting (→ page 155).

Switching the reading light and search light and on or off

Requirements:

- **For the reading light:** the driver's and front passenger's hand movement takes place under the inside rearview mirror.
- **For the search light:** the function is available in the vehicle when it is dark.
- The front passenger seat is not occupied or a child is sitting in a child restraint system.
- The hand movement is made by the driver in the interaction area above the front passenger seat.

Switching the reading light on and off



Carrying out operation of the reading light for the driver and front passenger

- ▶ Move your hand up and down vertically under the inside review mirror.
The reading light is switched on or off.

Switching the search light on and off

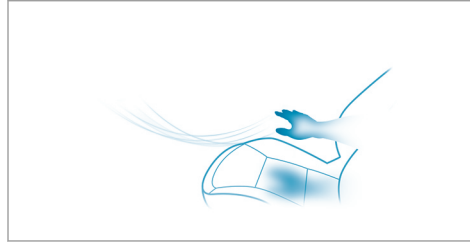

Interaction area for activating the search light

- ▶ **To switch on:** reach across the front passenger seat with a hand.
The search light is switched on automatically for the driver.
- ▶ **To switch off:** take a hand back away from the front passenger seat.
The search light is switched off again.

Automatic preselection of the outside mirror (COMFORT/reactive)

Until now, to set the outside mirror the desired mirror had to be selected using a preselection button in the driver's door.

With the MBUX Interior Assistant, the mirror to be set is preselected automatically by the natural movement of your head to the left or right. When the hand touches the button for adjusting the outside mirror, the LED under the button of the preselected mirror side lights up.

Use the button to set the position of the active outside mirror.

- ① Preselection of the outside mirror using buttons is still possible. Further information on adjusting the outside mirrors (→ page 159).
- ① The driver camera is also used for this application.

Calling up favorites with the V pose (INFOTAINMENT/contactless)

Requirements:

- At least one favorite has been saved in the favorites list.
- The favorite has been connected with the MBUX Interior Assistant.
- The area for detecting the favorites pose (V pose) is above the center console in front of the central display.
- The V pose is held for a brief time.

The V pose makes it easier to call up favorites.

The front vehicle occupants can associate their own favorite with the V-pose. Some examples include a navigation destination, a radio station or a massage program for a seat.

If the vehicle is equipped with a front passenger display, the front passenger can link the V-pose directly to a favorite on the front passenger display. If the front passenger performs the V-pose as described, the favorite will open on the front passenger display.

- ❗ If a favorite has not yet been saved and connected with the MBUX Interior Assistant, the multimedia system will assist you.

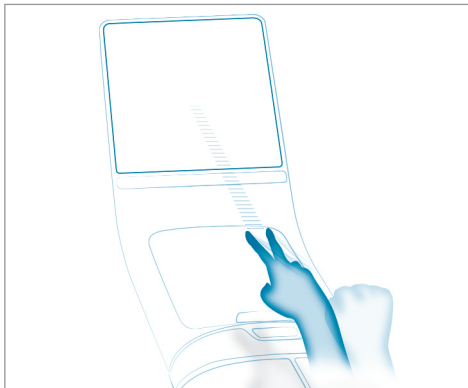

Implementation of the V-pose above the stowage compartment of the center console at the height of the central display

- ▶ Position your hand above the stowage compartment of the center console at the height of the central display. The back of your hand is

facing upwards. In doing so, your index and middle finger are spread to form a V. With your other fingers bent inwards.

- ▶ Briefly hold the V pose. The favorite is called up.

Function of the driver camera

The driver camera is located in the driver display.

The driver camera detects the following characteristics:

- Head position
- Viewing direction
- Eyelid closure characteristics
- Driver's face

- ❗ The driver camera records image data for applications such as ATTENTION ASSIST and facial recognition, for example. The camera converts the image data directly into meta data. No image data is saved in the process. The data is only processed in the vehicle and is not transmitted from the vehicle.

The driver camera is automatically activated each time the vehicle is opened with the SmartKey.

The driver camera must be set up for face detection before use. Teaching-in biometric data (→ page 313).

System limits

The system may be impaired or may not function in the following situations:

- The camera is covered or dirty, fogged up or scratched.
- The driver's face and/or eyes are covered.
- The driver is wearing glasses that block infrared.

Display messages

In the following situations display messages may be shown:

- The driver camera is inoperative.
The camera is faulty.

The **Driver Camera Inoperative See Operator's Manual** message appears.

- The driver camera cannot capture the position of your head.
The **Change the steering wheel/ seat position until 6 dots are visible on the upper edge of the screen.** message appears.
- The view of the driver camera is reduced or restricted.
The **Driver Camera View Currently Restricted See Operator's Manual** message appears.

Notes on care

Please comply with the notes on caring for the interior (→ page 360).

Switching the driver camera on or off

Multimedia system:

-  ▶ Settings ▶ System
- ▶ Intelligent Assistance
- ▶ Select **On** or **Off**.

When the driver camera is switched off, the following functions are not available or limited:

- The MBUX augmented reality Head-up Display (→ page 288)

- The microsleep detection of ATTENTION ASSIST (→ page 224)
- The facial recognition
This function serves as sensor input for authentication and unlocking of the user profile and protected applications (→ page 313).
- Multimodality
This function activates the MBUX Voice Assistant with eye control, e.g. for the confirmation of a display message by voice.
- The mirror preselection (→ page 159)
This function allows the natural movement of the head to the left or right to automatically preselect the outside mirror to be adjusted.

Information on users, suggestions and favorites

⚠ WARNING Risk of becoming trapped during adjustment of the driver's seat after calling up a driver profile

Selecting a user profile may trigger an adjustment of the driver's seat to the position saved

under the user profile. You or other vehicle occupants could be injured in the process.

- ▶ Make sure that when the position of driver's seat is being adjusted using the multimedia system, no people or body parts are in the seat's range of movement.

If there is a risk of someone becoming trapped, stop the adjustment process immediately:

- ▶ a) Tap the warning message on the central display.
 - or
 - ▶ b) Press a memory position button or a seat adjustment switch on the driver's door.
- The adjustment process will be stopped.

The driver's seat is equipped with an access pre-venter.

If the driver's door is open, the driver's seat will **not** be set after calling up the driver's profile.

User profiles and user-specific content

Prerequisites for the vehicle owner:

- You have a Mercedes me user account.
 - You have a Mercedes me PIN.
 - You have agreed to the terms of use.
 - The vehicle is linked to a Mercedes me user account.
- ❗ If one of the pre-requisites listed is missing or if no user profile has been selected, the data described in the following section will be saved in the vehicle as the standard setting. Standard settings can be changed by all vehicle users.

User profiles save personal settings. If the vehicle is used by several people, a person can change their profile settings without changing the settings of other users.

If the vehicle is equipped with the MBUX high end Rear Seat Entertainment System, the occupants in the rear passenger compartment can log in as Mercedes me users from their seats. The Multi-seat Profile Management allows three profiles to

be used simultaneously. A user profile can only be activated simultaneously on one display.

- ❗ Some settings apply to the entire vehicle and are displayed in all user profiles, e.g. ambient lighting and the current navigation settings. These initially belong to the driver, but can also be changed by the other vehicle occupants in their user profile.

You can individualize a user profile in the vehicle using the set-up assistant or using the settings in your user profile. Some settings, e.g. the Mercedes me PIN and a profile photo are made in the Mercedes me app or in the Mercedes me Portal.

User-specific content and applications with personal data are protected by different levels of security. To access protected content, the Mercedes me PIN and, depending on the vehicle equipment, biometric sensors can be used.

- ❗ The security level is set by the multimedia system and calculated from the combination of all sensor inputs. Some security levels cannot be turned off.

i When a user profile is activated, the following personalized comfort systems, for example, can be adjusted or their settings loaded:

- Seat
- Ambient light
- Outside mirrors
- Blinds
- Climate control settings

If the user profile is activated when driving then the driver's seat position will not be adjusted.

Depending on the vehicle equipment you can, as a user, save the following settings, for example:

- Driver's seat, steering wheel and mirror settings
- Climate control
- Ambient lighting
- Radio (including station list)
- Suggestions and favorites

Suggestions

The vehicle can learn the habits of the driver. It then makes suggestions regarding navigation destinations, phone numbers and music preferences. The requirements for that are the selection of a user, your consent to the recording of data and sufficient collected data.

Favorites

Favorites offer you quick access to frequently used applications. 100 favorites are available in total.

Configuring users, suggestions and favorites

Requirements:

- To use the set-up assistant: the vehicle is stationary.

Multimedia system:



Adding a user

- ▶ Select **+** **Add User** .
A QR code is loaded.

- ▶ Scan the displayed QR code with the Mercedes me app or any QR code scanner on a mobile device. If the Mercedes me app is not yet installed on your mobile device, you will be directed to the store of your mobile device.

- ▶ Follow the directions in the app. The vehicle is connected with your Mercedes me user account. This automatically creates your user profile in the vehicle.

If only your user profile is available, it will be loaded automatically.

If more than one user profile is available, you will be directed to the user selection.

When the vehicle is stationary, the set-up assistant starts automatically after user selection.

Selecting user options

- ▶ Select **Settings**.
- ▶ Select **Suggestions**.
- ▶ Select **Allow All Suggestions**.

or

- ▶ Switch the options on or off individually. If an option is switched on and sufficient data has been gathered, suggestions based on your user behavior will be offered to you.
- ▶ **For intelligent multimodality:** select **Multimodality**. If the option is active, the MBUX Voice Assistant can be activated in certain situations.
- ▶ **To switch the learning function off for 24 h:** switch on **Deactivate 24h Intelligent Learning**.
- ▶ **To delete cumulated suggestions:** select **Reset Suggestion History** and confirm **Ja** (Yes).

Protecting user-specific content and applications

If you add a new user, access protection is already activated for the user profile. The Mercedes me PIN and, depending on the vehicle equipment, biometric sensors are available for access. Biometric sensors must be taught in in the vehicle. The authentication process then takes all taught-in and available sensors into account.

The following user-specific content and applications are protected, for example:

- User selection and user profile settings
- Biometric sensors

The teaching-in of biometric sensors is protected.

- Suggestions

The data and determination of the most probable navigation destinations, media sources, radio stations, contacts and messages are protected.

- ENERGIZING COACH

The recorded health data and their evaluation are protected.

- Mercedes me connect store

The purchase of services is protected.

- ▶ Switch **Protect Content** on or off.
- ▶ Switch **Access Protection** on or off.
- ⓘ When access protection is switched off, your user profile can be accessed and changed from every vehicle seat.

- ⓘ Access protection is switched on or off on a vehicle-specific basis.

Teaching in, editing and deleting biometric data

The biometric data models are saved in the sensors in the vehicle. If recognition has been taught-in, this sensor serves as a contributory factor for authentication on the multimedia system.

- ▶ Select **Protect Content**.
- ▶ Select **Facial Recognition**, **Fingerprint Recognition** or **Voice Recognition**.

- ⓘ If necessary, authenticate yourself on the multimedia system.

Authenticating using face recognition

- ▶ Close the driver's door or fasten the driver's seat belt.
- ▶ Look at the driver display for about five seconds. Your face is scanned. A message in the driver display shows whether facial recognition was successful or not. You can unlock your user profile and protected applications with the facial scan.

Authenticating using fingerprints

- ▶ Place and lift your finger several times on the fingerprint sensor under the touchscreen (→ page 294).
The finger is scanned. If the scanning procedure is successful, a message appears on the central display. You can unlock your user profile and protected applications with your finger print.

Authenticating using voice recognition

- ▶ Speak the sentence shown on the central display and follow the Voice Assistant's instructions.
If the voice recognition was successful, a message appears on the central display. You can unlock your user profile.
- ⓘ Avoid background or disturbing noises during voice recognition.

Deleting biometric data

- ▶ Tap on  , for example, behind **Facial Recognition**.
- ▶ Select **Yes**.

Teaching in the vehicle SmartKey for profile selection





- ▶ Select **Protect Content**.
- ▶ Select **SmartKey Recognition**.
- ▶ Have the SmartKey ready and follow the set-up assistant's prompts.
The user profile is linked to the selected SmartKey. If you open the vehicle with the SmartKey, the light, mirror and seat settings for your user profile are pre-activated. The SmartKey you are currently using for unlock-ing is used.
The SmartKey is only stored for the driver and for one user profile.

Selecting a user



- ⓘ When you call up your driver profile, the driver's seat and the steering wheel can be set.
You can cancel the setting process with the following actions:
 - Press **Tap Here to Cancel** message on the central display.
 - Press one of the seat operating buttons in the driver's door.

- ▶ Select **Change User**.
- ▶ Select a user.
- ▶ When requested to do so, authenticate with the Mercedes me PIN or a taught-in biometric characteristic.
The user profile is loaded and activated.
- ⓘ If you select **Continue Without Selecting a User**, no specific settings for the user profile are loaded.

Adding favorites from categories

- ▶ Select .
- ▶ Select .
- ▶ Select .
- ▶ Select  **Create New Favorite**.
- ▶ Select the category.
- ▶ Select a favorite.

Linking favorites with the MBUX Interior Assistant V pose

- ▶ Select .
- ▶ Select .

- ▶ Select .
- ▶ Select **Driver** or **Passenger**.
- ▶ Select the category.
- ▶ Select a favorite.

System settings

Overview of the system settings menu

In the system settings menu, you can make settings in the following menus and control elements:

- Display
 - Display brightness
 - Screensaver for the front passenger display (vehicles with MBUX Hyperscreen)
- Control elements:
 - Keyboard language and handwriting recognition
 - Sensitivity of the Touch Controls
 - Haptic operation for the touchscreen
- MBUX Voice Assistant

- MBUX Interior Assistant
- Tone
 - Entertainment
 - Navigation and traffic announcements
 - Telephone
 - Voice amplification
- Data protection
- Connectivity:
 - Wi-Fi, Bluetooth®, NFC
- MBUX rear tablet child-proof lock
- Time & date
- Language
- Units for distance
- System PIN
- Software update
- System reset

Overview of software updates

Important software updates may be necessary for the security of your multimedia system's data.

Install these updates, or else the security of your multimedia system cannot be ensured.

The multimedia system displays a corresponding message when a software update is available.

If the **Automatic Online Update** option is active, software updates are downloaded automatically. If the option is deactivated, you will be informed of new software updates once. The software updates are available for downloading for a limited period of time.

Carrying out a software update:

- You can start software updates via the communication module.
- You can start software updates via a Wi-Fi hot-spot.
- You can start map updates from an external medium.

 Online software updates cannot be performed via external Wi-Fi hotspots that are encrypted using TKIP.

- ❗ To complete software updates via the communication module, the vehicle must be connected with the Internet and a Mercedes me user account.
- ❗ To complete software updates via Wi-Fi, the vehicle must be connected to an external Wi-Fi hotspot.

A software update consists of three steps:

- Downloading or copying of the data required for installation
 - Installation of the downloaded software update
 - Activation of the downloaded software update.
- ❗ It may be necessary to restart the MBUX multimedia system after completion of a software update.
 - ❗ While some software updates are being downloaded, the multimedia system cannot be operated and the vehicle functions may be restricted.
 - ❗ Some software updates require a safe vehicle status for the installation to be completed.

They can only be carried out in a safely parked vehicle with the vehicle switched off.

For software updates requiring a safe vehicle status: when the last installation step is reached, a message appears on the central display after the vehicle is switched off. Follow the step-by-step instructions on the central display to complete the installation.

There are software updates that can only be installed when the vehicle is safely parked, there are no more people in the vehicle and the vehicle is locked.

Availability of the driver and central display

During the installation of software updates, it is not possible to use the vehicle, central display and driver display. You may receive the following display message when an installation is running:

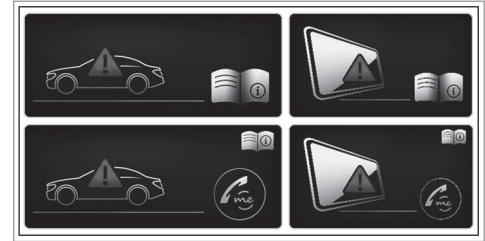

- ❗ The display message does not appear every time a software update is installed.

In rare cases, an error can occur during the installation. The multimedia system automatically attempts to restore the previous version.

If it is not possible to restore the previous version, the display message shown above appears every time the vehicle is started.

Failure of the driver display

If the driver display fails or there is a malfunction, you may not recognize limitations in the functions of systems relevant to safety or the speed display, for example. The operating safety of the vehicle may be impaired. Drive on carefully and have the

vehicle checked at a qualified specialist workshop immediately (→ page 440).

Further information about software updates can be found at <https://me.secure.mercedes-benz.com>.

Failure of the central display

If the central display fails or the display message shown above is shown continuously, several systems such as the rear view camera, PARKTRONIC or climate control are no longer available. Drive on carefully and consult a specialist workshop as soon as possible.

Front passenger display failure (only vehicles with MBUX Hyperscreen)

If the front passenger display has failed or a display message appears permanently, functions and systems are no longer available via the front passenger display. Visit a qualified specialist workshop.

Setting up a Wi-Fi hotspot

Requirements:

- The Wi-Fi function is activated on the multimedia system and the communication device to be connected.
- The communication device to be connected supports at least one of the types of connection described.

The connection types shown depend on the device to be connected. The function must be supported by the multimedia system and by the device to be connected. The type of connection established must be selected on the multimedia system and on the device to be connected.

- ① Some functions may first need to be activated on the communication device being connected. More detailed information can be found in the manufacturer's operating instructions.
- ① The use of the vehicle data tariff by external devices is not available in all countries.

Multimedia system:

→  » Settings » System
» Internet and Bluetooth

- ① The availability of the functions is dependent on the country.
- ▶ Select **Wi-Fi**.
The controller is to the right: Wi-Fi is switched on.

When the Wi-Fi function is switched on, you can connect the multimedia system with external hotspots or make it available as a hotspot for external devices.

When the Wi-Fi function is switched off, it is not possible to establish a hotspot connection.

When the Wi-Fi function is switched off, no connection can be established with the MBUX rear tablet.

- ① The data volume can be purchased **directly from a mobile phone network provider** via the Mercedes me Portal.
- ① The use of the vehicle data tariff by external devices is not available in all countries.

Using the multimedia system as a Wi-Fi hotspot

- ▶ Select **MBUX Hotspot**.
- ▶ Select one of the following connection options.

Connecting using a QR code

Requirement: an app for scanning the QR code is installed on the device being connected.

Alternatively: the device being connected has an integrated QR code scanner (see manufacturer's operating instructions).

- ▶ Scan the QR code shown.
The Wi-Fi connection is established.

Connecting using NFC

- ▶ Activate NFC on the device to be connected.
- ▶ When the NFC icon is displayed in the **MBUX Hotspot** menu, hold the device to be connected to the NFC interface.
- ▶ Follow the instructions on the device.
The Wi-Fi connection is established.

Connecting using a security key

- ▶ Select the vehicle from the device to be connected. The vehicle is displayed with the **MBUX XXXXX** network name.
- ▶ Enter the security key which is shown in the central display on the device to be connected.
- ▶ Confirm the entry.

Generating a new security key

- ▶ Select the hotspot name **MBUX XXXXX** in the **MBUX Hotspot** menu.
- ▶ Confirm the prompt with **Yes**.
A new security key is generated.

A connection will be established with the newly created security key.

- ⓘ When a new security key is generated, all existing Wi-Fi connections are then disconnected. If the Wi-Fi connections are being re-established, the new security key must be entered.

Using a mobile communication device as a Wi-Fi hotspot (tethering)

An external Wi-Fi hotspot is accessed for the Internet connection of the multimedia system. The data tariff of the mobile communication device via **Purchased Plan** is used for the data connection.

- ⓘ This function is country-dependent.
- ⓘ With external Wi-Fi hotspots, which are encrypted via TKIP, online software updates cannot be carried out via the external Wi-Fi hotspot.

- ▶ Select the **Connect to the Internet** option in the **Internet and Bluetooth** menu.

Setting up an Internet connection via Wi-Fi

- ⓘ The Wi-Fi function on the mobile phone and Internet access via Wi-Fi must be activated (see the manufacturer's operating instructions).

- ▶ Select **Search for Access**.
- ▶ Select the network.
- ▶ Log in to the Wi-Fi network.

or

- ▶ Select the mobile phone with the  Wi-Fi symbol.

System language

Notes on the system language

This function allows you to determine the language for the menu displays and the navigation announcements. The selected language affects the characters available for entry. The navigation announcements are not available in all languages. If a language is not available, the navigation announcements will be in English.

Setting the language

Multimedia system:

 ▶▶ Settings ▶▶ System
▶▶ Language

Setting the system language

A list of the available system languages is shown.

- ▶ Select a language.
The system language is switched to the selected language.

Resetting the multimedia system (reset function)

 **WARNING** Risk of accidents due to failure of the central display functions

While the multimedia system is being reset, its functions such as the rear view camera are not available.

- ▶ Only reset the multimedia system when the vehicle is stationary.

Requirements:

- The vehicle is switched on.
- Some settings can only be reset when the vehicle is stationary.

Multimedia system:

 ▶▶ Settings ▶▶ System ▶▶ Reset

When resetting the system, personal data and settings are deleted, for example:

- Connected devices
- Individual user profiles
- Biometric data

- Vehicles with rear telephony: handset connection

- ⓘ The data used and saved in the multimedia system by the driver assistance systems is deleted.
- ⓘ Vehicles with rear telephony: The handset must be in the cradle while the system is reset.

- ▶ Select **Reset**.

A query appears asking if the system should really be reset.

- ▶ Select **Yes**.

The multimedia system is reset to the factory settings. The multimedia system is restarted after the system reset.

- ⓘ Due to data protection, as well as the function of individual driving systems and driving safety systems, it is a requirement to carry out a complete system reset before selling the vehicle or transferring it to a third party, or after use as a hire car.

Drive system settings

Calling up the energy flow display

Multimedia system:



- ▶ Select **Energy Flow**.

The energy flow in the vehicle is displayed.

Navigation and traffic

Notes on navigation

Route guidance with augmented reality

- ⚠ **WARNING** Risk of accident and injury as a result of distraction, incorrect depiction or wrong interpretation of the display

The camera image of the augmented reality display is not suitable as a guide for driving.

- ▶ Always keep an eye on the actual traffic situation.
- ▶ Avoid extended observation of the camera image.

- ⚠ **WARNING** Risk of accident and injury due to imprecise positioning of additional information

The additional information from the augmented reality display may be inaccurate and is not a substitute for observing and assessing the actual driving situation.

- ▶ Always keep an eye on the actual traffic situation when carrying out all driving maneuvers.

Switching navigation on

Multimedia system:



- ▶ Alternatively, press the  button on the steering wheel on the right (→ page 303). The Zero Layer with the digital map is displayed.

Navigation overview



Digital map and user-specific applications





- 1 Navigation module (reduced view) or EQ module (reduced view)
Route guidance active:
Navigation module shows in the reduced view the information relevant to the route, e.g. the next charging stop, the destination and a traffic delay
 ends the current route guidance
Tapping opens the navigation module in the expanded view with the **Route**
Route guidance not active:

EQ module is shown in the reduced view

Tapping opens the EQ module in the expanded view with the charging functions

- ② Enters a destination
- ③ Calls up the Control Center in the status line
- ④ Current vehicle position (vehicle symbol or arrow)
- ⑤ Display area with entertainment sources, phone, active applications and suggestions
- ⑥ Searches for POIs, e.g. charging stations  and parking facilities , as well as sets map orientation and map type
- ⑦ Navigation window shows the next maneuver (zoomed out view) or the route monitor (zoomed in view)

For example, with active route guidance, route sections of the route list, displays for upcoming driving maneuvers, lane recommendations

-  Switches off navigation announcements
-  Switches on navigation announcements

The following map orientations ⑥ are available:

- 2D and to the north

- 2D and direction of travel
- 3D and direction of travel
- Map with complete route

① If the map is moved, the map switches between 3D direction of travel and 2D north orientation.

The following map types ⑥ are available:

- Daytime display
- Night-time display
- Satellite map

Navigation module (expanded view)



- ① Arrival time at charging stop, type of charging station
- ② Charging stop shows the charging time recommended by the navigation with Electric Intelligence as well as charge levels on arrival and onward journey for an optimal travel time

- ③ Distance from current vehicle position and remaining driving time
- ④ Searches for an additional charging station

EQ module (expanded view)

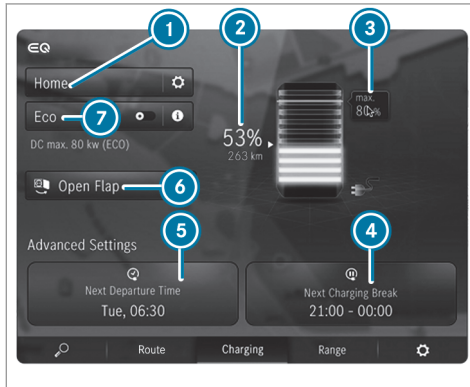

- ① Sets the charging program (→ page 209)
- ② Current condition of charge of the high-voltage battery

- ③ Maximum condition of charge (depending on the setting)
- ④ Sets the next charging break (to use a less expensive tariff)
- ⑤ Sets the departure time
- ⑥ Opens the socket flap
- ⑦ Activates or deactivates ECO charging

Overview of the toll system

Debiting of toll charges at freeway toll gates is facilitated with an electronic payment system.

The toll system uses RFID (Radio Frequency Identification) for data transfer between the control unit and the toll station.

The toll system is switched off at the factory.

The control unit is in the vehicle glove box.

To register and activate the control unit, the following steps are required:

- You activate the toll system in the settings of the MBUX multimedia system.
- In the Mercedes me app, register the unit identification number of the control unit and activate the toll system.

Registration and activation of the toll system can take up to 24 hours.

When the toll system is activated, the number of vehicle occupants is first transmitted manually and is preset with one person.

The number of vehicle occupants can be transmitted automatically. In the process, the number of seat belts worn is determined.

The toll system is operational in all states in the USA and in all provinces in Canada.

- ① In Mexico, for example, the toll system can be registered and activated for journeys to the USA.

Notices

- Drive at the prescribed vehicle speed in the toll lane.
- Only after registration and activation of the toll system will the toll be debited automatically.
- Mercedes-Benz recommends operation using the MBUX multimedia system. Alternatively, this can also be done on the control unit in the glove box.

- For safety reasons, make the entries with the vehicle stationary.
- For further information, please consult the Mercedes me app or an authorized Mercedes-Benz Center.

Or call 1-800-FOR-MERCEdes (in the USA) or 1-800-387-0100 (in Canada).

For information on how to register and activate the toll system, see the Digital Operator's Manual.

Entering a destination

Requirements:

- **For online search:** an Internet connection is established.
- Mercedes me connect is available.
- You have set up a user account in the Mercedes me Portal.
- The vehicle is connected with the user account and you have accepted the terms of use.

Further information can be found at: <https://www.mercedes.me>

- The service is available.
- The service has been activated at an authorized Mercedes-Benz Center.

Multimedia system:



- Example: entering a POI or address
- 1 Input line

- 2 Searches for a POI
- 3 Selects destination search, displays further destination searches with double arrow
- 4 Deletes the last character entered
- 5 Hides the keypad
- 6 Switches to handwriting recognition
- 7 Starts the MBUX Voice Assistant
- 8 Sets the written language
- 9 Switches to digits and special characters
- 10 Switches to upper-case or lower-case letters

▶ Enter the destination in ①. The entries can be made in any order. The search results are displayed in a list.

- Online search results for POIs may contain additional information, for example opening times and prices. The information is provided by an online map service. This online function is not available in all countries.
- You can enter a destination as a 3 word address from what3words. This option is not available in all countries.

- ▶ Hide the keyboard with **OK**.
- ▶ Select the destination in the list.
The route is calculated.
- ❶ Observe the notes on the MBUX multimedia system (→ page 294).

Calculating a route with Electric Intelligence and using settings for route guidance

Requirements:

- The destination has been entered.
- The destination address is shown.
- **For navigation with Electric Intelligence:**
 - Mercedes me connect is available.
 - You have a Mercedes me connect user account and the vehicle is connected with the account.
 - The "Navigation with Electric Intelligence" service is available and activated in the Mercedes me Portal.
The services "Navigation with Electric Intelligence", "Display of charging points" and

"Mercedes me Charge" are required for optimal function.

- The **Plan Charging Stops** route option is switched on.



Example: detailed display

- ❶ Saves as favorite (**Plan Charging Stops** is switched on)

Calls up alternative routes (**Plan Charging Stops** is switched off)

- ❷ Calculates the route and starts route guidance
- ❸ Selects a point of interest in the vicinity of the destination
- ❹ Destination information, online content (e.g. weather information), 3-word address from what3words, saves destination as favorite, shares destination

After selecting a destination, Electric Intelligence automatically and intelligently calculates the route to the destination. This is updated during route guidance. The route with Electric Intelligence contains the required charging stations as intermediate destinations. The charging stations are determined taking account of the driving distance and the estimated charging times.

- ❶ When the **Plan Charging Stops** route option is switched off, a route without charging stations is calculated.

▶ Select one of the options.

Saving a destination as a favorite

- ▶ Select  **Favorite**.
- ▶ Select an option.

Calling up the route overview

- ▶  When **Plan Charging Stops** is switched off, this option is available instead of the favorites function.
- ▶ Select **Routes**.
- ▶ Select an alternative route.

Starting route guidance

- ▶ Select  **Let's Go!**.

Calling up the detailed display with destination address

- ▶ Pull the bar above the  **Let's Go!** symbol upwards.
Depending on the destination selection and availability, online content, for example ratings, prices and weather information, is shown.

If the destination is in a different time zone, a message is displayed.

- ▶ **To share a destination:** select  **Share**.
This option allows you to scan the displayed QR code.

- ▶ **To save a destination as a favorite:** select  **Favorite** and then an option.

- ▶ **To call up an Internet address:** if a web address is available, select **www**.

- ▶ **To call the destination:** if a telephone number is available, select **Call**.

Searching for POIs in the vicinity of the destination shown

- ▶ Select **In The Vicinity**.
- ▶ Search using categories, enter a search entry or search for a personal POI .

Switching on the Electric Intelligence route option

- ▶ Select  in the navigation module (→ page 321).
- ▶ Select **Route**.
- ▶ Activate **Plan Charging Stops**.
If the route has been calculated and the state of charge of the high-voltage battery is not sufficient to reach the destination, charging

stations are set automatically as intermediate destinations.

Setting the condition of charge of the high voltage battery when the charging station and destination are reached

- ▶ Select  in the navigation module (→ page 321).
- ▶ Select **Route**.
- ▶ Select **State of Charge at Destination** or **State of Charge at Charging Stations**.
- ▶ Move the control knob to the left or right and set the preferred condition of charge in percent (%).
The destination or charging station along the route is reached with the set condition of charge.

To reach a charging station, the system uses the battery capacity, e.g. up to 10% residual energy content (condition of charge). You can increase this condition of charge on arrival at the charging station and destination, e.g. to 25% at the charging station and 50% at the destination.

i In the event of increased energy consumption while driving, e.g. with headwind, the following options are available on the system side:

- The charging station is safely reached even at charge levels of less than 10%.
- Navigation with Electric Intelligence selects a closer charging station for the route.

i If a charging facility is available at the destination, the condition of charge can be lowered below 10%. The **Min.** message appears on the central display. Make sure that the range monitor is switched on.

▶ **To select a charging station provider:** switch **Mercedes me Charge** on or off. If the option is activated, only charging stations payable with Mercedes me Charge are taken into account when selecting the charging station.

or

▶ Activate **All**. All charging stations known to the navigation system are taken into account when calculat-

ing routes with Electric Intelligence, regardless of the type of payment.

It may be necessary to register with the provider.

Switching the range monitor on or off

The activated range monitoring assists with messages on the driver and central display to ensure safe arrival at the destination.

- ▶ Select  in the navigation module (→ page 321).
- ▶ Select **Route**.
- ▶ Activate or deactivate **Range Monitor**. To reach the destination with the condition of charge set by the driver, the range is permanently monitored when the option is switched on.

i This function is not available in all countries.

Displaying a route overview with charging station



- 1 Arrival time at charging stop, type of charging station
- 2 Charging stop shows the charging time recommended by the navigation with Electric Intelligence as well as charge levels on arrival and onward journey for an optimal travel time

- ③ Distance from current vehicle position and remaining driving time
- ④ Searches for an additional charging station

You can influence the route calculated by the navigation with Electric Intelligence using options ① and ④.

- ▶ Select one of the options.

Ignoring a charging station



If you do not want to drive to the selected charging station, it can be removed for the current route guidance. The navigation with Electric Intelligence tries to plan the best possible alternative charging station for the route.

- ▶ Select ①.
The expected charging power, the dynamic condition of charge display as well as the current condition of charge and the predicted charging target are displayed, for example.
- ▶ Select **Ignore**.
- ▶ Select **Ignore during this journey**.
The charging station is removed from the current route.



- ① After selecting **Details**, the detailed information about the charging station is displayed.

Adding a charging station

If you want to drive to a charging station earlier on the route, for example, you can search for an additional charging station. If the charging station is suitable for the route, it will be accepted by the navigation with Electric Intelligence.



- ▶ Select ④.
- ▶ Select a charging station.
- ① You can also search for a charging station using the  symbol on the digital map or next to  **Where to?** .

Selecting a route type

- ▶ Select  in the navigation module (→ page 321).
- ▶ Select **Route**.
The route is calculated as a fast route with a short journey time. Trailer mode is available if a trailer has been coupled with the vehicle. If available, you can select online routes. Traffic announcements for the route are taken into account via **Reroute Based on Traffic** .

- ① Trailer mode and online routes are not available in all countries and for all vehicles.

Activating a commuter route

- ① A user profile has been created and **Allow Destination Suggestions** has been activated in the user options (→ page 313). Route guidance is not active.
- ▶ Select  in the navigation module.
- ▶ Select **Route**.
- ▶ Activate **Activate Commuter Route**.
The navigation system automatically detects that the vehicle is on a commuter route.
For the daily commuter route, traffic events on the route are also reported when driving without active route guidance.
- ▶ **To select or delete a commuter route:**
select **Start** or .

Avoiding or using route sections, e.g. highways or ferries

- ▶ Select  in the navigation module.
- ▶ Select **Route**.

- ▶ Select **Avoid Options**.
- ▶ Activate or deactivate the avoid option.

Activating route guidance with augmented reality

- ▶ Select  in the navigation module.
- ▶ Select **View**.
- ▶ Select **Augmented Reality Video**.
- ▶ Activate or deactivate **Augmented Reality Video**.
The AR camera's video image is shown on the central display before a turning maneuver. The video image includes additional information.

Showing property information for route guidance with augmented reality

Road guidance with augmented reality is activated.

- ▶ Select  in the navigation module.
- ▶ Select **View**.
- ▶ Select **Augmented Reality Video**.

- ▶ Activate **Street Names** and **House Numbers**.
During route guidance, the activated options are shown as additional information in the camera image.

Using map functions

Multimedia system:



Increasing map scale

- ▶ When the map is shown, tap twice quickly with one finger on the central display.
- or
- ▶ Move two fingers apart on the central display.

Decreasing map scale

- ▶ Tap with two fingers on the central display.
- or
- ▶ Move two fingers together on the central display.

Moving the map

- ▶ When the map is displayed, swipe in any direction with one finger on the central display.

- ▶ **To reset the map to the current vehicle position:** select  **Center**.

Selecting map orientation

- ▶ Tap repeatedly on the  compass symbol on the map.

The map orientations changes in this order:

- The 3D map view is aligned to the direction of travel.
- The 2D map view is aligned to the direction of travel.
- The 2D map view is displayed so that north is always at the top.
- The map shows the complete route.

Using services

Requirements:

- There is an Internet connection.
- Mercedes me connect is available.
- You have set up a user account in the Mercedes me Portal.

- The vehicle is connected to a user account and you have accepted the conditions of use for the service.

Further information can be found at: <https://www.mercedes.me>

- The service is available.
- The service has been activated at an authorized Mercedes-Benz Center.

Multimedia system:



Showing traffic information

- ▶ Select  in the navigation module (→ page 321).
- ▶ Select **View**.
- ▶ Select **Map Symbols**.
- ▶ Activate **Traffic Incidents** and **Free Flowing Traffic**.
Traffic incidents, for example roadworks, local area reports (e.g. fog) and warning messages, are shown on the route.

The traffic delay is displayed for the current route. The smallest value for the display for traffic delays is a minute.

Displaying hazard warnings

If hazard warnings are available these can be shown as symbols on the map. The display depends on the settings for the **Traffic Incidents** option.

- ▶ Set the option using .
If the option is activated, all of the symbols are shown.
If the option is deactivated, the symbols are only shown when there is a hazard warning.

The following hazards may be shown on the map:

- Accidents and breakdowns
- Slippery roads, fog, crosswinds and heavy rain
- Hazards reported manually
- Vehicle with active hazard warning light
- Roadworks
- Additional hazards (if available)

Displaying online map contents

- ▶ Select  in the navigation module.
- ▶ Select **View**.
- ▶ Select **Map Symbols**.
- ▶ Switch on an online service, e.g. **Weather**.
Current weather information is displayed on the navigation map, e.g. temperature or cloud cover.
The service information is not shown in all map scales, e.g. weather symbols.

Parking service

 **NOTE** Damage to the vehicle due to not observing the maximum permitted headroom clearance

If the vehicle height is greater than the maximum permitted headroom clearance, the roof and other parts of the vehicle may be damaged.

- ▶ Observe the signposted headroom clearance.

- ▶ If the vehicle height is greater than the permitted headroom clearance, do not enter.
- ▶ Observe the changed vehicle height with add-on roof equipment.



! **NOTE** Before selecting the parking option

The data is based on information provided by the respective service provider.

Mercedes Benz accepts no liability for the accuracy of the information provided relating to the parking garage/parking lot.

- ▶ Always observe the local Information and conditions.

i This service is not available in all countries.

- ▶ Select  in the navigation module and activate **Parking**.
- ▶ Tap on  in the map.
- ▶ Select a parking option.
The map shows the parking options in the vicinity.

The following information is displayed (if available):

- Destination address, distance from current vehicle position and arrival time
- Information on the parking garage/parking lot

For example, opening times, parking charges, current occupancy, maximum parking time, **maximum access height**.

The maximum access height shown by the parking service does not replace the need for observation of the actual circumstances.

- Available payment options (Mercedes pay, coins, bank notes, cards)
- Details on parking tariffs
- Number of available parking spaces
- Payment method (e.g. at the parking meter)
- Services/facilities at the parking option
- Telephone number

- ▶ Calculate the route (→ page 325).

Notes on the dashcam

! **NOTE** Before using the dashcam

You are legally responsible for operation and use of the dashcam functions. The legal requirements relating to operation and use of the dashcam can vary depending on the country in which the dashcam is operated. Therefore, observe the legal requirements, in particular the data protection regulations, in your country.

For this reason, before using the dashcam inform yourself about the regulation details for the respective country.

This function is not permitted in all countries.

- ▶ Observe the country-specific regulations.

i To ensure secure operation, only use FAT32 or exFAT formatted USB storage devices.

- ❶ The file size and therefore the duration of single recording is limited by the limitations of the USB flash drive format. So FAT32 formatted USB flash drives do not allow files larger than 4 GB, for example.

When the file size is reached, the recording stops and you receive a notification.

- ❶ The following functions are available in the Gallery app:
 - Switching write protection on or off
 - Deleting video files

Selecting a USB device for a video recording with the dashcam

Requirements:

- At least one USB device is connected with the multimedia system .

Multimedia system:

→  » Apps » Dashcam

- ▶ Select the USB symbol.
- ▶ Select the USB device.

- ❶ When USB devices contain multiple partitions, recorded video files are not always displayed in the recording list. Mercedes-Benz recommends that you use USB devices with one partition.

Starting or stopping video recording with the dashcam

Requirements:

- For recording and saving a video file: a USB device is connected with the multimedia system.
- The vehicle is switched on.

Multimedia system:

→  » Apps » Dashcam

- ▶ If several USB devices are connected with the multimedia system, select a USB device (→ page 332).
If no USB device is selected, a selection is made automatically when recording starts.

- ▶ **To select a recording mode:** select **Loop Recording** or **Individual Recording**. **Loop Recording** records several short video files. When the memory is full, recording is continued automatically. In doing so, other files will be overwritten starting with the oldest file.

Individual Recording stops recording when the memory limit is reached. An individual recording is automatically protected against being overwritten.

- ▶ **To start:** select **Start Recording**. The length of the recording is shown. The **Please do not remove the storage medium** message appears. The video file is stored on the USB device.

- ▶ **To end:** select **End Recording**.

- ❶ In some countries, geo-coordinates (longitude and latitude) are shown in the video image. For technical reasons, the geo-coordinates may show greater inaccuracies.

A report may appear in the following cases:

- **Individual Recording:** the memory is full or there are only a few minutes recording time

available. The video recording stops or will be stopped imminently.

Change the USB device or delete a video file.

- The camera is not functional, the **Camera Unavailable** message appears.
Have the camera checked at an authorized Mercedes-Benz Center.
- If the country border indication has been switched on.
- If an outdoor recording is started with the camera app during a dashcam recording, the dashcam recording pauses and resumes automatically after the camera recording is finished. A notification to this effect is displayed.

Telephone

Telephony

Notes on telephony

- ⚠ **WARNING** Risk of distraction from operating integrated communication equipment while the vehicle is in motion

If you operate communication equipment integrated in the vehicle when driving, you could be distracted from the traffic situation. This could also cause you to lose control of the vehicle.

- ▶ Only operate this equipment when the traffic situation permits.
- ▶ If you cannot be sure of this, stop the vehicle whilst paying attention to road and traffic conditions and operate the equipment with the vehicle stationary.

- ⚠ **WARNING** Risk of accident from operating mobile communication equipment while the vehicle is in motion

Mobile communication devices distract the driver from the traffic situation. This can also cause the driver to lose control of the vehicle.

- ▶ As a driver, only operate mobile communication devices when the vehicle is stationary.
- ▶ As a vehicle occupant, use mobile communication devices only in the designated area, e.g. in the rear passenger compartment.

You must observe the legal requirements for the country in which you are currently driving when operating mobile communication equipment in the vehicle.

- ⚠ **WARNING** Risk of injury due to objects being stowed incorrectly

If objects in the vehicle interior are stowed incorrectly, they can slide or be thrown around

and hit vehicle occupants. In addition, cup holders, open stowage spaces and mobile phone receptacles cannot always retain all objects within.

There is a risk of injury, particularly in the event of sudden braking or a sudden change in direction.

- ▶ Always stow objects so that they cannot be thrown around in such situations.
- ▶ Always make sure that objects do not protrude from stowage spaces, parcel nets or stowage nets.
- ▶ Close the lockable stowage spaces before starting a journey.
- ▶ Always stow and secure heavy, hard, pointed, sharp-edged, fragile or bulky objects in the trunk/cargo compartment.

Observe the additional information on stowing mobile communications devices correctly:

- Loading the vehicle (→ page 119)

Bluetooth® connection:

The menu view and the available functions in the telephone menu are in part dependent on the Bluetooth® profile of the connected mobile phone. If the mobile phone supports all the following Bluetooth® profiles, the full range of features is available:

- PBAP (Phone Book Access Profile)
 - The contacts on the mobile phone are shown automatically on the multimedia system.
- MAP (Message Access Profile)
 - The mobile phone message functions can be used on the multimedia system.
- HFP (hands-free profile)
 - Wireless telephony is available on the multimedia system.
- SAP (SIM Access Profile)
 - The car telephone has access to the SIM card data and dials into the mobile phone network via the exterior antenna.

Irrespective of this, Bluetooth® audio functionality can be used with any mobile radio unit.

For information on the range of functions of the mobile radio unit to be connected, see the manufacturer's operating instructions.

Network connection:

The following cases can lead to the call being disconnected while the vehicle is in motion:

- You switch into a transmission/reception station, in which no communication channel is free.
- The SIM card used is not compatible with the network available
- A mobile phone with "Twincard" is logged into the network with the second SIM card at the same time

The multimedia system supports calls in HD Voice® for improved speech quality. A requirement for this is that the mobile phone and the mobile phone network provider of the person you are calling support HD Voice®.

Depending on the quality of the connection, the voice quality may fluctuate.

Further information can be obtained from an authorized Mercedes-Benz Center or at: <https://www.mercedes-benz.com/connect>

Telephone menu overview

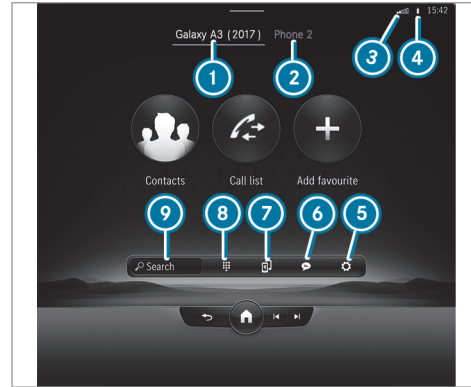

- ① Bluetooth® device name of the currently connected mobile phone/of the mobile phone
- ② Bluetooth® device name of the currently connected mobile phone/of the mobile phone (two phone mode)
- ③ Signal strength of the mobile phone network
- ④ Battery status of the connected mobile phone

- ⑤ Options
- ⑥ Messages
- ⑦ Calls up my devices
- ⑧ Numerical pad
- ⑨ Starts contact search

Telephony operating modes overview

Depending on your equipment, the following telephony operating modes are available:

- A mobile phone is connected to the multimedia system via Bluetooth®.
- Two mobile phones are connected with the multimedia system via Bluetooth® (two phone mode).
 - You can use all the functions of the multimedia system with both mobile phones.

Connecting a mobile phone

Requirements:

- Bluetooth® is activated on the mobile phone (see the manufacturer's operating instructions).

- Bluetooth® is activated on the multimedia system.

Multimedia system:

→ [Home] → Phone → [Settings] → Devices
→ My Devices

Searching for a mobile phone

- ▶ Select **Connect New Device**.

Connecting a mobile phone

- ▶ Select a mobile phone.
A code is displayed in the multimedia system and on the mobile phone.
- ▶ If both codes match, confirm the code on the mobile phone.

Functions in the telephony menu

In the telephony menu you have the following functions, for example:

- Making calls, e.g.:
 - [Phone] Accept a call
 - [End Call] **End Call**
 - Answering a call with a message

- [Conference] **Conference**
- Accepting or rejecting a waiting call
- Managing contacts, e.g.:
 - Downloading mobile phone contacts
 - Managing the format of a contact's name
 - Deleting favorites
- Receiving and sending messages, e.g.:
 - Using the read-aloud function
 - Dictating a new message

Mercedes me app

Mercedes me calls

Making a call via the overhead control panel

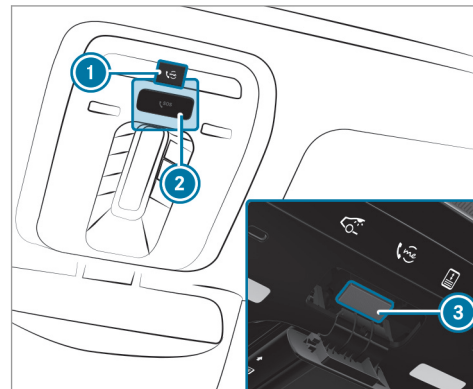

- ① me button for service or information calls
- ② SOS button cover
- ③ SOS button (emergency call system)

Making a Mercedes me call

- ▶ Press me button ①.

Making an emergency call

- ▶ To open the cover of SOS button ②, press it briefly.
- ▶ Press and hold SOS button ③ for at least one second.

If a Mercedes me call is active, an emergency call can still be triggered. This has priority over all other active calls.

Information about the Mercedes me call using the me button

A call to the Mercedes-Benz Customer Center has been initiated via the me button in the overhead control panel or the multimedia system (→ page 336).

Using the voice dialog system you access the desired service:

- Accident and Breakdown Management
- Mercedes-Benz Customer Center for general information about the vehicle

You can find information on the following topics:

- Activation of Mercedes me connect
- Operating the vehicle
- Nearest authorized Mercedes-Benz Center
- Other products and services from Mercedes-Benz

Data is transferred during the connection to the Mercedes-Benz Customer Center (→ page 338).

Calling the Mercedes-Benz customer center using the multimedia system

Requirements:

- Access to a GSM network is available.
- The contract partner's GSM network coverage is available in the respective region.
- The vehicle must be switched on so that vehicle data can be transferred automatically.

Multimedia system:



- ▶ Call Mercedes me connect.

After confirmation, the multimedia system sends the required vehicle data. The data transfer is shown on the central display.

Then, you can select a service and be connected to a specialist at the Mercedes-Benz customer center.

Calling the Mercedes-Benz Customer Center after automatic accident or breakdown detection

Requirements:

- The vehicle has detected an accident or breakdown situation.
- The vehicle is stationary.
- The hazard warning lights are switched on.

ⓘ This function is not available in all countries. The vehicle can detect accident or breakdown situations under certain circumstances.

In the event an accident or breakdown is detected, the emergency guide shows safety notes in the multimedia system display.

After quitting the emergency guide display on the multimedia system, a prompt appears asking whether you would like to get support from the Mercedes-Benz Customer Center.

▶ Select **Call**.

- After your agreement, or if the Mercedes me connect service "Accident and Breakdown Management" is active, the vehicle data is transferred automatically (→ page 340).
- The Mercedes-Benz Customer Center takes your call and organizes the breakdown and accident assistance.

You may be charged for these services.

- ⓘ Depending on the severity of the accident, an automatic emergency call can be initiated. This has priority over all other active calls.
- ⓘ In addition, if the Mercedes me connect service "Telediagnosics" is active, a similar prompt can appear after a delay in the event

of a breakdown. If you are already in contact with the Mercedes-Benz Customer Center or have already received support, this prompt can be ignored or declined.

- ⓘ If you answer the prompt for support from the Mercedes-Benz Customer Center with **Call Later**, the message will be hidden and appear again later. The prompt triggered by the Mercedes me connect service "Telediagnosics", can either be confirmed or declined. After being declined, this will not be shown again.

Arranging a service appointment via a Mercedes me call

If you have activated the maintenance management service, relevant vehicle data is transferred automatically to the Mercedes-Benz Customer Center. You will then receive individual recommendations regarding the maintenance of your vehicle.

Regardless of whether you have consented to the maintenance management service, the multimedia system reminds you after a certain amount of

time that a service is due. A prompt appears asking if you would like to make an appointment.

- ▶ **To arrange a service appointment:** select **Call**. After your agreement, the vehicle data is transferred and the Mercedes-Benz customer center takes your preferred appointment date. The information is then sent to your desired service outlet.

This will contact you to confirm the appointment and if necessary consult about the details.

- ⓘ If you select **Call Later** after the service message appears, the message is hidden and reappears at a later time.

Transferred data during a Mercedes me call

If you initiate a service call using Mercedes me, data is transferred to enable targeted advice and an efficient service.

The following requirements must be fulfilled for the transfer of the data:

- The vehicle is switched on.
- The required data transfer technology is supported by the mobile phone network provider.

- The quality of the mobile connection is sufficient.

Multi-stage transfer depends on the following factors:

- Reason for the initiation of the call
- The available mobile phone transmission technology.
- The activated Mercedes me connect services.
- The service selected in the voice control system.

Data transfer if Mercedes me connect services are not activated

If no Mercedes me connect services are activated, the following data is transferred:

- Vehicle identification number
- Time of the call
- Reason for the initiation of the call
- Confirmation of the data protection prompt
- Country indicator of the vehicle
- Set language for the multimedia system

- Telephone number of the communication platform installed in the vehicle

If a call is made for a service appointment via the service reminder, the following data is also transmitted:

- Current mileage and maintenance data

If a call is made after automatic accident or breakdown detection using the multimedia system, the following data is also transmitted:

- Current mileage and maintenance data
- Current vehicle location

If Accident and Breakdown Management is called via the voice control system, the following data can also be called up from the vehicle by the Mercedes-Benz customer center:

- Current vehicle location

Data processing

The data transmitted within the scope of the call is deleted from the processing system after the call is finished, in so far as this data is not being used for other activated Mercedes me connect services.

The incident-specific data is processed and stored in the Mercedes-Benz customer center and, if required to process the incident, forwarded to the service partner authorized by the Mercedes-Benz customer center. Please take note of the data protection information on the Mercedes me Internet page <https://www.mercedes.me> or in the recorded message immediately after calling the Mercedes-Benz customer center.

- ① The recorded message is not available in every country.

Mercedes me connect

Information on Mercedes me connect

Mercedes me connect consists of multiple services.

You can use the following services via the multimedia system and the overhead control panel, for example:

- Accident and Breakdown Management (me button or situation-dependent display in the multimedia system)

- Mercedes-Benz emergency call system (automatic emergency call and SOS button)

The Mercedes me connect Accident and Breakdown Management and the Mercedes-Benz emergency call center are available to you around the clock.

The me button and the SOS button can be found on the vehicle's overhead control panel (→ page 336).

You can also call the Mercedes-Benz Customer Center using the multimedia system (→ page 337).

Please note that Mercedes me connect is a Mercedes-Benz service. In emergencies, first call the national emergency services using the standard national emergency service telephone numbers. In emergencies, you can also use the Mercedes-Benz emergency call system (→ page 343).

Please note the Mercedes me connect terms of use and the data protection information for Mercedes me connect. You can find these in your Mercedes me user account.

Further information about Mercedes me connect services can be obtained in the Mercedes me Portal: <https://me.secure.mercedes-benz.com>

Information on Mercedes me connect Accident and Breakdown Management

The Accident and Breakdown Management can include the following functions:

- Supplement to the Mercedes-Benz emergency call system (→ page 343)

If necessary, the contact person at the Mercedes-Benz emergency call center forwards the call to Mercedes me connect Accident and Breakdown Management. Forwarding the call is however not possible in all countries.

- Breakdown assistance by a technician on location and/or the towing away of the vehicle to the nearest authorized Mercedes-Benz Center

You may be charged for these services.

- Addition to the emergency guide after automatic accident or breakdown detection (→ page 337)

In the event of a breakdown or accident, further vehicle data is sent which enables optimal support by the Mercedes-Benz Customer Center and the authorized service partner or breakdown assistance.

- Addition to the Mercedes me connect service Telediagnosics

With the Telediagnosics function, specific wear and failure reports are recorded by the service provider, in so far as these can be clearly interpreted and are available through the monitoring of components that are subject to diagnostics.

If your vehicle detects a breakdown or threat of a breakdown, you may be prompted via the multimedia system to contact the Mercedes-Benz Customer Center for further help. This prompt in the multimedia system only appears when the vehicle is stationary.

- ⓘ These services are subject to technical restrictions such as the mobile phone coverage, mobile network quality and the ability of the processing systems to interpret the transferred data. In some circumstances, this can result in delays or the failure of the information to appear in the multimedia system.

More information about Mercedes me connect services can be obtained in the Mercedes me Portal: <https://me.secure.mercedes-benz.com>

Data transferred during Mercedes me connect call services

The data transferred during a Mercedes me connect call depends on:

- The reason for initiation of the call
- The service that is selected in the voice control system
- The activated Mercedes me connect services

You can find out which data is transferred when using the services in the currently valid Mercedes me connect terms of use and the data protection information for Mercedes me connect. You can find these in your Mercedes me user account.

Overview of the Mercedes me & Apps menu

When you log in with a user account to the Mercedes me Portal, then services and offers from Mercedes-Benz will be available to you.

For more information consult an authorized Mercedes-Benz Center or visit the Mercedes me portal: <https://me.secure.mercedes-benz.com>

- ⓘ Make sure you always keep the Mercedes me apps updated.

You can call up the menu using **Apps** in the multimedia system.

In the **Apps** menu, the following options can be available:

- Connecting the vehicle with the **Mercedes me** user account
- Deleting a connection between a **Mercedes me** user account and the vehicle
- Calling up the Mercedes me services
- Calling up apps such as, In-Car Office or the web browser depending on availability

Web browser overview

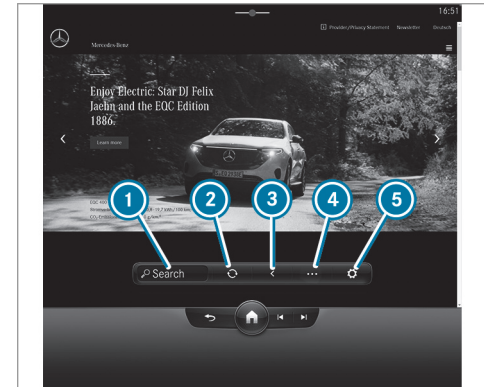

- 1 Search
- 2 To refresh/stop
- 3 Previous website
- 4 Options
- 5 Settings

① Under  you have the following options:

- [Bookmarks](#)
- [Browser History](#)
- [Request Mobile Website](#)
- [Entered URLs](#)
- [Tabs](#)

① Websites cannot be shown while the vehicle is in motion.

Overview of smartphone integration

With Smartphone Integration, you can use certain functions on your mobile phone via the multimedia system display.

Only one mobile phone at a time can be connected via Smartphone Integration to the multimedia system. Also for use with two phone mode with smartphone integration, only one additional mobile phone can be connected using Bluetooth® with the multimedia system.

The full range of functions for Smartphone Integration is only possible with an Internet connection. The appropriate application must be down-

loaded on the mobile phone to use Smartphone Integration. The mobile phone must be switched on and connected to the multimedia system via the USB port using a suitable cable.

Apps for Smartphone Integration:

- Apple CarPlay® (wireless connection via Bluetooth® also possible)
- Android Auto (wireless connection via Bluetooth® also possible)

① For safety reasons, the first activation of Apple CarPlay® or Android Auto on the multimedia system must be carried out when the vehicle is stationary with the parking brake.

You can start Smartphone Integration using the [My Devices](#) menu.

You can end Smartphone Integration via the [My Devices](#) or by disconnecting the connecting cable between the mobile phone and multimedia system.

① Mercedes-Benz recommends disconnecting the connection via the device manager or the connecting cable only when the vehicle is stationary.

Overview of transferred vehicle data

When using Smartphone Integration, certain vehicle data is transferred to the mobile phone. This enables you to get the best out of selected mobile phone services. Vehicle data is not directly accessible.

The following system information is transmitted:

- Software release of the multimedia system
- System ID (anonymized)

The transfer of this data is used to optimize communication between the vehicle and the mobile phone.

To do this, and to assign several vehicles to the mobile phone, a vehicle identifier is randomly generated.

This has no connection to the vehicle identification number (VIN) and is deleted when the multimedia system is reset (→ page 320).

The following driving status data is transmitted:

- Transmission position engaged
- Distinction between parked, standstill, rolling and driving

- Day/night mode of the instrument cluster
- Drive type

The transfer of this data is used to alter how content is displayed to correspond to the driving situation.

The following position data is transmitted:

- Coordinates
- Speed
- Compass direction
- Acceleration direction

The mobile phone uses this data to improve the accuracy of navigation, for example, when driving through a tunnel.

Mercedes-Benz emergency call system

Information on the Mercedes-Benz emergency call system

Your vehicle is equipped with the Mercedes-Benz emergency call system (“eCall”). This feature can help save lives in the event of an accident. eCall

in no way replaces assistance provided from dialing 911.

Mercedes-Benz eCall only functions in areas where mobile phone coverage is available from the wireless service providers. Insufficient network coverage from the wireless service providers may result in an emergency call not being transmitted.

eCall is a standard feature in your Mercedes-Benz vehicle. In order to function as intended, the system relies on the transmission of data detailed in the Transmitted Data section that follows.

To disable eCall, a customer must visit an authorized Mercedes-Benz Service department to deactivate the vehicle’s communication module.

Deactivation of this module prevents the activation of any and all Mercedes me connect services. After the deactivation of eCall, automatic emergency call and manual emergency call will not be available.

The vehicle must be switched on before an automatic emergency call can be made.

- ⓘ eCall is activated at the factory.

- ⓘ eCall can be deactivated by an authorized Mercedes-Benz dealer. Please note that in the event ownership of the vehicle is transferred to another owner in its deactivated state, eCall will remain deactivated unless the new owner visits an authorized Mercedes-Benz dealership to reactivate the system.

Overview of the Mercedes-Benz emergency call system

eCall can help to reduce the time between an accident and the arrival of emergency services at the site of the accident. It helps locate an accident site in places that are difficult to access. However, even if a vehicle is equipped with eCall, this does not mean the system is ON. As such, eCall does not replace dialing 911 in the event of an accident.

An emergency call can be made automatically or manually.

Only make emergency calls if you or others are in need of rescue. Do not make an emergency call in the event of a breakdown or a similar situation.

Triggering an automatic Mercedes-Benz emergency call

Requirements:

- The vehicle is switched on.
- The starter battery is sufficiently charged.

The Mercedes-Benz emergency call system triggers an emergency call automatically in the following cases:

- After activation of the restraint systems such as airbags or Emergency Tensioning Devices after an accident
- After an automatically initiated emergency stop by Active Emergency Stop Assist

The emergency call has been made:

- A voice connection is made to the Mercedes-Benz emergency call center.
- A message with accident data is transmitted to the Mercedes-Benz emergency call center.

The Mercedes-Benz emergency call center can transmit the vehicle position data to one of the emergency call centers.

The SOS button in the overhead control panel flashes until the emergency call is finished.

It is not possible to immediately end an automatic emergency call.

If no connection can be made to the emergency services either, a corresponding message appears in the media display.

- ▶ Dial the local emergency number on your mobile phone.

If an emergency call has been initiated:

- Remain in the vehicle if the road and traffic conditions permit you to do so until a voice connection is established with the emergency call center operator.
- Based on the call, the operator decides whether it is necessary to call rescue teams and/or the police to the accident site.
- If no vehicle occupant answers, an ambulance is sent to the vehicle immediately.

Triggering a manual Mercedes-Benz emergency call

- ▶ **To use the SOS button in the overhead control panel:** press the SOS button at least one second long (→ page 336).

or

- ▶ **To use voice control:** use the voice commands of the MBUX Voice Assistant.

The emergency call has been made:

- A voice connection is made to the Mercedes-Benz emergency call center.
- A message with accident data is transmitted to the Mercedes-Benz emergency call center.
The Mercedes-Benz emergency call center can transmit the vehicle position data to one of the emergency call centers.
- Remain in the vehicle if the road and traffic conditions permit you to do so until a voice connection is established with the emergency call center operator.
- Based on the call, the operator decides whether it is necessary to call rescue teams and/or the police to the accident site.

If no connection can be made to the emergency services, a corresponding message appears in the central display.

- ▶ Dial the local emergency number on your mobile phone.

Ending an unintentionally triggered manual Mercedes-Benz emergency call

- ▶ Select <schar> on the multifunction steering wheel. Depress button for several seconds.

Data transfer of the Mercedes-Benz emergency call system

In the event of an automatic or manual emergency call the following data is transmitted, for example:

- Vehicle's GPS position data
- GPS position data on the route (a few hundred meters before the incident)
- Direction of travel
- Vehicle identification number
- Vehicle drive type
- Number of people determined to be in the vehicle

- Whether Mercedes me connect is available or not
- Whether the emergency call was initiated manually or automatically
- Time of the accident
- Language setting on the multimedia system

Data transmitted is vehicle information. For any questions about the collection, use and sharing of the eCall system data, please contact MBUSA's Customer Assistance Center at 800-FOR-MERC.

For Canada, please contact MBC's Customer Assistance Center at 1-800-387-0100.









Customer requests for covered information should be submitted via the same channels.





For accident clarification purposes, the following measures can be taken up to an hour after the emergency call has been initiated:

- The current vehicle position can be determined.
- A voice connection to the vehicle occupants can be established.

Radio & media

Overview of the symbols and functions in the media menu







Symbol	Designation	Function
	Play	Select to start or continue playback.
	Rest	Select to pause the playback.
	Repeat a track	Select to repeat the current track or the active playlist. <ul style="list-style-type: none"> • Select once: the active playlist is repeated. • Select twice: the current track is repeated. • Select three times: the function is deactivated.
	Random playback	Select to play back the tracks in random order.
	Skip forwards/back	Select to skip to the next or to the previous track.
	Additional options	Select to show additional options.
	Categories	Select to show or search through available categories (e.g. playback lists, albums, artists, etc.).
	Search	Select to search in the active menu. You can search for artists, genres or moods, for example.

Symbol	Designation	Function
	Settings	Select to make settings.
	Home	Select to return to the home screen.
	Messaging	Select to call up messaging.
	Full screen	Select to switch to full screen mode.

The following functions and settings are available in the media menu:





- Connecting external data storage media with the multimedia system (e.g. using USB or Bluetooth®)
- Playing back audio or video files

Overview of the symbols and functions in the radio menu

Symbol	Designation	Function
	Home	Select to return to the home screen.
	Messaging	Select to call up messaging.
	Skip forwards/back	Select to skip to the next or to the previous station.
	Settings	Select to have further options shown. The setting options are country-dependent.
HD	HD radio®	Select to switch the HD Radio® function on or off. This function is not available in all countries.
	Station list	Select to have the station list shown.
	Search	Select to search in the active menu. You can search for artists, genres or moods, for example.

Additional functions of TuneIn Radio

-  A relatively large volume of data can be transmitted when using TuneIn Radio.

Symbol	Designation	Function
	Settings	The following additional settings are available in the TuneIn Radio menu: <ul style="list-style-type: none"> • Selecting stream • Logging on to or out of the TuneIn account
	Favourites	Select during playback to save the station currently set as a favorite.
	Play/Pause	Select to start, stop or continue playback.
	Browse	Select to choose a category and then a radio station.

Additional functions of the satellite radio

SIRIUS XM[®] satellite radio offers more than 175 digital-quality radio channels providing 100% commercial-free music, sports, news and entertainment, for example. SIRIUS XM[®] satellite radio employs a fleet of high-performance satellites to

broadcast around the clock throughout the USA and Canada. The satellite radio program is available for a monthly fee. Information about this can be obtained from a Sirius XM[®] Service Center and at <https://www.siriusxm.com> (USA) or <https://www.siriusxm.ca> (Canada).

 Sirius, XM and all related marks and logos are trademarks of Sirius XM Radio Inc. and its subsidiaries. All other marks, channel names and logos are the property of their respective owners. All rights reserved.

Symbol	Designation	Function
	Settings	The following additional settings are available in the satellite radio menu: <ul style="list-style-type: none"> • Activate child safety lock to lock channels with adult content • Set alarm programming for music and sport alerts • Create TuneMix lists to listen to music seamlessly
	Play	Select to start or continue playback.
	Rest	Select to pause the playback.

Depending on the frequency band selected, different functions are available to you.

Select the desired frequency band in the radio menu head runner.

Calling up TuneIn Radio

Requirements:

- There is a user account at <https://www.mercedes.me>.
- The vehicle is linked to the Mercedes me user account.
- The TuneIn Radio service is activated in the Mercedes me portal.

- The data volume is available.
Depending on the country, data volume may need to be purchased.
- A fast Internet connection for data transmission free of interference.

 Data volume can be purchased **directly from a mobile phone network provider** via the Mercedes me Portal.

- ⓘ The functions and services are country-dependent. For more information, consult an authorized Mercedes-Benz Center.

Multimedia system:

↳  » Radio

- ▶ Select **TuneIn Radio**.
The TuneIn menu appears. The last station set starts playing.
- ⓘ The connection quality depends on the local mobile phone reception.

Setting up satellite radio

Requirements:

- Satellite radio equipment is available.
- Registration with a satellite radio provider has been completed.
- If registration is not included when purchasing the system, your credit card details will be required to activate your account.

Multimedia system:

↳  »  Radio » SiriusXM
» 

- ▶ Select **Service Information**.
The service information screen appears showing the radio ID and the current subscription status.
- ▶ Establish a telephone connection.
- ▶ Follow the service staff's instructions.
The activation process may take up to ten minutes.
- ⓘ You can also have the satellite service activated online. To do so, please visit <https://www.siriusxm.com> (USA) or <https://www.siriusxm.ca> (Canada).

Music and sport alerts

Multimedia system:

↳  »  Radio » SiriusXM
»  » Alerts

Setting music and sport alerts

This function enables you to program an alert for your favorite artists, tracks or sporting events. Music alerts can be saved whilst a track is being played and sport alerts can be saved during a live game. You can also specify sport alerts via the menu option. The system then continuously searches through all the channels.

- ▶ Set a music or sports alert, to be informed of matches in the live program.

Activating messages for a category

- ▶ Select a category and activate .

Adding messages for a category

- ▶ Select a category and add a message .
- ▶ Select **Artist Alerts** or **Song Alerts** in the dialog window.
The message is set for the activated track and artist. If a match is found, a prompt

appears asking whether you wish to change to the station.

Deleting messages in a category

▶ Select a category, mark the desired messages and delete .

or

▶ Do not mark any messages and delete all entries .

Sound settings

Overview of functions in the sound menu

The setting options and functions available depend on the sound system installed. You can find out which sound system is installed in your vehicle in the Digital Operator's Manual.

Standard sound system

The following functions are available:

- Equalizer:
 - Treble, mid-range and bass
- Balance and fader
- Volume:

- Automatic adjustment

Burmester® surround sound system and Burmester® high-end 3D surround sound system

The following functions are available:

- Equalizer:
 - Treble, mid-range and bass
- Balance and fader
- Sound focus
- VIP seat (Burmester® high-end 3D surround sound system only)
- Sound profiles
- Volume:
 - Automatic adjustment

ASSYST PLUS service interval display

Function of the ASSYST PLUS service interval display

The ASSYST PLUS service interval display on the driver display informs you of the next regular service due date.

Depending on the operating conditions of the vehicle, the remaining time or distance until the next service due date will be displayed.

You can hide this service display using the  back button on the left-hand side of the steering wheel.

You can obtain information concerning the servicing of your vehicle from a qualified specialist workshop, e.g. an authorized Mercedes-Benz Center.

Displaying the service due date

Driver display:



The next service due date is displayed.

▶ **To exit the display:** press the back button  on the left-hand side of the steering wheel.

Bear in mind the following related topic:

- Operating the driver display (→ page 287).

Information on regular maintenance work

! **NOTE** Premature wear through failure to observe service due dates

Maintenance work which is not carried out at the right time or incompletely can lead to increased wear and damage to the vehicle.

- ▶ Adhere to the prescribed service intervals.
- ▶ Always have the prescribed maintenance work carried out at a qualified specialist workshop.

! **NOTE** Irreparable damage to the high-voltage battery due to maintenance work not being carried out

The high-voltage battery is subject to wear. Maintenance work which is not carried out in time can lead to irreparable damage to the high-voltage battery.

- ▶ Always observe the warning messages about the high-voltage battery and immediately consult a qualified specialist workshop.
- ▶ Have the necessary maintenance work on the high-voltage battery carried out at a qualified specialist workshop.

Notes on special service requirements

The prescribed service interval is based on normal operation of the vehicle. Maintenance work will need to be performed more often than specified if the vehicle is operated under arduous conditions or increased loads. This is the case for frequent operation in mountainous terrain or on poor road surfaces, for example.

In these or similar operating conditions, have the interior air filter changed more frequently. The tires must be checked more frequently if the vehicle is operated under increased loads. Further information can be obtained at a qualified specialist workshop.

The ASSYST PLUS service interval display is only an aid. The driver of the vehicle bears responsibility as regards to whether maintenance work needs to be performed more often than specified based on the actual operating conditions and/or loads.

Battery disconnection periods

The ASSYST PLUS service interval display can calculate the service due date only when the battery is connected.

- ▶ Display and note down the service due date on the driver display before disconnecting the battery (→ page 353).

Engine compartment

Notes on the hood

Only the specialist personnel of a qualified specialist workshop should open the hood. Access by the customer is not permitted.

To open the hood, consult a qualified specialist workshop.

⚠ WARNING Risk of accident due to driving with the hood unlocked

The hood may open and block your view.

- ▶ Never release the hood when driving.
- ▶ Before every trip, ensure that the hood is locked.

⚠ WARNING Risk of accident and injury when opening and closing the hood

The hood may suddenly drop into the end position.

There is a risk of injury for anyone in the hood's range of movement.

- ▶ Do not open or close the hood if there is a person in the hood's range of movement.

⚠ WARNING Risk of injury due to overheated vehicle

If you open the hood in the event of an overheated vehicle or fire in the engine compartment, the following situations may occur:

- You may come into contact with hot gases.
- You may come into contact with other escaping hot operating fluids.
- ▶ In the event of overheating or fire in the engine compartment, keep the hood closed and call the fire service.
- ▶ Allow the overheated vehicle to cool down first if you need to open the hood.

⚠ WARNING Risk of injury due to moving parts

Components in the engine compartment may continue to run or start unexpectedly even when the drive system is switched off.

Observe the following if you must open the hood:

- ▶ Switch off the vehicle.
- ▶ Never touch the danger zones surrounding moving components, e.g. the rotation area of the fan.
- ▶ Remove jewellery and watches.
- ▶ Keep items of clothing and hair away from moving parts.

⚠ WARNING Risk of injury from using the windshield wipers when the hood is open

If the windshield wipers start moving when the hood is open, you could be trapped by the wiper linkage.

- ▶ Always switch off the windshield wipers and the vehicle first if you need to open the hood.

Notes on the coolant level

Checking or refilling coolant should be carried out only by the trained personnel of a qualified specialist workshop. Access by the customer is not permitted.

To check or refill coolant, use a qualified specialist workshop.

⚠ WARNING Risk of scalding from hot coolant

If you open the cap when the drive system is at operating temperature, you may scald yourself.

- ▶ Allow the vehicle to cool before opening the cap.
- ▶ When opening the cap, wear protective gloves and protective eyewear.

- ▶ To release the pressure, slowly open the cap.

Keeping the air-water duct free

- ▶ Keep the area between the hood and the windshield free of deposits, e.g. ice, snow and leaves.

Adding washer fluid to the windshield washer system

⚠ WARNING Risk of fire and injury from windshield washer concentrate

Windshield washer concentrate is highly flammable.

- ▶ Avoid fire, open flames, smoking and the creation of sparks when using windshield washer concentrate.

Requirements:

- The vehicle is unlocked.

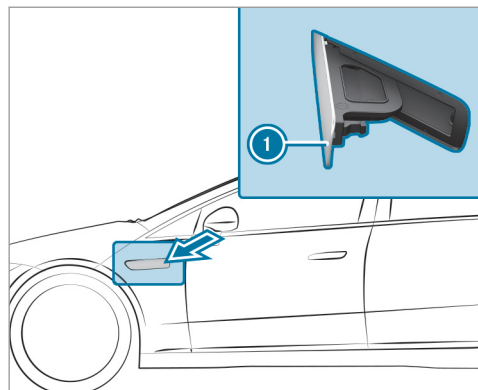

- ▶ Press on the back area of washer fluid flap ①.
- ▶ Washer fluid flap ① will open.
- ▶ Add washer fluid.
- ▶ Washer fluid flap ① will close.
- ① Further information about the windshield washer fluid (→ page 416)

Cleaning and care

Notes on washing the vehicle in a car wash

⚠ WARNING Risk of accident due to reduced braking effect after washing the vehicle

The braking effect is reduced after washing the vehicle.

- ▶ After the vehicle has been washed, brake carefully while paying attention to the traffic conditions until the braking effect has been fully restored.

! NOTE Damage from automatic braking

If one of the following functions is switched on, the vehicle brakes automatically in certain situations:

- Active Brake Assist
- Active Distance Assist DISTRONIC
- HOLD function
- Active Parking Assist

To avoid damage to the vehicle, deactivate these systems in the following or similar situations:

- ▶ During towing
- ▶ In a car wash

! NOTE Damage due to unsuitable car wash

- ▶ Before driving into a car wash make sure that the car wash is suitable for the vehicle dimensions.
- ▶ Ensure there is sufficient ground clearance between the underbody and the guide rails of the car wash.
- ▶ Ensure that the clearance width of the car wash, in particular the width of the guide rails, is sufficient.

To avoid damage to your vehicle when using a car wash, ensure the following beforehand:

- Active Distance Assist DISTRONIC is deactivated.
- The HOLD function is switched off.

- The surround view camera or the rear view camera is switched off.
- The vehicle is locked and the door handles retracted.
- The side windows and sliding sunroof are completely closed.
- The blower for the ventilation and heating is switched off.
- The windshield wiper switch is in position **0**.
- The SmartKey is at a minimum distance of 20 ft (6 m) away from the vehicle. Otherwise the tailgate or a door could open unintentionally.
- For car washes with a conveyor system:
 - Neutral **N** is engaged.
 - The vehicle is locked from inside.
- Do not make any hand movements in the area of the overhead control panel or deactivate (→ page 316) the **Sliding Sunroof and Roller Sunblind** option in the settings for the MBUX interior assistant.

- ⓘ If, after the car wash, you remove the wax from the windshield and wiper rubbers, this will prevent smearing and reduce wiper noise.

Notes on using a power washer

⚠ WARNING Risk of an accident when using power washers with round-spray nozzles

The water jet can cause externally invisible damage.

Components damaged in this way may unexpectedly fail.

- ▶ Do not use a power washer with round-spray nozzles.
- ▶ Have damaged tires or chassis parts replaced immediately.

To avoid damage to your vehicle, observe the following when using a power washer:

- The SmartKey is at a minimum distance of 10 ft (3 m) away from the vehicle. Otherwise, the tailgate or a door could open unintentionally.

- Maintain a distance of at least 11.8 in (30 cm) to the vehicle.
- **Vehicles with decorative foil:** Parts of your vehicle are covered with a decorative foil. Maintain a distance of at least 27.6 in (70 cm) between the foil-covered parts of the vehicle and the nozzle of the power washer. Move the power washer nozzle around whilst cleaning. The water temperature of the power washer must not exceed 140°F (60°C).
- Observe the information on the correct distance in the equipment manufacturer's operating instructions.
- Do not direct the nozzle of the power washer directly at sensitive parts, such as tires, gaps, electrical components, batteries, light sources and ventilation slits.

Washing the vehicle by hand

Observe the legal requirements, e.g. in a number of countries, washing by hand is only permitted in specially designated wash bays.

- ▶ Use a mild cleaning agent, e.g. car shampoo.

- ▶ Wash the vehicle with lukewarm water using a soft car sponge. When doing so, do not expose the vehicle to direct sunlight.
- ▶ Carefully hose the vehicle off with water and dry using a chamois.
- ① Observe the notes on the care of vehicle parts (→ page 359).

Notes on paintwork/matte finish paintwork care

To avoid damaging the paintwork and interfering with the driving assistance systems, please observe the following notes:

Paint

- Insect remains: soak with insect remover and rinse off the treated areas afterwards.
- Bird droppings: soak with water and rinse off afterwards.
- Tree resin, oils, fuels and greases: remove by rubbing gently with a cloth soaked in petroleum ether or lighter fluid.
- Coolant and brake fluid: remove with a damp cloth and clean water.

- Tar stains: use tar remover.
- Wax: use silicone remover.
- Do not attach stickers, films or similar materials. Only have film attached to the bumper at a qualified specialist workshop.
- Remove dirt immediately, where possible.

Matte finish

- Only use care products approved for Mercedes-Benz.
- Do not attach stickers, films or similar materials. Only have film attached to the bumper at a qualified specialist workshop.
- Do not polish the vehicle and alloy wheels.
- Only use car washes that correspond to the latest engineering standards.
- Do not use car wash program with a final hot wax treatment.
- Do not use paint cleaners, buffing or polishing products, gloss preservers, e.g. wax.

In the event of paintwork damage:

- Always have paintwork repairs carried out at a qualified specialist workshop.

- Make sure the radar sensors function (→ page 217).

Notes on cleaning decorative foils

Observe the notes on matte finish care in the chapter "Notes on paintwork/matte finish paintwork care" (→ page 358). They also apply to matte decorative foils.

Observe the notes on cleaning decorative foils to avoid vehicle damage.

Cleaning

- For cleaning, use plenty of water and a mild cleaning agent without additives or abrasive substances, e.g. a car shampoo approved for Mercedes-Benz.
- Remove dirt immediately, where possible, whilst avoiding rubbing too hard. There is otherwise a risk of damaging the decorative foil irreparably.
- If there is dirt on the finish or if the decorative foil is dull: Use the Paint Cleaner recommended and approved for Mercedes-Benz.

- Insect remains: Soak with insect remover and rinse off the treated areas afterwards.
- Bird droppings: Soak with water and rinse off afterwards.
- To prevent water stains, dry a foil-wrapped vehicle with a soft, absorbent cloth after every car wash.

Avoiding damage to the decorative foil

- The service life and color of decorative foils are impaired by:
 - Sunlight
 - Temperature, e.g. hot air blower
 - Weather conditions
 - Stone chippings and dirt
 - Chemical cleaning agents
 - Oily products
- Do not use polish on matte decorative foil. Polishing will have the effect of shining the foil-wrapped surface.
- Do not treat matte or structured decorative foils with wax. Permanent stains may occur.

Scratches, corrosive deposits, areas affected by corrosion and damage caused by incorrect care cannot always be completely repaired. In such cases, visit a qualified specialist workshop.

You can obtain more information on care and cleaning products from the manufacturer.

In the case of foil-wrapped surfaces, optical differences may occur between the surfaces that were not protected by a decorative foil after removing a decorative foil.

- ① Have work or repairs to decorative foils carried out at a qualified specialist workshop, e.g. in an authorized Mercedes-Benz Center.

Notes on care of vehicle parts

⚠ WARNING Risk of entrapment if the windshield wipers are switched on while the windshield is being cleaned

If the windshield wipers are set in motion while you are cleaning the windshield or wiper blades, you can be trapped by the wiper arm.

- ▶ Always switch off the windshield wipers and the drive system before cleaning the windshield or wiper blades.

To avoid damage to the vehicle, observe the notes on cleaning and care of the following vehicle parts:

Wheels and rims

- Use water and acid-free alloy wheel cleaners.
- Do not use acidic alloy wheel cleaners to remove brake dust. This could damage wheel bolts and brake components.
- To avoid corrosion of the brake discs and brakepads, drive the vehicle for a few minutes after cleaning before parking it. The brake discs and brakepads warm up and dry out.

Windows

- Clean the windows inside and outside with a damp cloth and with a cleaning agent recommended for Mercedes-Benz.
- Do not use dry cloths or abrasive or solvent-based cleaning agents to clean the inside of windows.

- ① After changing the wiper blades or treating the vehicle with wax, clean the windshield thoroughly with cleaning agents recommended for Mercedes-Benz. Failure to observe the application instructions may result in damage, smear marks or blinding spots.
- ① Remove external fogging or dirt on the windshield in front of the multifunction camera. Otherwise, driving systems and driving safety systems may be impaired or not available (→ page 217).

Wiper blades

- Move the wiper arms into the replacement position (→ page 157).
- With the wiper arms folded out, clean the wiper blades with a damp cloth.
- ① Make sure that the wiper blades are coated. The coating can leave residues on a cloth. Do not rub the wiper blades excessively or clean them too often.

Exterior lighting

- Clean the lenses with a wet sponge and mild cleaning agent, e.g. car shampoo.

- Only use cleaning agents or cleaning cloths that are suitable for plastic lenses.

Vehicle socket (high-voltage battery)

- Use clean water and a soft cloth to clean the vehicle socket.
- Do not use power washers or cleaning agents, such as soap.

Sensors

- Clean the sensors in the front and rear bumpers with a soft cloth and car shampoo (→ page 217).
- When using a power washer, maintain a minimum distance of 11.8 in (30 cm).

Rear view camera and surround view camera

- Open the camera cover with the multimedia system (→ page 266).
- Use clean water and a soft cloth to clean the camera lens.
- Do not use a power washer.

Notes on care of the interior

⚠ WARNING Risk of injury from plastic parts breaking off after the use of solvent-based care products

Care and cleaning products containing solvents can cause surfaces in the cockpit to become porous. When the airbags are deployed, plastic parts may break away.

- ▶ Do not use any care or cleaning products containing solvents to clean the cockpit.

⚠ WARNING Risk of injury or fatal injuries from bleached seat belts

Bleaching or dyeing seat belts can severely weaken them.

This can, for example, cause seat belts to tear or fail in an accident.

- ▶ Never bleach or dye seat belts.

To avoid damage to the vehicle, observe the following notes on cleaning and care:

Seat belts

- Clean with lukewarm and soapy water.
- Do not use chemical cleaning agents.
- Do not dry by heating them to over 176°F (80°C) or exposing them to direct sunlight.

Display

- Switch off the display and let it cool down.
- Clean the surface carefully with a microfiber cloth and a suitable display care product (TFT-LCD).
- Do not use any other agents.

Head-up Display

- Clean with a soft, non-static, lint-free cloth.
- Do not use cleaning agents.

Plastic trim

- Clean with a damp microfiber cloth.
- For heavy soiling: Use a cleaner recommended for Mercedes-Benz.
- Do not attach stickers, films or similar materials.

- Do not allow cosmetics, insect repellent or sun cream to come in contact with the plastic trim.

Real wood and trim elements

- Clean with a microfiber cloth.
- Black piano-lacquer look: Clean with a damp cloth and soapy water.
- For heavy soiling: Use a cleaner recommended for Mercedes-Benz.
- Do not use solvent-based cleaning agents, polishes or waxes.

Headliner

- Clean with a brush or dry shampoo.

Carpet

- Use a carpet and textile cleaning agent recommended for Mercedes-Benz.

Steering wheel made of genuine leather or DINAMICA

NOTE Damage caused by wrong cleaners

- ▶ Do not use solvent-based cleaning agents such as tar remover or wheel

cleaner; neither should you use polishes or waxes. Otherwise you may damage the finish.

- Clean with a damp cloth and 1% soapy water solution and then wipe with a dry cloth.
- For heavy soiling: Use a cleaner recommended for Mercedes-Benz.
- Leather care: Use a leather care agent that has been recommended for Mercedes-Benz.
- Do not allow the leather to become too damp.
- Do not use a microfiber cloth.
- ⓘ Leather is a natural product. It has natural surface properties, such as differences in structure, marks caused by growth and injury or subtle color differences. These surface properties are characteristics of leather and not material faults. What's more, leather is subject to a natural aging process during which the surface properties change.

Genuine leather seat covers

- Clean with a damp cloth and then wipe with a dry cloth.

362 Maintenance and care

- Leather care: Use a leather care agent that has been recommended for Mercedes-Benz.
 - Do not allow the leather to become too damp.
 - Do not use a microfiber cloth.
- ⓘ Regular cleaning and care of the leather reduces soiling, wear marks and aging damage and thus significantly extends its life span. Clothing that can leave stains, e.g. jeans, can leave discoloration on the leather.

DINAMICA seat covers

- Clean with a damp cloth.
- Do not use a microfiber cloth.

Imitation leather seat covers

- Clean with a damp cloth and 1% soapy water.
- Do not use a microfiber cloth.

Emergency**Removing the safety vest**

The safety vests are located in stowage spaces in the front door.

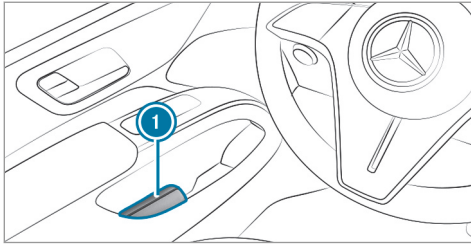

- ▶ Take the safety vest bag out of stowage space ①.
- ▶ Open the safety vest bag and pull out the safety vest.
- ① Safety vests can also be stored in the rear door stowage spaces.

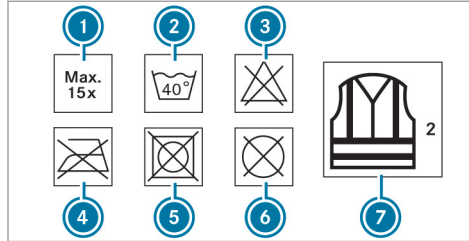

- ① Maximum number of washes
- ② Maximum wash temperature
- ③ Do not bleach
- ④ Do not iron
- ⑤ Do not tumble dry
- ⑥ Do not dry clean
- ⑦ This is a class 2 vest

The requirements defined by the legal standard are only fulfilled in the following cases:

- The safety vest is the correct size
- The safety vest is fully closed whilst being worn

Replace the safety vest in the following cases:

- The reflective strips are damaged or dirt on the reflective strips can no longer be removed
- The maximum number of washes is exceeded
- the fluorescence has faded

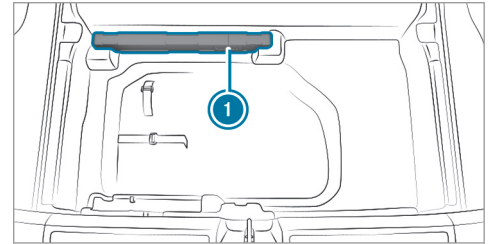
Warning triangle**Removing the warning triangle**

- ▶ Open the cargo compartment floor.
- ▶ Remove warning triangle ①.

Setting up the warning triangle

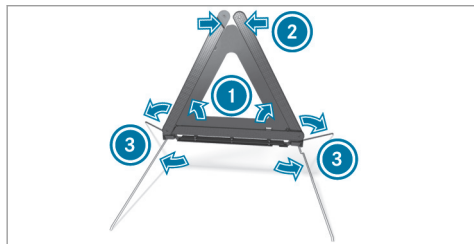

- ▶ Fold side reflectors ① upwards to form a triangle and attach at the top using upper press-stud ②.
- ▶ Fold legs ③ down and out to the side.

First-aid kit (soft sided)

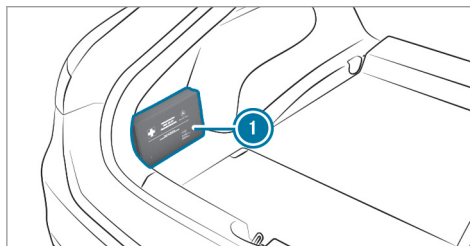

First-aid kit (soft sided) ① is located on the left-hand side of the trunk when delivered.

Flat tire

Notes on flat tires

⚠ WARNING Risk of accident due to a flat tire

A flat tire severely affects the driving characteristics as well as the steering and braking of the vehicle.

Tires without run-flat characteristics:

- ▶ Do not drive with a flat tire.
- ▶ Change the flat tire immediately with an emergency spare wheel or spare wheel. Alternatively, consult a qualified specialist workshop.

Tires with run-flat characteristics:

- ▶ Observe the information and warning notes on MOExtended tires (run-flat tires).

In the event of a flat tire, the following options are available depending on your vehicle's equipment:

- **Vehicles with MOExtended tires:** it is possible to continue the journey for a short period of time. Make sure you observe the notes on MOExtended tires (run-flat tires) (→ page 365).
- **Vehicles with a TIREFIT kit:** you can repair the tire so that it is possible to continue the journey for a short period of time. To do this, use the TIREFIT kit (→ page 366).

- **Vehicles with Mercedes me connect:** you can make a call for breakdown assistance via the overhead control panel in the case of a breakdown (→ page 336).
- **All vehicles:** change the wheel (→ page 404).

i The emergency spare wheel is only available in certain countries.

Notes on MOExtended tires (run-flat tires)

⚠ WARNING Risk of accident when driving in limp-home mode

When driving in emergency mode the handling characteristics are impaired.

- ▶ Do not exceed the specified maximum speed of the MOExtended tires.
- ▶ Avoid any abrupt steering and driving maneuvers as well as driving over obstacles (curbs, pot holes, off-road). This applies, in particular, to a loaded vehicle.
- ▶ Stop driving in the emergency mode if you notice:

- Banging noise
 - Vehicle vibration
 - Smoke which smells like rubber
 - Continuous ESP® intervention
 - Cracks in the tire side walls
- ▶ After driving in emergency mode, have the rims checked by a qualified specialist workshop with regard to their further use.
 - ▶ The defective tire must be replaced in every case.

With MOExtended tires (run-flat tires), you can continue to drive your vehicle even if there is a total loss of pressure in one or more tires. However, the tire affected must not show any clearly visible damage.

You can recognize MOExtended tires by the MOExtended marking which appears on the side wall of the tire.

Vehicles with tire pressure monitoring system: MOExtended tires may only be used in conjunc-

tion with an activated tire pressure monitoring system.

If a pressure loss warning message appears in the driver's display, proceed as follows:

- Check the tire for damage.
- If driving on, observe the following notes.

Driving distance possible in emergency mode after the pressure loss warning:

Load condition	Driving distance possible in emergency mode
Partially laden	50 miles (80 km)
Fully laden	19 miles (30 km)

The driving distance possible in emergency mode may vary depending on the driving style. Observe the maximum permissible speed of 50 mph (80 km/h).

If a tire has gone flat and cannot be replaced with an MOExtended tire, you can use a standard tire as a temporary measure.

TIREFIT kit storage location

The TIREFIT kit is located under the cargo compartment floor.

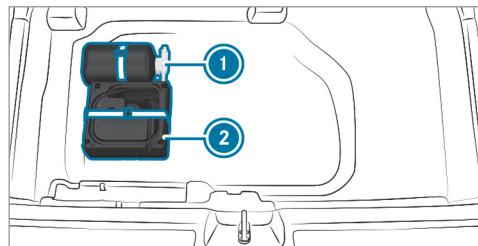

- ① Tire sealant bottle
- ② Tire inflation compressor

Depending on the model, the TIREFIT kit may also be located in other places under the cargo compartment floor.

Using the TIREFIT kit

Requirements:

- Tire sealant bottle and tire inflation compressor (→ page 366)
- TIREFIT sticker
- Gloves

You can use TIREFIT tire sealant to seal perforation damage of up to 0.16 in (4 mm), particularly those in the tire contact surface. You can use TIREFIT in outside temperatures down to -4 °F (-20 °C).

⚠ WARNING Risk of accident when using tire sealant

The tire sealant may be unable to seal the tire properly, especially in the following cases:

- There are large cuts or punctures in the tire (larger than damage previously mentioned)
- The wheel rims have been damaged
- After journeys with very low tire pressure or with flat tires

- ▶ Do not continue driving.
- ▶ Consult a qualified specialist workshop.

⚠ WARNING Risk of injury and poisoning from tire sealant

The tire sealant is harmful and causes irritation. Do not allow it to come into contact with the skin, eyes or clothing, and do not swallow it. Do not inhale tire sealant fumes. Keep the tire sealant away from children.

If you come into contact with the tire sealant, observe the following:

- ▶ Rinse off the tire sealant from your skin immediately using water.
- ▶ If tire sealant gets into your eyes, thoroughly rinse out the eyes using clean water.
- ▶ If tire sealant has been swallowed, immediately rinse out the mouth thoroughly and drink plenty of water. Do not induce vomiting and seek medical attention immediately.

- ▶ Change out of any clothes contaminated with tire sealant immediately.
- ▶ If allergic reactions occur, seek medical attention immediately.

! **NOTE** Overheating due to the tire inflation compressor running too long

- ▶ Do not run the tire inflation compressor for longer than ten minutes without interruption.

Comply with the manufacturer's safety notes on the sticker on the tire inflation compressor.

Have the tire sealant bottle replaced in a qualified specialist workshop every five years.

- ▶ Do not remove any foreign objects which have entered the tire.

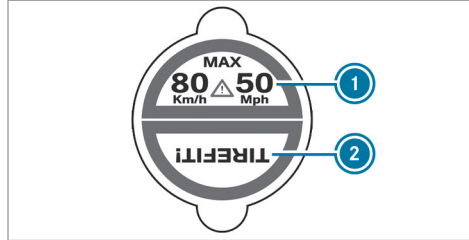

- ▶ Affix part ① of the TIREFIT sticker to the instrument cluster within the driver's field of vision.
- ▶ Affix part ② of the TIREFIT sticker near the valve on the wheel with the faulty tire.

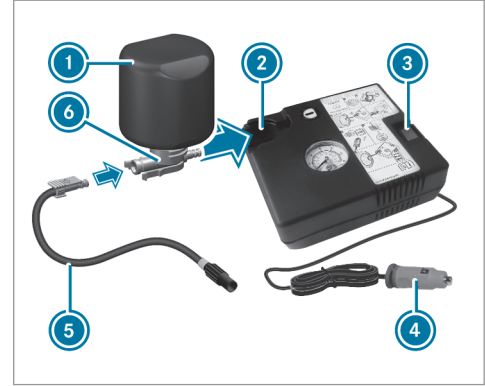

- ▶ Pull plug ④ with the cable and hose ⑤ out of the tire inflation compressor housing.
- ▶ Push the plug of hose ⑤ into flange ⑥ of tire sealant bottle ① until the plug engages.
- ▶ Place tire sealant bottle ① head downwards into recess ② of the tire inflation compressor.

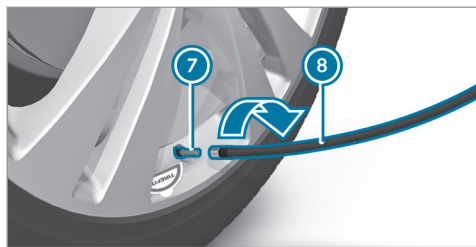

- ▶ Remove the valve cap from valve ⑦ on the faulty tire.
 - ▶ Screw filling hose ⑧ onto valve ⑦.
 - ▶ Insert plug ④ into a 12 V socket in your vehicle.
 - ▶ Switch on the vehicle.
 - ▶ Switch on the tire inflation compressor using On/Off switch ③.
- The tire is inflated. First, tire sealant is pumped into the tire. The pressure may briefly rise to approximately 500 kPa (5.0 bar/73 psi).

Do not switch off the tire inflation compressor during this phase!

- ▶ Let the tire inflation compressor run for a maximum of ten minutes.
The tire should then have attained a tire pressure of at least 200 kPa (2.0 bar/29 psi).

If tire sealant leaks out, make sure you clean the affected area as quickly as possible. It is preferable to use clean water.

If you get tire sealant on your clothing, have it cleaned as soon as possible with perchloroethylene.

If, after ten minutes, a tire pressure of 200 kPa (2.0 bar/29 psi) has not been attained:

- ▶ Switch off the tire inflation compressor.
- ▶ Unscrew the filling hose from the valve of the faulty tire.

Please note that tire sealant may leak out when unscrewing the filling hose.

- ▶ Drive forwards or in reverse very slowly for approximately 33 ft (10 m).

- ▶ Pump up the tire again.
After a maximum of ten minutes the tire pressure must be at least 200 kPa (2.0 bar/29 psi).

⚠ WARNING Risk of accident due to the specified tire pressure not being achieved

If the specified tire pressure is not achieved after the specified time, the tire is too badly damaged. The tire sealant cannot repair the tire in this instance.

The braking characteristics as well as the driving characteristics may be greatly impaired.

- ▶ Do not continue driving.
- ▶ Consult a qualified specialist workshop.

If, after ten minutes, a tire pressure of 200 kPa (2.0 bar/29 psi) has been attained:

- ▶ Switch off the tire inflation compressor.
- ▶ Unscrew the filling hose from the valve of the faulty tire.

⚠ WARNING Risk of accident from driving with sealed tires

A tire temporarily sealed with tire sealant impairs the handling characteristics and is not suitable for higher speeds.

- ▶ Adapt your driving style accordingly and drive carefully.
- ▶ Do not exceed the maximum speed limit with a tire that has been repaired using tire sealant.

- ▶ Observe the maximum permissible speed for a tire sealed with tire sealant 50 mph (80 km/h).

! NOTE Staining caused by leaking tire sealant

After use, excess tire sealant may leak out from the filling hose.

- ▶ Therefore, place the filling hose in the plastic bag that contained the TIREFIT kit.

🔥 ENVIRONMENTAL NOTE Environmental pollution caused by environmentally irresponsible disposal

Tire sealant contains pollutants.

- ▶ Have the tire sealant bottle disposed of professionally, e.g. at an authorized Mercedes-Benz Center.

- ▶ Stow the tire sealant bottle and the tire inflation compressor.
- ▶ Pull away immediately.
- ▶ Stop driving after approximately ten minutes and check the tire pressure using the tire inflation compressor.
The tire pressure must now be at least 130 kPa (1.3 bar/19 psi).

⚠ WARNING Risk of accident due to the specified tire pressure not being attained

If the specified tire pressure is not reached, the tire is too badly damaged. The tire sealant cannot repair the tire in this instance.

The braking and driving characteristics may be greatly impaired.

- ▶ Do not continue driving.
- ▶ Consult a qualified specialist workshop.

In cases such as the one mentioned above, contact an authorized Mercedes-Benz Center. Or call 1-800-FOR-MERCEDES (in the USA) or 1-800-387-0100 (in Canada).

- ▶ Correct the tire pressure if it is still at least 130 kPa (1.3 bar/19 psi). See the Tire and Loading Information placard on the B-pillar on the driver's side or the tire pressure table in the socket flap for values.
- ▶ **To increase the tire pressure:** switch on the tire inflation compressor.

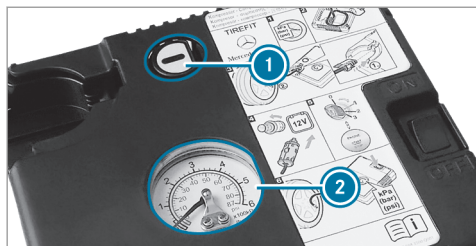

- ▶ **To reduce the tire pressure:** press pressure release button ① next to manometer ②.
- ▶ When the tire pressure is correct, unscrew the filling hose from the valve of the sealed tire.
- ▶ Screw the valve cap onto the valve of the sealed tire.
- ▶ Pull the tire sealant bottle out of the tire inflation compressor. The filling hose stays on the tire sealant bottle.
- ▶ Drive to the nearest qualified specialist workshop and have the tire, tire sealant bottle and filling hose replaced there.

Battery (vehicle)

Notes on the 12 V battery

⚠ WARNING Risk of explosion due to electrostatic charge

Electrostatic charge can ignite the highly explosive gas mixture in the battery.

- ▶ To discharge any electrostatic charge that may have built up, touch the metal vehicle body before handling the battery.

The highly flammable gas mixture is created while the battery is charging and during starting assistance.

⚠ WARNING Danger of chemical burns from the battery acid

Battery acid is caustic.

- ▶ Avoid contact with the skin, eyes or clothing.
- ▶ Do not lean over the battery.
- ▶ Do not inhale battery gases.

- ▶ Keep children away from the battery.
- ▶ Immediately rinse battery acid off thoroughly with plenty of clean water and seek medical attention immediately.

🔥 ENVIRONMENTAL NOTE Environmental damage due to improper disposal of batteries



Batteries contain pollutants. It is illegal to dispose of them with the household rubbish.



Dispose of batteries in an environmentally responsible manner. Take discharged batteries to a qualified specialist workshop or to a collection point for used batteries.

If you have to disconnect the 12 V battery, contact a qualified specialist workshop.

Comply with safety notes and take protective measures when handling batteries.



Risk of explosion.



Fire, open flames and smoking are prohibited when handling the battery. Avoid creating sparks.



Electrolyte or battery acid is corrosive. Avoid contact with the skin, eyes or clothing. Wear suitable protective clothing, in particular gloves, an apron and a face mask. Immediately rinse electrolyte or acid splashes off with clean water. Consult a doctor if necessary.



Wear safety glasses.



Keep children away.



Observe this Operator's Manual.

If you do not want to use the vehicle for a long period of time, consult a qualified specialist workshop.

Notes on the high-voltage battery

⚠ DANGER Risk of explosion from excessive internal pressure of the high-voltage battery

Flammable gas may escape and ignite in the event of a vehicle fire.

▶ Stop the charging process immediately in case of unusual odors, smoke or burn marks.

- ▶ Leave the danger zone immediately. Secure the danger zone at a sufficient distance.
- ▶ Call the fire brigade.

Observe the notes on charging the high-voltage battery (→ page 195).



Risk of explosion.



Fire, open flames and smoking are prohibited when handling the battery. Avoid creating sparks.



Electrolyte or battery acid is corrosive. Avoid contact with the skin, eyes or clothing. Wear suitable protective clothing, in particular gloves, an apron and a face mask. Immediately rinse electrolyte or acid splashes off with clean water. Consult a doctor if necessary.



Wear safety glasses.



Keep children away.



Observe this Operator's Manual.

Starting assistance and charging the 12 V battery

- ▶ Only have starting assistance provided by a qualified specialist workshop, e.g. an authorized Mercedes-Benz Center.
- ▶ Only have the battery charged at a qualified specialist workshop, e.g. an authorized Mercedes-Benz Center.

Replacing the 12 V battery

- ▶ Only have the battery replaced at a qualified specialist workshop, e.g. at an authorized Mercedes-Benz Center.

Tow starting or towing away

Overview of the permitted towing methods

! NOTE Damage from automatic braking

If one of the following functions is switched on, the vehicle brakes automatically in certain situations:

- Active Brake Assist
- Active Distance Assist DISTRONIC
- HOLD function
- Active Parking Assist

To avoid damage to the vehicle, deactivate these systems in the following or similar situations:

- ▶ During towing
- ▶ In a car wash

Mercedes-Benz recommends transporting your vehicle in the case of a breakdown, rather than towing it away.

For towing, use a tow rope or tow bar with both axles on the ground. Do not use tow bar systems.

If you notice that the vehicle has lost coolant, do not have it towed away. Have the vehicle transported instead.

! NOTE Damage to the vehicle due to towing away incorrectly

- ▶ Observe the instructions and notes on towing away.

Vehicles with rear wheel drive**Permitted towing methods**

Both axles on the ground	Yes, maximum 30 miles (50 km) at 30 mph (50 km/h), only forwards with the driver in the cockpit.
Front axle raised	No
Rear axle raised	Yes, maximum 30 miles (50 km) at 30 mph (50 km/h)

4MATIC vehicles**Permitted towing methods**

Both axles on the ground	Yes, maximum 30 miles (50 km) at 30 mph (50 km/h), only forwards with the driver in the cockpit.
Front axle raised	No
Rear axle raised	No

Towing the vehicle with both axles on the ground



- ▶ Observe the notes on the permitted towing methods (→ page 372).
- ▶ Make sure that the 12 V battery is connected and charged.

Observe the following points when the 12 V battery is disconnected or discharged:

- The drive system cannot be started
- The electric parking brake cannot be released or applied
- The transmission cannot be shifted to position **N** or **P**

In the following situations, only transporting the vehicle is permitted:

- If the transmission cannot be shifted to **N**
- If the 12 V battery is disconnected or discharged
- If the display in the instrument cluster is not working
- If the  **Towing Not Permitted See Operator's Manual** message is displayed

- If the  **Check Coolant Level See Operator's Manual** message is displayed
 - If the  **Stop Switch Engine Off** message is displayed
- ▶ In such cases, transport the vehicle (→ page 375).

! **NOTE** Damage due to towing away at excessively high speeds or over long distances

The drivetrain could be damaged when towing at excessively high speeds or over long distances.

- ▶ A towing speed of 30 mph (50 km/h) must not be exceeded.
- ▶ A towing distance of 30 miles (50 km) must not be exceeded.

⚠ WARNING Risk of accident when towing a vehicle which is too heavy

If the vehicle to be tow-started or towed away is heavier than the permissible gross mass of your vehicle, the following situations can occur:

- The towing eye may become detached.
- The vehicle/trailer combination may swerve or rollover.

▶ Before tow-starting or towing away, check if the vehicle to be tow-started or towed away exceeds the permissible gross mass.

If a vehicle must be tow-started or towed away, its permissible gross mass must not exceed the permissible gross mass of the towing vehicle.

▶ Information on the permissible gross mass of the vehicle can be found on the vehicle identification plate (→ page 412).

Towing away the vehicle

▶ Install the towing eye (→ page 378).

▶ Fasten the towing device.

! NOTE Damage due to incorrect connection of the tow bar

▶ Only connect the tow rope or tow bar to the towing eyes.

- ▶ Deactivate the automatic locking mechanism (→ page 80).
- ▶ Do not activate the HOLD function.
- ▶ Deactivate the tow-away alarm (→ page 101).
- ▶ Deactivate Active Brake Assist (→ page 246).
- ▶ Shift the transmission to position **N**.
- ▶ Release the electric parking brake.
- ▶ Remain in the cockpit during towing and observe the display messages.
- ▶ Do not switch off the vehicle while it is being towed.
- ▶ Do not open the driver's door or front passenger door; the transmission will otherwise automatically shift to **P**.

⚠ WARNING Risk of accident due to limited safety-related functions during the towing process

Safety-related functions are limited or no longer available in the following situations:

- The vehicle is switched off.
- The brake system or power steering system is malfunctioning.
- The energy supply or the on-board electrical system is malfunctioning.

▶ In such cases, do not tow the vehicle.

▶ Transport the vehicle (→ page 375).

! NOTE Damage to the drive system due to incorrect towing

The vehicle may not be towed in the following situations:

- The vehicle is switched off.
- The brake system or power steering system is malfunctioning.

- The energy supply or the on-board electrical system is malfunctioning.
- ▶ In such cases, do not tow the vehicle.

! **NOTE** Damage due to excessive tractive power

If you pull away sharply, the tractive power may be too high and the vehicles could be damaged.

- ▶ Pull away slowly and smoothly.

Loading the vehicle for transport

Requirements:

- The vehicle is stationary.
- The vehicle is switched off.
- The driver's display is in the initial state with no menus open (→ page 287). Transport is also possible with a warning message visible.
- The 12 V battery is charged.

- ▶ If necessary, set the system language (→ page 320).
- ▶ Observe the notes on towing away (→ page 373).
- ▶ Connect the towing device to the towing eye in order to load the vehicle.
- ▶ Switch on the power supply (→ page 180).
- ▶ Shift the transmission to position **N**.
- ⓘ The transmission may be locked in position **P** in the event of damage to the electrics. To shift to **N**, provide the on-board electrical system with power (→ page 372).

! **NOTE** Possible damage to the vehicle when loading or unloading

When loading or unloading, the vehicle must be raised to transport level.

If the transport settings are not shown or the **Vehicle Not Ready for Loading** message is displayed, the vehicle may not be loaded or unloaded.

- ▶ If required, raise the vehicle to transport level again.
- ▶ A vehicle that cannot be raised to transport level may not be loaded or unloaded using a ramp. Consult a qualified specialist workshop.

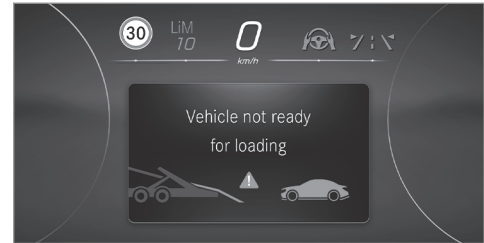



! **WARNING** Risk of accident due to activated transport level



If the vehicle is raised to transport level, driving and driving safety systems have only limited availability and the view from the vehicle is restricted.

Driving safety is severely restricted and there is a risk of an accident!

- ▶ Do not use transport level in normal road operation.
- ▶ Only activate and use transport level to load the vehicle and when not on public roads.
- ▶ Ensure that no persons or obstacles are located in the area surrounding the vehicle.

Raising the vehicle to transport level

- ▶ Press the  button for at least five seconds.
- ▶ Immediately press and hold the  button for at least one second. The **For Transport Level Switch On Vehicle** message is displayed.
- ▶ Switch on the vehicle (→ page 181). The transport settings are displayed.

- ▶ Swipe downward to select **Transport Level** and press . The vehicle is raised and the **Vehicle raising..... Do not drive onto ramp yet** message is displayed for 5 seconds. The raising process can last up to 60 seconds and can be canceled with the  button.
- ▶ When raising, do not switch off the vehicle.

While the vehicle is being raised, you can maneuver at a maximum speed of 25 mph (40 km/h).



- ▶ Before loading the vehicle, wait until transport level has been reached and the **Transport Level** status is shown.

- ⓘ If the vehicle is raised to transport level, the transport settings will continue to be shown even after a restart. Operation of the driver's display is meanwhile restricted.

When the vehicle is at transport level, it is lowered again in the following situations:

- When driven faster than 25 mph (40 km/h).
- The 12 V battery is discharged.

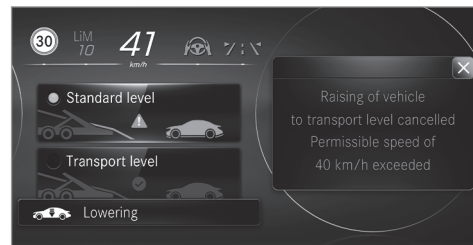

The vehicle is adjusted to the height of the last active level.

Transporting the vehicle

- ▶ Load the vehicle onto the transporter.

- ▶ Shift the transmission to position **P**.
- ▶ Use the electric parking brake to secure the vehicle against rolling away.
- ▶ Switch off the vehicle and the power supply.
- ▶ Only secure the vehicle by the wheels.

4MATIC vehicles

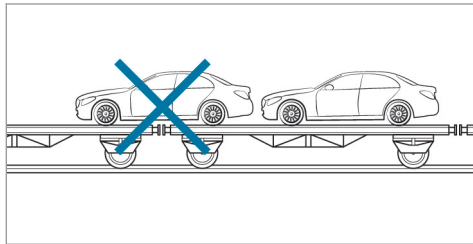

- ▶ Make sure that the front and rear axles come to rest on the same transportation vehicle.

! **NOTE** Damage to the drive train due to incorrect positioning of the vehicle

- ▶ Do not position the vehicle above the connection point of the transport vehicle.

Unloading the vehicle

- ▶ Make sure that the vehicle is raised to transport level before unloading (→ page 259).

Lowering the vehicle after unloading

- ▶ Switch on the power supply.
- ▶ Switch on the vehicle.
- ▶ Swipe upward in the transport settings to select **Standard Level** and press **OK**.
The vehicle is adjusted to the height of the last active level and the **Lowering Vehicle...** message is displayed.
- ▶ After the vehicle has been lowered, press the **↵** button for at least two seconds.
The transport settings are closed.

Towing eye storage location

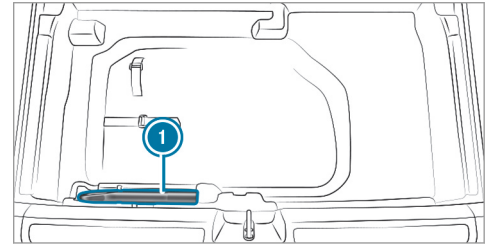

Towing eye ① is located under the trunk floor.

Installing and removing the towing eye

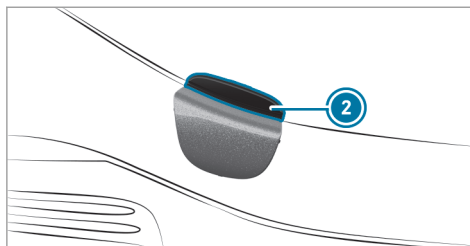
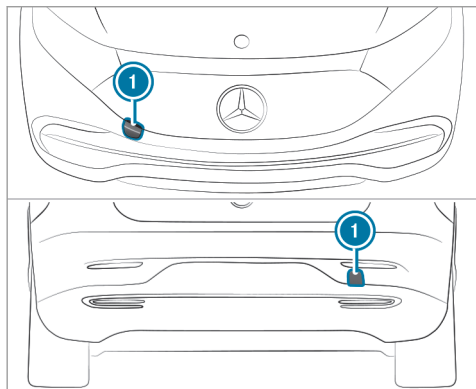

- ▶ Press cover ① at top ② inwards and remove.
- ▶ Screw in the towing eye clockwise as far as it will go and tighten.
- ▶ Make sure that cover ① engages in the bumper when you remove the towing eye.

! **NOTE** Damage to the vehicle due to incorrect use of the towing eye or trailer hitch

When a towing eye or trailer hitch is used to recover a vehicle, the vehicle may be damaged in the process.

- ▶ Only use the towing eye or trailer hitch to tow away or tow start the vehicle.
- ▶ Do not use the towing eye or trailer hitch to tow the vehicle during recovery.

Tow-starting the vehicle

- ▶ If the drive system does not start, have the vehicle transported to a qualified specialist workshop, e.g. an authorized Mercedes-Benz Center.
- ▶ The drive system cannot be started by tow-starting the vehicle. Do not perform any attempts to tow-start the vehicle.

Electrical fuses

Notes on electrical fuses

⚠ **WARNING** Risk of accident and injury due to overloaded lines

If you manipulate or bridge a faulty fuse or if you replace it with a fuse with a higher amperage, the electric line could be overloaded.

This could result in a fire.

- ▶ Always replace faulty fuses with specified new fuses containing the correct amperage.

! NOTE Damage due to incorrect fuses

Electrical components or systems may be damaged by incorrect fuses, or their functionality may be significantly impaired.

- ▶ Only use fuses that have been approved by Mercedes-Benz and which have the correct fuse rating.

Blown fuses must be replaced with fuses of the same rating, which you can recognize by the color and the label. The fuse ratings and further information to be observed can be found in the fuse assignment diagram.

Fuse assignment diagram: on the fuse box in the rear passenger compartment (→ page 380).

! NOTE Damage or malfunctions caused by moisture

Moisture may cause damage to the electrical system or cause it to malfunction.

- ▶ When the fuse box is open, make sure that no moisture can enter the fuse box.
- ▶ When closing the fuse box, make sure that the seal of the lid is positioned correctly on the fuse box.

If the newly inserted fuse also blows, have the cause traced and rectified at a qualified specialist workshop.

Ensure the following before replacing a fuse:

- The vehicle is secured against rolling away.
- All electrical consumers are switched off.
- The vehicle is switched off.

The electrical fuses are located in various fuse boxes:

- Fuse box on the driver's side of the cockpit (→ page 379)

- Fuse box in the front passenger footwell (→ page 379)
- Fuse box in the rear passenger compartment (→ page 380)

Opening and closing the fuse box in the cockpit

- Observe the notes on electrical fuses (→ page 378).

The fuse box is on the driver's side on the side of the cockpit under a cover.

- ▶ To open and close it, consult an authorized Mercedes-Benz Center.

Opening and closing the fuse box in the front passenger footwell

Requirements:

- Observe the notes on electrical fuses (→ page 378).

Right-hand drive vehicles: the fuse box is on the left side.

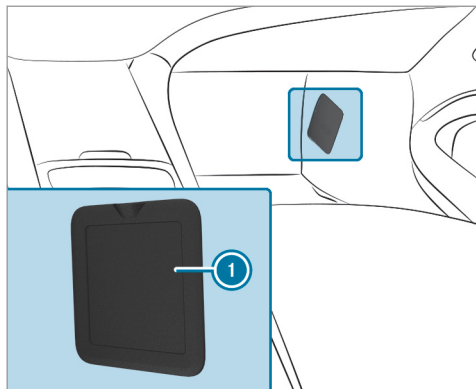

The fuse box is under the seat on the right side of the vehicle.

- ▶ Contact an authorized Mercedes-Benz Center for further information.

- ▶ **To open the fuse box:** Remove cover ①.
- ▶ **To close the fuse box:** Reinsert cover ①.

Opening and closing the fuse box in the rear passenger compartment

Requirements:

- Observe the notes on electrical fuses (→ page 378).

Notes on noise or unusual handling characteristics

Make sure there are no vibrations, noises or unusual handling characteristics when the vehicle is in motion. This may indicate that the wheels or tires are damaged. Hidden tire damage could also be causing the unusual handling characteristics. If you suspect that a tire is malfunctioning, reduce your speed immediately and have the tires and wheels checked at a qualified specialist workshop.

Notes on regularly inspecting wheels and tires

⚠ WARNING Risk of injury through damaged tires

Damaged tires can cause tire pressure loss.

- ▶ Check the tires regularly for signs of damage and replace any damaged tires immediately.

⚠ WARNING Risk of hydroplaning due to insufficient tire tread

Insufficient tire tread will result in reduced tire grip.

In heavy rain or slush the risk of hydroplaning is increased, in particular where speed is not adapted to suit the conditions.

- ▶ Thus, you should regularly check the tread depth and the condition of the tread across the entire width of all tires.

Minimum tread depth for:

- Summer tires: $\frac{1}{8}$ in (3 mm)
- M+S tires: $\frac{1}{16}$ in (4 mm)

- ▶ For safety reasons, replace the tires before the legally-prescribed limit for the minimum tread depth is reached.

Carry out the following checks on all wheels regularly, at least once a month or as required, for example, prior to a long journey or driving off-road:

- Check the tire pressure (→ page 383).

- Visually inspect wheels and tires for damage.
- Check the valve caps.
- Visual check of the tire tread depth and the tire contact surface across the entire width.

The minimum tread depth for summer tires is $\frac{1}{8}$ in (3 mm) and for winter tires $\frac{1}{16}$ in (4 mm).

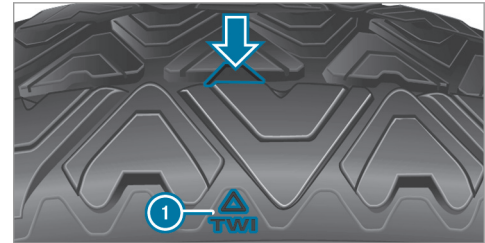

Six marks ① show where the bar indicators (arrow) are integrated into the tire tread. They are visible once a tire tread depth of approximately $\frac{1}{16}$ in (1.6 mm) has been reached.

Notes on snow chains

⚠ WARNING Risk of accident due to incorrectly installed snow chains

If you have installed snow chains on the front wheels, they may drag against the vehicle body or chassis components.

- ▶ Never install snow chains on the front wheels.
- ▶ Only install snow chains on the rear wheels in pairs.

ⓘ NOTE Damage to components of the vehicle body or chassis due to mounted snow chains

If you mount snow chains to the front wheels of 4MATIC vehicles, you may damage components of the vehicle body or chassis.

- ▶ Only mount snow chains to the rear wheels of 4MATIC vehicles.

Observe the following notes when using snow chains:

- Snow chains are only permissible for certain wheel/tire combinations. You can obtain information about this from an authorized Mercedes-Benz Center.
- For safety reasons, only use snow chains that have been specifically approved for your vehicle by Mercedes-Benz, or snow chains with the same quality standard.
- Comply with the installation instructions of the snow chain manufacturer.
- If snow chains are installed, the maximum permissible speed is 30 mph (50 km/h).
- **Vehicles with Active Parking Assist:** Do not use Active Parking Assist when snow chains are installed.
- **Vehicles with level control:** If snow chains are installed, only drive at raised vehicle level (→ page 259).
- **Vehicles with rear axle steering:** If snow chains are installed, only drive with snow chain mode active (→ page 382).

- ⓘ You can deactivate ESP® to pull away (→ page 221). This allows the wheels to spin, achieving an increased driving force.

Activating or deactivating snow chain mode

Multimedia system:



- ▶ Activate or deactivate **Snow Chain Mode**.

When the function is active, the vehicle behaves as if snow chains were mounted. For example, the maximum steering movement of the rear wheels is limited.

Additionally, parts of the driving and driving safety systems are not available when snow chain mode is active.

Tire pressure

Notes on tire pressure

⚠ WARNING Risk of accident due to insufficient or excessive tire pressure

Underinflated or overinflated tires pose in particular the following risks:

- The tires can burst.
- The tires can wear excessively and/or unevenly.
- The driving characteristics as well as the steering and braking characteristics may be greatly impaired.

▶ Comply with the recommended tire pressures and check the tire pressure of all tires, including the spare wheel, regularly:

- Monthly
- When the load changes
- Before embarking on a longer journey

- If operating conditions change, e.g. off-road driving
- ▶ Adjust the tire pressure, if necessary.

Tire pressure which is too high or too low can:

- Shorten the service life of the tires.
- Cause increased tire damage.
- Adversely affect driving characteristics and thus driving safety, e.g. due to hydroplaning.

⚠ WARNING Risk of accident due to too low a tire pressure

Tires with pressure that is too low can overheat and burst as a consequence.

In addition, they also suffer from irregular wear, which can significantly impair the braking properties and the handling characteristics.

▶ Avoid excessively low tire pressure.

Tire pressure which is too low can cause:

- Tire malfunctions as a result of overheating

- Impaired handling characteristics
- Irregular wear
- Increased energy consumption

⚠ WARNING Risk of accident due to too high a tire pressure

Tires with excessively high pressure can burst.

In addition, they also suffer from irregular wear, which can significantly impair the braking properties and the handling characteristics.

▶ Avoid excessively high tire pressures.

Tire pressure which is too high can cause:

- Increased braking distance
- Impaired handling characteristics
- Irregular wear
- Impaired driving comfort
- Susceptibility to damage

⚠ WARNING Risk of accident due to repeated pressure drop in the tires

The wheels, valves or tires could be damaged. Too low a tire pressure can lead to the tires bursting.

- ▶ Examine the tires for foreign objects.
- ▶ Check whether the tire has a puncture or the valve has a leak.
- ▶ If you are unable to rectify the damage, contact a qualified specialist workshop.

You can find information on tire pressure for the vehicle's factory-installed tires on the following labels:

- Tire and Loading Information placard on the B-pillar of your vehicle (→ page 388).
- Tire pressure table on the inside of the socket flap (→ page 384).

Observe the maximum tire pressure (→ page 394).

Use a suitable pressure gauge to check the tire pressure. The outer appearance of a tire does not

permit any reliable conclusion about the tire pressure.

Only correct tire pressure when the tires are cold. Conditions for cold tires:

- The vehicle has been parked with the tires out of direct sunlight for at least three hours.
- The vehicle has traveled less than 1 mile (1.6 km).

The vehicle's tires heat up when driving. As the temperature of the tires increases, so too does the tire pressure.

Vehicles with a tire pressure monitoring system:

You can also see the tire pressure in the driver's display.

The tire pressure recommended for increased load/speed in the tire pressure table can affect the ride comfort.

⚠ WARNING Risk of accident due to unsuitable accessories on tire valves

If you mount unsuitable accessories onto tire valves, the tire valves may be overloaded and

malfunction, which can cause tire pressure loss.

- ▶ Only screw standard valve caps or valve caps specifically approved by Mercedes-Benz for your vehicle onto the tire valve.

Tire pressure table

The tire pressure table is on the inside of the socket flap.

- ⓘ The data shown in the images is example data.

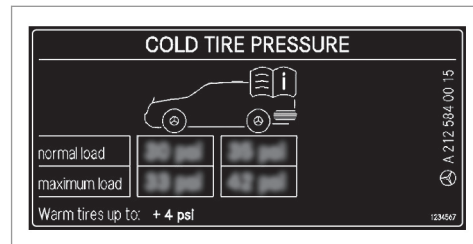

The tire pressure table shows the recommended tire pressure for all tires approved for this vehicle. The recommended tire pressures apply for cold tires under various operating conditions, i.e. loading and/or speed of the vehicle.

If one or more tire sizes precede a tire pressure, the tire pressure information following is only valid for those tire sizes.

The load conditions "partially laden" and "fully laden" are defined in the table for different numbers of passengers and amounts of luggage. The actual number of seats may differ from this.

		kPa		psi	
R18					
R19					
M+S					

Some tire pressure tables only show the rim diameter instead of the complete tire size, e.g. **R18**. The rim diameter is part of the tire size and can be found on the tire side wall (→ page 395).

Be sure to also observe the following further related subjects:

- Notes on tire pressure (→ page 383)
- Tire and Loading Information placard (→ page 388)

- Maximum tire pressure (→ page 394)

Checking the tire pressure manually

- ▶ Read the tire pressure recommended for the current operating conditions from the Tire and Loading Information placard or the tire pressure table. Observe the notes on tire pressure.
- ▶ Remove the valve cap of the tire to be checked.
- ▶ Press the tire pressure gauge securely onto the valve.
- ▶ Read the tire pressure.
- ▶ If the tire pressure is lower than the recommended value, increase the tire pressure to the recommended value.
- ▶ If the tire pressure is higher than the recommended value, release air. To do so, press down the metal pin in the valve, e.g. using the tip of a pen. Then, check the tire pressure again using the tire pressure gauge.
- ▶ Screw the valve cap onto the valve.

Further related subjects:

- Notes on tire pressure (→ page 383)
- Tire pressure table (→ page 384)
- Tire and Loading Information placard (→ page 388)

Tire pressure monitoring system

Function of the tire pressure monitoring system

⚠ DANGER Risk of accident due to incorrect tire pressure

Each tire, including the spare (if provided), should be checked monthly when cold and inflated to the inflation pressure recommended by the vehicle manufacturer on the vehicle placard or tire inflation pressure label. (If your vehicle has tires of a different size than the size indicated on the vehicle placard or tire inflation pressure label, you should determine the proper tire inflation pressure for those tires.)

As an added safety feature, your vehicle has been equipped with a tire pressure monitoring system (TPMS) that illuminates a low tire pressure telltale when one or more of your tires is significantly under-inflated. Accordingly, when the low tire pressure telltale illuminates, you should stop and check your tires as soon as possible, and inflate them to the proper pressure. Driving on a significantly under-inflated tire causes the tire to overheat and can lead to tire failure. Under-inflation also reduces fuel efficiency and tire tread life, and may affect the vehicle's handling and stopping ability. Please note that the TPMS is not a substitute for proper tire maintenance, and it is the driver's responsibility to maintain correct tire pressure, even if under-inflation has not reached the level to trigger illumination of the TPMS low tire pressure telltale.

Your vehicle has also been equipped with a TPMS malfunction indicator to indicate when the system is not operating properly. The TPMS malfunction indicator is combined with the low tire pressure telltale. When the system

detects a malfunction, the telltale will flash for approximately one minute and then remain continuously illuminated. This sequence will continue upon subsequent vehicle start-ups as long as the malfunction exists.

When the malfunction indicator is illuminated, the system may not be able to detect or signal low tire pressure as intended. TPMS malfunctions may occur for a variety of reasons, including the installation of replacement or alternate tires or wheels on the vehicle that prevent the TPMS from functioning properly.

The system checks the tire pressure and the tire temperature of the tires installed on the vehicle by means of a tire pressure sensor.

The tire pressure and the tire temperature appear on the driver display.

If there is a substantial pressure loss or if the tire temperature is excessive, you will be warned with display messages (→ page 480) or the  warning lamp in the driver display (→ page 498).

The tire pressure monitoring system is only an aid. It is the driver's responsibility to set the tire pres-

sure to the recommended cold tire pressure suitable for the operating situation.

In most cases, the tire pressure monitoring system will automatically update the new reference values after you have changed the tire pressure. You can, however, also update the reference values by restarting the tire pressure monitoring system manually (→ page 387).

System limits

The system may be impaired or may not function particularly in the following situations:

- Incorrect reference values were taught in
- Sudden pressure loss caused by a foreign object penetrating the tire, for example
- There is a malfunction caused by another radio signal source

Checking the tire pressure with the tire pressure monitoring system

Requirements:

- The vehicle is switched on.

Driver's display:



▶ Press **OK** to confirm.

One of the following displays appears:

- Current tire pressure of each wheel:

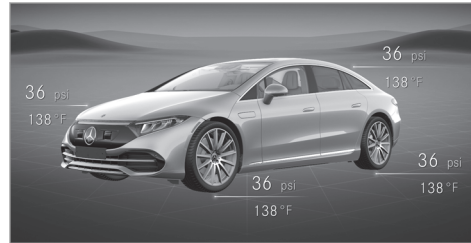

- **Tire pressure displayed after driving for a few minutes.:** current values are not yet known to the system. The pressure/temperature values of each tire are displayed as soon as they are known to the system.
- **Tire Pressure Monitor Active:** the teach-in process of the system is not yet complete. The tire pressures are already being monitored.

▶ Compare the current tire pressure with the recommended tire pressure for the current operating condition (→ page 384). Additionally, observe the notes on cold tires (→ page 383).

ⓘ The values displayed on the driver display may deviate from those of the tire pressure gauge as they refer to sea level. At high elevations, the tire pressure value indicated by a tire pressure gauge are higher than those shown on the driver display.

Bear in mind the following related topic:

- Notes on tire pressure (→ page 383)

Restarting the tire pressure monitoring system

Requirements:

- The recommended tire pressure is correctly set for the respective operating status on each of the four wheels (→ page 383).

Restart the tire pressure monitoring system in the following situations:

- The tire pressure has changed.

- The wheels or tires have been changed or newly installed.

Driver's display:

→  → Service

- ▶ Select **Tire Pressure** and confirm with **OK**.
- ▶ Swipe downwards on Touch Control on the steering wheel.
The **Use current pressures as new reference values?** message is shown in the driver's display.

- ▶ Select **Yes** and confirm the restart with **OK**.
The **Tire Pressure Monitor Restarted** message is shown in the driver's display.

Current warning messages are deleted and the yellow  warning lamp goes out.

After you have been driving for a few minutes, the system checks whether the current tire pressures are within the specified range. The current tire pressures are then accepted as reference values and monitored.

If the tire pressure levels are not within the specified range, the **Please Correct Tire Pressure** message appears.

Bear in mind the following related topic:

- Notes on tire pressure (→ page 383)

Loading the vehicle

Notes on Tire and Loading Information placard

⚠ WARNING Risk of accident from overloaded tires

Overloaded tires may overheat and burst as a consequence. Overloaded tires can also impair the steering and handling characteristics and lead to brake failure.

- ▶ Observe the load rating of the tires.
- ▶ The load rating must be at least half the permissible axle load of the vehicle.
- ▶ Never overload the tires by exceeding the maximum load.

The Tire and Loading Information placard is on the B-pillar on the driver's side of the vehicle.

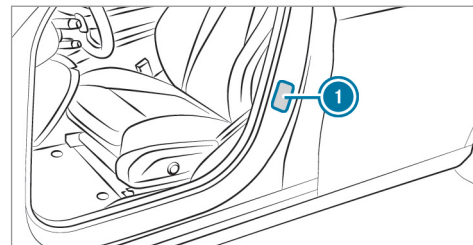

① Tire and Loading Information placard

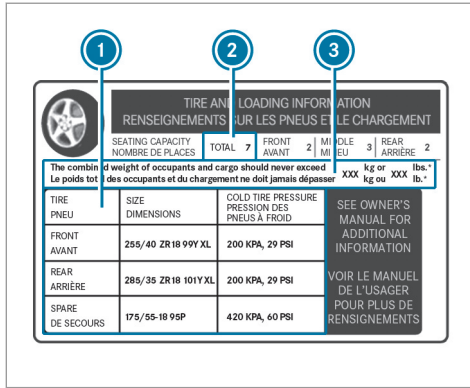

i The data shown in the illustration is example data.

The Tire and Loading Information placard shows the following information:

- Maximum number of seats **2** according to the maximum number of people permitted to travel in the vehicle.

- Maximum permissible load **3** comprises the gross weight of all vehicle occupants, load and luggage.
- Recommended tire pressure **1** for cold tires. The recommended tire pressures are valid for the maximum permissible load and up to the maximum permissible vehicle speed.

Please also note:

- Information on permissible weights and loads on the vehicle identification plate (→ page 412).
- Information on tire pressure in the tire pressure table (→ page 384).

Further related subjects:

- Determining the maximum permissible load (→ page 389)
- Notes on tire pressure (→ page 383).

Steps for Determining Correct Load Limit

The following steps have been developed as required of all manufacturers under Title 49, Code of U.S. Federal Regulations, Part 575, pursuant to

the "National Traffic and Motor Vehicle Safety Act of 1966".

- ▶ **(1):** Locate the statement "The combined weight of occupants and cargo should never exceed XXX kg or XXX lbs." on your vehicle's placard.
- ▶ **(2):** Determine the combined weight of the driver and passengers that will be riding in your vehicle.
- ▶ **(3):** Subtract the combined weight of the driver and passengers from XXX kg or XXX lbs.
- ▶ **(4):** The resulting figure equals the available amount of cargo and luggage load capacity. For example, if the "XXX" amount equals 1,400 lbs. and there will be five 150 lb passengers in your vehicle, the amount of available cargo and luggage load capacity is 650 lbs. (1,400 - 750 (5 x 150) = 650 lbs.)
- ▶ **(5):** Determine the combined weight of luggage and cargo being loaded on the vehicle. That weight may not safely exceed the available cargo and luggage load capacity calculated in Step 4.

▶ **(6):** If your vehicle will be towing a trailer, load from your trailer will be transferred to your vehicle. Consult this manual to determine how this reduces the available cargo and luggage load capacity of your vehicle.

ⓘ Not all vehicles are permitted to tow a trailer. Towing a trailer is only permitted if a trailer-hitch is installed. Please consult an authorized Mercedes-Benz dealer if you have any questions about towing a trailer with your vehicle.

Even if you have calculated the total load carefully, you should still make sure that the maximum permissible gross weight and the maximum gross axle weight rating of your vehicle are not exceeded. Details can be found on the vehicle identification plate.

Step 1

	Example 1	Example 2
Combined maximum weight of occupants and load (data from the Tire and Loading Information placard)	1500 lbs (680 kg)	1500 lbs (680 kg)

▶ Have your loaded vehicle – including driver, occupants and load – weighed on a vehicle weighbridge. The measured values may not exceed the maximum permissible values stated on the vehicle identification plate.

Further related subjects:

- Calculation example for determining the maximum load (→ page 390)
- Tire and Loading Information placard (→ page 388)
- Tire pressure table (→ page 384)
- Vehicle identification plate (→ page 412)

Calculation example for determining the maximum load

The following table shows examples of how to calculate total and load capacities with varying seating configurations and different numbers and sizes of occupants. The following examples use a maximum load of 1500 lbs (680 kg). **This is for illustration purposes only.** Make sure you are using the actual load limit for your vehicle stated on your vehicle's Tire and Loading Information placard (→ page 388).

The higher the weight of all the occupants, the smaller the maximum load for luggage.

Step 2

	Example 1	Example 2
Number of people in the vehicle (driver and occupants)	5	1
Distribution of the occupants	Front: 2 Rear: 3	Front: 1
Weight of occupants	Occupant 1: 150 lbs (68 kg) Occupant 2: 180 lbs (82 kg) Occupant 3: 160 lbs (73 kg) Occupant 4: 140 lbs (63 kg) Occupant 5: 120 lbs (54 kg)	Occupant 1: 200 lbs (91 kg)
Total weight of all occupants	750 lbs (340 kg)	200 lbs (91 kg)

Step 3

	Example 1	Example 2
Permissible load (maximum gross vehicle weight rating from the Tire and Loading Information placard minus the gross weight of all occupants)	1500 lbs (680 kg) - 750 lbs (340 kg) = 750 lbs (340 kg)	1500 lbs (680 kg) - 200 lbs (91 kg) = 1300 lbs (589 kg)

Tire labeling

Overview of tire labeling

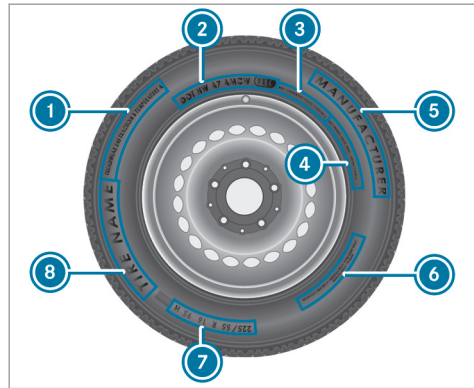

- ① Uniform Tire Quality Grading Standards
- ② DOT (Department of Transportation), (TIN) Tire Identification Number
- ③ Maximum tire load (→ page 394)
- ④ Maximum tire pressure (→ page 394)

- ⑤ Manufacturer
- ⑥ Tire characteristics (→ page 395)
- ⑦ Tire size designation, load-bearing capacity, speed rating and load index (→ page 395)
- ⑧ Tire name
- ⑨ The data shown in the illustration is example data.

Tire Quality Grading

In accordance with the US Department of Transportation's "Uniform Tire Quality Grading Standards", tire manufacturers are required to grade their tires on the basis of the following three performance factors:

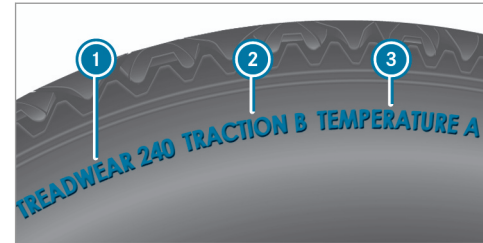

- ① Tread wear grade
- ② Traction grade
- ③ Temperature grade
- ⑨ The data shown in the illustration is example data.
- ⑨ The classification is not legally stipulated for Canada, but it is generally stated.

Tread wear grade

The treadwear grade is a comparative rating based on the wear rate of the tire when tested under controlled conditions on a specified government test course. For example, a tire graded 150 would wear one and one-half (1 1/2) times as

well on the government course as a tire graded 100.

The relative performance of tires depends upon the actual conditions of their use, however, and may depart significantly from the norm due to variations in driving habits, service practices and differences in road characteristics and climate.

Traction grade

⚠ DANGER Risk of accident due to inadequate traction

The traction grade assigned to this tire is based on straight-ahead braking traction tests.

- ▶ Always adapt your driving style and drive at a speed to suit the prevailing traffic and weather conditions.

! NOTE Damage to the drivetrain from wheelspin

- ▶ Avoid wheelspin.

The traction grades, from highest to lowest, are AA, A, B, and C. Those grades represent the tire's ability to stop on wet pavement as measured under controlled conditions on specified government test surfaces of asphalt and concrete. A tire marked C may have poor traction performance.

Temperature grade

⚠ WARNING Risk of accident from tire overheating and tire failure

Excessive speed, underinflation, or excessive loading, either separately or in combination, can cause excessive heat build-up and possible tire failure.

- ▶ Observe the recommended tire pressure.
- ▶ Regularly check the pressure of all the tires.
- ▶ Adjust the tire pressure, if necessary.

The temperature grades are A (the highest), B, and C, representing the tire's resistance to the generation of heat and its ability to dissipate heat when tested under controlled conditions on a specified indoor laboratory test wheel. Sustained

high temperature can cause the material of the tire to degenerate and reduce tire life, and excessive temperature can lead to sudden tire failure. The grade C corresponds to a level of performance which all passenger car tires must meet under the Federal Motor Safety Standard No. 109. Grades B and A represent higher levels of performance on the laboratory test wheel than the minimum required by law.

DOT, Tire Identification Number (TIN)

US tire regulations stipulate that every tire manufacturer or retreader must imprint a TIN in or on the side wall of each tire produced.



i The data shown in the image is example data. The TIN is a unique identification number to identify tires and comprises the following:

- **DOT (Department of Transportation):** tire symbol marks **1** indicating that the tire complies with the requirements of the US Department of Transportation.
- **Manufacturer identification code:** manufacturer identification code **2** contains details of the tire manufacturer. New tires have a code with two symbols. Retreaded tires have a code with four symbols. Further information on retreaded tires (→ page 399).
- **Tire size:** identifier **3** describes the tire size.
- **Tire type code:** tire type code **4** can be used by the manufacturer as a code to describe specific characteristics of the tire.
- **Manufacturing date:** manufacturing date **5** provides information about the age of a tire. The 1st and 2nd positions represent the calendar week and the 3rd and 4th positions state the year of manufacture (e.g. "3208" represents the 32nd week of 2008).

Information on the maximum tire load

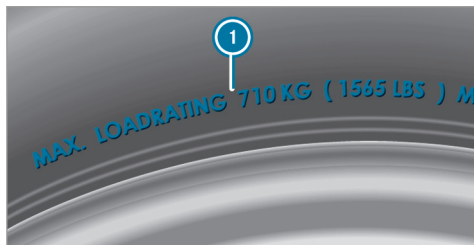

i The data shown in the image is example data. Maximum tire load **1** is the maximum permissible weight for which the tire is approved.

Do not overload the tires by exceeding the specified load limit. The maximum permissible load can be found on the vehicle's Tire and Loading Information placard on the B-pillar on the driver's side (→ page 388).

Specifications for maximum tire pressure

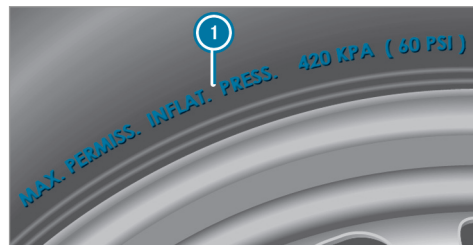

i The data shown in the illustration is example data.

Never exceed maximum tire pressure **1** specified for the tire. Always observe the recommended tire pressure for your vehicle when adjusting the tire pressure (→ page 384).

Information on tire characteristics

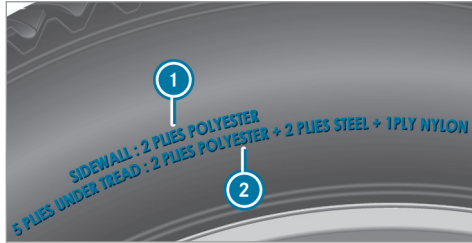

i The data shown in the image is example data. This information describes the type of tire cord and the number of layers in side wall **1** and under tire tread **2**.

Tire size designation, load-bearing capacity, speed rating and load index

⚠ WARNING Risk of injury through exceeding the specified tire load-bearing capacity or the permissible speed rating

Exceeding the specified tire load rating or the permissible speed rating may lead to tire damage and to the tires bursting.

- ▶ Therefore, only use tire types and sizes approved for your vehicle model.
- ▶ Observe the tire load rating and speed rating required for your vehicle.

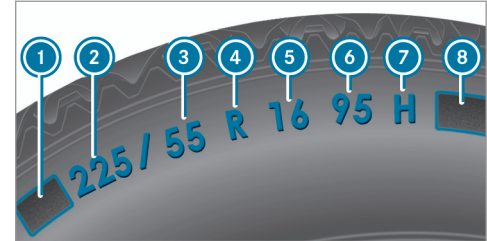

- 1** First letter(s)
- 2** Nominal tire width in millimeters
- 3** Aspect ratio in %
- 4** Tire code
- 5** Rim diameter
- 6** Load-bearing index
- 7** Speed rating
- 8** Load index

i The data shown in the illustration is example data.

Information about reading tire data can be obtained from any qualified specialist workshop.

First letter(s) 1:

- Without: passenger vehicle tires according to European manufacturing standards.
- "P": passenger vehicle tires according to US manufacturing standards.
- "LT": light truck tires according to US manufacturing standards.
- "T": compact emergency spare wheels with high tire pressure that are only designed for temporary use in an emergency.

Aspect ratio 3:

Ratio between tire height and tire width in percent (tire height divided by tire width).

Tire code 4 (tire type):

- "R" radial tire
- "D": bias ply tire
- "B": bias belted tires
- "ZR": radial tire with a maximum speed above 149 mph (240 km/h) (optional)

Rim diameter 5:

The diameter of the bead seat (not the diameter of the rim flange). The rim diameter is specified in inches (in).

Load-bearing index 6:

Numerical code that specifies the maximum load-bearing capacity of a tire (e.g. "91" corresponds to 1356 lbs (615 kg)).

The load-bearing capacity of the tire must be at least half the gross axle weight rating of your vehicle. Do not overload the tires by exceeding the specified load limit.

See also:

- Maximum permissible load on the Tire and Loading Information placard (→ page 388)
- Maximum tire load (→ page 394)
- Load index

Speed rating 7:

Specifies the approved maximum speed of the tire.

- **i** An electronic speed limiter prevents your vehicle from exceeding a speed of 130 mph (210 km/h).

Make sure that your tires have the required speed rating. You can obtain information on the required speed rating from an authorized Mercedes-Benz Center.

Summer tires

Index	Speed rating
Q	up to 100 mph (160 km/h)
R	up to 106 mph (170 km/h)
S	up to 112 mph (180 km/h)
T	up to 118 mph (190 km/h)
H	up to 130 mph (210 km/h)
V	up to 149 mph (240 km/h)
W	up to 168 mph (270 km/h)
Y	up to 186 mph (300 km/h)

Index	Speed rating
ZR...Y ¹	up to 186 mph (300 km/h)
ZR...(..Y) ¹	over 186 mph (300 km/h)
ZR ¹	over 149 mph (240 km/h)

- Specifying the speed rating as the "ZR" index in tire code ④ is optional for tires up to 186 mph (300 km/h).
- If your tire code ④ includes "ZR" and there is no speed rating ⑦, find out what the maximum speed is from the tire manufacturer.
- If load-bearing index ⑥ and speed rating ⑦ are in brackets, the maximum speed rating of your tire is above 186 mph (300 km/h). To find out the maximum speed, ask the tire manufacturer.

¹ "ZR" stated in the tire code.

² Or "M+S"  " for winter tires.

All-weather tires and winter tires

Index	Speed rating
Q M+S ²	up to 100 mph (160 km/h)
T M+S ²	up to 118 mph (190 km/h)
H M+S ²	up to 130 mph (210 km/h)
V M+S ²	up to 149 mph (240 km/h)

Winter tires bear the  snowflake symbol and fulfill the requirements of the Rubber Manufacturers Association (RMA) and the Rubber Association of Canada (RAC) regarding the tire traction on snow.

Load index ⑧:

- No specification given: standard load (SL) tire
- "XL" or "Extra Load": extra load tire or reinforced tire
- "Light Load": light load tire

- "C", "D", "E": a load range that depends on the maximum load that the tire can carry at a certain pressure

Definition of terms for tires and loading

Tire structure and characteristics: describes the number of layers or the number of rubber-coated belts in the tire contact surface and the tire wall. These are made of steel, nylon, polyester and other materials.

Bar: metric unit for tire pressure. 14.5038 pounds per square inch (psi) and 100 kilopascal (kPa) is the equivalent of one bar.

DOT (Department of Transportation): DOT-marked tires fulfill the requirements of the US Department of Transportation.

Average weight of the vehicle occupants: the number of vehicle occupants for which the vehicle is designed, multiplied by 150 lb (68 kg).

Uniform Tire Quality Grading Standards: a uniform standard to grade the quality of tires with regard

to tread quality, tire traction and temperature characteristics. The quality grading assessment is made by the manufacturer following specifications from the U.S. government. The quality grade of a tire is imprinted on the side wall of the tire.

Recommended tire pressure: the recommended tire pressure is the tire pressure specified for the tires mounted to the vehicle at the factory.

The tire and information table contains the recommended tire pressures for cold tires, the maximum permissible load and the maximum permissible vehicle speed.

The tire pressure table contains the recommended tire pressures for cold tires under various operating conditions, i.e. loading and/or speed of the vehicle.

Increased vehicle weight due to optional equipment: the combined weight of all standard and optional equipment available for the vehicle, regardless of whether it is actually installed on the vehicle or not.

Rim: the part of the wheel on which the tire is installed.

GAWR (Gross Axle Weight Rating): the GAWR is the maximum permissible axle load. The actual load on an axle must never exceed the gross axle weight rating. The gross axle weight rating can be found on the vehicle identification plate on the B-pillar on the driver's side.

Speed rating: the speed rating is part of the tire identification. It specifies the speed range for which a tire is approved.

GVW (Gross Vehicle Weight): the gross vehicle weight comprises the weight of the vehicle including fuel, tools, the spare wheel, accessories installed, occupants, luggage and the trailer drawbar noseweight, if applicable. The gross vehicle weight must not exceed the gross vehicle weight rating GVWR as specified on the vehicle identification plate on the B-pillar on the driver's side.

GVWR (Gross Vehicle Weight Rating): the GVWR is the maximum permitted gross weight of the fully laden vehicle (weight of the vehicle including all accessories, occupants, fuel, luggage and the trailer drawbar noseweight if applicable). The gross vehicle weight rating is specified on the vehicle identification plate on the B-pillar on the driver's side.

Maximum weight of the laden vehicle: the maximum weight is the sum of the curb weight of the vehicle, the weight of the accessories, the maximum load and the weight of optional equipment installed at the factory.

Kilopascal (kPa): metric unit for tire pressure. 6.9 kPa corresponds to 1 psi. Another unit for tire pressure is bar. 100 kilopascal (kPa) equals 1 bar.

Load index: in addition to the load-bearing index, the load index may also be imprinted on the side wall of the tire. This specifies the load-bearing capacity of the tire more precisely.

Curb weight: the weight of a vehicle with standard equipment including the maximum capacity of fuel, oil and coolant. It also includes the air conditioning system and optional equipment if these are installed on the vehicle, but does not include passengers or luggage.

Maximum tire load: the maximum tire load is the maximum permissible weight in kilograms or lbs for which a tire is approved.

Maximum permissible tire pressure: maximum permissible tire pressure for one tire.

Maximum load on one tire: maximum load on one tire. This is calculated by dividing the maximum axle load of one axle by two.

PSI (pounds per square inch): standard unit of measurement for tire pressure.

Aspect ratio: ratio between tire height and tire width in percent.

Tire pressure: pressure inside the tire applying an outward force to every square inch of the tire. The tire pressure is specified in pounds per square inch (psi), in kilopascals (kPa) or in bar. The tire pressure should only be corrected when the tires are cold.

Cold tire pressure: the tires are cold when the vehicle has been parked for at least 3 hours without direct sunlight on the tires or the vehicle has been driven for less than 1 mile (1.6 km).

Tire contact surface: the part of the tire that comes into contact with the road.

Tire bead: the purpose of the tire bead is to ensure that the tire sits securely on the wheel rim. There are several wire cores in the tire bead to prevent the tire from changing length on the wheel rim.

Side wall: the part of the tire between the tread and the tire bead.

Weight of optional equipment: the combined weight of the optional equipment weighing more than the replaced standard parts and more than 5 lbs (2.3 kg). This optional equipment, such as high-performance brakes, level control system, a roof luggage rack or high-performance batteries, is not included in the curb weight and the weight of the accessories.

TIN (Tire Identification Number): a unique identification number which can be used by a tire manufacturer to identify tires, for example, in a product recall, and thus identify the purchasers. The TIN is made up of the manufacturer's identity code, tire size, tire type code and the manufacturing date.

Load-bearing index: the load-bearing index is a code that contains the maximum load-bearing capacity of a tire.

Traction: traction is the grip resulting from friction between the tires and the road surface.

Wear indicator: narrow bars (tread wear bars) that are distributed over the tire contact surface. If the

tire tread is level with the bars, the wear limit of 1/16 in (1.6 mm) has been reached.

Distribution of vehicle occupants: distribution of vehicle occupants over designated seat positions in a vehicle.

Maximum permissible payload weight: nominal load and luggage load plus 150 lb (68 kg) multiplied by the number of seats in the vehicle.

Changing a wheel

Notes on selecting, installing and replacing tires

! **NOTE** Mercedes-AMG vehicles

▶ Observe the notes in the Supplement. You could otherwise fail to recognize dangers.

⚠ **WARNING** Risk of accident due to incorrect wheel and tire dimensions

If wheels and tires of the wrong size are installed, the service brakes or components in the

brake system and in the wheel suspension may be damaged.

- ▶ Always replace wheels and tires with ones that fulfill the specifications of the original part.

For wheels, pay attention to the following:

- Designation
- Type

For tires, pay attention to the following:

- Designation
- Manufacturer
- Type

⚠ WARNING Risk of injury through exceeding the specified tire load-bearing capacity or the permissible speed rating

Exceeding the specified tire load rating or the permissible speed rating may lead to tire damage and to the tires bursting.

▶ Therefore, only use tire types and sizes approved for your vehicle model.

▶ Observe the tire load rating and speed rating required for your vehicle.

! NOTE Vehicle and tire damage through tire types and sizes that have not been approved

For safety reasons, only use tires, wheels and accessories which have been specially approved by Mercedes-Benz for your vehicle. These tires are specially adapted to the active safety systems, such as ABS, ESP® and 4MATIC, and marked as follows:

- MO = Mercedes-Benz Original
- MOE = Mercedes-Benz Original Extended (run-flat tire only for certain wheels)
- MO1 = Mercedes-Benz Original (only certain AMG tires)

Otherwise, certain properties, such as handling characteristics, vehicle noise emissions, consumption, etc. could be adversely affected.

Furthermore, other tire sizes could result in the tires rubbing against the body and axle components when loaded. This could result in damage to the tire or the vehicle.

Only use tires, wheels and accessories that have been checked and recommended by Mercedes-Benz.

! NOTE Risk to driving safety from retreaded tires

Retreaded tires are neither tested nor recommended by Mercedes-Benz, since previous damage cannot always be detected on retreaded tires.

For this reason driving safety cannot be guaranteed.

▶ Do not use used tires if you have no information about their previous usage.

- !** **NOTE** Possible wheel and tire damage when driving over obstacles

Large wheels have a smaller section width. As the section width decreases, the risk of wheels and tires being damaged when driving over obstacles increases.

- ▶ Avoid obstacles or drive especially carefully.
- ▶ Reduce your speed when driving over curbs, speed bumps, manhole covers and potholes.
- ▶ Avoid particularly high curbs.

- !** **NOTE** Possible wheel and tire damage when parking on curbs or in potholes

Parking on curbs or in potholes may damage the wheels and tires.

- ▶ If possible, park only on flat surfaces.
- ▶ Avoid curbs and potholes when parking.

- !** **NOTE** Damage to electronic component parts from the use of tire-mounting tools

Vehicles with a tire pressure monitoring system: Electronic component parts are located in the wheel. Tire-mounting tools should not be used in the area of the valve.

This could otherwise damage the electronic component parts.

- ▶ Have the tires changed at a qualified specialist workshop only.

- !** **NOTE** Damage to summer tires at low ambient temperatures

At low ambient temperatures, tears could form when driving with summer tires, causing permanent damage to the tires.

- ▶ At temperatures below 45 °F (7 °C) use  M+S tires.

Accessory parts which are not approved for your vehicle by Mercedes-Benz, or which are not used correctly, can impair the operating safety.

Before purchasing and using non-approved accessories, visit a qualified specialist workshop and inquire about:

- Suitability
- Legal stipulations
- Factory recommendations

- !** **WARNING** Risk of accident with high performance tires

The special tire tread in combination with the optimized tire compound means that the risk of skidding and hydroplaning on wet roads is increased.

In addition, the tire grip is greatly reduced at a low outside temperature and tire running temperature.

- ▶ Switch on the ESP® and adapt your driving style accordingly.
- ▶ Use  M+S tires at outside temperatures of less than 50 °F (10 °C).
- ▶ Only use the tires for their intended purpose.

Observe the following when selecting, installing and replacing tires:

- Furthermore, the use of certain tire types in certain regions and areas of operation can be highly beneficial.
- Only use tires and wheels of the same type (summer tires, winter tires, MOExtended tires) and the same make.
- Only install wheels of the same size on one axle (left and right).

It is only permissible to install a different wheel size in the event of a flat tire in order to drive to the specialist workshop.

- **Vehicles with a tire pressure monitoring system:** All installed wheels must be equipped with functioning sensors for the tire pressure monitoring system.
- At temperatures below 45 °F (7 °C) use winter tires or all-season tires marked  M+S for all wheels.

Winter tires provide the best possible grip in wintry road conditions.

- For M+S tires, only use tires with the same tread.
- Observe the maximum permissible speed for the M+S tires installed.
If the tire's maximum speed is below that of the vehicle, this must be indicated by an appropriate label in the driver's field of vision.
- Break in new tires at moderate speeds for the first 60 miles (100 km).
- Replace the tires after six years at the latest, regardless of wear.
- **When replacing with tires that do not feature run-flat characteristics:** vehicles with MOExtended tires are not equipped with a TIREFIT kit at the factory. Equip the vehicle with a TIREFIT kit after replacing with tires that do not feature run-flat characteristics, e.g. winter tires.

For more information on wheels and tires, contact a qualified specialist workshop.

Be sure to also observe the following further related subjects:

- Notes on tire pressure (→ page 383)

- Tire and Loading Information placard (→ page 388)
- Tire size designation, load-bearing capacity, speed rating and load index (→ page 395)
- Tire pressure table (→ page 384)
- Notes on the emergency spare wheel (→ page 408)

Notes on rotating the wheels

 **WARNING** Risk of injury through different wheel sizes

Rotating the front and rear wheels can severely impair the driving characteristics. The wheel brakes or suspension components may also be damaged.

 Rotate front and rear wheels only if the wheels and tires are of the same dimensions.

The wear patterns on the front and rear wheels differ:

- Front wheels wear more on the tire shoulder

- Rear wheels wear more in the center of the tire

Do not drive with tires that have too little tread depth. This significantly reduces traction on wet roads (hydroplaning).

On vehicles that have the same size front and rear wheels, rotate the wheels according to the intervals in the tire manufacturer's warranty book in your vehicle documents. If this is not available, rotate the tires every 3,000 to 6,000 miles (5,000 to 10,000 km), depending on the wear. Ensure that the direction of rotation is maintained.

Observe the instructions and safety notes on "Changing a wheel" when doing so (→ page 404).

Notes on storing wheels

When storing wheels, observe the following notes:

- After removing wheels, store them in a cool, dry and preferably dark place.
- Protect the tires from contact with oil, grease or fuel.

Overview of the tire-change tool kit

! NOTE Mercedes-AMG vehicles

- ▶ Observe the notes in the Supplement. You could otherwise fail to recognize dangers.

Apart from some country-specific variants, vehicles are not equipped with a tire-change tool kit. For more information on which tire-changing tools are required and approved for performing a wheel change on your vehicle, consult a qualified specialist workshop.

You require the following tools, for example, to change a wheel:

- Jack
- Chock
- Lug wrench
- Alignment bolt

The tire-change tool kit is located in tool bag ① in the trunk.

- ① Depending on the vehicle equipment, the tool bag may be located at other positions in the trunk.

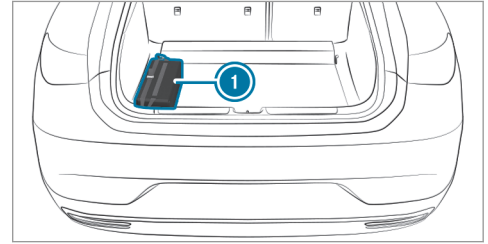

The tool bag contains:

- Jack
- Gloves
- Lug wrench
- Alignment bolt
- Folding chock
- Ratchet for jack

Preparing the vehicle for a wheel change

Requirements:

- The vehicle is not on a slope.
- The vehicle is on solid, non-slippery and level ground.
- The required tire-change tool kit is available.

i If your vehicle is not equipped with the tire-change tool kit, consult a qualified specialist workshop to find out about suitable tools.

▶ Apply the electric parking brake manually.

▶ Move the front wheels to the straight-ahead position.

▶ Shift the transmission to position **P**.

▶ **Vehicles with AIRMATIC:** Set the raised vehicle level for greater ground clearance (→ page 259).

▶ Switch off the vehicle.

▶ Make sure that the vehicle cannot be started.

▶ Place chocks or other suitable items under the front and rear of the wheel that is diagonally opposite the wheel you wish to change.

▶ Unload the vehicle.

Raising the vehicle when changing a wheel

Requirements:

- There are no persons in the vehicle.
- The vehicle has been prepared for a wheel change (→ page 404).

Important notes on using the jack:

- Use only a vehicle-specific jack that has been approved by Mercedes-Benz to raise the vehicle.
- The jack is only designed for raising and holding the vehicle for a short time while a wheel is being changed and not for maintenance work under the vehicle.
- The jack must be placed on a firm, flat and non-slip surface. If necessary, use a large, flat, load-bearing, non-slip underlay.
- The foot of the jack must be positioned vertically under the jack support point.

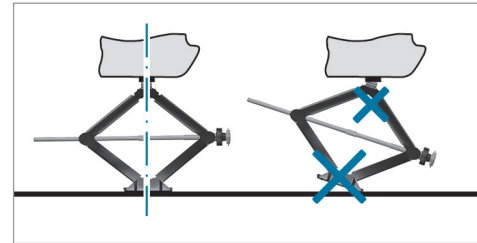

Rules of conduct when the vehicle is raised:

- Never place your hands or feet under the vehicle.
- Never lie under the vehicle.
- Do not start the vehicle and do not release the electric parking brake.
- Do not open or close any doors or the tailgate.

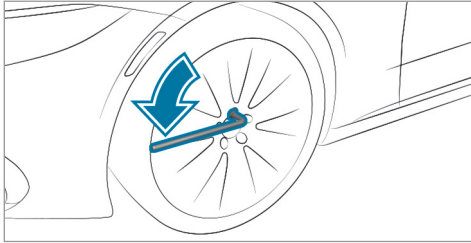

- ▶ Using the lug wrench, loosen the wheel bolts on the wheel you wish to change by about one full turn. Do not unscrew the screws completely.

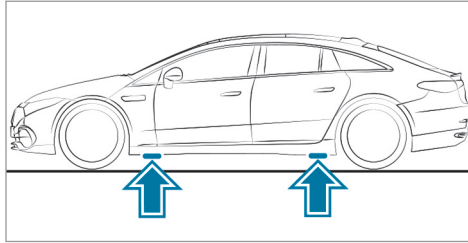

Position of jack support points

! **NOTE** Mercedes-AMG vehicles

- ▶ Observe the notes in the Supplement. You could otherwise fail to recognize dangers.

! **WARNING** Risk of injury from incorrect positioning of the jack

If you do not position the jack correctly at the appropriate jacking point of the vehicle, the jack could tip with the vehicle raised.

- ▶ Only position the jack at the appropriate jacking point of the vehicle. The base of

the jack must be positioned vertically under the jacking point of the vehicle.

! **NOTE** Damage to the vehicle due to using an unsuitable jack

You can damage the vehicle and, in particular the high-voltage battery, if you use a jack that is not specifically designed for the jack support points of the vehicle.

- ▶ Only use jacks that are specifically designed for the jack support points, or use an appropriate adapter.

! **NOTE** Risk of damage to the vehicle due to incorrect positioning of the jack

If you do not position the jack at the designated jack support points, you could damage your vehicle and, in particular, the high-voltage battery.

- ▶ Only position the jack at the designated jack support points.

- ▶ Take the ratchet out of the tire-change tool kit and place it on the hexagon nut of the jack so that the letters "AUF" are visible.

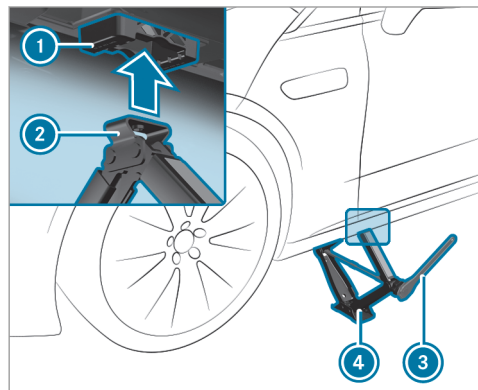

- ▶ Position support ② of jack ④ on jack support point ①.
- ▶ Turn ratchet ③ clockwise until support ② sits completely on jack support point ① and the base of the jack lies evenly on the ground.

- ▶ Turn ratchet ③ until the tire is raised a maximum of 1.2 in (3 cm) from the ground.
- ▶ Loosen and remove the wheel (→ page 406).

Removing a wheel

Requirements:

- The vehicle is raised.

! NOTE Mercedes-AMG vehicles

- ▶ Observe the notes in the Supplement. You could otherwise fail to recognize dangers.

When changing a wheel, avoid applying any force to the brake discs, as this could impair the level of comfort when braking.

! NOTE Damage to threading from dirt on wheel bolts

- ▶ Do not place wheel bolts in sand or on a dirty surface.

- ▶ Unscrew the uppermost wheel bolt completely.

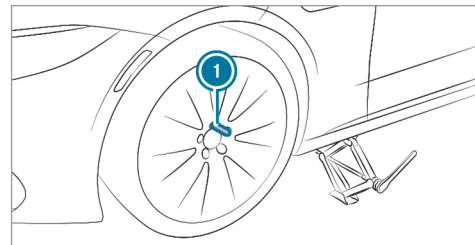

- ▶ Screw alignment bolt ① into the thread instead of the wheel bolt.
- ▶ Unscrew the remaining wheel bolts completely.
- ▶ Remove the wheel.

Installing a new wheel

! NOTE Mercedes-AMG vehicles

- ▶ Observe the notes in the Supplement. You could otherwise fail to recognize dangers.

! WARNING Risk of accident from losing a wheel

Oiled, greased or damaged wheel bolt/wheel nut threads or wheel hub/wheel mounting bolt threads can cause the wheel bolts/wheel nuts to come loose.

- ▶ Never oil or grease the threads.
- ▶ In the event of damage to the threads, contact a qualified specialist workshop immediately.
- ▶ Have the damaged wheel bolts or damaged hub threads replaced.
- ▶ Do not continue driving.

- ▶ Observe the information on the choice of tires (→ page 399).

For tires with a specified direction of rotation, an arrow on the side wall of the tire indicates the correct direction of rotation. Observe the direction of rotation when installing.

- ▶ Slide the wheel to be mounted onto the alignment bolt and push it on.

! WARNING Risk of injury from tightening wheel bolts and nuts

If you tighten the wheel bolts or wheel nuts when the vehicle is raised, the jack could tip.

- ▶ Only tighten wheel bolts or wheel nuts when the vehicle is on the ground.
- ▶ Be sure to observe the instructions and safety notes on "Changing a wheel" (→ page 399).
- ▶ For safety reasons, only use wheel bolts which have been approved by Mercedes-Benz and for the wheel in question.

! NOTE Damage to paintwork of the wheel rim when screwing in the first wheel bolt

If the wheel has too much play when screwing in the first wheel bolt, the wheel rim paint can be damaged.

- ▶ Press the wheel firmly against the wheel hub when screwing in the first wheel bolt.

- ▶ Tighten the wheel bolts evenly in a diagonal pattern in the order indicated until they are finger-tight.
- ▶ Unscrew and remove the alignment bolt.
- ▶ Tighten the last wheel bolt until it is finger-tight.
- ▶ Lower the vehicle (→ page 407).

Lowering the vehicle after a wheel change

Requirements:

- The new wheel has been installed (→ page 407).

NOTE Risk of vehicle jack becoming trapped by the AIRMATIC system

If the AIRMATIC system has released air when raising the vehicle, the jack can become trapped when the vehicle is lowered.

- ▶ Start the drive system. This adapts the vehicle level.
- ▶ Remove the jack from under the vehicle.

▶ **To lower the vehicle:** place the ratchet onto the hexagon nut of the jack so that the letters "AB" are visible and turn counter-clockwise.

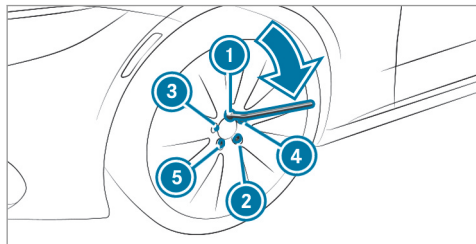

- ▶ Tighten the wheel bolts evenly in a diagonal pattern in the order indicated ① to ⑤ with an initial maximum force of 59 lb-ft (80 Nm).
- ▶ Tighten the wheel bolts evenly in a diagonal pattern in the order indicated ① to ⑤ with the specified tightening torque of 111 lb-ft (150 Nm).

WARNING Risk of accident due to incorrect tightening torque

The wheels could come loose if the wheel bolts or wheel nuts are not tightened to the prescribed torque.

- ▶ Ensure that the wheel bolts or wheel nuts are tightened to the prescribed tightening torque.
- ▶ If you are not sure, do not move the vehicle. Contact a qualified specialist workshop and have the tightening torque checked immediately.
- ▶ Check the tire pressure of the newly installed wheel and adjust it if necessary.

ⓘ The following does not apply if the new wheel is an emergency spare wheel.

▶ **Vehicles with a tire pressure monitoring system:** Restart the tire pressure monitoring system (→ page 387).

Emergency spare wheel

Notes on the emergency spare wheel

WARNING Risk of accident caused by incorrect wheel and tire dimensions

The wheel or tire sizes and the tire type of the emergency spare wheel or spare wheel and the wheel to be replaced may differ. The emergency spare wheel or spare wheel can significantly impair driving characteristics of the vehicle.

To prevent hazardous situations:

- ▶ Drive carefully.
- ▶ Never install more than one emergency spare wheel or spare wheel that differs in size.

- ▶ Only use an emergency spare wheel or spare wheel briefly.
- ▶ Do not deactivate ESP®.
- ▶ Have the emergency spare wheel or spare wheel of a different size replaced at the nearest qualified specialist workshop. The new wheel must have the correct dimensions.

Observe the following notes on installing an emergency spare wheel:

- The maximum permissible speed with an emergency spare wheel installed is 50 mph (80 km/h).
- Do not equip the emergency spare wheel with snow chains.
- Replace the emergency spare wheel after six years at the latest, regardless of wear.
- Use the wheel bolts that are included with the emergency spare wheel.

Specified tightening torque: 96 lb-ft (130 Nm)

- Check the tire pressure of the emergency spare wheel installed. Correct the pressure as necessary.
- ⓘ The specified tire pressure is stated on the label of the emergency spare wheel.
- ⓘ **Vehicles with a tire pressure monitoring system:** If an emergency spare wheel is installed, the tire pressure monitoring system cannot function reliably. For a few minutes after an emergency spare wheel is installed, the system may still display the tire pressure of the removed wheel. Only restart the system again when the emergency spare wheel has been replaced with a new wheel.

Be sure to also observe the following further related subjects:

- Notes on tire pressure (→ page 383)
- Tire and Loading Information placard (→ page 388)
- Tire pressure table (→ page 384)
- Notes on installing tires (→ page 399)
- Installing an emergency spare wheel (→ page 404)

Notes on technical data

! NOTE Mercedes-AMG vehicles

- ▶ Observe the notes in the Supplement. You could otherwise fail to recognize dangers.

The data stated only applies to vehicles with standard equipment. You can obtain further information from an authorized Mercedes-Benz Center.

Vehicle electronics

Two-way radios

Notes on installing two-way radios

! WARNING Risk of accident due to improper work on two-way radios

If two-way radios are manipulated or retrofitted incorrectly, the electromagnetic radiation from the two-way radios can interfere with the vehicle electronics and jeopardize the operating safety of the vehicle.

- ▶ You should have all work on electrical and electronic components carried out at a qualified specialist workshop.

! WARNING Risk of accident due to improper operation of two-way radios

If you use two-way radios in the vehicle improperly, their electromagnetic radiation can disrupt the vehicle's electronics. This is the case in the following situations, in particular:

- The two-way radio is not connected to an exterior antenna.
- The exterior antenna is installed incorrectly or is not a low-reflection antenna.

This could jeopardize the operating safety of the vehicle.

- ▶ Have the low-reflection exterior antenna installed at a qualified specialist workshop.

- ▶ When operating two-way radios in the vehicle, always connect them to the low-reflection exterior antenna.

! NOTE Invalidation of the operating permit due to failure to comply with the instructions for installation and use

The operating permit may be invalidated if the instructions for installation and use of two-way radios are not observed.

- ▶ Only use approved frequency bands.
- ▶ Observe the maximum permissible output power in these frequency bands.
- ▶ Only use approved antenna positions.

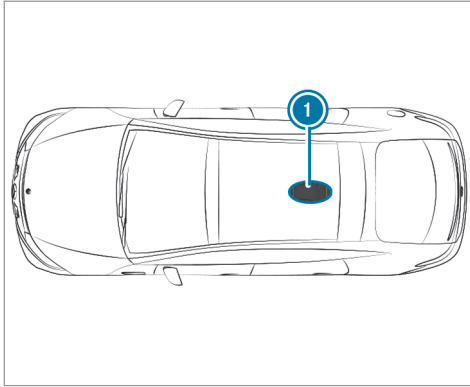

① Rear roof area

On vehicles with a panoramic sliding sunroof, installing an antenna is not permitted.

Use Technical Specification ISO/TS 21609 (Road Vehicles - "EMCs for installation of aftermarket radio frequency transmitting equipment") when retrofitting two-way radios. Comply with the legal requirements for detachable parts.

If your vehicle has installing for two-way radio equipment, use the power supply and antenna connectors provided in the pre-installation. Observe the manufacturer's supplements when installing.

Two-way radio transmission output

The maximum transmission output (PEAK) at the base of the antenna must not exceed the values in the following table.

Frequency band and maximum transmission output

Frequency band	Maximum transmission output
2 m frequency band 144 - 174 MHz	50 W
Terrestrial Trunked Radio (TETRA) 380 - 460 MHz	10 W
70 cm frequency band 430 - 470 MHz	35 W

Frequency band	Maximum transmission output
Two-way radio 2G	2 W
Two-way radio 3G/4G/5G	0.5 W

The following devices can be used in the vehicle without restrictions:

- Two-way radios with a maximum transmission output of up to 100 mW
- Two-way radios with transmitter frequencies in the 380 - 420 MHz frequency band and a maximum transmission output of up to 2 W (TETRA)
- Mobile phones (2G/3G/4G/5G)

There are no restrictions when positioning the antenna on the outside of the vehicle for the following frequency bands:

- TETRA
- 2G/3G/4G/5G

Regulatory radio identification and notes

Regulatory radio identification of small components

Manufacturer information about radio-based vehicle components can be found using the key phrase "Regulatory radio identification" in the Digital Operator's Manual in the vehicle, on the Internet and in the app.

Regulatory radio identification - Indonesia

Manufacturer information about radio-based vehicle components can be found using the key phrase "Regulatory radio identification - Indonesia" in the Digital Operator's Manual in the vehicle, on the Internet and in the app.

- ⓘ These are not small components. Information about small components can be found using the key phrase "Regulatory radio identification of small components".

Information on installation clearances

Information on installation clearances of wireless vehicle components can be found using the key phrase "Installation clearances" in the Digital Operator's Manual in the vehicle, on the Internet, and in the app.

Further component-specific information

Further component-specific information can be found using the key phrase "further component-specific information" in the Digital Operator's Manual in the vehicle, on the Internet and in the app.

Vehicle identification plate, VIN and engine number overview

Vehicle identification plate

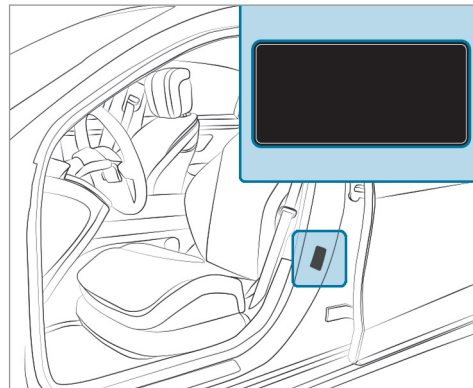

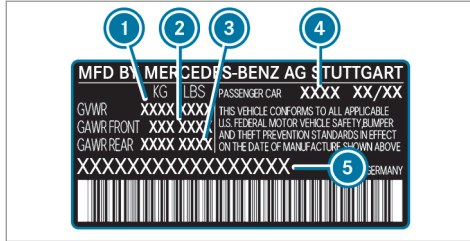

Vehicle identification plate (USA only)

- ① Maximum permissible gross vehicle weight
- ② Maximum permissible front axle load
- ③ Maximum permissible rear axle load
- ④ Paint code
- ⑤ VIN (vehicle identification number)

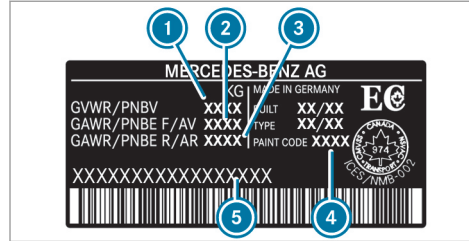

Vehicle identification plate (Canada only)

- ① Maximum permissible gross vehicle weight
- ② Maximum permissible front axle load
- ③ Maximum permissible rear axle load
- ④ Paint code
- ⑤ VIN (vehicle identification number)

The permissible gross vehicle weight is made up of the vehicle weight, all vehicle occupants and the load. The maximum gross axle weight rating is the maximum weight that can be carried on one axle (front or rear axle).

Do not exceed the maximum permissible gross vehicle weight or the maximum gross axle weight rating for the front or rear axle.

VIN below the front right-hand seat

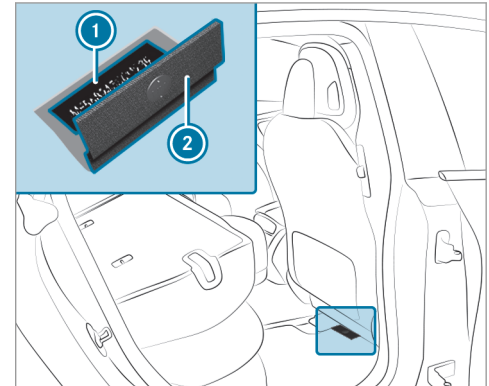

- ① Imprinted VIN (vehicle identification number)
- ② Floor covering

VIN at the lower edge of the windshield

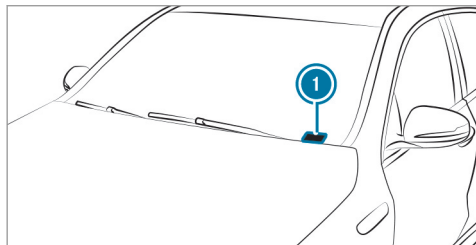

- ① VIN (vehicle identification number) as label

Operating fluids

Notes on operating fluids

⚠ WARNING Risk of injury from operating fluids harmful to your health

Operating fluids may be poisonous and harmful to your health.

- ▶ Observe the text on the original containers when using, storing or disposing of operating fluids.
- ▶ Always store operating fluids sealed in their original containers.
- ▶ Always keep children away from operating fluids.

🔥 ENVIRONMENTAL NOTE Pollution of the environment due to irresponsible disposal of operating fluids

Incorrect disposal of operating fluids can cause considerable damage to the environment.

- ▶ Dispose of operating fluids in an environmentally responsible manner.

Operating fluids include the following:

- Lubricants
- Coolant
- Brake fluid
- Windshield washer fluid

- Climate control system refrigerant

Only use products approved by Mercedes-Benz. Damage caused by the use of products that have not been approved is not covered by the Mercedes-Benz warranty or goodwill gestures.

You can identify operating fluids approved by Mercedes-Benz by the following inscriptions on the container:

- MB-Freigabe (e.g. MB-Freigabe 229.51)
- MB-Approval (e.g. MB-Approval 229.51)

Further information on approved operating fluids is available at the following locations:

- In the Mercedes-Benz Specifications for Operating Fluids by entering the designation
 - At <https://bevo.mercedes-benz.com>
 - In the Mercedes-Benz BeVo app
- At a qualified specialist workshop

Notes on brake fluid

Note the instructions about operating fluids (→ page 414).

⚠ WARNING Risk of an accident due to vapor pockets forming in the brake system

The brake fluid constantly absorbs moisture from the air. This lowers the boiling point of the brake fluid. If the boiling point is too low, vapor pockets may form in the brake system when the brakes are applied hard.

This causes the braking effect to be impaired.

- ▶ Have the brake fluid renewed at the specified intervals.

Have the brake fluid replaced regularly at a qualified specialist workshop.

Only use a brake fluid approved by Mercedes-Benz according to MB-Freigabe or MB-Approval 331.0.

Coolant

Notes on coolant

Observe the notes on operating fluids (→ page 414).

⚠ WARNING Risk of fire- and injury from antifreeze

If antifreeze comes into contact with hot component parts in the engine compartment, it may ignite.

- ▶ Allow the drive system to cool down before you add antifreeze.
- ▶ Make sure that no antifreeze spills out next to the filler opening.
- ▶ Thoroughly clean the antifreeze from component parts before starting the vehicle.

! NOTE Damage caused by incorrect coolant

- ▶ Only use coolant that has been premixed with the required antifreeze protection.

Information on coolant is available at the following locations:

- In the Mercedes-Benz Specification for Operating Fluids 320.1

- At <https://bevo.mercedes-benz.com>
- In the Mercedes-Benz BeVo app
- At a qualified specialist workshop

! NOTE Overheating at high outside temperatures

If an inappropriate coolant is used, the engine cooling system is not sufficiently protected against overheating and corrosion at high outside temperatures.

- ▶ Only use coolant approved by Mercedes-Benz.
- ▶ Observe the instructions in the Mercedes-Benz Specifications for Operating Fluids 320.1.

Have the coolant regularly replaced at a qualified specialist workshop.

Proportion of antifreeze concentrate in the engine cooling system:

- A minimum of 50% (antifreeze protection down to about -35°F (-37°C))

416 Technical data

- A maximum of 55% (antifreeze protection down to -49°F (-45°C))

Coolant capacity

Missing values were not available at the time of going to press.

Coolant (engine)

Model	Capacity
EQS 450+	
EQS 580 4MATIC	

Notes on windshield washer fluid

Observe the notes on operating fluids (→ page 414).

⚠ WARNING Risk of fire and injury from windshield washer concentrate

Windshield washer concentrate is highly flammable. If it comes into contact with hot components, it may ignite.

▶ Make sure that windshield washer concentrate is not spilled near to the filler opening.

! **NOTE** Damage to the exterior lighting due to unsuitable windshield washer fluid

Unsuitable windshield washer fluid may damage the plastic surface of the exterior lighting.

▶ Only use windshield washer fluid which is also suitable for use on plastic surfaces, e.g. MB SummerFit or MB WinterFit.

! **NOTE** Blocked spray nozzles caused by mixing windshield washer fluids

▶ Do not mix MB SummerFit and MB WinterFit with other windshield washer fluids.

Do not use distilled or de-ionized water. Otherwise, the fill level sensor may be triggered erroneously.

Recommended windshield washer fluid:

- Above freezing point: e.g. MB SummerFit

- Below freezing point: e.g. MB WinterFit

For the correct mixing ratio, refer to the information on the antifreeze container.

Mix washer fluid with windshield washer fluid all year round.

Refrigerant

Notes on refrigerant

Observe the notes on operating fluids (→ page 414).

! **NOTE** Damage due to incorrect refrigerant

If a non-approved refrigerant is used, the climate control system may be damaged.

▶ **USA:** use only R-134a refrigerant.

▶ **Canada:** use only R-1234yf refrigerant.

! **NOTE** Damage to the climate control system due to incorrect refrigerant compressor oil

- ▶ Only use refrigerant compressor oil that has been approved by Mercedes-Benz.
- ▶ Do not mix the approved refrigerant compressor oil with a different refrigerant compressor oil.

Work on the climate control system may be carried out only at a qualified specialist workshop. All applicable regulations, as well as SAE standard J639, must be adhered to.

The information label for the climate control system regarding the refrigerant type and the refrigerant compressor oil (PAG oil) is located on the inside of the hood.

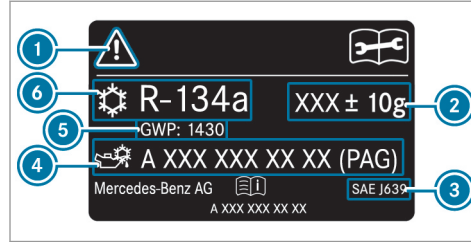

- Information label (example – USA/China)
- ① Hazard and service warning symbols
 - ② Refrigerant filling capacity
 - ③ Applicable standards
 - ④ PAG oil part number
 - ⑤ GWP (global warming potential) of the refrigerant used
 - ⑥ Refrigerant type

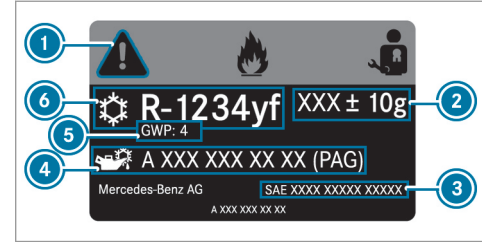

- Information label (example – Canada)
- ① Hazard and service warning symbols
 - ② Refrigerant filling capacity
 - ③ Applicable standards
 - ④ PAG oil part number
 - ⑤ GWP (global warming potential) of the refrigerant used
 - ⑥ Refrigerant type

Symbols ① indicate the following:

- Possible dangers
- Having maintenance work carried out at a qualified specialist workshop

Filling capacity for refrigerant and PAG oil

Capacity

Model	Refrigerant
All models	33.5 ± 0.4 oz (950 ± 10 g)
Model	PAG oil
All models	5.6 ± 0.4 oz (160 ± 10 g)

Vehicle data

Vehicle dimensions

The heights specified may vary as a result of the following factors:

- Tires
- Load
- Condition of the suspension
- Optional equipment

Vehicle dimensions

All models	
Vehicle length	207.3 in (5265 mm)
Vehicle width including outside mirrors	83.7 in (2125 mm)
Vehicle height	59.6 in (1513 mm)
Wheelbase	126.4 in (3210 mm)
Turning radius	39.0 ft (11.9 m)

Weights and loads

Vehicle-specific weight information can be found on the vehicle identification plate.

Observe the vehicle data specified below: optional equipment increases the curb weight and reduces the payload.

High-voltage battery

Missing values were not available at the time of going to press.

Data on charging the high-voltage battery

EQS 450+	
Model	Lithium-ion
Usable energy content	107.8 kWh
Range	
Charge time - mode 4 with approx. 148 kW peak charging capacity	36 min
Charge time - mode 3 with 9.6 kW charging capacity	Approx. 11 h 15 min
EQS 580 4MATIC	
Model	Lithium-ion
Usable energy content	107.8 kWh
Range	

EQS 580 4MATIC

Charge time – mode 4 with approx. 148 kW peak charging capacity	36 min
Charge time – mode 3 with 9.6 kW charging capacity	Approx. 11 h 15 min

Charge time – mode 3 applies to AC charging from 10% to 100% of the usable energy content.

Charge time – mode 4 applies to direct current charging from 10% to 80% of the usable energy content.

The time taken to charge the battery depends on the condition of charge of the battery, the ambient temperature and the charging capacity of the battery. The charging capacity, in turn, depends on the supply voltage, the current intensity and the type of power supply.

The nominal voltage range for your vehicle can be found on the information label in the socket cover (→ page 195).

Display messages

Introduction

Notes about display messages

Display messages appear on the driver display.

Display messages with graphical symbols are simplified in the Operator's Manual and may differ from the symbols on the driver display. The driver display shows high-priority display messages in red. Certain display messages are accompanied by a warning tone.

Please act in accordance with the display messages and follow the additional notes in the Operator's Manual.

For some display messages, symbols will also be shown:

- ⓘ Further information
- ✕ Hide display message

With the left-hand Touch Control, you can select the respective symbol by swiping to the left or right. Pressing ⓘ displays further information on the central display. Press the ✕ symbol to hide the display message.

You can hide low-priority display messages by pressing the back button  or the left-hand Touch Control. The display messages will then be stored in the message memory.

Rectify the cause of a display message as quickly as possible.

High-priority display messages cannot be hidden. The driver display will show these display messages continuously until the cause of the display message has been rectified.

Calling up saved display messages

Driver display:



 Service

The **Message Memory: XX** message appears in the driver display.

▶ Scroll through the display messages by swiping upwards or downwards on the left-hand Touch Control.

▶ **To exit the display:** press the  back button.

Occupant safety

Display messages	Possible causes/consequences and ► Solutions
 <p data-bbox="195 384 463 433">Restraint System Malfunction Service Required</p>	<p data-bbox="526 291 1055 314">* The restraint system is malfunctioning (→ page 44).</p> <div data-bbox="550 332 1702 572" style="border: 1px solid gray; padding: 5px;"> <p data-bbox="559 339 1245 366">⚠ DANGER Risk of death due to the restraint system malfunctioning</p> <p data-bbox="559 381 1659 433">Components in the restraint system may be activated unintentionally or not deploy as intended in an accident. In the event of an accident, the high-voltage on-board electrical system may not be deactivated as intended.</p> <p data-bbox="559 443 1650 495">You may receive an electric shock if you touch the damaged components of the high-voltage on-board electrical system.</p> <ul data-bbox="559 505 1522 560" style="list-style-type: none"> <li data-bbox="559 505 1522 529">► Have the restraint system checked and repaired immediately at a qualified specialist workshop. <li data-bbox="559 536 1110 560">► After an accident, switch off the vehicle immediately. </div>
 <p data-bbox="195 684 463 733">Front Left Malfunction Service Required (example)</p>	<p data-bbox="526 591 1203 615">* The corresponding restraint system is malfunctioning (→ page 44).</p> <div data-bbox="550 632 1702 873" style="border: 1px solid gray; padding: 5px;"> <p data-bbox="559 640 1245 667">⚠ DANGER Risk of death due to the restraint system malfunctioning</p> <p data-bbox="559 681 1659 733">Components in the restraint system may be activated unintentionally or not deploy as intended in an accident. In the event of an accident, the high-voltage on-board electrical system may not be deactivated as intended.</p> <p data-bbox="559 743 1650 795">You may receive an electric shock if you touch the damaged components of the high-voltage on-board electrical system.</p> <ul data-bbox="559 806 1522 860" style="list-style-type: none"> <li data-bbox="559 806 1522 829">► Have the restraint system checked and repaired immediately at a qualified specialist workshop. <li data-bbox="559 837 1110 860">► After an accident, switch off the vehicle immediately. </div>

Display messages	Possible causes/consequences and ► Solutions
 <p>Left Window Airbag Malfunction Service Required (example)</p>	<p>* The corresponding restraint system is malfunctioning (→ page 44).</p> <div style="border: 1px solid gray; padding: 5px; margin-top: 10px;"> <p>⚠ WARNING Risk of injury or fatal injury due to a malfunction in the window curtain airbag</p> <p>The window curtain airbag might be triggered unintentionally or might not be triggered at all in the event of an accident.</p> <p>► Have the window curtain airbag checked and repaired immediately at a qualified specialist workshop.</p> </div>
<p>Front Passenger Airbag Disabled See Operator's Manual</p>	<p>* The front passenger airbag and the front passenger knee airbag have been disabled even though an adult or a person of adult stature is on the front passenger seat. If additional forces are applied to the seat, the weight the system detects may be too low.</p> <div style="border: 1px solid gray; padding: 5px; margin-top: 10px;"> <p>⚠ WARNING Risk of injury or fatal injury due to a disabled front passenger airbag</p> <p>If the front passenger airbag is disabled, the front passenger airbag will not be deployed in the event of an accident and cannot perform its intended protective function.</p> <p>A person in the front passenger seat could then, for example, come into contact with the vehicle's interior, especially if the person is sitting too close to the cockpit.</p> <p>► Make sure, both before and during the journey, that the status of the front passenger airbag is correct.</p> </div> <ul style="list-style-type: none"> ► Stop the vehicle immediately in accordance with the traffic conditions. ► Make sure that no objects are trapped under the front passenger seat. ► Check the status of automatic front passenger airbag actuation (→ page 54).

Display messages	Possible causes/consequences and ► Solutions
<p>Front Passenger Airbag Enabled See Operator's Manual</p>	<p>► If necessary, consult a qualified specialist workshop immediately.</p> <p>* The front passenger airbag and the front passenger knee airbag will be enabled while the vehicle is in motion in the following situations:</p> <ul style="list-style-type: none"> • Even when a child, a small adult or an object weighing less than the system weight threshold is located on the front passenger seat • Even when the front passenger seat is not occupied <p>The system may detect objects or forces that are adding to the weight applied to the seat.</p> <div style="background-color: #f0f0f0; padding: 5px; border: 1px solid #ccc;"> <p>▲ WARNING Risk of injury or death when using a child restraint system while the front passenger airbag is enabled</p> <p>If you secure a child in a child restraint system on the front passenger seat and the front passenger airbag is enabled, the front passenger airbag can deploy in the event of an accident. The child could be struck by the airbag.</p> <p>► Ensure, both before and during the journey, that the status of the front passenger airbag is correct.</p> <p>NEVER use a rearward facing child restraint on a seat protected by an ACTIVE AIRBAG in front of it, DEATH or SERIOUS INJURY to the CHILD can occur.</p> </div> <p>► Stop the vehicle immediately in accordance with the traffic conditions.</p> <p>► Make sure that no objects are trapped under the front passenger seat.</p>

424 Display messages and warning/indicator lamps

Display messages	Possible causes/consequences and ► Solutions
	<ul style="list-style-type: none">► Check the status of automatic front passenger airbag actuation (→ page 54).► If necessary, consult a qualified specialist workshop immediately.
PRE-SAFE Inoperative See Operator's Manual	<ul style="list-style-type: none">* The PRE-SAFE® functions are malfunctioning.<ul style="list-style-type: none">► Consult a qualified specialist workshop.
PRE-SAFE Impulse Side Inoperative See Operator's Manual	<ul style="list-style-type: none">* The PRE-SAFE® Impulse Side system is malfunctioning or inoperative after having already been triggered.<ul style="list-style-type: none">► Consult a qualified specialist workshop.

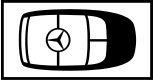

SmartKey

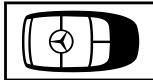
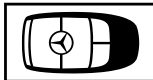
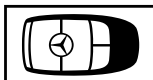

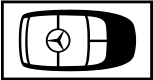
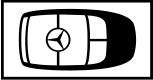

Display messages	Possible causes/consequences and ► Solutions
 <p>Obtain a New Key</p>	<ul style="list-style-type: none">* Have the SmartKey replaced.<ul style="list-style-type: none">► Consult a qualified specialist workshop.

Display messages	Possible causes/consequences and ► Solutions
 <p data-bbox="194 336 397 367">Replace Key Battery</p>	<p data-bbox="517 248 896 274">* The SmartKey battery is discharged.</p> <ul style="list-style-type: none"> <li data-bbox="545 279 914 310">► Replace the battery (→ page 75).
 <p data-bbox="194 476 443 533">Key Not Detected (white display message)</p>	<p data-bbox="517 388 914 414">* The SmartKey is currently undetected.</p> <ul style="list-style-type: none"> <li data-bbox="545 419 1081 450">► Change the location of the SmartKey in the vehicle. <li data-bbox="545 455 1681 486">► If the SmartKey is still not recognized, place it in the marked space for starting with the SmartKey (→ page 182).
 <p data-bbox="194 642 462 699">Key Not Detected (red display message)</p>	<p data-bbox="517 554 1238 580">* The SmartKey cannot be detected and may no longer be in the vehicle.</p> <p data-bbox="545 585 1238 616">The SmartKey is no longer in the vehicle and you switch off the vehicle:</p> <ul style="list-style-type: none"> <li data-bbox="554 621 924 652">• You can no longer start the vehicle. <li data-bbox="554 657 942 688">• You cannot centrally lock the vehicle. <ul style="list-style-type: none"> <li data-bbox="545 694 997 725">► Ensure that the SmartKey is in the vehicle. <p data-bbox="545 745 1413 777">If the SmartKey detection function has a malfunction due to a strong radio signal source:</p> <ul style="list-style-type: none"> <li data-bbox="545 782 1265 813">► Stop the vehicle immediately in accordance with the traffic conditions. <li data-bbox="545 818 1533 849">► Place the SmartKey in the marked space for starting the engine with the SmartKey (→ page 182).

Display messages	Possible causes/consequences and ► Solutions
 <p data-bbox="144 339 369 366">Don't Forget Your Key</p>	<ul style="list-style-type: none"> * A warning tone will also sound. This message reminds you to take your SmartKey with you when you leave the vehicle.
 <p data-bbox="144 481 421 531">Key Being Initialized Please Wait</p>	<ul style="list-style-type: none"> * The vehicle is processing in order to teach in the new SmartKey. <ul style="list-style-type: none"> ► Wait until processing is complete.
<p data-bbox="144 557 412 632">Place the Key in the Marked Space See Operator's Manual</p>	<ul style="list-style-type: none"> * SmartKey detection is malfunctioning. <ul style="list-style-type: none"> ► Change the location of the SmartKey in the vehicle. ► Place the SmartKey in the marked space for starting the engine with the SmartKey (→ page 182).

Lights

Display messages	Possible causes/consequences and ► Solutions
 <p data-bbox="195 384 356 436">Check Left Low Beam (example)</p>	<ul style="list-style-type: none"> <li data-bbox="524 291 968 311">* The corresponding light source is defective. <li data-bbox="543 325 759 346">► Drive on carefully. <li data-bbox="543 359 1055 380">► Visit a qualified specialist workshop immediately. <li data-bbox="543 393 1689 445">ⓘ LED light sources: the display message for the corresponding light appears only when all the light-emitting diodes in the light are faulty.
 <p data-bbox="195 556 436 608">Malfunction See Operator's Manual</p>	<ul style="list-style-type: none"> <li data-bbox="524 463 916 483">* The exterior lighting is malfunctioning. <li data-bbox="543 497 968 518">► Consult a qualified specialist workshop.
 <p data-bbox="195 723 473 774">Automatic Headlamp Mode Inoperative</p>	<ul style="list-style-type: none"> <li data-bbox="524 632 1143 653">* The light sensor for automatic driving lights is malfunctioning. <li data-bbox="543 667 968 687">► Consult a qualified specialist workshop.

Display messages	Possible causes/consequences and ► Solutions
 <p data-bbox="144 339 417 391">Active Headlamps Inoperative</p>	<ul style="list-style-type: none"> * The active headlamps are malfunctioning. <ul style="list-style-type: none"> ► Consult a qualified specialist workshop.
 <p data-bbox="144 508 369 534">Switch On Headlamps</p>	<ul style="list-style-type: none"> * You are driving without low-beam headlamps. <ul style="list-style-type: none"> ► Turn the light switch to the  or AUTO position.
 <p data-bbox="144 647 319 673">Switch Off Lights</p>	<ul style="list-style-type: none"> * You are leaving the vehicle and the lights are still switched on. <ul style="list-style-type: none"> ► Turn the light switch to the AUTO position.
<p data-bbox="144 696 402 747">DIGITAL LIGHT Functions Limited</p>	<ul style="list-style-type: none"> * The DIGITAL LIGHT system is malfunctioning. The lighting system will continue to work even without the functions of the DIGITAL LIGHT system. <ul style="list-style-type: none"> ► Consult a qualified specialist workshop.
<p data-bbox="144 799 412 877">Adaptive Highbeam Assist Currently Unavailable See Operator's Manual</p>	<ul style="list-style-type: none"> * Adaptive Highbeam Assist is temporarily unavailable. The system limits have been reached (→ page 150).



Display messages	Possible causes/consequences and ► Solutions
	<p>Once the cause of the problem is no longer present, the system will be available again. The Adaptive Highbeam Assist Now Available display message will appear.</p> <ul style="list-style-type: none"> ► Drive on. ► Operate the high beam manually until Adaptive High Beam Assist is available again.
<p>Adaptive Highbeam Assist Inoperative</p>	<p>* Adaptive Highbeam Assist is malfunctioning.</p> <ul style="list-style-type: none"> ► Drive on. <p>or</p> <ul style="list-style-type: none"> ► Stop the vehicle in accordance with the traffic conditions and restart the vehicle. ► If the display message does not disappear: consult a qualified specialist workshop. ► Until then, operate the high beam manually.
<p>Adaptive Highbeam Assist Plus Currently Unavailable See Operator's Manual</p>	<p>* Adaptive Highbeam Assist Plus is temporarily unavailable. The system limits have been reached (→ page 152).</p> <p>Once the cause of the problem is no longer present, the system will be available again. The Adaptive Highbeam Assist Plus Available Again display message will appear.</p> <ul style="list-style-type: none"> ► Drive on. ► Operate the high beam manually until Adaptive High Beam Assist Plus is available again.
<p>Adaptive Highbeam Assist Plus Inoperative</p>	<p>* Adaptive Highbeam Assist Plus is malfunctioning.</p> <ul style="list-style-type: none"> ► Drive on.

430 Display messages and warning/indicator lamps



Display messages	Possible causes/consequences and ► Solutions
	<p>or</p> <ul style="list-style-type: none">► Stop the vehicle in accordance with the traffic conditions and restart the vehicle.► If the display message does not disappear: consult a qualified specialist workshop.► Until then, operate the high beam manually.
Hazard Warning Light Malfunction	<ul style="list-style-type: none">* The hazard warning lamp switch is malfunctioning.► Consult a qualified specialist workshop.



Climate control



Display messages	Possible causes/consequences and ► Solutions
 <p>Inoperative High-Voltage Battery Charging Not Complete</p>	<ul style="list-style-type: none">* The high-voltage battery is charging. Pre-entry climate control cannot be switched on.► Wait until the charging process has achieved a minimum charge.

Display messages	Possible causes/consequences and ► Solutions
 <p data-bbox="194 341 452 393">Inoperative Charge High-voltage Battery</p>	<ul style="list-style-type: none">* The charge of the high-voltage battery is too low. Pre-entry climate control cannot be switched on.<ul style="list-style-type: none">► Charge the high-voltage battery.
 <p data-bbox="194 512 452 590">Pre-entry Climate Control Available Again via Smart-Key after Vehicle Start</p>	<ul style="list-style-type: none">* You have attempted to switch on pre-entry climate control more than three times with the engine switched off.<ul style="list-style-type: none">► Start the vehicle for ten seconds. Pre-entry climate control is operational again.
 <p data-bbox="194 704 452 782">Pre-entry Climate Control via Key Inoperative High-voltage Battery Low</p>	<ul style="list-style-type: none">* The charge of the high-voltage battery is too low. Pre-entry climate control cannot be switched on.





Drive system







Display messages	Possible causes/consequences and ► Solutions
 <p data-bbox="144 381 380 430">Performance Extremely Limited</p>	<p data-bbox="473 288 1031 314">* A malfunction has occurred in the high-voltage battery. Output and range are severely restricted.</p> <ul style="list-style-type: none"> <li data-bbox="495 358 851 385">► Switch the vehicle off and lock it. <li data-bbox="495 391 1175 418">► After waiting for a short time, unlock the vehicle and start it again. <p data-bbox="495 443 861 470">If the display message appears again:</p> <ul style="list-style-type: none"> <li data-bbox="495 476 704 503">► Drive on carefully. <li data-bbox="495 509 1036 536">► Fully charge the high-voltage battery (→ page 195). <p data-bbox="495 561 1300 588">If the output and range are still reduced, there is a malfunction in the drive system.</p> <ul style="list-style-type: none"> <li data-bbox="495 594 704 621">► Drive on carefully. <li data-bbox="495 627 916 654">► Consult a qualified specialist workshop.
 <p data-bbox="144 764 410 814">Towing Not Permitted See Operator's Manual</p>	<p data-bbox="473 671 838 698">* The drive system is malfunctioning.</p> <ul style="list-style-type: none"> <li data-bbox="495 704 1289 731">► Have the vehicle transported only using a transporter or trailer (→ page 372).



Display messages	Possible causes/consequences and ► Solutions
 <p data-bbox="194 341 462 393">Acoustic Presence Indicator Inoperative</p>	<ul style="list-style-type: none"> * The sound generator (acoustic vehicle warning system) is malfunctioning. No driving noises are being produced. The vehicle may not be heard by other road users. <ul style="list-style-type: none"> ► Drive with particular care. ► Visit a qualified specialist workshop.
<p data-bbox="194 419 471 528">To switch vehicle off, press and hold Start/Stop button for at least 3 seconds or press 3 times</p>	<ul style="list-style-type: none"> * You have pressed the start/stop button while the vehicle is in motion. <ul style="list-style-type: none"> ► To switch off the drive system while the vehicle is in motion (→ page 181).
 <p data-bbox="194 637 452 688">Check Coolant Level See Operator's Manual</p>	<ul style="list-style-type: none"> * The coolant level is too low. <div data-bbox="545 585 1690 673" style="border: 1px solid black; padding: 5px; margin: 5px 0;"> <p>NOTE Damage to the drive system due to insufficient coolant</p> <ul style="list-style-type: none"> ► Avoid long journeys with insufficient coolant. </div> <ul style="list-style-type: none"> ► Have the cooling system of the drive system checked at a qualified specialist workshop.
 <p data-bbox="194 823 443 875">Coolant Stop Switch Off Vehicle</p>	<ul style="list-style-type: none"> * The coolant is too hot. <ul style="list-style-type: none"> ► Stop the vehicle immediately in accordance with the traffic conditions and switch off the drive system.



Display messages	Possible causes/consequences and ► Solutions
	<p>▲ WARNING Risk of injury due to overheated vehicle</p> <p>If you open the hood in the event of an overheated vehicle or fire in the engine compartment, the following situations may occur:</p> <ul style="list-style-type: none"> • You may come into contact with hot gases. • You may come into contact with other escaping hot operating fluids. <p>► In the event of overheating or fire in the engine compartment, keep the hood closed and call the fire service.</p> <p>► Allow the overheated vehicle to cool down first if you need to open the hood.</p> <p>► Wait until the drive system has cooled down.</p> <p>► Make sure that the air supply to the vehicle radiator is not obstructed.</p> <p>► Avoiding high loads on the drive system, drive to the nearest qualified specialist workshop.</p>
	<p>* The cooling system has detected a component malfunction.</p> <p>► Avoiding high loads on the drive system, drive to the nearest qualified specialist workshop.</p>
 <p>Charger Cable Connected</p>	<p>* You cannot pull away while the charging cable is connected.</p> <p>► Disconnect the charging cable from the vehicle.</p>

Display messages	Possible causes/consequences and ► Solutions
<p>Not Possible to Unlock Charger Cable See Operator's Manual</p>	<ul style="list-style-type: none"> * The charging cable connector cannot be removed from the charging station's socket. <ul style="list-style-type: none"> ► Press the EMERGENCY OFF switch on the charging station. If the charging cable connector cannot be removed after that: <ul style="list-style-type: none"> ► Request service personnel from the operator of the charging station via the emergency call button attached to the charging station or the emergency call numbers.
<p>Vehicle Currently Not Being Charged... Charging Station Fault</p>	<ul style="list-style-type: none"> * A malfunction has occurred in the charging station or the RFID card is not recognized. <ul style="list-style-type: none"> ► Start the charging process at a different charging station. or ► Have the RFID card checked to ensure it is functioning.
<p>Charging Fault Change Charging Mode See Operator's Manual</p>	<ul style="list-style-type: none"> * A temporary malfunction has occurred at the charging station. <ul style="list-style-type: none"> ► Wait until the malfunction has passed. or ► Start the charging process at a different charging station.
<p>AC Charging Inoperative Service Required</p>	<ul style="list-style-type: none"> * The charging process cannot be started due to a malfunction. <ul style="list-style-type: none"> ► Consult a qualified specialist workshop.
<p>DC Charging Inoperative Service Required</p>	<ul style="list-style-type: none"> * The charging process cannot be started due to a malfunction. <ul style="list-style-type: none"> ► Consult a qualified specialist workshop.

Display messages	Possible causes/consequences and ► Solutions
<p data-bbox="144 249 421 322">Reduced Drive System Performance See Operator's Manual</p>	<ul style="list-style-type: none"> <li data-bbox="476 249 1646 399">* The drive system is outside the normal operating temperature range, e.g. due to extremely low or high outside temperatures. Drive system power output is reduced. The yellow reduced power output warning lamp  is lit. Once the operating temperature of the drive system returns to normal (e.g. after a short trip), the full output will be available again. The display message and the yellow reduced power output warning lamp  will go out. <ul style="list-style-type: none"> <li data-bbox="495 410 704 433">► Drive on carefully. <li data-bbox="476 443 1443 572">* The high-voltage battery is not charged sufficiently. Drive system power output is reduced. The yellow reduced power output warning lamp  is lit. <ul style="list-style-type: none"> <li data-bbox="495 515 704 538">► Drive on carefully. <li data-bbox="495 549 962 571">► Charge the high-voltage battery immediately. <li data-bbox="476 583 1369 676">* If the drive system power output is still reduced, there is a malfunction in the drive system. <ul style="list-style-type: none"> <li data-bbox="495 619 704 642">► Drive on carefully. <li data-bbox="495 652 912 675">► Consult a qualified specialist workshop.
<div data-bbox="155 692 312 774" style="border: 1px solid black; padding: 5px; text-align: center;">  </div> <p data-bbox="144 785 421 831">Battery Too Low Stop Vehicle Charge Immediately</p>	<ul style="list-style-type: none"> <li data-bbox="476 692 1637 873">* The charge level of the high-voltage battery is so low that it is no longer possible to drive the vehicle. The drive system can no longer be restarted. When the drive system is restarted, the message Battery Too Low Stop Vehicle Charge Immediately will appear again. <ul style="list-style-type: none"> <li data-bbox="495 816 1212 839">► Stop the vehicle immediately in accordance with the traffic conditions. <li data-bbox="495 849 986 872">► Charge the high-voltage battery (→ page 195).

Display messages	Possible causes/consequences and ► Solutions
<p>Wait in the READY status Battery is warming up see Operator's Manual</p>	<ul style="list-style-type: none"> * Operational readiness is established  and the transmission position  is engaged. The high-voltage battery is warmed up to the operating temperature. This process can take a few minutes and may be prolonged if defrosting of the windshield  is activated. The heating process ends when transmission position  is engaged. However, when driving, the output is significantly limited until the high-voltage battery has reached its operating temperature.
 <p>Battery Overheated Stop, Everyone Get Out Out- doors if Possible</p>	<ul style="list-style-type: none"> * The high-voltage battery has overheated. There is a risk of fire. <ul style="list-style-type: none"> ► Stop the vehicle immediately in accordance with the traffic conditions. ► If possible, stop the vehicle in the open air and ensure that all vehicle occupants get out. ⓘ Supporting vehicle functions may activate automatically, e.g. the air-recirculation mode as part of climate control. ► Do not continue driving. ► If smoke is present, leave the danger zone and call the fire service immediately. ► Consult a qualified specialist workshop even if there are no external signs of a fire.
 <p>Malfunction</p>	<ul style="list-style-type: none"> * The drive system is malfunctioning. A warning tone will also sound. <ul style="list-style-type: none"> ► Consult a qualified specialist workshop.

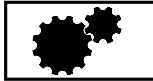
Display messages	Possible causes/consequences and ► Solutions
 <p data-bbox="144 339 347 391">Malfunction Service Required</p>	<ul style="list-style-type: none"> * The drive system is malfunctioning. <ul style="list-style-type: none"> ► Consult a qualified specialist workshop.
 <p data-bbox="144 508 412 584">Have High-voltage System Checked See Operator's Manual</p>	<ul style="list-style-type: none"> * A function restriction has occurred in the drive system. <ul style="list-style-type: none"> ► Consult a qualified specialist workshop.
<p data-bbox="144 609 402 636">Preparing Drive System...</p>	<ul style="list-style-type: none"> * The insulation of the drive system is being tested. This process can last for up to ten seconds.
<p data-bbox="144 660 376 708">Do Not Restart Vehicle Service Required</p>	<ul style="list-style-type: none"> * It is not possible to restart the drive system due to a malfunction. <ul style="list-style-type: none"> ► Do not switch off the drive system; drive on to the nearest qualified specialist workshop.
 <p data-bbox="144 823 421 878">Reserve Level Charge High-Voltage Battery</p>	<ul style="list-style-type: none"> * The charge level of the high-voltage battery has dropped into the reserve range. <ul style="list-style-type: none"> ► Charge the high-voltage battery (→ page 195).

Display messages	Possible causes/consequences and ► Solutions
 <p>Malfunction</p>	<ul style="list-style-type: none"> * The drive system is malfunctioning. The output of your vehicle is restricted. <ul style="list-style-type: none"> ► Consult a qualified specialist workshop.
 <p>Stop Switch Off Vehicle</p>	<ul style="list-style-type: none"> * The drive system is malfunctioning. <ul style="list-style-type: none"> ► Stop the vehicle immediately in accordance with the traffic conditions and switch off the drive system. Do not continue driving. ► Do not tow the vehicle, stop towing if necessary. ► Consult a qualified specialist workshop.
 <p>Malfunction Visit Workshop</p>	<ul style="list-style-type: none"> * The drive system is malfunctioning. <ul style="list-style-type: none"> ► Consult a qualified specialist workshop.
<p>High-voltage Battery Fault No Start in Approx. XXX mi Service Required (yellow display message)</p>	<ul style="list-style-type: none"> * A malfunction has occurred in the high-voltage battery. It is no longer possible to start the electric drive system after the distance displayed has been covered. <ul style="list-style-type: none"> ► Have the necessary maintenance work on the high-voltage battery carried out at a qualified specialist workshop.



440 Display messages and warning/indicator lamps



Display messages	Possible causes/consequences and ► Solutions
High-voltage Battery Fault No Start in Approx. XXX mi Service Required (red display message)	<ul style="list-style-type: none">* A malfunction has occurred in the high-voltage battery. It is no longer possible to start the electric drive system after the distance displayed has been covered. ► Have the necessary maintenance work on the high-voltage battery carried out immediately at a qualified specialist workshop.
High-voltage Battery Fault Do Not Restart Service Required	<ul style="list-style-type: none">* A malfunction has occurred in the high-voltage battery. It is no longer possible to restart the drive system once it has been switched off. ► Do not switch off the drive system; drive on to the nearest qualified specialist workshop.



Vehicle

Display messages	Possible causes/consequences and ► Solutions
	<ul style="list-style-type: none">* The driver display is inoperative due to a failed software update. The display message will be shown every time the engine is started. <div style="border: 1px solid gray; padding: 5px;"><p>⚠ WARNING Risk of accident due to failure of the driver display</p><p>In the event that the driver display fails or malfunctions, you will not recognize function restrictions affecting systems relevant to safety. This may impair operating safety.</p><p>► Park the vehicle safely as soon as possible and notify a qualified specialist workshop.</p></div>



Display messages	Possible causes/consequences and ► Solutions
	<p>If the driver display fails, you may not recognize function restrictions affecting systems relevant to safety or the speed display, for example. The operating safety of the vehicle may be impaired (→ page 316).</p> <p>► Have the vehicle checked by a qualified specialist workshop immediately.</p>
 <p>Vehicle Ready to Drive Switch the Ignition Off Before Exiting</p>	<p>* You are leaving the vehicle in a ready-to-drive state.</p> <p>► Get out of the vehicle, secure it against rolling away and take the SmartKey with you.</p> <p>► If you do not leave the vehicle, switch off the electrical consumers, e.g. the seat heating. Otherwise, the 12-V battery may discharge and starting the engine may be possible only with the help of a second battery (jump start).</p>
<p>Head-up Display Currently Unavailable See Operator's Manual</p>	<p>* The Head-up Display is temporarily unavailable. Possible causes:</p> <ul style="list-style-type: none"> • Malfunctions in the power supply • Signal interference <p>► Stop in accordance with the traffic conditions and switch the vehicle off and on again.</p> <p>► If the display message still appears, consult a qualified specialist workshop.</p>
<p>Head-up Display Inopera- tive</p>	<p>* The Head-up Display has an internal error.</p> <p>► Consult a qualified specialist workshop.</p>

Display messages	Possible causes/consequences and ► Solutions
<p>Head-up Display Brightness Currently Reduced See Operator's Manual</p>	<p>* The brightness of the Head-up Display is reduced. Possible causes:</p> <ul style="list-style-type: none"> • Dirt on the windshield in the camera's field of vision • Faulty exterior brightness signals <p>► Switch on the windshield wipers.</p> <p>► Clean the windshield if necessary.</p> <p>► Switch the vehicle off and switch it back on</p> <p>► If the display message still appears, consult a qualified specialist workshop.</p>
 <p>Steering Malfunction Drive Carefully Service Required</p>	<p>* A power steering malfunction has occurred. Steering characteristics may be impaired as a result.</p> <p>► Drive on carefully.</p> <p>► Consult a qualified specialist workshop.</p>
 <p>Steering Malfunction Increased Physical Effort See Operator's Manual</p>	<p>* The power steering assistance is malfunctioning.</p> <div style="background-color: #f0f0f0; padding: 5px; border: 1px solid #ccc;"> <p>▲ WARNING Risk of an accident due to altered steering characteristics</p> <p>If the power assistance of the steering fails partially or completely, you will need to use more force to steer.</p> <ul style="list-style-type: none"> ► If safe steering is possible, drive on carefully. ► Visit or consult a qualified specialist workshop immediately. </div>

Display messages	Possible causes/consequences and ► Solutions
 <p data-bbox="195 342 463 417">Steering Malfunction Stop Immediately See Operator's Manual</p>	<p data-bbox="524 249 1271 275">* The steering is malfunctioning. Steering capability is significantly impaired.</p> <div data-bbox="550 291 1702 469" style="border: 1px solid gray; padding: 5px;"> <p data-bbox="559 301 1184 327">⚠ WARNING Risk of accident if steering capability is impaired</p> <p data-bbox="559 337 1437 363">If the steering does not function as intended, the vehicle's operating safety is jeopardized.</p> <ul style="list-style-type: none"> <li data-bbox="559 373 1641 425">▶ Pull over and stop the vehicle safely as soon as possible, paying attention to road and traffic conditions. Do not continue driving under any circumstances. <li data-bbox="559 436 984 462">▶ Consult a qualified specialist workshop. </div>
 <p data-bbox="195 578 436 629">Rear Axle Steering Currently Malfunctioning</p>	<p data-bbox="524 484 1337 510">* The rear axle steering is temporarily unavailable. The turning radius may increase.</p> <ul style="list-style-type: none"> <li data-bbox="543 521 1369 547">▶ Stop the vehicle in accordance with the traffic conditions and restart the vehicle. <p data-bbox="543 567 962 593">If the display message does not disappear:</p> <ul style="list-style-type: none"> <li data-bbox="543 603 759 629">▶ Drive on carefully. <li data-bbox="543 640 966 666">▶ Consult a qualified specialist workshop.
 <p data-bbox="195 772 476 824">Rear Axle Steering Malfunction Service Required</p>	<p data-bbox="524 679 935 705">* The rear axle steering is malfunctioning.</p> <p data-bbox="543 715 935 741">The rear axle has no steering capability.</p> <p data-bbox="543 752 1179 778">The steering wheel may be tilted when you drive in a straight line.</p> <ul style="list-style-type: none"> <li data-bbox="543 788 972 814">▶ Adapt your speed and drive on carefully. <li data-bbox="543 824 1086 850">▶ Consult a qualified specialist workshop immediately.

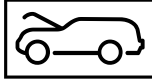
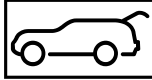
Display messages	Possible causes/consequences and ► Solutions
 <p data-bbox="144 339 426 391">Rear Axle Steering Malfunction Stop Immediately</p>	<p data-bbox="476 249 1628 401">* The rear axle steering is malfunctioning. The rear axle has no steering capability. The steering wheel may be tilted considerably when you drive in a straight line. Depending on the steering wheel's tilted position, the steering wheel will also vibrate and a continuous warning tone will sound.</p> <div data-bbox="500 422 1646 598" style="border: 1px solid gray; padding: 5px;"> <p data-bbox="506 428 1129 456">⚠ WARNING Risk of accident if steering capability is impaired</p> <p data-bbox="506 470 1387 495">If the steering does not function as intended, the vehicle's operating safety is jeopardized.</p> <ul style="list-style-type: none"> <li data-bbox="506 505 1591 557">► Pull over and stop the vehicle safely as soon as possible, paying attention to road and traffic conditions. Do not continue driving under any circumstances. <li data-bbox="506 567 931 591">► Consult a qualified specialist workshop. </div> <p data-bbox="495 619 1073 643">► When stopping, bear the enlarged vehicle width in mind.</p>
<p data-bbox="144 660 389 712">Snow Chain Mode Maximum Speed Exceeded</p>	<p data-bbox="476 660 1221 684">* The maximum permissible speed for snow chain mode has been exceeded.</p> <p data-bbox="495 695 704 718">► Drive more slowly.</p>
	<p data-bbox="476 733 746 757">* At least one door is open.</p> <p data-bbox="495 767 680 791">► Close all doors.</p>

Display messages	Possible causes/consequences and ► Solutions
	<p>* The hood is open.</p> <div style="border: 1px solid gray; padding: 5px; margin: 10px 0;"> <p>⚠ WARNING Risk of accident due to driving with the hood unlocked</p> <p>The hood may open and block your view.</p> <ul style="list-style-type: none"> ► Never release the hood when driving. ► Before every trip, ensure that the hood is locked. </div> <ul style="list-style-type: none"> ► Stop the vehicle immediately in accordance with the traffic conditions. ► Do not continue driving. ► Consult a qualified specialist workshop.
	<p>* The tailgate is open.</p> <ul style="list-style-type: none"> ► Close the tailgate.
<p>Ambient Lighting Warning Support Inoperative</p>	<p>* The ambient lighting may not provide full visual warning support.</p> <ul style="list-style-type: none"> ► Lock the vehicle and unlock it again after a few minutes. ► If the display message appears regularly, contact a qualified specialist workshop.

Display messages	Possible causes/consequences and ► Solutions
 <p>Rear Left Backrest Not Latched (example)</p>	<ul style="list-style-type: none"> * The seat backrest of the corresponding seat is not engaged. <ul style="list-style-type: none"> ► Fold the seat backrest back until it engages.
 <p>Check Washer Fluid</p>	<ul style="list-style-type: none"> * The washer fluid level in the washer fluid reservoir has dropped below the minimum. <ul style="list-style-type: none"> ► Add washer fluid (→ page 355).
<p>Windshield Wiper Malfunction</p>	<ul style="list-style-type: none"> * The windshield wipers are malfunctioning. <ul style="list-style-type: none"> ► Restart the vehicle. If the display message still appears: <ul style="list-style-type: none"> ► Consult a qualified specialist workshop.

Transmission

Display messages	Possible causes/consequences and ► Solutions
Shift to P Only When Vehicle Is Stationary	<ul style="list-style-type: none"> * It is possible to select the park position P only if the vehicle is stationary. <ul style="list-style-type: none"> ► Depress the brake pedal. ► Shift the transmission to park position P when the vehicle is stationary.
Depress Brake to Shift from P	<ul style="list-style-type: none"> * You have attempted to shift the transmission out of park position P and into another transmission position. <ul style="list-style-type: none"> ► Depress the brake pedal. ► Select transmission position D, R or neutral N.
To Deselect P or N Depress Brake and Start Vehicle	<ul style="list-style-type: none"> * You have attempted to shift the transmission out of park position P or neutral N and into another transmission position. <ul style="list-style-type: none"> ► Depress the brake pedal. ► Start the vehicle. ► Change the transmission position.
Depress Brake to Shift to D or R	<ul style="list-style-type: none"> * You have attempted to select transmission position D or R. <ul style="list-style-type: none"> ► Depress the brake pedal. ► Select transmission position D or R.
Apply Brake To Park Service Required	<ul style="list-style-type: none"> * A malfunction has occurred in the emergency power supply to park position P. <ul style="list-style-type: none"> ► Consult a qualified specialist workshop.





Display messages	Possible causes/consequences and ► Solutions
	<ul style="list-style-type: none"> ► Until then, always select park position P manually before you switch off the vehicle. ► Before leaving the vehicle, apply the electric parking brake.
Risk of Vehicle Rolling Away Driver's Door Open Position P Not Selected	<p>* The driver's door is not fully closed and transmission position D, R or neutral N is selected. The vehicle may roll away.</p> <ul style="list-style-type: none"> ► Select park position P when switching off the vehicle.
Risk of Vehicle Rolling Away Apply Brake to Park	<p>* The transmission is malfunctioning. Park position P cannot be selected.</p> <ul style="list-style-type: none"> ► Park the vehicle safely. ► Use the electric parking brake to secure the vehicle against rolling away. ► On gradients, turn the front wheels so that the vehicle will roll towards the curb if it starts moving.
Risk of Vehicle Rolling Away N Activated Manually No Automatic Change to P	<p>* While the vehicle was at a standstill or driving at very low speed, neutral N was engaged with the drive system or the vehicle switched on.</p> <div style="border: 1px solid black; padding: 5px; margin-top: 10px;"> <p>! NOTE Damage to the vehicle due to rolling away</p> <p>When the vehicle is switched off or the driver's door is opened, automatic engagement of park position P is deactivated.</p> <p>The vehicle may roll away.</p> <ul style="list-style-type: none"> ► Be ready to brake. ► Do not leave the vehicle unattended. </div>









Display messages	Possible causes/consequences and ► Solutions
	<ul style="list-style-type: none"> ► Depress the brake pedal until the vehicle comes to a standstill. ► Engage park position P when the vehicle is stationary with the brake pedal depressed. ► To continue driving with the brake pedal depressed, select transmission position D or R.
<p>N Automatically Activated Please Shift to Transmission Position Again</p>	<ul style="list-style-type: none"> * Neutral N was automatically engaged when the vehicle was rolling or being driven. ⓘ When you open the driver's door in neutral N, park position P will be engaged automatically. ► Depress the brake pedal until the vehicle comes to a standstill. ► Engage park position P when the vehicle is stationary with the brake pedal depressed. ► To continue driving with the brake pedal depressed, select transmission position D or R.
<p>N is Engaged Please Engage Desired Gear</p>	<ul style="list-style-type: none"> * The accelerator pedal was depressed while the vehicle was rolling or moving in neutral N. ► To accelerate the vehicle, select transmission position D or R.
<p>Reversing Not Possible Service Required</p>	<ul style="list-style-type: none"> * The transmission is malfunctioning. It is not possible to select transmission position R. ► Consult a qualified specialist workshop.
<p>Transmission Malfunction Stop</p>	<ul style="list-style-type: none"> * The transmission is malfunctioning. The transmission shifts to neutral N automatically. ► Stop the vehicle immediately in accordance with the traffic conditions. ► Depress the brake pedal. ► Engage park position P. ► Consult a qualified specialist workshop.

450 Display messages and warning/indicator lamps





Display messages	Possible causes/consequences and ► Solutions
Service Required Do Not Change Transmission Position	<ul style="list-style-type: none">* The transmission is malfunctioning. It is no longer possible to change the transmission position.<ul style="list-style-type: none">► If transmission position D is selected, consult a qualified specialist workshop and do not change the transmission position.► For all other transmission positions, park the vehicle safely.► Consult a qualified specialist workshop or breakdown service.
Auxiliary Battery Malfunction (white display message)	<ul style="list-style-type: none">* There is a malfunction in the auxiliary battery.<ul style="list-style-type: none">► Visit a qualified specialist workshop.► Until then, always select park position P manually before you switch off the vehicle.► Before leaving the vehicle, apply the electric parking brake.







Brakes

Display messages	Possible causes/consequences and ► Solutions
<div data-bbox="205 291 362 373" data-label="Image"> </div> <p data-bbox="205 381 306 407">(USA only)</p> <div data-bbox="205 418 362 501" data-label="Image"> </div> <p data-bbox="205 508 338 534">(Canada only)</p> <p data-bbox="195 541 458 591">Parking Brake See Operator's Manual</p>	<ul style="list-style-type: none"> <li data-bbox="528 288 1337 313">* The yellow  indicator lamp is lit. The electric parking brake is malfunctioning. <ul style="list-style-type: none"> <li data-bbox="547 324 635 350">To apply: <li data-bbox="547 358 1005 384">► Switch the vehicle off and switch it back on <li data-bbox="547 392 1134 418">► Apply the electric parking brake manually (→ page 215). <p data-bbox="547 446 1068 472">If it is not possible to apply the electric parking brake:</p> <ul style="list-style-type: none"> <li data-bbox="547 480 964 506">► Consult a qualified specialist workshop. <li data-bbox="547 514 1254 540">► Where necessary, also secure the parked vehicle against rolling away. <li data-bbox="528 548 1692 599">* The yellow  indicator lamp and the red  (USA only) or  (Canada only) indicator lamp are lit. The electric parking brake is malfunctioning. <ul style="list-style-type: none"> <li data-bbox="547 608 654 634">To release: <li data-bbox="547 642 1005 668">► Switch the vehicle off and switch it back on <li data-bbox="547 676 1156 702">► Release the electric parking brake manually (→ page 215). <p data-bbox="547 710 569 736">or</p> <ul style="list-style-type: none"> <li data-bbox="547 744 1199 770">► Release the electric parking brake automatically (→ page 214). <p data-bbox="547 768 1129 794">If it is still not possible to release the electric parking brake:</p> <ul style="list-style-type: none"> <li data-bbox="547 802 1203 828">► Do not continue driving. Consult a qualified specialist workshop.



Display messages	Possible causes/consequences and ► Solutions
	<p>* The yellow  indicator lamp is lit and the red  (USA only) or  (Canada only) indicator lamp is flashing. The electric parking brake is malfunctioning.</p> <p>The electric parking brake could not be applied or released.</p> <ul style="list-style-type: none">► Switch the vehicle off and switch it back on <p>To apply:</p> <ul style="list-style-type: none">► Release and then apply the electric parking brake manually (→ page 215). <p>To release:</p> <ul style="list-style-type: none">► Apply and then release the electric parking brake manually. <p>If the electric parking brake cannot be applied or the red  (USA only) or  (Canada only) indicator lamp continues to flash:</p> <ul style="list-style-type: none">► Do not continue driving. Consult a qualified specialist workshop.► Where necessary, also secure the parked vehicle against rolling away. <p>* The yellow  indicator lamp is lit and the red  (USA only) or  (Canada only) indicator lamp flashes for approximately ten seconds after the electric parking brake has been applied or released. It then remains lit or goes out. The electric parking brake is malfunctioning.</p> <p>If the state of charge is too low:</p> <ul style="list-style-type: none">► Charge the 12 V battery.

Display messages	Possible causes/consequences and ► Solutions
	<p>To apply:</p> <ul style="list-style-type: none">► Apply the electric parking brake manually. <p>If it is not possible to apply the electric parking brake:</p> <ul style="list-style-type: none">► Consult a qualified specialist workshop.► Where necessary, also secure the parked vehicle against rolling away. <p>To release:</p> <ul style="list-style-type: none">► If the conditions for automatic release are fulfilled and the electric parking brake is not released automatically, release the electric parking brake manually (→ page 215). <p>If it is still not possible to release the electric parking brake:</p> <ul style="list-style-type: none">► Do not continue driving. Consult a qualified specialist workshop.

Display messages	Possible causes/consequences and ► Solutions
 <p>(USA only)</p>  <p>(Canada only)</p> <p>Please Release Parking Brake</p>	<p>* The red  indicator lamp (USA only) or  indicator lamp (Canada only) is flashing.</p> <p>The electric parking brake is applied while you are driving:</p> <ul style="list-style-type: none">• A condition for automatic release of the electric parking brake has not been fulfilled (→ page 214).• You are performing emergency braking using the electric parking brake (→ page 215). <p>► Check the conditions for automatic release of the electric parking brake.</p> <p>► Release the electric parking brake manually.</p>





Display messages	Possible causes/consequences and ► Solutions
 <p>(USA only)</p>  <p>(Canada only)</p> <p>Switch on Vehicle to Release the Parking Brake</p>	<p>* The red  (USA only) or  (Canada only) indicator lamp is lit. You have attempted to release the electric parking brake with the vehicle switched off.</p> <ul style="list-style-type: none">► Switch on the vehicle.
 <p>(USA only)</p>  <p>(Canada only)</p> <p>Brake Immediately</p>	<p>* A malfunction has occurred while the HOLD function was activated. A horn may also sound at regular intervals. You cannot start the vehicle system.</p> <ul style="list-style-type: none">► Immediately depress the brake pedal firmly until the display message disappears. You cannot start the vehicle system again.



Display messages	Possible causes/consequences and ► Solutions
<div data-bbox="155 252 310 332" data-label="Image"> </div> <p data-bbox="144 342 247 366">(USA only)</p> <div data-bbox="155 377 310 456" data-label="Image"> </div> <p data-bbox="144 467 279 491">(Canada only)</p> <p data-bbox="144 501 421 550">Malfunction see Operator's Manual</p>	<p data-bbox="476 249 944 308">* The brake force boosting function is impaired. The hill start assist may be impaired.</p> <div data-bbox="500 325 1646 477" data-label="Complex-Block"> <p data-bbox="506 335 1190 359">▲ WARNING Risk of an accident due to a brake system malfunction</p> <p data-bbox="506 373 1276 397">If the brake system is malfunctioning, braking characteristics may be impaired.</p> <ul data-bbox="506 408 1313 467" style="list-style-type: none"> <li data-bbox="506 408 722 432">► Drive on carefully. <li data-bbox="506 442 1313 466">► Have the brake system checked immediately at a qualified specialist workshop. </div>
<div data-bbox="155 581 310 660" data-label="Image"> </div> <p data-bbox="144 671 247 695">(USA only)</p> <div data-bbox="155 705 310 785" data-label="Image"> </div> <p data-bbox="144 795 279 819">(Canada only)</p> <p data-bbox="144 829 316 853">Malfunction Stop</p>	<p data-bbox="476 578 1411 601">* The brake force boosting function is impaired and the braking characteristics may be affected.</p> <div data-bbox="500 618 1646 795" data-label="Complex-Block"> <p data-bbox="506 628 1319 652">▲ WARNING Risk of accident and injury if brake force boosting is malfunctioning</p> <p data-bbox="506 667 1609 715">If brake force boosting is malfunctioning, increased brake pedal force may be necessary for braking. The braking characteristics may be impaired. The braking distance can increase in emergency braking situations.</p> <ul data-bbox="506 726 1134 785" style="list-style-type: none"> <li data-bbox="506 726 1134 750">► Stop in a safe location immediately. Do not continue driving. <li data-bbox="506 760 931 784">► Consult a qualified specialist workshop. </div>

Display messages	Possible causes/consequences and ► Solutions
 <p>(USA only)</p>  <p>(Canada only)</p> <p>Check Brake Fluid Level</p>	<p>* There is insufficient brake fluid in the brake fluid reservoir.</p> <div style="border: 1px solid gray; padding: 5px; margin-top: 10px;"> <p>⚠ WARNING Risk of an accident due to low brake fluid level</p> <p>If the brake fluid level is too low, the braking effect and the braking characteristics may be impaired.</p> <ul style="list-style-type: none"> ▶ Pull over and stop the vehicle safely as soon as possible, paying attention to road and traffic conditions. Do not continue driving under any circumstances. ▶ Consult a qualified specialist workshop. ▶ Do not add brake fluid. </div>
<p>Check Brake Pads See Operator's Manual</p>	<p>* The brakepads have reached the wear limit.</p> <ul style="list-style-type: none"> ▶ Consult a qualified specialist workshop.



Driving systems

Display messages	Possible causes/consequences and ► Solutions
 <p>Off</p>	<p>* The HOLD function is deactivated because the vehicle is slipping or a condition for activation is not fulfilled.</p> <ul style="list-style-type: none"> ▶ Reactivate the HOLD function later or check the activation conditions for the HOLD function (→ page 221).

Display messages	Possible causes/consequences and ► Solutions
 <p data-bbox="144 339 421 391">ATTENTION ASSIST Inoperative</p>	<ul style="list-style-type: none"> <li data-bbox="469 249 861 275">* ATTENTION ASSIST is malfunctioning. <li data-bbox="493 282 916 308">► Consult a qualified specialist workshop.
 <p data-bbox="144 508 421 560">ATTENTION ASSIST: Take a Break!</p>	<ul style="list-style-type: none"> <li data-bbox="469 418 1502 470">* ATTENTION ASSIST has detected fatigue or an increasing lack of concentration on the part of the driver (→ page 224). <li data-bbox="493 477 787 503">► If necessary, take a break.
 <p data-bbox="144 677 399 729">ATTENTION ASSIST Nodding Off Take a Break!</p>	<ul style="list-style-type: none"> <li data-bbox="469 587 1208 644">* ATTENTION ASSIST has detected indicators of microsleep (→ page 224). A warning tone will also sound. <li data-bbox="493 651 1055 677">► It is recommended that you take a break immediately. <li data-bbox="493 684 1240 710">► Press the left-hand Touch Control and acknowledge the display message.
 <p data-bbox="144 846 232 872">--- mph</p>	<ul style="list-style-type: none"> <li data-bbox="469 756 1252 782">* Cruise control cannot be activated as not all activation conditions are fulfilled. <li data-bbox="493 789 1184 815">► Observe the activation conditions for cruise control (→ page 227).

Display messages	Possible causes/consequences and ► Solutions
Cruise Control Inoperative	<ul style="list-style-type: none"> * Cruise control is malfunctioning. <ul style="list-style-type: none"> ► Consult a qualified specialist workshop.
Cruise Control Off	<ul style="list-style-type: none"> * Cruise control has been deactivated. If there is an additional warning tone, cruise control has been deactivated automatically (→ page 226).
 <p>--- mph</p>	<ul style="list-style-type: none"> * Active Distance Assist DISTRONIC cannot be activated as not all activation conditions are fulfilled. <ul style="list-style-type: none"> ► Comply with the activation conditions of Active Distance Assist DISTRONIC (→ page 231).
 <p>Suspended</p>	<ul style="list-style-type: none"> * If you depress the accelerator pedal beyond the setting of Active Distance Assist DISTRONIC, the system will switch to passive mode (→ page 228).
 <p>Off</p>	<ul style="list-style-type: none"> * Active Distance Assist DISTRONIC was deactivated. If a warning tone also sounds, Active Distance Assist DISTRONIC has deactivated automatically (→ page 231).

Display messages	Possible causes/consequences and ► Solutions
<p>Active Distance Assist Currently Unavailable See Operator's Manual</p>	<p>* Active Distance Assist DISTRONIC is temporarily unavailable. The ambient conditions are outside the system limits (→ page 228). As soon as the ambient conditions are within the system limits, the system will become available again.</p> <ul style="list-style-type: none"> ► Drive on. or ► If the display message does not disappear, stop the vehicle in accordance with the traffic conditions and restart the vehicle.
<p>Active Distance Assist Inoperative</p>	<p>* Active Distance Assist DISTRONIC is malfunctioning. Other driving systems and driving safety systems may also be malfunctioning.</p> <ul style="list-style-type: none"> ► Drive on. or ► Stop the vehicle in accordance with the traffic conditions and restart the vehicle. ► If the display message does not disappear: consult a qualified specialist workshop.
<p>Active Distance Assist Now Available</p>	<p>* Active Distance Assist DISTRONIC is operational again.</p> <ul style="list-style-type: none"> ► Switch on Active Distance Assist DISTRONIC (→ page 231).
<p>Active Steering Assist Currently Unavailable See Operator's Manual</p>	<p>* Active Steering Assist is temporarily unavailable. The ambient conditions are outside the system limits (→ page 236). As soon as the ambient conditions are within the system limits, the system will become available again.</p>

Display messages	Possible causes/consequences and ► Solutions
	<ul style="list-style-type: none"> ► Drive on ► Check the tire pressure if necessary.
Active Steering Assist Inoperative	<ul style="list-style-type: none"> * Active Steering Assist is malfunctioning. Active Distance Assist DISTRONIC remains available. ► Drive on or ► Stop the vehicle in accordance with the traffic conditions and restart the vehicle. ► If the display message does not disappear: consult a qualified specialist workshop.
	<ul style="list-style-type: none"> * Active Steering Assist has reached the system limits (→ page 236). You have not steered independently for a considerable period of time. ► Take over the steering and drive on in accordance with the traffic conditions.
Active Steering Assist Currently Unavailable Due to Multiple Emergency Stops	<ul style="list-style-type: none"> * Active Steering Assist is temporarily unavailable due to multiple emergency stops. ► Take over the steering and stop in accordance with the traffic conditions. ► Switch the vehicle off and switch it back on Active Steering Assist is available once more.
 Beginning Emergency Stop	<ul style="list-style-type: none"> * Your hands are not on the steering wheel. The Active Steering Assist will initiate an emergency stop (→ page 236). ► Put your hands on the steering wheel. <p>Information on canceling an emergency stop (→ page 238).</p>

Display messages	Possible causes/consequences and ► Solutions
<p>Active Emergency Stop Assist Currently Unavailable See Operator's Manual</p>	<ul style="list-style-type: none"> * Active Emergency Stop Assist is temporarily unavailable. The ambient conditions are outside the system limits (→ page 238). As soon as the ambient conditions are within the system limits, the system will become available again. <ul style="list-style-type: none"> ► Drive on or ► If the display message does not disappear, stop the vehicle in accordance with the traffic conditions and restart the vehicle. * Vehicles without the Driving Assistance Package: Active Emergency Stop Assist is temporarily unavailable due to multiple emergency stops. <ul style="list-style-type: none"> ► Take over the steering and stop in accordance with the traffic conditions. ► Switch the vehicle off and switch it back on Active Emergency Stop Assist is available once more.
<p>Active Emergency Stop Assist Inoperative</p>	<ul style="list-style-type: none"> * Active Emergency Stop Assist is malfunctioning. <ul style="list-style-type: none"> ► Drive on. or ► Stop the vehicle in accordance with the traffic conditions and restart the vehicle. ► If the display message does not disappear: consult a qualified specialist workshop.

Display messages	Possible causes/consequences and ► Solutions
<p>Active Lane Change Assist Currently Unavailable See Operator's Manual</p>	<p>* Active Lane Change Assist is temporarily unavailable. The ambient conditions are outside the system limits (→ page 239). As soon as the ambient conditions are within the system limits, the system will become available again.</p> <ul style="list-style-type: none"> ► Drive on or ► If the display message does not disappear, stop the vehicle in accordance with the traffic conditions and restart the vehicle.
<p>Active Lane Change Assist Inoperative</p>	<p>* Active Lane Change Assist is malfunctioning.</p> <ul style="list-style-type: none"> ► Drive on or ► Stop the vehicle in accordance with the traffic conditions and restart the vehicle. ► If the display message does not disappear: consult a qualified specialist workshop.
<p>Active Stop & Go Assist Currently Unavailable See Operator's Manual</p>	<p>* Active Stop-and-Go Assist is temporarily unavailable. Active Distance Assist DISTRONIC and Active Steering Assist are still available. The ambient conditions are outside the system limits (→ page 228). As soon as the ambient conditions are within the system limits, the system will become available again.</p> <ul style="list-style-type: none"> ► Drive on.

Display messages	Possible causes/consequences and ► Solutions
<p>Active Stop & Go Assist Inoperative See Operator's Manual</p>	<p>* Active Stop-and-Go Assist is malfunctioning. Active Stop-and-Go Assist has been deactivated. Active Distance Assist DISTRONIC and Active Steering Assist are still available.</p> <ul style="list-style-type: none"> ► Drive on. or ► Stop the vehicle in accordance with the traffic conditions and restart the vehicle. ► If the display message does not disappear: consult a qualified specialist workshop.
<p>Traffic Sign Assist Currently Unavailable See Operator's Manual</p>	<p>* Traffic Sign Assist is temporarily unavailable. Once the cause of the problem is no longer present, the system will be available again.</p> <ul style="list-style-type: none"> ► Drive on
<p>Traffic Sign Assist Inoperative</p>	<p>* Traffic Sign Assist is malfunctioning.</p> <ul style="list-style-type: none"> ► Drive on or ► Stop the vehicle in accordance with the traffic conditions and restart the vehicle. ► If the display message does not disappear: consult a qualified specialist workshop.
<p>Blind Spot Assist Currently Unavailable See Operator's Manual</p>	<p>* Blind Spot Assist is temporarily unavailable. The system limits have been reached (→ page 252). Once the cause of the problem is no longer present, the system will be available again.</p>

Display messages	Possible causes/consequences and ► Solutions
	<ul style="list-style-type: none"> ► Drive on or ► If the display message does not disappear, stop the vehicle in accordance with the traffic conditions and restart the vehicle.
Blind Spot Assist Inoperative	<ul style="list-style-type: none"> * Blind Spot Assist is malfunctioning. ► Drive on or ► Stop the vehicle in accordance with the traffic conditions and restart the vehicle. ► If the display message does not disappear: consult a qualified specialist workshop.
Active Blind Spot Assist Currently Unavailable See Operator's Manual	<ul style="list-style-type: none"> * Active Blind Spot Assist is temporarily unavailable. The system limits have been reached (→ page 252). Once the cause of the problem is no longer present, the system will be available again. ► Drive on or ► If the display message does not disappear, stop the vehicle in accordance with the traffic conditions and restart the vehicle.
Active Blind Spot Assist Inoperative	<ul style="list-style-type: none"> * Active Blind Spot Assist is malfunctioning. ► Drive on or



466 Display messages and warning/indicator lamps

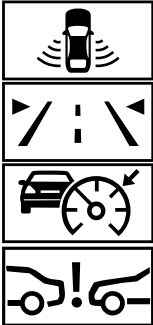

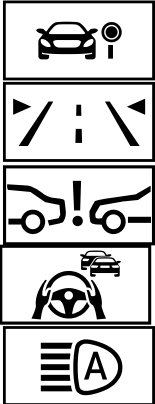
Display messages	Possible causes/consequences and ► Solutions
	<ul style="list-style-type: none">► Stop the vehicle in accordance with the traffic conditions and restart the vehicle.► If the display message does not disappear: consult a qualified specialist workshop.
Active Lane Keeping Assist Currently Unavailable See Operator's Manual	<p>* Active Lane Keeping Assist is temporarily unavailable. The ambient conditions are outside the system limits (→ page 255). As soon as the ambient conditions are within the system limits, the system will become available again.</p> <ul style="list-style-type: none">► Drive on
Active Lane Keeping Assist Inoperative	<p>* Active Lane Keeping Assist is malfunctioning.</p> <ul style="list-style-type: none">► Drive onor► Stop the vehicle in accordance with the traffic conditions and restart the vehicle.► If the display message does not disappear: consult a qualified specialist workshop.

Display messages	Possible causes/consequences and ► Solutions
 <p data-bbox="195 596 439 648">Temporarily Unavailable Sensors are Dirty</p>	<p data-bbox="528 249 1415 275">* Front and corner radar sensors (hereafter "sensors") are malfunctioning. Possible causes:</p> <ul data-bbox="550 285 1203 379" style="list-style-type: none"> <li data-bbox="550 285 787 306">• The sensors are dirty <li data-bbox="550 317 768 337">• Heavy rain or snow <li data-bbox="550 348 1203 379">• Extended country driving without other traffic, e.g. in the desert <p data-bbox="547 394 1696 446">Driving systems and driving safety systems may be malfunctioning or temporarily unavailable. The brake system, steering and drive system will continue to function normally.</p> <p data-bbox="547 456 667 477">► Drive on.</p> <p data-bbox="547 503 1696 555">Once the causes of the problem are no longer present, the driving systems and driving safety systems will be available again and the corresponding symbols will be switched off.</p> <p data-bbox="547 565 962 591">If the display message does not disappear:</p> <ul data-bbox="547 601 1142 695" style="list-style-type: none"> <li data-bbox="547 601 1142 627">► Stop the vehicle in accordance with the traffic conditions. <li data-bbox="547 638 1086 664">► Clean all sensor covers from outside (→ page 217). <li data-bbox="547 674 768 695">► Restart the vehicle.

Display messages	Possible causes/consequences and ► Solutions
 <p data-bbox="144 681 389 731">Temporarily Unavailable Camera View Restricted</p>	<p data-bbox="476 249 1147 270">* The view of the multifunction camera is restricted. Possible causes:</p> <ul data-bbox="500 283 1633 401" style="list-style-type: none"> <li data-bbox="500 283 1215 304">• Dirt on the windshield in the field of vision of the multifunction camera <li data-bbox="500 318 759 338">• Heavy rain, snow or fog <li data-bbox="500 352 1633 401">• Condensation on the inside of the windshield: in certain weather conditions, condensation can form on the inside of the windshield during cold times of year in particular. <p data-bbox="495 418 1646 468">ⓘ This condensation on the windshield will be removed automatically within a short time with the aid of a heater. The restriction is temporary.</p> <p data-bbox="495 481 1646 531">Driving systems and driving safety systems may be malfunctioning or temporarily unavailable. The brake system, steering and drive system will continue to function normally.</p> <p data-bbox="495 544 611 565">► Drive on</p> <p data-bbox="495 593 1646 643">Once the causes of the problem are no longer present, the driving systems and driving safety systems will be available again and the corresponding symbols will be switched off.</p> <p data-bbox="495 656 907 677">If the display message does not disappear:</p> <ul data-bbox="495 691 1411 781" style="list-style-type: none"> <li data-bbox="495 691 1092 711">► Stop the vehicle in accordance with the traffic conditions. <li data-bbox="495 724 1411 744">► Clean the windshield, especially in the position of the multifunction camera (→ page 217). <li data-bbox="495 758 717 779">► Restart the vehicle.
<p data-bbox="144 798 421 871">Driver Camera View Currently Restricted See Operator's Manual</p>	<p data-bbox="476 798 1060 819">* The view of the driver camera is reduced. Possible causes:</p> <ul data-bbox="500 832 1234 853" style="list-style-type: none"> <li data-bbox="500 832 1234 853">• Objects or stickers are projecting into the driver camera's field of vision.

Display messages	Possible causes/consequences and ► Solutions
	<ul style="list-style-type: none"> • The driver camera is dirty. ► Keep the driver camera's field of vision free. ► Clean the driver camera if necessary. Please comply with the notes on caring for the interior relating to the display (→ page 360).
<p>Change the steering wheel/ seat position until 6 dots are visible on the upper edge of the screen.</p>	<ul style="list-style-type: none"> * The driver camera cannot capture your line of sight. ► Change the steering wheel and seat position until six dots are visible on the top edge of the screen. The display message will appear again if the driver camera is again unable to detect your line of sight after 30 minutes. The display message will no longer appear at all if you confirm the display message and the driver camera cannot detect your line of sight during the entire journey.
<p>Driver Camera Inoperative See Operator's Manual</p>	<ul style="list-style-type: none"> * The driver camera is malfunctioning. ► Consult a qualified specialist workshop.
<div data-bbox="205 656 362 739" style="border: 1px solid black; padding: 5px; text-align: center;">  </div> <p>Malfunction Drive at Max. 50 mph</p>	<ul style="list-style-type: none"> * AIRMATIC is functioning only to a limited extent. The vehicle's handling characteristics may be affected. <div data-bbox="547 700 1696 843" style="border: 1px solid gray; padding: 5px;"> <p>NOTE The tires on the front axle or the fenders could be damaged by large steering movements</p> <ul style="list-style-type: none"> ► Avoid large steering movements while driving and listen for scraping sounds. ► If you hear scraping sounds, pull over and stop the vehicle in accordance with the traffic conditions, and set a higher vehicle level if possible. </div>

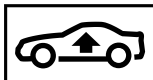
Display messages	Possible causes/consequences and ► Solutions
	<ul style="list-style-type: none"> ► Drive in a manner appropriate for the current level, but do not exceed 50 mph (80 km/h). ► Consult a qualified specialist workshop.
 <p>Maximum Speed 12mph</p>	<p>* AIRMATIC is functioning only to a limited extent. The vehicle's handling characteristics may be affected.</p> <ul style="list-style-type: none"> ► The current level is too high. Do not drive at speeds greater than 12 mph (20 km/h). ► Consult a qualified specialist workshop.
 <p>STOP Vehicle Level Too Low</p>	<p>* You have pulled away despite the vehicle level being too low.</p> <ul style="list-style-type: none"> ► Stop the vehicle in accordance with the traffic conditions. The vehicle will be raised to the selected vehicle level. ► Wait until the display message disappears before pulling away. <p>If the display message does not disappear and a warning tone also sounds, AIRMATIC is malfunctioning:</p> <ul style="list-style-type: none"> ► Do not drive at speeds greater than 50 mph (80 km/h) and consult a qualified specialist workshop immediately. <div style="border: 1px solid black; padding: 5px; margin-top: 10px;"> <p>! NOTE The tires on the front axle or the fenders could be damaged by large steering movements</p> <ul style="list-style-type: none"> ► Avoid large steering movements while driving and listen for scraping sounds. ► If you hear scraping sounds, pull over and stop the vehicle in accordance with the traffic conditions, and set a higher vehicle level if possible. </div>



Display messages	Possible causes/consequences and ► Solutions
	<ul style="list-style-type: none"> ► Set a higher vehicle level (→ page 259). Depending on the malfunction, the vehicle will be raised.
 <p>Vehicle Rising Please Wait</p>	<ul style="list-style-type: none"> * The vehicle level is too low. The vehicle will be raised to the selected vehicle level. <ul style="list-style-type: none"> ► Wait until the display message disappears before pulling away.
 <p>Compressor Is Cooling</p>	<ul style="list-style-type: none"> * Due to frequent level changes within a short space of time, the compressor first needs to cool down in order to set the selected vehicle level. When the compressor has cooled down, the vehicle will continue rising to the selected vehicle level. <ul style="list-style-type: none"> ► Drive on in a manner appropriate for the current level. Make sure that there is sufficient ground clearance.
<p>Active Parking Assist Limited Availability of Maneuvering Assistance See Operator's Manual</p>	<ul style="list-style-type: none"> * Active Parking Assist's maneuvering assistant is temporarily unavailable or only partially available. <ul style="list-style-type: none"> ► Clean all sensors of the parking and camera system (→ page 359). ► If the display message still appears, consult a qualified specialist workshop.
<p>PARKTRONIC Inoperative See Operator's Manual</p>	<ul style="list-style-type: none"> * Parking Assist PARKTRONIC is malfunctioning. Once the cause of the problem is no longer present, the system will be available again. <ul style="list-style-type: none"> ► Continue driving while paying attention to the vehicle's surroundings. <p>or</p>

472 Display messages and warning/indicator lamps

Display messages	Possible causes/consequences and ► Solutions
	<ul style="list-style-type: none">► Stop the vehicle in accordance with the traffic conditions and restart the vehicle.► If the display message still appears, consult a qualified specialist workshop.
<p>Active Parking Assist and PARKTRONIC Inoperative See Operator's Manual</p>	<p>* Active Parking Assist and Parking Assist PARKTRONIC are malfunctioning. Once the cause of the problem is no longer present, the system will be available again.</p> <ul style="list-style-type: none">► Continue driving while paying attention to the vehicle's surroundings. <p>or</p> <ul style="list-style-type: none">► Stop the vehicle in accordance with the traffic conditions and restart the vehicle.► If the display message still appears, consult a qualified specialist workshop.

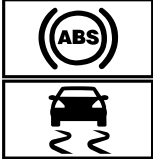
Driving safety systems

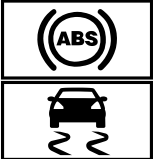
Display messages	Possible causes/consequences and ► Solutions
 <p data-bbox="197 467 458 519">Currently Unavailable See Operator's Manual</p>	<p data-bbox="526 291 1692 386">* ABS and ESP[®] are temporarily unavailable. Other driving systems and driving safety systems (e.g. BAS) may also be temporarily unavailable. The brake system will continue to operate normally. Braking distance may increase in an emergency braking situation.</p> <div data-bbox="550 405 1698 448" style="background-color: #f0f0f0; padding: 5px;"> <p data-bbox="559 415 1215 441">▲ WARNING Risk of skidding if ABS and ESP[®] are malfunctioning</p> </div> <p data-bbox="559 456 1650 541">The wheels may lock during braking and ESP[®] does not perform any vehicle stabilization. The steerability and braking characteristics are heavily impaired and the braking distance may increase. In addition, other driving safety systems are switched off.</p> <ul data-bbox="559 552 1633 664" style="list-style-type: none"> <li data-bbox="559 552 1615 601">► Drive carefully on a suitable stretch of road, making slight steering movements at a speed above 19 mph (30 km/h). <li data-bbox="559 612 1633 664">► If the display message does not disappear, consult a qualified specialist workshop immediately. Drive carefully.

Display messages	Possible causes/consequences and ► Solutions
 <p data-bbox="144 425 417 474">Inoperative See Operator's Manual</p>	<p data-bbox="476 249 1641 346">* ABS and ESP® are malfunctioning. Other driving systems and driving safety systems (e.g. BAS) may also be malfunctioning. The brake system will continue to operate normally. Braking distance may increase in an emergency braking situation.</p> <div data-bbox="500 363 1646 581" style="border: 1px solid black; padding: 5px;"> <p data-bbox="506 370 1166 399">▲ WARNING Risk of skidding if ABS and ESP® are malfunctioning</p> <p data-bbox="513 415 1387 441">The wheels may block during braking and ESP® does not perform any vehicle stabilization.</p> <p data-bbox="513 451 1600 498">The steerability and braking characteristics are heavily impaired and the braking distance may increase. In addition, other driving safety systems are switched off.</p> <ul style="list-style-type: none"> <li data-bbox="513 508 722 534">► Drive on carefully. <li data-bbox="513 544 1289 570">► Have ABS and ESP® checked immediately at a qualified specialist workshop. </div>
 <p data-bbox="144 689 408 738">Currently Unavailable See Operator's Manual</p>	<p data-bbox="476 596 1350 658">* ESP® is temporarily unavailable. Other driving systems and driving safety systems (e.g. BAS) may also be malfunctioning.</p> <div data-bbox="500 676 1646 852" style="border: 1px solid black; padding: 5px;"> <p data-bbox="506 683 1060 712">▲ WARNING Risk of skidding if ESP is malfunctioning®</p> <p data-bbox="513 728 1618 774">If ESP® is malfunctioning, ESP® cannot carry out vehicle stabilization. In addition, other driving safety systems are switched off.</p> <ul style="list-style-type: none"> <li data-bbox="513 785 1563 842">► Drive carefully on a suitable stretch of road, making slight steering movements at a speed above 19 mph (30 km/h). </div>

Display messages	Possible causes/consequences and ► Solutions
	<ul style="list-style-type: none"> ► If the display message does not disappear, consult a qualified specialist workshop immediately. Drive carefully.
 <p data-bbox="195 425 469 474">Inoperative See Operator's Manual</p>	<p data-bbox="526 334 778 360">* ESP® is malfunctioning.</p> <p data-bbox="543 368 1400 394">Other driving systems and driving safety systems (e.g. BAS) may also be malfunctioning.</p> <p data-bbox="543 404 1689 429">The brake system will continue to operate normally. Braking distance may increase in an emergency braking situation.</p> <div data-bbox="550 446 1696 487" style="background-color: #cccccc; padding: 5px;"> <p data-bbox="559 453 1114 482">▲ WARNING Risk of skidding if ESP® is malfunctioning</p> </div> <p data-bbox="559 496 1668 550">If ESP® is malfunctioning, ESP® cannot carry out vehicle stabilization. In addition, other driving safety systems are switched off.</p> <ul style="list-style-type: none"> ► Drive on carefully. ► Have ESP® checked at a qualified specialist workshop.

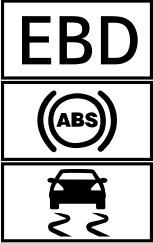
Display messages	Possible causes/consequences and ► Solutions
 <p data-bbox="144 511 417 560">Inoperative See Operator's Manual</p>	<p data-bbox="476 249 1350 311">* EBD, ABS and ESP® are malfunctioning. Other driving systems and driving safety systems (e.g. BAS) may also be malfunctioning.</p> <div data-bbox="500 329 1648 547" style="border: 1px solid black; padding: 5px;"> <p data-bbox="510 337 1221 365">▲ WARNING Risk of skidding if EBD, ABS and ESP® are malfunctioning</p> <p data-bbox="510 381 1391 407">The wheels may block during braking and ESP® does not perform any vehicle stabilization.</p> <p data-bbox="510 417 1600 467">The steerability and braking characteristics are heavily impaired and the braking distance may increase. In addition, other driving safety systems are switched off.</p> <ul data-bbox="510 477 1313 536" style="list-style-type: none"> <li data-bbox="510 477 722 503">► Drive on carefully. <li data-bbox="510 513 1313 536">► Have the brake system checked immediately at a qualified specialist workshop. </div>
<p data-bbox="144 588 417 660">Active Brake Assist Functions Currently Limited See Operator's Manual</p>	<p data-bbox="476 588 1637 638">* For vehicles with the Driving Assistance Package, the following functions may be temporarily unavailable or only partially available:</p> <ul data-bbox="500 648 972 741" style="list-style-type: none"> <li data-bbox="500 648 972 674">• Active Brake Assist with cross-traffic function <li data-bbox="500 684 753 710">• Evasive Steering Assist <li data-bbox="500 721 698 741">• PRE-SAFE® PLUS <p data-bbox="495 762 1230 788">Vehicles with Blind Spot Assist: PRE-SAFE® PLUS is temporarily unavailable.</p> <p data-bbox="495 798 1160 824">The ambient conditions are outside the system limits (→ page 242).</p> <p data-bbox="495 835 1419 860">Vehicles without the Driving Assistance Package: Active Brake Assist is temporarily unavailable.</p>

Display messages	Possible causes/consequences and ► Solutions
	<p>► Drive on. As soon as the ambient conditions are within the system limits, the system will become available again.</p> <p>or</p> <p>► If the display message does not disappear, stop the vehicle in accordance with the traffic conditions and restart the vehicle.</p>
<p>Active Brake Assist Functions Limited See Operator's Manual</p>	<p>* For vehicles with the Driving Assistance Package, the following functions may be temporarily unavailable or only partially available:</p> <ul style="list-style-type: none"> • Active Brake Assist with cross-traffic function • Evasive Steering Assist • PRE-SAFE® PLUS <p>Vehicles without the Driving Assistance Package: Active Brake Assist is temporarily unavailable or only partially available.</p> <p>► Drive on</p> <p>or</p> <p>► Stop the vehicle in accordance with the traffic conditions and restart the vehicle.</p> <p>► If the display message does not disappear: consult a qualified specialist workshop.</p>

Mercedes-Benz emergency call system

Display messages	Possible causes/consequences and ► Solutions
 <p>Inoperative</p>	<p>* The Mercedes-Benz emergency call system is malfunctioning. The Mercedes me connect system is also malfunctioning.</p> <ul style="list-style-type: none">► Consult a qualified specialist workshop.

Battery

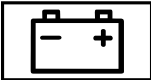

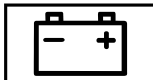
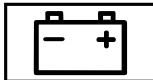
Display messages	Possible causes/consequences and ► Solutions
<p>Cannot Start Vehicle See Operator's Manual</p>	<p>* It is not possible to start the vehicle. A malfunction has occurred in the drive system.</p> <ul style="list-style-type: none">► Switch the vehicle off and lock it.► After waiting for a short time, unlock the vehicle and start it again.► If the display message appears again and the vehicle does not start, consult a qualified specialist workshop.
 <p>12 V On-board Electrical System Service Required</p>	<p>* The 12 V on-board electrical system is malfunctioning.</p> <ul style="list-style-type: none">► Consult a qualified specialist workshop immediately.



Display messages	Possible causes/consequences and ► Solutions
 <p data-bbox="194 341 443 388">Stop Vehicle See Operator's Manual</p>	<p data-bbox="526 248 1349 274">* The 12 V battery is no longer being charged and the condition of charge is too low.</p> <div data-bbox="545 290 1690 409" style="border: 1px solid black; padding: 5px;"> <p data-bbox="563 300 1118 326">! NOTE Possible engine damage if you continue driving</p> <ul style="list-style-type: none"> <li data-bbox="563 341 1081 367">▶ Do not continue driving under any circumstances. <li data-bbox="563 372 979 398">▶ Consult a qualified specialist workshop. </div> <ul style="list-style-type: none"> <li data-bbox="545 429 1506 455">▶ Stop the vehicle immediately in accordance with the traffic conditions. Do not continue driving. <li data-bbox="545 461 794 486">▶ Switch off the vehicle. <li data-bbox="545 492 960 518">▶ Consult a qualified specialist workshop.
 <p data-bbox="194 631 443 678">Switch on vehicle to charge the 12 V battery</p>	<p data-bbox="526 538 1275 564">* The vehicle is off and the condition of charge of the 12 V battery is too low.</p> <ul style="list-style-type: none"> <li data-bbox="545 574 1099 600">▶ Switch off electrical consumers that are not required. <li data-bbox="545 606 822 631">▶ Drive for 30–60 minutes. <p data-bbox="545 637 572 663">or</p> <ul style="list-style-type: none"> <li data-bbox="545 668 1118 694">▶ Charge the vehicle at a charging station (→ page 195).

Display messages	Possible causes/consequences and ► Solutions
 <p data-bbox="144 342 413 415">Stop vehicle To charge the 12 V battery do not switch off vehicle</p>	<p data-bbox="473 249 957 273">* The 12 V battery condition of charge is too low.</p> <ul style="list-style-type: none"> <li data-bbox="495 283 1452 307">► Stop the vehicle immediately in accordance with the traffic conditions. Do not continue driving. <li data-bbox="495 318 778 341">► Leave the vehicle running <li data-bbox="495 352 953 376">► If the display message disappears: drive on. <li data-bbox="495 386 1332 410">► If the display message does not disappear: consult a qualified specialist workshop.

Tire pressure monitor

Display messages	Possible causes/consequences and ► Solutions
<p data-bbox="144 571 389 619">Tire Press. Monitor Currently Unavailable</p>	<p data-bbox="473 571 1600 619">* There is interference from a powerful radio signal source As a result, no signals from the tire pressure sensors are being received. The tire pressure monitoring system is temporarily unavailable.</p> <p data-bbox="495 629 1485 653">The tire pressure monitoring system will restart automatically as soon as the cause has been rectified.</p> <ul style="list-style-type: none"> <li data-bbox="495 664 617 687">► Drive on.
<p data-bbox="144 708 426 756">Tire Press. Monitor Inoperative</p>	<p data-bbox="473 708 1021 732">* The tire pressure monitoring system is malfunctioning.</p> <div data-bbox="500 746 1646 855" style="background-color: #f0f0f0; padding: 5px;"> <p data-bbox="510 757 1483 781">▲ WARNING There is a risk of an accident if the tire pressure monitoring system is malfunctioning</p> <p data-bbox="510 791 1591 855">The tire pressure monitoring system cannot issue a warning if there is pressure loss in one or more of the tires. Tires with insufficient tire pressure may impair the driving characteristics as well as steering and braking.</p> </div>

Display messages	Possible causes/consequences and ► Solutions
	<p>► Have the tire pressure monitoring system checked at a qualified specialist workshop.</p>
<p>Tire Pressure Monitor Inoperative No Wheel Sensors</p>	<p>* The wheels installed do not have suitable tire pressure sensors. The tire pressure monitoring system is deactivated.</p> <p>► Install wheels with suitable tire pressure sensors.</p>
 <p>Wheel Sensor(s) Missing</p>	<p>* There is no signal from the tire pressure sensor of one or more wheels. No pressure value is displayed for the affected tire.</p> <p>► Have the faulty tire pressure sensor replaced at a qualified specialist workshop.</p>
 <p>Check Tires</p>	<p>* The tire pressure in one or more tires has dropped significantly. The wheel position is displayed. A warning tone will also sound.</p> <p>⚠ WARNING Risk of an accident due to insufficient tire pressure</p> <ul style="list-style-type: none"> • The tires can burst. • The tires can wear excessively and/or unevenly. • The driving characteristics as well as the steering and braking may be greatly impaired. <p>You could then lose control of the vehicle.</p> <p>► Observe the recommended tire pressures.</p> <p>► Adjust the tire pressure if necessary.</p>

Display messages	Possible causes/consequences and ► Solutions
 <p data-bbox="144 417 395 467">Please Correct Tire Pressure</p>	<p data-bbox="495 249 1092 309"> ► Stop the vehicle in accordance with the traffic conditions. ► Check the tire pressure (→ page 383) and the tires. </p> <p data-bbox="476 325 1637 446"> * The tire pressure is too low in at least one of the tires, or the difference in tire pressure between the individual wheels is too great. ► Check the tire pressure and add air, if necessary. ► When the tire pressure is correct, restart the tire pressure monitor (→ page 387). </p>
 <p data-bbox="144 588 395 609">Warning Tire Malfunction</p>	<p data-bbox="476 493 1443 516">* The tire pressure in one or more tires has dropped suddenly. The wheel position will be displayed.</p> <div data-bbox="495 534 1646 824" style="border: 1px solid black; padding: 5px;"> <p data-bbox="506 544 1110 568">⚠ WARNING Risk of an accident from driving with a flat tire</p> <ul data-bbox="519 586 1541 643" style="list-style-type: none"> • The tires can overheat and be damaged. • The driving characteristics as well as the steering and braking characteristics may be greatly impaired. <p data-bbox="513 664 922 684">You could then lose control of the vehicle.</p> <ul data-bbox="513 695 1600 814" style="list-style-type: none"> ► Do not drive with a flat tire. ► Do not exceed the maximum permissible driving distance in emergency mode and the maximum permissible speed with a flat MOExtended tire. ► Observe the notes on flat tires. </div> <p data-bbox="495 845 944 868">Notes in the event of a flat tire (→ page 364).</p>

Display messages	Possible causes/consequences and ► Solutions
	<ul style="list-style-type: none"> ► Stop the vehicle in accordance with the traffic conditions. ► Check the tires.
Tires Overheated	<p>* At least one tire is overheating. The affected tires are displayed in red. At temperatures close to the limit value, the tires are displayed in yellow.</p> <div style="background-color: #f0f0f0; padding: 5px; border: 1px solid #ccc;"> <p>▲ WARNING Risk of an accident from driving with overheated tires</p> <p>Overheated tires can burst.</p> <ul style="list-style-type: none"> ► Reduce speed so that the tires cool down. </div>
Decrease Speed	<p>* At least one tire is overheating. The affected tires are displayed in red. At temperatures close to the limit value, the tires are displayed in yellow.</p> <div style="background-color: #f0f0f0; padding: 5px; border: 1px solid #ccc;"> <p>▲ WARNING Risk of an accident from driving with overheated tires</p> <p>Overheated tires can burst.</p> <ul style="list-style-type: none"> ► Reduce speed so that the tires cool down. </div>

Warning and indicator lamps

Overview of indicator and warning lamps

Some systems will perform a self-test when the vehicle is switched on. Some indicator and warning lamps may briefly light up or flash. This behavior is non-critical. These indicator and warning lamps indicate a malfunction only if they light up or flash after the vehicle has been started or during a journey.



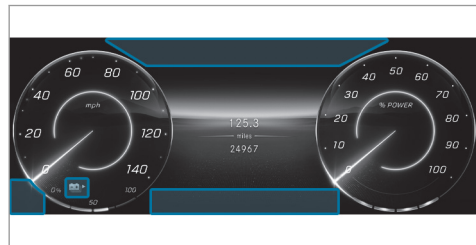



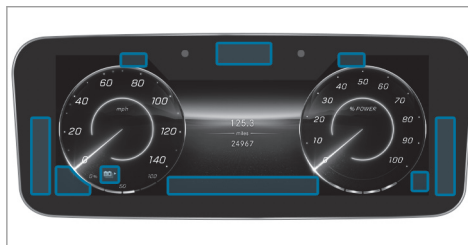

Driver display

























Driver display with driver camera



Indicator and warning lamps:



-  Restraint system (→ page 485)
-  Seat belt (→ page 485)
-  Reduced power (→ page 487)
-  System error (→ page 487)
-  Electrical malfunction (→ page 487)
-  Power steering (yellow) (→ page 488)
-  Power steering (red) (→ page 488)
-  Rear axle steering (yellow) (→ page 488)

-  Rear axle steering (red) (→ page 488)
-  USA: electric parking brake (red) (→ page 490)
-  Canada: electric parking brake (red) (→ page 490)
-  Electric parking brake (yellow) (→ page 490)
-  USA: Recuperative Brake System (→ page 490)
-  Canada: brakes (yellow) (→ page 490)
-  USA: brakes (red) (→ page 490)
-  Canada: brakes (red) (→ page 490)
-  Distance warning (→ page 493)
-  Active Brake Assist (→ page 493)
-  Active Brake Assist (→ page 493)
-  Active Brake Assist (→ page 493)
-  AIRMATIC (→ page 493)
-  ABS (→ page 495)
- ESP® (→ page 495)



	ESP® OFF (→ page 495)
	Mercedes-Benz emergency call system (→ page 497)
	Tire pressure monitoring system (→ page 498)
	Parking lights (→ page 143)
	Low beam (→ page 143)
	High beam (→ page 144)
	Turn signal lights (→ page 144)
	Rear fog light (→ page 143)

Occupant safety



Warning/indicator lamp	Possible causes/consequences and ► Solutions
 <p>Restraint system warning lamp</p>	<p>* The restraint system red warning lamp is lit while the vehicle is on. The restraint system is malfunctioning (→ page 44).</p> <p>⚠ DANGER Risk of death due to the restraint system malfunctioning</p> <p>Components in the restraint system may be activated unintentionally or not deploy as intended in an accident. In the event of an accident, the high-voltage on-board electrical system may not be deactivated as intended.</p>

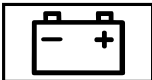

Warning/indicator lamp	Possible causes/consequences and ► Solutions
	<p>You may receive an electric shock if you touch the damaged components of the high-voltage on-board electrical system.</p> <ul style="list-style-type: none"> ► Have the restraint system checked and repaired immediately at a qualified specialist workshop. ► After an accident, switch off the vehicle immediately. <ul style="list-style-type: none"> ► Drive on carefully. ► Note the messages on the driver display. ► Consult a qualified specialist workshop immediately.
 <p>Seat belt warning lamp flashes</p>	<p>* The red seat belt warning lamp flashes and an intermittent warning tone sounds. The driver or front passenger has not fastened his/her seat belt while the vehicle is in motion.</p> <ul style="list-style-type: none"> ► Fasten your seat belt (→ page 48). <p>There are objects on the front passenger seat.</p> <ul style="list-style-type: none"> ► Remove the objects from the front passenger seat.
 <p>Seat belt warning lamp lights up</p>	<p>* The red seat belt warning lamp lights up for six seconds once the vehicle has started. In addition, an intermittent warning tone may sound. The red seat belt warning lamp reminds the driver and front passenger to fasten their seat belts.</p> <ul style="list-style-type: none"> ► Fasten your seat belt (→ page 48). <p>If you have placed objects on the front passenger seat, the red seat belt warning lamp may remain lit.</p>

Drive system



Warning/indicator lamp	Possible causes/consequences and ► Solutions
 <p data-bbox="195 381 421 433">Reduced warning lamp power</p>	<p data-bbox="513 288 981 339">* The yellow reduced-power warning lamp is on. Drive system power output is reduced.</p> <p data-bbox="528 350 962 376">► Note the messages on the driver display.</p>
 <p data-bbox="195 541 463 567">System error warning lamp</p>	<p data-bbox="513 451 1507 503">* The red system error warning lamp is lit while the vehicle is in a state of operational readiness READY. There is a malfunction in the drive system.</p> <p data-bbox="528 513 962 539">► Note the messages on the driver display.</p>
 <p data-bbox="195 676 473 728">Electrical malfunction warning lamp</p>	<p data-bbox="513 583 1009 635">* The red electrical malfunction warning lamp is lit. There is a malfunction with the electrics.</p> <p data-bbox="528 645 962 671">► Note the messages on the driver display.</p>





Vehicle

Warning/indicator lamp	Possible causes/consequences and ► Solutions
 <p data-bbox="144 381 376 433">Power steering warning lamp (yellow)</p>	<p data-bbox="463 291 1243 339">* The yellow power steering warning lamp is lit while the drive system is running. The power assistance or the steering itself is malfunctioning.</p> <ul style="list-style-type: none"> <li data-bbox="476 350 907 376">► Note the messages on the driver display.
 <p data-bbox="144 542 376 594">Power steering warning lamp (red)</p>	<p data-bbox="463 452 1215 501">* The red power steering warning lamp is lit while the drive system is running. The power assistance or the steering itself is malfunctioning.</p> <div data-bbox="482 519 1646 697" style="border: 1px solid black; padding: 5px;"> <p data-bbox="491 526 1114 552">▲ WARNING Risk of accident if steering capability is impaired</p> <p data-bbox="491 567 1369 593">If the steering does not function as intended, the vehicle's operating safety is jeopardized.</p> <ul style="list-style-type: none"> <li data-bbox="491 603 1613 652">► Pull over and stop the vehicle safely as soon as possible, paying attention to road and traffic conditions. Do not continue driving under any circumstances. <li data-bbox="491 663 916 688">► Consult a qualified specialist workshop. </div> <ul style="list-style-type: none"> <li data-bbox="476 714 907 740">► Note the messages on the driver display.

Warning/indicator lamp	Possible causes/consequences and ► Solutions
 <p>Rear axle steering warning lamp (yellow)</p>	<p>* The yellow rear axle steering warning lamp is lit while the drive system is running. The rear axle steering is malfunctioning.</p> <ul style="list-style-type: none"> ► Note the messages on the driver display.
 <p>Rear axle steering warning lamp (red)</p>	<p>* The red rear axle steering warning lamp is lit while the drive system is running. The rear axle steering is malfunctioning.</p> <div style="border: 1px solid black; padding: 5px; margin-top: 10px;"> <p>⚠ WARNING Risk of accident if steering capability is impaired</p> <p>If the steering does not function as intended, the vehicle's operating safety is jeopardized.</p> <ul style="list-style-type: none"> ► Pull over and stop the vehicle safely as soon as possible, paying attention to road and traffic conditions. Do not continue driving under any circumstances. ► Consult a qualified specialist workshop. </div> <ul style="list-style-type: none"> ► Note the messages on the driver display.



Brakes



Warning/indicator lamp	Possible causes/consequences and ► Solutions
<p data-bbox="155 291 310 373"></p> <p data-bbox="144 381 413 433">Electric parking brake indicator lamp (red) (USA only)</p> <p data-bbox="155 439 310 522"></p> <p data-bbox="144 529 413 607">Electric parking brake indicator lamp (red) (Canada only)</p> <p data-bbox="155 613 310 696"></p> <p data-bbox="144 703 402 755">The electric parking brake (yellow) indicator lamp</p>	<p data-bbox="463 289 1068 314">* The red electric parking brake indicator lamp flashes or is lit.</p> <p data-bbox="476 322 1326 348">The yellow electric parking brake indicator lamp is also lit in the event of a malfunction.</p> <p data-bbox="476 355 909 381">► Note the messages on the driver display.</p>

Warning/indicator lamp	Possible causes/consequences and ► Solutions
 <p>Recuperative Brake System warning lamp (USA only)</p>  <p>Brakes warning lamp (yellow) (Canada only)</p>	<p>*The yellow  warning lamp (USA only) or the yellow  brake warning lamp (Canada only) is lit while the vehicle is running.</p> <p>▲ WARNING Risk of an accident due to a brake system malfunction</p> <p>If the brake system is malfunctioning, braking characteristics may be impaired.</p> <ul style="list-style-type: none">► Drive on carefully.► Have the brake system checked immediately at a qualified specialist workshop. <p>The hill start assist may be malfunctioning.</p> <ul style="list-style-type: none">► Adjust your speed and drive on carefully, leaving a suitable distance to the vehicle in front.► If the driver display shows a display message, observe it.► Consult a qualified specialist workshop.

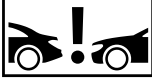

Warning/indicator lamp	Possible causes/consequences and ► Solutions
<div data-bbox="155 251 312 332" data-label="Image"> </div> <p data-bbox="144 342 395 391">Brake warning lamp (USA only)</p> <div data-bbox="155 397 312 478" data-label="Image"> </div> <p data-bbox="144 488 413 537">Brake system warning lamp (Canada only)</p>	<p data-bbox="458 249 1068 273">* The red brake warning lamp is lit while the vehicle is running.</p> <p data-bbox="476 283 639 307">Possible causes:</p> <ul data-bbox="482 318 1402 373" style="list-style-type: none"> <li data-bbox="482 318 1402 341">• The brake force boosting is malfunctioning and the braking characteristics may be affected. <li data-bbox="482 351 1073 373">• There is insufficient brake fluid in the brake fluid reservoir. <p data-bbox="476 394 907 418">► Note the messages on the driver display.</p> <div data-bbox="482 439 1646 477" data-label="Section-Header"> <p>▲ WARNING Risk of accident and injury if brake force boosting is malfunctioning</p> </div> <p data-bbox="495 485 1591 534">If brake force boosting is malfunctioning, increased brake pedal force may be necessary for braking. The braking characteristics may be impaired. The braking distance can increase in emergency braking situations.</p> <ul data-bbox="495 544 1116 600" style="list-style-type: none"> <li data-bbox="495 544 1116 568">► Stop in a safe location immediately. Do not continue driving. <li data-bbox="495 578 916 600">► Consult a qualified specialist workshop. <div data-bbox="482 631 1646 670" data-label="Section-Header"> <p>▲ WARNING Risk of an accident due to low brake fluid level</p> </div> <p data-bbox="495 678 1467 702">If the brake fluid level is too low, the braking effect and the braking characteristics may be impaired.</p> <ul data-bbox="495 712 1609 832" style="list-style-type: none"> <li data-bbox="495 712 1609 761">► Pull over and stop the vehicle safely as soon as possible, paying attention to road and traffic conditions. Do not continue driving under any circumstances. <li data-bbox="495 770 916 794">► Consult a qualified specialist workshop. <li data-bbox="495 803 753 827">► Do not add brake fluid.



Driving systems

Warning/indicator lamp	Possible causes/consequences and ► Solutions
 <p data-bbox="195 384 454 433">Warning lamp for distance warning function</p>	<p data-bbox="513 291 1212 339">* The red distance warning lamp lights up while the vehicle is in motion. The distance to the vehicle in front is too small for the speed selected.</p> <p data-bbox="528 353 1411 373">If there is an additional warning tone, you are approaching an obstacle at too high a speed.</p> <ul style="list-style-type: none"> <li data-bbox="528 387 898 408">► Be prepared to brake immediately. <li data-bbox="528 421 781 442">► Increase the distance. <p data-bbox="528 463 981 483">Function of Active Brake Assist (→ page 242).</p>
 <p data-bbox="195 599 463 648">Active Brake Assist warning lamp</p>	<p data-bbox="513 506 1535 555">* The Active Brake Assist warning lamp is on. Due to dirty sensors or a malfunction, the system is not available or the range of functions is restricted.</p> <ul style="list-style-type: none"> <li data-bbox="528 568 959 589">► Note the messages on the driver display.
 <p data-bbox="195 760 463 809">Active Brake Assist warning lamp</p>	<p data-bbox="513 667 1548 750">* The Active Brake Assist warning lamp is on. The system is switched off or the range of functions has been automatically restricted. This may be the case if the driver is not wearing a seat belt or another driving system has been activated.</p> <ul style="list-style-type: none"> <li data-bbox="528 763 1116 784">► Observe the notes on Active Brake Assist (→ page 242).

Warning/indicator lamp	Possible causes/consequences and ► Solutions
 <p data-bbox="144 342 417 391">Active Brake Assist warning lamp</p>	<p data-bbox="458 249 1369 332">* The Active Brake Assist warning lamp is on. After you drive off, the system's range of functions is restricted due to the teach-in process. Depending on the ambient conditions, the teach-in process may take a few minutes.</p> <p data-bbox="476 342 1068 368">► Observe the notes on Active Brake Assist (→ page 242).</p>
 <p data-bbox="144 503 399 552">Suspension warning lamp (yellow)</p>	<p data-bbox="458 410 883 458">* The yellow AIRMATIC warning lamp is lit. A malfunction has occurred in AIRMATIC.</p> <p data-bbox="476 469 911 495">► Note the messages on the driver display.</p>
 <p data-bbox="144 660 399 709">Suspension warning lamp (red)</p>	<p data-bbox="458 567 883 616">* The red AIRMATIC warning lamp is lit. A malfunction has occurred in AIRMATIC.</p> <div data-bbox="482 640 1646 723" style="border: 1px solid black; padding: 5px;"> <p data-bbox="495 647 1252 673">! NOTE The vehicle's driving characteristics will have changed significantly.</p> <p data-bbox="495 683 920 709">► Consult a qualified specialist workshop.</p> </div> <p data-bbox="476 740 911 766">► Note the messages on the driver display.</p> <p data-bbox="476 777 901 802">► Consult a qualified specialist workshop.</p>

Driving safety systems

Warning/indicator lamp	Possible causes/consequences and ► Solutions
 <p data-bbox="195 381 375 407">ABS warning lamp</p>	<p data-bbox="513 288 1136 339">* The yellow ABS warning lamp is lit while the vehicle is running. ABS is malfunctioning.</p> <p data-bbox="526 350 1112 376">If an additional warning tone sounds, EBD is malfunctioning.</p> <p data-bbox="526 386 1280 412">Other driving systems and driving safety systems may also be malfunctioning.</p> <ul style="list-style-type: none"> <li data-bbox="526 422 960 448">► Note the messages on the driver display. <div style="border: 1px solid black; padding: 5px; margin-top: 10px;"> <p data-bbox="539 469 1252 495">⚠ WARNING There is a risk of skidding if EBD or ABS is malfunctioning</p> <p data-bbox="545 510 901 536">The wheels may lock during braking.</p> <p data-bbox="545 547 1668 593">The steerability and braking characteristics are heavily impaired and the braking distance may increase. In addition, other driving safety systems are switched off.</p> <ul style="list-style-type: none"> <li data-bbox="545 603 757 629">► Drive on carefully. <li data-bbox="545 640 1349 666">► Have the brake system checked immediately at a qualified specialist workshop. </div>
 <p data-bbox="195 785 462 811">ESP® warning lamp flashes</p>	<p data-bbox="513 692 1191 743">* The yellow ESP® warning lamp flashes while the vehicle is in motion. One or more wheels have reached their grip limit (→ page 220).</p> <ul style="list-style-type: none"> <li data-bbox="526 754 1186 780">► Adapt your driving style to suit the road and weather conditions.



Warning/indicator lamp	Possible causes/consequences and ► Solutions
 <p data-bbox="144 342 426 370">ESP® warning lamp lights up</p>	<p data-bbox="463 249 1332 339">* The yellow ESP® warning lamp is lit while the vehicle is running. ESP® is malfunctioning. Other driving systems and driving safety systems (e.g. BAS) may also be malfunctioning.</p> <ul data-bbox="476 350 907 373" style="list-style-type: none">► Note the messages on the driver display. <div data-bbox="482 391 1646 578"><p data-bbox="491 401 1045 428">▲ WARNING Risk of skidding if ESP® is malfunctioning</p><p data-bbox="495 443 1604 495">If ESP® is malfunctioning, ESP® cannot carry out vehicle stabilization. In addition, other driving safety systems are switched off.</p><ul data-bbox="495 505 1060 567" style="list-style-type: none">► Drive on carefully.► Have ESP® checked at a qualified specialist workshop.</div>
 <p data-bbox="144 684 380 712">ESP® OFF warning lamp</p>	<p data-bbox="463 591 1142 643">* The yellow ESP® OFF warning lamp is lit while the vehicle is running. ESP® is deactivated.</p> <p data-bbox="476 656 1193 681">Other driving systems and driving safety systems may also be inoperative.</p> <div data-bbox="482 702 1646 860"><p data-bbox="491 712 1147 739">▲ WARNING Risk of skidding when driving with ESP® deactivated</p><p data-bbox="495 754 1517 778">ESP® does not act to stabilize the vehicle. The availability of further driving safety systems is also limited.</p><ul data-bbox="495 788 1097 850" style="list-style-type: none">► Drive on carefully.► Deactivate ESP® only for as long as the situation requires.</div>

Warning/indicator lamp	Possible causes/consequences and ► Solutions
	<p>If ESP® cannot be activated, ESP® is malfunctioning.</p> <ul style="list-style-type: none">► Have ESP® checked immediately at a qualified specialist workshop. <p>► Observe the notes on deactivating ESP® (→ page 220).</p>

Mercedes-Benz emergency call system

Warning/indicator lamp	Possible causes/consequences and ► Solutions
 <p>Mercedes-Benz emergency call system warning lamp</p>	<p>*The Mercedes-Benz emergency call system is malfunctioning. The Mercedes me connect system is also malfunctioning.</p> <ul style="list-style-type: none">► Consult a qualified specialist workshop.

Tire pressure monitor

Warning/indicator lamp	Possible causes/consequences and ► Solutions
 <p>Tire pressure monitoring system warning lamp flashes</p>	<p>*The yellow tire pressure monitor warning lamp (pressure loss/malfunction) flashes for approximately one minute and then remains lit. The tire pressure monitor is malfunctioning.</p> <p>▲ WARNING There is a risk of an accident if the tire pressure monitoring system is malfunctioning</p> <p>The tire pressure monitoring system cannot issue a warning if there is pressure loss in one or more of the tires. Tires with insufficient tire pressure may impair the driving characteristics as well as steering and braking.</p> <p>► Have the tire pressure monitoring system checked at a qualified specialist workshop.</p>
 <p>Tire pressure monitoring system warning lamp lights up</p>	<p>*The yellow tire pressure monitoring system warning lamp (pressure loss/malfunction) is lit. The tire pressure monitoring system has detected tire pressure loss in at least one of the tires.</p> <p>▲ WARNING Risk of an accident due to insufficient tire pressure</p> <ul style="list-style-type: none"> • The tires can burst. • The tires can wear excessively and/or unevenly. • The driving characteristics as well as the steering and braking may be greatly impaired. <p>You could then lose control of the vehicle.</p> <p>► Observe the recommended tire pressures.</p> <p>► Adjust the tire pressure if necessary.</p>

Warning/indicator lamp	Possible causes/consequences and ► Solutions
	<ul style="list-style-type: none"><li data-bbox="528 249 1123 275">► Stop the vehicle in accordance with the traffic conditions.<li data-bbox="528 285 925 311">► Check the tire pressure and the tires.

1, 2, 3 ...**4MATIC**

- All-wheel distribution..... 195
- Function..... 195

12 V battery

- see On-board electrical system battery (12 V)

A**A/C function**

- Activating/deactivating (control panel)... 166
- Activating/deactivating (MBUX multi-media system)..... 167

ABS (Anti-lock Braking System)..... 219**Acceleration increase**

- Notes..... 183

Accelerator pedal

- see Haptic accelerator pedal

Accident and Breakdown Management

- Mercedes me connect..... 340

Acoustic locking verification signal

- Activating/deactivating..... 74

Acoustic presence indicator (sound generator)

- Notes..... 178

Activating a commuter route..... 325**Active Blind Spot Assist**

- Activating/deactivating..... 255
- Brake application..... 254
- Function..... 252
- System limitations..... 252

Active Brake Assist

- Function/notes..... 242
- Setting..... 246

Active Distance Assist DISTRONIC

- Active Emergency Stop Assist..... 238
- Active Lane Change Assist..... 239
- Calling up a speed..... 231
- Function..... 228
- Increasing/decreasing the speed..... 231
- Route-based speed adaptation..... 234
- Storing a speed..... 231
- Switching off/deactivating..... 231
- Switching on/activating..... 231
- System limitations..... 228

Active Emergency Stop Assist..... 238**Active headlamps..... 146****Active Lane Change Assist**

- Activating/deactivating..... 242
- Function..... 239

Active Lane Keeping Assist

- Activating/deactivating..... 258
- Activating/deactivating the warning..... 258
- Function..... 255
- Setting the sensitivity..... 258
- System limits..... 255

Active Parking Assist

- Automatic braking function..... 275
- Cross traffic warning..... 280
- Drive Away Assist..... 279
- Exiting a parking space..... 274
- Function..... 270
- Maneuvering brake function..... 281
- Parking..... 272
- Pausing..... 275
- System limitations..... 270

Active Service System PLUS

- see ASSYST PLUS

Active Speed Limit Assist

- Display..... 233

- Function..... 233
- Active Steering Assist**
- Activating/deactivating..... 238
- Active Emergency Stop Assist..... 238
- Active Lane Change Assist..... 239
- Function..... 236
- System limits..... 236
- Active Traffic Jam Assist**
- Function..... 235
- Adaptive cruise control**
- see Active Distance Assist DISTRONIC
- Adaptive Highbeam Assist**
- Activating/deactivating..... 151
- Function..... 150
- Adaptive Highbeam Assist Plus**
- Function..... 152
- Switching on/off..... 153
- ADS PLUS damping system**
- see AIRMATIC
- After-sales service**
- see ASSYST PLUS
- Air bag**
- Reduced protection..... 52
- Air conditioning menu**
- Calling up..... 166
- Selecting climate modes..... 167
- Air conditioning system**
- see Climate control
- Air distribution**
- Setting..... 163
- Setting (3-zone automatic climate control)..... 164
- Setting (MBUX multimedia system)..... 168
- Air freshener system**
- see Fragrance system
- Air inlet**
- see Air-water duct
- Air pressure**
- see Tire pressure
- Air suspension**
- see AIRMATIC
- Air vents**
- Adjusting (front)..... 176
- Adjusting (rear)..... 176
- Air vents**
- see Air vents
- Air-conditioning system**
- see Climate control
- Air-recirculation mode (with fine particle prefilter)..... 169, 170**
- Air-water duct**
- Keeping free..... 355
- Airbag**
- Activation..... 44
- Automatic co-driver airbag shutoff..... 53
- Belt airbag..... 48
- Front airbag (driver, front passenger)..... 50
- Installation locations..... 50
- Knee airbag..... 50
- Overview..... 50
- PASSENGER AIR BAG indicator lamps..... 54
- Protection..... 51
- Side airbag..... 50
- Window curtain airbag..... 50
- Airflow**
- Setting..... 163
- Setting (3-zone automatic climate control)..... 164
- AIRMATIC**
- Setting..... 259

- Suspension..... 258
- Alarm**
see Panic alarm
- Alarm system**
see ATA (anti-theft alarm system)
- All-wheel drive**
see 4MATIC
- Alternative route**
see Route
- Ambient lighting**
Setting (MBUX multimedia system)..... 155
- Android Auto**
see Smartphone integration
- Animals**
Pets in the vehicle..... 72
- Anti-lock braking system**
see ABS (Anti-lock Braking System)
- Anti-skid chains**
see Snow chains
- Anti-theft protection**
Immobilizer..... 99
- Anti-theft protection**
see ATA (anti-theft alarm system)
- Anticipatory occupant protection**
see PRE-SAFE® (anticipatory occupant protection)
see PRE-SAFE® PLUS (anticipatory occupant protection plus)
- Apple CarPlay®**
see Smartphone integration
- Assistance systems**
see Driving safety system
- ASSYST PLUS**
Battery disconnection periods..... 354
Displaying the service due date..... 353
Function/notes..... 353
Regular maintenance work..... 353
Special service requirements..... 353
- ATA (anti-theft alarm system)**
Activating/deactivating the interior motion sensor..... 101
Arming/disarming the tow-away alarm... 101
Deactivating the alarm..... 100
Function..... 99
Interior motion sensor function..... 101
- The tow-away alarm function..... 100
- ATTENTION ASSIST**
Setting..... 226
- ATTENTION ASSIST with microsleeep detection**
Function..... 224
System limits..... 224
- Attention assistant**
see ATTENTION ASSIST with microsleeep detection
- Augmented reality**
Function on the Head-up Display..... 290
- Authorized Mercedes-Benz Center**
see Qualified specialist workshop
- Authorized workshop**
see Qualified specialist workshop
- Automatic co-driver airbag shutoff**
Function of co-driver airbag shutoff..... 53
- Automatic distance control**
see Active Distance Assist DISTRONIC
- Automatic driving lights**..... 144
- Automatic front passenger airbag shutoff**
PASSENGER AIR BAG indicator lamps..... 54

- Automatic measures after an accident..... 58
- Automatic mirror folding function**
 Activating/deactivating..... 162
- Automatic seat adjustment**
 Setting..... 111
- B**
- Back seat**
 see Seats
- Bad weather light**..... 148
- Bag hook**..... 132
- BAS (Brake Assist System)**..... 219
- Battery**
 see High-voltage battery
- Battery (high-voltage on-board electrical system)**
 see High-voltage battery
- Battery (SmartKey)**
 Replacing..... 75
- Battery (vehicle)**
 Notes..... 370
- Beginner driver mode**
 Activating/deactivating..... 224
- Belt**
 see Seat belt
- Belt airbag**
 Activation..... 44
 Function/notes..... 48
- Blind Spot Assist**
 Activating/deactivating..... 255
 Function..... 252
 System limitations..... 252
- Blower**
 see Climate control
- Brake Assist System**
 see BAS (Brake Assist System)
- Brake fluid**
 Notes..... 414
- Brake force distribution**
 EBD (electronic brake force distribution)..... 221
- Brakes**
 ABS (Anti-lock Braking System)..... 219
 Active Brake Assist..... 242
 BAS (Brake Assist System)..... 219
 Breaking-in notes..... 182
 Driving tips..... 183
 EBD (electronic brake force distribution)..... 221
 HOLD function..... 221
 Limited braking effect (salt-treated roads)..... 183
 New/replaced brake linings/brake discs..... 182
 Post-collision brake..... 58
- Brakes**
 see Recuperation
- Braking assistance**
 see BAS (Brake Assist System)
- Breakdown**
 Assistance overview..... 24
 Changing a wheel..... 404
 Roadside Assistance..... 30
 Tow-starting..... 378
 Towing away..... 373
 Transporting the vehicle..... 375
- Breakdown**
 see Flat tire

Breaking-in notes..... 182

C

Calls

Mercedes me..... 336

Camera

Information..... 217

Camera

see Dashcam

see Driver camera

see Rear view camera

see Surround view camera

Car key

see SmartKey

Car wash

see Care

Car wash (care)..... 356

Car-to-X-Communication

Displaying hazard warnings..... 329

Care

Air-water duct..... 355

Automatic car wash..... 356

Carpet..... 360

Decorative foil..... 358

Display..... 360

Exterior lighting..... 359

Head-up Display..... 360

Headliner..... 360

Paint..... 358

Plastic trim..... 360

Power washer..... 357

Real wood/trim elements..... 360

Rear view camera..... 359

Seat belt..... 360

Seat cover..... 360

Sensors..... 359

Steering wheel..... 360

Surround view camera..... 359

Vehicle socket for the high-voltage
battery..... 359

Washing by hand..... 357

Wheels/rims..... 359

Windows..... 359

Wiper blades..... 359

Cargo compartment cover

Extending/retracting..... 129

Notes..... 128

Removing/installing..... 129

Cargo tie-down rings..... 132

Carpet (Care)..... 360

Change of address..... 30

Change of ownership..... 30

Changing a wheel

Preparation..... 404

Raising the vehicle..... 404

Changing a wheel

see Emergency spare wheel

Charging

At time of departure..... 209

Charging cable control panel..... 200

Condition of charge display..... 208

Configuring weekly profile..... 209

Ending the charging process (alternat-
ing current, mode 2/3)..... 205

Ending the charging process (direct
current, mode 4)..... 207

Indicator lamps on vehicle socket..... 202

Maximum charging current (mains
socket)..... 200

Notes - charging station (mode 3)..... 198































Notes - fast charging station (mode 4).... 199







































Notes - mains socket (Mode 2)..... 197

- Notes - wallbox (mode 3)..... 198
 Notes on charging the high-voltage battery..... 195
 Notes on the high-voltage battery..... 371
 Notes on wireless charging..... 138
 On-board electrical system battery (12 V)..... 372
 Starting the charging process (alternating current, mode 2/3)..... 202
 Starting the charging process (direct current, mode 4)..... 205
 Stowing the charging cable..... 195
 USB port..... 138
- Charging cable**
 Control panel..... 200
 Stowing..... 195
- Child safety lock**
 Rear doors..... 70
 Rear side windows..... 72
- Child seat**
 Attaching (notes)..... 62
 Basic instructions..... 58
 Front-passenger seat (notes)..... 69
 LATCH-type (ISOFIX) (installing)..... 63
 Notes on risks and dangers..... 59
 Securing on the front passenger seat..... 69
 Securing on the rear seat..... 67
 Top Tether..... 66
- Children**
 Avoiding dangers in the vehicle..... 59
 Basic instructions..... 58
 Special seat belt retractor..... 63
- Chock**
 Storage location..... 403
- Chock**
 see Chock
- City lighting**..... 148
- Cleaning**
 see Care
- Cleaning fluid**
 see Windshield washer fluid
- Climate control**
 Activating/deactivating..... 166
 Activating/deactivating (rear operating unit)..... 166
 Activating/deactivating the A/C function (control panel)..... 166
 Activating/deactivating the A/C function (MBUX multimedia system)..... 167
 Activating/deactivating the fragrance system..... 170
 Activating/deactivating the synchronization function (MBUX multimedia system)..... 169
 Air-recirculation mode (with fine particle prefilter)..... 169, 170
 Automatic control..... 167
 Calling up the air conditioning menu..... 166
 Control panel for 3-zone automatic climate control..... 164
 Control panel for dual-zone automatic climate control..... 163
 Defrost..... 167
 Defrosting the windshield..... 163
 Defrosting the windshield (3-zone automatic climate control)..... 164
 Filling capacity for refrigerant and PAG oil..... 418
 Front air vents..... 176
 Immediate pre-entry climate control..... 175
 Information on the windshield heater..... 172
 Inserting/removing the flacon (fragrance system)..... 171
 Ionization..... 170
 Note..... 163

- Pre-entry climate control at departure time..... 173
- Pre-entry climate control when the vehicle is unlocked..... 172
- Rear air vents..... 176
- Rear operating unit..... 22, 165
- Refrigerant..... 416
- Removing condensation from the windows..... 169
- Setting (MBUX multimedia system)..... 166
- Setting the air distribution..... 163
- Setting the air distribution (3-zone automatic climate control)..... 164
- Setting the airflow..... 163
- Setting the airflow (3-zone automatic climate control)..... 164
- Setting the fragrance system..... 170
- Setting the temperature..... 163
- Setting the temperature (3-zone automatic climate control)..... 164
- Switching the rear window heater on/off..... 163
- Switching the rear window heater on/off (3-zone automatic climate control)..... 164
- Ventilating the vehicle (convenience opening)..... 94
- Clothes hooks**
Using..... 133
- Co-driver airbag shutoff**
see Automatic co-driver airbag shutoff
- Cockpit**
Overview (central display)..... 6
Overview (MBUX Hyperscreen)..... 8
- Coffee cup symbol**
see ATTENTION ASSIST with micro-sleep detection
- Collision detection (parked vehicle)**
Setting..... 216
- Combination switch**..... 144
- Component-specific information**..... 412
- Content sharing menu**
Overview..... 301
- Control elements**
Touch-sensitive..... 29
- Convenience closing**..... 94
- Convenience doors**
Setting (MBUX multimedia system)..... 85
- Convenience doors**
see Door
- Convenience opening**..... 94
- Coolant (engine)**
Capacity..... 416
Level check..... 355
Notes..... 415
- Cooling**
see Climate control
- Copyrights**
License..... 42
Trademarks..... 42
- Cornering light**..... 147
- Crosswind Assist**
Function/notes..... 221
- Cruise control**
Activating..... 227
Buttons..... 227
Calling up a speed..... 227
Deactivating..... 227
Function..... 226

- Requirements..... 227
- Selecting..... 227
- Setting a speed..... 227
- Storing a speed..... 227
- System limitations..... 226
- Cup holder**
 - Installing/removing (center console)..... 135
 - Using..... 137
- Customer Assistance Center (CAC)..... 36**
- Customer Relations Department..... 36**
- D**
- Dashcam**
 - Notes..... 331
 - Selecting a USB device..... 332
 - Starting/stopping a video recording..... 332
- Data acquisition**
 - Vehicle..... 37
- Data protection rights**
 - Data storage..... 40
- Data storage**
 - Data protection rights..... 40
 - Electronic control units..... 37
- Online services..... 40
- Vehicle..... 37
- Daytime running lamp mode**
 - see Daytime running lamps
- Daytime running lamps**
 - Activating/deactivating..... 153
- Deactivating the alarm (ATA)..... 100**
- Dealership**
 - see Qualified specialist workshop
- Declaration of conformity**
 - Wireless vehicle components..... 33
- Decorative foil (cleaning instructions)..... 358**
- Definitions (tires and loading)..... 397**
- Defrost function..... 167**
- Destination entry**
 - Entering a POI or address..... 324
- Detecting inattentiveness**
 - see ATTENTION ASSIST
- Diagnostics connection..... 33**
- DIGITAL LIGHT**
 - Active headlamps..... 146
 - Assistance functions..... 148
- Bad weather light..... 148
- City lighting..... 148
- Cornering light..... 147
- Fog light (enhanced)..... 147
- Highway mode..... 147
- Overview..... 146
- Switching the Intelligent Light System
 - on/off..... 150
 - Topographical compensation..... 148
- Digital Operator's Manual..... 26**
- Dinghy towing**
 - see Tow-bar system
- DIRECT SELECT lever**
 - Engaging drive position..... 195
 - Engaging neutral..... 194
 - Engaging park position..... 194
 - Engaging park position automatically..... 194
 - Engaging reverse gear..... 194
 - Function..... 193
- Disconnect device**
 - High-voltage on-board electrical system..... 179
- Display (care)..... 360**

- Display (driver's display)**
 Overview of displays..... 292
- Display (MBUX multimedia system)**
 Calling up the Zero Layer..... 298
 Home screen..... 301
 Operating..... 303
 Operating the Zero Layer..... 298
 Zero Layer (function)..... 295
 Zero Layer (overview)..... 296
- Display message**
 Calling up (driver display)..... 420
 Notes..... 420
- Display messages**
-  --- mph..... 459
 -  --- mph..... 458
 -  12 V On-board Electrical System Service Required..... 478
 -  Acoustic Presence Indicator Inoperative..... 433
 -  Active Headlamps Inoperative..... 428
 -  ATTENTION ASSIST Inoperative..... 458
 -  ATTENTION ASSIST Nodding Off Take a Break!..... 458
 -  ATTENTION ASSIST: Take a Break!..... 458
 -  Automatic Headlamp Mode Inoperative..... 427
 -  Battery Overheated Stop, Everyone Get Out Outdoors if Possible..... 437
 -  Battery Too Low Stop Vehicle Charge Immediately..... 436
 -  Beginning Emergency Stop..... 461
 -  BRAKE Brake Immediately..... 455
 -  Charger Cable Connected..... 434
 -  BRAKE Check Brake Fluid Level..... 457
 -  Check Coolant Level See Operator's Manual..... 433
 -  Check Left Low Beam (example)... 427
 -  Check Tires..... 481
 -  Check Washer Fluid..... 446
 -  Compressor Is Cooling..... 471
 -  Coolant Stop Switch Off Vehicle.... 433
 -  Currently Unavailable See Operator's Manual..... 473
 -  Currently Unavailable See Operator's Manual..... 474
 -  Don't Forget Your Key..... 426
 -  Front Left Malfunction Service Required (example)..... 421
 -  Have High-voltage System Checked See Operator's Manual..... 438
 -  Inoperative Charge High-voltage Battery..... 431
 -  Inoperative High-Voltage Battery Charging Not Complete..... 430
 -  Inoperative See Operator's Manual..... 474
 -  Inoperative See Operator's Manual..... 475
 -  EBD Inoperative See Operator's Manual..... 476

-  Inoperative..... 478
-  Key Being Initialized Please Wait.... 426
-  Key Not Detected (red display message)..... 425
-  Key Not Detected (white display message)..... 425
-  Left Window Airbag Malfunction Service Required (example)..... 422
-  Malfunction Drive at Max. 50 mph..... 469
-  Malfunction see Operator's Manual..... 456
-  Malfunction See Operator's Manual..... 427
-  Malfunction Service Required..... 438
-  Malfunction Stop..... 456
-  Malfunction Visit Workshop..... 439
-  Malfunction..... 439
-  Malfunction..... 437
-  Maximum Speed 12mph..... 470
-  Obtain a New Key..... 424
-  Off..... 459
-  Off..... 457
-  Parking Brake See Operator's Manual..... 451
-  Performance Extremely Limited.... 432
-  Please Correct Tire Pressure..... 482
-  Please Release Parking Brake..... 454
-  Pre-entry Climate Control Available Again via SmartKey after Vehicle Start..... 431
-  Pre-entry Climate Control via Key Inoperative High-voltage Battery Low..... 431
-  Rear Axle Steering Currently Malfunctioning..... 443
-  Rear Axle Steering Malfunction Service Required..... 443
-  Rear Axle Steering Malfunction Stop Immediately..... 444
-  Rear Left Backrest Not Latched (example)..... 446
-  Replace Key Battery..... 425
-  Reserve Level Charge High-Voltage Battery..... 438
-  Restraint System Malfunction Service Required..... 421
-  Steering Malfunction Drive Carefully Service Required..... 442
-  Steering Malfunction Increased Physical Effort See Operator's Manual.... 442
-  Steering Malfunction Stop Immediately See Operator's Manual..... 443
-  Stop Switch Off Vehicle..... 439
-  STOP Vehicle Level Too Low..... 470
-  Stop Vehicle See Operator's Manual..... 479
-  Stop vehicle To charge the 12 V battery do not switch off vehicle..... 480
-  Suspended..... 459

- | | | | |
|--|-----|---|-----|
|  Switch Off Lights..... | 428 | | |
|  Switch On Headlamps..... | 428 | | |
|  Switch on vehicle to charge the 12 V battery..... | 479 | | |
|  Switch on Vehicle to Release the Parking Brake..... | 455 | | |
|  Temporarily Unavailable Camera View Restricted..... | 468 | | |
|  Temporarily Unavailable Sensors are Dirty..... | 467 | | |
|  Towing Not Permitted See Operator's Manual..... | 432 | | |
|  Vehicle Ready to Drive Switch the Ignition Off Before Exiting..... | 441 | | |
|  Vehicle Rising Please Wait..... | 471 | | |
|  Warning Tire Malfunction..... | 482 | | |
|  Wheel Sensor(s) Missing..... | 481 | | |
| AC Charging Inoperative Service Required..... | 435 | | |
| | | Active Blind Spot Assist Currently Unavailable See Operator's Manual..... | 465 |
| | | Active Blind Spot Assist Inoperative..... | 465 |
| | | Active Brake Assist Functions Currently Limited See Operator's Manual..... | 476 |
| | | Active Brake Assist Functions Limited See Operator's Manual..... | 477 |
| | | Active Distance Assist Currently Unavailable See Operator's Manual..... | 460 |
| | | Active Distance Assist Inoperative..... | 460 |
| | | Active Distance Assist Now Available..... | 460 |
| | | Active Emergency Stop Assist Currently Unavailable See Operator's Manual..... | 462 |
| | | Active Emergency Stop Assist Inoperative..... | 462 |
| | | Active Lane Change Assist Currently Unavailable See Operator's Manual..... | 463 |
| | | Active Lane Change Assist Inoperative... | 463 |
| | | Active Lane Keeping Assist Currently Unavailable See Operator's Manual..... | 466 |
| | | Active Lane Keeping Assist Inoperative... | 466 |
| | | Active Parking Assist and PARKTRONIC Inoperative See Operator's Manual..... | 472 |
| | | Active Parking Assist Limited Availability of Maneuvering Assistance See Operator's Manual..... | 471 |
| | | Active Steering Assist Currently Unavailable Due to Multiple Emergency Stops..... | 461 |
| | | Active Steering Assist Currently Unavailable See Operator's Manual..... | 460 |
| | | Active Steering Assist Inoperative..... | 461 |
| | | Active Stop & Go Assist Currently Unavailable See Operator's Manual..... | 463 |
| | | Active Stop & Go Assist Inoperative See Operator's Manual..... | 464 |

- Adaptive Highbeam Assist Currently Unavailable See Operator's Manual..... 428
- Adaptive Highbeam Assist Inoperative.... 429
- Adaptive Highbeam Assist Plus Currently Unavailable See Operator's Manual..... 429
- Adaptive Highbeam Assist Plus Inoperative..... 429
- Ambient Lighting Warning Support Inoperative..... 445
- Apply Brake To Park Service Required.... 447
- Auxiliary Battery Malfunction (white display message)..... 450
- Blind Spot Assist Currently Unavailable See Operator's Manual..... 464
- Blind Spot Assist Inoperative..... 465
- Cannot Start Vehicle See Operator's Manual..... 478
- Change the steering wheel/ seat position until 6 dots are visible on the upper edge of the screen..... 469
- Charging Fault Change Charging Mode See Operator's Manual..... 435
- Check Brake Pads See Operator's Manual..... 457
- Cruise Control Inoperative..... 459
- Cruise Control Off..... 459
- DC Charging Inoperative Service Required..... 435
- Decrease Speed..... 483
- Depress Brake to Shift from P..... 447
- Depress Brake to Shift to D or R..... 447
- DIGITAL LIGHT Functions Limited..... 428
- Do Not Restart Vehicle Service Required..... 438
- Driver Camera Inoperative See Operator's Manual..... 469
- Driver Camera View Currently Restricted See Operator's Manual..... 468
- Front Passenger Airbag Disabled See Operator's Manual..... 422
- Front Passenger Airbag Enabled See Operator's Manual..... 423
- Hazard Warning Light Malfunction..... 430
- Head-up Display Brightness Currently Reduced See Operator's Manual..... 442
- Head-up Display Currently Unavailable See Operator's Manual..... 441
- Head-up Display Inoperative..... 441
- High-voltage Battery Fault No Start in Approx. XXX mi Service Required (red display message)..... 440
- High-voltage Battery Fault No Start in Approx. XXX mi Service Required (yellow display message)..... 439
- High-voltage Battery Fault Do Not Restart Service Required..... 440

- N Automatically Activated Please Shift to Transmission Position Again..... 449
- N is Engaged Please Engage Desired Gear..... 449
- Not Possible to Unlock Charger Cable See Operator's Manual..... 435
- PARKTRONIC Inoperative See Operator's Manual..... 471
- Place the Key in the Marked Space See Operator's Manual..... 426
- PRE-SAFE Impulse Side Inoperative See Operator's Manual..... 424
- PRE-SAFE Inoperative See Operator's Manual..... 424
- Preparing Drive System..... 438
- Reduced Drive System Performance See Operator's Manual..... 436
- Reversing Not Possible Service Required..... 449
- Risk of Vehicle Rolling Away Apply Brake to Park..... 448
- Risk of Vehicle Rolling Away Driver's Door Open Position P Not Selected..... 448
- Risk of Vehicle Rolling Away N Activated Manually No Automatic Change to P..... 448
- Service Required Do Not Change Transmission Position..... 450
- Shift to P Only When Vehicle Is Stationary..... 447
- Snow Chain Mode Maximum Speed Exceeded..... 444
- Tire Press. Monitor Currently Unavailable..... 480
- Tire Press. Monitor Inoperative..... 480
- Tire Pressure Monitor Inoperative No Wheel Sensors..... 481
- Tires Overheated..... 483
- To Deselect P or N Depress Brake and Start Vehicle..... 447
- To switch vehicle off, press and hold Start/Stop button for at least 3 seconds or press 3 times..... 433
- Traffic Sign Assist Currently Unavailable See Operator's Manual..... 464
- Traffic Sign Assist Inoperative..... 464
- Transmission Malfunction Stop..... 449
- Vehicle Currently Not Being Charged... Charging Station Fault..... 435
- Wait in the READY status Battery is warming up see Operator's Manual..... 437
- Windshield Wiper Malfunction..... 446
- Distance control**
see Active Distance Assist DISTRONIC
- DISTRONIC**
see Active Distance Assist DISTRONIC
- Door**
Child safety lock (rear doors)..... 70
Closing the convenience doors..... 80

- Locking/unlocking (emergency key)..... 86
- Opening (from inside)..... 77
- Opening the convenience doors..... 80
- Power closing function..... 85
- Unlocking (from inside)..... 77
- Door control panel**..... 20
- Door control panel (rear passenger compartment)**..... 22
- DOT, Tire Identification Number (TIN)**..... 393
- Drawbar**
 - see Tow-bar system
- Drinking and driving**..... 183
- Drinks holder**
 - see Cup holder
- Drive Away Assist**..... 279
- Drive position**
 - Engaging..... 195
- Drive program display**..... 192
- Drive programs**
 - see DYNAMIC SELECT
- Drive system**
 - Manual switch-off..... 179
 - Starting (emergency operation mode).... 182
- Driver camera**
 - Activating/deactivating..... 311
 - Overview..... 310
- Driver display**
 - Displaying the service due date..... 353
 - Function/notes..... 286
 - Notes on menus..... 288
 - Operating..... 287
 - Warning/indicator lamps..... 484
- Driver display with driver camera**..... 14
- Driver's display**..... 10
- Driver's seat**
 - see Seat
- Driving safety system**
 - ABS (Anti-lock Braking System)..... 219
 - Active Brake Assist..... 242
 - BAS (Brake Assist System)..... 219
 - Cameras..... 217
 - EBD (electronic brake force distribution)..... 221
 - ESP® Crosswind Assist..... 221
 - Overview..... 218
 - Radar and ultrasonic sensors..... 217
- Responsibility..... 217
- Driving system**
 - see Active Blind Spot Assist
 - see Active Distance Assist DISTRONIC
 - see Active Emergency Stop Assist
 - see Active Lane Change Assist
 - see Active Lane Keeping Assist
 - see Active Parking Assist
 - see Active Speed Limit Assist
 - see Active Steering Assist
 - see AIRMATIC
 - see ATTENTION ASSIST with micro-sleep detection
 - see Blind Spot Assist
 - see Cruise control
 - see Driving safety system
 - see HOLD function
 - see Memory Parking Assist
 - see Parking Assist PARKTRONIC
 - see Rear view camera
 - see Remote Parking Assist
 - see Surround view camera
 - see Traffic Sign Assist

Driving tips

Acoustic presence indicator (sound generator).....	178
Breaking-in notes.....	182
Drinking and driving.....	183
Electric mode.....	178
General driving tips.....	183
Range maximization.....	190

Driving tips

see Recuperation

Drowsiness detection

see ATTENTION ASSIST with micro-sleep detection

Dynamic handling control system

see ESP® (Electronic Stability Program)

DYNAMIC SELECT

Calling up the fuel consumption indicator.....	193
Configuring drive program I.....	192
Displaying vehicle data.....	193
Drive program display.....	192
Drive programs.....	191
Function.....	191
Operating.....	192

Selecting the drive program.....	192
----------------------------------	-----

E**Easy entry feature**

Function/notes.....	116
Setting.....	118

Easy exit feature

Function/notes.....	116
Setting.....	118

EBD (electronic brake force distribution)

Function/notes.....	221
---------------------	-----

ECO Assist

Activating/deactivating.....	190
Function.....	188

ECO display

Function.....	186
---------------	-----

Electric mode

Notes.....	178
------------	-----

Electric parking brake

Applying automatically.....	214
Applying/releasing manually.....	215
Emergency braking.....	215
Releasing automatically.....	214

Electronic Stability Program

see ESP® (Electronic Stability Program)

Emergency

Assistance overview.....	24
First-aid kit (soft sided).....	364
Reflective safety vest.....	363
Removing the warning triangle.....	363
Setting up the warning triangle.....	364

Emergency braking..... 215**Emergency braking**

see BAS (Brake Assist System)

Emergency call

see Mercedes-Benz emergency call system

Emergency key

Locking/unlocking the doors.....	86
----------------------------------	----

Emergency operation mode

Starting the vehicle.....	182
---------------------------	-----

Emergency shutoff

see High-voltage on-board electrical system

Emergency spare wheel

Notes.....	408
------------	-----

Emergency start (drive system)..... 378

- Emergency Tensioning Devices**
 Activation..... 44
- Energy flow display**
 Displaying..... 321
- Engine**
 Engine number..... 412
- Engine number**..... 412
- ERM (Extended Range Mode)**
 see Range maximization
- Error message**
 see Display message
- ESC (Electronic Stability Control)**
 see ESP® (Electronic Stability Program)
- ESP®**
 Crosswind Assist..... 221
- ESP® (Electronic Stability Program)**
 Activating/deactivating..... 221
 Function/notes..... 220
- Exiting procedure**
 Playing back..... 284
- Exterior lighting**
 Care..... 359
- Exterior lighting**
 see Lights
- Exterior mirrors**
 Automatic mirror folding function..... 162
 Automatic preselection (MBUX Interior Assistant)..... 309
 Parking position..... 161
- F**
- Fatigue detection**
 see ATTENTION ASSIST with micro-sleep detection
- Favorites**
 Adding..... 313
- Fine particle status display**..... 166
- First-aid kit (soft sided)**..... 364
- Flacon**
 Inserting/removing..... 171
- Flat tire**
 Changing a wheel..... 404
 MOExtended tires..... 365
 Notes..... 364
 TIREFIT kit..... 366
- Flat towing**
 see Tow-bar system
- Floor mats**..... 141
- Fog light (enhanced)**..... 147
- Foil covering**
 Radar and ultrasonic sensors..... 217
- Fragrance**
 see Fragrance system
- Fragrance system**
 Activating/deactivating..... 170
 Adjusting the fragrance intensity..... 170
 Inserting/removing the flacon..... 171
- Free software**..... 42
- Frequencies**
 Two-way radio..... 411
- Front airbag (driver, front passenger)**..... 50
- Front passenger seat**
 Adjusting from the driver's seat..... 105
 Adjusting from the rear passenger compartment..... 105
- Front passenger seat**
 see Seat

Fuel consumption indicator	
Calling up.....	193
Function seat	
see Door control panel	
Function seat (rear passenger compartment)	
see Seat (rear passenger compartment)	
Fuses	
Before replacing a fuse.....	378
Dashboard fuse box.....	379
Fuse assignment diagram.....	378
Fuse box in the front-passenger footwell.....	379
Fuse box in the rear passenger compartment.....	380
Notes.....	378
Fuses	
see Fuses	

G

Garage door opener	
Clearing the memory.....	213
Garage door openers	
Opening/closing the door.....	213

Programming buttons.....	211
Resolving problems.....	213
Synchronizing the rolling code.....	213
Genuine parts.....	27
Glove box	
Opening/closing.....	123
GPS-based vehicle level	
Setting.....	260

H

Handbrake	
see Electric parking brake	
Handling (unusual).....	381
HANDS-FREE ACCESS.....	90
Haptic accelerator pedal.....	190
Hazard warning lights.....	145
Hazardous substances	
Information.....	31
Head restraint	
Activating/deactivating neck heating.....	109
Attaching/removing the additional cushion (rear passenger compartment)..	109
Front (adjusting mechanically) (4-way)....	107
Programming buttons.....	211
Resolving problems.....	213
Synchronizing the rolling code.....	213
Genuine parts.....	27
Glove box	
Opening/closing.....	123
GPS-based vehicle level	
Setting.....	260
Head-up Display	
Augmented reality.....	290
Care.....	360
Function.....	288
Operating.....	291
Operating the memory function.....	119
Selecting (with augmented reality).....	291
Switching on/off.....	291
Headlamps	
see Automatic driving lights	
Headliner (care).....	360
Heating	
see Climate control	
Help call	
see Mercedes-Benz emergency call system	
High beam	
Activating/deactivating.....	144
High beam	
see Adaptive Highbeam Assist	
see Adaptive Highbeam Assist Plus	
Front (luxury head restraint).....	108
Rear (folding into position/folding back mechanically).....	110
Rear (setting) (standard).....	108

- High-beam flasher**..... 144
- High-voltage battery**
- Charging at time of departure..... 209
 - Charging cable control panel..... 200
 - Charging duration..... 418
 - Condition of charge display..... 208
 - Configuring weekly profile..... 209
 - Disconnect device..... 179
 - Ending the charging process (alternating current, mode 2/3)..... 205
 - Ending the charging process (direct current, mode 4)..... 207
 - Energy flow display..... 321
 - Function/notes..... 371
 - General notes on charging..... 195
 - Indicator lamps on vehicle socket..... 202
 - Maximum charging current (mains socket)..... 200
 - Notes on charging (charging station, mode 3)..... 198
 - Notes on charging (fast charging station, mode 4)..... 199
 - Notes on charging (mains socket, mode 2)..... 197
 - Notes on charging (wallbox, mode 3)..... 198
- Range..... 418
- Range maximization..... 190
- Starting the charging process (alternating current, mode 2/3)..... 202
- Starting the charging process (direct current, mode 4)..... 205
- Stowing the charging cable..... 195
- Type..... 418
- High-voltage on-board electrical system**
- Charging cable control panel..... 200
 - Disconnect device..... 179
 - Indicator lamps on vehicle socket..... 202
 - Manual disconnection..... 179
- Highway mode**..... 147
- Hill start assist**..... 223
- HOLD function**
- Function/notes..... 221
 - Switching on/off..... 222
- Home screen (central display)**
- Overview..... 301
- Hood**
- Opening/closing..... 354
- I**
- Identification plate**
- Engine..... 412
 - Refrigerant..... 416
 - vehicle..... 412
- Ignition key**
- see SmartKey
- Immediate pre-entry climate control**..... 175
- Immobilizer**..... 99
- Indicator lamp**
- see Warning/indicator lamp
- Individual drive program**
- Configuring..... 192
 - Selecting..... 192
- Inside rearview mirror**
- Anti-glare mode (automatic)..... 160
- Inside rearview mirror**
- see Outside mirrors
- Inspection**
- see ASSYST PLUS
- Instrument cluster**
- see Driver display

Intelligent Light System

Activating/deactivating.....	150
Active headlamps.....	146
Adaptive Highbeam Assist.....	150
Adaptive Highbeam Assist Plus.....	152
Assistance functions.....	148
Bad weather light.....	148
City lighting.....	148
Cornering light.....	147
Fog light (enhanced).....	147
Highway mode.....	147
Overview.....	146
Topographical compensation.....	148

Interior lighting

Adjusting.....	154
Ambient lighting.....	155
Reading lamp.....	154
Switch-off delay time.....	156

Interior motion sensor

Activating/deactivating.....	101
Function.....	101

Internet radio

see Tuneln

Ionization

Activating/deactivating (MBUX multi-media system).....	170
--	-----

iPhone®

see Smartphone integration

J**Jack**

Storage location.....	403
-----------------------	-----

Jump-start connection..... 372**K****KEYLESS-GO**

Deactivating a function.....	74
Locking/unlocking the vehicle.....	78
Problem.....	79
Unlocking setting.....	74

Knee airbag..... 50**L****Labeling (tires)**

see Tire labeling

Lamp

see Interior lighting

Lamp (driver display)

see Warning/indicator lamp

Lane detection (automatic)

see Active Lane Keeping Assist

Lane Keeping Assist

see Active Lane Keeping Assist

Language

Notes.....	320
Setting.....	320

LATCH-type (ISOFIX) child seat anchor

Installing.....	63
-----------------	----

Level control system

see AIRMATIC

Light switch

Overview.....	143
---------------	-----

Lighting

see Interior lighting
see Lights

Lights

Active headlamps.....	146
Adaptive Highbeam Assist.....	150

- Adaptive Highbeam Assist Plus..... 152
 - Automatic driving lights..... 144
 - Bad weather light..... 148
 - City lighting..... 148
 - Combination switch..... 144
 - Cornering light..... 147
 - Fog light (enhanced)..... 147
 - Hazard warning lights..... 145
 - High beam..... 144
 - High-beam flasher..... 144
 - Highway mode..... 147
 - Intelligent Light System..... 146
 - Light switch..... 143
 - Low beam..... 143
 - Parking lights..... 143
 - Rear fog light..... 143
 - Responsibility for lighting systems..... 143
 - Setting the exterior lighting switch-off delay time..... 153
 - Standing lights..... 143
 - Switching the Intelligent Light System on/off..... 150
 - Switching the locator lighting on/off..... 154
 - Turn signal light..... 144
 - Limited Warranty**
 - Vehicle..... 37
 - Limiting the opening angle (tailgate)**..... 91
 - Live Traffic Information**
 - Switching the traffic information display on..... 329
 - Load index (tires)**..... 395
 - Load-bearing capacity (tires)**..... 395
 - Loading**
 - Bag hook..... 132
 - Cargo tie-down rings..... 132
 - Definitions..... 397
 - Notes..... 119
 - Roof luggage rack..... 133
 - Loading guidelines**..... 119
 - Loading information table**..... 388
 - Loads**
 - Fixing..... 119
 - Locator lighting**
 - Activating/deactivating..... 154
 - Locking/unlocking**
 - Emergency key..... 86
 - KEYLESS-GO..... 78
 - Opening the tailgate..... 87
 - Switching the automatic locking feature on/off..... 80
 - Unlocking/opening the doors from the inside..... 77
 - Low beam**
 - Activating/deactivating..... 143
 - Luggage**
 - Securing..... 119
 - Lumbar support**
 - see Lumbar support (4-way)
 - Lumbar support (4-way)**..... 106
- M**
- Maintenance**
 - Vehicle..... 30
 - Maintenance**
 - see ASSYST PLUS
 - Malfunction**
 - Restraint system..... 44
 - Maneuvering assistance**
 - Activating/deactivating..... 282
 - Cross traffic warning..... 280

- Drive Away Assist..... 279
- Maneuvering brake function..... 281
- Maneuvering brake function**..... 281
- Map**
- Displaying online map contents..... 329
- Displaying weather information..... 329
- Moving..... 329
- Selecting the map orientation..... 329
- Setting the map scale..... 329
- Massage programs**
- Overview..... 112
- Resetting the settings..... 113
- Selecting the front seats..... 113
- Maximum load rating**..... 394
- Maximum permissible load**
- Calculation example..... 390
- Determining..... 389
- Maximum tire pressure**..... 394
- MBUX Interior Assistant**
- Anticipatory exit warning..... 308
- Automatic preselection of the outside mirror..... 309
- Calling up favorites with the V pose..... 310
- Operating the function with the favorites pose..... 310
- Overview..... 306
- Switching the reading light on/off (contactless)..... 308
- Switching the search light on/off (contactless)..... 308
- MBUX multimedia system**
- Activating/deactivating snow chain mode..... 382
- Activating/deactivating the fragrance system..... 170
- Calling up the Zero Layer..... 298
- Configuring drive program I..... 192
- Coupling the steering wheel heater to the seat heating..... 116
- Driver camera..... 310
- Home screen..... 301
- Notes..... 294
- Operating the touchscreen..... 303
- Operating the Zero Layer..... 298
- Overview..... 294
- Restoring (factory settings)..... 320
- Setting collision detection (parked vehicle)..... 216
- Setting route-based speed adaptation.... 235
- Setting the air distribution..... 168
- Setting the fragrance system..... 170
- Setting the rear climate control..... 168
- Switching ionization on/off..... 170
- Zero Layer (function)..... 295
- Zero Layer (overview)..... 296
- MBUX multimedia system**
- see Display (MBUX multimedia system)
- see MBUX Interior Assistant
- MBUX Voice Assistant**
- Function..... 304
- Voice prompting..... 305
- Mechanical key**
- Inserting/removing..... 75
- Unlocking the tailgate..... 92
- Media**
- Overview of the functions and symbols... 346
- Medical aids**..... 35
- Memory function**
- Function..... 118
- Head-up Display..... 119
- Operating..... 119
- Outside mirrors..... 119

- Seat..... 119
Steering wheel..... 119
- Memory Parking Assist**
Exiting a parking space..... 284
Function..... 282
Parking..... 284
Recording..... 283
Setting..... 285
System limits..... 282
- Menus (driver display)**
Notes..... 288
- Mercedes me app**
Information..... 341
Notes..... 29
On-demand feature..... 29
- Mercedes me calls**
Arranging a service appointment..... 338
Calling the Mercedes-Benz customer center..... 337
Calling the Mercedes-Benz Customer Center after automatic accident or breakdown detection..... 337
Information..... 337
- Making a call via the overhead control panel..... 336
Transferred data..... 338
- Mercedes me connect**
Accident and Breakdown Management... 340
Information..... 339
Transferred data..... 341
- Mercedes-AMG vehicles**
Notes..... 178
- Mercedes-Benz emergency call system**
Automatic emergency call..... 344
Information..... 343
Information about data transfer..... 345
Manual emergency call..... 344
Overview..... 343
- Message (driver display)**
see Display message
- Message memory**..... 420
- Mirrors**
see Outside mirrors
- Mobile phone**
Authorizing (Remote Parking Assist)..... 279
Notes on wireless charging..... 138
Wireless charging (front)..... 140
- Wireless charging (rear passenger compartment)..... 140
- Mobile phone**
see Smartphone integration
see Telephone
- Model type**
see Vehicle identification plate
- MOExtended tires**..... 365
- Multimedia system**
Setting Memory Parking Assist..... 285
- N**
- Navigation**
Notes..... 321
Overview..... 321
Switching on..... 321
- Navigation**
see Destination entry
see Map
- Navigation with Electric Intelligence**
see Route
- Neutral**
Engaging..... 194

Nodding off

see ATTENTION ASSIST with micro-sleep detection

O**Occupant safety**

see Airbag
 see Automatic co-driver airbag shutoff
 see Automatic measures after an accident
 see Child seat
 see Pets in the vehicle
 see Post-collision brake
 see PRE-SAFE® (anticipatory occupant protection)
 see PRE-SAFE® Impulse Side
 see PRE-SAFE® PLUS (anticipatory occupant protection plus)
 see Restraint system
 see Seat belt

On-board diagnostics interface

see Diagnostics connection

On-board electrical system battery (12 V)

Charging..... 372
 Replacing..... 372

Starting assistance..... 372

On-board electronics

Notes..... 410
 Two-way radios..... 410

On-demand feature

Activating..... 29
 Notes..... 29

Online services

Data storage..... 40

Open-source software..... 42**Opening the tailgate using your foot**

HANDS-FREE ACCESS..... 90

Operating fluids

Brake fluid..... 414
 Coolant (engine)..... 415
 Notes..... 414
 Refrigerant (air conditioning system)..... 416
 Windshield washer fluid..... 416

Operating safety

Declaration of conformity (wireless vehicle components)..... 33
 Information..... 31

Operator's Manual

Vehicle equipment..... 28

Operator's Manual (digital)..... 26**Outside mirrors**

Anti-glare mode (automatic)..... 160
 Folding in/out..... 159
 Operating the memory function..... 119
 Setting..... 159

Overhead control panel

Overview..... 18

Overview

Toll system..... 321

P**Paint (cleaning instructions)..... 358****Paint code..... 412****Panic alarm**

Arming/disarming..... 74

Panorama roof with power tilt/sliding panel

see Sliding sunroof

Park position

Engaging..... 194

- Selecting automatically..... 194
- Parking**
see Electric parking brake
- Parking aid**
see Parking Assist PARKTRONIC
- Parking Assist PARKTRONIC**
Activating..... 269
Adjusting warning tones..... 270
Function..... 266
Switching off..... 269
System limitations..... 266
- Parking assistance systems**
see Active Parking Assist
see Memory Parking Assist
- Parking brake**
see Electric parking brake
- Parking lights**..... 143
- Parking position**
Exterior mirrors..... 161
Storing the position of the front-passenger outside mirror using reverse gear..... 161
- Parking procedure**
Playing back..... 284
- Partitioning net**
Attaching/removing..... 130
- PASSENGER AIR BAG status display**
see Automatic front passenger airbag shutoff
- Payload**
Calculation example..... 390
Determining the maximum..... 389
- Perfume**
see Fragrance system
- Perfume atomizer**
Setting..... 170
- Perfume vial**
see Fragrance system
- Permissible towing methods**..... 372
- Pets in the vehicle**..... 72
- Plastic trim (Care)**..... 360
- Post-collision brake**..... 58
- Power closing function**
Door..... 85
- Power supply**
Switching on (start/stop button)..... 180
- Power washer (care)**..... 357
- Pre-entry climate control (immediate)**..... 175
- Pre-entry climate control at departure time**
Function..... 173
Setting..... 174
- Pre-entry climate control for departure time**
Activating/deactivating..... 175
- Pre-entry climate control when the vehicle is unlocked**
Activating/deactivating..... 173
Function..... 172
Setting..... 173
- PRE-SAFE® (anticipatory occupant protection)**
Function..... 57
PRE-SAFE® Sound..... 57
Reversing measures..... 57
- PRE-SAFE® Impulse Side**
Activation..... 44
Function..... 58

PRE-SAFE® PLUS (anticipatory occupant protection plus)

- Function..... 57
- Reversing measures..... 57

Preventative occupant protection system

- see PRE-SAFE® (anticipatory occupant protection)
- see PRE-SAFE® PLUS (anticipatory occupant protection plus)

Profile

- Notes..... 311

Program

- see DYNAMIC SELECT

Protecting the environment

- Notes..... 27

Protection against collision

- see Drive Away Assist
- see Maneuvering brake function

Q**QR code**

- Rescue card..... 37

Qualified specialist workshop..... 35**R****Radar and ultrasonic sensors**

- Damage..... 217

Radio

- Overview of the functions and symbols... 348

Rain-closing feature

- Sliding sunroof..... 98

Range

- Notes..... 286

Range maximization

- Activating/deactivating..... 191
- Function..... 190

Reading lamp

- see Interior lighting

Reading light

- Switching on/off (contactless)..... 308

Real wood (Care)..... 360**Rear axle steering..... 185****Rear climate control**

- Setting (MBUX multimedia system)..... 168

Rear doors (child safety lock)..... 70**Rear fog lamp**

- Switching on/off..... 144

Rear passenger compartment seat

- Seats..... 106

Rear seat

- see Seats

Rear view camera

- Activating using GPS (surround view camera)..... 266
- Care..... 359
- Function..... 260
- Managing activation points (surround view camera)..... 266

Rear window heater..... 163**Rear window heater (3-zone automatic climate control)..... 164****Recuperation**

- Function..... 186
- Setting..... 187

Reflective safety vest..... 363**Refrigerant (air conditioning system)**

- Notes..... 416

- Regulatory radio identification**
 Indonesia..... 412
 Small components..... 412
- Regulatory radio information**
 Installation clearances..... 412
- Remote Parking Assist**
 Authorizing a mobile phone..... 279
 Function..... 275
 Operating..... 276
 System limitations..... 275
- Reporting safety defects**..... 36
- Rescue card**..... 37
- Reset function (MBUX multimedia system)**... 320
- Restoring (factory settings)**
 see Reset function (MBUX multimedia system)
- Restraint system**
 Basic instructions for children..... 58
 Function in an accident..... 44
 Functionality..... 44
 Limited protection..... 43
 Malfunction..... 44
 Protection..... 43
 Self-test..... 44
 Warning lamp..... 44
- Reverse gear**
 Engaging..... 194
- Reversing camera**
 Opening the camera cover (surround
 view camera)..... 266
- Rims (care)**..... 359
- Roadside Assistance (breakdown)**..... 30
- Roll away protection**
 see HOLD function
- Roller sunblind**
 Sliding sunroof..... 95
- Roof load**..... 418
- Roof luggage rack**
 Loading..... 133
 Securing..... 133
- Route**
 Activating a commuter route..... 325
 Selecting a type..... 325
 Selecting an alternative route..... 325
 Switching on Electric Intelligence..... 325
- Route guidance with augmented reality**
 Activating..... 325
- Activating/deactivating the traffic
 light view..... 250
 Displaying street names and house
 numbers..... 325
- Route-based speed adaptation**
 Function..... 234
 Setting..... 235
- Run-flat characteristics**
 MOExtended tires..... 365
- S**
- Safety systems**
 see Driving safety system
- Satellite radio**
 Logging in..... 351
 Setting music and sport alerts..... 351
- Search light**
 Switching on/off (contactless)..... 308
- Seat**
 4-way lumbar support..... 106
 Adjusting (electrically)..... 102
 Adjusting the front passenger seat
 from the rear passenger compartment... 105
 Automatic adjustment..... 111

- Configuring settings..... 111
- Correct driver's seat position..... 102
- Folding back the backrest (rear passenger compartment)..... 127
- Locking the backrest (rear passenger compartment)..... 128
- Massage program overview..... 112
- Operating the memory function..... 119
- Resetting the settings..... 113
- Setting options..... 20
- Workout program overview..... 112
- Seat (rear passenger compartment)**
 - Setting options..... 22
- Seat belt**
 - Adjusting the height..... 48
 - Care..... 360
 - Fastening..... 48
 - Protection..... 45
 - Warning lamp..... 49
- Seat belt adjustment**
 - Activating/deactivating..... 49
 - Function..... 49
- Seat belt warning**
 - see Seat belt
- Seat belts**
 - Activating/deactivating seat belt adjustment..... 49
 - Belt airbag..... 48
 - Reduced protection..... 46
 - Releasing..... 49
 - Seat belt adjustment (function)..... 49
- Seat cover (Care)**..... 360
- Seat heating**
 - Activating/deactivating..... 22, 113
- Seat ventilation**
 - Activating/deactivating..... 22, 114
- Seats**
 - Folding the backrest forwards (rear passenger compartment)..... 124
 - Rear passenger compartment (adjusting electrically)..... 106
- Selector lever**
 - see DIRECT SELECT lever
- Self-test**
 - Automatic front passenger airbag shut off..... 54
- Sensors (care)**..... 359
- Service**
 - see ASSYST PLUS
- Service Center**
 - see Qualified specialist workshop
- Service interval display**
 - see ASSYST PLUS
- Setting a speed**
 - see Cruise control
- Setting the map scale**
 - see Map
- Side airbag**..... 50
- Side windows**
 - Child safety lock in the rear passenger compartment..... 72
 - Closing using the SmartKey..... 94
 - Convenience closing..... 94
 - Convenience opening..... 94
 - Opening with the SmartKey..... 94
 - Opening/closing..... 92
 - Problem..... 95
- Size designation (tires)**..... 395
- Sliding sunroof**
 - Automatic functions..... 98

- Closing..... 95
- Closing using the SmartKey..... 94
- Opening..... 95
- Opening with the SmartKey..... 94
- Problem..... 98
- Rain-closing feature..... 98
- SmartKey**
 - Acoustic locking verification signal..... 74
 - Battery..... 75
 - Deactivating a function..... 74
 - Energy consumption..... 74
 - Function overview..... 73
 - Key ring attachment..... 75
 - Mechanical key..... 75
 - Panic alarm..... 74
 - Problem..... 77
 - Unlocking setting..... 74
- SmartKey**
 - see SmartKey
- Smartphone**
 - see Smartphone integration
 - see Telephone
- Smartphone integration**
 - Overview..... 342
- Snow chain mode**
 - Activating/deactivating..... 382
- Snow chains**..... 382
- Socket (12 V)**
 - Front passenger footwell..... 138
- Software update**
 - System updates..... 316
- Sound**
 - PRE-SAFE® Sound..... 57
 - Wheels and tires..... 381
 - Wheels/tires..... 381
- Sound generator**
 - Acoustic presence indicator..... 178
- Sound menu**
 - Functions overview..... 352
- Spare wheel**
 - see Emergency spare wheel
- Special seat belt retractor**..... 63
- Specialist workshop**
 - see Qualified specialist workshop
- Speed index (tires)**..... 395
- Standing lights**..... 143
- Start/stop button**
 - Parking the vehicle..... 210
 - Starting the vehicle..... 181
 - Switching on the power supply/vehicle.. 180
- Starting**
 - see Vehicle
- Starting assistance**
 - see Jump-start connection
- Starting-off aid**
 - see Hill start assist
- Steering**
 - Rear axle steering..... 185
- Steering wheel**
 - Adjusting (electrically)..... 115
 - Care..... 360
 - Operating the memory function..... 119
- Steering wheel heater**
 - Coupling to seat heating..... 116
- Storage areas**
 - see Storage space
- Storage compartments**
 - see Storage space

Storage space

Armrest.....	122
Center console.....	122
Door.....	122
Front center console.....	122
Glove box.....	122

Stowage areas

see Loading

Stowage compartments

see Loading

Street names and house numbers

Displaying.....	325
-----------------	-----

Surround View

see Surround view camera

Surround view camera

Activating using GPS (rear view camera).....	266
Button.....	266
Care.....	359
Function.....	262
Managing activation points (rear view camera).....	266
Opening the camera cover (reversing camera).....	266

Selecting a view.....	266
-----------------------	-----

Suspension

Setting the suspension level (AIR-MATIC).....	259
---	-----

Suspension

see AIRMATIC

Suspension level (AIRMATIC)

Setting.....	259
--------------	-----

Switch-off delay time

Exterior.....	153
Interior.....	156

Switching on the ignition

see Vehicle

Synchronization function

Activating/deactivating (MBUX multimedia system).....	169
---	-----

System settings

Overview of the system settings menu....	316
Reset function (MBUX multimedia system).....	320

System settings

see Language

T**Tailgate**

Closing.....	88
HANDS-FREE ACCESS.....	90
Limiting the opening angle.....	91
Opening.....	87
Opening dimensions.....	418
Unlocking (mechanical key).....	92

Technical data

Component-specific information.....	412
Information.....	410
Regulatory radio identification (Indonesia).....	412
Regulatory radio identification of small components.....	412
Regulatory radio information.....	412

Telephone

Authorizing a mobile phone (Remote Parking Assist).....	279
Connecting a mobile phone (Passkey)....	335
Connecting a mobile phone (Secure Simple Pairing).....	335
Functions in the telephone menu.....	336
Notes.....	333

- Notes on wireless charging (mobile phone)..... 138
- Operating modes..... 335
- Telephone menu overview..... 335
- Wireless charging (mobile phone in the rear passenger compartment).... 22, 140
- Wireless charging (mobile phone, front)..... 140
- Telephony operating modes**
- Bluetooth® Telephony..... 335
- Temperature**..... 163
- Temperature (3-zone automatic climate control)**..... 164
- Temperature grade**..... 392
- Through-loading feature**
- see Seats
- TIN (Tire Identification Number)**..... 393
- Tire and Loading Information placard**..... 388
- Tire characteristics**..... 395
- Tire inflation compressor**
- see TIREFIT kit
- Tire information table**..... 388
- Tire labeling**
- Characteristics..... 395
- DOT, Tire Identification Number (TIN).... 393
- Load index..... 395
- Load-bearing capacity..... 395
- Maximum tire load..... 394
- Maximum tire pressure..... 394
- Overview..... 392
- Speed rating..... 395
- Temperature grade..... 392
- Tire Quality Grading..... 392
- Tire size designation..... 395
- Traction grade..... 392
- Tread wear grade..... 392
- Tire load (maximum)**..... 394
- Tire pressure**
- Checking (manually)..... 385
- Checking (tire pressure monitoring system)..... 387
- Maximum..... 394
- Notes..... 383
- Restarting the tire pressure monitoring system..... 387
- Tire pressure monitoring system (function)..... 386
- Tire pressure table..... 384
- TIREFIT kit..... 366
- Tire pressure monitor**
- Checking the tire pressure..... 387
- Checking the tire temperature..... 387
- Function..... 386
- Restarting..... 387
- Tire pressure table**..... 384
- Tire Quality Grading**..... 392
- Tire temperature**
- Checking (tire pressure monitoring system)..... 387
- Tire pressure monitoring system (function)..... 386
- Tire tread**..... 381
- Tire-change tool kit**
- Overview..... 403
- TIREFIT kit**
- Storage location..... 366
- Using..... 366
- Tires**
- Characteristics..... 395
- Checking..... 381

- Checking the tire pressure (manually)..... 385
 Checking the tire pressure (tire pressure monitoring system)..... 387
 Definitions..... 397
 DOT, Tire Identification Number (TIN)..... 393
 Flat tire..... 364
 Installing..... 407
 Load index..... 395
 Load-bearing capacity..... 395
 Maximum tire load..... 394
 Maximum tire pressure..... 394
 MOExtended tires..... 365
 Noise generation..... 381
 Notes on installing..... 399
 Overview of tire labeling..... 392
 Removing..... 406
 Replacing..... 399, 404
 Restarting the tire pressure monitoring system..... 387
 Rotating..... 402
 Selection..... 399
 Snow chains..... 382
 Speed rating..... 395
 Storing..... 403
 Temperature grade..... 392
 Tire and Loading Information placard..... 388
 Tire pressure (notes)..... 383
 Tire pressure monitoring system (function)..... 386
 Tire pressure table..... 384
 Tire Quality Grading..... 392
 Tire size designation..... 395
 TIREFIT kit..... 366
 Traction grade..... 392
 Tread wear grade..... 392
 Unfamiliar handling..... 381
Toll system
 Windshield..... 162
Tool
 see Vehicle tool kit
Top Tether..... 66
Touch Control
 Driver display..... 287
 Operating..... 303
Touch-sensitive controls..... 29
Touchscreen
 Operating..... 303
Tow-away alarm
 Activating/deactivating..... 101
 Function..... 100
Tow-bar system..... 285
Tow-starting..... 378
Towing away..... 373
Towing eye
 Installing..... 378
 Storage location..... 377
Towing methods..... 372
Traction grade..... 392
Traffic information
 Switching on the display..... 329
Traffic light data service
 Display in the driver display..... 250
Traffic light view
 Activating/deactivating..... 250
 Information..... 250
 Traffic light data service..... 250
Traffic Sign Assist
 Function/notes..... 246
 Setting..... 249
 System limits..... 246
Transmission
 DIRECT SELECT lever..... 193
 Drive programs..... 191

DYNAMIC SELECT button.....	191
Engaging drive position.....	195
Engaging neutral.....	194
Engaging park position.....	194
Engaging reverse gear.....	194
Transmission position display.....	193
Transmission positions.....	193
Transmission position display	193
Transporting	
Vehicle.....	375
Tread wear grade	392
Trim element (Care)	360
Trunk lid	
see Tailgate	
Tuneln	
Calling up.....	350
Turn signal indicator	144
Turn signal light	
Activating/deactivating.....	144
Two-way radios	
Frequencies.....	411
Notes on installation.....	410
Transmission output (maximum).....	411

U**Unlocking**

 see Locking/unlocking

Updates

 Important system updates..... 316

USB port

 Front storage compartment..... 122

 Rear passenger compartment..... 138

User profiles

 Adding a user..... 313

 Selecting user options..... 313

V**Valet service mode**

 Activating/deactivating..... 223

 Function..... 223

Vehicle

 Collision detection (parked vehicle)..... 216

 Correct use..... 35

 Data acquisition..... 37

 Data storage..... 37

 Diagnostics connection..... 33

 Equipment..... 28

 Limited Warranty..... 37

 Locking (automatically)..... 80

 Locking/unlocking (emergency key)..... 86

 Locking/unlocking (from inside)..... 78

 Locking/unlocking (KEYLESS-GO)..... 78

 Lowering..... 407

 Maintenance..... 30

 Medical aids..... 35

 Problem notification..... 36

 QR code rescue card..... 37

 Qualified specialist workshop..... 35

 Raising..... 404

 Starting (emergency operation mode).... 182

 Starting (start/stop button)..... 181

 Switching off (start/stop button)..... 210

 Switching on (start/stop button)..... 180

 Towing..... 285

 Ventilating (convenience opening)..... 94

Vehicle battery

 see On-board electrical system battery (12 V)









Vehicle camera



















 Information..... 217

Vehicle data

 Displaying (DYNAMIC SELECT)..... 193

 Roof load..... 418

- Turning circle..... 418
 Vehicle height..... 418
 Vehicle length..... 418
 Vehicle width..... 418
 Wheelbase..... 418
- Vehicle data storage**
 Event data recorders..... 41
 MBUX multimedia system/Mercedes
 me connect..... 40
- Vehicle dimensions**..... 418
- Vehicle identification number**
 see VIN
- Vehicle identification plate**
 Paint code..... 412
 VIN..... 412
- Vehicle maintenance**
 see ASSYST PLUS
- Vehicle operation**
 Outside the USA or Canada..... 30
- Vehicle sensors**
 Information..... 217
- Vehicle socket**
 Care..... 359
- Indicator lamps..... 202
- Vehicle tool kit**
 TIREFIT kit..... 366
 Towing eye..... 377
- Ventilating**
 Convenience opening..... 94
- Ventilation**
 see Climate control
- Vents**
 see Air vents
- VIN**
 Identification plate..... 412
 Seat..... 412
 Windshield..... 412
- Vision**
 Removing condensation from the win-
 dows..... 169
 Windshield heater..... 172
- W**
- Warning lamp**
 see Warning/indicator lamp
- Warning system**
 see ATA (anti-theft alarm system)
- Warning triangle**
 Removing..... 363
 Setting up..... 364
- Warning/indicator lamp**
 ABS warning lamp..... 495
 Active Brake Assist warning
 lamp..... 493, 494
 Brake system warning lamp
 (Canada only)..... 492
 BRAKE Brake warning lamp (USA only)..... 492
 Brakes warning lamp (yellow)
 (Canada only)..... 491
 Electric parking brake indicator
 lamp (red) (Canada only)..... 490
 PARK Electric parking brake indicator
 lamp (red) (USA only)..... 490
 Electrical malfunction warning
 lamp..... 487
 ESP® OFF warning lamp..... 496

-  ESP® warning lamp flashes..... 495
-  ESP® warning lamp lights up..... 496
-  Mercedes-Benz emergency call system warning lamp..... 497
-  Power steering warning lamp (red)..... 488
-  Power steering warning lamp (yellow)..... 488
-  Rear axle steering warning lamp (red)..... 489
-  Rear axle steering warning lamp (yellow)..... 489
-  **RBS** Recuperative Brake System warning lamp (USA only)..... 491
-  Reduced warning lamp power..... 487
-  Restraint system warning lamp..... 485
-  Seat belt warning lamp flashes..... 486
-  Seat belt warning lamp lights up.... 486
-  Suspension warning lamp (red)..... 494
-  Suspension warning lamp (yellow)..... 494
-  System error warning lamp..... 487
-  The electric parking brake (yellow) indicator lamp..... 490
-  Tire pressure monitoring system warning lamp flashes..... 498
-  Tire pressure monitoring system warning lamp lights up..... 498
-  Warning lamp for distance warning function..... 493
- Overview..... 484
- PASSENGER AIR BAG..... 54
- Warranty**..... 37
- Washing by hand (care)**..... 357
- Water tank**
see Air-water duct
- Weather information**..... 329
- Web browsers**
Overview..... 341
- Wheel change**
Lowering the vehicle..... 407
Mounting a new wheel..... 407
Removing a wheel..... 406
- Wheel rotation**..... 402
- Wheels**
Care..... 359
Checking..... 381
Checking the tire pressure (manually).... 385
Checking the tire pressure (tire pressure monitoring system)..... 387
Definitions..... 397
DOT, Tire Identification Number (TIN).... 393
Flat tire..... 364
Installing..... 407
Load index..... 395
Load-bearing capacity..... 395
Maximum tire load..... 394
Maximum tire pressure..... 394
MOExtended tires..... 365
Noise generation..... 381
Notes on installing..... 399
Overview of tire labeling..... 392
Removing..... 406
Replacing..... 399, 404

- Restarting the tire pressure monitoring system..... 387
- Rotating..... 402
- Selection..... 399
- Snow chains..... 382
- Speed rating..... 395
- Storing..... 403
- Temperature grade..... 392
- Tire and Loading Information placard..... 388
- Tire characteristics..... 395
- Tire pressure (notes)..... 383
- Tire pressure monitoring system (function)..... 386
- Tire pressure table..... 384
- Tire Quality Grading..... 392
- Tire size designation..... 395
- TIREFIT kit..... 366
- Traction grade..... 392
- Tread wear grade..... 392
- Unfamiliar handling..... 381
- Wi-Fi**
- Configuring..... 318
- Window curtain airbag**..... 50
- Window lifter**
- see Side windows
- Windows**
- Care..... 359
- Windows**
- see Side windows
- Windshield**
- Defrosting..... 163
- Defrosting (3-zone automatic climate control)..... 164
- Infrared reflective..... 162
- Radio waves..... 162
- Replacing the wiper blades..... 157
- Windshield**
- see Windshield
- Windshield heater**..... 172
- Windshield heater**
- see Windshield heater
- Windshield washer fluid**
- Notes..... 416
- Windshield washer system**
- Refilling..... 355
- Windshield wipers**
- Activating/deactivating..... 157
- Replacing the wiper blades..... 157
- Winter operation**
- Activating/deactivating snow chain mode..... 382
- Snow chains..... 382
- Wiper blades**
- Care..... 359
- Replacing (windshield)..... 157
- Wireless charging**
- Function/notes..... 138
- Mobile phone (rear passenger compartment)..... 140
- Mobile phone, front..... 140
- Wireless vehicle components**
- Declaration of conformity..... 33
- Workout program**
- Overview..... 112
- Workshop**
- see Qualified specialist workshop
- Z**
- Zero Layer (central display)**
- Calling up..... 298
- Function..... 295
- Operating..... 298

Overview..... 296

