



# Mercedes-AMG GT R

Operator's Manual



1905842203

Order no. P190 0203 13 Part no. 190 584 22 03 Edition B-2018

Mercedes-AMG GT R

Mercedes-Benz



## Symbols

Registered trademarks:

- Bluetooth® is a registered trademark of Bluetooth SIG Inc.
- DTS™ is a registered trademark of DTS, Inc.
- Dolby® and MLP™ are registered trademarks of DOLBY Laboratories.
- BabySmart™, ESP® and PRE-SAFE® are registered trademarks of Daimler AG.
- HomeLink® is a registered trademark of Johnson Controls.
- iPod® and iTunes® are registered trademarks of Apple Inc.
- Burmester® is a registered trademark of Burmester Audiosysteme GmbH.
- Microsoft® and Windows media® are registered trademarks of Microsoft Corporation.
- SIRIUS® is a registered trademark of Sirius XM Radio Inc.
- HD Radio™ is a registered trademark of iBiquity Digital Corporation.
- Gracenote® is a registered trademark of Gracenote, Inc.
- ZAGAT Survey® and related brands are registered trademarks of Zagat Survey, LLC.

In this Operator's Manual you will find the following symbols:

### **WARNING**

Warning notes make you aware of dangers which could pose a threat to your health or life, or to the health and life of others.

### **Environmental note**

Environmental notes provide you with information on environmentally aware actions or disposal.

 Notes on material damage alert you to dangers that could lead to damage to your vehicle.

 Practical tips or further information that could be helpful to you.

- ▶ This symbol indicates an instruction that must be followed.
- ▶ Several of these symbols in succession indicate an instruction with several steps.

 This symbol tells you where you can find more information about a topic.

 This symbol indicates a warning or an instruction that is continued on the next page.

 **Display** This text indicates a message on the multifunction display/multimedia display.

 This symbol tells you that you can find further information in the Digital Operator's Manual.

## Publication details

### Internet

Further information about Mercedes-Benz vehicles and about Daimler AG can be found on the following websites:

<http://www.mbusa.com> (USA only)

<http://www.mercedes-benz.ca> (Canada only)

### Editorial office

©Daimler AG: not to be reprinted, translated or otherwise reproduced, in whole or in part, without written permission from Daimler AG.

### Vehicle manufacturer

Daimler AG  
Mercedesstraße 137  
70327 Stuttgart  
Germany



## Welcome to the world of Mercedes-Benz

We urge you to read this Operator's Manual carefully and familiarize yourself with the vehicle before driving. For your own safety and a longer vehicle life, follow the instructions and warning notices in this Operator's Manual. Ignoring them could result in damage to the vehicle or personal injury to you or others.

Vehicle damage caused by failure to follow instructions is not covered by the Mercedes-Benz Limited Warranty.

The equipment or product designation of your vehicle may vary depending on:

- Model
- Order
- Country specification
- Availability

Mercedes-Benz therefore reserves the right to introduce changes in the following areas:

- Design
- Equipment
- Technical features

The equipment in your vehicle may therefore differ from that shown in the descriptions and illustrations.

The following are integral components of the vehicle:

- Digital Operator's Manual
- Printed Operator's Manual
- Maintenance Booklet
- Equipment-dependent supplements

Keep these documents in the vehicle at all times. If you sell the vehicle, always pass all documents on to the new owner.

### Your Operator's Manual:

#### Digital form inside the vehicle

The Digital Operator's Manual provides comprehensive and specifically adapted information on your vehicle's equipment and multimedia system. It contains informative animations, individual language settings and an intuitive search function.

#### Booklet inside the vehicle

In addition to this manual and the aforementioned digital media, you also have the option to obtain a comprehensive printed version of the Supplement for your multimedia system from your authorized Mercedes-Benz Center.

#### Digital form via the Internet

The Operator's Manual on the Internet provides easy access to all information regarding your vehicle and multimedia system. It also provides helpful animations, interesting background information and a wide array of search options.

#### Digital form as an app

Using the Mercedes-Benz Guides app, you can view all the information on your vehicle and multimedia system via mobile Internet or download it independently of network access. Available for smartphones or tablets.



Apple® iOS



Android™

Please note that the Mercedes-Benz Guides app may not yet be available in your country.

Mercedes-Benz USA, LLC  
Mercedes-Benz Canada, Inc.  
A Daimler Company

|  |           |   |            |
|--|-----------|---|------------|
| <b>Index</b> .....                             | <b>4</b>  | Memory function .....                                       | 85         |
| <b>Digital Operator's Manual</b> .....         | <b>22</b> | <b>Lights and windshield wipers</b> .....                   | <b>87</b>  |
| Introduction .....                             | 22        | Exterior lighting .....                                     | 87         |
| Operation .....                                | 22        | Interior lighting .....                                     | 90         |
| <b>Introduction</b> .....                      | <b>23</b> | Replacing bulbs .....                                       | 91         |
| Protecting the environment .....               | 23        | Windshield wipers .....                                     | 91         |
| Genuine Mercedes-Benz parts .....              | 23        | <b>Climate control</b> .....                                | <b>94</b>  |
| Operator's Manual .....                        | 24        | Overview of climate control systems .....                   | 94         |
| Service and vehicle operation .....            | 24        | Operating the climate control systems .....                 | 95         |
| Operating safety .....                         | 26        | Air vents .....   | 98         |
| QR codes for the rescue card .....             | 28        | <b>Driving and parking</b> .....                            | <b>100</b> |
| Data stored in the vehicle .....               | 28        | Notes on breaking-in a new vehicle .....                    | 100        |
| Mercedes me website .....                      | 30        | Driving .....   | 100        |
| Information on copyright .....                 | 31        | DYNAMIC SELECT controller .....                             | 107        |
| <b>At a glance</b> .....                       | <b>32</b> | AMG SPEEDSHIFT DCT 7-speed sports transmission .....        | 108        |
| Cockpit .....                                  | 32        | Refueling .....   | 116        |
| Instrument cluster .....                       | 33        | Parking .....   | 118        |
| Multifunction steering wheel .....             | 34        | Driving tips .....  | 122        |
| Center console .....                           | 35        | Driving systems .....                                       | 125        |
| Overhead control panel .....                   | 36        | <b>On-board computer and displays</b> .....                 | <b>150</b> |
| Door control panel .....                       | 37        | Important safety notes .....                                | 150        |
| <b>Safety</b> .....                            | <b>38</b> | Displays and operation .....                                | 150        |
| Panic alarm .....                              | 38        | Menus and submenus .....                                    | 152        |
| Occupant safety .....                          | 38        | Display messages .....                                      | 164        |
| Children in the vehicle .....                  | 53        | Warning and indicator lamps in the instrument cluster ..... | 188        |
| Pets in the vehicle .....                      | 56        | <b>Multimedia system</b> .....                              | <b>199</b> |
| Driving safety systems .....                   | 56        | General notes .....   | 199        |
| Protection against theft .....                 | 62        | Important safety notes .....                                | 199        |
| <b>Opening and closing</b> .....               | <b>64</b> | Function restrictions .....                                 | 199        |
| SmartKey .....                                 | 64        | Operating system .....                                      | 200        |
| Doors .....                                    | 69        | <b>Stowage and features</b> .....                           | <b>208</b> |
| Cargo compartment .....                        | 71        | Stowage areas .....   | 208        |
| Side windows .....                             | 73        | Features .....  | 211        |
| <b>Seats, steering wheel and mirrors</b> ..... | <b>77</b> |   |            |
| Correct driver's seat position .....           | 77        |   |            |
| Seats .....                                    | 77        |   |            |
| Steering wheel .....                           | 81        |   |            |
| Mirrors .....                                  | 83        |   |            |

|   |            |
|---|------------|
| <b>Maintenance and care</b> .....             | <b>226</b> |
| Engine compartment .....                      | 226        |
| ASSYST PLUS .....                             | 231        |
| Care .....                                    | 232        |
| <b>Breakdown assistance</b> .....             | <b>239</b> |
| Where will I find...? .....                   | 239        |
| Flat tire .....                               | 240        |
| Battery (vehicle) .....                       | 244        |
| Jump-starting .....                           | 245        |
| Towing and tow-starting .....                 | 248        |
| Fuses .....                                   | 250        |
| <b>Wheels and tires</b> .....                 | <b>252</b> |
| Important safety notes .....                  | 252        |
| Operation .....                               | 252        |
| Winter operation .....                        | 254        |
| Tire pressure .....                           | 255        |
| Loading the vehicle .....                     | 260        |
| All about wheels and tires .....              | 263        |
| Changing a wheel .....                        | 270        |
| Wheel and tire combinations .....             | 274        |
| <b>Technical data</b> .....                   | <b>276</b> |
| Information regarding technical data ...      | 276        |
| Vehicle electronics .....                     | 276        |
| Identification plates .....                   | 276        |
| Service products and filling capacities ..... | 277        |
| Vehicle data .....                            | 282        |



**1, 2, 3 ...****12 V socket**

see Sockets

**A****ABS (Anti-lock Braking System)**

- Display message ..... 166
- Function/notes ..... 56
- Warning lamp ..... 191

**Accident**

- Automatic measures after an accident ..... 53

**Activating media mode**

- General notes ..... 206

**Activating/deactivating cooling****with air dehumidification** ..... 95**Active aerodynamics profile**

- Display message ..... 186
- Extending/retracting ..... 221
- Problem ..... 222

**Active Brake Assist**

- Activating or deactivating ..... 159
- Display message ..... 171
- Function/notes ..... 57

**ADAPTIVE BRAKE** ..... 62**Adaptive Brake Assist**

- Display message ..... 166

**Adaptive Damping System**

- Function/notes ..... 138

**Adaptive Highbeam Assist**

- Display message ..... 176
- Function/notes ..... 89
- Switching on/off ..... 90

**Additional speedometer** ..... 161**Additives (engine oil)** ..... 280**Address book**

- see also Digital Operator's Manual ..... 199

**Adjusting lumbar support** ..... 79**Adjusting the volume**

- Multimedia system ..... 200

**Air bags**

- Deployment ..... 50
- Display message ..... 174
- Front air bag (driver, front passenger) ..... 44

Important safety notes ..... 43

Introduction ..... 43

Knee bag ..... 45

Occupant Classification System

(OCS) ..... 46

PASSENGER AIR BAG indicator

lamps ..... 39

Side impact air bag ..... 45

Window curtain air bag ..... 45

**Air vents**

Important safety notes ..... 98

Setting ..... 98

Setting the side air vents ..... 99

**Air-conditioning system**

see Climate control

**Alarm**

ATA (Anti-Theft Alarm system) ..... 62

Switching off (ATA) ..... 62

Switching the function on/off

(ATA) ..... 62

**Alarm system**

see ATA (Anti-Theft Alarm system)

**AMG**

Adaptive sport suspension system ..... 138

E-SELECT lever ..... 108

Menu (on-board computer) ..... 161

Performance Seat ..... 80

SPEEDSHIFT DCT 7-gear sport transmission ..... 108

**AMG ceramic brakes** ..... 124**AMG high-performance and ceramic brakes** ..... 124**AMG sports exhaust system** ..... 105**Anti-lock braking system**

see ABS (Anti-lock Braking System)

**Anti-Theft Alarm system**

see ATA (Anti-Theft Alarm system)

**Ashtray** ..... 212**Assistance display (on-board computer)** ..... 158**Assistance menu (on-board computer)** ..... 159**ASSYST PLUS**

Displaying a service message ..... 232

Hiding a service message ..... 231

- Resetting the service interval display ..... 232
  - Service message ..... 231
  - Special service requirements ..... 232
  - ATA (Anti-Theft Alarm system)**
    - Activating/deactivating ..... 62
    - Function ..... 62
    - Switching off the alarm ..... 62
  - ATTENTION ASSIST**
    - Activating/deactivating ..... 159
    - Display message ..... 179
    - Function/notes ..... 144
  - Authorized Mercedes-Benz Center**  
see Qualified specialist workshop
  - Authorized workshop**  
see Qualified specialist workshop
  - AUTO lights**
    - Display message ..... 176
    - see Lights
  - Automatic car wash (care)** ..... 233
  - Automatic engine start (ECO start/stop function)** ..... 105
  - Automatic engine switch-off (ECO start/stop function)** ..... 104
  - Automatic headlamp mode** ..... 87
  - Automatic transmission**
    - Accelerator pedal position ..... 111
    - Automatic drive program ..... 113
    - Changing gear ..... 111
    - Display message ..... 184
    - Double-clutch function ..... 111
    - Drive program display ..... 110
    - Driving tips ..... 111
    - Emergency running mode ..... 116
    - Gliding mode ..... 111
    - Important safety notes ..... 108
    - Kickdown ..... 111
    - Manual drive program ..... 113
    - Manual mode ..... 114
    - Oil temperature (on-board computer) ..... 161
    - Overview ..... 108
    - Problem (malfunction) ..... 116
    - Pulling away ..... 103
    - Rocking the vehicle free ..... 111
    - Starting the engine ..... 103
    - Steering wheel paddle shifters ..... 112
    - Transmission position display ..... 110
    - Transmission positions ..... 110
  - Automatic transmission emergency mode** ..... 116
- B**
- Back button** ..... 200
  - BAS (Brake Assist System)** ..... 57
  - Battery (SmartKey)**
    - Checking ..... 67
    - Important safety notes ..... 66
    - Replacing ..... 67
  - Battery (vehicle)**
    - Charging ..... 245
    - Display message ..... 178
    - Important safety notes ..... 244
    - Jump starting ..... 245
  - Belt**  
see Seat belts
  - Belt warning** ..... 43
  - Blind Spot Assist**
    - Activating/deactivating (on-board computer) ..... 159
    - Display message ..... 180
    - Notes/function ..... 146
  - Bluetooth®**
    - Connecting a different mobile phone ..... 206
    - Searching for a mobile phone ..... 206
    - see also Digital Operator's Manual ..... 199
    - Telephony ..... 205
  - Brake Assist**  
see BAS (Brake Assist System)
  - Brake fluid**
    - Display message ..... 171
    - Notes ..... 280
  - Brake force distribution**  
see EBD (electronic brake force distribution)
  - Brakes**
    - ABS ..... 56
    - AMG high-performance and ceramic brakes ..... 124
    - BAS ..... 57
    - Brake fluid (notes) ..... 280
    - Braking assistance appropriate to the situation ..... 59

- Display message ..... 166
  - EBD ..... 62
  - Hill start assist ..... 103
  - Important safety notes ..... 123
  - Maintenance ..... 124
  - Parking brake ..... 120
  - Riding tips ..... 123
  - Warning lamp ..... 190
  - Braking assistance appropriate to the situation**
    - Function/notes ..... 59
  - Breakdown**
    - Where will I find...? ..... 239
    - see Flat tire
    - see Towing away
  - Buttons on the steering wheel** ..... 151
- C**
- California**
    - Important notice for retail customers and lessees ..... 24
  - Calling up a malfunction**
    - see Display messages
  - Calling up the climate control bar**
    - Multimedia system ..... 203
  - Calling up the climate control menu**
    - Multimedia system ..... 203
  - Car**
    - see Vehicle
  - Care**
    - Car wash ..... 233
    - Carpets ..... 238
    - Display ..... 237
    - Exhaust pipe ..... 236
    - Exterior lights ..... 236
    - Gear or selector lever ..... 237
    - Interior ..... 237
    - Matte finish ..... 234
    - Notes ..... 232
    - Paint ..... 234
    - Plastic trim ..... 237
    - Power washer ..... 234
    - Rear view camera ..... 236
    - Roof lining ..... 238
    - Seat belt ..... 238
    - Seat cover ..... 238
    - Sensors ..... 236
    - Steering wheel ..... 237
    - Trim pieces ..... 237
    - Washing by hand ..... 233
    - Wheels ..... 235
    - Windows ..... 235
    - Wiper blades ..... 235
  - Cargo compartment cover**
    - Important safety notes ..... 210
  - Cargo net** ..... 210
  - CD**
    - see also Digital Operator's Manual ..... 199
  - CD player (on-board computer)** ..... 156
  - Center console**
    - Overview ..... 35
  - Central locking**
    - Locking/unlocking (SmartKey) ..... 64
  - Changing the media source** ..... 156
  - Charge retention**
    - Socket ..... 121
  - Charge-air pressure (on-board computer)** ..... 161
  - Child**
    - Restraint system ..... 54
  - Child seat**
    - Forward-facing restraint system ..... 55
    - On the front-passenger seat ..... 55
    - Rearward-facing restraint system ..... 55
  - Children**
    - Special seat belt retractor ..... 54
  - Children in the vehicle**
    - Important safety notes ..... 53
  - Cigarette lighter** ..... 213
  - Cleaning**
    - Mirror turn signal ..... 236
  - Climate control**
    - Automatic climate control (dual-zone) ..... 94
    - Controlling automatically ..... 96
    - Cooling with air dehumidification ..... 95
    - Cooling with air dehumidification (multimedia system) ..... 203
    - Defrosting the windows ..... 97
    - Defrosting the windshield ..... 97
    - ECO start/stop function (3-zone automatic climate control) ..... 95



- General notes ..... 94
  - Indicator lamp ..... 96
  - Information about using automatic climate control ..... 95
  - Overview ..... 203
  - Overview of systems ..... 94
  - Problem with the rear window defroster ..... 98
  - Problems with cooling with air dehumidification ..... 96
  - Refrigerant ..... 282
  - Refrigerant filling capacity ..... 282
  - Setting the air distribution ..... 96
  - Setting the air vents ..... 98
  - Setting the airflow ..... 97
  - Setting the climate mode (multimedia system) ..... 203
  - Setting the temperature ..... 96
  - Switching air-recirculation mode on/off ..... 98
  - Switching on/off ..... 95
  - Switching the rear window defroster on/off ..... 97
  - Switching the synchronization function on and off ..... 97
  - Synchronization function (multimedia system) ..... 204
  - Climate control settings**
    - Multimedia system ..... 203
  - Climate control system**
    - Climate control (3-zone automatic climate control) ..... 95
  - Cockpit**
    - Overview ..... 32
  - COMAND display**
    - Cleaning ..... 237
  - Combination switch** ..... 88
  - Connecting a USB device**
    - see also Digital Operator's Manual ..... 199
  - Consumption statistics (on-board computer)** ..... 153
  - Controller** ..... 200
  - Convenience closing feature** ..... 74
  - Convenience opening feature** ..... 74
  - Coolant (engine)**
    - Checking the level ..... 230
  - Display message ..... 177
  - Filling capacity ..... 281
  - Important safety notes ..... 281
  - Temperature display in the instrument cluster ..... 150
  - Warning lamp ..... 194
  - Cooling**
    - see Climate control
  - Copyright** ..... 31
  - Cornering light function**
    - Display message ..... 176
  - Cruise control**
    - Cruise control lever ..... 126
    - Deactivating ..... 127
    - Display message ..... 181
    - Driving system ..... 125
    - Function/notes ..... 125
    - Setting a speed ..... 127
    - Storing and maintaining current speed ..... 126
  - Cup holder**
    - Center console ..... 211
    - Important safety notes ..... 211
  - Customer Assistance Center (CAC)** ..... 27
  - Customer Relations Department** ..... 27
- ## D
- Data**
    - see Technical data
  - Data carrier**
    - Selecting ..... 156
  - Daytime running lamps**
    - Display message ..... 176
    - Function/notes ..... 87
    - Switching on/off (on-board computer) ..... 160
  - Declarations of conformity** ..... 26
  - Diagnostics connection** ..... 27
  - Digital Operator's Manual**
    - Help ..... 22
    - Introduction ..... 22
  - Digital speedometer** ..... 153
  - Display**
    - see Display messages
    - see Warning and indicator lamps

- Display messages**
  - ASSYST PLUS ..... 231
  - Calling up (on-board computer) .... 165
  - Driving systems ..... 179
  - Engine ..... 177
  - General notes ..... 164
  - Hiding (on-board computer) ..... 165
  - Introduction ..... 164
  - Lights ..... 176
  - Safety systems ..... 166
  - SmartKey ..... 187
  - Tires ..... 182
  - Vehicle ..... 184
- Distance Pilot DISTRONIC**
  - Activating ..... 129
  - Activation conditions ..... 129
  - Cruise control lever ..... 129
  - Display Message ..... 181
  - Displays in the instrument cluster .. 133
  - Driving tips ..... 133
  - Driving with Distance Pilot
  - DISTRONIC ..... 130
  - Function/notes ..... 127
  - Important safety notes ..... 128
  - Setting a speed ..... 131
  - Setting the specified minimum distance ..... 132
  - Stopping ..... 131
  - Switching off ..... 132
- Distance recorder** ..... 152
- Distance warning (warning lamp)** .... 196
- Distance warning function**
  - Function/notes ..... 58
- Door control panel**
  - Overview ..... 37
- Doors**
  - Automatic locking (switch) ..... 70
  - Central locking/unlocking (SmartKey) ..... 64
  - Display message ..... 186
  - Emergency locking ..... 71
  - Emergency unlocking ..... 71
  - Important safety notes ..... 69
  - Opening (from inside) ..... 70
- Drinking and driving** ..... 122
- Drive program**
  - Automatic ..... 113
  - Display ..... 110
  - Manual ..... 113
  - SETUP (on-board computer, Mercedes-AMG vehicles) ..... 162
- Driver's door**
  - see Doors
- Driving**
  - Important safety notes ..... 100
- Driving abroad**
  - Mercedes-Benz Service ..... 232
- Driving on flooded roads** ..... 125
- Driving safety system**
  - Active Brake Assist ..... 57
  - Braking assistance appropriate to the situation ..... 59
- Driving safety systems**
  - ABS (Anti-lock Braking System) ..... 56
  - ADAPTIVE BRAKE ..... 62
  - BAS (Brake Assist System) ..... 57
  - Distance warning function ..... 58
  - EBD (electronic brake force distribution) ..... 62
  - ESP® (Electronic Stability Program) ..... 59
  - Important safety information ..... 56
  - Overview ..... 56
- Driving system**
  - Distance Pilot DISTRONIC ..... 127
  - Parking assist PARKTRONIC ..... 138
- Driving systems**
  - AMG adaptive sport suspension system ..... 138
  - ATTENTION ASSIST ..... 144
  - Blind Spot Assist ..... 146
  - Cruise control ..... 125
  - Display message ..... 179
  - HOLD function ..... 135
  - Lane Keeping Assist ..... 148
  - Lane Tracking package ..... 146
  - RACE START ..... 136
  - Rear view camera ..... 141
- Driving tips**
  - AMG high-performance and ceramic brakes ..... 124
  - Automatic transmission ..... 111
  - Brakes ..... 123
  - Break-in period ..... 100
  - Distance Pilot DISTRONIC ..... 133
  - Downhill gradient ..... 123

- Drinking and driving ..... 122
  - Driving in winter ..... 125
  - Driving on flooded roads ..... 125
  - Driving on wet roads ..... 125
  - Exhaust check ..... 122
  - Fuel ..... 122
  - General ..... 122
  - Hydroplaning ..... 125
  - Icy road surfaces ..... 125
  - Limited braking efficiency on salted roads ..... 123
  - Snow chains ..... 254
  - Subjecting brakes to a load ..... 123
  - The first 1000 miles (1500 km) .... 100
  - Wet road surface ..... 123
  - DVD video**
  - Operating (on-board computer) .... 157
  - see also Digital Operator's Manual ..... 199
  - DYNAMIC SELECT controller** ..... 107
- E**
- E-SELECT lever** ..... 108
  - EASY-ENTRY feature**
  - Function/notes ..... 82
  - EASY-EXIT feature**
  - Function/notes ..... 82
  - EBD (electronic brake force distribution)**
  - Display message ..... 168
  - Function/notes ..... 62
  - ECO start/stop function**
  - Automatic engine switch-off ..... 104
  - Deactivating/activating ..... 105
  - General information ..... 104
  - Important safety notes ..... 104
  - Introduction ..... 104
  - Electronic Stability Program**
  - see ESP® (Electronic Stability Program)
  - Emergency**
  - Automatic measures after an accident ..... 53
  - Emergency release**
  - Driver's door ..... 71
  - Vehicle ..... 71
  - Emergency Tensioning Devices**
  - Activation ..... 50
  - Emergency unlocking**
  - Tailgate ..... 72
  - Emissions control**
  - Service and warranty information .... 24
  - Engine**
  - Check Engine warning lamp ..... 194
  - Display message ..... 177
  - ECO start/stop function ..... 104
  - Engine number ..... 277
  - Irregular running ..... 106
  - Jump-starting ..... 245
  - Starting problems ..... 106
  - Starting the engine with the SmartKey ..... 103
  - Starting with the Start/Stop button ..... 103
  - Switching off ..... 119
  - Tow-starting (vehicle) ..... 250
  - Engine electronics**
  - Notes ..... 276
  - Problem (malfunction) ..... 106
  - Engine oil**
  - Adding ..... 229
  - Additives ..... 280
  - Checking the oil level ..... 227
  - Checking the oil level using the dipstick ..... 227
  - Checking the oil level using the on-board computer ..... 228
  - Display message ..... 178
  - Filling capacity ..... 280
  - Notes about oil grades ..... 280
  - Notes on oil level/consumption .... 227
  - Temperature (on-board computer) ..... 161
  - Entering an address**
  - see also Digital Operator's Manual ..... 199
  - ESP® (Electronic Stability Program)**
  - AMG menu (on-board computer) ... 162
  - Characteristics ..... 60
  - Deactivating/activating ..... 60
  - Display message ..... 166
  - Function/notes ..... 59
  - General notes ..... 59
  - Important safety information ..... 60
  - Warning lamp ..... 191



- ETS/4ETS (Electronic Traction System)** ..... 60
- Exhaust check** ..... 122
- Exhaust pipe (cleaning instructions)** ..... 236
- Exterior lighting**
- Cleaning ..... 236
  - see Lights
- Exterior mirrors**
- Adjusting ..... 83
  - Dipping (automatic) ..... 84
  - Folding in/out (automatically) ..... 84
  - Folding in/out (electrically) ..... 84
  - Out of position (troubleshooting) ..... 84
  - Setting ..... 84
  - Storing settings (memory function) ..... 86
  - Storing the parking position ..... 85
- F**
- Favorites**
- Overview ..... 202
- Features** ..... 211
- Filler cap**
- see Refueling
- Flat tire**
- Changing a wheel/mounting the spare wheel ..... 270
  - Preparing the vehicle ..... 240
  - TIREFIT kit ..... 241
- Floormats** ..... 225
- Frequencies**
- Mobile phone ..... 276
  - Two-way radio ..... 276
- Fuel**
- Additives ..... 279
  - Consumption statistics ..... 153
  - Displaying the current consumption ..... 153
  - Displaying the range ..... 153
  - Driving tips ..... 122
  - E10 ..... 278
  - Fuel gauge ..... 33
  - Grade (gasoline) ..... 278
  - Important safety notes ..... 278
  - Problem (malfunction) ..... 118
  - Refueling ..... 116
  - Tank content/reserve fuel ..... 278
- Fuel filler flap**
- Closing ..... 117
  - General information ..... 117
  - Opening ..... 117
  - Problem (malfunction) ..... 118
- Fuel level**
- Calling up the range (on-board computer) ..... 153
- Fuel tank**
- Capacity ..... 278
  - Problem (malfunction) ..... 118
- Fuses**
- Allocation chart ..... 251
  - Before changing ..... 251
  - Fuse box in the cargo compartment ..... 251
  - Fuse box in the front-passenger footwell ..... 251
  - Important safety notes ..... 250
- G**
- G-Meter (on-board computer)** ..... 162
- Garage door opener**
- Clearing the memory ..... 225
  - General notes ..... 222
  - Important safety notes ..... 223
  - Opening/closing the garage door .. 225
  - Problems when programming ..... 224
  - Programming (button in the rear-view mirror) ..... 223
  - Synchronizing the rolling code ..... 223
- Gasoline** ..... 278
- Gear indicator (on-board computer)** ..... 161
- Genuine parts** ..... 23
- Glove box** ..... 209
- Google™ Local Search**
- see also Digital Operator's Manual ..... 199
- H**
- Handbrake**
- see Parking brake

- Handwriting recognition**  
 Switching text reader function  
 on/off ..... 202  
 Touchpad ..... 201
- Hazard warning lamps** ..... 89
- Head restraints**  
 Adjusting ..... 79
- Headlamps**  
 Cleaning system (notes) ..... 281  
 Fogging up ..... 90  
 see Automatic headlamp mode
- Heating**  
 see Climate control
- High beam flasher** ..... 88
- High-beam headlamps**  
 Display message ..... 176  
 Switching on/off ..... 88
- Hill start assist** ..... 103
- HOLD function**  
 Activating ..... 135  
 Deactivating ..... 136  
 Display message ..... 180  
 Function/notes ..... 135
- Home address**  
 see also Digital Operator's Manual ..... 199
- Hood**  
 Closing ..... 227  
 Display message ..... 186  
 Important safety notes ..... 226  
 Opening ..... 226
- Horn** ..... 32
- Hydroplaning** ..... 125
- I**
- Ignition lock**  
 see Key positions
- Immobilizer** ..... 62
- Indicator lamps**  
 see Warning and indicator lamps
- Indicators**  
 see Turn signals
- Instrument cluster**  
 Overview ..... 33  
 Warning and indicator lamps ..... 33
- Instrument cluster lighting** ..... 160
- Interior lighting**  
 Automatic control ..... 90  
 Overview ..... 90  
 Reading lamp ..... 90  
 Setting the brightness of the display/switch (on-board computer) .. 160
- iPod®**  
 see also Digital Operator's Manual ..... 199
- J**
- Jack**  
 Using ..... 271
- Jump starting (engine)** ..... 245
- K**
- Key positions**  
 SmartKey ..... 102  
 Start/Stop button ..... 101
- KEYLESS-GO**  
 Convenience closing feature ..... 74  
 Deactivation ..... 65  
 Locking ..... 65  
 Start function ..... 65  
 Unlocking ..... 65
- KEYLESS-GO start function**  
 Start/Stop button ..... 101
- Kickdown**  
 Driving tips ..... 111
- Knee bag** ..... 45
- L**
- Lamps**  
 see Warning and indicator lamps
- Lane Keeping Assist**  
 Activating/deactivating (on-board computer) ..... 160  
 Display message ..... 180  
 Function/information ..... 148
- Lane Tracking package** ..... 146
- Lap time (RACETIMER)** ..... 163
- License plate lamp (display message)** ..... 176
- Light sensor (display message)** ..... 176
- Lights**  
 Automatic headlamp mode ..... 87

- Fogged up headlamps ..... 90
  - Hazard warning lamps ..... 89
  - High beam flasher ..... 88
  - High-beam headlamps ..... 88
  - Light switch ..... 87
  - Low-beam headlamps ..... 88
  - Parking lamps ..... 88
  - Rear fog lamp ..... 88
  - Setting exterior lighting ..... 87
  - Setting the brightness of the display/switch (on-board computer) .. 160
  - Standing lamps ..... 88
  - Switching the daytime running lamps on/off (on-board computer) ..... 160
  - Turn signals ..... 88
  - see Interior lighting
  - Loading guidelines** ..... 208
  - Locking (doors)**
    - Automatic ..... 70
    - Emergency locking ..... 71
    - From inside (central locking button) ..... 70
    - see KEYLESS-GO
  - Locking centrally**
    - see Central locking
  - Low-beam headlamps**
    - Display message ..... 176
    - Switching on/off ..... 88
- M**
- M button** ..... 112
  - M+S tires** ..... 254
  - Malfunction message**
    - see Display messages
  - Manual mode** ..... 114
  - Matte finish (cleaning instructions)** ..... 234
  - mbrace**
    - Call priority ..... 217
    - Display message ..... 171
    - Downloading destinations (COMAND) ..... 217
    - Downloading routes ..... 220
    - Emergency call ..... 215
    - General notes ..... 214
    - Geo fencing ..... 220
    - Info call button ..... 216
    - Locating a stolen vehicle ..... 219
    - Remote fault diagnosis ..... 219
    - Remote vehicle locking ..... 218
    - Roadside assistance button ..... 216
    - Search & Send ..... 218
    - Self-test ..... 214
    - Speed alert ..... 220
    - System ..... 214
    - Triggering the vehicle alarm ..... 220
    - Vehicle remote unlocking ..... 218
  - Mechanical key**
    - Function/notes ..... 66
    - General notes ..... 66
    - Inserting ..... 66
    - Locking vehicle ..... 71
    - Removing ..... 66
    - Unlocking the driver's door ..... 71
  - Media Interface**
    - see Digital Operator's Manual
  - Memory card (audio)** ..... 156
  - Memory function**
    - Seats, steering wheel, exterior mirrors ..... 85
  - Mercedes me connect**
    - Change of vehicle ..... 30
    - Data protection ..... 30
    - Website ..... 30
  - Mercedes-Benz Intelligent Drive**
    - Distance Pilot DISTRONIC ..... 127
  - Message memory (on-board computer)** ..... 165
  - Messages**
    - see Display messages
    - see Warning and indicator lamps
  - Mirror turn signal**
    - Cleaning ..... 236
  - Mirrors**
    - see Exterior mirrors
    - see Rear-view mirror
    - see Vanity mirror
  - Mobile phone**
    - Connecting (Bluetooth® interface) ..... 205
    - Connecting another mobile phone ..... 206
    - Frequencies ..... 276
    - Installation ..... 276



- Menu (on-board computer) ..... 157
  - Transmission output (maximum) .... 276
  - Modifying the programming (SmartKey)** ..... 65
  - Mounting wheels**
    - Lowering the vehicle ..... 274
    - Mounting a new wheel ..... 273
    - Preparing the vehicle ..... 271
    - Raising the vehicle ..... 271
    - Removing a wheel ..... 273
    - Securing the vehicle against rolling away ..... 271
  - MP3**
    - Operation ..... 156
    - see also Digital Operator's Manual ..... 199
  - Multifunction display**
    - Function/notes ..... 152
  - Multifunction steering wheel**
    - Operating the on-board computer .. 151
    - Overview ..... 34
  - Multimedia system**
    - Switching on and off ..... 200
  - Music files**
    - see also Digital Operator's Manual ..... 199
- N**
- Navigation**
    - Displaying (on-board computer) .... 154
    - Menu (on-board computer) ..... 154
    - see also Digital Operator's Manual ..... 199
  - Notes on breaking-in a new vehicle** ..... 100
- O**
- Occupant Classification System (OCS)**
    - Conditions ..... 46
    - Faults ..... 49
    - Operation ..... 46
    - System self-test ..... 48
  - Occupant safety**
    - Air bags ..... 43
    - Automatic measures after an accident ..... 53
    - Belt warning ..... 43
    - Children in the vehicle ..... 53
    - Important safety notes ..... 38
    - Introduction to the restraint system ..... 38
    - Occupant Classification System (OCS) ..... 46
    - PASSENGER AIR BAG indicator lamps ..... 39
    - Pets in the vehicle ..... 56
    - PRE-SAFE® (anticipatory occupant protection) ..... 52
    - Restraint system warning lamp ..... 39
    - Seat belt ..... 39
  - OCS**
    - Conditions ..... 46
    - Faults ..... 49
    - Operation ..... 46
    - System self-test ..... 48
  - Odometer** ..... 152
  - Oil**
    - see Engine oil
  - On-board computer**
    - AMG menu ..... 161
    - Assistance graphic menu ..... 158
    - Assistance menu ..... 159
    - Display messages ..... 164
    - Displaying a service message ..... 232
    - Distance Pilot DISTRONIC ..... 133
    - Factory settings ..... 161
    - G-Meter ..... 162
    - Important safety notes ..... 150
    - Instrument cluster menu ..... 160
    - Lights menu ..... 160
    - Media menu ..... 156
    - Menu overview ..... 152
    - Message memory ..... 165
    - Navigation menu ..... 154
    - Operation ..... 151
    - RACETIMER ..... 163
    - Radio menu ..... 155
    - Service menu ..... 159
    - Settings menu ..... 159
    - Standard display ..... 152
    - Telephone menu ..... 157
    - Trip menu ..... 152
    - Video DVD operation ..... 157

- Operating safety**  
 Declaration of conformity ..... 26  
 Important safety notes ..... 26
- Operating system**  
 see On-board computer
- Operation**  
 Digital Operator's Manual ..... 22
- Operator's Manual**  
 Overview ..... 24  
 Vehicle equipment ..... 24
- Outside temperature display** ..... 150
- Overhead control panel** ..... 36
- P**
- Paddle shifters**  
 see Steering wheel paddle shifters
- Paint code number** ..... 276
- Paintwork (cleaning instructions)** ... 234
- Panic alarm** ..... 38
- Parking**  
 Important safety notes ..... 118  
 Parking brake ..... 120  
 Position of exterior mirror, front-passenger side ..... 85  
 Rear view camera ..... 141  
 Switching off the engine ..... 119  
 see Parking Assist PARKTRONIC
- Parking aid**  
 see Exterior mirrors  
 see Parking Assist PARKTRONIC
- Parking Assist PARKTRONIC**  
 Deactivating/activating ..... 140  
 Driving system ..... 138  
 Important safety notes ..... 138  
 Problems (malfunctions) ..... 141  
 Sensor range ..... 139  
 Warning display ..... 140
- Parking brake**  
 Applying automatically ..... 120  
 Applying or releasing manually ..... 120  
 Display message ..... 168  
 Electric parking brake ..... 120  
 Emergency braking ..... 121  
 General notes ..... 120  
 Releasing automatically ..... 121  
 Warning lamp ..... 193
- Parking lamps**  
 Switching on/off ..... 88
- PASSENGER AIR BAG**  
 Display message ..... 174  
 Indicator lamps ..... 39  
 Problems (malfunction) ..... 174
- Pets in the vehicle** ..... 56
- Phone book**  
 see also Digital Operator's Manual ..... 199
- Plastic trim (cleaning instructions)** ..... 237
- Power washers** ..... 234
- Power windows**  
 see Side windows
- PRE-SAFE® (anticipatory occupant protection)**  
 Display message ..... 172  
 Operation ..... 52
- Protection against theft**  
 ATA (Anti-Theft Alarm system) ..... 62  
 Immobilizer ..... 62
- Protection of the environment**  
 General notes ..... 23
- Pulling away**  
 Automatic transmission ..... 103  
 General notes ..... 103  
 Hill start assist ..... 103
- Q**
- QR code**  
 Mercedes-Benz Guide App ..... 1  
 Rescue card ..... 28
- Qualified specialist workshop** ..... 27
- Quick access for audio and telephone**  
 Changing the station/music track ..... 202
- R**
- RACE START**  
 Activating ..... 136  
 Important safety notes ..... 136
- RACE TIMER (on-board computer, Mercedes-AMG vehicles)** ..... 163

- Radio**
    - Selecting a station ..... 155
  - Radio mode**
    - see also Digital Operator's Manual ..... 199
  - Radio-wave reception/transmission in the vehicle**
    - Declaration of conformity ..... 26
  - Reading lamp** ..... 90
  - Rear axle steering**
    - Function/notes ..... 104
  - Rear fog lamp**
    - Display message ..... 176
    - Switching on/off ..... 88
  - Rear lamps**
    - see Lights
  - Rear spoiler**
    - Permanently mounted ..... 222
  - Rear view camera**
    - Cleaning instructions ..... 236
    - Function/notes ..... 141
    - Switching on/off ..... 142
  - Rear window defroster**
    - Problem (malfunction) ..... 98
    - Switching on/off ..... 98
  - Rear-view mirror**
    - Anti-glare (manual) ..... 83
    - Dipping (automatic) ..... 84
  - Reflective safety jacket** ..... 239
  - Refrigerant (air-conditioning system)**
    - Important safety notes ..... 282
  - Refueling**
    - Fuel gauge ..... 33
    - Important safety notes ..... 116
    - Refueling process ..... 117
    - see Fuel
  - Remote control**
    - Garage door opener ..... 222
    - Programming (garage door opener) ..... 223
  - Replacing bulbs**
    - General notes ..... 91
  - Reporting safety defects** ..... 27
  - Rescue card** ..... 28
  - Reserve (fuel tank)**
    - see Fuel
  - Reserve fuel**
    - Display message ..... 179
    - Warning lamp ..... 194
  - Restraint system**
    - Display message ..... 172
    - Introduction ..... 38
    - Warning lamp ..... 193
    - Warning lamp (function) ..... 39
  - Reversing feature**
    - Side windows ..... 73
  - Reversing lamps (display message)** ..... 176
  - Roadside Assistance (breakdown)** .... 25
  - Roof lining and carpets (cleaning guidelines)** ..... 238
  - Route guidance**
    - see also Digital Operator's Manual ..... 199
- S**
- Safety**
    - Children in the vehicle ..... 53
    - see Occupant safety
    - see Operating safety
  - Safety system**
    - see Driving safety systems
  - SD card**
    - Inserting/removing ..... 207
  - SD memory card**
    - see also Digital Operator's Manual ..... 199
    - Selecting ..... 156
  - Search & Send**
    - see also Digital Operator's Manual ..... 199
  - Seat**
    - Correct driver's seat position ..... 77
  - Seat belts**
    - Adjusting the driver's and front-passenger seat belt ..... 42
    - Cleaning ..... 238
    - Correct usage ..... 41
    - Fastening ..... 42
    - Important safety guidelines ..... 40
    - Introduction ..... 39
    - Releasing ..... 42
    - Warning lamp ..... 189

- Warning lamp (function) ..... 43
- Seats**
- Adjusting (electrically) ..... 79
- Adjusting (manually) ..... 78
- Adjusting (Performance Seat) ..... 80
- Adjusting lumbar support ..... 79
- Adjusting the head restraint ..... 79
- Cleaning the cover ..... 238
- Important safety notes ..... 77
- Seat heating problem ..... 81
- Storing settings (memory function) ..... 86
- Switching seat heating on/off ..... 80
- Selector lever**
- Cleaning ..... 237
- Positions ..... 108
- Sensors (cleaning instructions) ..... 236**
- Service menu (on-board computer) ..... 159**
- Service message**
- see ASSYST PLUS
- Service products**
- Brake fluid ..... 280
- Coolant (engine) ..... 281
- Engine oil ..... 280
- Fuel ..... 277
- Important safety notes ..... 277
- Refrigerant (air-conditioning system) ..... 282
- Washer fluid ..... 281
- Setting the date/time format**
- see also Digital Operator's Manual ..... 199
- Setting the language**
- see also Digital Operator's Manual ..... 199
- Setting the time**
- see also Digital Operator's Manual ..... 199
- Settings**
- Factory (on-board computer) ..... 161
- On-board computer ..... 159
- SETUP (on-board computer, Mercedes-AMG vehicles) ..... 162**
- Side impact air bag ..... 45**
- Side marker lamp (display message) ..... 176**
- Side windows**
- Cleaning ..... 235
- Convenience closing feature ..... 74
- Convenience opening feature ..... 74
- Important safety information ..... 73
- Opening/closing ..... 73
- Problem (malfunction) ..... 75
- Resetting ..... 75
- Reversing feature ..... 73
- SIRIUS services**
- see also Digital Operator's Manual ..... 199
- SmartKey**
- Changing the battery ..... 67
- Changing the programming ..... 65
- Checking the battery ..... 67
- Convenience closing feature ..... 74
- Convenience opening feature ..... 74
- Display message ..... 187
- Door central locking/unlocking ..... 64
- Important safety notes ..... 64
- KEYLESS-GO start function ..... 65
- Loss ..... 68
- Mechanical key ..... 66
- Overview ..... 64
- Positions (ignition lock) ..... 102
- Problem (malfunction) ..... 68
- Starting the engine ..... 103
- SMS**
- see also Digital Operator's Manual ..... 199
- Snow chains ..... 254**
- Sockets**
- General notes ..... 213
- Luggage compartment ..... 214
- Sound**
- Switching on/off ..... 200
- Special seat belt retractor ..... 54**
- Specialist workshop ..... 27**
- Speed, controlling**
- see Cruise control
- Speedometer**
- Activating/deactivating the additional speedometer ..... 161
- Digital ..... 153
- Segments ..... 150
- Selecting the display unit ..... 160

- SPORT handling mode**  
 Activating/deactivating ..... 60  
 Warning lamp ..... 193
- Sports exhaust system**  
 see AMG sports exhaust system
- Standing lamps**  
 Display message ..... 176  
 Switching on/off ..... 88
- Start/Stop button**  
 General notes ..... 101  
 Key positions ..... 101  
 Starting the engine ..... 103
- Start/stop function**  
 see ECO start/stop function
- Starting (engine)** ..... 102
- Steering**  
 Display message ..... 187  
 Warning lamps ..... 198
- Steering wheel**  
 Adjusting (electrically) ..... 82  
 Button overview ..... 34  
 Buttons (on-board computer) ..... 151  
 Cleaning ..... 237  
 EASY ENTRY/EXIT feature ..... 82  
 Important safety notes ..... 81  
 Paddle shifters ..... 112  
 Storing settings (memory function) ..... 86
- Steering wheel paddle shifters** ..... 112
- Stopwatch (RACETIMER)** ..... 163
- Stowage areas** ..... 208
- Stowage compartments**  
 Armrest (front) ..... 209  
 Armrest (under) ..... 209  
 Cup holders ..... 211  
 Glove box ..... 209  
 Important safety information ..... 208  
 Stowage net ..... 209
- Stowage net** ..... 209
- Summer tires**  
 In winter ..... 254
- Sun visor** ..... 211
- Suspension setting**  
 AMG adaptive sport suspension system ..... 138
- Suspension tuning**  
 SETUP (on-board computer, Mercedes-AMG vehicles) ..... 162
- Switching air-recirculation mode on/off** ..... 98
- Switching on media mode**  
 Via the device list ..... 207
- T**
- Tachometer** ..... 150
- Tail lamps**  
 Display message ..... 176  
 see Lights
- Tailgate**  
 Display message ..... 186  
 Emergency unlocking ..... 72  
 Important safety notes ..... 71  
 Opening (automatically from inside) ..... 72  
 Opening dimensions ..... 282  
 Opening/closing ..... 71  
 Opening/closing (from outside) ..... 72
- Tank content**  
 Fuel gauge ..... 33
- Technical data**  
 Capacities ..... 277  
 Information ..... 276  
 Tires/wheels ..... 274  
 Vehicle data ..... 282
- Telephone**  
 Accepting a call (multifunction steering wheel) ..... 158  
 Authorizing a mobile phone (connecting) ..... 206  
 Connecting a mobile phone (general information) ..... 205  
 Display message ..... 187  
 Introduction ..... 157  
 Menu (on-board computer) ..... 157  
 Number from the phone book ..... 158  
 Redialing ..... 158  
 Rejecting/ending a call ..... 158  
 see also Digital Operator's Manual ..... 199  
 Switching between mobile phones ..... 206

**Temperature**

|   |     |
|---|-----|
| Coolant (display in the instrument cluster) ..... | 150 |
| Engine oil (on-board computer) .....              | 161 |
| Outside temperature .....                         | 150 |
| Setting (climate control) .....                   | 96  |
| Transmission oil (on-board computer) .....        | 161 |

**Timing (RACETIMER) .....** 163**Tire pressure**

|                                      |     |
|--------------------------------------|-----|
| Calling up (on-board computer) ..... | 258 |
| Checking manually .....              | 257 |
| Display message .....                | 182 |
| Maximum .....                        | 257 |
| Not reached (TIREFIT) .....          | 242 |
| Notes .....                          | 256 |
| Reached (TIREFIT) .....              | 243 |
| Recommended .....                    | 255 |

**Tire pressure monitor**

|   |     |
|---|-----|
| Checking the tire pressure electronically ..... | 259 |
| Function/notes .....                            | 258 |
| General notes .....                             | 258 |
| Important safety notes .....                    | 258 |
| Restarting .....                                | 260 |
| Warning lamp .....                              | 197 |
| Warning message .....                           | 259 |

**Tire-change tool kit .....** 240**TIREFIT kit .....** 241

|                                 |     |
|---------------------------------|-----|
| Important safety notes .....    | 241 |
| Storage location .....          | 240 |
| Tire pressure not reached ..... | 242 |
| Tire pressure reached .....     | 243 |

**Tires**

|  |     |
|--|-----|
| Aspect ratio (definition) .....                            | 269 |
| Average weight of the vehicle occupants (definition) ..... | 268 |
| Bar (definition) .....                                     | 268 |
| Changing a wheel .....                                     | 270 |
| Characteristics .....                                      | 268 |
| Checking .....   | 253 |
| Curb weight (definition) .....                             | 269 |
| Definition of terms .....                                  | 268 |
| Direction of rotation .....                                | 270 |
| Display message .....                                      | 182 |
| Distribution of the vehicle occupants (definition) .....   | 270 |

|   |     |
|---|-----|
| DOT (Department of Transportation) (definition) .....                 | 268 |
| DOT, Tire Identification Number (TIN) .....                           | 267 |
| GAWR (Gross Axle Weight Rating) (definition) .....                    | 268 |
| GVW (Gross Vehicle Weight) (definition) .....                         | 269 |
| GVWR (Gross Vehicle Weight Rating) (definition) .....                 | 269 |
| Important safety notes .....  | 252 |
| Increased vehicle weight due to optional equipment (definition) ..... | 268 |
| Information on driving .....  | 252 |
| Kilopascal (kPa) (definition) .....                                   | 269 |
| Labeling (overview) .....   | 265 |
| Load bearing index (definition) .....                                 | 270 |
| Load index .....  | 267 |
| Load index (definition) .....   | 269 |
| Maximum load on a tire (definition) .....                             | 269 |
| Maximum loaded vehicle weight (definition) .....                      | 269 |
| Maximum permissible tire pressure (definition) .....                  | 269 |
| Maximum tire load .....   | 267 |
| Maximum tire load (definition) .....                                  | 269 |
| Optional equipment weight (definition) .....                          | 270 |
| PSI (pounds per square inch) (definition) .....                       | 269 |
| Replacing .....   | 270 |
| Service life .....  | 253 |
| Sidewall (definition) .....   | 269 |
| Speed rating (definition) .....                                       | 269 |
| Storing .....   | 271 |
| Structure and characteristics (definition) .....                      | 268 |
| Summer tires in winter .....  | 254 |
| Temperature .....   | 264 |
| TIN (Tire Identification Number) (definition) .....                   | 270 |
| Tire bead (definition) .....  | 269 |
| Tire pressure (definition) .....                                      | 269 |
| Tire pressures (recommended) .....                                    | 268 |
| Tire size (data) .....  | 274 |
| Tire size designation, load-bearing capacity, speed rating .....      | 265 |

- Tire tread ..... 253
  - Tire tread (definition) ..... 269
  - Total load limit (definition) ..... 270
  - Traction ..... 264
  - Traction (definition) ..... 270
  - Tread wear ..... 264
  - Uniform Tire Quality Grading Standards ..... 263
  - Uniform Tire Quality Grading Standards (definition) ..... 268
  - Wear indicator (definition) ..... 270
  - Wheel and tire combination ..... 274
  - Wheel rim (definition) ..... 268
  - see Flat tire
  - Touchpad**
    - Changing the station/music track ..... 202
    - Character suggestions ..... 201
    - Deleting characters ..... 201
    - Entering a space ..... 201
    - Entering characters ..... 201
    - Gesture control ..... 201
    - Handwriting recognition ..... 201
    - Operating the touchpad ..... 201
    - Overview ..... 201
    - Quick access for Audio ..... 202
    - Switching ..... 201
    - Switching input line ..... 201
  - Tow-starting**
    - Emergency engine starting ..... 250
  - Towing away**
    - Important safety guidelines ..... 248
    - Installing the towing eye ..... 249
    - Removing the towing eye ..... 249
    - Transporting the vehicle ..... 250
    - With both axles on the ground ..... 249
  - Towing eye** ..... 239
  - Traction control**
    - Activating ..... 137
    - Deactivating ..... 137
    - Display message ..... 186
    - Function/notes ..... 137
    - Important safety notes ..... 137
  - Traffic reports**
    - see also Digital Operator's Manual ..... 199
  - Transmission**
    - Driving tips ..... 111
    - Selector lever ..... 108
    - see Automatic transmission
    - Transmission position display** ..... 110
    - Transmission positions** ..... 110
    - Transporting the vehicle** ..... 250
    - Trim pieces (cleaning instructions)** ..... 237
    - Trip computer (on-board computer)** ..... 153
    - Trip odometer**
      - Calling up ..... 152
      - Resetting (on-board computer) ..... 153
    - Trunk load (maximum)** ..... 282
    - Trunk partition** ..... 210
    - Turn signals**
      - Display message ..... 176
      - Switching on/off ..... 88
    - Two-way radio**
      - Frequencies ..... 276
      - Installation ..... 276
      - Transmission output (maximum) .... 276
    - Type identification plate**
      - see Vehicle identification plate
- U**
- Unlocking**
    - Emergency unlocking ..... 71
    - From inside the vehicle (central unlocking button) ..... 70
  - USB devices**
    - Connecting to the Media Interface ..... 207
- V**
- Vanity mirror (in the sun visor)** ..... 212
  - Vehicle**
    - Correct use ..... 27
    - Data acquisition ..... 28
    - Display message ..... 184
    - Electronics ..... 276
    - Equipment ..... 24
    - Individual settings ..... 159
    - Limited Warranty ..... 28
    - Loading ..... 260
    - Locking (in an emergency) ..... 71
    - Locking (SmartKey) ..... 64



- Lowering ..... 274
  - Maintenance ..... 25
  - Operating safety ..... 26
  - Parking ..... 118
  - Parking for a long period ..... 121
  - Pulling away ..... 103
  - Raising ..... 271
  - Reporting problems ..... 27
  - Securing from rolling away ..... 271
  - Towing away ..... 248
  - Transporting ..... 250
  - Unlocking (in an emergency) ..... 71
  - Unlocking (SmartKey) ..... 64
  - Vehicle data ..... 282
  - Vehicle data**
  - Trunk load (maximum) ..... 282
  - Vehicle dimensions** ..... 282
  - Vehicle emergency locking** ..... 71
  - Vehicle identification number**
  - see VIN
  - Vehicle identification plate** ..... 276
  - Vehicle tool kit** ..... 239
  - Video**
  - Operating the DVD ..... 157
  - see also Digital Operator's Manual ..... 199
  - VIN**
  - Seat ..... 277
  - Type plate ..... 276
- W**
- Warning and indicator lamps**
  - ABS ..... 191
  - Active Brake Assist ..... 196
  - Brakes ..... 190
  - Check Engine ..... 194
  - Coolant ..... 194
  - Distance warning ..... 196
  - ESP® ..... 191
  - ESP® OFF ..... 192
  - Fuel tank ..... 194
  - Overview ..... 33
  - Parking brake ..... 193
  - PASSENGER AIR BAG ..... 39
  - Reserve fuel ..... 194
  - Restraint system ..... 193
  - Seat belt ..... 189
  - SPORT handling mode ..... 193
  - Steering ..... 198
  - Tire pressure monitor ..... 197
  - Warranty** ..... 24
  - Washer fluid**
  - Display message ..... 187
  - Weather display (COMAND)**
  - see also Digital Operator's Manual ..... 199
  - Wheel and tire combinations**
  - Tires ..... 274
  - Wheel bolt tightening torque** ..... 274
  - Wheel chock** ..... 271
  - Wheels**
  - Changing a wheel ..... 270
  - Checking ..... 253
  - Cleaning ..... 235
  - Important safety notes ..... 252
  - Information on driving ..... 252
  - Interchanging/changing ..... 270
  - Mounting a new wheel ..... 273
  - Mounting a wheel ..... 271
  - Removing a wheel ..... 273
  - Storing ..... 271
  - Tightening torque ..... 274
  - Wheel size/tire size ..... 274
  - Window curtain air bag**
  - Display message ..... 173
  - Operation ..... 45
  - Windows**
  - see Side windows
  - Windshield**
  - Defrosting ..... 97
  - Windshield washer fluid**
  - see Windshield washer system
  - Windshield washer system**
  - Adding washer fluid ..... 231
  - Important safety notes ..... 281
  - Windshield wipers**
  - Problem (malfunction) ..... 93
  - Replacing the wiper blades ..... 92
  - Switching on/off ..... 91
  - Winter driving**
  - Important safety notes ..... 254
  - Slippery road surfaces ..... 125
  - Snow chains ..... 254
  - Winter operation**
  - Summer tires ..... 254

**Winter tires**

M+S tires ..... 254

**Wiper blades**

Cleaning ..... 235

Important safety notes ..... 92

Replacing ..... 92

Replacing (windshield) ..... 92

**Workshop**

see Qualified specialist workshop

## Introduction

The printed Operator's Manual provides information about the safe operation of your vehicle. The Digital Operator's Manual provides comprehensive and specifically adapted information on your vehicle's equipment and multimedia system. You can call up the Digital Operator's Manual via the multimedia system.

- i** You will not incur any costs when calling up the Digital Operator's Manual. The Digital Operator's Manual works without connecting to the Internet.

There are three ways to access the topics of the Digital Operator's Manual:

### • Visual search

The visual search allows you to explore your vehicle "virtually". Starting from either the vehicle exterior view or interior view, you can access many of the different topics covered by the Digital Operator's Manual. To access the vehicle interior section, select the "Vehicle interior" view.

### • Keyword search

The keyword search allows you to search for a keyword by entering characters. Further information can be found in the Digital Operator's Manual in the "COMAND" section under the "Character entry (telephony)" keyword.

### • Contents

You can select individual sections in the contents.

- i** The Digital Operator's Manual is deactivated for safety reasons while driving.

## Operation

### Calling up the Digital Operator's Manual

- ▶ Show the main function bar by sliding **↑** the controller up.
- ▶ Select the **Vehicle** menu item by turning **⌂** and pressing **⌂** the controller. The vehicle menu is displayed.

- ▶ Select the **Operator's Manual** menu item by turning **⌂** and pressing **⌂** the controller.
- ▶ Confirm **⌂** the message about the warning and safety notes.  
The basic menu for the Digital Operator's Manual appears.

## Operating the Digital Operator's Manual

### General notes

Please observe the information about the operation of the controller (▶ page 200).

### Content pages

The content pages can be accessed by means of a visual search, a keyword search or using the contents.

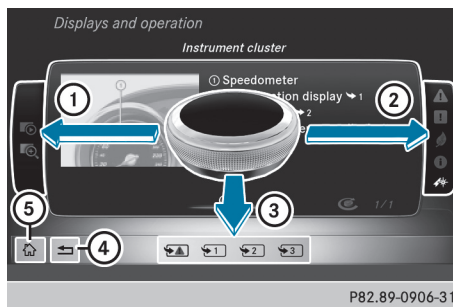

- ▶ **To scroll forwards/backwards:** turn **⌂** the controller.
- ▶ **To display in full-screen or animation:** slide **←** the controller to the left **1**.
- ▶ **To select information texts or save bookmarks:** slide **→** the controller to the right **2**.
- ▶ **To select a link:** slide **⌂** the controller downwards **3**.
- ▶ **To exit a content page:** select **⌂** symbol **4**.
- ▶ **To call up the basic menu of the Digital Operator's Manual:** select **⌂** symbol **5**.
- ▶ **To switch functions to the multimedia system:** select **⌂** symbol **4** repeatedly until you exit the Digital Operator's Manual.

## Protecting the environment

### General notes

#### Environmental note

Daimler's declared policy is one of comprehensive environmental protection.

The objectives are for the natural resources that form the basis of our existence on this planet to be used sparingly and in a manner that takes the requirements of both nature and humanity into account.

You too can help to protect the environment by operating your vehicle in an environmentally responsible manner.

Fuel consumption and the rate of engine, transmission, brake and tire wear are affected by these factors:

- operating conditions of your vehicle
- your personal driving style

You can influence both factors. You should bear the following in mind:

Operating conditions:

- avoid short trips as these increase fuel consumption.
- always make sure that the tire pressures are correct.
- do not carry any unnecessary weight.
- remove roof racks once you no longer need them.
- a regularly serviced vehicle will contribute to environmental protection. You should therefore adhere to the service intervals.
- always have service work carried out at a qualified specialist workshop.

Personal driving style:

- do not depress the accelerator pedal when starting the engine.
- do not warm up the engine when the vehicle is stationary.
- drive carefully and maintain a safe distance from the vehicle in front.
- avoid frequent, sudden acceleration and braking.

- change gear in good time and use each gear only up to  $\frac{2}{3}$  of its maximum engine speed.
- switch off the engine in stationary traffic.
- keep an eye on the vehicle's fuel consumption.

### Environmental concerns and recommendations

Wherever the Operator's Manual requires you to dispose of materials, first try to regenerate or reuse them. Observe the relevant environmental rules and regulations when disposing of materials. In this way you will help to protect the environment.

## Genuine Mercedes-Benz parts

#### Environmental note

Daimler AG also supplies reconditioned major assemblies and parts which are of the same quality as new parts. They are covered by the same Limited Warranty entitlements as new parts.

**!** Air bags and Emergency Tensioning Devices, as well as control units and sensors for these restraint systems, may be installed in the following areas of your vehicle:

- doors
- door pillars
- door sills
- seats
- cockpit
- instrument cluster
- center console

Do not install accessories such as audio systems in these areas. Do not carry out repairs or welding. You could impair the operating efficiency of the restraint systems.

Have aftermarket accessories installed at a qualified specialist workshop.

You could jeopardize the operating safety of your vehicle if you use parts, tires and wheels as well as accessories relevant to safety which have not been approved by Mercedes-Benz. This could lead to malfunctions in safety-relevant

systems, e.g. the brake system. Use only genuine Mercedes-Benz parts or parts of equal quality. Only use tires, wheels and accessories that have been specifically approved for your vehicle.

Genuine Mercedes-Benz parts are subject to strict quality control. Every part has been specifically developed, manufactured or selected for and adapted to Mercedes-Benz vehicles. Therefore, only genuine Mercedes-Benz parts should be used.

More than 300,000 different genuine Mercedes-Benz parts are available for Mercedes-Benz models.

All authorized Mercedes-Benz Centers maintain a supply of genuine Mercedes-Benz parts for necessary service and repair work. In addition, strategically located parts delivery centers provide quick and reliable parts service.

Always specify the vehicle identification number (VIN) when ordering genuine Mercedes-Benz parts (> page 276).

## Operator's Manual

### Vehicle equipment

**i** This Operator's Manual describes all models and all standard and optional equipment of your vehicle available at the time of this Operator's Manual going to print. Country-specific differences are possible. Bear in mind that your vehicle may not feature all functions described here. This also applies to safety-relevant systems and functions. The equipment in your vehicle may therefore differ from that shown in the descriptions and illustrations.

The original purchase agreement lists all systems installed in your vehicle.

Should you have any questions concerning equipment and operation, please consult an authorized Mercedes-Benz Center.

The Operator's Manual and Maintenance Booklet are important documents and should be kept in the vehicle.

## Service and vehicle operation

### Warranty

The Limited Warranty for your vehicle applies in accordance with the warranty terms and conditions in the Service and Warranty Information booklet.

Your authorized Mercedes-Benz Center will replace and repair all factory-installed parts in accordance with the following warranty terms and conditions:

- New Vehicle Limited Warranty
- Emission System Warranty
- Emission Performance Warranty
- California, Connecticut, Maine, Massachusetts, New York, Pennsylvania, Rhode Island and Vermont Emission Control System Warranty
- State warranty enforcement laws (lemon laws)

Replacement parts and accessories are covered by the Mercedes-Benz Parts and Accessories warranties. These are available at any authorized Mercedes-Benz Center.

**i** Should you lose your Service and Warranty Information booklet, have an authorized Mercedes-Benz Center arrange for a replacement. The new Service and Warranty Information booklet will be posted to you.

### Information for customers in California

Under California law you may be entitled to a replacement of your vehicle or a refund of the purchase price or lease price, if after a reasonable number of repair attempts Mercedes-Benz USA, LLC and/or its authorized repair or service facilities fail to fix one or more substantial defects or malfunctions in the vehicle that are covered by its express warranty.

During the period of 18 months from original delivery of the vehicle or the accumulation of 18,000 miles (approximately 29,000 km) on the odometer of the vehicle, whichever occurs first, a reasonable number of repair attempts is presumed for a retail buyer or lessee if one or more of the following occurs:

- (1) the same substantial defect or malfunction results in a condition that is likely to cause

death or serious bodily injury if the vehicle is driven, that defect or malfunction has been subject to repair two or more times, and you have directly notified Mercedes-Benz USA, LLC in writing of the need for its repair.

- (2) the same substantial defect or malfunction of a less serious nature than category (1) has been subject to repair four or more times and you have directly notified Mercedes-Benz in writing of the need for its repair.
- (3) the vehicle is out of service by reason of repair of the same or different substantial defects or malfunctions for a cumulative total of more than 30 calendar days.

Please send your written notice to:  
Mercedes-Benz USA, LLC  
Customer Assistance Center  
One Mercedes Drive  
Montvale, NJ 07645-0350

### Maintenance

#### USA only:

Always have the Service and Warranty Booklet with you when you bring the vehicle to an authorized Mercedes-Benz Center. The service advisor will record every service for you in the Service and Warranty Booklet.

#### Canada only:

Have every service in a qualified specialist workshop confirmed in the service report.

### Roadside Assistance

The Mercedes-Benz Roadside Assistance Program offers technical help in the event of a breakdown. Calls to the toll-free Roadside Assistance Hotline are answered by our agents 24 hours a day, 365 days a year.

**1-800-FOR-MERCEdes (1-800-367-6372)**  
**(USA)**

**1-800-387-0100 (Canada)**

For additional information, refer to the Mercedes-Benz Roadside Assistance Program brochure (USA) or the "Roadside Assistance" section in the Service and Warranty Booklet (Canada). You will find both in the vehicle document wallet.

### Change of address or change of ownership

In the event of a change of address, please send us the "Notification of Address Change" in the Service and Warranty Booklet or simply call the Mercedes-Benz Customer Assistance Center (USA) at the hotline number 1-800-FOR-MERCEdes (1-800-367-6372) or Customer Service Center (Canada) at 1-800-387-0100. This will assist us in contacting you in a timely manner should the need arise. If you sell your Mercedes, please leave all literature in the vehicle so that it is available to the next owner.

If you have purchased a used car, please send us the "Notification of Used Car Purchase" in the Service and Warranty Booklet or simply call the Mercedes-Benz Customer Assistance Center (USA) at the hotline number 1-800-FOR-MERCEdes (1-800-367-6372) or Customer Service (Canada) at 1-800-387-0100.

### Vehicle operation outside the USA and Canada

When you are abroad with your vehicle, observe the following points:

- Service facilities or replacement parts may not be readily available.
- Lead-free fuel for vehicles with a catalytic converter may not be available. Leaded fuel can cause damage to the catalytic converter.
- The fuel may have a considerably lower octane number. Unsuitable fuel can cause engine damage.

Some Mercedes-Benz models are available for delivery in Europe through our European Delivery Program. For details, consult an authorized Mercedes-Benz Center or write to one of the following addresses.

#### In the USA

Mercedes-Benz USA, LLC  
European Delivery Department  
One Mercedes Drive  
Montvale, NJ 07645-0350

#### In Canada

Mercedes-Benz Canada, Inc.  
European Delivery Department  
98 Vanderhoof Avenue  
Toronto, Ontario M4G 4C9

## Operating safety

### Important safety notes

#### WARNING

If you do not have the prescribed service/maintenance work or any required repairs carried out, this can result in malfunctions or system failures. There is a risk of an accident.

Always have the prescribed service/maintenance work as well as any required repairs carried out at a qualified specialist workshop.

#### WARNING

Flammable material such as leaves, grass or twigs may ignite if they come into contact with hot parts of the exhaust system. There is a risk of fire.

When driving off road or on unpaved roads, check the vehicle's underside regularly. In particular, remove parts of plants or other flammable materials which have become trapped. In the case of damage, contact a qualified specialist workshop.

#### WARNING

Modifications to electronic components, their software as well as wiring can impair their function and/or the function of other networked components. In particular, systems relevant to safety could also be affected. As a result, these may no longer function as intended and/or jeopardize the operating safety of the vehicle. There is an increased risk of an accident and injury.

Never tamper with the wiring as well as electronic components or their software. You should have all work to electrical and electronic equipment carried out at a qualified specialist workshop.

 There is a risk of damage to the vehicle if:

- the vehicle becomes stuck, e.g. on a high curb or an unpaved road
- you drive too fast over an obstacle, e.g. a curb, a speed bump or a pothole in the road
- a heavy object strikes the underbody or parts of the chassis

In situations like this, the body, the underbody, chassis parts, wheels or tires could be damaged without the damage being visible. Components damaged in this way can unexpectedly fail or, in the case of an accident, no longer withstand the loads they are designed to.

If the underbody paneling is damaged, combustible materials such as leaves, grass or twigs can gather between the underbody and the underbody paneling. If these materials come in contact with hot parts of the exhaust system, they can catch fire.

In such situations, have the vehicle checked and repaired immediately at a qualified specialist workshop. If on continuing your journey you notice that driving safety is impaired, pull over and stop the vehicle immediately, paying attention to road and traffic conditions. In such cases, consult a qualified specialist workshop.

## Declarations of conformity

### Vehicle components which receive and/or transmit radio waves

**USA:** "The wireless devices of this vehicle comply with Part 15 of the FCC Rules. Operation is subject to the following two conditions: 1) These devices may not cause harmful interference, and 2) These devices must accept any interference received, including interference that may cause undesired operation. Changes or modifications not expressly approved by the party responsible for compliance could void the user's authority to operate the equipment."

**Canada:** "The wireless devices of this vehicle comply with Industry Canada license-exempt RSS standard(s). Operation is subject to the following two conditions: (1) These devices may not cause interference, and (2) These devices must accept any interference, including interference that may cause undesired operation of the device."



### Diagnostics connection

The diagnostics connection is only intended for the connection of diagnostic equipment at a qualified specialist workshop.

#### WARNING

If you connect equipment to a diagnostics connection in the vehicle, it may affect the operation of vehicle systems. As a result, the operating safety of the vehicle could be affected. There is a risk of an accident.

Only connect equipment to a diagnostics connection in the vehicle, which is approved for your vehicle by Mercedes-Benz.

#### WARNING

Objects in the driver's footwell can restrict the pedal travel or obstruct a depressed pedal. The operating and road safety of the vehicle is jeopardized. There is a risk of an accident.

Make sure that all objects in the vehicle are stowed correctly, and that they cannot enter the driver's footwell. Install the floor mats securely and as specified in order to ensure sufficient clearance for the pedals. Do not use loose floor mats and do not place floor mats on top of one another.

**!** If the engine is switched off and equipment on the diagnostics connection is used, the starter battery may discharge.

Connecting equipment to the diagnostics connection can lead to emissions monitoring information being reset, for example. This may lead to the vehicle failing to meet the requirements of the next emissions test during the main inspection.

### Qualified specialist workshop

An authorized Mercedes-Benz Center is a qualified specialist workshop. It has the necessary specialist knowledge, tools and qualifications to correctly carry out the work required on your vehicle. This is especially the case for work relevant to safety.

Always have the following work carried out at an authorized Mercedes-Benz Center:

- work relevant to safety
- service and maintenance work
- repair work
- alterations, installation work and modifications
- work on electronic components

### Correct use

If you remove any warning stickers, you or others could fail to recognize certain dangers. Leave warning stickers in position.

Observe the following information when driving your vehicle:

- the safety notes in this manual
- the vehicle technical data
- traffic rules and regulations
- laws and safety standards pertaining to motor vehicles

### Problems with your vehicle

If you should experience a problem with your vehicle, particularly one that you believe may affect its safe operation, we urge you to contact an authorized Mercedes-Benz Center immediately to have the problem diagnosed and rectified. If the problem is not resolved to your satisfaction, please discuss the problem again with the authorized Mercedes-Benz Center or, if necessary, contact us at one of the following addresses.

#### In the USA

Customer Assistance Center  
Mercedes-Benz USA, LLC  
One Mercedes Drive  
Montvale, NJ 07645-0350

#### In Canada

Customer Relations Department  
Mercedes-Benz Canada, Inc.  
98 Vanderhoof Avenue  
Toronto, Ontario M4G 4C9

### Reporting safety defects

USA only:

The following text is published as required of manufacturers under Title 49, Code of U.S. Federal Regulations, Part 575 pursuant to the "National Traffic and Motor Vehicle Safety Act of 1966".

If you believe that your vehicle has a defect which could cause a crash or could cause injury or death, you should immediately inform the National Highway Traffic Safety Administration (NHTSA) in addition to notifying Mercedes-Benz USA, LLC.

If NHTSA receives similar complaints, it may open an investigation, and if it finds that a safety defect exists in a group of vehicles, it may order a recall and remedy campaign. However, NHTSA cannot become involved in individual problems between you, your dealer, or Mercedes-Benz USA, LLC.

To contact NHTSA, you may call the Vehicle Safety Hotline toll-free at 1-888-327-4236 (TTY: 1-800-424-9153); go to <http://www.safercar.gov>; or write to: Administrator, NHTSA, 400 Seventh Street, SW., Washington, DC 20590.

You can also obtain other information about motor vehicle safety at:

<http://www.safercar.gov>

### Limited Warranty

**!** Follow the instructions in this manual about the proper operation of your vehicle as well as about possible vehicle damage. Damage to your vehicle that arises from culpable contraventions against these instructions is not covered either by the Mercedes-Benz Limited Warranty or by the New or Used-Vehicle Warranty.

### QR codes for the rescue card

The QR codes are secured in the fuel filler flap and on the opposite side on the B-pillar. In the event of an accident, rescue services can use the QR code to quickly find the appropriate rescue card for your vehicle. The current rescue card contains the most important information about your vehicle in a compact form, e.g. the routing of the electric cables.

You can find more information under [www.mercedes-benz.de/qr-code](http://www.mercedes-benz.de/qr-code).

## Data stored in the vehicle

### Data storage

A wide range of electronic components in your vehicle contain data memories.

These data memories temporarily or permanently store technical information about:

- the vehicle's operating state
- incidents
- malfunctions

In general, this technical information documents the state of a component, a module, a system or the surroundings.

These include, for example:

- operating conditions of system components, e.g. fluid levels
- the vehicle's status messages and those of its individual components, e.g. number of wheel revolutions/speed, deceleration in movement, lateral acceleration, accelerator pedal position
- malfunctions and defects in important system components, e.g. lights, brakes
- vehicle reactions and operating conditions in special driving situations, e.g. air bag deployment, intervention of stability control systems
- ambient conditions, e.g. outside temperature

This data is of an exclusively technical nature and can be used to:

- assist in recognizing and rectifying malfunctions and defects
- analyze vehicle functions, e.g. after an accident
- optimize vehicle functions

The data cannot be used to trace the vehicle's movements.

When your vehicle is serviced, technical information can be read from the event data memory and malfunction data memory.

Services include, for example:

- repair services
- service processes
- warranties
- quality assurance

The vehicle is read out by employees of the service network (including the manufacturer) using special diagnostic testers. More detailed information is obtained from it, if required.

After a malfunction has been rectified, the information is deleted from the malfunction memory or is continually overwritten.

When operating the vehicle, situations are conceivable in which this technical data, in connection with other information (if necessary, under consultation with an authorized expert), could be traced to a person.

Examples include:

- accident reports
- damage to the vehicle
- witness statements

Further additional functions that have been contractually agreed upon with the customer allow certain vehicle data to be conveyed by the vehicle as well. The additional functions include, for example, vehicle location in case of an emergency.

### COMAND/mbrace

If the vehicle is equipped with COMAND or mbrace, additional data about the vehicle's operation, the use of the vehicle in certain situations, and the location of the vehicle may be compiled through COMAND or the mbrace system.

For additional information please refer to the COMAND User Manual or the Digital Operator's Manual and/or the mbrace Terms and Conditions.

### Event data recorders

This vehicle is equipped with an event data recorder (EDR). This vehicle is equipped with an event data recorder (EDR). The main purpose of an EDR is to record, in certain crash or near crash-like situations, such as an air bag deployment or hitting a road obstacle, data that will assist in understanding how a vehicle's systems performed. The EDR is designed to record data related to vehicle dynamics and safety systems for a short period of time, typically 30 seconds or less.

The EDR in this vehicle is designed to record such data as:

- How various systems in your vehicle were operating
- Whether or not the driver and passenger safety belts were buckled/fastened

- How far (if at all) the driver was depressing the accelerator and/or brake pedal and
- How fast the vehicle was traveling.

These data can help provide a better understanding of the circumstances in which crashes and injuries occur. NOTE: EDR data are recorded by your vehicle only if a non-trivial crash situation occurs; no data are recorded by the EDR under normal driving conditions and no personal data (e.g. name, gender, age and crash location) are recorded. However, other parties, such as law enforcement could combine the EDR data with the type of personally identifying data routinely acquired during a crash investigation.

Access to the vehicle and/or the EDR is needed to read data that is recorded by an EDR, and special equipment is required. In addition to the vehicle manufacturer, other parties that have the special equipment, such as law enforcement, can read the information by accessing the vehicle or the EDR.

EDR data may be used in civil and criminal matters as a tool in accident reconstruction, accident claims and vehicle safety. Since the Crash Data Retrieval CDR tool that is used to extract data from the EDR is commercially available, Mercedes-Benz USA, LLC ("MBUSA") expressly disclaims any and all liability arising from the extraction of this information by unauthorized Mercedes-Benz personnel.

MBUSA will not share EDR data with others without the consent of the vehicle owners or, if the vehicle is leased, without the consent of the lessee. Exceptions to this representation include responses to subpoenas by law enforcement; by federal, state or local government; in connection with or arising out of litigation involving MBUSA or its subsidiaries and affiliates; or, as required by law.

Warning: The EDR is a component of the Restraint System Module. Tampering with, altering, modifying or removing the EDR component may result in a malfunction of the Restraint System Module and other systems.

State laws or regulations regarding EDRs that conflict with federal regulation are pre-empted. This means that in the event of such conflict, the federal regulation governs. As of February 2013, 13 states have enacted laws relating to EDRs.

## Mercedes me website

### General information

#### WARNING

If you operate information systems and communication equipment integrated in the vehicle when driving, you may be distracted from the traffic situation. You could also lose control of the vehicle. There is a risk of an accident.

Only operate this equipment when the traffic situation permits. If you are not sure that this is possible, park the vehicle paying attention to traffic conditions and operate the equipment when the vehicle is stationary.

Mercedes me connect services may be limited to certain countries and certain devices. Daimler AG can restrict or discontinue the service.

The remote online services of Mercedes me connect:

- are not intended for use in the vehicle. These services must not be used while the vehicle is in motion.
- may contain data which is out of date or invalid. The displays in the vehicle apply at all times.

The remote online services and selected basic services can be used via the website <https://www.mercedes.me> or via the web application for your smartphone. They can be called up using many Internet-enabled end devices.

You must observe the legal requirements for the country in which you are currently driving when calling up the website via the multimedia system. Do not use the website while the vehicle is in motion.

### Notes on data protection

#### WARNING

The use of remote control functions can lead to security risks.

Remote control functions include, for example:

- Locking/unlocking the vehicle
- Activating auxiliary heating

A security risk could occur, for example by the activation of the auxiliary heating at an unsuitable location for the vehicle.

An unauthorized person with knowledge of your access data could take control of vehicle behavior and/or individual vehicle functions.

Take great care to protect your access data from unauthorized access.

Change your access data immediately if you suspect unauthorized access has taken place or that your access data has been compromised. In addition, consult an authorized Mercedes-Benz Center immediately.

Any person who has access to your access data can use the Mercedes me connect services.

### Change of vehicle

If you sell your vehicle, you are obliged to delete the vehicle from your personal area on the Mercedes me website.

If you have bought a used vehicle, it is possible that the previous owner still has access to the Mercedes me connect services. Daimler AG or Mercedes me connect are not automatically informed about the change of owner.

For as long as the previous owner has a connection with the vehicle, they can use all of the Mercedes me connect services.

For example:

- locating the vehicle
- remotely operated vehicle functions  
e.g. locking and unlocking the vehicle

Active vehicle location is shown in the multimedia system display.

If in doubt, deactivate the function:

- on the Mercedes me connect website by switching off the function in the settings.
- via the Mercedes-Benz Customer Center. You can call up the Mercedes-Benz Customer Center by pressing the  button in the

overhead control unit. Have access for the previous owner deactivated.

### Information on copyright

#### Free and open-source software

Information on license for free and open-source software used in your vehicle can be found on the data carrier in your vehicle document wallet and, including updates, on the following website:

<http://www.mercedes-benz.com/opensource>

## Cockpit

At a glance

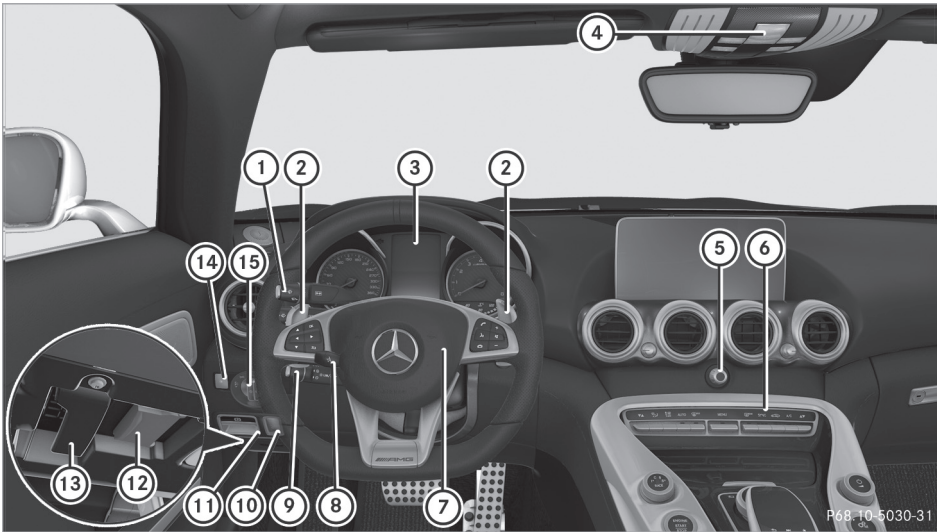

|   | Function                                | Page |
|---|---|------|
| ① | Combination switch                      | 88   |
| ② | Steering wheel paddle shifters          | 112  |
| ③ | Instrument cluster                      | 33   |
| ④ | Overhead control panel                  | 36   |
| ⑤ | Sets the traction control               | 137  |
| ⑥ | Climate control systems                 | 95   |
| ⑦ | Horn                                    |      |
| ⑧ | Adjusts the steering wheel electrically | 82   |

|   | Function               | Page |
|---|------------------------|------|
| ⑨ | Cruise control lever   | 125  |
| ⑩ | Unlocks the tailgate   | 72   |
| ⑪ | Electric parking brake | 120  |
| ⑫ | Diagnostics connection | 27   |
| ⑬ | Opens the hood         | 226  |
| ⑭ | Rear fog lamp          | 88   |
| ⑮ | Light switch           | 87   |

Instrument cluster

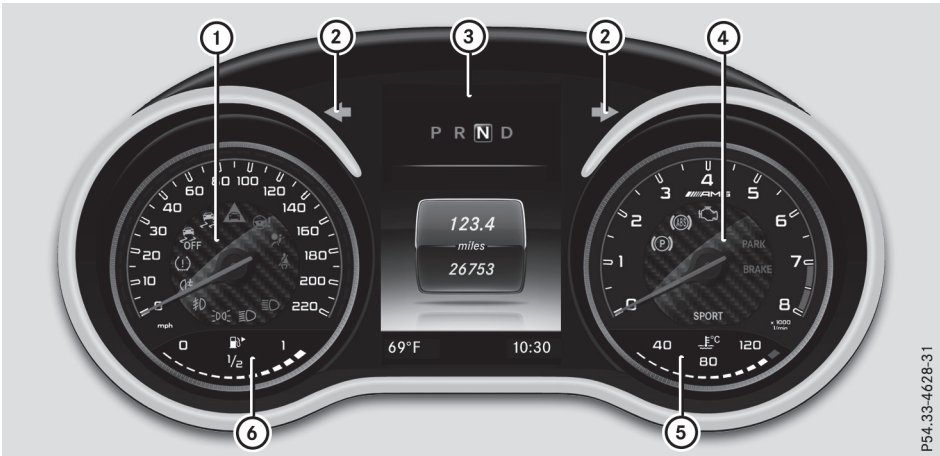

At a glance

P54.33-4628-31

|   | Function   | Page  |
|---|--|---|
| ① | Speedometer<br>Speedometer segments<br>Warning and indicator lamps:<br>Tire pressure monitor<br>ESP® OFF<br>ESP®<br>Distance warning<br>Power steering<br>Restraint system<br>Seat belts<br>High-beam headlamps<br>Low-beam headlamps<br>Parking lamps<br>This lamp has no function<br>Rear fog lamp | 150<br>197<br>191<br>191<br>196<br>198<br>39<br>189<br>88<br>88<br>88 |
| ② | Turn signals   | 88  |
| ③ | Multifunction display  | 152   |
| ④ | Tachometer   | 150   |

|   | Function  | Page  |
|---|---|---|
|   | Warning and indicator lamps:<br>Electric parking brake (yellow)<br>ABS<br>Check Engine<br>Electric parking brake (red)<br>USA only<br>Canada only<br>Brakes (red)<br>USA only<br>Canada only<br>SPORT handling mode | 193<br>191<br>194<br>193<br>190<br>190<br>193 |
| ⑤ | Coolant temperature display<br>Warning and indicator lamps:<br>Coolant  | 150<br>194                                    |
| ⑥ | Fuel level indicator<br>Warning and indicator lamps:<br>Reserve fuel level with fuel filler flap location indicator (right)   | 194   |

**i** Information on the display of the outside temperature in the multifunction display can be found under "Outside temperature display" (> page 150).

Adjusting the instrument cluster lighting using the on-board computer (> page 160).



## Multifunction steering wheel

At a glance

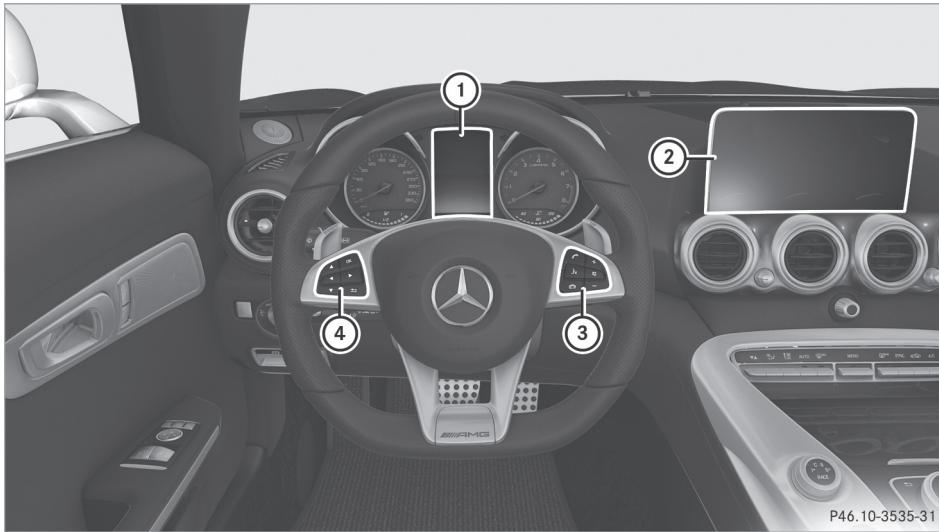

P46.10-3535-31

|   | Function   | Page |
|---|--|------|
| ① | Multifunction display  | 152  |
| ② | Multimedia system display  |      |
| ③ | Rejects or ends a call<br>Makes or accepts a call<br>Further telephone functions<br>Adjusts volume<br>Mute<br>Switches on the Voice Control System | 157  |

|   | Function   | Page |
|---|--|------|
| ④ | Opens the menu list<br>Selects a menu<br>Confirms the selection<br>Back<br>Operates the on-board computer<br>Switches off the Voice Control System | 151  |

**i** In vehicles with multimedia system COMAND you can find further information:

- on the multimedia system in the Digital Operator's Manual
- on the Voice Control System in the separate operating instructions

## Center console

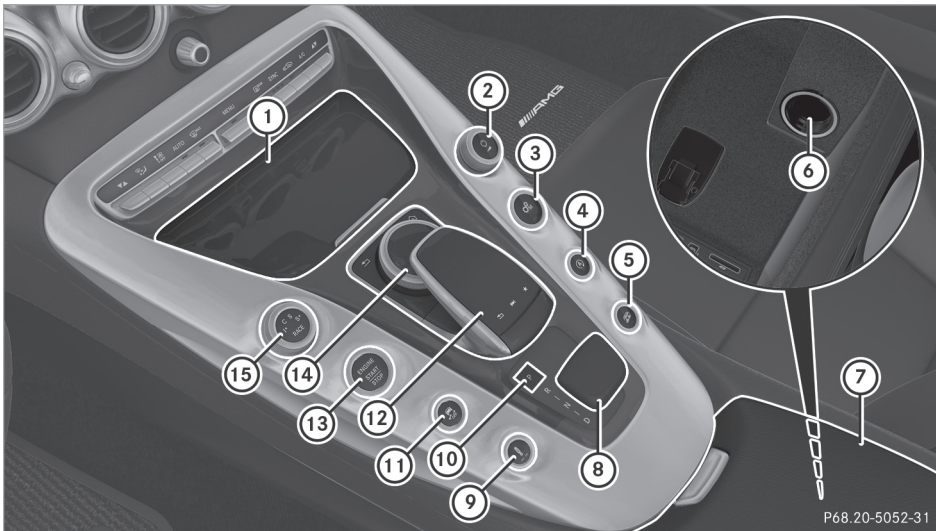

P68.20-5052-31

At a glance

|   | Function  | Page |   | Function                    | Page   |                              |                            |   |
|---|---|------|---|-----------------------------|--|------------------------------|----------------------------|---|
| ① | Stowage compartment   | 209  | ⑧                                       | AMG E-SELECT selector lever | 108  |                              |                            |   |
|   | 12 V socket   | 213  |   | ⑨                           | Adjusts AMG adaptive sport suspension system | 138                          |                            |   |
|   | Cigarette lighter   | 213  |   |                             | ⑩  | Button for position <b>P</b> | 108                        |   |
|   | Ashtray   | 212  |   |                             |  | ⑪                            | Activates/deactivates ESP® | 60  |
|   |   |      |   |                             |  |                              | ⑫                          | Activates/deactivates SPORT handling mode                   |
|   |   | ⑬    | Touchpad; see Digital Operator's Manual |                             |  |                              |                            |   |
| ② | Switches the multimedia system on/off (see the Digital Operator's Manual) |      |   | ⑭                           |  |                              |                            | Start/Stop button   |
| ③ | M button (activates manual mode)  |      | 112                                     |                             | ⑮  |                              |                            | Multimedia system controller; see Digital Operator's Manual |
| ④ | <b>A</b> ECO button (start/stop function) incl. indicator lamp            |      | 105                                     |                             |  | ⑮                            |                            | Selects the drive program (DYNAMIC SELECT controller)       |
| ⑤ | Adjusts the exhaust flap of the AMG sports exhaust system                 |      | 105                                     |                             |  |                              |                            |   |
| ⑥ | Ignition lock (in the stowage compartment)                                | 102  |   |                             |  |                              |                            |   |
| ⑦ | Stowage compartment   | 209  |   |                             |  |                              |                            |   |

## Overhead control panel

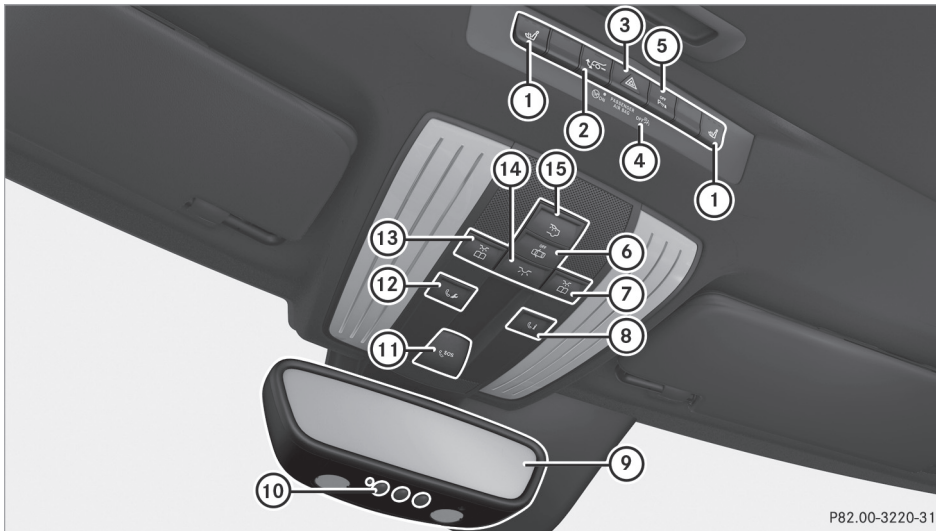

P82.00-3220-31

|   | Function  | Page     |
|---|---|----------|
| ① | Seat heating  | 80       |
| ② | Active aerodynamics profile                             | 221      |
| ③ | Hazard warning lamps                                    | 89       |
| ④ | PASSENGER AIRBAG indicator lamps<br>ATA indicator lamp  | 39<br>62 |
| ⑤ | Parking Assist<br>PARKTRONIC                            | 138      |
| ⑥ | Switches the automatic interior lighting control on/off | 90       |
| ⑦ | Switches the right-hand reading lamp on/off             | 90       |
| ⑧ | Info call button (mbrace system)                        | 216      |





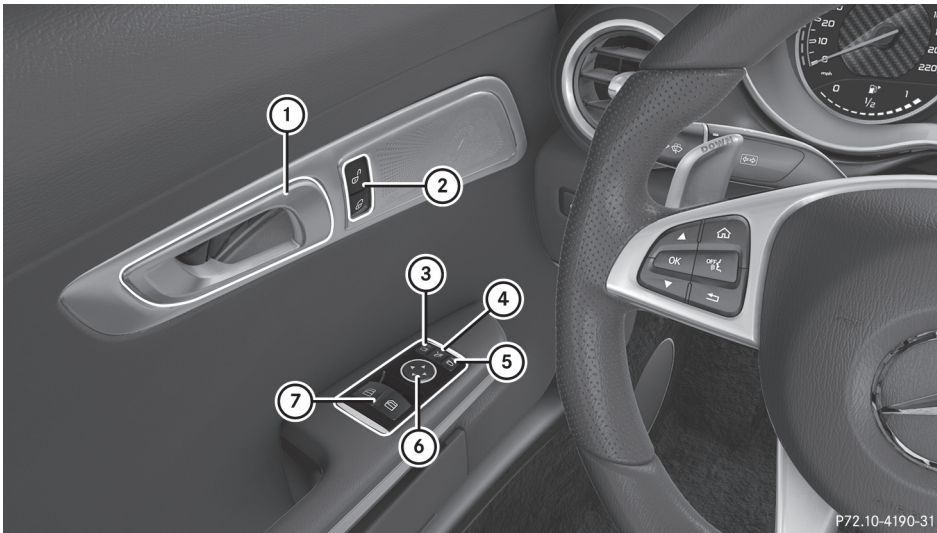

|   | Function   | Page |
|---|--|------|
| ⑨ | Rear-view mirror                                 | 84   |
| ⑩ | Transmitter buttons for the garage door opener   | 223  |
| ⑪ | SOS button (mbrace system)                       | 215  |
| ⑫ | Breakdown assistance call button (mbrace system) | 216  |
| ⑬ | Switches the left-hand reading lamp on/off       | 90   |
| ⑭ | Switches the interior lighting on/off            |      |
| ⑮ | Switches the cargo compartment lamp on/off       | 90   |

Door control panel



P72.10-4190-31

At a glance

|   | Function  | Page |   | Function  | Page |
|---|---|------|---|---|------|
| ① | Opens the door  | 70   | ⑤ |  Selects the right exterior mirror | 83   |
| ② |   Locks/unlocks the vehicle | 70   | ⑥ |  Adjusts the exterior mirrors      | 83   |
| ③ |  Selects the left exterior mirror   | 83   | ⑦ |  Opens/closes the side windows    | 73   |
| ④ |  Folds the exterior mirrors in/out electrically  | 84   |   |   |      |

### Panic alarm

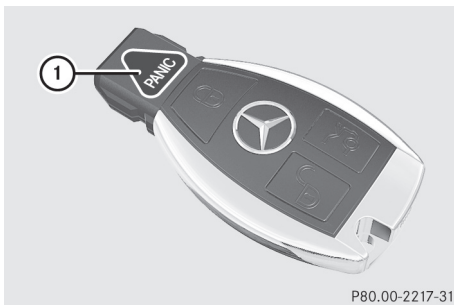

P80.00-2217-31

- ▶ **To activate:** press **PANIC** button ① for at least one second.  
A visual and audible alarm is triggered if the alarm system is armed.
- ▶ **To deactivate:** press **PANIC** button ① again.  
or
- ▶ Press the Start/Stop button.  
The SmartKey must be in the vehicle.  
or
- ▶ Insert the SmartKey into the ignition lock.

### Occupant safety

#### Introduction to the restraint system

The restraint system can reduce the risk of vehicle occupants coming into contact with parts of the vehicle's interior in the event of an accident. The restraint system can also reduce the forces to which vehicle occupants are subjected during an accident.

The restraint system comprises:

- Seat belt system
- Air bags

The components of the restraint system work in conjunction with each other. They can only deploy their protective function if, at all times, all vehicle occupants:

- have fastened their seat belts correctly (▷ page 41)
- have the seat adjusted properly (▷ page 77)

Depending on the vehicle's equipment, the head restraints must also be adjusted properly.

As the driver, you also have to make sure that the steering wheel is adjusted correctly. Observe the information relating to the correct driver's seat position (▷ page 77).

You also have to make sure that an air bag can inflate properly if deployed (▷ page 43).

An air bag supplements a correctly worn seat belt. As an additional safety device, the air bag increases the level of protection for vehicle occupants in the event of an accident. For example, if, in the event of an accident, the protection offered by the seat belt is sufficient, the air bags are not deployed. When an accident occurs, only the air bags that increase protection in that particular accident situation are deployed. However, seat belts and air bags generally do not protect against objects penetrating the vehicle from the outside.

Information on restraint system operation can be found under "Triggering of the Emergency Tensioning Devices and air bags" (▷ page 50).

See "Children in the vehicle" for information on children traveling with you in the vehicle as well as on child restraint systems (▷ page 53).

#### Important safety notes

##### WARNING

Modifications to the restraint system may cause it to no longer work as intended. The restraint system may then not perform its intended protective function and may fail in an accident or trigger unexpectedly, for example. This poses an increased risk of injury or even fatal injury.

Never modify parts of the restraint system.  
Never tamper with the wiring, the electronic components or their software.

If it is necessary to modify components of the restraint system to accommodate a person with disabilities, contact an authorized Mercedes-Benz Center for details. USA only: for further information contact our Customer Assistance Center at 1-800-FOR-MERCEDES (1-800-367-6372).

Mercedes-Benz recommends that you only use driving aids which have been approved specifically for your vehicle by Mercedes-Benz.

### Restraint system warning lamp

The functions of the restraint system are checked after the ignition is switched on and at regular intervals while the engine is running. Therefore, malfunctions can be detected in good time.

The  restraint system warning lamp on the instrument cluster lights up when the ignition is switched on. It goes out no later than a few seconds after the vehicle is started. The components of the restraint system are in operational readiness.

A malfunction has occurred if the  restraint system warning lamp:

- does not light up after the ignition is switched on
- does not go out after a few seconds with the engine running
- lights up again while the engine is running



#### WARNING

If the restraint system is malfunctioning, restraint system components may be triggered unintentionally or may not deploy as intended during an accident. This can affect for example the Emergency Tensioning Device or the air bag. This poses an increased risk of injury or even fatal injury.

Have the restraint system checked and repaired in a qualified specialist workshop as soon as possible.

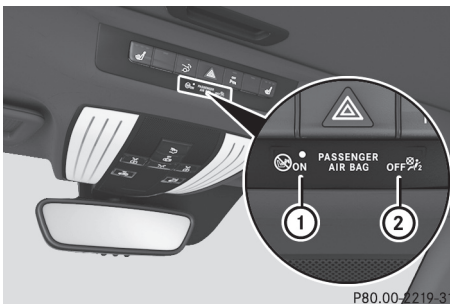
### PASSENGER AIR BAG indicator lamp



PASSENGER AIR BAG ON indicator lamp  and PASSENGER AIR BAG OFF indicator lamp  are part of the Occupant Classification System (OCS).

The indicator lamps display the status of the front-passenger front air bag.

- PASSENGER AIR BAG ON lights up for 60 seconds, subsequently both indicator lamps are off (PASSENGER AIR BAG ON and OFF): the front-passenger front air bag is able to deploy in the event of an accident.
- PASSENGER AIR BAG OFF lights up: the front-passenger front air bag is deactivated. It will then not be deployed in the event of an accident.

If the PASSENGER AIR BAG ON indicator lamp is off, only the PASSENGER AIR BAG OFF indicator lamp shows the status of the front-passenger front air bag. The PASSENGER AIR BAG OFF indicator lamp may be lit continuously or be off. Depending on the person in the front-passenger seat, the front-passenger front air bag must either be deactivated or enabled; see the following points. You must make sure of this both before and during a journey.

- **Children in a child restraint system:** whether the front-passenger front air bag is enabled or deactivated depends on the installed child restraint system, and the age and size of the child. Therefore, be sure to observe the notes on the "Occupant Classification System (OCS)" ([▷ page 46](#)) and on "Children in the vehicle" ([▷ page 53](#)). There you will also find instructions on rearward and forward-facing child restraint systems on the front-passenger seat.
- **All other persons:** depending on the classification of the person in the front-passenger seat, the front-passenger front air bag is enabled or deactivated ([▷ page 46](#)). Be sure to observe the notes on "Seat belts" ([▷ page 39](#)) and "Air bags" ([▷ page 43](#)). There you can also find information on the correct seat position.

### Seat belts

#### Introduction

Seat belts are the most effective means of restricting the movement of vehicle occupants in the event of an accident or the vehicle rolling over. This reduces the risk of vehicle occupants coming into contact with parts of the vehicle interior or being ejected from the vehicle. Furthermore, the seat belt helps to keep the vehicle



occupant in the best position in relation to the air bag.

The seat belt system comprises:

- Seat belts
- Emergency Tensioning Devices and seat belt force limiters

If the seat belt is pulled quickly or sharply by the seat belt guide, the inertia reel locks. The belt strap cannot be extracted any further.

The Emergency Tensioning Device tightens the seat belt in an accident, pulling the belt close against the body. However it does not pull the vehicle occupant back in the direction of the backrest.

The Emergency Tensioning Device does not correct an incorrect seat position or the routing of an incorrectly fastened seat belt.

When triggered, a seat belt force limiter helps to reduce the force exerted by the seat belt on the vehicle occupant.

The seat belt force limiters are synchronized with the front air bags which absorb part of the deceleration force. This can reduce the force exerted on the vehicle occupants during an accident.

- ❗ If the front-passenger seat is not occupied, do not engage the seat belt tongue in the buckle on the front-passenger seat. Otherwise, the Emergency Tensioning Device and side impact air bag could be triggered in the event of an accident and would need to be replaced.

### Important safety notes

The use of seat belts and child restraint systems is required by law in:

- all 50 states
- the U.S. territories
- the District of Columbia
- all Canadian provinces

Even where this is not required by law, all vehicle occupants should correctly fasten their seat belts before starting the journey.

#### WARNING

If the seat belt is not worn correctly, it cannot perform its intended protective function. An incorrectly fastened seat belt can also cause injuries, for example, in the event of an acci-

dent or when braking or changing direction abruptly. This poses an increased risk of injury or even fatal injury.

Always ensure that all vehicle occupants have their seat belts fastened correctly and are sitting properly.

The components of the restraint system work in conjunction with each other. They can only deploy their protective function if, at all times, all vehicle occupants:

- have fastened their seat belts correctly (▷ page 41)
- have the seat adjusted properly (▷ page 77)

Depending on the vehicle's equipment, the head restraints must also be adjusted properly.

#### WARNING

The seat belt does not offer the intended level of protection if you have not moved the backrest to an almost vertical position. When braking or in the event of an accident, you could slide underneath the seat belt and sustain abdomen or neck injuries, for example. This poses an increased risk of injury or even fatal injury.

Adjust the seat properly before beginning your journey. Always ensure that the backrest is in an almost vertical position and that the shoulder section of your seat belt is routed across the center of your shoulder.

#### WARNING

Persons less than 5 ft (1.50 m) tall cannot wear the seat belt correctly without an additional and suitable restraint system. If the seat belt is not worn correctly, it cannot perform its intended protective function. An incorrectly fastened seat belt can also cause injuries, for example, in the event of an accident or when braking or changing direction abruptly. This poses an increased risk of injury or even fatal injury.

For this reason, always secure persons under 5 ft (1.50 m) tall in suitable additional restraint systems.



If a child younger than twelve years old and under 5 ft (1.50 m) in height is traveling in the vehicle:

- always secure the child in a child restraint system suitable for this Mercedes-Benz vehicle. The child restraint system must be appropriate to the age, weight and size of the child
- always observe the instructions and safety notes on "Children in the vehicle" (▷ page 53) in addition to the child restraint system manufacturer's installation and operating instructions
- always observe the instructions and safety notes on the "Occupant classification system (OCS)" (▷ page 46)

#### WARNING

The seat belts may not perform their intended protective function if:

- they are damaged, modified, extremely dirty, bleached or dyed
- the seat belt buckle is damaged or extremely dirty
- the Emergency Tensioning Devices, belt anchorages or inertia reels have been modified.

Seat belts may be damaged in an accident, although the damage may not be visible, e.g. due to splinters of glass. Modified or damaged seat belts may tear or fail, e.g. in an accident. Modified Emergency Tensioning Devices could accidentally trigger or fail to deploy when necessary. This poses an increased risk of injury or even fatal injury.

Never modify the seat belts, Emergency Tensioning Devices, belt anchorages and inertia reels. Make sure that the seat belts are undamaged, not worn out and clean. Following an accident, have the seat belts checked immediately at a qualified specialist workshop.

Only use seat belts that have been approved for your vehicle by Mercedes-Benz.

**AMG Performance seat:** this seat is designed for the standard three-point seat belt. If you install another multi-point seat belt, e.g. sport or racing seat belts, the restraint system cannot provide the best level of protection.

#### WARNING

If you feed seat belts through the opening in the seat backrest, the seat backrest may be damaged or may even break in the event of an accident. This poses an increased risk of injury or even fatal injury.

Only use the standard three-point seat belt. Never modify the seat belt system.

#### Vehicles with the AMG Club Sport package:

- Only use the standard three-point seat belt on public roads.
- If you are not driving on public roads and you install the provided four-point seat belt, always observe the installation and operating instructions of the sport or racing seat belt manufacturer.

In this case, only install the provided four-point seat belt.

- Always have the standard three-point seat belt or the provided four-point seat belt installed at a qualified specialist workshop. Mercedes-Benz recommends that you use an authorized Mercedes-Benz Center for this purpose.

#### Proper use of the seat belts

Observe the safety notes on the seat belt (▷ page 40).

All vehicle occupants must be wearing the seat belt correctly before beginning the journey. Also make sure that all vehicle occupants are always wearing the seat belt correctly while the vehicle is in motion.

When fastening the seat belt, always make sure that:

- the seat belt buckle tongue is inserted only into the belt buckle belonging to that seat
  - the seat belt is pulled tight across your body. Avoid wearing bulky clothing, e.g. a winter coat.
  - the seat belt is not twisted
- Only then can the forces which occur be distributed over the area of the belt.
- the shoulder section of the belt is routed across the center of your shoulder

The shoulder section of the seat belt should not touch your neck or be routed under your arm or behind your back.

- the lap belt is taut and passes across your lap as low down as possible

The lap belt must always be routed across your hip joints and not across your abdomen. This applies particularly to pregnant women. If necessary, push the lap belt down to your hip joint and pull it tight using the shoulder section of the belt.

- the seat belt is not routed across sharp, pointed or fragile objects  
If you have such items located on or in your clothing, e.g. pens, keys or eyeglasses, store these in a suitable place.

- only one person is using a seat belt  
Infants and children must never travel sitting on the lap of a vehicle occupant. In the event of an accident, they could be crushed between the vehicle occupant and seat belt.

- objects are never secured with a seat belt if the seat belt is also being used by one of the vehicle's occupants

Also ensure that there are never objects between a person and the seat, e.g. cushions.

Seat belts are only intended to secure and restrain vehicle occupants. Always observe the "Loading guidelines" for securing objects, luggage or loads (> page 208).

### Fastening seat belts

Observe the safety notes on the seat belt (> page 40) and the notes on correct use of seat belts (> page 41).



Basic illustration

- ▶ Adjust the seat (> page 77).  
The seat backrest must be in an almost upright position.
- ▶ Pull the seat belt smoothly out of seat belt guide (3) and engage belt tongue (2) into belt buckle (1).  
The seat belt on the driver's seat and the front-passenger seat may be tightened automatically, see "Belt adjustment" (> page 42).
- ▶ If necessary, pull up on the shoulder section of the seat belt to tighten the belt across your body.

In order to attach the child restraint system securely in the vehicle, the seat belt on the front-passenger seat is equipped with a special seat belt retractor. Further information on the "Special seat belt retractor" (> page 54).

### Releasing seat belts

- ❗ Make sure that the seat belt is fully rolled up. Otherwise, the seat belt or belt tongue will be trapped in the door or in the seat mechanism. This could damage the door, the door trim panel and the seat belt. Damaged seat belts can no longer fulfill their protective function and must be replaced. Visit a qualified specialist workshop.

- ▶ Press the release button in the belt buckle, hold the belt tongue firmly and guide the belt back.

### Seat belt adjustment

The seat-belt adjustment is an integral part of the PRE-SAFE<sup>®</sup> convenience function. This function adjusts the driver's and front-passenger seat belt to the upper body of the vehicle occupants.

The belt strap is tightened slightly when:

- the belt tongue is engaged in the buckle and
- the ignition is switched on



The seat-belt adjustment will apply a certain retraction force if any slack is detected between the vehicle occupant and the seat belt. Do not hold on to the seat belt tightly while it is adjusting.

You can activate and deactivate the seat-belt adjustment function using the multimedia system. Information on activating and deactivating

the seat-belt adjustment function can be found in the Digital Operator's Manual.

### Belt warning for the driver and front passenger

The  seat belt warning lamp in the instrument cluster is a reminder that all vehicle occupants must wear their seat belts. It may light up continuously or flash. In addition, there may be a warning tone.

Regardless of whether the driver's seat belt has already been fastened, the  seat belt warning lamp lights up for six seconds each time the engine is started. If the doors are closed and the driver's or front-passenger seat belt has not been fastened, the  seat belt warning lamp lights up again after the six seconds. As soon as the driver's and front-passenger seat belts are fastened or a front door is opened again, the  seat belt warning lamp goes out.

If the driver's seat belt is not fastened after the engine is started, an additional warning tone will sound. The warning tone switches off after six seconds or once the driver's seat belt is fastened.

If the vehicle's speed exceeds 15 mph (25 km/h) once and the driver's and front-passenger seat belts are not fastened, a warning tone sounds. A warning tone also sounds with increasing intensity for 60 seconds or until the driver or front passenger have fastened their seat belts.

If the driver or front passenger unfasten their seat belts during the journey, the seat belt warning is activated again.

## Air bags

### Introduction

The installation point of an air bag can be recognized by the AIRBAG marking.

An air bag complements the correctly fastened seat belt. It is no substitute for the seat belt. The air bag provides additional protection in applicable accident situations.

Not all air bags are deployed in an accident. The different air bag systems function independently from one another (▷ page 50).

However, no system available today can completely eliminate injuries and fatalities.

It is also not possible to rule out a risk of injury caused by an air bag due to the high speed at which the air bag must be deployed.

### Important safety notes

#### WARNING

If you do not sit in the correct seat position, the air bag cannot protect as intended and could even cause additional injury when deployed. This poses an increased risk of injury or even fatal injury.

To avoid hazardous situations, always make sure that all of the vehicle's occupants:

- have fastened their seat belts correctly, including pregnant women
- are sitting correctly and maintain the greatest possible distance to the air bags
- follow the following instructions

Always make sure that there are no objects between the air bag and the vehicle's occupants.

- Adjust the seats properly before beginning your journey. Always make sure that the seat is in an almost upright position. The center of the head restraint must support the head at about eye level.

The setting options are different depending on the seat model.

- Move the driver's and front-passenger seats as far back as possible. The driver's seat position must allow the vehicle to be driven safely.
- Only hold the steering wheel on the outside. This allows the air bag to be fully deployed.
- Always lean against the backrest while driving. Do not lean forward or lean against the door or side window. You may otherwise be in the deployment area of the air bags.
- Always keep your feet in the footwell in front of the seat. Do not put your feet on the dashboard, for example. Your feet may otherwise be in the deployment area of the air bag.
- For this reason, always secure persons less than 5 ft (1.50 m) tall in suitable restraint systems. Up to this height, the seat belt cannot be worn correctly.

**If a child is traveling in your vehicle, also observe the following notes:**

- Always secure children under twelve years of age and less than 5 ft (1.50 m) tall in suitable child restraint systems.
- Only secure a child in a rearward-facing child restraint system on the front-passenger seat when the front-passenger front air bag is deactivated. If the PASSENGER AIR BAG OFF indicator lamp is permanently lit, the front-passenger front air bag is deactivated (> page 39).
- Always observe the instructions and safety notes on the "Occupant Classification System (OCS)" (> page 46) and on "Children in the vehicle" (> page 53) in addition to the child restraint system manufacturer's installation and operating instructions.

**Objects in the vehicle interior may prevent an air bag from functioning correctly.** Before starting your journey and to avoid risks resulting from the speed of the air bag as it deploys, make sure that:

- there are no people, animals or objects between the vehicle occupants and an air bag
- there are no objects between the seat, door and B-pillar
- no accessories, such as cup holders, are attached to the vehicle within the deployment area of an air bag, e.g. to doors or side windows
- no heavy, sharp-edged or fragile objects are in the pockets of your clothing. Store such objects in a suitable place

**⚠ WARNING**

If you modify the air bag cover or affix objects such as stickers to it, the air bag can no longer function correctly. There is an increased risk of injury.

Never modify an air bag cover or affix objects to it.

**⚠ WARNING**

Sensors to control the air bags are located in the doors. Modifications or work not performed correctly to the doors or door paneling, as well as damaged doors, can lead to the function of the sensors being impaired. The air bags might therefore not function properly

anymore. Consequently, the air bags cannot protect vehicle occupants as they are designed to do. There is an increased risk of injury.

Never modify the doors or parts of the doors. Always have work on the doors or door paneling carried out at a qualified specialist workshop.

### Front air bags

- ❗ Do not place heavy objects on the front-passenger seat. This could cause the system to identify the seat as being occupied. In the event of an accident, the restraint systems on the front-passenger side may be triggered and have to be replaced.

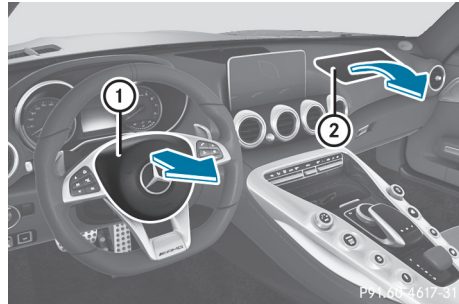

Driver's air bag ① deploys in front of the steering wheel. Front-passenger front air bag ② deploys in front of and above the glove box.

When deployed, the front air bags offer additional head and thorax protection for the occupants in the driver's and front-passenger seats.

The PASSENGER AIR BAG OFF indicator lamp informs you about the status of the front-passenger front air bag (> page 39).

The front-passenger front air bag will only deploy if:

- the system, based on the OCS weight sensor readings, detects that the front-passenger seat is occupied (> page 46). The PASSENGER AIR BAG OFF indicator lamp is not lit (> page 46)
- the restraint system control unit predicts a high accident severity

## Knee bags



Driver's knee bag ① deploys under the steering column and front-passenger knee bag ② under the glove box. The driver's and front-passenger knee bags are triggered together with the front air bags.

The driver's and front-passenger knee bags offer additional thigh, knee and lower leg protection.

## Side impact air bags

### WARNING

Unsuitable seat covers can obstruct or prevent deployment of the air bags integrated into the seats. Consequently, the air bags cannot protect vehicle occupants as they are designed to do. In addition, the operation of the occupant classification system (OCS) could be adversely affected. This poses an increased risk of injury or even fatal injury.

You should only use seat covers that have been approved for the respective seat by Mercedes-Benz.

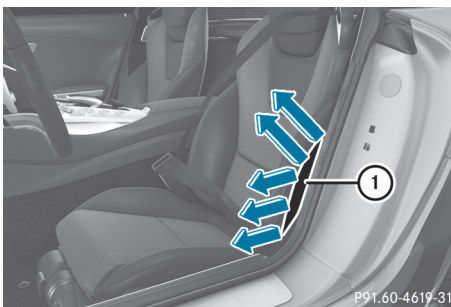

Side impact air bags ① deploy next to the outer bolster of the seat backrest.

When deployed, the side impact air bag offers additional thorax protection. However, it does not protect the:

- head
- neck
- arms

Increased pelvis protection is also offered on vehicles with AMG Performance seat.

In the event of a side impact, the side impact air bag is deployed on the side on which the impact occurs.

The side impact air bag on the front-passenger side deploys under the following conditions:

- the OCS system detects that the front-passenger seat is occupied or
- the seat belt buckle tongue is engaged in the belt buckle of the front-passenger seat

If the belt tongue is engaged in the belt buckle, the side impact air bag on the front-passenger side deploys if an appropriate accident situation occurs. In this case, deployment is independent of whether the front-passenger seat is occupied or not.

## Window curtain air bags

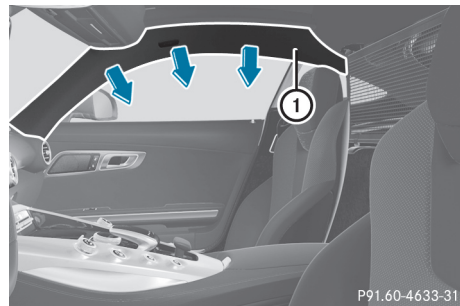

Window curtain air bags ① are integrated in the side of the roof frame above the doors.

When deployed, the window curtain air bag enhances the level of protection for the head. However, it does not protect the chest or arms.

In the event of a side impact, the window curtain air bag is deployed on the side on which the impact occurs.

If the system determines that they can offer additional protection to that provided by the seat belt, a window curtain air bag may be deployed in other accident situations (> page 50).



## Occupant Classification System (OCS)

### Introduction

The Occupant Classification System (OCS) categorizes the person in the front-passenger seat. Depending on that result, the front-passenger front air bag and front-passenger knee bag are either enabled or deactivated.

The system does not deactivate:

- the side impact air bag
- the window curtain air bag
- the Emergency Tensioning Devices

### Requirements

To be classified correctly, the front passenger must sit:

- with the seat belt fastened correctly
- in an almost upright position with their back against the seat backrest
- with their feet resting on the floor, if possible

If the front passenger does not observe these conditions, OCS may produce a false classification, e.g. because the front passenger:

- transfers their weight by supporting themselves on a vehicle armrest
- sits in such a way that their weight is raised from the seat cushion

If you install a child restraint system on the front-passenger seat, be sure to observe the correct positioning of the child restraint system. Never place objects under or behind the child restraint system, e.g. a cushion. The entire base of the child restraint system must always rest on the seat cushion of the front-passenger seat. The backrest of the forward-facing child restraint system must lie as flat as possible against the backrest of the front-passenger seat.

The child restraint system must not touch the roof or be subjected to a load by the head restraint. Adjust the angle of the seat backrest and the head restraint position accordingly.

Only then can OCS be guaranteed to function correctly. Always observe the child restraint system manufacturer's installation and operating instructions.

## Occupant Classification System operation (OCS)

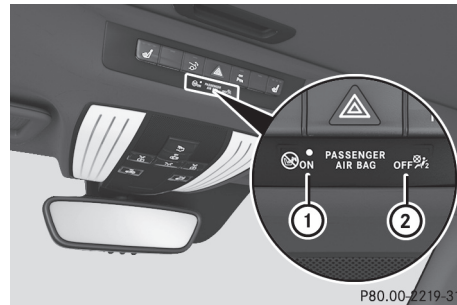

- ① PASSENGER AIR BAG ON indicator lamp
- ② PASSENGER AIR BAG OFF indicator lamp

The indicator lamps inform you whether the front-passenger front air bag is deactivated or enabled.

- ▶ Press the Start/Stop button once or twice, or turn the SmartKey to position **1** or **2** in the ignition lock.

The system carries out self-diagnostics.

The PASSENGER AIR BAG OFF and PASSENGER AIR BAG ON indicator lamps must light up simultaneously for approximately six seconds.

The indicator lamps display the status of the front-passenger front air bag.

- PASSENGER AIR BAG ON lights up for 60 seconds, subsequently both indicator lamps are off (PASSENGER AIR BAG ON and OFF): the front-passenger front air bag is able to deploy in the event of an accident.
- PASSENGER AIR BAG OFF lights up: the front-passenger front air bag is deactivated. It will then not be deployed in the event of an accident.

If the PASSENGER AIR BAG ON indicator lamp is off, only the PASSENGER AIR BAG OFF indicator lamp shows the status of the front-passenger front air bag. The PASSENGER AIR BAG OFF indicator lamp may be lit continuously or be off.

If the status of the front-passenger front air bag changes while the vehicle is in motion, an air bag display message appears in the instrument cluster (▷ page 174). When the front-passenger seat is occupied, always pay attention to the PASSENGER AIR BAG OFF indicator lamp. Be aware of the status of the front-passenger front air bag both before and during the journey.

**⚠ WARNING**

If the PASSENGER AIR BAG OFF indicator lamp is lit, the front-passenger front air bag is disabled. It will not be deployed in the event of an accident and cannot perform its intended protective function. A person in the front-passenger seat could then, for example, come into contact with the vehicle's interior, especially if the person is sitting too close to the dashboard. This poses an increased risk of injury or even fatal injury.

When the front-passenger seat is occupied, always ensure that:

- the classification of the person in the front-passenger seat is correct and the front-passenger front air bag is enabled or disabled in accordance with the person in the front-passenger seat
- the front-passenger seat has been moved back as far back as possible.
- the person is seated correctly.

Make sure, both before and during the journey, that the status of the front-passenger front air bag is correct.

**⚠ WARNING**

If you secure a child in a rearward-facing child restraint system on the front-passenger seat and the PASSENGER AIR BAG OFF indicator lamp is off, the front-passenger front air bag may deploy in the event of an accident. The child could be struck by the air bag. This poses an increased risk of injury or even fatal injury.

Make sure that the front-passenger front air bag has been disabled. The PASSENGER AIR BAG OFF indicator lamp must be lit.

If the PASSENGER AIR BAG OFF indicator lamp stays off, do not install a rearward-facing child restraint system on the front-passenger seat. You can find more information on OCS under "Problems with the Occupant Classification System" (▷ page 49).

**⚠ WARNING**

If you secure a child in a forward-facing child restraint system on the front-passenger seat and you position the front-passenger seat too close to the dashboard, in the event of an accident, the child could:

- come into contact with the vehicle's interior if the PASSENGER AIR BAG OFF indicator lamp is lit, for example
- be struck by the air bag if the PASSENGER AIR BAG OFF indicator lamp is off

This poses an increased risk of injury or even fatal injury.

Move the front-passenger seat as far back as possible. Always make sure that the shoulder belt strap is correctly routed from the vehicle belt guide to the shoulder belt guide on the child restraint system. The shoulder belt strap must be routed forwards and downwards from the vehicle belt guide. Always observe the child restraint system manufacturer's installation instructions.

If OCS determines that:

- the front-passenger seat is unoccupied, the PASSENGER AIR BAG OFF indicator lamp lights up after the system self-test and remains lit. This indicates that the front-passenger front air bag is deactivated.
- the front-passenger seat is occupied by a child of up to twelve months old, in a standard child restraint system, the PASSENGER AIR BAG OFF indicator lamp lights up after the system self-test and remains lit. This indicates that the front-passenger front air bag is deactivated.

But even in the case of a twelve-month-old child, in a standard child restraint system, the PASSENGER AIR BAG OFF indicator lamp can go out after the system self-test. This indicates that the front-passenger front air bag is activated. The result of the classification is dependent on, among other factors, the child restraint system and the child's stature. Make sure that the conditions for a correct classification are met. If the PASSENGER AIR BAG OFF indicator lamp remains off, do not install a child restraint system on the front-passenger seat.



- the front-passenger seat is occupied by a person with a smaller build (e.g. a teenager or small adult), the PASSENGER AIR BAG OFF indicator lamp lights up and remains lit after the system self-test depending on the result of the classification or, alternatively, goes out.
  - if the PASSENGER AIR BAG OFF indicator lamp is off, move the front-passenger seat as far back as possible.
  - if the PASSENGER AIR BAG OFF indicator lamp is lit, a person of smaller stature should not use the front-passenger seat.
- the front-passenger seat is occupied by an adult or a person of adult stature, the PASSENGER AIR BAG OFF indicator lamp goes out after the system self-test. This indicates that the front-passenger front air bag is activated.

If children are traveling in the vehicle, be sure to observe the notes on "Children in the vehicle" (> page 53).

When the Occupant Classification System (OCS) is malfunctioning, the red  restraint system warning lamp on the instrument cluster and the PASSENGER AIR BAG OFF indicator lamp light up simultaneously. The front-passenger front air bag is deactivated in this case and does not deploy during an accident. Have the Occupant Classification System (OCS) checked and repaired immediately at a qualified specialist workshop. Mercedes-Benz recommends that you use an authorized Mercedes-Benz Center for this purpose.

If the front-passenger seat, the seat cover or the seat cushion are damaged, have the necessary repair work carried out at a qualified specialist workshop. Mercedes-Benz recommends that you use an authorized Mercedes-Benz Center for this purpose.

For safety reasons, Mercedes-Benz recommends that you only use seat accessories that have been approved by Mercedes-Benz.

If the driver's air bag deploys, this does not mean that the front-passenger front air bag will also deploy. The Occupant Classification System (OCS) categorizes the occupant on the front-passenger seat. Depending on that result, the front-passenger front air bag is either enabled or deactivated.

## System self-test

### DANGER

If both the PASSENGER AIR BAG OFF and PASSENGER AIR BAG ON indicator lamps do not light up during the system self-test, the system is malfunctioning. The front-passenger front air bag might be triggered unintentionally or might not be triggered at all in the event of an accident with high deceleration. This poses an increased risk of injury or even fatal injury.

In this case the front-passenger seat may not be used. Do not install a child restraint system on the front-passenger seat. Have the Occupant Classification System (OCS) checked and repaired immediately at a qualified specialist workshop.

### WARNING

If the PASSENGER AIR BAG OFF indicator lamp remains lit after the system self-test, the front-passenger front air bag is disabled. It will not be deployed in the event of an accident. In this case, the front-passenger front air bag cannot perform its intended protective function, e.g. when a person is seated in the front-passenger seat.

That person could, for example, come into contact with the vehicle's interior, especially if the person is sitting too close to the dashboard. This poses an increased risk of injury or even fatal injury.

When the front-passenger seat is occupied, always ensure that:

- the classification of the person in the front-passenger seat is correct and the front-passenger front air bag is enabled or disabled in accordance with the person in the front-passenger seat
- the person is seated properly with a correctly fastened seatbelt
- the front-passenger seat has been moved as far back as possible

If the PASSENGER AIR BAG OFF indicator lamp remains lit when it should not, the front-

passenger seat may not be used. Do not install a child restraint system on the front-passenger seat. Have the Occupant Classification System (OCS) checked and repaired immediately at a qualified specialist workshop.

 **WARNING**

Objects between the seat surface and the child restraint system could affect OCS operation. This could result in the front-passenger air bag not functioning as intended during an accident. This poses an increased risk of injury or even fatal injury.

Do not place any objects between the seat surface and the child restraint system. The entire base of the child restraint system must always rest on the seat cushion of the front-passenger seat. The backrest of the forward-

facing child restraint system must, as far as possible, be resting on the backrest of the front-passenger seat. Always comply with the child restraint system manufacturer's installation instructions.

After the system self-test, the PASSENGER AIR BAG OFF or PASSENGER AIR BAG ON indicator lamp displays the status of the front-passenger front air bag (▷ page 46). If the front-passenger front air bag is enabled, the PASSENGER AIR BAG ON indicator lamp lights up for 60 seconds and then goes out.

If the PASSENGER AIR BAG ON indicator lamp is off, only the PASSENGER AIR BAG OFF indicator lamp shows the status of the front-passenger front air bag. The PASSENGER AIR BAG OFF indicator lamp may be lit continuously or be off.

For more information about the OCS, see "Problems with the Occupant Classification System" (▷ page 49).

### **Problems with the Occupant Classification System (OCS)**

---

Be sure to observe the notes on "System self-test" (▷ page 48).

| Problem  | Possible causes/consequences and ► Solutions   |
|--|--|
| <p>The PASSENGER AIR BAG OFF indicator lamp lights up and remains lit, even though the front-passenger seat is occupied by an adult or a person of a stature corresponding to that of an adult.</p>  | <p>The classification of the person on the front-passenger seat is incorrect.</p> <ul style="list-style-type: none"> <li>► Make sure the conditions for a correct classification of the person on the front-passenger seat are met (▷ page 46).</li> <li>► If the PASSENGER AIR BAG OFF indicator lamp remains lit, the front-passenger seat may not be used.</li> <li>► Have OCS checked as soon as possible at an authorized Mercedes-Benz Center.</li> </ul>  |
| <p>The PASSENGER AIR BAG OFF indicator lamp does not light up and/or does not stay on.</p> <p>The front-passenger seat is:</p> <ul style="list-style-type: none"> <li>• unoccupied</li> <li>• occupied with the weight of a child up to twelve months old in a child restraint system</li> </ul> | <p>OCS is malfunctioning.</p> <ul style="list-style-type: none"> <li>► Make sure there is nothing between the seat cushion and the child seat.</li> <li>► Make sure that the entire base of the child restraint system rests on the seat cushion of the front-passenger seat. The backrest of the forward-facing child restraint system must lie as flat as possible against the backrest of the front-passenger seat. If necessary, adjust the position of the front-passenger seat.</li> <li>► When installing the child restraint system, make sure that the seat belt is tight. Do not pull the seat belt tight using the front-passenger seat adjustment. This could result in the seat belt and the child restraint system being pulled too tightly.</li> <li>► Check for correct installation of the child restraint system. Make sure that the head restraint does not apply a load to the child restraint system. If necessary, adjust the head restraint accordingly.</li> <li>► Make sure that no objects are applying additional weight onto the seat.</li> <li>► If the PASSENGER AIR BAG OFF indicator lamp remains off and/or the PASSENGER AIR BAG ON indicator lamp lights up, do not install a child restraint system on the front-passenger seat.</li> <li>► Have OCS checked as soon as possible at an authorized Mercedes-Benz Center.</li> </ul> |

### Deployment of Emergency Tensioning Devices and air bags

#### Important safety notes

##### WARNING

The air bag parts are hot after an air bag has been deployed. There is a risk of injury. Do not touch the air bag parts. Have a deployed air bag replaced at a qualified specialist workshop as soon as possible.

##### WARNING

A deployed air bag no longer offers any protection and cannot provide the intended protection in an accident. There is an increased risk of injury.

Have the vehicle towed to a qualified specialist workshop in order to have a deployed air bag replaced.

Mercedes-Benz recommends that you have the vehicle transported to a qualified specialist workshop after an accident. Observe the notes on towing the vehicle away (▷ page 248).

For your own safety and that of your front passenger, it is important that you have deployed air bags replaced and faulty air bags repaired. This will help to make sure the air bags continue to perform their protective function for the vehicle occupants in the event of a crash.

### **WARNING**

Emergency Tensioning Devices that have deployed pyrotechnically are no longer operational and are unable to perform their intended protective function. This poses an increased risk of injury or even fatal injury.

Have pyrotechnically triggered Emergency Tensioning Devices replaced immediately at a qualified specialist workshop.

An electric motor is used by PRE-SAFE® to trigger the tightening of the seat belt in hazardous situations. This procedure is reversible.

If Emergency Tensioning Devices are triggered or air bags are deployed, you will hear a bang, and a small amount of powder may also be released. The  restraint system warning lamp lights up.

Only in rare cases will the bang affect your hearing. The powder that is released generally does not constitute a health hazard, but it may cause short-term breathing difficulties in people with asthma or other respiratory problems. Provided it is safe to do so, you should leave the vehicle immediately or open the window in order to prevent breathing difficulties.

Air bags and pyrotechnic Emergency Tensioning Devices (ETDs) contain perchlorate material, which may require special handling and regard for the environment. National guidelines must be observed during disposal. In California, see [www.dtsc.ca.gov/HazardousWaste/Perchlorate/index.cfm](http://www.dtsc.ca.gov/HazardousWaste/Perchlorate/index.cfm).

## Method of operation

During the first stage of a collision, the restraint system control unit evaluates important physical data relating to vehicle deceleration or acceleration, such as:

- duration
- direction
- intensity

Based on the evaluation of this data, the restraint system control unit triggers the Emer-

gency Tensioning Devices during a frontal or rear collision.

An Emergency Tensioning Device can only be triggered, if:

- the ignition is switched on
- the components of the restraint system are operational. You can find further information under "Restraint system warning lamp" (▷ page 39)
- the seat belt buckle tongue has engaged in the belt buckle of the respective seat

If the restraint system control unit detects a more severe accident, further components of the restraint system are activated independently of each other in certain frontal collision situations:

- Front air bags as well as driver's and front-passenger knee bags
- Window curtain air bag, if the system determines that deployment can offer additional protection to that provided by the seat belt

The front-passenger front air bag is activated or deactivated depending on the person on the front-passenger seat. The front-passenger front air bag can only deploy in an accident if the PASSENGER AIR BAG OFF indicator lamp is off. Observe the information on the PASSENGER AIR BAG indicator lamps (▷ page 39).

Your vehicle has two-stage front air bags. During the first deployment stage, the front air bag is filled with propellant gas to reduce the risk of injuries. The front air bag is fully deployed with the maximum amount of propellant gas if a second deployment threshold is reached within a few milliseconds.

The activation threshold of the Emergency Tensioning Devices and the air bag are determined by evaluating the rate of vehicle deceleration or acceleration which occurs at various points in the vehicle. This process is pre-emptive in nature. Deployment should take place in good time at the start of the collision.

The rate of vehicle deceleration or acceleration and the direction of the force are essentially determined by:

- the distribution of forces during the collision
- the collision angle
- the deformation characteristics of the vehicle
- the characteristics of the object with which the vehicle has collided

Factors which can only be seen and measured after a collision has occurred do not play a deci-

sive role in the deployment of an air bag. Nor do they provide an indication of air bag deployment.

The vehicle can be deformed considerably, without an air bag being deployed. This is the case if only parts which are relatively easily deformed are affected and the rate of deceleration is not high. Conversely, air bags may be deployed even though the vehicle suffers only minor deformation. This is the case if, for example, very rigid vehicle parts such as longitudinal body members are hit, and sufficient deceleration occurs as a result.

If the restraint system control unit detects a side impact or if the vehicle rolls over, the applicable components of the restraint system are activated independently of each other depending on the apparent type of accident.

- Side impact air bag on the side of impact, independently of the Emergency Tensioning Device and the use of the seat belt on the driver's seat

The side impact air bag on the front-passenger side deploys under the following conditions:

- the OCS system detects that the front-passenger seat is occupied or
- the seat belt buckle tongue is engaged in the belt buckle of the front-passenger seat
- Window curtain air bag on the side of impact, independently of the use of the seat belt and independently of whether the front-passenger seat is occupied
- Emergency Tensioning Devices, if the system determines that deployment can offer additional protection in this situation
- Window curtain air bags on the driver's and front-passenger side in certain situations when the vehicle rolls over, if the system determines that deployment can offer additional protection to that provided by the seat belt

**i** Not all air bags are deployed in an accident. The different air bag systems work independently of each other.

How the air bag system works is determined by the severity of the accident detected, especially the vehicle deceleration or acceleration and the apparent type of accident:

- Frontal collision
- Side impact
- Rollover

## PRE-SAFE® (anticipatory occupant protection system)

### Introduction

In certain hazardous situations, PRE-SAFE® takes pre-emptive measures to protect the vehicle occupants.

### Important safety notes

**i** Make sure that there are no objects in the footwell or behind the seats. There is a danger that the seats and/or objects could be damaged when PRE-SAFE® is activated.

Despite your vehicle being equipped with the PRE-SAFE® system, the possibility of personal injuries occurring as a result of an accident cannot be eliminated. Always adapt your driving style to suit the prevailing road and weather conditions and maintain a safe distance from the vehicle in front. Drive carefully.

### Function

PRE-SAFE® intervenes:

- in emergency braking situations, e.g. when BAS is activated
- in critical driving situations, e.g. when physical limits are exceeded and the vehicle understeers or oversteers severely
- on vehicles with Distance Pilot DISTRONIC: when active, Brake Assist intervenes powerfully

PRE-SAFE® takes the following measures depending on the hazardous situation detected:

- the front seat belts are pre-tensioned.
- if the vehicle skids, the side windows are closed.
- vehicles with the memory function for the front-passenger seat: the front-passenger seat is adjusted if it is in an unfavorable position.

If the hazardous situation passes without resulting in an accident, PRE-SAFE® slackens the belt pre-tensioning. All settings made by PRE-SAFE® can then be reversed.

If the seat belt pre-tensioning is not reduced:

- ▶ Move the seat backrest or seat back slightly when the vehicle is stationary. The seat belt pre-tensioning is reduced and the locking mechanism is released.

The seat-belt adjustment is an integral part of the PRE-SAFE® convenience function. Information about the convenience function can be found under "Belt adjustment" (▷ page 42).

### Automatic measures after an accident

Immediately after an accident, the following measures are implemented, depending on the type and severity of the impact:

- the hazard warning lamps are activated
- the emergency lighting is activated
- the vehicle doors are unlocked
- the front side windows are lowered
- vehicles with a memory function: the electrically adjustable steering wheel is raised when the driver's door is opened
- the engine is switched off and the fuel supply is cut off
- vehicles with mbrace: automatic emergency call

## Children in the vehicle

### Important safety notes

If a child younger than twelve years old and under 5 ft (1.50 m) in height is traveling in the vehicle:

- always secure the child in a child restraint system suitable for Mercedes-Benz vehicles. The child restraint system must be appropriate to the age, weight and size of the child
- be sure to observe the instructions and safety notes in this section in addition to the child restraint system manufacturer's installation instructions
- be sure to observe the instructions and safety notes on the "Occupant classification system (OCS)" (▷ page 46)

### WARNING

If you leave children unsupervised in the vehicle, they could set it in motion, for example by:

- releasing the parking brake
- shifting the transmission to the neutral position
- starting the engine

In addition, they may operate vehicle equipment and become trapped. There is a risk of an accident and injury.

When leaving the vehicle, always take the SmartKey with you and lock the vehicle. Never leave children unsupervised in the vehicle.

### WARNING

If persons, particularly children are subjected to prolonged exposure to extreme heat or cold, there is a risk of injury, possibly even fatal. Never leave children unattended in the vehicle.

### WARNING

If the child restraint system is subjected to direct sunlight, parts may get very hot. Children may burn themselves on these parts, particularly on the metal parts of the child restraint system. There is a risk of injury.

If you leave the vehicle, taking the child with you, always ensure that the child restraint system is not exposed to direct sunlight. Protect it with a blanket, for example. If the child restraint system has been exposed to direct sunlight, let it cool down before securing the child in it. Never leave children unattended in the vehicle.

Always ensure that all vehicle occupants have their seat belts fastened correctly and are sitting properly. Particular attention must be paid to children.

Observe the safety notes on the seat belt (▷ page 40) and the notes on correct use of seat belts (▷ page 41).

A booster seat may be necessary to achieve proper seat belt positioning for children over 41 lbs (18 kg) until they reach a height where a

three-point seat belt can be properly fastened without a booster seat.

### Special seat belt retractor

#### WARNING

If the seat belt is released while driving, the child restraint system will no longer be secured properly. The special seat belt retractor is disabled and the inertia reel draws in a portion of the seat belt. The seat belt cannot be immediately refastened. There is an increased risk of injury, possibly even fatal.

Stop the vehicle immediately, paying attention to road and traffic conditions. Reactivate the special seat belt retractor and secure the child restraint system properly.

The seat belt on the front-passenger's side is equipped with a special seat belt retractor. When activated, the special seat belt retractor ensures that the seat belt cannot slacken once the child seat is secured.

Installing a child restraint system:

- ▶ Make sure you observe the child restraint system manufacturer's installation instructions.
- ▶ Pull the seat belt smoothly out of the seat belt guide.
- ▶ Engage seat belt tongue in belt buckle.

Activating the special seat belt retractor:

- ▶ Pull the seat belt out fully and let the inertia reel retract it again. While the seat belt is retracting, you should hear a ratcheting sound. The special seat belt retractor is enabled.
- ▶ Push the child restraint system down so that the seat belt is tight and does not loosen.

Removing the child restraint system and deactivating the special seat belt retractor:

- ▶ Make sure you observe the child restraint system manufacturer's installation instructions.
- ▶ Press the release button of the seat belt buckle and route the seat belt tongue towards the seat belt guide. The special seat belt retractor is deactivated.

### Child restraint system

The use of seat belts and infant and child restraint systems is required by law in:

- all 50 states
- the U.S. territories
- the District of Columbia
- all Canadian provinces

#### WARNING

If the child restraint system is installed incorrectly on a suitable seat, it cannot protect as intended. The child cannot then be restrained in the event of an accident, heavy braking or sudden changes of direction. There is an increased risk of injury, possibly even fatal.

Make sure that you observe the child restraint system manufacturer's installation instructions and the notes on use. Please ensure, that the base of the child restraint system is always resting completely on the seat cushion. Never place objects, e.g. cushions, under or behind the child restraint system. Only use child restraint systems with the original cover designed for them. Only replace damaged covers with genuine covers.

#### WARNING

If the child restraint system is installed incorrectly or is not secured, it can come loose in the event of an accident, heavy braking or a sudden change in direction. The child restraint system could be thrown about, striking vehicle occupants. There is an increased risk of injury, possibly even fatal.

Always install child restraint systems properly, even if they are not being used. Make sure that you observe the child restraint system manufacturer's installation instructions.

You will find further information on stowing objects, luggage and loads securely under "Loading guidelines" (> page 208).

#### WARNING

Child restraint systems or their securing systems which have been damaged or subjected to a load in an accident can no longer protect



as intended. The child cannot then be restrained in the event of an accident, heavy braking or sudden changes of direction. There is an increased risk of injury, possibly even fatal.

Replace child restraint systems which have been damaged or subjected to a load in an accident as soon as possible. Have the securing systems on the child restraint system checked at a qualified specialist workshop, before you install a child restraint system again.

The seat belt serves as the fastening system for the child restraint system.

If you install a child restraint system on the front-passenger's seat, be sure to observe the instructions on the "Occupant Classification System (OCS)" (> page 46). This includes information on deactivating the front-passenger's air bag.

All child restraint systems must meet the following standards:

- U.S. Federal Motor Vehicle Safety Standards 213 and 225
- Canadian Motor Vehicle Safety Standards 213 and 210.2

A statement by the child restraint manufacturer of compliance with these standards can be found on the instruction label on the child restraint system. You will also find the statement in the instruction manual provided with the child restraint system.

Observe the warning labels in the vehicle interior and on the child restraint system.

### Child restraint system on the front-passenger seat

#### General notes

If you install a child restraint system on the front-passenger seat, always observe the instructions and safety notes on the "Occupant Classification System (OCS)" (> page 46).

You can thus avoid the risks that could arise as a result of:

- an incorrectly categorized person in the front-passenger seat
- the unintentional deactivation of the front-passenger front air bag
- the unsuitable positioning of the child restraint system, e.g. too close to the dashboard

#### Rearward-facing child restraint system

If it is absolutely necessary to install a rearward-facing child restraint system on the front-passenger seat, always make sure that the front-passenger front air bag is deactivated. Only if the PASSENGER AIR BAG OFF indicator lamp is permanently lit (> page 39) is the front-passenger front air bag deactivated.

Always observe the child restraint system manufacturer's installation and operating instructions.

#### Forward-facing child restraint system

If you secure a child in a forward-facing child restraint system on the front-passenger seat, always move the front-passenger seat as far back as possible. The entire base of the child restraint system must always rest on the seat cushion of the front-passenger seat. The backrest of the child restraint system must lie as flat as possible against the backrest of the front-passenger seat. The child restraint system must not touch the roof or be subjected to a load by the head restraint. Adjust the angle of the seat backrest and the head restraint position accordingly. Always make sure that the shoulder belt strap is correctly routed from the front-passenger seat belt guide to the shoulder belt guide on the child restraint system. The shoulder belt strap must be routed forward and down from the front-passenger seat belt guide.

Always observe the child restraint system manufacturer's installation and operating instructions.

### Pets in the vehicle

#### WARNING

If you leave animals unattended or unsecured in the vehicle, they could press buttons or switches, for example.

As a result, they could:

- activate vehicle equipment and become trapped, for example
- activate or deactivate systems, thereby endangering other road users

Unsecured animals could also be flung around the vehicle in the event of an accident or sudden steering or braking, thereby injuring vehicle occupants. There is a risk of an accident and injury.

Never leave animals unattended in the vehicle. Always secure animals properly during the journey, e.g. use a suitable animal transport box.

### Driving safety systems

#### Overview of driving safety systems

In this section, you will find information about the following driving safety systems:

- **ABS (Anti-lock Braking System)** (▷ page 56)
- **BAS (Brake Assist System)** (▷ page 57)
- **Active Brake Assist** (▷ page 57)
- **ESP® (Electronic Stability Program)** (▷ page 59)
- **EBD (Electronic Brake force Distribution)** (▷ page 62)
- **ADAPTIVE BRAKE** (▷ page 62)

#### Important safety notes

If you fail to adapt your driving style or if you are inattentive, the driving safety systems can neither reduce the risk of an accident nor override the laws of physics. Driving safety systems are merely aids designed to assist driving. You are responsible for maintaining the distance to the vehicle in front, for vehicle speed, for braking in

good time, and for staying in lane. Always adapt your driving style to suit the prevailing road and weather conditions and maintain a safe distance from the vehicle in front. Drive carefully.

The driving safety systems described only work as effectively as possible when there is adequate contact between the tires and the road surface. Please pay special attention to the notes on tires, recommended minimum tire tread depths, etc. (▷ page 252).

In wintry driving conditions, always use winter tires (M+S tires) and if necessary, snow chains. Only in this way will the driving safety systems described in this section work as effectively as possible.

### ABS (Anti-lock Braking System)

#### General information

ABS regulates brake pressure in such a way that the wheels do not lock when you brake. This allows you to continue steering the vehicle when braking.

The  ABS warning lamp in the instrument cluster lights up when the ignition is switched on. It goes out when the engine is running.

ABS works from a speed of about 5 mph (8 km/h), regardless of road-surface conditions. ABS works on slippery surfaces, even when you only brake gently.

#### Important safety notes

-  Observe the "Important safety notes" section (▷ page 56).

#### WARNING

If ABS is faulty, the wheels could lock when braking. The steerability and braking characteristics may be severely impaired. Additionally, further driving safety systems are deactivated. There is an increased danger of skidding and accidents.

Drive on carefully. Have ABS checked immediately at a qualified specialist workshop.

When ABS is malfunctioning, other systems, including driving safety systems, will also become inoperative. Observe the information on the ABS warning lamp (▷ page 191) and dis-

play messages which may be shown in the instrument cluster (> page 166).

## Brakes

- ▶ **If ABS intervenes:** continue to depress the brake pedal vigorously until the braking situation is over.
- ▶ **To make a full brake application:** depress the brake pedal with full force.

If ABS intervenes when braking, you will feel a pulsing in the brake pedal.

The pulsating brake pedal can be an indication of hazardous road conditions, and functions as a reminder to take extra care while driving.

## BAS (Brake Assist System)

### General information

BAS operates in emergency braking situations. If you depress the brake pedal quickly, BAS automatically boosts the braking force, thus shortening the stopping distance.

### Important safety notes

- i** Observe the "Important safety notes" section (> page 56).

#### **WARNING**

If BAS is malfunctioning, the braking distance in an emergency braking situation is increased. There is a risk of an accident.

In an emergency braking situation, depress the brake pedal with full force. ABS prevents the wheels from locking.

### Braking

- ▶ Keep the brake pedal firmly depressed until the emergency braking situation is over. ABS prevents the wheels from locking.

The brakes will function as usual once you release the brake pedal. BAS is deactivated.

## Active Brake Assist

### General information

- i** Observe the "Important safety notes" section (> page 56).

Active Brake Assist consists of a distance warning function with an autonomous braking function and situation-dependent braking assistance

Active Brake Assist can help you to minimize the risk of a collision with the vehicle traveling in front or reduce the effects of such a collision.

If Active Brake Assist detects that there is a risk of collision, you will be warned visually and acoustically. If you do not react to the visual and audible collision warning, autonomous braking can be initiated in critical situations. If you apply the brake yourself in a critical situation, Adaptive Brake Assist supports you with situation-dependent braking assistance.

### Important safety notes

In particular, the detection of obstacles can be impaired if:

- there is dirt on the sensors or anything else covering the sensors
- there is snow or heavy rain
- there is interference by other radar sources
- there are strong radar reflections, for example in parking garages
- a narrow vehicle is traveling in front, e.g. a motorbike
- a vehicle is traveling in front on a different line
- new vehicles or after servicing is carried out on the Active Brake Assist system

Observe the important safety notes in the "Breaking-in notes" section (> page 100).

Following damage to the front end of the vehicle, have the configuration and operation of the radar sensor checked at a qualified specialist workshop. This also applies to collisions at slow speeds where there is no visible damage to the front of the vehicle.

### Activating/deactivating

Active Brake Assist is automatically active after switching on the ignition.

You can activate or deactivate Active Brake Assist (> page 159) in the on-board computer.

When deactivated, the distance warning function and the autonomous braking function are also deactivated.

If Active Brake Assist is deactivated, the  symbol appears in the assistance graphic display.

## Distance warning function

### General information

The distance warning function can help you to minimize the risk of a front-end collision with a vehicle ahead or reduce the effects of such a collision. If the distance warning function detects that there is a risk of a collision, you will be warned visually and acoustically.

### Important safety notes

-  Observe the "Important safety notes" section for driving safety systems (▷ page 56).

#### WARNING

The distance warning function does not react:

- to people or animals
- to oncoming vehicles
- to crossing traffic
- when cornering

The distance warning function may not give warnings in all critical situations. There is a risk of an accident.

Always pay careful attention to the traffic situation and be ready to brake.

Always adapt your speed to suit the prevailing road and traffic conditions.

#### WARNING

The distance warning function cannot always clearly identify objects and complex traffic situations.

In such cases, the distance warning function may:

- give an unnecessary warning
- not give a warning

There is a risk of an accident.

Always pay careful attention to the traffic situation and do not rely solely on the distance warning function.

### Function

Starting at a speed of approximately 4 mph (7 km/h), the distance warning function warns you if you rapidly approach a vehicle in front. An intermittent warning tone will then sound, and the  distance warning lamp will light up in the instrument cluster.

- ▶ Brake immediately in order to increase the distance from the vehicle in front.

or

- ▶ Take evasive action, provided it is safe to do so.

Due to the nature of the system, particularly complicated but non-critical driving conditions may also cause the system to display a warning. With the help of the radar sensor system, the distance warning function can detect obstacles that are in the path of your vehicle for an extended period of time.

Up to a speed of approximately 44 mph (70 km/h), the distance warning function can also react to stationary obstacles, such as stopped or parked vehicles.

### Autonomous braking function

If the driver does not react to the distance warning signal in a critical situation, Active Brake Assist can assist the driver with the autonomous braking function.

The autonomous braking function:

- gives the driver more time to react to critical driving situations
- can help the driver to avoid an accident or
- reduces the effects of an accident

**Vehicles without Distance Pilot DISTRONIC:** the autonomous braking function is available in the following speed ranges:

- 4 - 65 mph (7 - 105 km/h) for moving objects
- 4 - 31 mph (7 - 50 km/h) for stationary objects

**Vehicles with Distance Pilot DISTRONIC:** the autonomous braking function is available in the following speed ranges:

- 4 - 124 mph (7 - 200 km/h) for moving objects
- 4 - 31 mph (7 - 50 km/h) for stationary objects

Due to the nature of the system, particularly complicated but non-critical driving conditions

may also cause the Autonomous Braking Function to intervene.

If the autonomous braking function requires a particularly high braking force, preventative passenger protection measures (PRE-SAFE®) are activated simultaneously (> page 52).

### Situation-dependent braking assistance

#### General information

**i** Observe the "Important safety notes" section (> page 56).

With the help of the radar sensor system, Adaptive Brake Assist can detect obstacles that are in the path of your vehicle for an extended period of time.

If Adaptive Brake Assist detects a risk of collision with the vehicle in front, it calculates the brake pressure necessary to avoid a collision. If you apply the brakes forcefully, situation-dependent braking assistance adapts to the situation and automatically increases the brake pressure to a degree appropriate to the traffic situation.

Situation-dependent braking assistance provides braking assistance in hazardous situations at speeds above 4 mph (7 km/h). It uses radar sensor technology to assess the traffic situation.

Situation-dependent braking assistance is capable of reacting to moving objects that have already been detected as such at least once over the period of observation, up to vehicle speeds of around 155 mph (250 km/h).

Situation-dependent braking assistance reacts to stationary obstacles up to a speed of approximately 44 mph (70 km/h).

If situation-dependent braking assistance demands particularly high brake pressure, preventative passenger protection measures (PRE-SAFE®) are triggered simultaneously (> page 52).

- ▶ Keep the brake pedal depressed until the emergency braking situation is over. ABS prevents the wheels from locking.

The brakes will work normally again if:

- you release the brake pedal.
- there is no longer any danger of a collision.
- no obstacle is detected in front of your vehicle.

Situation-dependent braking assistance is then deactivated.

#### Important safety notes

**i** Observe the "Important safety notes" section for driving safety systems (> page 56).

##### WARNING

Adaptive Brake Assist does not react:

- to people or animals
- to oncoming vehicles
- to crossing traffic
- when cornering

As a result, Adaptive Brake Assist may not intervene in all critical conditions. There is a risk of an accident.

Always pay careful attention to the traffic situation and be ready to brake.

##### WARNING

Adaptive Brake Assist cannot always clearly identify objects and complex traffic situations.

In such cases, Adaptive Brake Assist might:

- intervene unnecessarily
- not intervene

There is a risk of an accident.

Always pay careful attention to the traffic situation and be ready to brake. Terminate the intervention in a non-critical driving situation.

Due to the nature of the system, complex but non-critical driving conditions may also cause Active Brake Assist to intervene.

Even if Active Brake Assist is not available due to a malfunction in the radar sensor system, the brake system is still available with full brake boosting effect and BAS.

#### ESP® (Electronic Stability Program)

#### General notes

**i** Observe the "Important safety notes" section (> page 56).

ESP® monitors driving stability and traction, i.e. power transmission between the tires and the road surface.

If ESP® detects that the vehicle is deviating from the direction desired by the driver, one or more wheels are braked to stabilize the vehicle. The engine output is also modified to keep the vehicle on the desired course within physical limits. ESP® assists the driver when pulling away on wet or slippery roads. ESP® can also stabilize the vehicle during braking.

### ETS (Electronic Traction System)

- ❗ Observe the "Important safety notes" section (▷ page 56).

ETS traction control is part of ESP®.

Traction control brakes the drive wheels individually if they spin. This enables you to pull away and accelerate on slippery surfaces, for example if the road surface is slippery on one side. In addition, more drive torque is transferred to the wheel or wheels with traction.

Traction control remains active, even if you deactivate ESP®.

### Important safety notes

- ❗ Observe the "Important safety notes" section (▷ page 56).



#### WARNING

If ESP® is malfunctioning, ESP® is unable to stabilize the vehicle. Additionally, further driving safety systems are deactivated. This increases the risk of skidding and an accident.

Drive on carefully. Have ESP® checked at a qualified specialist workshop.

ESP® is only deactivated if the  warning lamp is lit continuously.

When SPORT handling mode is activated, the  warning lamp lights up in the instrument panel.

When the  and  warning lamps light up continuously, ESP® is not available due to a malfunction.

Observe the information on warning lamps (▷ page 191) and display messages which may be shown in the instrument cluster (▷ page 166).

Only use wheels with the recommended tire sizes. Only then will ESP® function properly.

### Characteristics of ESP®

#### General information

If the  ESP® warning lamp goes out before beginning the journey, ESP® is automatically active.

If ESP® intervenes, the  ESP® warning lamp flashes in the instrument cluster.

If ESP® intervenes:

- ▶ Do not deactivate ESP® under any circumstances.
- ▶ Only depress the accelerator pedal as far as necessary when pulling away.
- ▶ Adapt your driving style to suit the prevailing road and weather conditions.

#### ECO start/stop function

The ECO start/stop function switches the engine off automatically when the vehicle stops moving. The engine starts automatically when the driver wants to pull away again. ESP® remains in its previously selected status. **Example:** if ESP® was deactivated before the engine was switched off, ESP® remains deactivated when the engine is switched on again.

### Deactivating/activating ESP®

#### Important safety notes

- ❗ Observe the "Important safety notes" section (▷ page 56).

You can select between the following states of ESP®:

- ESP® is activated.
- SPORT handling mode is activated.
- ESP® is deactivated.

#### WARNING

If you deactivate ESP®, ESP® no longer stabilizes the vehicle. There is an increased risk of skidding and an accident.

Only deactivate ESP® in the situations described in the following.



### WARNING

When SPORT handling mode is activated, there is a greater risk of skidding and accidents.

Only activate SPORT handling mode in the situations described in the following.

In the following situations, it may be better to activate SPORT handling mode or deactivate ESP®:

- when using snow chains
- in deep snow
- on sand or gravel
- on closed roads when the vehicle's own oversteering and understeering characteristics are desired

Driving in SPORT handling mode or without ESP® requires an extremely qualified and experienced driver.

Activate ESP® as soon as the situations described above no longer apply. ESP® will otherwise not be able to stabilize the vehicle if the vehicle starts to skid or a wheel starts to spin.

**!** Avoid spinning the driven wheels for an extended period with ESP® deactivated. You could otherwise damage the drivetrain.

### Deactivating/activating ESP®

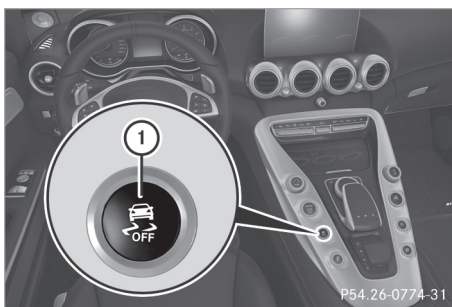



- ▶ **To activate SPORT handling mode:** briefly press button ①.  
The **SPORT** handling mode warning lamp in the instrument cluster lights up. The **SPORT han-**

**dling mode** message appears on the multifunction display.



- ▶ **To deactivate SPORT handling mode:** briefly press button ①.

The **SPORT** handling mode warning lamp in the instrument cluster goes out. ESP® is activated.

- ▶ **To deactivate ESP®:** press button ①.

The  ESP® OFF warning lamp in the instrument cluster lights up. The  OFF message appears on the multifunction display.

- ▶ **To activate ESP®:** when SPORT handling mode is activated or ESP® is deactivated, press button ①.

The  ESP® OFF warning lamp in the instrument cluster goes out. The  ON message appears on the multifunction display.

### Characteristics of activated SPORT handling mode

If SPORT handling mode is activated and one or more wheels start to spin, the  ESP® warning lamp in the instrument cluster flashes. ESP® only stabilizes the vehicle to a limited degree.

When SPORT handling mode is activated:

- ESP® only improves driving stability to a limited degree.
- Traction control is still activated.
- Engine torque is no longer limited and the drive wheels are able to spin.  
The spinning of the wheels results in a cut for better traction on loose surfaces.
- ESP® still provides support when you brake firmly.

### Characteristics when ESP® is deactivated

If ESP® is deactivated and one or more wheels start to spin, the  ESP® warning lamp in the instrument cluster flashes. In such situations, ESP® will not stabilize the vehicle.

If you deactivate ESP®:

- ESP® no longer improves driving stability.
- Engine torque is no longer limited and the drive wheels are able to spin.

The spinning of the wheels results in a cut for better traction on loose surfaces.

- Traction control is still activated.
- Adaptive Brake Assist is unavailable.



Active Brake Assist is also not activated if you brake firmly with assistance from ESP®.

- PRE-SAFE® is unavailable.
- PRE-SAFE® is also not activated if you brake firmly with assistance from ESP®.
- ESP® still provides support when you brake firmly.

### EBD (electronic brake force distribution)

#### General information

EBD monitors and controls the brake pressure on the rear wheels to improve driving stability while braking.

#### Important safety notes

- ⓘ Observe the "Important safety notes" section (▷ page 56).

#### ⚠ WARNING

If EBD is malfunctioning, the rear wheels can lock, e.g. under full braking. This increases the risk of skidding and an accident.

You should therefore adapt your driving style to the different handling characteristics. Have the brake system checked at a qualified specialist workshop.

Observe information regarding indicator and warning lamps (▷ page 191) as well as display messages (▷ page 168).

### ADAPTIVE BRAKE

ADAPTIVE BRAKE enhances braking safety and offers increased braking comfort. In addition to the braking function, ADAPTIVE BRAKE also features the hill start assist function (▷ page 103).

### Protection against theft

#### Immobilizer

The immobilizer prevents your vehicle from being started without the correct SmartKey.

- ▶ **To activate with KEYLESS-GO start-function or KEYLESS-GO:** switch the ignition off and open the driver's door.
- ▶ **To activate with the SmartKey:** remove the SmartKey from the ignition lock.
- ▶ **To deactivate:** switch on the ignition.

When leaving the vehicle, always take the SmartKey with you and lock the vehicle. Anyone can start the engine if a valid SmartKey has been left inside the vehicle.

- ⓘ The immobilizer is always deactivated when you start the engine.

In the event that the engine cannot be started (yet the vehicle's battery is charged), the system is not operational. Contact an authorized Mercedes-Benz Center or call 1-800-FOR-MERCEdes (in the USA) or 1-800-387-0100 (in Canada).

### ATA (anti-theft alarm system)

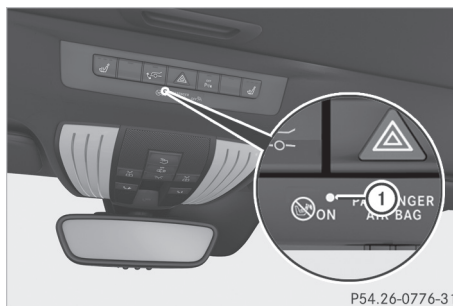

P54.26-0776-31

- ▶ **To arm:** lock the vehicle with the SmartKey or KEYLESS-GO. Indicator lamp ① flashes. The alarm system is armed after approximately 15 seconds.
  - ▶ **To disarm:** unlock the vehicle with the SmartKey or KEYLESS-GO.
- or
- ▶ **With KEYLESS-GO start function or vehicles with KEYLESS-GO:** press the Start/Stop button. The SmartKey must be in the vehicle.
- or
- ▶ Insert the SmartKey into the ignition lock.

A visual and audible alarm is triggered if the alarm system is armed and you open:

- a door
- the vehicle with the mechanical key
- the tailgate
- the hood

► **To turn the alarm off with the SmartKey:**

press the  or  button on the SmartKey.

The alarm is stopped.

or

► Insert the SmartKey into the ignition lock.

The alarm is stopped.

► **To stop the alarm using KEYLESS-GO:**

grasp the outside door handle. The SmartKey must be outside the vehicle.

The alarm is stopped.

or

► Press the Start/Stop button. The SmartKey must be inside the vehicle.

The alarm is stopped.

The alarm is not switched off, even if you close the open door that triggered it, for example.

**i** If the alarm continues for more than 30 seconds, the mbrace emergency call system automatically notifies the Customer Assistance Center. This is done either by text message or data connection.

The emergency call system sends a message or establishes a data connection provided that:

- you have subscribed to the mbrace service.
- the mbrace service has been activated properly.
- the necessary mobile phone network is available.

## SmartKey

### Important safety notes

#### WARNING

If children are left unsupervised in the vehicle, they could:

- open the doors, thus endangering other people or road users.
- get out and disrupt traffic.
- operate the vehicle's equipment.

Additionally, children could set the vehicle in motion if, for example, they:

- release the parking brake.
- shifting the automatic transmission out of park position **P**
- Start the engine.

There is a risk of an accident and injury.

When leaving the vehicle, always take the SmartKey with you and lock the vehicle. Never leave children or animals unattended in the vehicle. Always keep the SmartKey out of reach of children.

#### WARNING

If you attach heavy or large objects to the SmartKey, the SmartKey could be unintentionally turned in the ignition lock. This could cause the engine to be switched off. There is a risk of an accident.

Do not attach any heavy or large objects to the SmartKey. Remove any bulky key rings before inserting the SmartKey into the ignition lock.

- !** Keep the SmartKey away from strong magnetic fields. Otherwise, the remote control function could be affected.

Strong magnetic fields can occur in the vicinity of powerful electrical installations.

Do not keep the SmartKey:

- with electronic devices, e.g. a mobile phone or another SmartKey.
- with metallic objects, e.g. coins or metal foil.
- inside metallic objects, e.g. a metal case.

This can affect the functionality of the SmartKey.

**Vehicles with KEYLESS-GO start function:** do not keep the SmartKey on the cargo compartment cover or in the cargo compartment. Otherwise, the SmartKey may not be detected, e.g. when starting the engine using the Start/Stop button.



A brief radio connection between the vehicle and the SmartKey determines whether a valid SmartKey is in, or in the direct vicinity of, the vehicle. This occurs, for example:

- when starting the engine
- while driving
- when the external door handles are touched
- during convenience closing

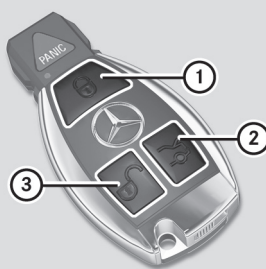
### SmartKey functions



P80.35-2476-31

- ①  Locks the vehicle
- ②  Opens the tailgate
- ③  Unlocks the vehicle

► **To unlock centrally:** press the  button.

If you do not open the vehicle within approximately 40 seconds of unlocking:

- the vehicle is locked again.
- the anti-theft alarm system is armed again.

► **To lock centrally:** press the  button.

The SmartKey centrally locks and unlocks the doors and the fuel filler flap.

When unlocking, the turn signals flash once. When locking, they flash three times.

You can also set an audible signal to confirm that the vehicle has been locked. The audible signal can be activated and deactivated via the multimedia system; see the Digital Operator's Manual.

When the locator lighting is activated via the multimedia system, it lights up when it is dark

after the vehicle is unlocked with the SmartKey. Information on activating and deactivating the locator lighting can be found in the Digital Operator's Manual.

- ▶ **To open the tailgate:** press and hold the  button until the tailgate opens.

## KEYLESS-GO

### General notes

Bear in mind that the engine can be started by any of the vehicle occupants if there is a SmartKey in the vehicle (▷ page 103).

### Locking/unlocking centrally

You can start, lock or unlock the vehicle using KEYLESS-GO. To do this, you only need carry the SmartKey with you. You can combine the functions of KEYLESS-GO with those of a conventional SmartKey. Unlock the vehicle by using KEYLESS-GO, for instance, and lock it using the  button on the SmartKey.

The driver's door and the door at which the handle is used, must both be closed. The SmartKey must be outside the vehicle. When locking or unlocking with KEYLESS-GO, the distance between the SmartKey and the corresponding door handle must not be greater than 3 ft (1 m).

A check which periodically establishes a radio connection between the vehicle and the SmartKey determines whether a valid SmartKey is in the vehicle. This occurs, for example:

- when starting the engine
- while driving
- when the external door handles are touched
- during convenience closing

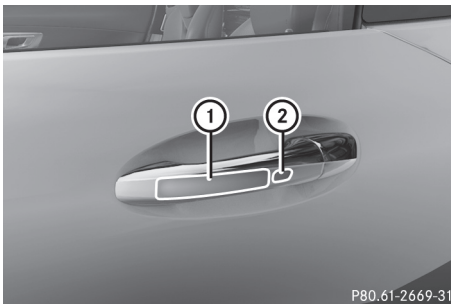

P80.61-2669-31

- ▶ **To unlock the vehicle:** touch the inner surface of the door handle.

- ▶ **To lock the vehicle:** touch sensor surface ① or ②.

Make sure that you do not touch the inner surface of the door handle.

- ▶ **Convenience closing feature:** touch recessed sensor surface ② for an extended period.

Further information on the convenience closing feature (▷ page 74).

### Deactivating and activating

If you do not intend to use the vehicle for a longer period of time, you can deactivate KEYLESS-GO. The SmartKey will then use very little power, thereby conserving battery power. For the purposes of activation/deactivation, the vehicle must not be nearby.

- ▶ **To deactivate:** press the  button on the SmartKey twice in rapid succession.

The battery check lamp of the SmartKey flashes twice briefly and lights up once, then KEYLESS-GO is deactivated (▷ page 67).

- ▶ **To activate:** press any button on the SmartKey.

or

- ▶ Insert the SmartKey into the ignition lock. KEYLESS-GO and all of its associated features are available again.

### KEYLESS-GO start function



Bear in mind that the engine can be started by any of the vehicle occupants if there is a SmartKey in the vehicle (▷ page 103).

### Changing the settings of the locking system

You can change the settings of the locking system. This means that only the driver's door and the fuel filler flap are unlocked when the vehicle is unlocked. This is useful if you frequently travel on your own.



- ▶ **To change the setting:** press and hold down the  and  buttons simultaneously

for about six seconds until the battery indicator lamp flashes twice (▷ page 67).



If the setting of the locking system is changed within the signal range of the vehicle, pressing the  or  button:

- locks or
- unlocks the vehicle

The SmartKey now functions as follows:

- ▶ **To unlock:** press the  button once.
- ▶ **To unlock centrally:** press the  button twice.
- ▶ **To lock:** press the  button.

The KEYLESS-GO functions can be changed as follows:

- ▶ **To unlock the driver's door:** touch the inner surface of the door handle on the driver's door.
- ▶ **To unlock centrally:** touch the inner surface of the front-passenger door handle.
- ▶ **To lock centrally:** touch the outer sensor surface on one of the door handles.
- ▶ **To restore the factory settings:** press and hold down the  and  buttons simultaneously for approximately six seconds until the battery check lamp flashes twice (▷ page 67).

## Mechanical key

### General notes

If the vehicle can no longer be locked or unlocked with the SmartKey or KEYLESS-GO, use the mechanical key.

If you use the mechanical key to unlock and open the driver's door, the anti-theft alarm system will be triggered. Switch off the alarm (▷ page 62).

If you unlock the vehicle using the mechanical key, the fuel filler flap will not be unlocked automatically.

- ▶ **To unlock the fuel filler flap:** insert the SmartKey into the ignition lock.

## Removing the mechanical key

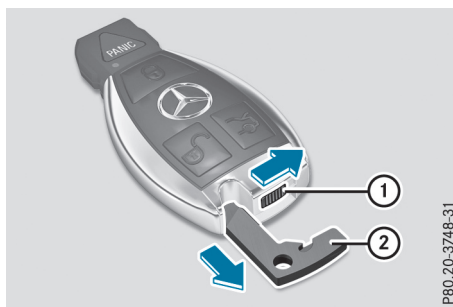

P80.20-3748-31

- ▶ Push release catch ① in the direction of the arrow and at the same time remove mechanical key ② from the SmartKey.

For further information about:

- unlocking the driver's door (▷ page 71)
- locking the vehicle (▷ page 71)

## Inserting the mechanical key

- ▶ Push mechanical key ② completely into the SmartKey until it engages and release catch ① is back in its basic position.

## SmartKey battery

### Important safety notes

#### WARNING

Batteries contain toxic and corrosive substances. If batteries are swallowed, it can result in severe health problems. There is a risk of fatal injury.

Keep batteries out of the reach of children. If a battery is swallowed, seek medical attention immediately.

#### Environmental note



Batteries contain dangerous substances. It is against the law to dispose of them with the household rubbish. They must be collected separately.



and recycled to protect the environment.

Dispose of batteries in an environmentally friendly manner. Take discharged batteries to a qualified specialist workshop or a special collection point for used batteries.

The SmartKey batteries contain perchlorate material, which may require special handling and regard for the environment. National guidelines must be observed during disposal. In California, see [www.dtsc.ca.gov/HazardousWaste/Perchlorate/index.cfm](http://www.dtsc.ca.gov/HazardousWaste/Perchlorate/index.cfm).

Mercedes-Benz recommends that you have the batteries replaced at a qualified specialist workshop.

### Checking the battery



- ▶ Press the or button. The battery is working properly if battery check lamp ① lights up briefly. The battery is discharged if battery check lamp ① does not light up briefly.
- ▶ Change the battery (▷ page 67).

If the SmartKey battery is checked within the signal reception range of the vehicle, pressing the or button:

- locks or
- unlocks the vehicle

**i** You can get a battery at any qualified specialist workshop.

### Replacing the battery

You require a CR 2025 3 V cell battery.

- ▶ Take the mechanical key out of the SmartKey (▷ page 66).

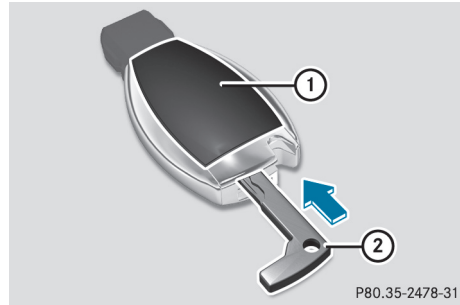

- ▶ Press mechanical key ② into the SmartKey opening in the direction of the arrow until battery compartment cover ① opens. Do not hold battery compartment cover ① closed while doing so.
- ▶ Remove battery compartment cover ①.

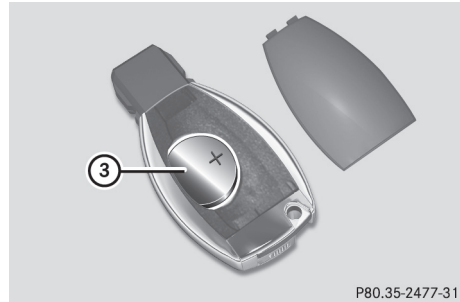

- ▶ Repeatedly tap the SmartKey against your palm until battery ③ falls out.
- ▶ Insert the new battery with the positive terminal facing upwards. Use a lint-free cloth to do so.
- ▶ Make sure that the surface of the battery is free of lint, grease and other contaminants.
- ▶ Insert the front tabs of battery compartment cover ① into the housing first and then press to close it.
- ▶ Insert mechanical key ② into the SmartKey (▷ page 66).
- ▶ Check the function of all SmartKey buttons on the vehicle.

### Problems with the SmartKey

| Problem  | Possible causes/consequences and ► Solutions  |
|--|---|
| You can no longer lock or unlock the vehicle using the SmartKey. | <p>The SmartKey battery is discharged or nearly discharged.</p> <ul style="list-style-type: none"> <li>► Check the SmartKey battery (▷ page 67) and replace it if necessary (▷ page 67).</li> </ul> <p>If this does not work:</p> <ul style="list-style-type: none"> <li>► Unlock (▷ page 71) or lock (▷ page 71) the vehicle using the mechanical key.</li> </ul> <p>There is interference from a powerful source of radio waves.</p> <ul style="list-style-type: none"> <li>► Unlock (▷ page 71) or lock (▷ page 71) the vehicle using the mechanical key.</li> </ul> <p>The SmartKey is faulty.</p> <ul style="list-style-type: none"> <li>► Unlock (▷ page 71) or lock (▷ page 71) the vehicle using the mechanical key.</li> <li>► Have the SmartKey checked at a qualified specialist workshop.</li> </ul>  |
| You can no longer lock or unlock the vehicle using KEYLESS-GO.   | <p>KEYLESS-GO was deactivated.</p> <ul style="list-style-type: none"> <li>► Reactivate KEYLESS-GO (▷ page 65).</li> </ul> <p>The SmartKey battery is discharged or nearly discharged.</p> <ul style="list-style-type: none"> <li>► Check the SmartKey battery (▷ page 67) and replace it if necessary (▷ page 67).</li> </ul> <p>If this does not work:</p> <ul style="list-style-type: none"> <li>► Unlock (▷ page 71) or lock (▷ page 71) the vehicle using the mechanical key.</li> </ul> <p>There is interference from a powerful source of radio waves.</p> <ul style="list-style-type: none"> <li>► Unlock (▷ page 71) or lock (▷ page 71) the vehicle using the mechanical key.</li> </ul> <p>KEYLESS-GO is malfunctioning.</p> <ul style="list-style-type: none"> <li>► Lock/unlock the vehicle using the remote control function of the SmartKey.</li> <li>► Have the vehicle and SmartKey checked at a qualified specialist workshop.</li> </ul> <p>If the vehicle can also not be locked/unlocked using the remote control function:</p> <ul style="list-style-type: none"> <li>► Unlock (▷ page 71) or lock (▷ page 71) the vehicle using the mechanical key.</li> <li>► Have the vehicle and SmartKey checked at a qualified specialist workshop.</li> </ul> |



| Problem   | Possible causes/consequences and ► Solutions   |
|---|--|
| The engine cannot be started using the SmartKey.  | <p>the on-board voltage is too low.</p> <ul style="list-style-type: none"> <li>► Switch off non-essential consumers, e.g. seat heating or interior lighting, and try to start the engine again.</li> </ul> <p>If this does not work:</p> <ul style="list-style-type: none"> <li>► Check the starter battery and charge it if necessary (&gt; page 245).</li> <li>or</li> <li>► Jump-start the vehicle (&gt; page 245).</li> <li>or</li> <li>► Consult a qualified specialist workshop.</li> </ul>  |
| The engine cannot be started using the Start/Stop button. The SmartKey is in the vehicle. | <p>The vehicle is locked.</p> <ul style="list-style-type: none"> <li>► Unlock the vehicle and try to start the vehicle again.</li> </ul> <p>The SmartKey battery is discharged or nearly discharged.</p> <ul style="list-style-type: none"> <li>► Check the SmartKey battery (&gt; page 67) and replace it if necessary (&gt; page 67).</li> </ul> <p>If this does not work:</p> <ul style="list-style-type: none"> <li>► Start your vehicle with the SmartKey in the ignition lock.</li> </ul> <p>There is interference from a powerful source of radio waves.</p> <ul style="list-style-type: none"> <li>► Start your vehicle with the SmartKey in the ignition lock.</li> </ul> |
| You have lost a SmartKey.   | <ul style="list-style-type: none"> <li>► Have the SmartKey deactivated at a qualified specialist workshop.</li> <li>► Report the loss immediately to the vehicle insurers.</li> <li>► If necessary, have the locks changed as well.</li> </ul>   |
| You have lost the mechanical key.   | <ul style="list-style-type: none"> <li>► Report the loss immediately to the vehicle insurers.</li> <li>► If necessary, have the locks changed as well.</li> </ul>  |

## Doors

### Important safety notes

#### WARNING

If children are left unsupervised in the vehicle, they could:

- open the doors, thus endangering other people or road users.
- get out and disrupt traffic.
- operate the vehicle's equipment.

Additionally, children could set the vehicle in motion if, for example, they:

- release the parking brake.
- shifting the automatic transmission out of park position **P**
- Start the engine.

There is a risk of an accident and injury.

When leaving the vehicle, always take the SmartKey with you and lock the vehicle. Never leave children or animals unattended in the vehicle. Always keep the SmartKey out of reach of children.

When a door is opened, the side window on that side opens slightly. When the door is closed, the side window closes again.

**!** The side windows will not open/close if the battery is discharged or if the side windows have iced up. It will then not be possible to close the door. Do not attempt to force the door closed. You could otherwise damage the door or the side window.

### Unlocking and opening doors from the inside

You can open a door from inside the vehicle even if it has been locked. If the vehicle has been locked with the SmartKey or with KEYLESS-GO, opening a door from the inside will trigger the anti-theft alarm system. Switch off the alarm (▷ page 62).



- ▶ Pull door handle (2).  
If the door is locked, locking knob (1) pops up. The door is unlocked and opens.

### Centrally locking and unlocking the vehicle from the inside

You can centrally lock and unlock the vehicle from the inside. The switches are on the driver's door.

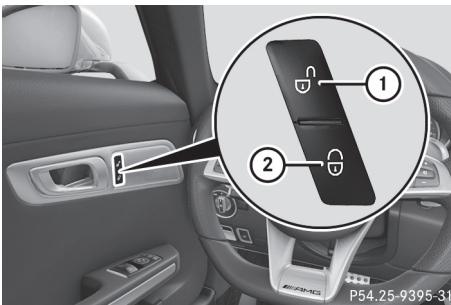

▶ **To unlock:** press button (1).

▶ **To lock:** press button (2).

If the front-passenger door is closed, the vehicle locks.

Meanwhile, the fuel filler flap will not be locked or unlocked.

You cannot unlock the vehicle centrally from the inside if the vehicle has been locked with the SmartKey or KEYLESS-GO.

The doors can be opened from the inside.

If the vehicle has been locked with the SmartKey or with KEYLESS-GO, opening a door from the inside will trigger the anti-theft alarm system. Switch off the alarm (▷ page 62).

If a locked door is opened from the inside, the previous unlock status of the vehicle will be taken into consideration if:

- the vehicle was locked using the locking button for the central locking, or
- if the vehicle was locked automatically

The vehicle will be fully unlocked if it had previously been fully unlocked. If only the driver's door had been previously unlocked, only the door which has been opened from the inside is unlocked.

### Automatic locking feature

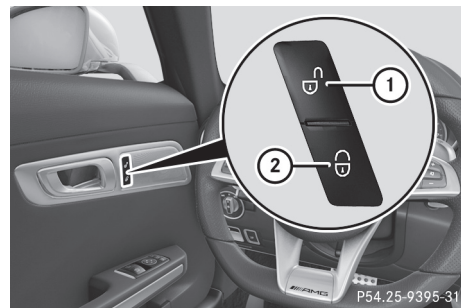

▶ **To deactivate:** press and hold button (1) for approximately five seconds until a tone sounds.

▶ **To activate:** press and hold button (2) for approximately five seconds until a tone sounds.

If you press one of the two buttons and do not hear a tone, the relevant setting has already been selected.

The vehicle is locked automatically when the ignition is switched on and the wheels are turning.

You could therefore be locked out if:

- the vehicle is being pushed
  - the vehicle is being towed
  - the vehicle is on a roller dynamometer
- i** You can activate and deactivate the automatic locking mechanism via the multimedia system (see the Digital Operator's Manual).

### Unlocking/locking the driver's door using the mechanical key

- i** If you want to centrally lock the vehicle using the mechanical key, begin by pressing the locking button for the interior locking mechanism while the driver's door is open. Then proceed to lock the driver's door using the mechanical key.

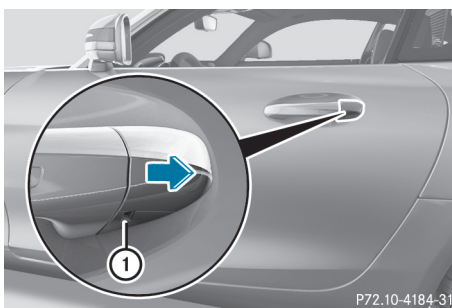

- ▶ Insert the mechanical key as far as it will go into opening ① in the protective cap.
- ▶ Pull and hold the door handle.
- ▶ Pull the protective cap on the mechanical key as straight as possible away from the vehicle until it releases.
- ▶ Release the door handle.

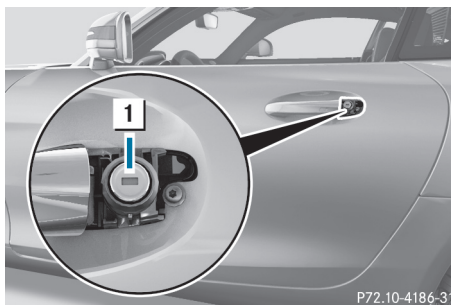

- ▶ **To unlock:** turn the mechanical key counter-clockwise as far as it will go to key position ①.
- ▶ **To lock:** turn the mechanical key clockwise as far as it will go to key position ①.

If you use the mechanical key to unlock and open the driver's door, the anti-theft alarm system will be triggered. Switch off the alarm (▶ page 62).

### Cargo compartment

#### Important safety notes

##### **⚠ WARNING**

Combustion engines emit poisonous exhaust gases such as carbon monoxide. If the tailgate is open when the engine is running, particularly if the vehicle is moving, exhaust fumes could enter the passenger compartment. There is a risk of poisoning.

Turn off the engine before opening the tailgate. Never drive with the tailgate open.

##### **⚠ WARNING**

If objects, luggage or loads are not secured or not secured sufficiently, they could slip, tip over or be flung around and thereby hit vehicle occupants. There is a risk of injury, particularly in the event of sudden braking or a sudden change in direction.

Always store objects so that they cannot be flung around. Secure objects, luggage or loads against slipping or tipping before the journey.

**!** The tailgate swings upwards and out when opening. Therefore, make sure that there is sufficient space above the tailgate.

The opening dimensions of the tailgate can be found in the "Vehicle data" section (▷ page 282).

You can switch the cargo compartment lamp on and off manually on the overhead control panel (▷ page 90).

Do not leave the SmartKey in the cargo compartment. You could otherwise lock yourself out.

You should preferably place luggage or loads in the cargo compartment. Observe the loading guidelines (▷ page 208).

### Opening/closing from outside

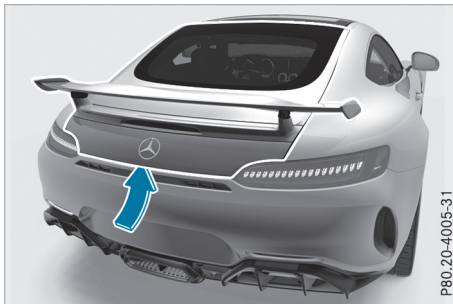

#### Opening



- ▶ Press the  button on the SmartKey. The tailgate opens slightly.
- ▶ Raise the tailgate.

#### Closing



- ▶ Pull the tailgate down using recess  and let it drop into the lock.
- ▶ Lock the vehicle if necessary with the  button on the SmartKey or with KEYLESS-GO (▷ page 65).

### Unlocking from inside the vehicle

#### WARNING

Combustion engines emit poisonous exhaust gases such as carbon monoxide. If the tailgate is open when the engine is running, particularly if the vehicle is moving, exhaust fumes could enter the passenger compartment. There is a risk of poisoning.

Turn off the engine before opening the tailgate. Never drive with the tailgate open.



You can open the tailgate from the driver's seat when the vehicle is stationary and unlocked.

- ▶ Press remote operating switch  for the tailgate until the tailgate is unlocked. The tailgate opens slightly.

### Tailgate emergency release

Use the emergency release if the tailgate can no longer be unlocked:

- using the SmartKey
- using the remote operating switch on the instrument panel
- ▶ Climb into the cargo compartment via the vehicle interior. Unhook the cargo compartment cover, if necessary (▷ page 210).

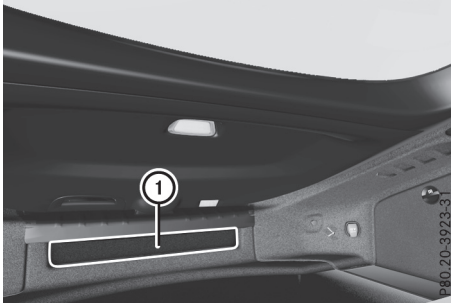

- ▶ Push carpet ① down.
- ▶ Pull the cable behind carpet ① until the tailgate unlocks.  
The tailgate opens slightly.
- ▶ Raise the tailgate.

When you close the tailgate, it is also locked at the same time.

## Side windows

### Important safety notes

#### **WARNING**

While opening the side windows, body parts could become trapped between the side window and the door frame as the side window moves. There is a risk of injury.

Make sure that nobody touches the side window during the opening procedure. If somebody becomes trapped, release the switch or pull the switch to close the side window again.

#### **WARNING**

While closing the side windows, body parts in the closing area could become trapped. There is a risk of injury.

When closing make sure that no parts of the body are in the closing area. If somebody becomes trapped, release the switch or press the switch to open the side window again.

#### **WARNING**

If children operate the side windows they could become trapped, particularly if they are left unsupervised. There is a risk of injury.

When leaving the vehicle, always take the SmartKey with you and lock the vehicle. Never leave children unsupervised in the vehicle.

### Side window reversing feature

The side windows are equipped with an automatic reversing feature. If a solid object blocks or restricts a side window from traveling upwards during the automatic closing process, the side window opens again automatically. During the manual closing process, the side window only opens again automatically after the corresponding switch is released. The automatic reversing feature is only an aid and does not relieve you of the responsibility of paying attention when closing a side window.

#### **WARNING**

The reversing feature does not react:

- to soft, light and thin objects, e.g. small fingers
- while resetting

This means that the reversing feature cannot prevent someone being trapped in these situations. There is a risk of injury.

Make sure that no body parts are in close proximity during the closing procedure. If someone becomes trapped, press the switch to open the side window again.

### Opening and closing the side windows

The switches for all side windows are located on the driver's door. There is also a switch on the front-passenger door for the corresponding side window.

The switch on the driver's door has priority.

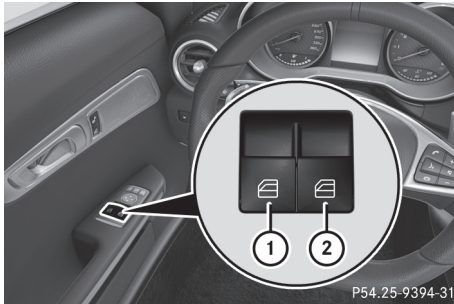

- ① Left
- ② Right

- ▶ Switch on the power supply or switch on the ignition with the Start/Stop button.
- ▶ **To open manually:** press and hold the corresponding switch.
- ▶ **To open fully:** press the switch beyond the point of resistance and release it. Automatic operation is started.
- ▶ **To close manually:** pull the corresponding switch and hold it.
- ▶ **To close fully:** pull the switch beyond the point of resistance and release it. Automatic operation is started.
- ▶ **To interrupt automatic operation:** press/pull the corresponding switch again.

If you press the switch beyond the point of resistance and release, automatic operation is started in the corresponding direction. You can stop automatic operation by pressing/pulling the switch again.

You can still operate the side windows when you switch off the power supply or the ignition. This function remains active for five minutes or until you open a door.

### Convenience opening

#### General notes

You can ventilate the vehicle before you start driving.

If the SmartKey is in close proximity to the vehicle, the convenience opening function is available.



To do so, open the side windows using the SmartKey.

The "convenience opening" feature is also available when the vehicle is unlocked.

### Convenience opening

- ▶ After unlocking the vehicle, press and hold the  button on the SmartKey until the side windows begin to open.

or

- ▶ When the vehicle is unlocked, press and hold the  button until the side windows have reached the desired position.
- ▶ **To interrupt convenience opening:** release the  button.

### Convenience closing feature

#### Important safety notes



##### WARNING

When using the convenience closing feature, parts of the body could be trapped in the closing area when a side window is being closed. There is a risk of injury.

Observe the complete closing procedure when the convenience closing feature is operating. Make sure that no body parts are in close proximity during the closing procedure.

When you lock the vehicle, you can close the windows at the same time.

#### Using the SmartKey

- ▶ Press and hold the  button until the side windows are fully closed.
- ▶ Make sure that all the side windows are closed.
- ▶ **To interrupt convenience closing:** release the  button.

#### Using KEYLESS-GO

The driver's door and the door at which the handle is used, must both be closed. The SmartKey must be outside the vehicle. The gap between the SmartKey and the corresponding door handle should not be greater than 3 ft (1 m).



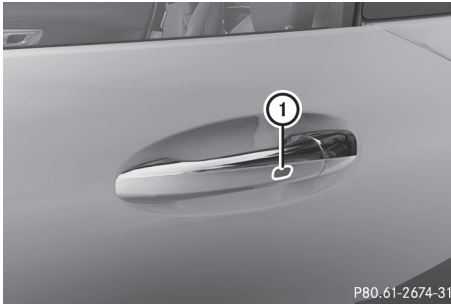

- ▶ Touch recessed sensor surface ① on the door handle until the side windows are fully closed.  
Make sure you only touch recessed sensor surface ①.
- ▶ Make sure that all the side windows are closed.
- ▶ **To interrupt convenience closing:** release recessed sensor surface ① on the door handle.

### Resetting the side windows

If a side window can no longer be closed fully, you must reset it.

- ▶ Close all the doors.
- ▶ Switch on the power supply or switch on the ignition with the Start/Stop button.
- ▶ Pull the corresponding switch on the door control panel until the side window is completely closed (▷ page 73).
- ▶ Hold the switch for an additional second.

If the side window opens again slightly:

- ▶ Immediately pull the corresponding switch on the door control panel until the side window is completely closed (▷ page 73).
- ▶ Hold the switch for an additional second.
- ▶ If the respective side window remains closed after the button is released, then it has been set correctly. If this is not the case, repeat the steps above.

### Problems with the side windows

#### **WARNING**

If you close a side window again immediately after it has been blocked or reset, the side window closes with increased or maximum force. The reversing feature is then not active. Parts of the body could be trapped in the closing area in the process. This poses an increased risk of injury or even fatal injury.

Make sure that no parts of the body are in the closing area. To stop the closing process, release the switch or push the switch again to reopen the side window.



| Problem   | Possible causes/consequences and ► Solutions   |
|---|--|
| A side window cannot be closed because it is blocked by objects, e.g. leaves in the window guide. | <ul style="list-style-type: none"> <li>► Remove the objects.</li> <li>► Close the side window.</li> </ul>  |
| A side window cannot be closed and you cannot see the cause.                                      | <p>If a side window is obstructed during closing and reopens again slightly:</p> <ul style="list-style-type: none"> <li>► Immediately after the window blocks, pull the corresponding switch again until the side window has closed.<br/>The side window is closed with increased force.</li> </ul> <p>If a side window is obstructed again during closing and reopens again slightly:</p> <ul style="list-style-type: none"> <li>► Immediately after the window blocks, pull the corresponding switch again until the side window has closed.<br/>The side window is closed without the automatic reversing feature.</li> </ul> |

### Correct driver's seat position

#### WARNING

You could lose control of your vehicle if you do the following while driving:

- adjust the driver's seat, head restraint, steering wheel or mirrors
- fasten the seat belt

There is a risk of an accident.

Adjust the driver's seat, head restraint, steering wheel and mirror and fasten your seat belt before starting the engine.



P91.40-3400-31

Observe the following when adjusting steering wheel ①, seat belt ② and driver's seat ③:

- you are as far away from the driver's air bag as possible
- you are sitting in a normal upright position
- your thighs are slightly supported by the seat cushion
- your legs are not entirely stretched and you can depress the pedals properly
- the back of your head is supported at eye level by the center of the head restraint
- you can hold the steering wheel with your arms slightly bent
- you can move your legs freely

- you can see all the displays in the instrument cluster clearly
- you should have a good overview of traffic conditions
- the seat belt is pulled snugly against the body and is routed across the center of your shoulder and across your hips in the pelvic area

Further related subjects:

- Manual seat adjustment. (▷ page 78)
- Electrical seat adjustment. (▷ page 79)
- Fastening the seat belt correctly (▷ page 42).
- Adjusting the rear-view mirror and exterior mirrors (▷ page 83).
- Storing seat settings, steering wheel and exterior mirrors with the memory function (▷ page 86).

### Seats

#### Important safety notes

#### WARNING

Children could become trapped if they adjust the seats, particularly when unattended. There is a risk of injury.

When leaving the vehicle, always take the SmartKey with you and lock the vehicle. Never leave children unsupervised in the vehicle.

The seats can still be adjusted when there is no SmartKey in the ignition lock.

#### WARNING

When you adjust a seat, you or other vehicle occupants could become trapped, e.g. on the seat guide rail. There is a risk of injury.

Make sure when adjusting a seat that no one has any body parts in the sweep of the seat.

Observe the safety notes on "Air bags" (▷ page 43) and "Children in the Vehicle" (▷ page 53).

**⚠ WARNING**

You could lose control of your vehicle if you do the following while driving:

- adjust the driver's seat, head restraint, steering wheel or mirrors
- fasten the seat belt

There is a risk of an accident.

Adjust the driver's seat, head restraint, steering wheel and mirror and fasten your seat belt before starting the engine.

For safety reasons, seat fore-and-aft adjustment on electrically adjustable seats is only possible for a maximum of two seconds when the vehicle is in motion. The seat fore-and-aft adjustment can then no longer be set.

**⚠ WARNING**

If you adjust the seat height carelessly, you or other vehicle occupants could be trapped and thereby injured. Children in particular could accidentally press the electrical seat adjustment buttons and become trapped. There is a risk of injury.

While moving the seats, make sure that your hands or other body parts do not get under the lever assembly of the seat adjustment system.

**⚠ WARNING**

If head restraints are not adjusted correctly, they cannot provide protection as intended. There is an increased risk of injury in the head and neck area, e.g. in the event of an accident or when braking.

Before driving off, make sure for every vehicle occupant that the center of the head restraint supports the back of the head at about eye level.

Using the fore-and-aft adjustment, adjust the head restraint so that it is as close as possible to your head.

**⚠ WARNING**

The seat belt does not offer the intended level of protection if you have not moved the backrest to an almost vertical position. When brak-

ing or in the event of an accident, you could slide underneath the seat belt and sustain abdomen or neck injuries, for example. This poses an increased risk of injury or even fatal injury.

Adjust the seat properly before beginning your journey. Always ensure that the backrest is in an almost vertical position and that the shoulder section of your seat belt is routed across the center of your shoulder.

**!** To avoid damage to the seats and the seat heating, observe the following information:

- keep liquids from spilling on the seats. If liquid is spilled on the seats, dry them as soon as possible.
- if the seat covers are damp or wet, do not switch on the seat heating. The seat heating should also not be used to dry the seats.
- clean the seat covers as recommended; see "Interior care".
- do not transport heavy loads on the seats. Do not place sharp objects on the seat cushions, e.g. knives, nails or tools. The seats should only be occupied by passengers, if possible.
- when the seat heating is in operation, do not cover the seats with insulating materials, e.g. blankets, coats, bags, seat covers, child seats or booster seats.

**!** Make sure that there are no objects in the footwell under or behind the seats when moving the seats back. There is a risk that the seats and/or the objects could be damaged.

**Adjusting the seats manually****General notes**

The manually adjustable seat is only available in Canada.

### Adjusting the seat fore-and-aft position

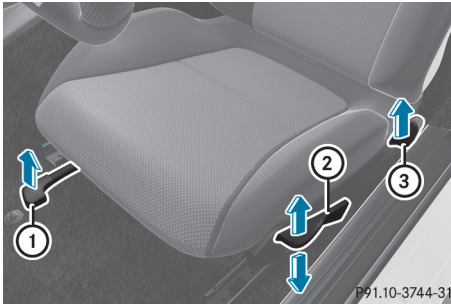

- ▶ Lift handle ① and slide the seat forwards or backwards.
- ▶ Release lever ① again. Make sure that you hear the seat engage in position.

### Backrest angle

- ▶ Relieve the pressure on the backrest.
- ▶ Pull lever ③ up and adjust the backrest to the desired angle.
- ▶ Release lever ③ again. The seat backrest must audibly engage.

### Seat height

- ▶ Pull up or push down lever ② repeatedly until the seat has reached the desired height.

### Adjusting the seats electrically

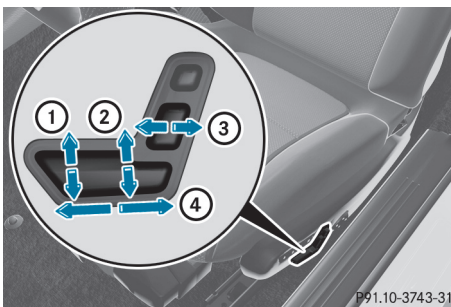

- ① Seat cushion angle
- ② Seat height
- ③ Backrest angle
- ④ Seat fore-and-aft adjustment

For safety reasons, seat fore-and-aft adjustment on electrically adjustable seats is only possible for a maximum of two seconds when the vehicle is in motion. The seat fore-and-aft adjustment can then no longer be set.

**i** If after starting the journey no correct seat fore-and-aft adjustment has been made, there is a risk of accident and injury. Pull over and stop the vehicle safely as soon as possible and readjust the seat position.

**i** Further related subjects:

- You can store the seat settings using the memory function (▷ page 86).
- If PRE-SAFE® is triggered, the front-passenger seat will be moved to a better position if it was previously in an unfavorable position (▷ page 52).

### Adjusting the head restraints

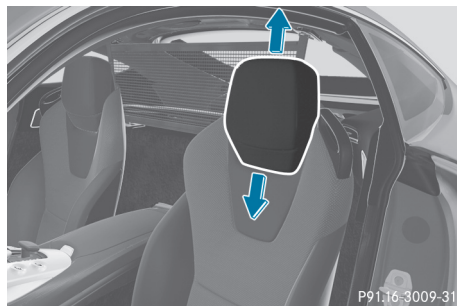

- ▶ **To raise:** pull the head restraint up to the desired position.
- ▶ **To lower:** push the head restraint down to the desired position.

**i** The head restraint can only be adjusted on manually and electrically adjustable seats, but not with AMG Performance Seats.

### Adjusting the lumbar support

You can adjust the contour of the seat backrests individually to provide optimum support for your back.

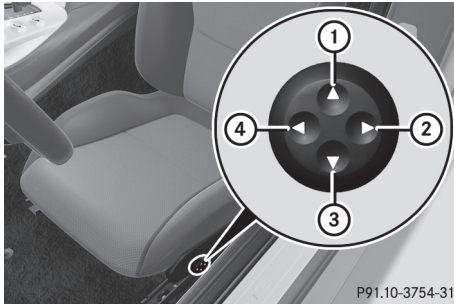

P91.10-3754-31

- ① To raise the backrest contour
- ② To soften the backrest contour
- ③ To lower the backrest contour
- ④ To harden the backrest contour

### Adjusting the AMG Performance Seat

#### General notes

To adjust the contour of the seat and for improved lateral support, you can individually adjust the front seats.

The AMG Performance seat is designed for the standard three-point seat belt. If you install another multi-point seat belt, e.g. sport or racing seat belts, the restraint system cannot provide the best level of protection.

For further information about the seat belt (▷ page 41)

#### Adjusting the side bolsters of the seat cushion and the seat backrest

##### Driver's seat

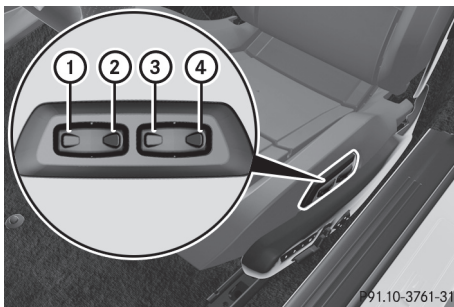

P91.10-3761-31

##### Side bolsters of the seat cushion

- ▶ To narrow: press button ①.
- ▶ To broaden: press button ②.

##### Side bolsters of the seat backrest

- ▶ To narrow: press button ③.
- ▶ To broaden: press button ④.

##### Front-passenger seat

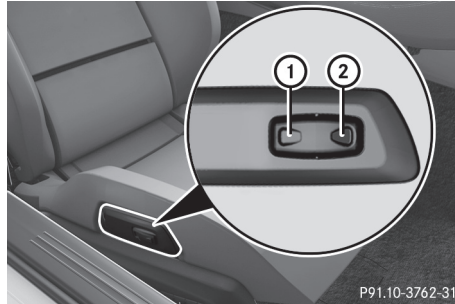

P91.10-3762-31

##### Side bolsters of the seat backrest

- ▶ To narrow: press button ①.
- ▶ To broaden: press button ②.

- ❗ The side bolsters of the front-passenger seat cushion cannot be adjusted.

### Switching the seat heating on/off

#### Switching on/off

##### ⚠ WARNING

Repeatedly switching on the seat heating can cause the seat cushion and backrest pads to become very hot. The health of persons with limited temperature sensitivity or a limited ability to react to high temperatures may be affected or they may even suffer burn-like injuries. There is a risk of injury.

Therefore, do not switch the seat heating on repeatedly.

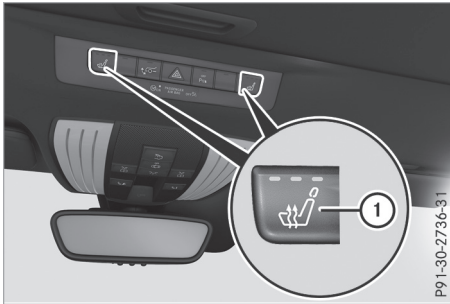

The three red indicator lamps in the button indicate the heating level you have selected.

The system automatically switches down from level 3 to level 2 after approximately eight minutes.

The system automatically switches down from level 2 to level 1 after approximately ten minutes.

The system automatically switches off approximately 20 minutes after it is set to level 1.

► Select key position **2** with the Start/Stop button.

► **To switch on:** press button **1** repeatedly until the desired heating level is set.

► **To switch off:** press button **1** repeatedly until all the indicator lamps go out.

**i** If the battery voltage is too low, the seat heating may switch off.

### Problems with the seat heating

| Problem   | Possible causes/consequences and ► Solutions   |
|---|--|
| The seat heating has switched off prematurely or cannot be switched on. | <p>The on-board voltage is too low because too many electrical consumers are switched on.</p> <p>► Switch off electrical consumers that you do not need, such as the rear window defroster or interior lighting.</p> <p>Once the battery is sufficiently charged, the seat heating can be switched back on manually.</p> |

### Steering wheel

#### Important safety notes

##### **⚠ WARNING**

You could lose control of your vehicle if you do the following while driving:

- adjust the driver's seat, head restraint, steering wheel or mirrors
- fasten the seat belt

There is a risk of an accident.

Adjust the driver's seat, head restraint, steering wheel and mirror and fasten your seat belt before starting the engine.

##### **⚠ WARNING**

If the steering wheel is unlocked while the vehicle is in motion, it could change position unexpectedly. This could cause you to lose

control of the vehicle. There is a risk of an accident.

Before starting off, make sure the steering wheel is locked. Never unlock the steering wheel while the vehicle is in motion.

##### **⚠ WARNING**

Children could injure themselves if they adjust the steering wheel. There is a risk of injury.

When leaving the vehicle, always take the SmartKey with you and lock the vehicle. Never leave children unsupervised in the vehicle.

The electrically adjustable steering wheel can still be adjusted when there is no SmartKey in the ignition lock.



### Adjusting the steering wheel

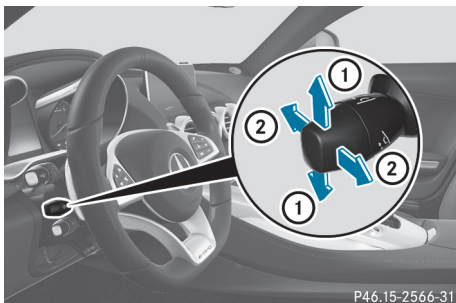

- ① Adjusts the steering wheel position (fore-and-aft adjustment)
  - ② Adjusts the steering wheel height
- i** Further related subjects:
- EASY-ENTRY/EXIT feature (▷ page 82)
  - Storing settings (▷ page 86)

### EASY-ENTRY/EXIT feature

#### Important safety notes

#### **⚠ WARNING**

When the EASY-ENTRY/EXIT feature adjusts the steering wheel, you and other vehicle occupants – particularly children – could become trapped. There is a risk of injury.

While the EASY-ENTRY/EXIT feature is making adjustments, make sure that no one has any body parts in the sweep of the steering wheel.

Move the steering wheel adjustment lever if there is a risk of entrapment by the steering wheel. The adjustment process is stopped.

Press one of the memory function position buttons. The adjustment process is stopped. This function is only available on vehicles with memory function.

#### **⚠ WARNING**

If children activate the EASY-ENTRY/EXIT feature, they can become trapped, particularly when unattended. There is a risk of injury.

When leaving the vehicle, always take the SmartKey with you and lock the vehicle. Never leave children unsupervised in the vehicle.

#### **⚠ WARNING**

If you drive off while the EASY-ENTRY/EXIT feature is making adjustments, you could lose control of the vehicle. There is a risk of an accident.

Always wait until the adjustment process is complete before driving off.

The EASY-ENTRY/EXIT feature makes getting in and out of your vehicle easier.

You can activate and deactivate the EASY-ENTRY/EXIT feature using the multimedia system (see the Digital Operator's Manual)

### Position of the steering wheel when the EASY-ENTRY/EXIT feature is active

The steering wheel swings up when you:

- remove the SmartKey from the ignition lock
- open the driver's door with the Start/Stop switch in position **1**

- i** The steering wheel only moves up if it has not already reached the upper stop.

### Position of the steering wheel for driving

The steering wheel is moved to the last selected position when you:

- close the driver's door and
- press the Start/Stop button once

When you close the driver's door with the ignition switched on, the steering wheel is also automatically moved to the previously set position.

The last position of the steering wheel column is stored after each manual setting or when you store the setting with the memory function (▷ page 86).

### Crash-responsive EASY-EXIT feature

If the crash-responsive EASY-EXIT feature is triggered in an accident, the steering column will move upwards when the driver's door is opened or the SmartKey is removed from the ignition



lock. This makes it easier to exit the vehicle and rescue the occupants.

## Mirrors

### Rear-view mirror

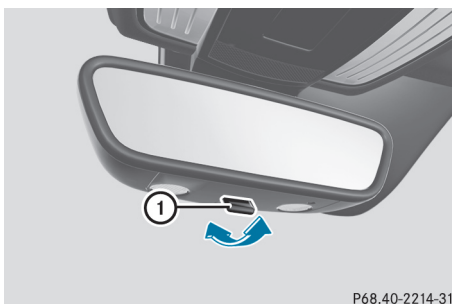

P68.40-2214-31

- ▶ **Anti-glare mode:** flick anti-glare lever ① forwards or back.

### Exterior mirrors

#### Important safety notes

##### WARNING

You could lose control of your vehicle if you do the following while driving:

- adjust the driver's seat, head restraint, steering wheel or mirrors
- fasten the seat belt

There is a risk of an accident.

Adjust the driver's seat, head restraint, steering wheel and mirror and fasten your seat belt before starting the engine.

##### WARNING

The exterior mirror on the front-passenger side reduces the size of the image. Visible objects are actually closer than they appear. This means that you could misjudge the distance from road users traveling behind, e.g. when changing lane. There is a risk of an accident.

For this reason, always make sure of the actual distance from the road users traveling behind by glancing over your shoulder.

### Adjusting the exterior mirrors

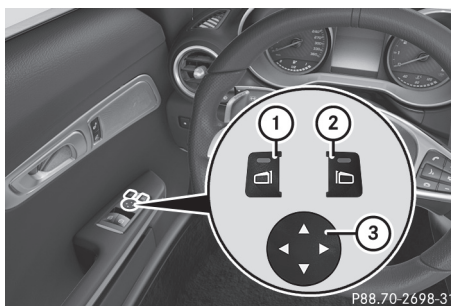

P88.70-2698-31

- ▶ Select key position ① or ② with the Start/Stop button.
- ▶ Exterior mirror on the front-passenger side: press button ②.  
Exterior mirror on the front-passenger side: press button ①.  
The indicator lamp lights up in the button that has been pressed.  
The indicator lamp goes out again after some time. You can adjust the selected mirror using button ③ as long as the indicator lamp is lit.
- ▶ Press button ③ up, down, or to the left or right until you have adjusted the exterior mirror to the correct position. You should have a good overview of traffic conditions.

The convex exterior mirrors provide a larger field of vision.

After the engine has been started, the exterior mirrors are automatically heated if the rear window defroster is switched on and the outside temperature is low.

### Folding the exterior mirrors in or out electrically

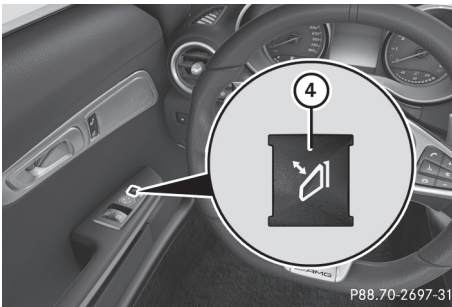

- ▶ Select key position **1** or **2** with the Start/Stop button.
- ▶ Briefly press button **4**. Both exterior mirrors fold in or out.
- i** Make sure that the exterior mirrors are always folded out fully while driving. They could otherwise vibrate.
- i** If you are driving faster than 30 mph (47 km/h), you can no longer fold in the exterior mirrors.

### Resetting the exterior mirrors

If the battery has been disconnected or completely discharged, the exterior mirrors must be reset. The exterior mirrors will otherwise not fold in when you select the **Automatic Mirror Folding** function in the multimedia system.

- ▶ Select key position **1** with the Start/Stop button.
- ▶ Briefly press button **4**.

### Folding the exterior mirrors in or out automatically

When the **Automatic Mirror Folding** function is activated in the multimedia system:

- the exterior mirrors fold in automatically as soon as you lock the vehicle from the outside.
  - the exterior mirrors fold out automatically again as soon as you unlock the vehicle.
- i** If the exterior mirrors have been folded in manually, they do not fold out.

### Exterior mirror pushed out of position

If an exterior mirror has been pushed out of position, proceed as follows:

- ▶ Press and hold button **4** until you hear a click and the mirror engages audibly into position (▷ page 84). The mirror housing is engaged again and you can adjust the exterior mirrors as usual (▷ page 83).

### Automatic anti-glare mirrors

#### **⚠ WARNING**

Electrolyte may escape if the glass in an automatic anti-glare mirror breaks. The electrolyte is harmful and causes irritation. It must not come into contact with your skin, eyes, respiratory organs or clothing or be swallowed. There is a risk of injury.

If you come into contact with the electrolyte, observe the following:

- Rinse off the electrolyte from your skin immediately with water.
- Immediately rinse the electrolyte out of your eyes thoroughly with clean water.
- If the electrolyte is swallowed, immediately rinse your mouth out thoroughly. Do not induce vomiting.
- If electrolyte comes into contact with your skin or hair or is swallowed, seek medical attention immediately.
- Immediately change out of clothing which has come into contact with electrolyte.
- If an allergic reaction occurs, seek medical attention immediately.

The rear-view mirror and the exterior mirror on the driver's side automatically go into anti-glare mode if the following conditions are met simultaneously:

- the ignition is switched on
- incident light from headlamps strikes the sensor in the rear-view mirror

The mirrors do not go into anti-glare mode if reverse gear is engaged or if the interior lighting is switched on.

### Parking position for the exterior mirror on the front-passenger side

#### Storing the parking position

You can position the front-passenger side exterior mirror in such a way that you can see the rear wheel on that side as soon as you engage reverse gear. You can store this position.

#### Using reverse gear

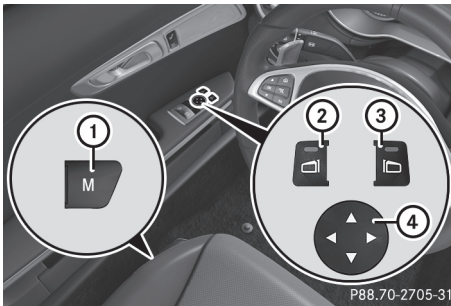

- ① Memory button **M**
- ② Button for the driver's side exterior mirror
- ③ Button for the front-passenger side exterior mirror
- ④ Switch

- ▶ Select key position **2** with the Start/Stop button.
- ▶ Press button **③**.
- ▶ Start the engine.
- ▶ Engage reverse gear.  
The exterior mirror on the front-passenger side moves to the default setting parking position.
- ▶ Use button **④** to adjust the exterior mirror to a position that allows you to see the rear wheel and the curb.  
The parking position is stored.

**i** If you shift the transmission to another position, the exterior mirror on the front-passenger side returns to the driving position after approximately ten seconds.

#### Using the memory button

You can store the parking position of the exterior mirror on the front-passenger side using memory button **M** **①**. The reverse gear must not be engaged.

- ▶ Select key position **2** with the Start/Stop button.
- ▶ Press button **③**.
- ▶ Use button **④** to adjust the exterior mirror to a position that allows you to see the rear wheel and the curb.
- ▶ Press memory button **M** **①** and one of the arrows on button **④** within three seconds.  
The parking position is stored if the exterior mirror does not move.
- ▶ If the mirror moves out of position, repeat the steps.

#### Calling up a stored parking position setting

- ▶ Select key position **2** with the Start/Stop button.
- ▶ Adjust the exterior mirror on the front-passenger side using button **③**.
- ▶ Start the engine.
- ▶ Engage reverse gear.  
The exterior mirror on the front-passenger side moves to the stored parking position.  
The exterior mirror on the front-passenger side moves back to its original position:
  - as soon as you exceed a speed of 9 mph (15 km/h)
  - about ten seconds after you have disengaged reverse gear
  - if you press button **②** for the exterior mirror on the driver's side

### Memory function

#### Important safety notes

##### **⚠ WARNING**

If you use the memory function on the driver's side while driving, you could lose control of the vehicle as a result of the adjustments being made. There is a risk of an accident. Only use the memory function on the driver's side when the vehicle is stationary.

##### **⚠ WARNING**

When the memory function adjusts the seat or steering wheel, you and other vehicle occu-

pants – particularly children – could become trapped. There is a risk of injury.

While the memory function is making adjustments, make sure that no one has any body parts in the sweep of the seat or steering wheel. If somebody becomes trapped, immediately release the memory function position button. The adjustment process is stopped.

#### WARNING

Children could become trapped if they activate the memory function, particularly when unattended. There is a risk of injury.

When leaving the vehicle, always take the SmartKey with you and lock the vehicle. Never leave children unsupervised in the vehicle.

#### Storing settings

The memory function can be used at any time, e.g. even when the SmartKey is not in the ignition lock.

With the memory function, you can store up to three different settings, e.g. for three different people.

The following settings are stored as a single memory preset:

- seat and backrest position
- driver's side: position of the exterior mirrors on the driver's and front-passenger sides

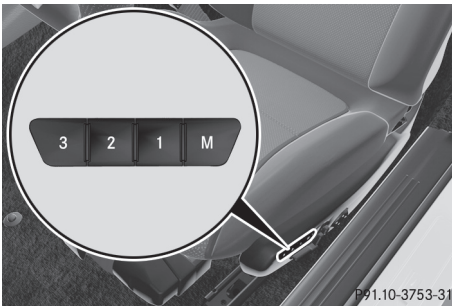

- ▶ Select key position **2** with the Start/Stop button.
- ▶ Adjust the seat accordingly (▷ page 79).

- ▶ On the driver's side, adjust the steering wheel (▷ page 82) and the exterior mirrors (▷ page 83).
- ▶ Press memory button **M** and one of the storage position buttons **1**, **2** or **3** within three seconds.  
The settings are stored in the selected preset position. A tone sounds when the settings have been completed.

#### Calling up a stored setting

- ▶ Press and hold the corresponding storage position button **1**, **2** or **3** until:
  - Seat
  - Steering wheel
  - Exterior mirrors
 are in the stored position.
- i** The steering wheel and seat adjustment procedure is interrupted as soon as you release the storage position button. Mirror adjustment continues.

## Exterior lighting

### General notes

For reasons of safety, Mercedes-Benz recommends that you drive with the lights switched on even during the daytime. In some countries, operation of the headlamps varies due to legal requirements and self-imposed obligations.

### Setting the exterior lighting

#### Setting options

Exterior lighting can be set using:

- the light switch
- the combination switch (▷ page 88)

#### Light switch

##### Operation

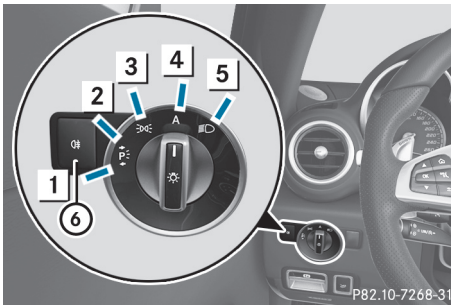

- 1 Left-hand standing lamps
- 2 Right-hand standing lamps
- 3 Parking lamps, license plate and instrument cluster lighting
- 4 Automatic headlamp mode, controlled by the light sensor
- 5 Low-beam/high-beam headlamps
- 6 Rear fog lamp

If you hear a warning tone when you leave the vehicle, the lights may still be switched on.

- ▶ Turn the light switch to the position.

The exterior lighting (except the parking/standing lamps) switches off automatically if you:

- Switch off the engine with the Start/Stop button
- Open the driver's door

### Automatic headlamp mode

#### WARNING

If the light switch is set to and it is foggy, snowing or there is poor visibility, the low-beam headlamps will not come on automatically. There is a risk of an accident.

In such situations, turn the light switch to



The automatic headlamp feature is only an aid. The driver is responsible for the vehicle's lighting at all times.

#### Canada only:

The daytime running lamps improve the visibility of your vehicle during the day. The daytime running lamps function is required by law in Canada. It cannot therefore be deactivated.

When the engine is running and the vehicle is stationary: if you move the selector lever out of a driving position into position (P), the daytime running lamps/low-beam headlamps go out after three minutes.

When the engine is running, the vehicle is stationary and in bright ambient light: if you turn the light switch to the position, the daytime running lamps and parking lamps switch on.

If the engine is running and you turn the light switch to the position, the manual settings take precedence over the daytime running lamps.

#### USA only:

The daytime running lamps improve the visibility of your vehicle during the day. To do this, the daytime running lamps function must be switched on using the on-board computer (▷ page 160).

If the engine is running and you turn the light switch to the or position, the manual settings take precedence over the daytime running lamps.

is the preferred light switch position. The light setting is automatically selected according to the brightness of the ambient light (exception: poor visibility due to weather conditions such as fog, snow or spray):

- If the Start/Stop button is pressed once: depending on the brightness of the ambient light, the parking lamps are switched on or off automatically.
- With the engine running: if you have activated the **Daytime Running Lights** function via

P82.10-7268-31

the on-board computer, the daytime running lamps or the parking lamps and the low-beam headlamps are switched on or off automatically depending on the brightness of the ambient light.

- **To switch on the automatic headlamps:** turn the light switch to the **AUTO** position.



### Low-beam headlamps

#### WARNING

If the light switch is set to **A** and it is foggy, snowing or there is poor visibility, the low-beam headlamps will not come on automatically. There is a risk of an accident.





In such situations, turn the light switch to .

When the ignition is switched on and the light switch is in the  position, the parking lamps and low-beam headlamps are switched on even if the light sensor does not sense dark conditions. This is a particularly useful function in the event of rain and fog.



- **To switch on the low-beam headlamps:** select key position **2** with the Start/Stop button or start the engine.
- Turn the light switch to the  position. The green  indicator lamp in the instrument cluster lights up.



### Rear fog lamp

The rear fog lamp improves visibility of your vehicle for the traffic behind in the event of thick fog. Please take note of the country-specific regulations for the use of rear fog lamps.

- **To switch on the rear fog lamp:** select key position **2** with the Start/Stop button or start the engine.
- Turn the light switch to the  or **AUTO** position.
- Press the  button. The yellow  indicator lamp in the instrument cluster lights up.
- **To switch off the rear fog lamp:** press the  button. The yellow  indicator lamp in the instrument cluster goes out.



### Parking lamps

**!** If the battery charge is very low, the parking lamps or standing lamps are automatically switched off to enable the next engine start. Always park your vehicle safely and in a well lit area, in accordance with the relevant legal stipulations. Avoid using the  parking lamps over a period of several hours. If possible, switch on the right-hand  or left-hand  standing lamps.

- **To switch on:** turn the light switch to the  position. The green  indicator lamp in the instrument cluster lights up.

### Standing lamps

Switching on the standing lamps ensures the corresponding side of the vehicle is illuminated.

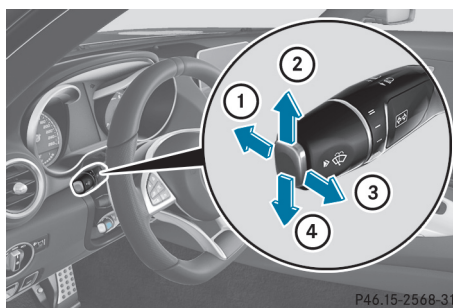

- **To switch on the standing lamps:** switch off the engine with the Start/Stop button.
- Turn the light switch to the  (left-hand side of the vehicle) or  ((right-hand side of the vehicle) position.

### Combination switch



- ① High-beam headlamps
- ② Turn signal, right
- ③ High-beam flasher
- ④ Turn signal, left
- **To indicate briefly:** press the combination switch briefly to the pressure point in the direction of arrow ② or ④. The corresponding turn signal flashes three times.
- **To indicate:** press the combination switch beyond the pressure point in the direction of arrow ② or ④.



- ▶ **To switch on the high-beam headlamps:** select key position **2** with the Start/Stop button or start the engine.
- ▶ Turn the light switch to the  or **AUTO** position.
- ▶ Press the combination switch beyond the pressure point in the direction of arrow **1**. In the **AUTO** position, the high-beam headlamps are only switched on when it is dark and the engine is running.  
The  indicator lamp in the instrument cluster lights up when the high-beam headlamps are switched on.
- ▶ **To switch off the high-beam headlamps:** move the combination switch back to its normal position.  
The  indicator lamp in the instrument cluster goes out.

Vehicles with Adaptive Highbeam Assist: when Adaptive Highbeam Assist is active, it controls switching on/off of the high-beam headlamps (▷ page 89).

- ▶ **To switch on the high-beam flasher:** pull the combination switch in the direction of arrow **3**.

### Hazard warning lamps

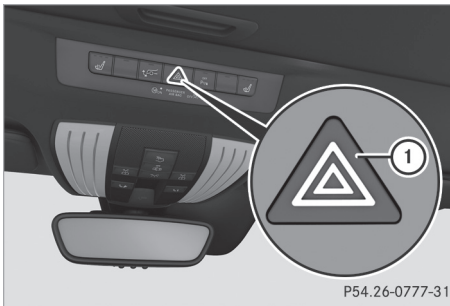

- ▶ **To switch on the hazard warning lamps:** press button **1**.  
All turn signals flash. If you now switch on a turn signal using the combination switch, only the turn signal lamp on the corresponding side of the vehicle will flash.
- ▶ **To switch off the hazard warning lamps:** press button **1**.

The hazard warning lamps automatically switch on if:

- an air bag is deployed or
- the vehicle decelerates rapidly from a speed of above 45 mph (70 km/h) and comes to a standstill

The hazard warning lamps switch off automatically if the vehicle reaches a speed of above 6 mph (10 km/h) again after a full brake application.

- i** The hazard warning lamps still operate if the ignition is switched off.

### Adaptive Highbeam Assist

#### General notes

You can use this function to set the headlamps to change between low beam and high beam automatically. The system recognizes vehicles with their lights on, either approaching from the opposite direction or traveling in front of your vehicle, and consequently switches the headlamps from high beam to low beam.

The system automatically adapts the low-beam headlamp range depending on the distance to the other vehicle. Once the system no longer detects any other vehicles, it reactivates the high-beam headlamps.

The system's optical sensor is located behind the windshield near the overhead control panel.

#### Important safety notes

##### **WARNING**

Adaptive Highbeam Assist does not recognize road users:

- who have no lights, e.g. pedestrians
- who have poor lighting, e.g. cyclists
- whose lighting is blocked, e.g. by a barrier

On very rare occasions, Adaptive Highbeam Assist may fail to recognize other road users that have lights, or may recognize them too late. In this, or in similar situations, the automatic high-beam headlamps will not be deactivated or will be activated regardless. There is a risk of an accident.



Always carefully observe the traffic conditions and switch off the high-beam headlamps in good time.

Adaptive Highbeam Assist cannot take into account road, weather or traffic conditions. Adaptive Highbeam Assist is only an aid. You are responsible for adjusting the vehicle's lighting to the prevailing light, visibility and traffic conditions.

In particular, the detection of obstacles can be restricted if there is:

- poor visibility, e.g. due to fog, heavy rain or snow
- dirt on the sensors or the sensors are obscured



### Switching Adaptive Highbeam Assist on/off

- ▶ **To switch on:** turn the light switch to the **AUTO** position.
- ▶ Press the combination switch beyond the pressure point in the direction of arrow ①. The  indicator lamp in the multifunction display lights up when it is dark and the light sensor activates the low-beam headlamps. If you are driving at speeds above approximately 16 mph (25 km/h):  
The headlamp range is set automatically depending on the distance between the vehicle and other road users.

If you are driving at speeds above approximately 19 mph (30 km/h) and no other road users have been detected:

The high-beam headlamps are switched on automatically. The  indicator lamp in the instrument cluster also lights up.

If you are driving at speeds below approximately 16 mph (25 km/h) or other road users have been detected or the roads are adequately lit:

The high-beam headlamps are switched off automatically. The  indicator lamp in the instrument cluster goes out. The  indicator lamp in the multifunction display remains lit.

- ▶ **To switch off:** move the combination switch back to its normal position or move the light switch to another position. The  indicator lamp in the instrument cluster goes out.

### Headlamps fogged up on the inside



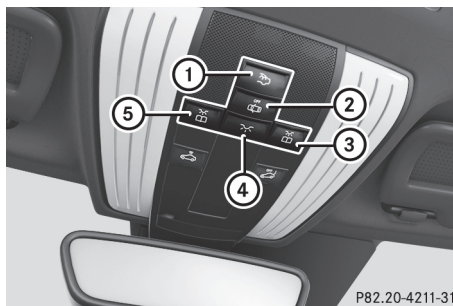

Certain climatic and physical conditions may cause moisture to form in the headlamp. This moisture does not affect the functionality of the headlamp.

## Interior lighting

### Overview



P82.20-4211-31

- ①  Activates/deactivates the cargo compartment lamp
- ②  Switches the automatic interior lighting control on or off
- ③  Switches the right-hand reading lamp on/off
- ④  Activates/deactivates interior lighting
- ⑤  Switches the left-hand reading lamp on/off

### Interior lighting control

#### General notes

In order to avoid the vehicle battery discharging, the interior light functions are deactivated after some time, except for when the Start/Stop button is in key position ②.

#### Automatic interior lighting control

- ▶ **To switch on or off:** press the  button. When the automatic interior lighting control is activated, the button is flush with the overhead control panel.

The interior lighting automatically switches on if you:

- unlock the vehicle
- open a door
- switch off the engine with the Start/Stop button

The interior lighting is activated for a short time when the engine is switched off with the Start/Stop button. This delayed switch-off can be adjusted via the multimedia system (see Digital Operator's Manual).

### Replacing bulbs

The front and rear light clusters of your vehicle are equipped with LED light bulbs. Do not replace the bulbs yourself. Contact a qualified specialist workshop which has the necessary specialist knowledge and tools to carry out the work required.

Lamps are an important aspect of vehicle safety. You must therefore make sure that these function correctly at all times. Have the headlamp setting checked regularly.

### Windshield wipers

#### Switching the windshield wipers on/off

**!** Do not operate the windshield wipers when the windshield is dry, as this could damage the wiper blades. Moreover, dust that has collected on the windshield can scratch the glass if wiping takes place when the windshield is dry.

If it is necessary to switch on the windshield wipers in dry weather conditions, always use washer fluid when operating the windshield wipers.

**!** If the windshield wipers leave smears on the windshield after the vehicle has been washed in an automatic car wash, wax or other residues may be the reason for this. Clean the windshield using washer fluid after washing the vehicle in an automatic car wash.

**!** Intermittent wiping with rain sensor: due to optical influences and the windshield becoming dirty in dry weather conditions, the windshield wipers may be activated inadvertently.

This could then damage the windshield wiper blades or scratch the windshield.

For this reason, you should always switch off the windshield wipers in dry weather.

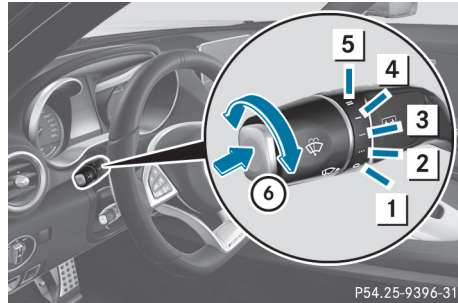

- |   |  |   |
|---|--|---|
| 1 |  | Windshield wiper off  |
| 2 |  | Intermittent wipe, low (rain sensor set to low sensitivity)   |
| 3 |  | Intermittent wipe, high (rain sensor set to high sensitivity) |
| 4 |  | Continuous wipe, slow   |
| 5 |  | Continuous wipe, fast   |
| 6 |  | Single wipe   |
|   |  | Wipes with washer fluid                                       |

► Switch on the ignition.

► Turn the combination switch to the corresponding position.

In the or position, the appropriate wiping frequency is set automatically according to the intensity of the rain. In the position, the rain sensor is more sensitive than in the position, causing the windshield wiper to wipe more frequently.

The rain sensor is only an aid. The driver is responsible for ensuring unimpaired vision. Turn the switch to a suitable position, depending on the intensity of the precipitation, to ensure that a good view of the traffic conditions is maintained.

If the wiper blades are worn, the windshield will no longer be wiped properly. This could prevent you from observing the traffic conditions.

Worn or damaged wiper blades cause smearing. This can cause the rain sensor to malfunction

### Replacing the wiper blades

#### Important safety notes

#### WARNING

If the windshield wipers begin to move while you are changing the wiper blades, you could be trapped by the wiper arm. There is a risk of injury.

Always switch off the windshield wipers and ignition before changing the wiper blades.

**!** Never open the hood if a windshield wiper arm has been folded away from the windshield.

Never fold a windshield wiper arm without a wiper blade back onto the windshield.

Hold the windshield wiper arm firmly when you change the wiper blade. If you release the windshield wiper arm without a wiper blade and it falls onto the windshield, the windshield may be damaged by the force of the impact.

Mercedes-Benz recommends that you have the wiper blades changed at a qualified specialist workshop.

**!** To avoid damaging the wiper blades, make sure that you touch only the wiper arm of the wiper.

#### Replacing the wiper blades

##### Adjusting the wiper blades so that they are vertical

- ▶ Switch off the engine.
- ▶ Remove your foot from the brake pedal.

- ▶ Set the windshield wiper to the  position.
- ▶ Press the Start/Stop button repeatedly until the windshield wiper starts.
- ▶ When the wiper arms are in a vertical position to the hood, press the Start/Stop button.
- ▶ Fold the wiper arm away from the windshield.

#### Removing the wiper blades

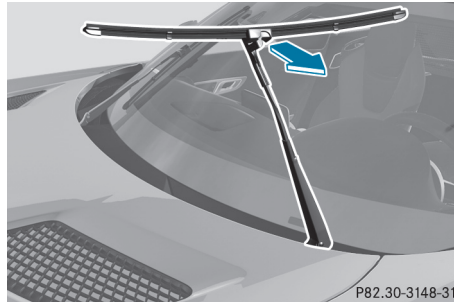

- ▶ Set the wiper blade at right angles to the wiper arm.
- ▶ Remove the wiper blade from the retainer on the wiper arm in the direction of the arrow.

#### Installing the wiper blades

- ▶ Slide the new wiper blade into the retainer on the wiper arm in the opposite direction to the arrow.
- ▶ Turn the wiper blade parallel to the wiper arm.
- ▶ Fold the wiper arm back onto the windshield.

### Problems with the windshield wipers

| Problem   | Possible causes/consequences and ► Solutions  |
|---|---|
| The windshield wipers are jammed.   | Leaves or snow, for example, may be obstructing the windshield wiper movement. The wiper motor has been deactivated. <ul style="list-style-type: none"> <li>► Switch off the engine using the Start/Stop button and open the driver's door.</li> <li>► Remove the cause of the obstruction.</li> <li>► Switch the windshield wipers back on.</li> </ul> |
| The windshield wipers fail completely.  | The windshield wiper drive is malfunctioning. <ul style="list-style-type: none"> <li>► Select another wiper speed on the combination switch.</li> <li>► Have the windshield wipers checked at a qualified specialist workshop.</li> </ul>   |
| The windshield washer fluid from the spray nozzles no longer hits the center of the windshield. | The spray nozzles are misaligned. <ul style="list-style-type: none"> <li>► Have the spray nozzles adjusted at a qualified specialist workshop.</li> </ul>   |
| The wiper arms are on the windshield.   | The wiper arms have been moved by an external force. <ul style="list-style-type: none"> <li>► Select key position <b>2</b> with the Start/Stop button. The wiper arms move back down automatically.</li> </ul>  |

## Overview of climate control systems

### General notes

Observe the settings recommended on the following pages. The windows could otherwise fog up.

To prevent the windows from fogging up:

- switch off climate control only briefly
- switch on air-recirculation mode only briefly
- switch on the cooling with air dehumidification function
- switch on the defrost windshield function briefly, if required

Climate control regulates the temperature and air humidity in the vehicle interior. The interior filter cleans the air, thus improving the interior climate.

The cooling with air dehumidification function is only available when the engine is running. Optimum climate control is only achieved with the side windows closed.

**i** Ventilate the vehicle for a brief period during warm weather, e.g. using the convenience opening feature (> page 74). This will speed up the cooling process and the desired interior temperature will be reached more quickly.

**i** The integrated filter filters out most particles of dust and soot and completely filters out pollen. It also reduces gaseous pollutants and odors. A clogged filter reduces the amount of air supplied to the vehicle interior. Depending on the operating conditions and environmental influences, the interval for replacing the filter may be shorter than specified.

**i** It is possible that the blower may be activated automatically 60 minutes after the engine has been switched off depending on various factors, e.g. the outside temperature. The vehicle is then ventilated for 30 minutes to dry the climate control system.

### Control panel for dual-zone automatic climate control

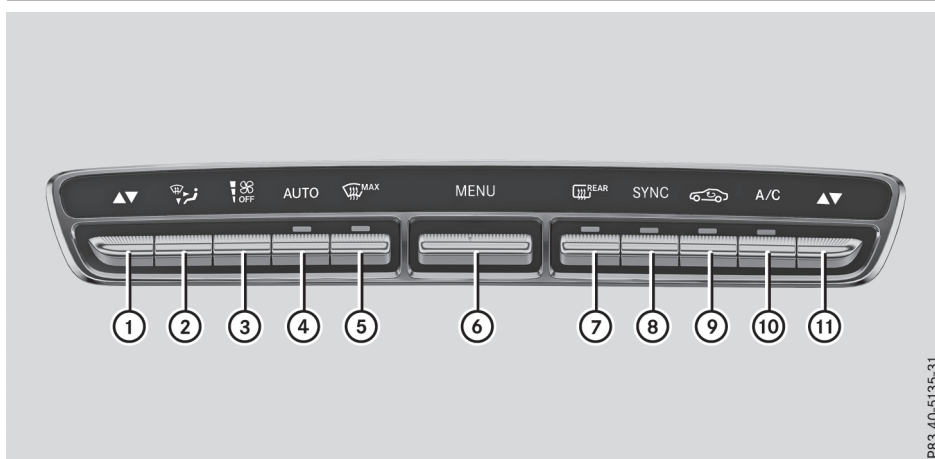

P83\_40-5135-31

- ① Sets the temperature, left (> page 96)
- ② Sets the air distribution, left (> page 96)
- ③ Sets the airflow (> page 97)
- ④ Switches off climate control (> page 95)
- ④ Sets climate control to automatic (> page 96)
- ⑤ Defrosts the windshield (> page 97)
- ⑥ Calls up the climate control menu of the multimedia system (> page 203)
- ⑦ Switches the rear window defroster on/off (> page 97)

- ⑧ Activates/deactivates synchronization (▷ page 97)
- ⑨ Activates/deactivates air-recirculation mode manually (▷ page 98)
- ⑩ Switches cooling with air dehumidification on/off (▷ page 95)
- ⑪ Sets the temperature, right (▷ page 96)

## Optimum use of dual-zone automatic climate control

### Dual-zone automatic climate control

The following contains instructions and recommendations to enable you to get the most out of your dual-zone automatic climate control:

- Activate climate control using the **AUTO** rocker switch. The indicator lamp above the **AUTO** rocker switch lights up. The "Cooling with air dehumidification" function is not activated automatically in automatic mode. If necessary, activate this function (▷ page 95).
- Set the temperature to 72 °F (22 °C).
- Only use the "Windshield defrosting" function briefly until the windshield is clear again.
- Only use air-recirculation mode briefly, e.g. if there are unpleasant outside odors or when in a tunnel. The windows could otherwise fog up, since no fresh air is drawn into the vehicle in air-recirculation mode.

### ECO start/stop function

During automatic engine switch-off, the climate control system only operates at a reduced capacity. If you require the full climate control output, you can switch off the ECO start/stop function by pressing the ECO button (▷ page 105).

## Operating the climate control systems

### Switching climate control on/off

#### General notes

When the climate control is switched off, the air supply and air circulation are also switched off.

The windows could fog up. Therefore, switch off climate control only briefly

Switch on climate control primarily using the **AUTO** rocker switch (▷ page 96).

#### Activating/deactivating

- ▶ Select key position **2** with the Start/Stop button (▷ page 102).
- ▶ **To switch on:** set the airflow to level **1** or higher using the **1** rocker switch.
- ▶ **To switch off:** set the airflow to level **0** using the **0** rocker switch.

#### Activating/deactivating cooling with air dehumidification

#### General notes

If you deactivate the "Cooling with air-dehumidification" function, the air inside the vehicle will not be cooled. The air inside the vehicle will also not be dehumidified. The windows can fog up more quickly. Therefore, deactivate the cooling with air-dehumidification function only briefly.

The "Cooling with air dehumidification" function is only available when the engine is running. The air inside the vehicle is cooled and dehumidified according to the temperature selected.

Condensation may drip from the underside of the vehicle when it is in cooling mode. This is normal and not a sign that there is a malfunction.

#### Activating/deactivating

- ▶ Press the **A/C** rocker switch up or down. The indicator lamp above the **A/C** rocker switch lights up or goes out.

## Problems with the "Cooling with air dehumidification" function

| Problem   | Possible causes/consequences and ► Solutions   |
|---|--|
| The indicator lamp over the  rocker switch flashes three times or remains off. The cooling with air dehumidification function cannot be activated via the multimedia system any longer (▷ page 203). | Cooling with air dehumidification has been deactivated due to a malfunction.<br>► Visit a qualified specialist workshop. |







### Setting climate control to automatic



#### General notes

In automatic mode, the set temperature is maintained automatically at a constant level. The system automatically regulates the temperature of the dispensed air, the airflow and the air distribution.

During automatic controlling, the "Cooling with air dehumidification" function is activated.



#### Automatic control

- Select key position  with the Start/Stop button (▷ page 102).
- **To activate:** press rocker switch  up or down.  
The indicator lamp above the  rocker switch lights up.
- Set the desired temperature using the  rocker switch.
- **To switch to manual operation:** press the  rocker switch up or down.  
or
- Press the upper or lower section of the  rocker switch.  
The indicator lamp above the  rocker switch goes out.

In automatic mode, if you adjust the airflow or air distribution manually, the indicator lamp above the  rocker switch goes out. The function which has not been changed manually, however, continues to be controlled automatically. When the manually set function switches back to automatic mode, the indicator lamp above the  rocker switch lights up again.

### Setting the temperature







Different temperatures can be set for the driver's and front-passenger sides.

- Select key position  with the Start/Stop button (▷ page 102).
- **To increase or reduce:** press the  rocker switch up or down.



Only change the temperature setting in small increments. Start at 72 °F (22 °C).

### Setting the air distribution

#### Air distribution settings

-  Directs air through the defroster vents
-  Directs air through the center and side air vents
-  Directs air through the footwell air vents
-  Directs air through the center, side and footwell vents
-  Directs air through the defroster, center, side and footwell vents
-  Directs air through the defroster, center and side air vents
-  Directs air through the defroster and footwell vents

#### Setting

- Select key position  with the Start/Stop button (▷ page 102).
- Press the  rocker switch up or down.  
The various air distribution settings appear in the multimedia system.



### Setting the airflow

- ▶ Select key position **2** with the Start/Stop button (▷ page 102).
- ▶ **To increase or reduce:** press the  rocker switch up or down.

### Switching the synchronization function on/off

#### General notes

Climate control can be set centrally using the synchronization function. The temperature setting is adopted for the front-passenger side.

#### Activating/deactivating

- ▶ Press the **SYNC** rocker switch up or down. The indicator lamp above the **SYNC** rocker switch lights up or goes out.

The synchronization function deactivates if the settings for the front-passenger side are changed.



### Defrosting the windshield

#### General notes

You can use this function to defrost the windshield or to clear a fogged up windshield and side windows.



Switch off the "Windshield defrosting" function as soon as the windshield is clear again.

#### Activating/deactivating

- ▶ Select key position **2** with the Start/Stop button (▷ page 102).
- ▶ **To switch on:** press the  rocker switch up or down. The indicator lamp above the  rocker switch lights up. The current climate control settings are deactivated. The climate control system switches to the following functions:
  - high airflow
  - high temperature



- air distribution to the windshield and front side windows
- air-recirculation mode off

**i** If necessary, the "Cooling with air dehumidification" function is activated. In this case, the indicator lamp above the  rocker switch remains switched off.

- ▶ **To switch off:** press the  rocker switch up or down. The indicator lamp above the  rocker switch goes out. The previously selected settings are restored. Air-recirculation mode remains deactivated.

### Defrosting the windows

#### Windows fogged up on the inside

- ▶ Activate the "Cooling with air dehumidification" function with the  rocker switch.
- ▶ Switch on automatic mode using the **AUTO** rocker switch.
- ▶ If the windows continue to fog up, activate the "Windshield defrosting" function using the  rocker switch.

**i** You should only select this setting until the windshield is clear again.

#### Windows fogged up on the outside

- ▶ Activate the windshield wipers.
- ▶ Switch on automatic mode using the **AUTO** rocker switch.

**i** If you clean the windows regularly, they do not fog up so quickly.



### Rear window defroster

#### General notes

The rear window defroster has a high current draw. You should therefore switch it off as soon as the rear window is clear. Otherwise, the rear window defroster switches off automatically after several minutes.

If the battery voltage is too low, the rear window defroster may switch off.

### Activating/deactivating

- ▶ Select key position **2** with the Start/Stop button (▷ page 102).
- ▶ Press the  rocker switch up or down. The indicator lamp above the  rocker switch lights up or goes out.

### Problems with the rear window defroster

| Problem   | Possible causes/consequences and ► Solutions   |
|---|--|
| The rear window defroster has deactivated prematurely or cannot be activated. | <p>The battery has not been sufficiently charged.</p> <ul style="list-style-type: none"> <li>▶ Switch off any consumers that are not required, e.g. reading lamps, interior lighting or the seat heating. When the battery is sufficiently charged, the rear window defroster can be activated again.</li> </ul> |



### Activating/deactivating air-recirculation mode

#### General notes

You can also temporarily deactivate the flow of fresh air manually if unpleasant odors are entering the vehicle from outside. The air already inside the vehicle will then be recirculated.

If you switch on air-recirculation mode, the windows can fog up more quickly, in particular at low temperatures. Only use air-recirculation mode briefly to prevent the windows from fogging up.



#### Activating/deactivating

- ▶ Select key position **2** with the Start/Stop button (▷ page 102).
- ▶ **To activate:** press the  rocker switch up or down. The indicator lamp above the  rocker switch lights up.

Air-recirculation mode switches on automatically:

- at high outside temperatures
- in a tunnel (vehicles with a navigation system only)

The indicator lamp above the  rocker switch is not lit when automatic air-recirculation mode is activated. Outside air is added after about 30 minutes.

- ▶ **To deactivate:** press the  rocker switch up or down. The indicator lamp above the  rocker switch goes out.

Air-recirculation mode deactivates automatically:

- after approximately five minutes at outside temperatures below approximately 41 °F (5 °C)
- after approximately five minutes if cooling with air dehumidification is deactivated
- after approximately 30 minutes at outside temperatures above approximately 41 °F (5 °C) if the "Cooling with air dehumidification" function is activated

### Air vents

#### Important safety notes

#### WARNING

Very hot or very cold air can flow from the air vents. This could result in burns or frostbite in the immediate vicinity of the air vents. There is a risk of injury.

Make sure that all vehicle occupants always maintain a sufficient distance to the air outlets. If necessary, redirect the airflow to another area of the vehicle interior.

In order to ensure the direct flow of fresh air through the air vents into the vehicle interior, please observe the following notes:

- keep the air inlet between the windshield and the hood free of blockages, such as ice, snow or leaves.
- never cover the air vents or air intake grilles in the vehicle interior.

### Setting the air vents

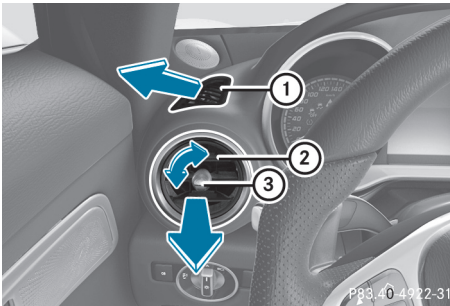

Side air vent (example)

- ① Side window defroster vent
- ② Side air vent, left
- ③ Control for left side air vent

- ▶ **To open or close:** turn thumbwheel ③ to the left or right as far as it will go.
- ▶ **To adjust the air direction:** hold side air vent ② in the center and move it up or down or to the left or right.

### Notes on breaking-in a new vehicle

#### Important safety notes

The sensor system of some driving and driving safety systems adjusts automatically while a certain distance is being driven after the vehicle has been delivered or after repairs. Full system effectiveness is not reached until the end of this teach-in procedure.

New and replaced brake pads and discs only reach their optimum braking effect after several hundred kilometers of driving. Compensate for this by applying greater force to the brake pedal.

#### The first 1000 miles (1500 km)

The more you look after the engine when it is new, the more satisfied you will be with its performance in the future.

- You should therefore drive at varying vehicle and engine speeds for the first 1000 miles (1500 km).
- Ideally, for the first 1,000 miles (1,500 km), drive in program **C**.
- Do not drive faster than 85 mph (140 km/h) for the first 1,000 miles (1,500 km).
- Only briefly allow the engine to reach a maximum engine speed of 4,500 rpm briefly.
- Avoid heavy loads, e.g. driving at full throttle, during this period.
- Do not exceed  $\frac{2}{3}$  of the maximum permitted engine speed for each gear.
- Shift up into manual mode **M** and temporary manual drive program in good time.
- Do not carry out a RACE START.
- Do not manually shift to a lower gear to brake the vehicle.
- Try to avoid depressing the accelerator pedal beyond the pressure point (kickdown).

After 1000 miles (1500 km), you can increase the engine speed gradually and accelerate the vehicle to full speed.

You should also observe these notes on breaking in if the engine or parts of the drive train on your vehicle have been replaced.

Always observe the respective maximum permissible speed.

### Driving

#### Important safety notes

##### WARNING

Objects in the driver's footwell can restrict the pedal travel or obstruct a depressed pedal. The operating and road safety of the vehicle is jeopardized. There is a risk of an accident.

Make sure that all objects in the vehicle are stowed correctly, and that they cannot enter the driver's footwell. Install the floormats securely and as specified in order to ensure sufficient clearance for the pedals. Do not use loose floormats and do not place floormats on top of one another.

##### WARNING

Unsuitable footwear can hinder correct usage of the pedals, e.g.:

- shoes with thick soles
- shoes with high heels
- slippers

There is a risk of an accident.

Wear suitable footwear to ensure correct usage of the pedals.

##### WARNING

If you switch off the ignition while driving, safety-relevant functions are only available with limitations, or not at all. This could affect, for example, the power steering and the brake boosting effect. You will require considerably more effort to steer and brake. There is a risk of an accident.

Do not switch off the ignition while driving.

##### WARNING

If the parking brake has not been fully released when driving, the parking brake can:

- overheat and cause a fire
- lose its hold function.

There is a risk of fire and an accident. Release the parking brake fully before driving off.

**!** Do not warm up the engine with the vehicle stationary. Drive off immediately. Avoid high engine speeds and driving at full throttle until the engine has reached its operating temperature.

Only shift the automatic transmission to the desired drive position when the vehicle is stationary.

Where possible, avoid spinning the drive wheels when pulling away on slippery roads. You could otherwise damage the drive train.

**!** During a cold start with low engine oil temperatures (below 32 °F) (0 °C), the maximum engine speed is restricted in order to protect the engine. To protect the engine and maintain smooth engine operation, avoid driving at full throttle when the engine is cold.

## Key positions

### Start/Stop button

#### General notes

All vehicles are equipped with a Start/Stop button.

The Start/Stop button is located in the center console and is illuminated when the vehicle is unlocked.

The SmartKey must be in the vehicle.

Pressing the Start/Stop button several times in succession corresponds to the different SmartKey positions in the ignition lock. This is only the case if you are not depressing the brake pedal.

If you depress the brake pedal and press the Start/Stop button, the engine starts immediately.

A check which periodically establishes a radio connection between the vehicle and the SmartKey determines whether a valid SmartKey is in the vehicle. This occurs, for example, when starting the engine.

If there is a SmartKey in the ignition lock, this takes precedence over the KEYLESS-GO start function.

To start the vehicle without actively using the SmartKey:

- the SmartKey must be in the vehicle.
- the vehicle must not be locked with the SmartKey or KEYLESS-GO (▷ page 65).

Do not keep the SmartKey:

- with electronic devices, e.g. a mobile phone or another SmartKey.
- with metallic objects, e.g. coins or metal foil.
- inside metallic objects, e.g. a metal case.

This can affect the functionality of the SmartKey.

If you lock the vehicle with the SmartKey remote control or with KEYLESS-GO, after a short time:

- you will not be able to switch on the ignition with the Start/Stop button.
- you will not be able to start the engine with the Start/Stop button until the vehicle is unlocked again.

If you lock the vehicle centrally using the button on the driver's door (▷ page 70), you can continue to start the engine with the Start/Stop button.

The engine can be switched off while the vehicle is in motion by pressing and holding the Start/Stop button for three seconds. This function operates independently of the ECO start/stop automatic engine switch-off function.

### Key positions with the Start/Stop button

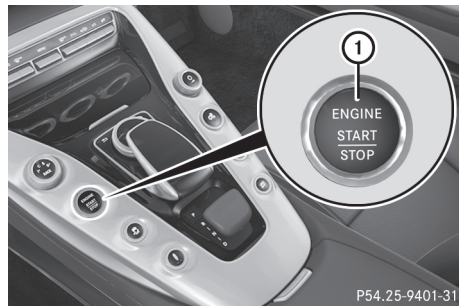

As soon as the ignition is switched on, all the indicator lamps in the instrument cluster light up. Further information on situations where an indicator lamp either fails to go out after starting the engine or lights up while driving (▷ page 190).

If Start/Stop button ① has not yet been pressed, this corresponds to the SmartKey being removed from the ignition.

- **To switch on the power supply:** press Start/Stop button ① once.  
The power supply is switched on. You can now activate the windshield wipers, for example.

The power supply is switched off again if:

- the driver's door is opened and
- you press Start/Stop button ① twice when in this key position

- **To switch on the ignition:** press Start/Stop button ① twice.  
The ignition is switched on.

If you press Start/Stop button ① once when in this position, the ignition is deactivated again.

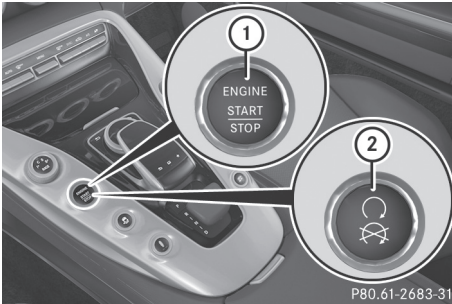

- ① Start/Stop button USA
- ② Start/Stop button Canada

### SmartKey

You can also start the vehicle with the SmartKey in the ignition lock.

The ignition lock is located in the rear storage space of the center console.

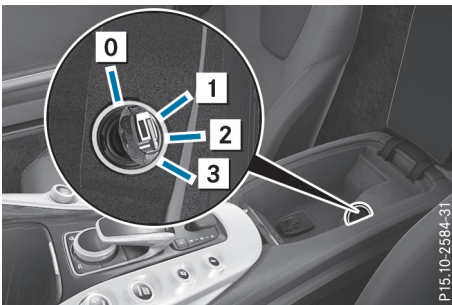

- 0 To remove the SmartKey
- 1 Power supply for some consumers, such as the windshield wipers

- 2 Ignition (power supply for all consumers) and drive position
- 3 To start the engine

- ❗ The SmartKey can be turned in the ignition lock even if it is not the correct SmartKey for the vehicle. The ignition is not switched on. The engine cannot be started.

### Starting the engine

#### Important safety notes

##### ⚠ WARNING

If children are left unsupervised in the vehicle, they could:

- open the doors, thus endangering other people or road users.
- get out and disrupt traffic.
- operate the vehicle's equipment.

Additionally, children could set the vehicle in motion if, for example, they:

- release the parking brake.
- shifting the automatic transmission out of park position **P**
- Start the engine.

There is a risk of an accident and injury.

When leaving the vehicle, always take the SmartKey with you and lock the vehicle. Never leave children or animals unattended in the vehicle. Always keep the SmartKey out of reach of children.

##### ⚠ WARNING

Combustion engines emit poisonous exhaust gases such as carbon monoxide. Inhaling these exhaust gases leads to poisoning. There is a risk of fatal injury. Therefore never leave the engine running in enclosed spaces without sufficient ventilation.

##### ⚠ WARNING

Flammable materials introduced through environmental influence or by animals can ignite if in contact with the exhaust system or

parts of the engine that heat up. There is a risk of fire.

Carry out regular checks to make sure that there are no flammable foreign materials in the engine compartment or in the exhaust system.

### General notes

The catalytic converter is preheated for up to 30 seconds after a cold start. The sound of the engine may change during this time.

### AMG SPEEDSHIFT DCT 7-speed sport transmission

- ▶ Shift the transmission to position **P** (▷ page 108).  
The transmission position indicator on the multifunction display shows **P** (▷ page 110).

You can start the engine in transmission position **P** and **N**.

### Starting procedure with the Start/Stop button

The Start/Stop button can be used to start the vehicle manually without inserting the SmartKey into the ignition lock. You merely need to carry the SmartKey on your person. This mode for starting the engine operates independently of the ECO start/stop automatic engine start function.

You can start the engine if a valid SmartKey is in the vehicle. Switch off the engine and always take the SmartKey with you when leaving the vehicle, even if you only leave it for a short time. Pay attention to the important safety notes.

- ▶ Depress the brake pedal and keep it depressed.
- ▶ Press the Start/Stop button once (▷ page 101).  
The engine starts.

### Starting procedure with the SmartKey

- ▶ Turn the SmartKey to position **3** in the ignition lock (▷ page 102) and release it as soon as the engine is running.

If the engine will not start:

- ▶ Remove the SmartKey from the ignition lock.
- ▶ Reinsert the SmartKey into the ignition lock after a short waiting period.
- ▶ Turn the SmartKey to position **2** in the ignition lock (▷ page 102).  
The indicator lamps in the instrument cluster light up (▷ page 188).
- ▶ Turn the SmartKey to position **3** in the ignition lock (▷ page 102) and release it as soon as the engine is running.

### Pulling away

#### General notes

#### WARNING

If the engine speed is above the idling speed and you engage transmission position **D** or **R**, the vehicle could pull away suddenly. There is a risk of an accident.

When engaging transmission position **D** or **R**, always firmly depress the brake pedal and do not simultaneously accelerate.

Depress the accelerator carefully when pulling away.

The vehicle locks centrally once you have pulled away. The locking knobs in the doors drop down. You can open the doors from the inside at any time.

You can also deactivate the automatic locking feature (▷ page 70).

It is only possible to shift the transmission from position **P** to the desired position if:

- the engine is running and
- you depress the brake pedal

If you do not depress the brake pedal, the E-SELECT lever can still be moved but the parking lock remains engaged.

Information on the automatic release of the electric parking brake (▷ page 121).

### Hill start assist

Hill start assist helps you when pulling away forward or in reverse on an uphill gradient. It holds the vehicle for a short time after you have removed your foot from the brake pedal. This



gives you enough time to move your foot from the brake pedal to the accelerator pedal and to depress it before the vehicle begins to roll.

#### WARNING

After a short time, hill start assist will no longer brake your vehicle and it could roll away. There is a risk of an accident and injury.

Therefore, quickly move your foot from the brake pedal to the accelerator pedal. Never leave the vehicle when it is held by hill start assist.

Hill start assist is not active if:

- you are pulling away on a level road or on a downhill gradient
- the transmission is in position **N**
- the electric parking brake is applied
- ESP® is malfunctioning

### Rear axle steering

#### General notes

Depending on the speed, rear axle steering adapts the track of the rear axle to the position of the front wheels. Together with the steering angle of the front wheels, this results in greater mobility and stability than on vehicles without rear axle steering.

Rear axle steering has the following characteristics:

- reduced steering effort and turning circle, resulting in reduced parking effort.
- improved driving stability, e.g. on curves.
- the vehicle has more direct steering. Control of the vehicle is thereby increased.

### ECO start/stop function

#### Introduction

The ECO start/stop function switches the engine off automatically if the vehicle is stopped under certain conditions.

The engine starts automatically when the driver wants to pull away again. The ECO start/stop function thereby helps you to reduce the fuel consumption and emissions of your vehicle.

### Important safety notes

#### WARNING

If the engine is switched off automatically and you exit the vehicle, the engine is restarted automatically. The vehicle may begin moving. There is a risk of accident and injury.

If you wish to exit the vehicle, always turn off the ignition and secure the vehicle against rolling away.

### General notes



#### ① ECO start/stop display

If the engine has been switched off automatically by the ECO start/stop function, the **(A)** ECO symbol is shown in the multifunction display.

The ECO start/stop function is only available in drive program **C**.

The ECO start/stop function is activated whenever you switch on the engine using the SmartKey or the Start/Stop button. This is the case if:

- the ignition was switched off for more than four hours or
- the ECO start/stop function had been activated before the engine was switched off

### Automatic engine switch-off

The ECO start/stop function switches the engine off automatically if:

- the ECO start/stop function is activated (> page 105) and
- you brake the vehicle to a standstill in transmission position **D**

The ECO start/stop function is operational when:

- the indicator lamp in the ECO button is lit green
- the outside temperature and the atmospheric air pressure is within the range that is suitable for the system

- the engine and the transmission are at a sufficient temperature for the ECO start/stop function
- the set temperature for the vehicle interior has been reached
- the battery is sufficiently charged
- the system detects that the windshield is not fogged up when the air-conditioning system is switched on
- the hood is closed
- the driver's door is closed and the driver's seat belt is fastened

All of the vehicle's systems remain active when the engine is stopped automatically.

The HOLD function can also be activated if the engine has been switched off automatically. It is then not necessary to continue applying the brakes during the automatic stop phase. When you depress the accelerator pedal, the engine starts automatically and the braking effect of the HOLD function is deactivated.

### Automatic engine start

The engine starts automatically if:

- you switch off the ECO start/stop function by pressing the ECO button
  - switch to drive program **RACE, S+ or S** (> page 107)
  - you switch to manual mode **M** (> page 112)
  - in transmission position **D**, the brake pedal is released and the HOLD function is not active
  - you depress the accelerator pedal
  - you engage reverse gear **R**
  - you move the transmission out of position **P**
  - you unfasten your seat belt or open the driver's door
  - the vehicle starts to roll
  - the brake system requires this
  - the temperature in the vehicle interior deviates from the set range
  - the system detects moisture on the windshield when the air-conditioning system is switched on
  - the battery's condition of charge is too low
- Shifting the transmission to position **P** does not start the engine.

### Deactivating or activating the ECO start/stop function



► **To deactivate:** press ECO button ①. Indicator lamp ② goes out.

► **To activate:** press ECO button ①. Indicator lamp ② lights up.

If indicator lamp ② is off, the ECO start/stop function has been deactivated manually or as the result of a malfunction. The engine will then not be switched off automatically when the vehicle stops.

The ECO start/stop function is deactivated, if:

- switch to drive program **RACE, S+ or S** (> page 107)
- you switch to manual mode **M** (> page 112)

### AMG sports exhaust system

You can choose between different AMG sports exhaust system volumes using the position of the exhaust flap.

Each time you start the engine with the Smart-Key or the Start/Stop button, the quietest setting is activated.



Setting the volume:

- ▶ Press button ①.
- If you select the loudest setting, indicator lamp ② lights up.

You can also adjust the position of the exhaust flap using the:

- DYNAMIC SELECT controller (▷ page 107)
- Multimedia system

### Problems with the engine

| Problem   | Possible causes/consequences and ▶ Solutions   |
|---|--|
| The engine does not start.                                    | <p>The HOLD function or Distance Pilot DISTRONIC is activated.</p> <ul style="list-style-type: none"> <li>▶ Deactivate the HOLD function (▷ page 135) or Distance Pilot DISTRONIC (▷ page 127).</li> <li>▶ Try to start the engine again (▷ page 102).</li> </ul>  |
| The engine does not start. The starter motor can be heard.    | <ul style="list-style-type: none"> <li>• There is a malfunction in the engine electronics.</li> <li>• There is a malfunction in the fuel supply.</li> </ul> <p>Before attempting to start the engine again:</p> <ul style="list-style-type: none"> <li>▶ Press the Start/Stop button repeatedly until all indicator lamps in the instrument cluster go out.</li> </ul> <p>or</p> <ul style="list-style-type: none"> <li>▶ Turn the SmartKey back to key position <b>0</b> in the ignition lock.</li> <li>▶ Try to start the engine again (▷ page 102). Avoid excessively long and frequent attempts to start the engine as these will drain the battery.</li> </ul> <p>If the engine does not start after several attempts:</p> <ul style="list-style-type: none"> <li>▶ Consult a qualified specialist workshop.</li> </ul> |
| The engine does not start. You cannot hear the starter motor. | <p>The on-board voltage is too low because the battery is too weak or discharged.</p> <ul style="list-style-type: none"> <li>▶ Jump-start the vehicle (▷ page 245).</li> </ul> <p>If the engine does not start despite attempts to jump-start it:</p> <ul style="list-style-type: none"> <li>▶ Consult a qualified specialist workshop.</li> </ul> <p>The starter motor was exposed to a thermal load that was too high.</p> <ul style="list-style-type: none"> <li>▶ Try to start the engine again (▷ page 102).</li> </ul> <p>If the engine still does not start:</p> <ul style="list-style-type: none"> <li>▶ Consult a qualified specialist workshop.</li> </ul>   |

| Problem  | Possible causes/consequences and ► Solutions   |
|--|--|
| The engine is not running smoothly and is misfiring.               | <p>There is a malfunction in the engine electronics or in a mechanical component of the engine management system.</p> <ul style="list-style-type: none"> <li>► Only depress the accelerator pedal slightly. Otherwise, non-combusted fuel may get into the catalytic converter and damage it.</li> <li>► Have the cause rectified immediately at a qualified specialist workshop.</li> </ul> |
| The coolant temperature gauge shows a value above 248 °F (120 °C). | <p>The coolant level is too low. The coolant is too hot and the engine is no longer being cooled sufficiently.</p> <ul style="list-style-type: none"> <li>► Stop as soon as possible and allow the engine and the coolant to cool down.</li> <li>► Check the coolant level (► page 230). Observe the warning notes as you do so and add coolant if necessary.</li> </ul>                     |

**DYNAMIC SELECT controller**

**General information**

Select the drive program using the DYNAMIC SELECT controller.

**Available drive programs:**

|                      |  |
|----------------------|--|
| <b>C</b> Comfort     | Comfort-oriented, optimum-economy engine and transmission settings                 |
| <b>S</b> Sport       | Sporty engine and transmission settings  |
| <b>S+</b> Sport Plus | Especially sporty engine and transmission settings                                 |
| <b>Race</b>          | Maximum sportiness and engine and transmission settings suitable for the racetrack |
| <b>I</b> Individual  | Individual settings  |

Depending on the drive program selected the following vehicle characteristics will change:

- the drive (engine management)
- the transmission management
- ESP® (► page 59)
- the suspension (► page 138)
- the position of the exhaust flap (► page 105)

- the availability of the ECO start/stop function (► page 104)
- the availability of gliding mode (► page 111)

Further information for automatic drive program characteristics (► page 113).

Additionally, in drive program I you can configure the respective vehicle characteristics using the multimedia system. You can find information about this in the Digital Operator's Manual.

Each time you start the engine with the Smart-Key or the Start/Stop button, drive program **C** is activated. For further information about starting the engine, see (► page 102).

**Selecting the drive program**



P27.60-3713-31

- ▶ Turn DYNAMIC SELECT controller ① until the desired drive program is selected. The selected drive program appears in the multifunction display. After five seconds the display goes out and the symbol of the selected drive program appears. The drive program indicator on DYNAMIC SELECT controller ① lights up in red. In addition, the current drive program settings are displayed in the multimedia system display.

### Additional settings

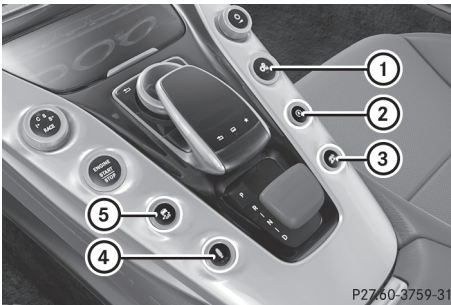

- ① Manual mode (▷ page 114)
- ② ECO start/stop function (▷ page 104)
- ③ Position of the exhaust flap (▷ page 105)
- ④ Suspension (▷ page 138)
- ⑤ ESP® (▷ page 59)

When you press buttons ① - ⑤ the corresponding setting is selected. The DYNAMIC SELECT controller setting is overwritten.

These settings will also be maintained for manual mode and ESP® if you switch to drive program **RACE**, **S+**, **S** or **C** using the DYNAMIC SELECT controller.

If you switch to drive program **I**, all stored characteristics will be accepted. This is also the case if you have previously pressed one of buttons ① - ⑤. If you then change the drive program using the DYNAMIC SELECT controller, the standard setting for the drive program is selected.

### AMG SPEEDSHIFT DCT 7-speed sports transmission

#### Important safety notes

##### ⚠ WARNING

If the engine speed is above the idling speed and you engage transmission position **D** or **R**, the vehicle could pull away suddenly. There is a risk of an accident.

When engaging transmission position **D** or **R**, always firmly depress the brake pedal and do not simultaneously accelerate.

##### ⚠ WARNING

The automatic transmission switches to neutral position **N** when you switch off the engine. The vehicle may roll away. There is a risk of an accident.

After switching off the engine, always switch to parking position **P**. Prevent the parked vehicle from rolling away by applying the parking brake.

### E-SELECT selector lever

#### General notes

- ⚠ If the engine speed is too high or the vehicle is in motion, do not shift the automatic transmission directly from **D** to **R**, from **R** to **D** or directly to **P**.

Do not open the driver's door while the vehicle is in motion. At low speeds in transmission position **D** or **R**, otherwise park position **P** is engaged automatically.

The transmission could be damaged.

- ⚠ If you want to engage a transmission position or to exit park position **P**, the engine must be running.

The E-SELECT lever always returns to its original position.

The current transmission position **P**, **R**, **N** or **D** is shown in the transmission position display in the multifunction display.

**Overview of transmission positions**

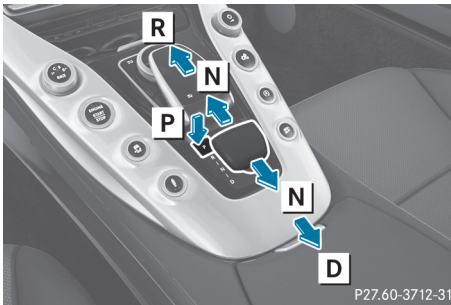

P27.60-3712-31

- P** Park position with parking lock
- R** Reverse gear
- N** Neutral
- D** Drive

**Engaging park position P**



P27.60-3724-31

- ▶ When the vehicle is stationary, depress the brake pedal.
- ▶ Press button ①.

Shifting directly from **P** to **R**:

- ▶ Start the engine (> page 103).
- ▶ Depress the brake pedal and push the E-SELECT lever forwards past the first point of resistance.

Shifting directly from **P** to **D**:

- ▶ Start the engine (> page 103).
- ▶ Depress the brake pedal and push the E-SELECT lever backwards past the first point of resistance.

To release park position **P**:

- depress the brake pedal and
- push the E-SELECT lever forwards or back to the first point of resistance

The transmission shifts to neutral **N**.

**Engaging park position P automatically**

Park position **P** is engaged automatically in the following circumstances:

- if you switch off the engine using the Start/Stop button and open the driver's or front-passenger door.
- if you remove the SmartKey from the ignition lock.
- if you open the driver's door while traveling at low speeds in transmission position **D** or **R**.

Under certain conditions, the automatic transmission shifts automatically to transmission position **P** if the HOLD function or Distance Pilot DISTRONIC is activated. Observe the information on the HOLD function (> page 136) and Distance Pilot DISTRONIC (> page 131).

**Engaging reverse gear R**

- ▶ Start the engine (> page 103).
- ▶ When the vehicle is stationary, depress the brake pedal.
- ▶ Push the E-SELECT lever forwards past the first point of resistance.

**Shifting to neutral N**

- ▶ Start the engine (> page 103).
- ▶ When the vehicle is stationary, depress the brake pedal.
- ▶ Push the E-SELECT lever forwards or back to the first point of resistance.

If you move the E-SELECT lever to **N** before switching off the engine, the transmission remains in **N** for approximately 30 minutes. If you open the driver's or front-passenger door during this time, the transmission shifts automatically to **P**.

The transmission remains in **N** if:

- the SmartKey is in the ignition lock and
- you use the E-SELECT lever to shift the transmission to **N** before switching the engine off

This still applies if you open the driver's or front-passenger door.

You can find further information under "Car wash" (> page 233).



### Shifting to transmission position D

- ▶ Start the engine (▷ page 103).
- ▶ When the vehicle is stationary, depress the brake pedal.
- ▶ Push the E-SELECT lever back past the first point of resistance.

### Transmission position and drive program display

The current transmission position and drive program appear in the multifunction display.

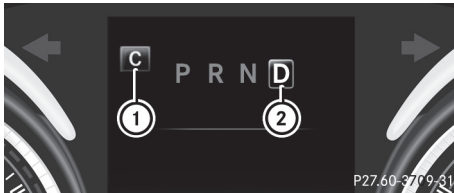

- ① Drive program
- ② Transmission position

Additionally, displays next to the E-SELECT lever show the current transmission position.

The displays light up if you:

- switch on the power supply with the Start/ Stop button (▷ page 101) or
- insert the SmartKey into the ignition lock (▷ page 102).

The displays go out if you:

- switch off the power supply with the Start/ Stop button (▷ page 101) or
- remove the SmartKey from the ignition lock (▷ page 102).

If the transmission position display in the multifunction display is not working, check on the display next to the E-SELECT lever whether the desired transmission position is engaged.

### Transmission positions

#### **P** Park position

This prevents the vehicle from rolling away when stopped.

Only shift the transmission into position **P** (▷ page 108) when the vehicle is stationary. The parking lock should not be used as a brake when parking. Always apply the electronic parking brake in addition to the parking lock in order to secure the vehicle.

The automatic transmission shifts to **P** automatically if you:

- remove the SmartKey
- switch off the engine when in **R** or **D** and open the driver's door or front-passenger door
- open the driver's door while traveling at low speeds in transmission position **D** or **R**

In the event of a malfunction of the vehicle's electronics, the transmission may lock in position **P**. Have the vehicle electronics checked immediately at a qualified specialist workshop.

#### **R** Reverse gear

Only shift the transmission into position **R** when the vehicle is stationary.



**N Neutral**

Do not shift the transmission to **N** while driving. The automatic transmission could otherwise be damaged.

No power is transmitted from the engine to the drive wheels.

Releasing the brakes will allow you to move the vehicle freely, e.g. to push it or tow it.

If ESP® is deactivated or faulty: shift the transmission to position **N** if the vehicle is in danger of skidding, e.g. on icy roads.

If you switch off the engine using the SmartKey or the Start/Stop button, the automatic transmission shifts to neutral **N** automatically.

**!** Coasting in neutral **N** may cause damage to the drive train.

**D Drive**

The automatic transmission changes gear automatically in the automatic drive programs (> page 113). All forward gears are available.

**Driving tips****Changing gear**

The automatic transmission shifts through the individual gears automatically when it is in transmission position **D**. This automatic gear shifting behavior is determined by:

- the selected drive program (> page 107)
- the position of the accelerator pedal
- the road speed

**Accelerator pedal position**

Your style of driving influences how the automatic transmission shifts gear:

- little throttle: early upshifts
- more throttle: late upshifts

A dynamic driving style with high longitudinal and lateral acceleration delays the shift points to higher engine speeds.

**Double-clutch function**

When shifting down, the double-clutch function is active regardless of the currently selected drive program. The double-clutch function reduces load change reactions and is conducive to a sporty driving style. The sound generated by the double-clutch function depends on the drive program selected.

**Kickdown**

Use kickdown for maximum acceleration.

- ▶ In the automatic drive programs, depress the accelerator pedal beyond the pressure point. Depending on the engine speed and the selected drive program, the automatic transmission shifts to the lowest gear permissible to give optimal acceleration.
- ▶ Ease off the accelerator pedal once the desired speed is reached. The automatic transmission shifts back up.

Kickdown is not available in manual mode **M**.

**Rocking the vehicle free**

Rocking the vehicle free may help to free the vehicle if it has become stuck in slush or snow. To do so, shift back and forth repeatedly between transmission positions **D** and **R**. The vehicle's transmission management restricts shifting between transmission positions **D** and **R** to speeds up to a maximum of 5 mph (9 km/h).

To shift back and forth between transmission positions **D** and **R**, move the E-SELECT lever up and down beyond the pressure point.

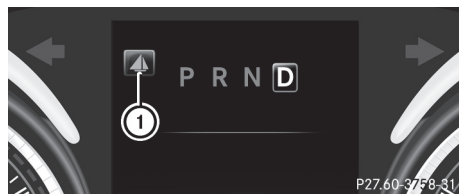
**Gliding mode**

P27.60-3758-31

Gliding mode is characterized by the following:

- The combustion engine is disconnected from the drive train.
- The engine speed corresponds to the idling speed.
- Status icon **C** goes out and status icon ① is displayed in the multifunction display (▷ page 110).

In drive program **C**, you can deactivate and activate gliding mode using the ECO button (▷ page 105).

Gliding mode can be activated under the following conditions:

- The speed is within a suitable range.
- The course of the road is suitable, e.g. there are no steep up or downhill gradients.
- You are no longer depressing the accelerator pedal.

Gliding mode is deactivated under the following conditions:

- You depress the accelerator pedal.
- You depress the brake pedal.
- You switch the transmission position using the E-SELECT lever (▷ page 108).
- You switch to drive program **RACE**, **S+** or **S** (▷ page 107).
- You switch to manual mode **M** (▷ page 112).
- You leave the suitable speed range.

- i** If you have selected the "Comfort" setting for the drive (engine management) in drive program **I**, you can also activate gliding mode. You can find information about this in the Digital Operator's Manual.

### M button



P27.60-3720-31

- ▶ Press M button ①.
- Indicator lamp ② lights up. The letter **M** appears in the multifunction display. Manual mode **M** is activated.

Further information on manual mode **M** (▷ page 114).

In addition to manual mode **M**, you can also activate temporary manual drive program (▷ page 113).

|                 |                                |
|-----------------|--------------------------------|
| <b>M</b> Manual | Permanent manual gear-shifting |
|-----------------|--------------------------------|

Each time you start the engine using the Smart-Key or the Start/Stop button, drive program **C** is activated. For further information about starting the engine, see (▷ page 102).

### Steering wheel paddle shifters

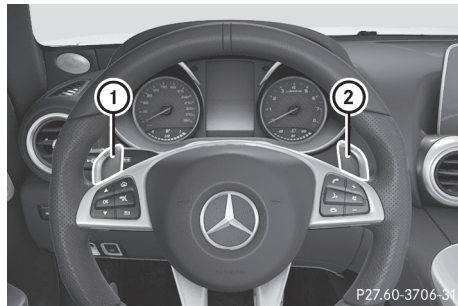

P27.60-3706-31

Using steering wheel paddle shifters ① and ② you can:

- activate the temporary manual drive program and change gear yourself in automatic drive programs (▷ page 113)
- change gear yourself in manual mode **M** (▷ page 114)
- activate RACE START (▷ page 136)

## Automatic drive program

### Drive program C (Comfort)

Drive program **C** is characterized by the following:

- the vehicle delivers comfortable, economical handling characteristics.
- the vehicle pulls away more gently in forward and reverse gears, unless the accelerator pedal is depressed fully.
- the vehicle has improved driving stability, for example on slippery road surfaces.
- optimal fuel consumption resulting from the automatic transmission shifting up sooner. The vehicle is driven in the low engine speed range and the wheels are less likely to spin.
- gliding mode is available.
- the ECO start/stop function is available.

### Drive program S (Sport)

Drive program **S** is characterized by the following:

- the vehicle exhibits sporty driving characteristics.
- the automatic transmission shifts up later. the fuel consumption possibly being higher as a result of the later automatic transmission shift points.
- the suspension exhibits stiff springing and damping settings.
- gliding mode is not available.
- the ECO start/stop function is not available.
- if a period of dynamic driving is followed by an extended phase with a constant accelerator pedal position, the vehicle shifts up to a higher gear. This optimizes fuel consumption.

### Drive program S+ (Sport Plus)

Drive program **S+** is characterized by the following:

- the vehicle exhibits particularly sporty driving characteristics.
- the automatic transmission shifts up later. the fuel consumption possibly being higher as a result of the later automatic transmission shift points.
- the suspension exhibits particularly hard springing and damping settings.

- gliding mode is not available.
- the ECO start/stop function is not available.
- if a period of dynamic driving is followed by an extended phase with a constant accelerator pedal position, the vehicle shifts up to a higher gear. This optimizes fuel consumption.

### Drive program I (Individual)

In drive program **I** the following properties of the drive program can be selected:

- the drive (engine management)
- the transmission management
- ESP® (▷ page 59)
- the suspension (▷ page 138)
- the position of the exhaust flap (▷ page 105)

Information about configuring drive program **I** with the multimedia system can be found in the Digital Operator's Manual.

### Temporary manual drive program

#### General notes

In this drive program, you can briefly change gear yourself by using the steering wheel paddle shifters. The transmission must be in position **D** to do this.

You can activate the temporary manual drive program in the automatic drive program. The switching times correspond to the previously active automatic drive program.

In addition to temporary manual drive program you can also activate manual mode **M** (▷ page 114).

#### Activating

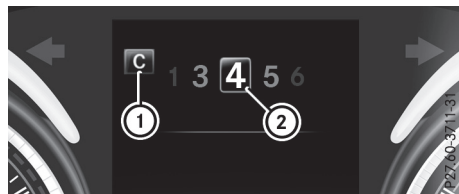

- ▶ Shift the transmission to position **D**.
- ▶ Pull the left or right steering wheel paddle shifter (▷ page 112). Temporary manual drive program is activated. The last active drive program **1** and selected gear **2** appear in the multifunction display.

### Shifting gears

If you pull on the left or right steering wheel paddle shifter, the automatic transmission switches to temporary manual drive program for a limited amount of time. Depending on which steering wheel paddle shifter is pulled, the automatic transmission immediately shifts into the next gear down or up, if permitted.

- ▶ **To shift up:** pull the right-hand steering wheel paddle shifter (▷ page 112).

The automatic transmission shifts up to the next gear.

If the maximum engine speed on the currently engaged gear is reached and you continue to accelerate, the automatic transmission automatically shifts up in order to prevent engine damage.

The automatic transmission will not shift up to the next gear when the engine speed is very low.

- ▶ **To shift down:** pull on the left-hand steering wheel paddle shifter (▷ page 112).

The automatic transmission shifts down to the next gear.

If the engine exceeds the maximum engine speed when shifting down, the automatic transmission protects against engine damage by not shifting down.

Automatic down shifting occurs when coasting.

When using kickdown, the automatic transmission automatically shifts to a lower gear.

### Deactivating

If you have activated temporary manual drive program, it will remain active for a certain amount of time. Under certain conditions, the minimum amount of time is extended, e.g. in the case of lateral acceleration, during overrun mode or when driving on steep terrain.

When temporary manual drive program is deactivated, the automatic transmission shifts into the automatic drive program that was last selected.

You can also deactivate temporary manual drive program yourself:

- ▶ Pull on the right-hand steering wheel paddle shifter and hold it in place (▷ page 112).

or

- ▶ Use the DYNAMIC SELECT controller to change the drive program (▷ page 107). Temporary manual drive program is deactivated. The automatic transmission switches into the automatic drive program that was last selected.

## Manual mode

### General information

In manual mode **M**, you can permanently change gear yourself by using the steering wheel paddle shifters. The transmission must be in position **D** to do this.

The switching times correspond to the previously active automatic drive program.

The transmission only shifts down automatically at low engine speeds depending on the respective gear.

In addition to manual mode **M**, you can also activate temporary manual drive program (▷ page 113).

### Activating

In manual mode **M**, you can change gear yourself using the steering wheel paddle shifters if the transmission is in position **D**. You can see the currently selected drive program and which gear is engaged in the multifunction display.

- ▶ Press the M button (▷ page 112).

**M** is shown in the multifunction display and the indicator lamp on the M button lights up.

### Shift recommendation

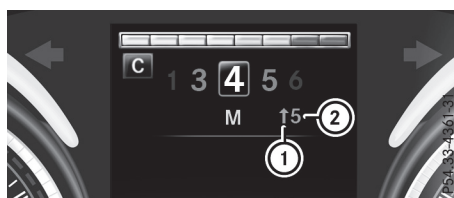

The gearshift recommendations assist you in adopting an economical driving style. The rec-

ommended gear is shown in the multifunction display.

- ▶ When the corresponding gearshift recommendation ① appears in the multifunction display of the instrument cluster, shift to recommended gear ②.

### Display for shift blocked



If the engine speed becomes too high or too low as a result of shifting gear, you cannot shift gear using the steering wheel paddle shifters. If you then pull the left-hand or right-hand steering wheel paddle shifter, segments ① light up red briefly.

- ❗ In drive programs S+ and RACE: if a manual gear downshift is not possible due to the engine speed, segments ① light up red in the multifunction display. If no segments ① light up, it is possible to shift down.

### Downshifting

- ▶ Pull the left-hand steering wheel paddle shifter (▷ page 112). The automatic transmission shifts down to the next gear if this is permissible.
- ▶ **Maximum acceleration:** pull the left-hand steering wheel paddle shifter until the transmission selects the optimum gear for the current speed.

If you slow down or stop without shifting down, the automatic transmission automatically shifts down.

### Deactivating

- ▶ Press the M button (▷ page 112). The indicator lamp in the button goes out.

### RACE drive program

The RACE drive program is designed for maximum performance in terms of shift points and engine speeds. The engine and transmission should be at normal operating temperature for the RACE drive program (▷ page 161). Use the RACE drive program on a closed-off race circuit.

The **RACE** drive program is characterized by the following:

- the vehicle exhibits driving characteristics suitable for the racetrack.
- all vehicle systems are set for maximum sportiness.
- for optimum performance, the transmission shifts up later and shifts down sooner.
- the multifunction display shows the manual gearshift program without upshift indicator (▷ page 113).
- the gearshift recommendation gives you information for slowly warming up the drive assemblies and for adopting a fuel-efficient driving style (▷ page 114). You can follow the gearshift recommendations at all times and shift gear accordingly using the steering wheel paddle shifters. On the basis of the gearshift recommendation, using the steering wheel paddle shifters, you can optimize the drive train and engine operating mode at any time.
- if you have selected a gear manually, this will be maintained until the vehicle speed increases or decreases dramatically.
- if you do not follow the gearshift recommendations, the automatic shift points may result in high fuel consumption.
- the suspension exhibits particularly hard springing and damping settings.
- the transmission shift and response times are significantly shorter with more aggressive gear changes. This is particularly the case when shifting up. The shift strategy is thus designed to interact dynamically with the high-revving engine.
- gliding mode is not available.
- the ECO start/stop function is not available.

### Problems with the transmission

| Problem  | Possible causes/consequences and ► Solutions  |
|--|---|
| The transmission has problems shifting gear.   | There is a malfunction in the transmission.<br>The transmission no longer shifts into the next gear.<br>► Have the transmission checked at a qualified specialist workshop immediately. |
| The acceleration ability is deteriorating.<br>The transmission no longer shifts into all of the gears. | A sub geartrain has failed.<br>The smoothness of the gear change is restricted.<br>► Have the transmission checked at a qualified specialist workshop immediately.                      |

### Refueling

#### Important safety notes

#### WARNING

Fuel is highly flammable. If you handle fuel incorrectly, there is a risk of fire and explosion.

You must avoid fire, open flames, creating sparks and smoking. Switch off the engine and, if applicable, the auxiliary heating before refueling.

#### WARNING

Fuel is poisonous and hazardous to health. There is a risk of injury.

You must make sure that fuel does not come into contact with your skin, eyes or clothing and that it is not swallowed. Do not inhale fuel vapors. Keep fuel away from children.

If you or others come into contact with fuel, observe the following:

- Wash away fuel from skin immediately using soap and water.
- If fuel comes into contact with your eyes, immediately rinse them thoroughly with clean water. Seek medical assistance without delay.

- If fuel is swallowed, seek medical assistance without delay. Do not induce vomiting.
- Immediately change out of clothing which has come into contact with fuel.

#### WARNING

Electrostatic buildup can create sparks and ignite fuel vapors. There is a risk of fire and explosion.

Always touch the vehicle body before opening the fuel filler flap or touching the fuel pump nozzle. Any existing electrostatic buildup is thereby discharged.

Do not get into the vehicle again during the refueling process. Otherwise, electrostatic charge could build up again.

- ❗ Do not use diesel to refuel vehicles with a gasoline engine. Do not switch on the ignition if you accidentally refuel with the wrong fuel. Otherwise, the fuel will enter the fuel system. Even small amounts of the wrong fuel could result in damage to the fuel system and the engine. Notify a qualified specialist workshop and have the fuel tank and fuel lines drained completely.
- ❗ Overfilling the fuel tank could damage the fuel system.
- ❗ Take care not to spill any fuel on painted surfaces. You could otherwise damage the paintwork.

**!** Use a filter when adding fuel from a fuel can. The fuel lines and/or the fuel injection system could otherwise be blocked by particles from the fuel can.

If you overfill the fuel tank, fuel could spray out when the fuel pump nozzle is removed.

For further information on fuel and fuel quality (▷ page 277).

## Refueling

### General information

Pay attention to the important safety notes (▷ page 116).

If you unlock/lock the vehicle from the outside, the fuel filler flap also unlocks/locks.

The position of the fuel filler cap is displayed  in the instrument cluster. The arrow next to the filling pump indicates the side of the vehicle.

### Opening the fuel filler flap

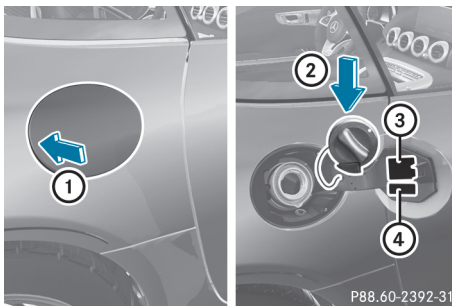

- ① To open the fuel filler flap
- ② To insert the fuel filler cap

- ③ Tire pressure table
- ④ Instruction label for fuel type to be refueled

- ▶ Switch off the engine.
- ▶ Open the driver's door.
  - The vehicle electronics are now in key position [0]. This is the same as the SmartKey having been removed.

or, if the SmartKey is inserted in the ignition lock:

- ▶ Remove the SmartKey from the ignition lock.
- ▶ Press the fuel filler flap in the direction of arrow ①.
  - The fuel filler flap swings up.
- ▶ Turn the fuel filler cap counterclockwise and remove it.
- ▶ Insert the fuel filler cap into the holder on the inside of fuel filler flap ②.
- ▶ Completely insert the filler neck of the fuel pump nozzle into the tank, hook in place and refuel.
- ▶ Only fill the tank until the pump nozzle switches off.

Do not add any more fuel after the pump stops filling for the first time. Otherwise, fuel may leak out.

### Closing the fuel filler flap

- ▶ Replace the cap on the filler neck and turn clockwise until it engages audibly.
- ▶ Close the fuel filler flap.

Close the fuel filler flap before locking the vehicle.

If you are driving with the fuel filler cap open, the  reserve fuel warning lamp flashes. A message appears in the multifunction display (▷ page 179).



## Problems with fuel and the fuel tank

| Problem                                | Possible causes/consequences and ► Solutions  |
|--|---|
| Fuel is leaking from the vehicle.      | <p> <b>WARNING</b></p> <p>The fuel line or the fuel tank is faulty.<br/>Risk of explosion or fire.</p> <ul style="list-style-type: none"> <li>► Apply the electric parking brake.</li> <li>► Switch off the engine.</li> <li>► Open the driver's door.<br/>The vehicle electronics are now in key position <b>0</b>. This is the same as the SmartKey having been removed.</li> </ul> <p>or, if the SmartKey is inserted in the ignition lock:</p> <ul style="list-style-type: none"> <li>► Remove the SmartKey from the ignition lock.</li> <li>► Do not restart the engine under any circumstances.</li> <li>► Consult a qualified specialist workshop.</li> </ul> |
| The fuel filler flap cannot be opened. | <p>The fuel filler flap is not unlocked.</p> <ul style="list-style-type: none"> <li>► Unlock the vehicle (► page 64).</li> </ul>  |
|  | <p>The SmartKey battery is discharged or nearly discharged.</p> <ul style="list-style-type: none"> <li>► Unlock the vehicle using the mechanical key (► page 66).</li> </ul>  |
|  | <p>The fuel filler flap is unlocked, but the opening mechanism is jammed.</p> <ul style="list-style-type: none"> <li>► Consult a qualified specialist workshop.</li> </ul>  |

## Parking

## Important safety notes

 **WARNING**

Flammable material such as leaves, grass or twigs may ignite if they come into contact with hot parts of the exhaust system or exhaust gas flow. There is a risk of fire.

Park the vehicle so that no flammable materials come into contact with parts of the vehicle which are hot. Take particular care not to park on dry grassland or harvested grain fields.

 **WARNING**

If you leave children unsupervised in the vehicle, they could set it in motion by, for example:

- release the parking brake.
- shift the automatic transmission out of the parking position **P**.
- start the engine.

In addition, they may operate vehicle equipment and become trapped. There is a risk of an accident and injury.

When leaving the vehicle, always take the SmartKey with you and lock the vehicle. Never leave children unsupervised in the vehicle.

 If the engine speed is too high or the vehicle is in motion, do not shift the automatic transmission directly from **D** to **R**, from **R** to **D** or directly to **P**.

Do not open the driver's door while the vehicle is in motion. At low speeds in transmission

position **D** or **R**, otherwise park position **P** is engaged automatically.

The transmission could be damaged.

- ❗ Always secure the vehicle correctly against rolling away. Otherwise, the vehicle or its drivetrain could be damaged.

To ensure that the vehicle is secured against rolling away unintentionally:

- the electric parking brake must be applied.
- the transmission must be in position **P**.
- the SmartKey must be removed from the ignition lock or the Start/Stop button must be pressed.
- the front wheels must be turned towards the curb on steep uphill or downhill gradients.
- the empty vehicle must be secured at the front axle with a wheel chock or similar, for example, on uphill or downhill gradients.
- a laden vehicle must also be secured at the rear axle with a wheel chock or similar, for example, on uphill or downhill gradients.

### Switching off the engine

#### Important safety notes

##### WARNING

The automatic transmission switches to neutral position **N** when you switch off the engine. The vehicle may roll away. There is a risk of an accident.

After switching off the engine, always switch to parking position **P**. Prevent the parked vehicle from rolling away by applying the parking brake.

#### AMG SPEEDSHIFT DCT 7-speed sport transmission

- ❗ Do not remove the SmartKey while the vehicle is in motion. Otherwise, at low speeds, parking lock **P** will be activated automatically.

Do not open the driver's door while the vehicle is in motion. At low speeds, transmission position **P** is engaged automatically.

This could cause damage to the transmission and the parking lock.

- ▶ Apply the electric parking brake.
- ▶ Shift the transmission to **P** using the button on the center console.

#### Using the Start/Stop button

- ▶ Press the Start/Stop button (▷ page 101) The engine stops and all the indicator lamps in the instrument cluster go out.

If the driver's door is closed, this is the same as key position **1**. If the driver's door is open, this is the same as key position **0**, i.e. the SmartKey having been removed.

If you switch the engine off with the transmission in position **R** or **D**, the transmission automatically shifts to **N**.

If you move the E-SELECT lever to **N** before switching off the engine, the transmission remains in **N** for 30 minutes.

If you open the driver's or front-passenger door during this period, the transmission automatically shifts to **P** and the electric parking brake is automatically applied.

The engine can be switched off in an emergency while the vehicle is in motion by pressing and holding the Start/Stop button for three seconds. This function operates independently of the ECO start/stop automatic engine switch-off function.

#### Using the SmartKey

- ▶ Turn the SmartKey to key position **0** in the ignition lock and remove it. The immobilizer is activated.

If you move the E-SELECT lever to **N** before switching off the engine, the transmission remains in **N** for approximately 30 minutes. If you open the driver's or front-passenger door during this time, the transmission shifts automatically to **P**.

The transmission remains in **N** if:

- the SmartKey is in the ignition lock and
- you use the E-SELECT lever to shift the transmission to **N** before switching the engine off

This still applies if you open the driver's or front-passenger door.

Further information on transmission position **N** when operating with a SmartKey is available under "Automatic car wash"

(▷ page 233).

## Electric parking brake

### General notes

#### WARNING

If you leave children unsupervised in the vehicle, they could set it in motion by, for example:

- release the parking brake.
- shift the automatic transmission out of the parking position **P**.
- start the engine.

In addition, they may operate vehicle equipment and become trapped. There is a risk of an accident and injury.

When leaving the vehicle, always take the SmartKey with you and lock the vehicle. Never leave children unsupervised in the vehicle.

The function of the electric parking brake is dependent on the on-board voltage. If the on-board voltage is low or there is a malfunction in the system, it may not be possible to apply the released parking brake.

- ▶ If this is the case, only park the vehicle on level ground and secure it to prevent it rolling away.
- ▶ Shift the automatic transmission to position **P**.

It may not be possible to release an applied parking brake if the on-board voltage is low or there is a malfunction in the system. Contact a qualified specialist workshop.

The electric parking brake performs a function test at regular intervals while the engine is switched off. The sounds that can be heard while this is occurring are normal.

## Applying or releasing manually

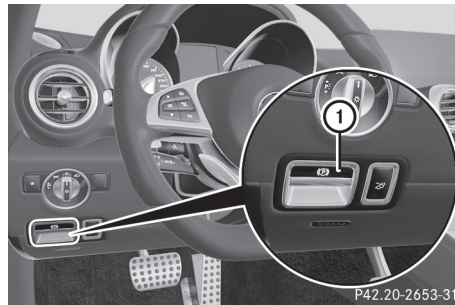

- ▶ **To apply:** push handle ①.

When the electric parking brake is applied, the red **PARK** (USA only) or **(P)** (Canada only) indicator lamp lights up in the instrument cluster.

The electric parking brake can also be applied when the SmartKey is in position **0**.

- ▶ **To release:** pull handle ①.

The red **PARK** (USA only) or **(P)** (Canada only) indicator lamp in the instrument cluster goes out.

The electric parking brake can only be released if:

- the ignition was switched on using the Start/Stop button or
- the SmartKey is in key position **1** or **2** in the ignition lock (▷ page 102)

## Applying automatically

The electric parking brake is automatically applied when the transmission is in position **P** and:

- the engine is switched off or
- the driver is not wearing a seat belt and the driver's door is opened

To prevent the electric parking brake from being automatically applied, pull handle ①.

The electric parking brake is also engaged automatically if:

- Distance Pilot DISTRONIC brings the vehicle to a standstill or
- the HOLD function is keeping the vehicle stationary

In addition, at least one of the following conditions must be fulfilled:

- there is a system malfunction
- the power supply is insufficient
- the vehicle is stationary for a lengthy period

The red **PARK** (USA only) or **(P)** (Canada only) indicator lamp in the instrument cluster lights up.

The electric parking brake is not automatically engaged if the engine is switched off by the ECO start/stop function.

### Releasing automatically

The electric parking brake is released when the following conditions are fulfilled:

- the engine is running
- the seat belt tongue is engaged in the belt buckle
- the transmission is in position **D** or **R** and you depress the accelerator pedal or shift from position **P** to **D** or **R**
- if the transmission is in position **R**, the tailgate must be closed

If the seat belt tongue is not engaged in the seat belt buckle, the following conditions must be fulfilled:

- the driver's door and front-passenger door are closed
- you move the transmission out of position **P** or you have previously driven at a speed above 2 mph (3 km/h)
- if the transmission is in position **R**, the tailgate must be closed

When the electric parking brake is released, the red **PARK** (USA only) or **(P)** (Canada only) indicator lamp goes out in the instrument cluster.

### Emergency braking

The vehicle can also be braked during an emergency by using the electric parking brake.

- ▶ While driving, push handle ① of the electric parking brake (> page 120). The vehicle is braked as long as you keep handle ① of the electric parking brake pressed. The longer electric parking brake handle ① is depressed, the greater the braking force.

During braking:

- a warning tone sounds
- the **Please Release Parking Brake** message appears
- the red **PARK** (USA only) or **(P)** (Canada only) indicator lamp in the instrument cluster flashes

When the vehicle has been braked to a standstill, the electric parking brake is engaged.

### Parking the vehicle for a long period

#### General notes

If you leave the vehicle parked for longer than four weeks, the battery may be damaged by exhaustive discharging.

If you leave the vehicle parked for longer than six weeks, the vehicle may suffer damage as a result of lack of use.

- ▶ Visit a qualified specialist workshop and seek advice.

### Trickle charging the on-board electrical system battery

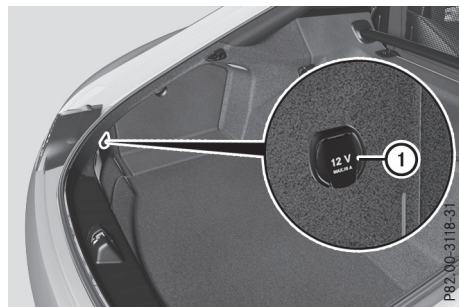

The battery may drain if the vehicle is left stationary for long periods. In this case, Mercedes-Benz recommends attaching the trickle charger to the 12 V socket in the cargo compartment.

- ① A trickle charger and further information can be obtained from a qualified specialist workshop.
- ▶ Switch the ignition off.
- ▶ Open the tailgate.

- ▶ Connect the cable provided in the cargo compartment to the trickle charger.
- ▶ Connect the trickle charger to 12 V socket ①. Consult the manufacturer's operating instructions on how to do so.

The tailgate can be closed, even if a trickle charger is connected. Make sure that the connector for both the connector cables is outside of the vehicle.

The connector can then separate if the vehicle is moved, even if you forget to disconnect the connector cables. This prevents damaging the cables and the trickle charger.

A trickle charger connected to 12 V socket ① only maintains the current charge level of the vehicle's electrical system battery. If the vehicle's electrical system battery is discharged, it needs to be charged with a battery charger.

## Driving tips

### General driving tips

#### Important safety notes

##### WARNING

If you switch off the ignition while driving, safety-relevant functions are only available with limitations, or not at all. This could affect, for example, the power steering and the brake boosting effect. You will require considerably more effort to steer and brake. There is a risk of an accident.

Do not switch off the ignition while driving.

##### WARNING

If you operate mobile communication equipment when driving, you may be distracted from the traffic situation. You could also lose control of the vehicle. There is a risk of an accident.

Only operate this equipment when the vehicle is stationary.

Observe the legal requirements for the country in which you are driving. Some jurisdictions prohibit the driver from using a mobile phone while driving a vehicle.

If you make a call while driving, always use hands-free mode. Only operate the telephone when the traffic situation permits. If you are unsure, pull over to a safe location and stop before operating the telephone.

Bear in mind that at a speed of only 30 mph (approximately 50 km/h), the vehicle covers a distance of 44 ft (approximately 14 m) per second.

#### Drive sensibly – save fuel

Observe the following tips to save fuel:

- ▶ The tires should always be inflated to the recommended tire pressure.
- ▶ Remove unnecessary loads.
- ▶ Warm up the engine at low engine speeds.
- ▶ Avoid frequent acceleration or braking.
- ▶ Have all service and maintenance work carried out at the specified intervals.

Fuel consumption also increases when driving in cold weather, in stop-start traffic and in hilly terrain.

#### Drinking and driving

##### WARNING

Drinking and driving and/or taking drugs and driving are very dangerous combinations. Even a small amount of alcohol or drugs can affect your reflexes, perceptions and judgment.

The possibility of a serious or even fatal accident is greatly increased when you drink or take drugs and drive.

Do not drink or take drugs and drive or allow anyone to drive who has been drinking or taking drugs.

#### Emission control

##### WARNING

Combustion engines emit poisonous exhaust gases such as carbon monoxide. Inhaling these exhaust gases leads to poisoning. There is a risk of fatal injury. Therefore never leave the engine running in enclosed spaces without sufficient ventilation.

Certain engine systems are designed to keep the level of poisonous components in exhaust fumes within legal limits.

These systems only work at peak efficiency if they are serviced exactly in accordance with the manufacturer's specifications. Always have work on the engine carried out at a qualified specialist workshop. Mercedes-Benz recommends that you use an authorized Mercedes-Benz Center for this purpose. In particular, work relevant to safety or on safety-related systems must be carried out at a qualified specialist workshop.

The engine settings must not be changed under any circumstances. Furthermore, all specific service work must be carried out at regular intervals and in accordance with the Mercedes-Benz service requirements.

You can obtain current information concerning the servicing of your vehicle at any time from a qualified specialist workshop. This could be an overview of the maintenance work or any additional maintenance work, for example.

## Braking

### Important safety notes

#### WARNING

If you shift down on a slippery road surface in an attempt to increase the engine's braking effect, the drive wheels could lose their grip. There is an increased danger of skidding and accidents.

Do not shift down for additional engine braking on a slippery road surface.

### Downhill gradients

-  On long and steep gradients, you must reduce the load on the brakes by shifting to a lower gear in good time. This allows you to take advantage of the engine's braking effect. This helps you to avoid overheating the brakes and wearing them out excessively. When you take advantage of engine braking, a drive wheel may not turn for some time, e.g. on a slippery road surface. This could cause damage to the drive train. This type of damage is not covered by the Mercedes-Benz warranty.

### Heavy and light loads

#### WARNING

If you rest your foot on the brake pedal while driving, the braking system can overheat. This increases the stopping distance and can even cause the braking system to fail. There is a risk of an accident.

Never use the brake pedal as a footrest. Never depress the brake pedal and the accelerator pedal at the same time.

-  Depressing the brake pedal constantly results in excessive and premature wear to the brake pads.

If the brakes have been subjected to a heavy load, do not stop the vehicle immediately. Drive on for a short while. This allows the airflow to cool the brakes more quickly.

### Wet roads

If you have driven for a long time in heavy rain without braking, there may be a delayed reaction from the brakes when braking for the first time. This may also occur after the vehicle has been washed or driven through deep water.

You have to depress the brake pedal more firmly. Maintain a greater distance from the vehicle in front.

After driving on a wet road or having the vehicle washed, brake firmly while paying attention to the traffic conditions. This will warm up the brake discs, thereby drying them more quickly and protecting them against corrosion.

### Limited braking performance on salt-treated roads

If you drive on salted roads, a layer of salt residue may form on the brake discs and brake pads. This can result in a significantly longer braking distance.

Observe the following rules when driving on salt-treated roads:

- In order to prevent any salt build-up, apply the brakes occasionally while paying attention to the traffic conditions.
- Carefully depress the brake pedal at the beginning and end of a journey.
- Maintain a greater distance to the vehicle ahead.

### Servicing the brakes

- !** The brake fluid level may be too low, if:
- if the red brake warning lamp lights up in the instrument cluster and
  - you hear a warning tone while the engine is running

Observe additional warning messages in the multifunction display.

The brake fluid level may be too low due to brake pad wear or leaking brake lines.

Have the brake system checked immediately. Consult a qualified specialist workshop to arrange this.

All checks and maintenance work on the brake system must be carried out at a qualified specialist workshop.

Have brake pads installed and brake fluid replaced at a qualified specialist workshop.

If the brake system has only been subject to moderate loads, you should test the functionality of your brakes at regular intervals.

Information on BAS (Brake Assist) (▷ page 57).

For safety reasons, Mercedes-Benz recommends only installing the following brake disks and brake pads/linings:

- brake disks that have been approved by Mercedes-Benz
- brake pads/linings that have been approved by Mercedes-Benz or that are of an equivalent standard of quality

Other brake disks or brake pads/linings can compromise the safety of your vehicle.

Always replace all brake disks and brake pads/linings on an axle at the same time. Always install new brake pads/linings when replacing brake disks.

The vehicle is equipped with lightweight brake disks to which the wheel assembly with rim and threaded connection is matched.

The use of brake disks other than those approved by Mercedes-Benz can change the track width and is subject to approval, if applicable.

Shock-type loads when handling the brake discs, such as when changing wheels, can lead to a reduction in comfort when driving with lightweight brake discs. Avoid shock-type loads on the lightweight brake disks, particularly on the brake plate.

Mercedes-Benz recommends that you only use brake fluid that has been specially approved for your vehicle by Mercedes-Benz, or which corresponds to an equivalent quality standard. Brake fluid which has not been approved for Mercedes-Benz vehicles or which is not of an equivalent quality could affect your vehicle's operating safety.

### AMG high-performance and ceramic brakes

The AMG brake systems are designed for heavy loads. This may lead to noise when braking. This will depend on:

- Speed
- Braking force
- Environmental conditions, such as temperature and humidity

The wear of individual components of the brake system, such as the brake pads/linings or brake discs, depends on the individual driving style and operating conditions.

For this reason, it is impossible to state a mileage that will be valid under all circumstances. An aggressive driving style will lead to high wear. You can obtain more information on this from a qualified specialist workshop.

New and replaced brake pads and discs only reach their optimum braking effect after several hundred kilometers of driving. Compensate for this by applying greater force to the brake pedal. Keep this in mind, and adapt your driving and braking accordingly during this break-in period. Excessive heavy braking results in correspondingly high brake wear. Observe the brake wear warning lamp in the instrument cluster and note any brake status messages in the multifunction display. Especially for high performance driving, it is important to maintain and have the brake system checked regularly.



## Driving on wet roads

### Hydroplaning

If water has accumulated to a certain depth on the road surface, there is a danger of hydroplaning occurring, even if:

- you drive at low speeds
- the tires have adequate tread depth

For this reason, in the event of heavy rain or in conditions in which hydroplaning may occur, you must drive in the following manner:

- lower your speed
- avoid ruts
- avoid sudden steering movements
- brake carefully

### Driving on flooded roads

**!** Do not drive through flooded areas. Check the depth of any water before driving through it. Drive slowly through standing water. Otherwise, water may enter the vehicle interior or the engine compartment. This can damage the electronic components in the engine or the automatic transmission. Water can also be drawn in by the engine's air suction nozzles and this can cause engine damage.

## Winter driving

### WARNING

If you shift down on a slippery road surface in an attempt to increase the engine's braking effect, the drive wheels could lose their grip. There is an increased danger of skidding and accidents.

Do not shift down for additional engine braking on a slippery road surface.

### DANGER

If the exhaust pipe is blocked or adequate ventilation is not possible, poisonous gases such as carbon monoxide (CO) may enter the vehicle. This is the case, e.g. if the vehicle becomes trapped in snow. There is a risk of fatal injury.

If you leave the engine or the auxiliary heating running, make sure the exhaust pipe and area around the vehicle are clear of snow. To ensure an adequate supply of fresh air, open a window on the side of the vehicle that is not facing into the wind.

Have your vehicle winter-proofed at a qualified specialist workshop at the onset of winter.

Drive particularly carefully on slippery road surfaces. Avoid sudden acceleration, steering and braking maneuvers. Do not use cruise control.

If the vehicle threatens to skid or cannot be stopped when moving at low speed:

- ▶ Shift the transmission to position **[N]**.

The outside temperature indicator is not designed to serve as an ice-warning device and is therefore unsuitable for that purpose.

Changes in the outside temperature are displayed after a short delay.

Indicated temperatures just above the freezing point do not guarantee that the road surface is free of ice. The road may still be icy, especially in wooded areas or on bridges. The vehicle could skid if you fail to adapt your driving style. Always adapt your driving style and drive at a speed to suit the prevailing weather conditions.

You should pay special attention to road conditions when temperatures are around freezing point.

For more information on driving with snow chains, see (▷ page 254).

For more information on driving with summer tires, see (▷ page 254).

Observe the notes in the "Winter operation" section (▷ page 254).

## Driving systems

### Cruise control

#### General notes

Cruise control maintains a constant road speed for you. It brakes automatically in order to avoid exceeding the set speed. Change into a lower gear in good time on long and steep downhill gradients. This is especially important if the vehicle is laden. By doing so, you will make use of the braking effect of the engine. This relieves the load on the brake system and prevents the

brakes from overheating and wearing too quickly.

Use cruise control only if road and traffic conditions make it appropriate to maintain a steady speed for a prolonged period. You can store any road speed above 20 mph (30 km/h).

### Cruise control lever

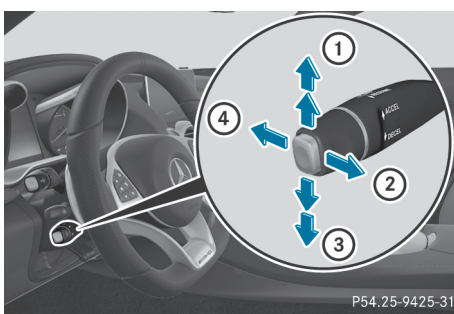

- ① Activates or increases speed
- ② Activates at the current speed/last stored speed
- ③ Activates or reduces speed
- ④ Deactivates cruise control

When you activate cruise control, the stored speed is shown in the multifunction display for five seconds. In addition, the  symbol appears in the multifunction display.

**Speedometer with segments:** when cruise control is activated, the segments from the stored speed to the end of the scale light up.

### Storing and maintaining the current speed

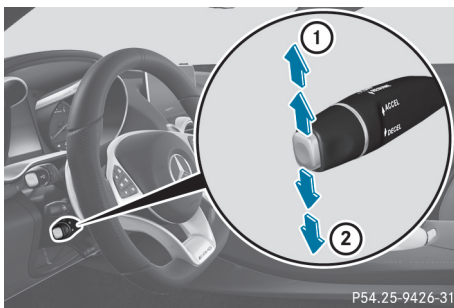

You can store the current speed if you are driving faster than 20 mph (30 km/h).

- ▶ Accelerate the vehicle to the desired speed.
- ▶ Briefly press the cruise control lever up ① or down ②.
- ▶ Remove your foot from the accelerator pedal. Cruise control is activated. The vehicle automatically maintains the stored speed.

**i** Cruise control may be unable to maintain the stored speed on uphill gradients. The stored speed is resumed when the gradient evens out. Cruise control maintains the stored speed on downhill gradients by automatically applying the brakes.

### Storing, maintaining and calling up a speed

#### WARNING

If you call up the stored speed and it is lower than the current speed, the vehicle decelerates. If you do not know the stored speed, the vehicle could decelerate unexpectedly. There is a risk of an accident.

Pay attention to the road and traffic conditions before calling up the stored speed. If you do not know the stored speed, store the desired speed again.

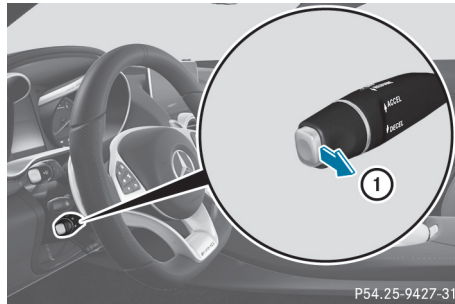

- ▶ Briefly pull the cruise control lever towards you ①.
- ▶ Remove your foot from the accelerator pedal. The first time cruise control is activated, it stores the current speed or regulates the speed of the vehicle to the previously stored speed.

## Setting a speed

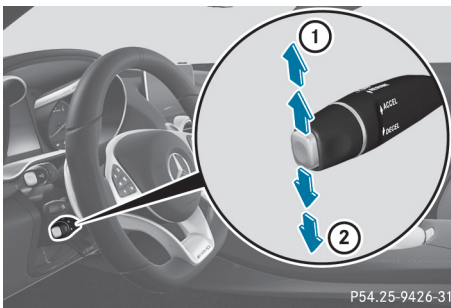

P54.25-9426-31

Keep in mind that it may take a brief moment until the vehicle has accelerated or braked to the speed set.

- ▶ Press the cruise control lever up ① for a higher speed or down ② for a lower speed.
- ▶ **To adjust the set speed in 1 mph increments (1 km/h increments):** briefly press the cruise control lever up ① or down ② to the pressure point.  
Every time the cruise control lever is pressed up ① or down ② the last speed stored is increased or reduced.
- ▶ **To adjust the set speed in 5 mph increments (10 km/h increments):** briefly press the cruise control lever up ① or down ② beyond the pressure point.  
Every time the cruise control lever is pressed up ① or down ② the last speed stored is increased or reduced.

- ❗ Cruise control is not deactivated if you depress the accelerator pedal. If you accelerate to overtake, cruise control adjusts the vehicle's speed to the last speed stored after you have finished overtaking.

## Deactivating cruise control

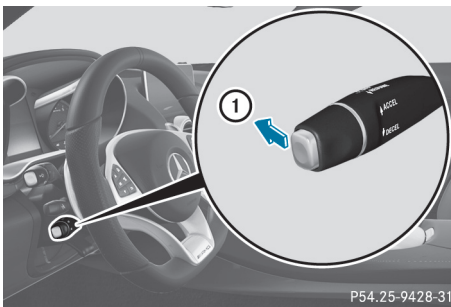

P54.25-9428-31

There are several ways to deactivate cruise control:

- ▶ Lightly press the cruise control lever forwards ①.

or

- ▶ Brake.

Cruise control is automatically deactivated if:

- you engage the electric parking brake
- you are driving at less than 20 mph (30 km/h)
- ESP® intervenes or you deactivate ESP®
- you shift the transmission to position **N** while driving

If cruise control is deactivated, you will hear a warning tone. You will see the **Cruise Control Off** message in the multifunction display for approximately five seconds.

- ❗ When you switch off the engine, the last speed stored is cleared.

## Distance Pilot DISTRONIC

### General notes

Distance Pilot DISTRONIC regulates the speed and automatically helps you maintain the distance to the vehicle detected in front. Vehicles are detected with the aid of the radar sensor system. Distance Pilot DISTRONIC brakes automatically so that the set speed is not exceeded. Change into a lower gear in good time on long and steep downhill gradients. This is especially important if the vehicle is laden. By doing so, you will make use of the braking effect of the engine. This relieves the load on the brake system and prevents the brakes from overheating and wearing too quickly.

If Distance Pilot DISTRONIC detects that there is a risk of a collision, you will be warned visually and acoustically. Without your intervention, Distance Pilot DISTRONIC cannot prevent a collision. An intermittent warning tone will then sound and the distance warning lamp will light up in the instrument cluster. Brake immediately in order to increase the distance to the vehicle in front or take evasive action provided it is safe to do so.

Distance Pilot DISTRONIC operates in the range between 0 mph (0 km/h) and 120 mph (200 km/h).

Do not use Distance Pilot DISTRONIC while driving on roads with steep gradients.

As Distance Pilot DISTRONIC transmits radar waves, it can resemble the radar detectors of the responsible authorities. You can refer to the relevant chapter in the Operator's Manual if questions are asked about this.

**i** USA only: This device has been approved by the FCC as a "Vehicular Radar System". The radar sensor is intended for use in an automotive radar system only. Removal, tampering, or altering of the device will void any warranties, and is not permitted by the FCC. Do not tamper with, alter, or use in any non-approved way.

Any unauthorized modification to this device could void the user's authority to operate the equipment.

**i** Canada only: This device complies with RSS-210 of Industry Canada. Operation is subject to the following two conditions:

1. This device may not cause interference, and
2. This device must accept any interference received, including interference that may cause undesired operation of the device.

Removal, tampering, or altering of the device will void any warranties, and is not permitted. Do not tamper with, alter, or use in any non-approved way.

Any unauthorized modification to this device could void the user's authority to operate the equipment.

### Important safety notes

#### WARNING

Distance Pilot DISTRONIC does not react to:

- people or animals
- stationary objects on the road, e.g. stopped or parked vehicles
- oncoming vehicles and crossing traffic

As a result, Distance Pilot DISTRONIC may neither give warnings nor intervene in such situations. There is a risk of an accident.

Always pay careful attention to the traffic situation and be ready to brake.

#### WARNING

Distance Pilot DISTRONIC cannot always clearly identify other road users and complex traffic situations.

In such cases, Distance Pilot DISTRONIC may:

- give an unnecessary warning and then brake the vehicle
- neither give a warning nor intervene
- accelerate or brake unexpectedly

There is a risk of an accident.

Continue to drive carefully and be ready to brake, especially if Distance Pilot DISTRONIC warns you.

#### WARNING

DISTRONIC PLUS brakes your vehicle with up to 50% of the maximum possible deceleration. If this braking force is insufficient, DISTRONIC PLUS warns you visually and audibly. There is a risk of an accident.

In such cases, apply the brakes yourself and try to take evasive action.

**i** When Distance Pilot DISTRONIC or the HOLD function is activated, the vehicle brakes automatically in certain situations. To avoid damage to the vehicle, deactivate Distance Pilot DISTRONIC and the HOLD function in the following or similar situations:

- when towing the vehicle
- in the car wash

If you fail to adapt your driving style, Distance Pilot DISTRONIC can neither reduce the risk of an accident nor override the laws of physics. Distance Pilot DISTRONIC cannot take into account road, weather or traffic conditions. Distance Pilot DISTRONIC is only an aid. You are responsible for the distance to the vehicle in front, for vehicle speed, for braking in good time and for staying in your lane.

Do not use Distance Pilot DISTRONIC:

- in road and traffic conditions which do not allow you to maintain a constant speed, for example in heavy traffic or on winding roads
- on slippery road surfaces. Braking or accelerating could cause the drive wheels to lose traction and the vehicle could then skid
- when there is poor visibility, e.g. due to fog, heavy rain or snow

Distance Pilot DISTRONIC may not detect narrow vehicles driving in front, e.g. motorcycles, or vehicles driving on a different line.

In particular, the detection of obstacles can be impaired if:

- there is dirt on the sensors or anything else covering the sensors
- there is snow or heavy rain
- there is interference by other radar sources
- there are strong radar reflections, for example, in parking garages

If Distance Pilot DISTRONIC no longer detects a vehicle in front, it may unexpectedly accelerate to the speed stored.

This speed may:

- be too high if you are driving in a turning lane or an exit lane
- be so high in the right lane that you pass vehicles driving on the left (in countries where they drive on the right)
- be so high in the left lane that you pass vehicles driving on the right (right-hand drive countries)

If there is a change of drivers, advise the new driver of the speed stored.

### Cruise control lever

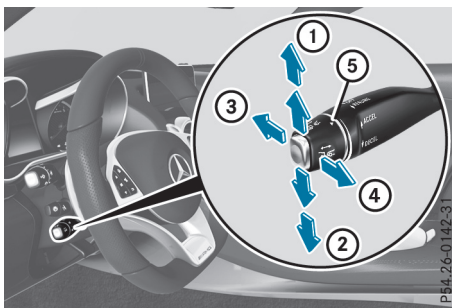

- ① Activates or increases speed
- ② Activates or reduces speed

- ③ Deactivates Distance Pilot DISTRONIC
- ④ Activating at the current speed/last stored speed
- ⑤ Sets a specified minimum distance

### Activating Distance Pilot DISTRONIC

#### Activation conditions

To activate Distance Pilot DISTRONIC, the following conditions must be fulfilled:

- the engine must be started. It may take up to two minutes of driving before Distance Pilot DISTRONIC is ready for use.
- the electric parking brake must be released.
- ESP® must be active, but not intervening.
- the transmission must be in position [D].
- the driver's door must be closed when you shift from [P] to [D] or your seat belt must be fastened.
- the front-passenger door and rear doors must be closed.

#### Activating

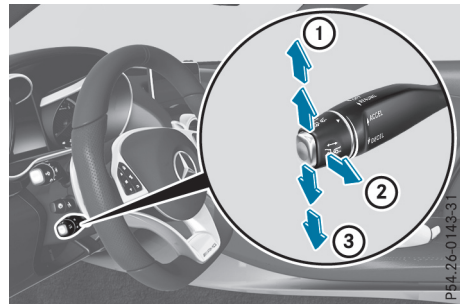

- ▶ Briefly pull the cruise control lever towards you ②, up ① or down ③ . Distance Pilot DISTRONIC is activated.
  - ▶ **To adjust the set speed in 1 mph increments (1 km/h increments):** briefly press the cruise control lever up ① to the pressure point for a higher speed, or down ③ for a lower speed. Every time the cruise control lever is pressed up or down, the last speed stored is increased or reduced.
- or
- ▶ **To adjust the set speed in 5 mph increments (10 km/h increments):** briefly press the cruise control lever up ① beyond the

P84-26-0142-31

P84-26-0143-31



pressure point for a higher speed, or down ③ for a lower speed.

Every time the cruise control lever is pressed up or down, the last speed stored is increased or reduced.

- ▶ Remove your foot from the accelerator pedal. Your vehicle adapts its speed to that of the vehicle in front, but only up to the desired stored speed.

- ❗ If you do not fully release the accelerator pedal, the **Distance Pilot Suspended** message appears in the multifunction display. The set distance to a slower-moving vehicle in front will then not be maintained. You will be driving at the speed you determine by the position of the accelerator pedal.

You can also activate Distance Pilot DISTRONIC when stationary. The lowest speed that can be set is 20 mph (30 km/h).

- ▶ Briefly pull the cruise control lever towards you ② or press it up ① or down ③. Distance Pilot DISTRONIC is activated.

### Activating at the current speed/last stored speed

#### ⚠ WARNING

If you call up the stored speed and it differs from the current speed, the vehicle accelerates or decelerates. If you do not know the stored speed, the vehicle could accelerate or brake unexpectedly. There is a risk of an accident.

Pay attention to the road and traffic conditions before calling up the stored speed. If you do not know the stored speed, store the desired speed again.

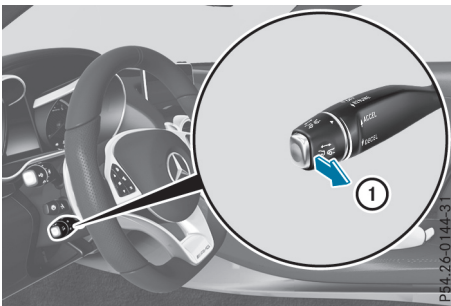

- ▶ Briefly pull the cruise control lever towards you ①.
- ▶ Remove your foot from the accelerator pedal. The first time Distance Pilot DISTRONIC is activated, it stores the current speed or regulates the speed of the vehicle to the previously stored speed.

### Driving with Distance Pilot DISTRONIC

#### Pulling away and driving

- ▶ **If you want to pull away with Distance Pilot DISTRONIC:** remove your foot from the brake pedal.
- ▶ Briefly pull cruise control ④ lever towards you.

or

- ▶ Accelerate briefly. Your vehicle pulls away and adapts its speed to that of the vehicle in front. If no vehicle is detected in front, your vehicle accelerates to the set speed.

- ❗ The vehicle can also pull away when it is facing an unidentified obstacle or is driving on a different line from another vehicle. The vehicle then brakes automatically. There is a risk of an accident. Be ready to brake at all times.

If there is no vehicle in front, Distance Pilot DISTRONIC operates in the same way as cruise control.

If Distance Pilot DISTRONIC detects a slower-moving vehicle in front, it brakes your vehicle. In this way, the distance you have selected is maintained.

If Distance Pilot DISTRONIC detects a faster-moving vehicle in front, it increases the driving speed. However, the vehicle is only accelerated up to the speed you have stored.

#### Selecting the drive program

Distance Pilot DISTRONIC supports a sporty driving style when you have selected the **S** or **S+** drive program (see the vehicle Operator's Manual). Acceleration behind the vehicle in front or to the set speed is then noticeably more dynamic. When you select the **C** drive program, the vehicle accelerates more gently. This setting is recommended in stop-and-start traffic.

## Changing lanes

If you change to the overtaking lane, Distance Pilot DISTRONIC supports you if:

- you are driving at a speed greater than 45 mph (70 km/h)
- you switch on the appropriate turn signal
- Distance Pilot DISTRONIC does not currently detect a danger of collision

If these conditions are fulfilled, your vehicle is accelerated. Acceleration will be interrupted if changing lanes takes too long or if the distance between your vehicle and the vehicle in front becomes too small.

- ❗ When you change lanes, Distance Pilot DISTRONIC monitors the left lane.

## Stopping

### ⚠ WARNING

If you leave the vehicle when it is only being braked by Distance Pilot DISTRONIC, it could roll away if:

- there is a malfunction in the system or in the voltage supply.
- Distance Pilot DISTRONIC is switched off using the cruise control lever, e.g. by a vehicle occupant or from outside the vehicle
- the electrical system in the engine compartment, the battery or the fuses are tampered with.
- the battery is disconnected
- the vehicle is accelerated, e.g. by a vehicle occupant.

There is a risk of an accident.

Before leaving the vehicle, always deactivate Distance Pilot DISTRONIC and secure the vehicle against rolling away.

Further information on deactivating Distance Pilot DISTRONIC (▷ page 132).

If Distance Pilot DISTRONIC detects that the vehicle in front is stopping, it brakes your vehicle to a stop.

Once your vehicle is stationary, it remains stationary and you do not need to depress the brake.

- ❗ After a time, the electric parking brake secures the vehicle and relieves the service brake.

- ❗ Depending on the specified minimum distance, your vehicle will come to a standstill at a sufficient distance behind the vehicle in front. The specified minimum distance is set using the control on the cruise control lever.

The electric parking brake secures the vehicle automatically if Distance Pilot DISTRONIC is activated when the vehicle is stationary and:

- the driver's seat belt is not fastened and the driver's door is open.
- the engine is switched off, unless it is automatically switched off by the ECO start/stop function.
- a system malfunction occurs.
- the power supply is not sufficient.

If a malfunction occurs, the transmission may also shift to position **P** automatically.

## Setting a speed

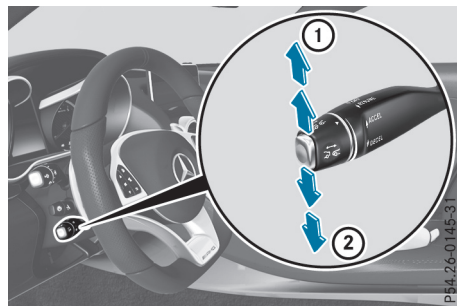

- ▶ Press the cruise control lever up ① for a higher speed or down ② for a lower speed.
- ▶ **To adjust the set speed in 1 mph increments (1 km/h increments):** briefly press the cruise control lever up ① or down ② to the pressure point. Every time the cruise control lever is pressed up ① or down ② the last speed stored is increased or reduced.
- ▶ **To adjust the set speed in 5 mph increments (10 km/h increments):** briefly press the cruise control lever up ① or down ② beyond the pressure point. Every time the cruise control lever is pressed up ① or down ②, the last speed stored is increased or reduced.



- i** If you accelerate to overtake, Distance Pilot DISTRONIC adjusts the vehicle's speed to the last speed stored after you have finished overtaking.

### Setting a specified minimum distance

You can set the specified minimum distance for Distance Pilot DISTRONIC by varying the time span between one and two seconds. With this function you can set the minimum distance that Distance Pilot DISTRONIC maintains to the vehicle in front, dependent on vehicle speed. You can see this distance in the multifunction display (▷ page 133).

- i** Make sure that you maintain the minimum distance to the vehicle in front as required by law. Adjust the distance to the vehicle in front if necessary.

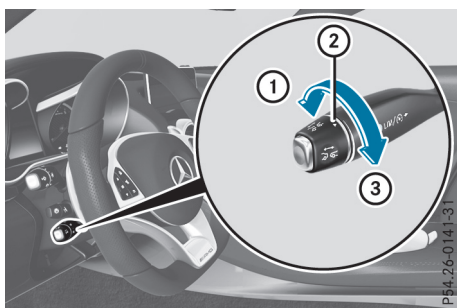

- ▶ **To increase:** turn control ② in direction ③. Distance Pilot DISTRONIC then maintains a greater distance between your vehicle and the vehicle in front.
- ▶ **To decrease:** turn control ② in direction ①. Distance Pilot DISTRONIC then maintains a shorter distance between your vehicle and the vehicle in front.

### Deactivating Distance Pilot DISTRONIC

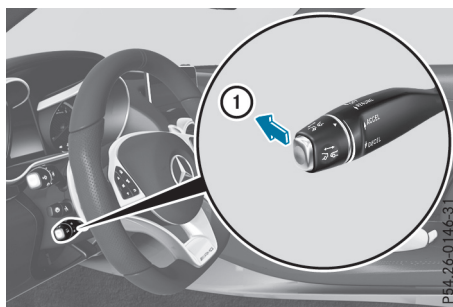

There are several ways to deactivate Distance Pilot DISTRONIC:

- ▶ Briefly press the cruise control lever forwards ①.

or

- ▶ Brake, unless the vehicle is stationary

When you deactivate Distance Pilot DISTRONIC, the **Distance Pilot Off** message appears in the multifunction display for approximately five seconds.

- i** The last speed stored remains stored until you switch off the engine.
- i** Distance Pilot DISTRONIC is not deactivated if you depress the accelerator pedal.

Distance Pilot DISTRONIC is automatically deactivated if:

- you engage the electric parking brake or if the vehicle is automatically secured with the electric parking brake
- ESP® intervenes or you deactivate ESP®
- the transmission is in position **P**, **R** or **N**
- you pull the cruise control lever towards you in order to pull away and the front-passenger door or one of the rear doors is open
- the vehicle has skidded

If Distance Pilot DISTRONIC is deactivated, you will hear a warning tone. You will see the **Distance Pilot Off** message on the multifunction display for approximately five seconds.

## Displays in the instrument cluster

### Displays in the speedometer

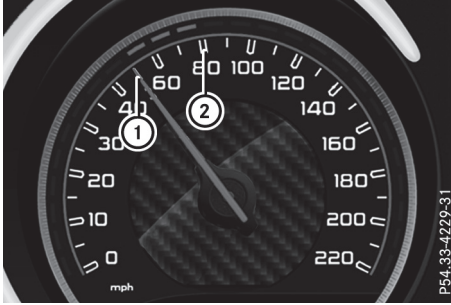

If Distance Pilot DISTRONIC detects a vehicle in front, segments between speed of the vehicle in front ① and stored speed ② light up.

- ❗ For design reasons, the speed displayed in the speedometer may differ slightly from the speed set for Distance Pilot DISTRONIC.

### Display when Distance Pilot DISTRONIC is deactivated

On the on-board computer, you can select the assistance graphics display.

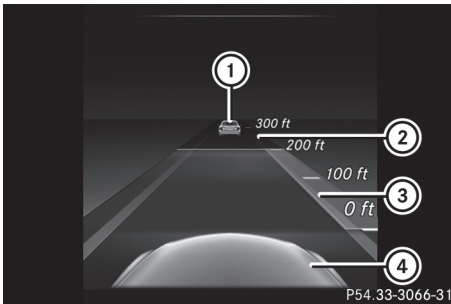

- ① Vehicle in front, if detected
- ② Distance indicator, current distance to the vehicle in front
- ③ Specified minimum distance to the vehicle in front; adjustable
- ④ Your vehicle

- ▶ Select the **Assistance Graphic** function using the on-board computer (▷ page 158).

### Display when Distance Pilot DISTRONIC is activated

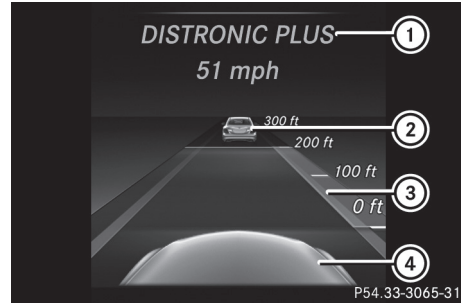

- ① Distance Pilot DISTRONIC active (text only appears when the cruise control lever is actuated)
- ② Vehicle in front, if detected
- ③ Specified minimum distance to the vehicle in front; adjustable
- ④ Your vehicle

- ▶ Select the **Assistance Graphic** function using the on-board computer (▷ page 158).

You will see the stored speed for approximately five seconds when you activate Distance Pilot DISTRONIC.

### Tips for driving with Distance Pilot DISTRONIC

#### General notes

Pay particular attention in the following traffic situations:

- Cornering, going into and coming out of a bend
- Vehicles traveling on a different line
- Other vehicles changing lanes
- Narrow vehicles
- Obstructions and stationary vehicles
- Crossing vehicles

In such situations, brake if necessary. Distance Pilot DISTRONIC will then be deactivated.

### Cornering, going into and coming out of a bend

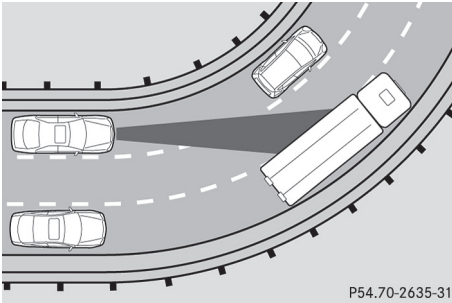

The ability of Distance Pilot DISTRONIC to detect vehicles when cornering is limited. Your vehicle may brake unexpectedly or late.

### Vehicles traveling on a different line

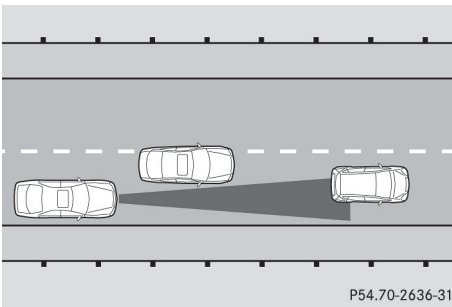

Distance Pilot DISTRONIC may not detect vehicles which are not driving in the middle of their lane. The distance to the vehicle in front will be too short.

### Other vehicles changing lanes

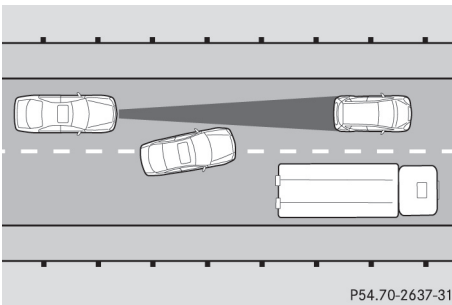

Distance Pilot DISTRONIC has not detected the vehicle cutting in yet. The distance to this vehicle will be too short.

### Narrow vehicles

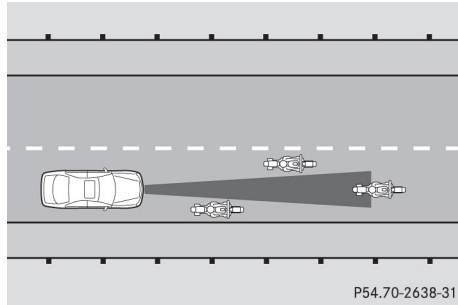

Distance Pilot DISTRONIC has not yet detected the vehicle in front on the edge of the road because of its narrow width. The distance to the vehicle in front will be too short.

### Obstructions and stationary vehicles

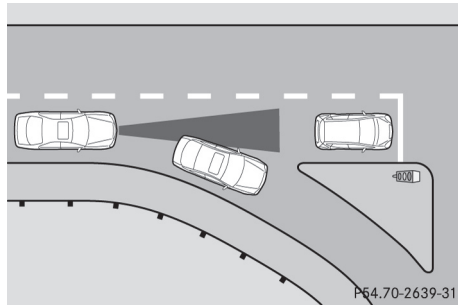

Distance Pilot DISTRONIC does not brake for obstacles or stationary vehicles. If, for example, the detected vehicle turns a corner and an obstacle or stationary vehicle is then revealed, Distance Pilot DISTRONIC will not brake for them.

### Crossing vehicles

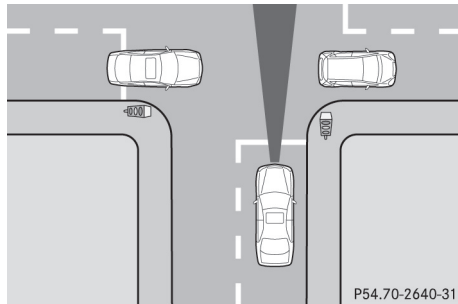

Distance Pilot DISTRONIC may mistakenly detect vehicles that are crossing your lane. Activating Distance Pilot DISTRONIC at, for example, a traffic light with crossing traffic, could cause your vehicle to pull away at the wrong time.

## HOLD

### General notes

The HOLD function can assist the driver in the following situations:

- when pulling away, especially on steep slopes
- when maneuvering on steep slopes
- when waiting in traffic

The vehicle is kept stationary without the driver having to depress the brake pedal.

The braking effect is canceled and the HOLD function deactivated when you depress the accelerator pedal to pull away.

### Important safety notes

#### WARNING

When leaving the vehicle, it can still roll away despite being braked by the HOLD function if:

- there is a malfunction in the system or in the voltage supply.
- the HOLD function has been deactivated by pressing the accelerator pedal or the brake pedal, e.g. by a vehicle occupant.
- the electrical system in the engine compartment, the battery or the fuses have been tampered with.
- the battery is disconnected

There is a risk of an accident.

If you wish to exit the vehicle, always turn off the HOLD function and secure the vehicle against rolling away.

- ❗ When Distance Pilot DISTRONIC or the HOLD function is activated, the vehicle brakes automatically in certain situations.

To avoid damage to the vehicle, deactivate Distance Pilot DISTRONIC and the HOLD function in the following or similar situations:

- when towing the vehicle
- in the car wash

Deactivating the HOLD function (> page 136).

### Activation conditions

You can activate the HOLD function if:

- the vehicle is stationary
- the engine is running or if it has been automatically switched off by the ECO start/stop function
- the driver's door is closed or your seat belt is fastened
- the electric parking brake is released
- the transmission is in position **D**, **R** or **N**

### Activating the HOLD function

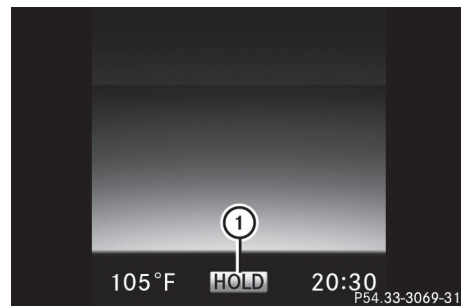

- ▶ Make sure that the activation conditions are met.
- ▶ Depress the brake pedal.
- ▶ Quickly depress the brake pedal further until  **HOLD** appears in the multifunction display. The HOLD function is activated. You can release the brake pedal.

- ❗ If depressing the brake pedal the first time does not activate the HOLD function, wait briefly and then try again.

## Deactivating the HOLD function

The HOLD function is deactivated automatically if:

- you depress the accelerator and the transmission is in position **D** or **R**
- you shift the transmission to position **P**
- you apply the brakes again with a certain amount of pressure until **HOLD** disappears from the multifunction display
- you secure the vehicle using the electric parking brake

- i** After a time, the electric parking brake secures the vehicle and relieves the service brake.

The electric parking brake secures the vehicle automatically if the HOLD function is activated when the vehicle is stationary and:

- the driver's seat belt is not fastened and the driver's door is open.
- the engine is switched off, unless it is automatically switched off by the ECO start/stop function.
- a system malfunction occurs.
- the power supply is not sufficient.

If the electric parking brake is not operational, a horn will sound at regular intervals. The HOLD function must then be deactivated.

If a malfunction occurs, the transmission may also be shifted to position **P** automatically.

The **Brake Immediately** message may also appear in the multifunction display.

- ▶ Immediately depress the brake firmly until the warning message in the multifunction display goes out.

The HOLD function is deactivated. The horn sounds at regular intervals if you have switched off the engine, released the seat belt and opened the driver's door with the HOLD function activated. The sounding of the horn alerts you to the fact that the HOLD function is still activated. If you attempt to lock the vehicle, the tone becomes louder. The vehicle cannot be locked until you have deactivated the HOLD function.

- i** After switching off the engine, it can only be started again once you have deactivated the HOLD function.

## RACE START

### Important safety notes

- i** RACE START must not be used on normal roads. RACE START must only be activated and used on dedicated road circuits, outside of public road use.

RACE START enables optimal acceleration from a standing start. For this, a suitably high-grip road surface is required and the vehicle and tires must be in good working order.

### WARNING

If you use RACE START, individual tires may start to spin and the vehicle could skid.

Depending on the selected ESP<sup>®</sup> mode, there is an increased risk of skidding and having an accident. Make sure that no persons, animals or obstacles are within range of the vehicle.

- i** Observe the safety notes on driving safety systems (▷ page 56).  
Be sure to read the safety notes and information on ESP<sup>®</sup> (▷ page 59).
- i** Observe the specific service requirements for racetrack mode operation (▷ page 232).

### Conditions for activation

You can activate RACE START if:

- the doors are closed.
- the engine is running and the engine and transmission are at operating temperature. This is the case when the oil temperature gauge in the multifunction display is shown in white (▷ page 161).
- ESP<sup>®</sup> is functioning correctly. (▷ page 60)
- the steering wheel is in the straight-ahead position.
- the vehicle is stationary and the brake pedal is depressed sufficiently (left foot).
- the transmission is in position **D**.
- drive program **S**, **S+** or **RACE** is selected (▷ page 107).

### Activating RACE START

- i** When manual mode (▷ page 114) is active, the transmission automatically shifts up to RACE START in the drive program. This func-

tion supports maximum acceleration with RACE START. After going through an accelerating process once from a stationary position, this function is automatically deactivated.

- ▶ Depress the brake pedal with your left foot and keep it depressed.
  - ▶ Fully depress the accelerator pedal. The engine speed is increased. The **RACE START Release brake to start** message appears in the multifunction display.
  - ▶ **To adjust RACE START:** pull the left-hand or right-hand steering wheel paddle shifter.
    - left-hand paddle shifter: to reduce engine speed
    - right-hand paddle shifter: to increase engine speed
 The engine speed is adjusted. The segments in the multifunction display flicker rapidly.
- i** If you do not release the brake pedal within a short time, RACE START will be canceled. The **RACE START Canceled** message appears in the multifunction display.
- ▶ Take your foot off the brake, but keep the accelerator pedal depressed. The vehicle pulls away at maximum acceleration. The **RACE START Active** message appears in the multifunction display.

RACE START is deactivated when the vehicle reaches a speed of approximately 30 mph (Canada: 50 km/h).

RACE START is deactivated immediately if you release the accelerator pedal during RACE START or if any of the activation conditions are no longer fulfilled. The **RACE START Not Possible See Operator's Manual** or **RACE START Canceled** message appears in the multifunction display.

- i** If RACE START is used repeatedly within a short period of time, it is only available again after the vehicle has been driven a certain distance.

## Traction control

### Important safety notes

#### WARNING

If you deactivate ESP<sup>®</sup>, ESP<sup>®</sup> no longer stabilizes the vehicle. There is an increased risk of skidding and an accident.

Only deactivate ESP<sup>®</sup> in the situations described in the following.

Observe the important safety notes on ESP<sup>®</sup> (▷ page 60).

Traction control is intended only for use on a designated race track. Do not use the function on public roads.

Driving with ESP<sup>®</sup> deactivated requires an extremely qualified and experienced driver.

### General notes

Traction control helps increase performance on the race track.

With traction control, you can adjust the balance between stability and agility gradually while accelerating.

While doing so, take the following parameters into account:

- current road conditions
- type of tire used
- road characteristics
- tire condition, such as temperature or wear
- personal driving style

### Activating and deactivating

#### Activating:

- ▶ Deactivate ESP<sup>®</sup> (▷ page 60). Traction control is activated.

**i** Traction control supports you only in metering the engine output. As ESP<sup>®</sup> is deactivated, ESP<sup>®</sup> does not stabilize the vehicle if the vehicle starts to skid.

#### Deactivating:

- ▶ Activate ESP<sup>®</sup> (▷ page 60).
- or
- ▶ Activate SPORT handling mode (▷ page 60). Traction control is deactivated.

### Setting the traction control

You can adjust traction control using the control in the center console.

The LEDs on the control display the currently set traction control level.

- ▶ **To increase traction control:** turn the control gradually clockwise.
- ▶ **To decrease traction control:** turn the control gradually counter-clockwise.  
If you turn the control all the way counter-clockwise, all the LEDs light up and traction control is deactivated.

### AMG adaptive sport suspension system

#### General notes

The electronically controlled damping system works continuously. This improves driving safety and ride comfort.

The damping is tuned individually to each wheel and depends on:

- your driving style, e.g. sporty
- the road surface condition, e.g. bumps
- your individual selection of Sport, Sport + or Comfort

The suspension setting is adjusted using the corresponding button in the center console.

- ❗ The mode can also be set using the DYNAMIC SELECT controller (▷ page 107).

Each time you start the engine with the Smart-Key or the Start/Stop button, Comfort mode is activated. For further information about starting the engine, see (▷ page 102).

#### Sport mode



P54.25-9402-31

The firmer setting of the suspension tuning in Sport mode ensures even better contact with the road. Select this mode when employing a sporty driving style, e.g. on winding country roads.

- ▶ Press button ① once.  
Indicator lamp ③ lights up. You have selected Sport mode.  
The **AMG Suspension System SPORT** message appears in the multifunction display.

#### Sport + mode

The very firm setting of the suspension setting in Sport + mode ensures the best possible contact with the road. Select this mode only when driving on race circuits.

If indicator lamps ② and ③ are off:

- ▶ Press button ① twice.  
Indicator lamps ② and ③ light up. You have selected Sport + mode.  
The **AMG Suspension System SPORT +** message appears in the multifunction display.

If indicator lamp ③ lights up:

- ▶ Press button ① once.  
Second indicator lamp ② lights up. You have selected Sport + mode.  
The **AMG Suspension System SPORT +** message appears in the multifunction display.

#### Comfort mode

In Comfort mode, the driving characteristics of your vehicle are more comfortable. Select this mode if you prefer a more comfortable driving style, but also when driving at speed on straight roads, e.g. highways.

- ▶ Press button ① repeatedly until indicator lamps ② and ③ go out.  
You have selected Comfort mode.  
The **AMG Suspension System COMFORT** message appears in the multifunction display.

### Parking Assist PARKTRONIC

#### Important safety notes

Parking Assist PARKTRONIC is an electronic parking aid with ultrasound. It monitors the area around your vehicle using six sensors in the



front bumper and four sensors in the rear bumper. Parking Assist PARKTRONIC shows you the distance between your vehicle and a detected obstacle visually and audibly.

Parking Assist PARKTRONIC is only an aid. It is not a replacement for your attention to your immediate surroundings. You are always responsible for safe maneuvering, parking and exiting a parking space. Make sure that there are no persons, animals or objects etc., in the maneuvering area while maneuvering and parking or exiting parking spaces.

**!** When parking, pay particular attention to objects above or below the sensors, such as flower pots or trailer drawbars. Parking Assist PARKTRONIC does not detect such objects when they are in the immediate vicinity of the vehicle. You could damage the vehicle or the objects.

The sensors may not detect snow and other objects that absorb ultrasonic waves.

Ultrasonic sources such as an automatic car wash, the compressed-air brakes of a truck or a pneumatic drill could cause Parking Assist PARKTRONIC to malfunction.

Parking Assist PARKTRONIC may not function correctly on uneven terrain.

Parking Assist PARKTRONIC is activated automatically when you:

- switch on the ignition
- shift the transmission to position **D**, **R** or **N**

Parking Assist PARKTRONIC is deactivated at speeds above approx. 11 mph (18 km/h). It is reactivated at lower speeds.

### Range of the sensors

#### General notes

Parking Assist PARKTRONIC does not take into account obstacles located:

- below the detection range, e.g. people, animals or objects.
- above the detection range, e.g. overhanging loads, truck overhangs or loading ramps.

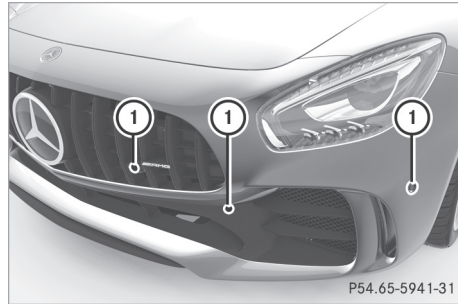

P54.65-5941-31

① Sensors in the front bumper, left-hand side (example)

The sensors must be free from dirt, ice or slush. They can otherwise not function correctly. Clean the sensors regularly, taking care not to scratch or damage them (> page 236).

#### Range

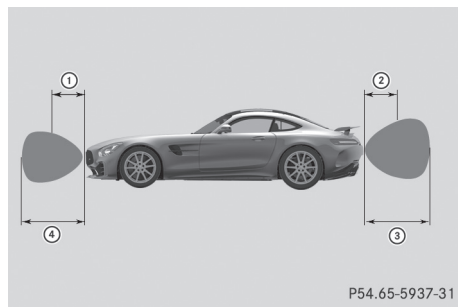

P54.65-5937-31

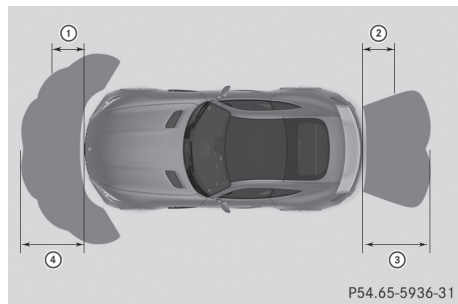

P54.65-5936-31

- ① Approx. 24 in (approx. 60 cm) (corners)
- ② Approx. 32 in (approx. 80 cm) (corners)
- ③ Approx. 48 in (approx. 120 cm) (center)
- ④ Approx. 40 in (approx. 100 cm) (center)

#### Minimum distance

|         |                              |
|---------|------------------------------|
| Center  | Approx. 8 in (approx. 20 cm) |
| Corners | Approx. 6 in (approx. 15 cm) |

If there is an obstacle within this range, the relevant warning displays light up and a warning tone sounds. If the distance falls below the minimum, the distance may no longer be shown.

### Warning displays

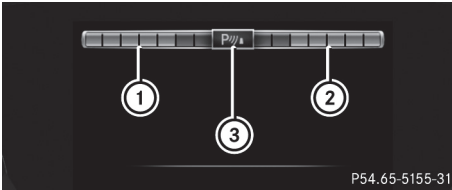

- ① Segments on the left-hand side of the vehicle
- ② Segments on the right-hand side of the vehicle
- ③ Segments showing operational readiness

The warning displays show the distance between the sensors and the obstacle. The warning display for the front area is in the instrument cluster. The warning display for the rear area is located on the headliner in the rear compartment.

The warning display for each side of the vehicle is divided into five yellow and two red segments. Parking Assist PARKTRONIC is operational if operational readiness indicator ③ lights up.

The selected transmission position and the direction in which the vehicle is rolling determine which warning display is active when the engine is running.

| Transmission position                                   | Warning display                |
|---|--------------------------------|
| <b>D</b>  | Front area activated           |
| <b>R</b> , <b>N</b> or the vehicle is rolling backwards | Rear and front areas activated |
| <b>P</b>  | No areas activated             |

One or more segments light up as the vehicle approaches a detected obstacle, depending on the vehicle's distance from the obstacle:

From the:

- sixth segment onwards, you will hear an intermittent warning tone for approximately two seconds.
- seventh segment onwards, you will hear a warning tone for approximately two seconds. This indicates that you have now reached the minimum distance.

### Deactivating or activating Parking Assist PARKTRONIC

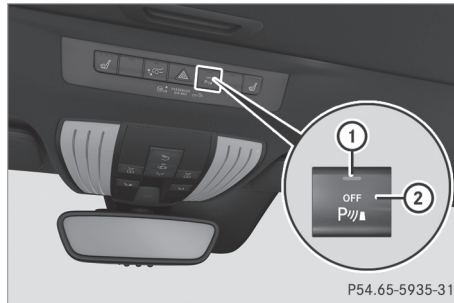

- ① Indicator lamp
- ② Deactivates or activates Parking Assist PARKTRONIC

If indicator lamp ① lights up, Parking Assist PARKTRONIC is deactivated.

- ① Parking Assist PARKTRONIC is automatically activated when you set the Start/Stop button to key position ②.

## Problems with Parking Assist PARKTRONIC

| Problem   | Possible causes/consequences and ► Solutions   |
|---|--|
| Only the red segments in the Parking Assist PARKTRONIC warning displays are lit. You also hear a warning tone for approximately two seconds. Parking Assist PARKTRONIC is then deactivated and the indicator lamp on the PARKTRONIC button lights up. | <p>Parking Assist PARKTRONIC has malfunctioned and has been deactivated.</p> <p>► If problems persist, have Parking Assist PARKTRONIC checked at a qualified specialist workshop.</p>  |
| Only the red segments in the Parking Assist PARKTRONIC warning displays are lit. Parking Assist PARKTRONIC is then deactivated.   | <p>The Parking Assist PARKTRONIC sensors are dirty or there is interference.</p> <p>► Clean the Parking Assist PARKTRONIC sensors (► page 236).</p> <p>► Switch the ignition back on.</p> <p>The problem may be caused by an external source of radio or ultrasound waves.</p> <p>► Check to see if Parking Assist PARKTRONIC works at a different location.</p> |

### Rear view camera

#### General notes

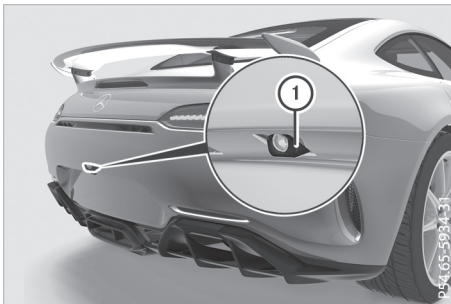

Rear view camera ① is located in the rear bumper, underneath the tailgate.

Rear view camera ① is an optical parking and maneuvering aid. It shows the area behind your vehicle with guide lines in the multimedia system display.

The area behind the vehicle is displayed as a mirror image, as in the rear view mirror.

**i** The text shown in the multimedia system display depends on the language setting. The following are examples of rear view camera messages in the multimedia system display.

#### Important safety notes

The rear view camera is only an aid. It is not a replacement for your attention to your immediate surroundings. You are always responsible for safe maneuvering and parking. Make sure that there are no persons, animals or objects etc., in the maneuvering area while maneuvering and parking in parking spaces.

The rear view camera will not function or will function only to a limited extent if:

- in heavy rain, snow or fog
- at night or in very dark places
- if the camera is exposed to very bright light
- if the area is lit by fluorescent bulbs or LED lighting (the display may flicker)
- if there is a sudden change in temperature, e.g. when driving into a heated garage in winter

- if the camera lens is dirty or obstructed. Observe the notes on cleaning (▷ page 236)
- if the rear of your vehicle is damaged. In this event, have the camera position and setting checked at a qualified specialist workshop

The field of vision and other functions of the rear view camera may be restricted due to additional accessories on the rear of the vehicle (e.g. license plate holder, bicycle rack).

The guide lines in the multimedia system display show the distances to your vehicle. The distances only apply to road level.

### Activating/deactivating the rear view camera

- ▶ **To activate:** ensure that key position **2** has been selected with the Start/Stop button.
- ▶ Make sure that the **Activation by R gear** function is selected on the multimedia system (see the Digital Operator's Manual).
- ▶ Engage reverse gear. The area behind the vehicle is shown with guide lines in the multimedia system display. The image from the rear view camera is available throughout the maneuvering process.

**To deactivate:** the rear view camera deactivates if you shift the transmission to **P** or after driving forwards a short distance.

### Messages in the multimedia system display

The rear view camera may show a distorted view of obstacles, show them incorrectly or not at all. Obstacles are not shown by the rear view camera in the following locations:

- very close to the rear bumper
  - under the rear bumper
- !** Objects not at ground level may appear to be further away than they actually are, e.g.:
- the bumper of a parked vehicle
  - the drawbar of a trailer
  - the ball coupling of a trailer tow hitch
  - the rear section of an HGV
  - a slanted post

Use the guidelines only for orientation. Approach objects no further than the bottom-most guideline.

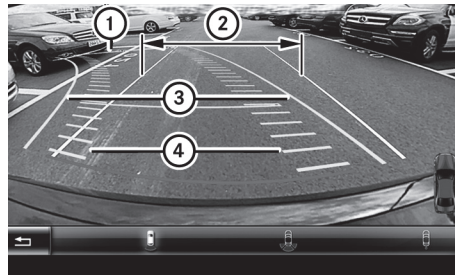

P54.65-4903-31

- ① Yellow guide line at a distance of approximately 13 ft (4.0 m) from the rear of the vehicle
- ② White guide line without steering input – vehicle width including the exterior mirrors (static)
- ③ Yellow guide line for the vehicle width including the exterior mirrors, for current steering wheel angle (dynamic)
- ④ Yellow lane marking the course the tires will take at the current steering wheel angle (dynamic)

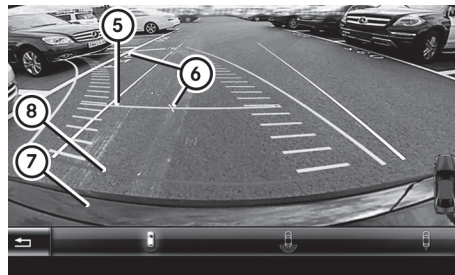

P54.65-4904-31

- ⑤ Yellow guide line at a distance of approximately 3 ft (1.0 m) from the rear of the vehicle
- ⑥ Vehicle center axle (marker assistance)
- ⑦ Bumper
- ⑧ Red guide line at a distance of approximately 12 in (0.30 m) from the rear of the vehicle

The guide lines are shown when the transmission is in position **R**.

The distance specifications only apply to objects that are at ground level.



P54.65-4905-31

- ① Front warning display
- ② Additional measurement operational readiness indicator for Parking Assist PARKTRONIC
- ③ Rear warning display

**Vehicles with Parking Assist PARKTRONIC:** when Parking Assist PARKTRONIC is operational (▷ page 140), additional measurement operational readiness indicator ② appears in the multimedia system display. If the Parking Assist PARKTRONIC warning displays are active or light up, warning displays ① and ③ are also active or light up correspondingly in the multimedia system display.

### "Reverse parking" function

#### Backing up straight into a parking space without steering input

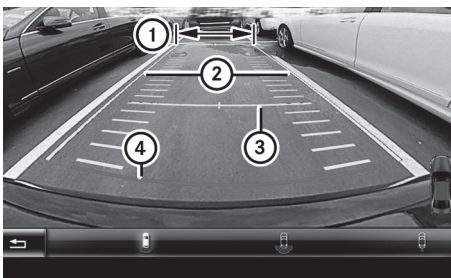

P54.65-4906-31

- ① White guide line without steering input – vehicle width including the exterior mirrors (static)
- ② Yellow guide line for the vehicle width including the exterior mirrors, for current steering wheel angle (dynamic)

- ③ Yellow guide line at a distance of approximately 3 ft (1.0 m) from the rear of the vehicle

- ④ Red guide line at a distance of approximately 12 in (0.30 m) from the rear of the vehicle

- ▶ Make sure that the rear view camera is switched on (▷ page 142). The lane and the guide lines are shown.
- ▶ With the help of white guide line ①, check whether the vehicle will fit into the parking space.
- ▶ Using white guide line ① as a guide, carefully back up until you reach the end position. Red guide line ④ is then at the end of parking space. The vehicle is almost parallel in the parking space.

#### Reverse perpendicular parking with steering input

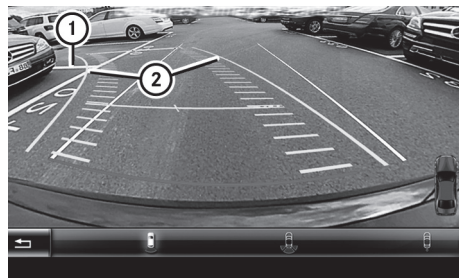

P54.65-4907-31

- ① Parking space marking
- ② Yellow guide line for the vehicle width including the exterior mirrors, for current steering wheel angle (dynamic)

- ▶ Drive past the parking space and bring the vehicle to a standstill.
- ▶ Make sure that the rear view camera is switched on (▷ page 142). The lane and the guide lines are shown.
- ▶ While the vehicle is at a standstill, turn the steering wheel in the direction of the parking space until yellow guide line ② reaches parking space marking ①.
- ▶ Maintain the steering input and reverse carefully.



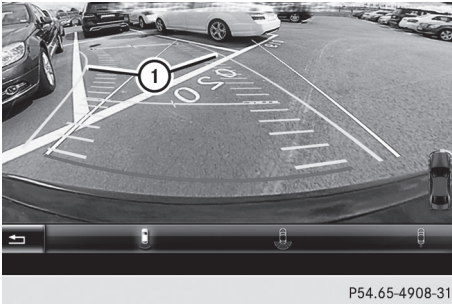

P54.65-4908-31

- ① Yellow guide line for the vehicle width including the exterior mirrors, for current steering wheel angle (dynamic)
- ▶ Stop the vehicle when it is almost exactly in front of the parking space. The white lane should be as close to parallel with the parking space marking as possible.

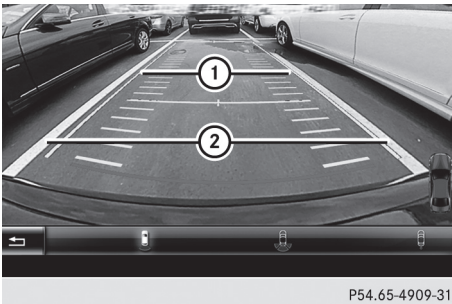

P54.65-4909-31

- ① White guide line for current steering input
- ② Parking space marking
- ▶ Turn the steering wheel to the center position while the vehicle is stationary.

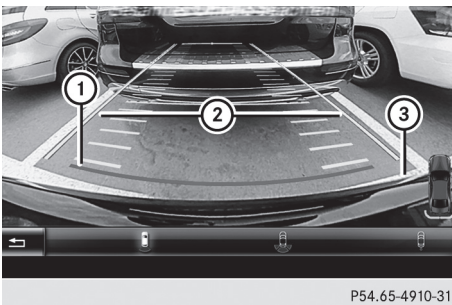

P54.65-4910-31

- ① Red guide line at a distance of approximately 12 in (0.30 m) from the rear of the vehicle
- ② White guide line without steering input
- ③ End of parking space

- ▶ Back up carefully until you have reached the final position. Red guide line ① is then at the end of parking space ③. The vehicle is almost parallel in the parking space.

### Wide-angle function

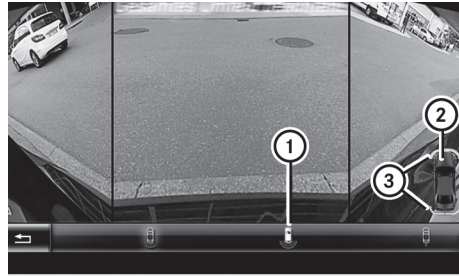

P54.65-4902-31

- ① Symbol for the wide-angle view function
- ② Your vehicle
- ③ Warning displays for Parking Assist PARKTRONIC

You can also use the rear view camera to select a wide-angle view.

When Parking Assist PARKTRONIC is operational (▷ page 140), a symbol for your own vehicle appears in the multimedia system display. If the Parking Assist PARKTRONIC warning displays are active, warning displays ③ light up in the multimedia system display in yellow or red accordingly.

### ATTENTION ASSIST

#### General notes

ATTENTION ASSIST helps you during long, monotonous journeys, such as on highways. It is active in the 37 mph (60 km/h) to 125 mph (200 km/h) range. If ATTENTION ASSIST detects typical indicators of fatigue or increasing lapses in concentration on the part of the driver, it suggests taking a break.

#### Important safety notes

ATTENTION ASSIST is only an aid to the driver. It might not always recognize fatigue or increasing inattentiveness in time or fail to recognize them at all. The system is not a substitute for a well-rested and attentive driver.

The functionality of ATTENTION ASSIST is restricted and warnings may be delayed or not occur at all:

- if the length of the journey is less than approximately 30 minutes
- if the road condition is poor, e.g. if the surface is uneven or if there are potholes
- if there is a strong side wind
- if you have adopted a sporty driving style with high cornering speeds or high rates of acceleration
- if you are predominantly driving slower than 37 mph (60 km/h) or faster than 125 mph (200 km/h)
- if the time has been set incorrectly
- in active driving situations, such as when you change lanes or change your speed

The ATTENTION ASSIST tiredness assessment is deleted and restarted when continuing the journey, if:

- you switch off the engine
- you take off your seat belt and open the driver's door, e.g. for a change of drivers or to take a break

### Displaying the attention level



You can have current status information displayed in the assistance menu (> page 159) of the on-board computer.

- ▶ Select the Assistance display for Attention Assist using the on-board computer (> page 158).

The following information is displayed:

- The length of the journey since the last break.
- The attention level determined by ATTENTION ASSIST (**Attention Level**), displayed in a bar display in five levels from high to low.
- If ATTENTION ASSIST is unable to calculate the attention level and cannot issue a warning, the **System Suspended** message appears. The bar display then changes what is shown, e.g. if you are driving at a speed below 37 mph (60 km/h) or above 125 mph (200 km/h).

### Activating ATTENTION ASSIST

- ▶ Activate ATTENTION ASSIST using the on-board computer (> page 159).  
The system determines the attention level of the driver depending on the setting selected:

Selection **Standard**: the sensitivity with which the system determines the attention level is set to normal.

Selection **Sensitive**: the sensitivity is set higher. The attention level detected by Attention Assist is adapted accordingly and the driver is warned earlier.

When ATTENTION ASSIST is deactivated, the  symbol appears in the multifunction display in the assistance graphic display.

When ATTENTION ASSIST has been deactivated, it is automatically reactivated after the engine has been stopped. The sensitivity selected corresponds to the last selection activated (standard/sensitive).

### Warning in the multifunction display

If fatigue or increasing lapses in concentration are detected, a warning appears in the multifunction display: **ATTENTION ASSIST Take a Break!**

In addition to the message shown in the multifunction display, you will then hear a warning tone.

- ▶ If necessary, take a break.
- ▶ Confirm the message by pressing the  button on the steering wheel.

On long journeys, take regular breaks in good time to allow yourself to rest. If you do not take a break and ATTENTION ASSIST still detects increasing lapses in concentration, you will be warned again after 15 minutes at the earliest.



This will only happen if ATTENTION ASSIST still detects typical indicators of fatigue or increasing lapses in concentration.

If a warning is output in the multifunction display, a service station search is performed in COMAND. You can select a service station and navigation to this service station will then begin. This function can be activated and deactivated in COMAND.

### Lane Tracking package

#### General notes

The Lane Tracking package consists of Blind Spot Assist (▷ page 146) and Lane Keeping Assist (▷ page 148).

#### Blind Spot Assist

##### General notes

Blind Spot Assist monitors the areas on either side of the vehicle that are not visible to the driver with two lateral, rear-facing radar sensors. A warning display in the exterior mirrors draws your attention to vehicles detected in the monitored area. If you then switch on the corresponding turn signal to change lane, you will also receive an optical and audible warning.

Blind Spot Assist supports you from a speed of approximately 20 mph (30 km/h).

##### Important safety notes

#### WARNING

Blind Spot Assist does not react to:

- vehicles overtaken too closely on the side, placing them in the blind spot area
- vehicles which approach with a large speed differential and overtake your vehicle

As a result, Blind Spot Assist may not give warnings in such situations. There is a risk of an accident.

Always observe the traffic conditions carefully, and maintain a safe lateral distance.

Blind Spot Assist is only an aid. It may fail to detect some vehicles and is no substitute for attentive driving. Always ensure that there is sufficient distance to the side for other road users and obstacles.

#### USA only:

This device has been approved by the FCC as a "Vehicular Radar System". The radar sensor is intended for use in an automotive radar system only. Removing, tampering with, or altering the device will void any warranties, and is not permitted by the FCC. Do not tamper with, alter, or use in any non-approved way.

Any unauthorized modification to this device could void the user's authority to operate the equipment.

#### Radar sensors

The radar sensors for Blind Spot Assist are integrated into the rear bumper. Make sure that the bumpers are free from dirt, ice or slush. The sensors must not be covered, for example by cycle racks or overhanging loads. Following a severe impact or in the event of damage to the bumpers, have the function of the radar sensors checked at a qualified specialist workshop. Blind Spot Assist may no longer work properly.

#### Monitoring area

In particular, the detection of obstacles can be impaired if:

- there is dirt on the sensors or anything else covering the sensors
- there is poor visibility, e.g. due to fog, heavy rain, snow or spray
- there are narrow vehicles, e.g. motorcycles or bicycles
- the road has very wide lanes
- the road has narrow lanes
- you are not driving in the middle of the lane
- there are barriers or similar lane borders

Vehicles in the monitoring range are then not indicated.

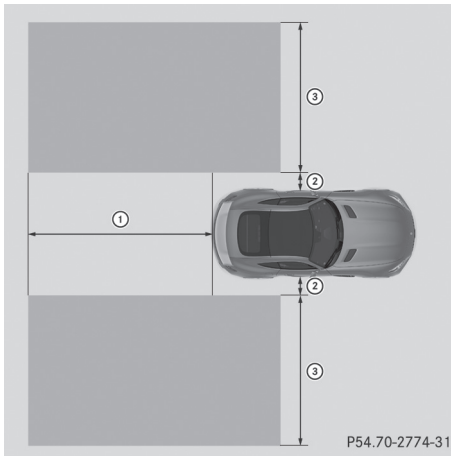

(Example)

At a distance of around 1.6 ft (0.5 m) ② from the vehicle, Blind Spot Assist monitors the area up to 10 ft (3 m) next to ③ and behind ① your vehicle, as shown in the picture.

If the lanes are narrow, vehicles driving in the lane beyond the lane next to your vehicle may be indicated, especially if the vehicles are not driving in the middle of their lane. This may be the case if there are vehicles driving at the inner edge of their lanes.

Due to the nature of the system:

- warnings may be issued in error when driving close to crash barriers or similar solid lane borders.
- the warning is canceled when driving for an extended period next to long vehicles, such as trucks.

### Warning lamp

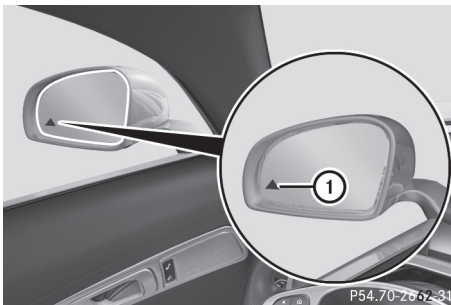

① Warning lamp

Blind Spot Assist is not active at speeds below approximately 20 mph (30 km/h). Vehicles in the monitoring range are then not indicated.

If Blind Spot Assist is activated, warning lamp ① in the exterior mirrors lights up yellow at speeds of up to 20 mph (30 km/h). At speeds above 20 mph (30 km/h), the warning lamp goes out and Blind Spot Assist is operational.

If a vehicle is detected within the blind spot monitoring range at speeds above 20 mph (30 km/h), warning lamp ① on the corresponding side lights up red. This warning is always emitted when a vehicle enters the blind spot monitoring range from behind or from the side. When you overtake a vehicle, the warning only occurs if the difference in speed is less than 7 mph (12 km/h).

If you select the reverse gear, Blind Spot Assist is not operational.

The brightness of the warning lamps is automatically adapted to the brightness of the surroundings.

### Collision warning

If a vehicle is detected in the monitoring range of Blind Spot Assist and you switch on the corresponding turn signal, a double warning tone sounds. The red warning lamp flashes on the relevant exterior mirror. If the turn signal remains on, detected vehicles are indicated by the flashing of the red warning lamp on the exterior mirror. There are no further warning tones.

### Switching on Blind Spot Assist

- ▶ Make sure that Blind Spot Assist is activated in the on-board computer (> page 159).
- ▶ Select key position ② with the Start/Stop button.

Warning lamps in the exterior mirrors light up red for approximately 1.5 seconds and then turn yellow.

## Lane Keeping Assist

### General notes

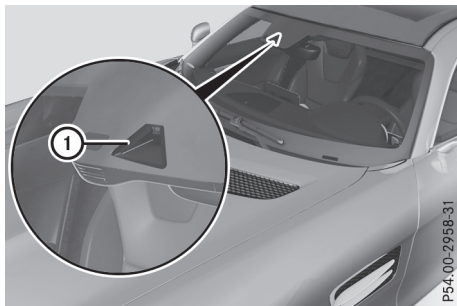

Lane Keeping Assist monitors the area in front of your vehicle by means of multifunction camera ① which is attached behind the top of the windshield. Lane Keeping Assist detects lane markings on the road and can warn you before you leave your lane unintentionally.

This function is available in the range between 40 mph and 120 mph (60 km/h and 200 km/h). A warning may be given if a front wheel passes over a lane marking. It will warn you by means of intermittent vibration in the steering wheel for up to 1.5 seconds.

### Important safety notes

#### WARNING

Lane Keeping Assist cannot always clearly detect lane markings.

In such cases, Lane Keeping Assist can:

- give an unnecessary warning
- not give a warning

There is a risk of an accident.

Always pay particular attention to the traffic situation and keep within the lane, especially if Lane Keeping Assist alerts you.

#### WARNING

The Lane Keeping Assist warning does not return the vehicle to the original lane. There is a risk of an accident.

You should always steer, brake or accelerate yourself, in particular if warned by Lane Keeping Assist.

If you fail to adapt your driving style, Lane Keeping Assist can neither reduce the risk of an accident nor override the laws of physics. Lane Keeping Assist cannot take into account the road, traffic and weather conditions. Lane Keeping Assist is merely an aid. You are responsible for the distance to the vehicle in front, for vehicle speed, for braking in good time and for staying in your lane.

The Lane Keeping Assist does not keep the vehicle in the lane.

The system may be impaired or may not function if:

- there is poor visibility, e.g. due to insufficient illumination of the road, or due to snow, rain, fog or spray
- there is glare, e.g. from oncoming traffic, the sun or reflections (e.g. when the road surface is wet)
- the windshield is dirty, fogged up, damaged or covered, for instance by a sticker, in the vicinity of the camera
- there are no or several unclear lane markings for one lane, e.g. roadworks
- the lane markings are worn away, dark or covered up, e.g. by dirt or snow
- the distance to the vehicle in front is too short and thus the lane markings cannot be detected
- the lane markings change quickly, e.g. lanes branch off, cross one another or merge
- the road is narrow and winding
- there are strong shadows cast on the road

### Switching on Lane Keeping Assist

- ▶ Activate Lane Keeping Assist using the on-board computer; to do so, select **Standard** or **Adaptive** (▷ page 160).

If you drive at speeds above 40 mph (60 km/h) and lane markings are detected, the lines in the assistance graphic are shown in green (▷ page 158). Lane Keeping Assist is ready for use.

### Standard

When **Standard** is selected, no warning vibration occurs if:

- you have switched on the turn signal. In this event, the warnings are suppressed for a certain period of time.
- a driving safety system intervenes, such as ABS, BAS or ESP®.

### Adaptive

When **Adaptive** is selected, no warning vibration occurs if:

- you have switched on the turn signal. In this event, the warnings are suppressed for a certain period of time.
- a driving safety system intervenes, e.g. ABS, BAS or ESP®.
- you accelerate hard, e.g. kickdown.
- you brake hard.
- you steer actively, e.g. swerve to avoid an obstacle or change lanes quickly.
- you cut the corner on a sharp bend.

In order that you are warned only when necessary and in good time if you cross the lane marking, the system detects certain conditions and warns you accordingly.

The warning vibration occurs earlier if:

- you approach the outer lane marking on a bend
- the road has very wide lanes, e.g. a freeway
- the system detects solid lane markings

The warning vibration occurs later if:

- the road has narrow lanes
- you cut the corner on a bend



### Important safety notes

#### WARNING

If you operate information systems and communication equipment integrated in the vehicle when driving, you may be distracted from the traffic situation. You could also lose control of the vehicle. There is a risk of an accident.

Only operate this equipment when the traffic situation permits. If you are not sure that this is possible, park the vehicle paying attention to traffic conditions and operate the equipment when the vehicle is stationary.

You must observe the legal requirements for the country in which you are currently driving when operating the on-board computer.

#### WARNING

If the instrument cluster has failed or malfunctioned, you may not recognize function restrictions in systems relevant to safety. The operating safety of your vehicle may be impaired. There is a risk of an accident.

Drive on carefully. Have the vehicle checked at a qualified specialist workshop immediately.

The on-board computer only shows messages or warnings from certain systems in the multifunction display. You should therefore make sure your vehicle is operating safely at all times.

If the operating safety of your vehicle is impaired, pull over as soon as it is safe to do so. Contact a qualified specialist workshop.

For an overview, see the instrument panel illustration (> page 33).

### Displays and operation

#### Speedometer with segments

The segments in the speedometer indicate which speed range is available:

- Cruise control activated (> page 125):

The segments light up from the stored speed to the type-tested maximum speed.

- Distance Pilot DISTRONIC is activated (> page 127):  
One or two segments in the set speed range light up.
- Distance Pilot DISTRONIC detects a vehicle in front moving more slowly than the stored speed:  
The segments between the speed of the vehicle in front and the stored speed light up.

#### Tachometer

-  Do not drive in the overrevving range, as this could damage the engine.

The red band in the tachometer indicates the engine's overrevving range.

The fuel supply is interrupted to protect the engine when the red band is reached.

#### Outside temperature display

You should pay special attention to road conditions when temperatures are around freezing point.

Bear in mind that the outside temperature display indicates the measured air temperature and not the road surface temperature.

The outside temperature display is in the multifunction display (> page 152).

Changes in the outside temperature are displayed after a short delay.

#### Coolant temperature gauge

#### WARNING

Opening the hood when the engine is overheated or when there is a fire in the engine compartment could expose you to hot gases or other service products. There is a risk of injury.

Let an overheated engine cool down before opening the hood. If there is a fire in the engine compartment, keep the hood closed and contact the fire department.

**!** A display message is shown if the coolant temperature is too high.

If the coolant temperature is over 248 °F (120 °C), do not continue driving. The engine will otherwise be damaged.

The coolant temperature display is in the lower section of the tachometer (▷ page 33).

Under normal operating conditions and with the specified coolant level, the coolant temperature may rise to 248 °F (120 °C).

**Operating the on-board computer**

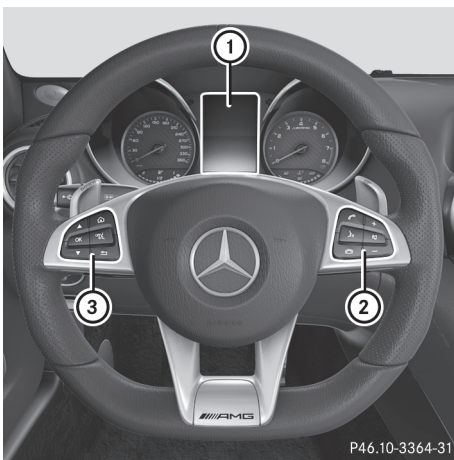

- ① Multifunction display
- ② Right control panel
- ③ Left control panel

▶ **To activate the on-board computer:** set the Start/Stop button to key position **1**.





You can control the multifunction display and the settings in the on-board computer using the buttons on the multifunction steering wheel.

**Left control panel**

|      |  |
|------|--|
|      | <ul style="list-style-type: none"> <li>• Opens the menu list</li> </ul>  |
| <br> | <p><b>Press briefly:</b></p> <ul style="list-style-type: none"> <li>• Scrolls in lists</li> <li>• Selects a menu or function</li> <li>• In the <b>Radio</b> or <b>Media</b> menu: opens the track or station list and selects a station, an audio track or a video scene</li> <li>• In the <b>Telephone</b> menu: switches to the phone book and selects a name or a telephone number</li> </ul> |
| <br> | <p><b>Press and hold:</b></p> <ul style="list-style-type: none"> <li>• Scrolls quickly through all lists</li> <li>• In the <b>Radio</b> or <b>Media</b> menu: selects a station, audio track or video scene using rapid scrolling</li> <li>• In the <b>Telephone</b> menu: starts rapid scrolling if the phone book is open</li> </ul>   |
|      | <ul style="list-style-type: none"> <li>• In all menus: confirms the selected entry in the list</li> <li>• In the <b>Radio</b> or <b>Media</b> menu: opens the list of available radio sources or media</li> <li>• In the <b>Telephone</b> menu: switches to the phone book and starts dialing the selected number</li> </ul>   |
|      | <ul style="list-style-type: none"> <li>• Switches off the Voice Control System (see the Digital Operator's Manual)</li> </ul>  |
|      | <p><b>Press briefly:</b></p> <ul style="list-style-type: none"> <li>• Back</li> <li>• In the <b>Radio</b> or <b>Media</b> menu: deselects the track or station list or list of available radio sources or media</li> <li>• Hides display messages</li> <li>• Exits the telephone book/redial memory</li> </ul>   |
|      | <p><b>Press and hold:</b></p> <ul style="list-style-type: none"> <li>• Calls up the standard display in the <b>Trip</b> menu</li> </ul>  |

P46.10-3364-31

**Right control panel**

|   |  |
|---|--|
|  | <ul style="list-style-type: none"> <li>Rejects or ends a call</li> <li>Exits the telephone book/redial memory</li> </ul>   |
|  | <ul style="list-style-type: none"> <li>Makes or accepts a call</li> <li>Switches to the redial memory</li> </ul>           |
|  | <ul style="list-style-type: none"> <li>Adjusts the volume</li> </ul>   |
|  | <ul style="list-style-type: none"> <li>Mute</li> </ul>   |
|  | <ul style="list-style-type: none"> <li>Switches on the Voice Control System (see the Digital Operator's Manual)</li> </ul> |

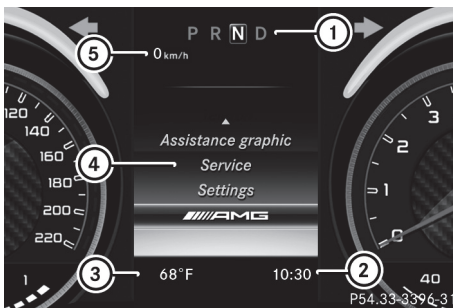
**Multifunction display**



- ① Transmission position (▷ page 110)
- ② Time
- ③ Outside temperature (▷ page 150)
- ④ Display
- ⑤ Additional speedometer (▷ page 161)



Display panel ④ shows the selected menu or submenu and display messages.

Additional speedometer ⑤ displays the speed in the respective unit that is not shown in the multifunction display.

- ▶ **To open the menu list:** press  on the steering wheel.
- Display panel ④ appears in the menu list.

Possible displays in the multifunction display:

-  Parking Assist PARKTRONIC (▷ page 138)
-  Cruise control (▷ page 125)
-  Adaptive Highbeam Assist (▷ page 89)

-  ECO start/stop function (▷ page 104)
-  HOLD function (▷ page 135)

**Menus and submenus****Menu overview**

Press the  button on the steering wheel to open the menu list.

Operating the on-board computer (▷ page 151).

Depending on the vehicle equipment, you can select the following menu:

- **Trip** menu (▷ page 152)
- **Navi** menu (navigation instructions) (▷ page 154)
- **Radio** menu (▷ page 155)
- **Media** menu (▷ page 156)
- **Telephone** menu (▷ page 157)
- **Assistance Graphic** menu (▷ page 158)
- **Service** menu (▷ page 159)
- **Settings** menu (▷ page 159)
- **AMG** menu (▷ page 161)

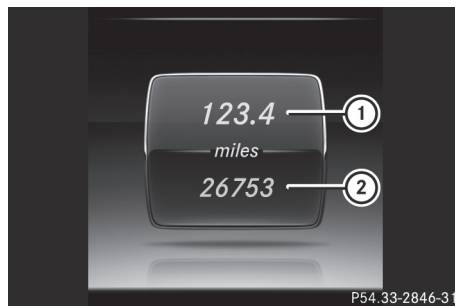
**Trip menu****Standard display**

- ▶ Press and hold the  button on the steering wheel until the **Trip** menu with trip odometer ① and odometer ② appears.



### Calling up the range

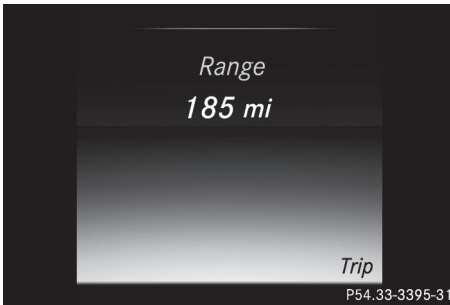

- ▶ Press the button on the steering wheel to open the menu list.
- ▶ Press or on the steering wheel to select the **Trip** menu.
- ▶ Press or to select the approximate **Range**.

The approximate range that can be covered depends on the fuel level and your current driving style. If there is only a small amount of fuel left in the fuel tank, a vehicle being refueled appears instead of approximate range.

### Trip computer "From Start" or "From Reset"

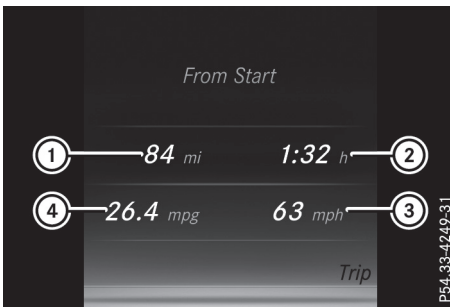

- ① Distance
  - ② Driving time
  - ③ Average speed
  - ④ Average fuel consumption
- ▶ Press on the steering wheel to open the menu list.
  - ▶ Press or on the steering wheel to select the **Trip** menu.

- ▶ Confirm by pressing on the steering wheel.
- ▶ Press or to select **From Start** or **From Reset**.

The values in the **From Start** submenu are calculated from the start of a journey, while the values in the **From Reset** submenu are calculated from the last time the submenu was reset (▷ page 153).

In the following cases the trip computer is automatically reset **From Start**:

- the ignition has been switched off for more than four hours.
- 999 hours have been exceeded.
- 9,999 miles have been exceeded.

The **From Reset** trip computer is automatically reset if the value exceeds 9,999 hours or 99,999 miles.

### Digital speedometer

- ▶ Press on the steering wheel to open the menu list.
- ▶ Press or on the steering wheel to select the **Trip** menu.
- ▶ Confirm by pressing on the steering wheel.
- ▶ Press the or button to select the digital speedometer.

### Resetting values

- ▶ Press on the steering wheel to open the menu list.
- ▶ Press or on the steering wheel to select the **Trip** menu.
- ▶ Confirm by pressing on the steering wheel.
- ▶ Press the or button to select the function that you wish to reset.
- ▶ Press the button.
- ▶ Press to select **Yes** and press to confirm.





You can reset the values of the following functions:

- Trip odometer
- "From Start" trip computer
- "From Reset" trip computer

## Navigation system menu

### Displaying navigation instructions

In the **Navi** menu, the multifunction display shows navigation instructions. You can find further information on navigation instructions in the multimedia system in the Digital Operator's Manual.

- ▶ Switch on the multimedia system (see the Digital Operator's Manual)
- ▶ Press the  button on the steering wheel to open the menu list.
- ▶ Press  or  on the steering wheel to select the **Navi** menu.
- ▶ Confirm by pressing  on the steering wheel.

### Route guidance not active

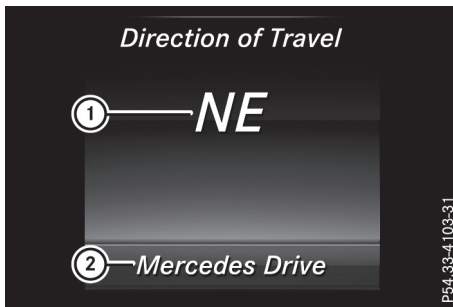

- ① Direction of travel
- ② Current road

### Route guidance active

#### No change of direction announced

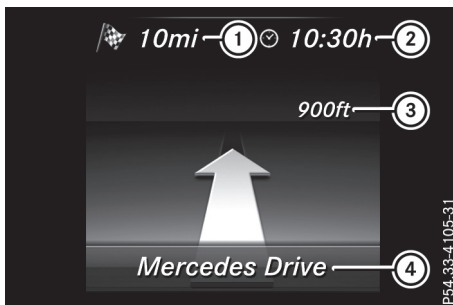

- ① Distance to the next destination
- ② Estimated arrival time

- ③ Distance to the next change of direction
- ④ Current road

### Change of direction announced with a lane recommendation

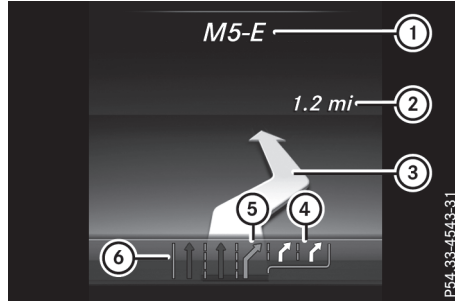

- ① Road into which the change of direction leads
- ② Distance to the change of direction
- ③ Change-of-direction symbol
- ④ Recommended lane and new lane during a change of direction (white)
- ⑤ Possible lane
- ⑥ Lane not recommended (dark gray)

On multilane roads, new lane recommendations can be displayed for the next change of direction if the digital map supports this data. During the change of direction, new lanes may be added.

Lane not recommended ⑥: you will not be able to complete the next change of direction if you stay in this lane.

Possible lane ⑤: you will only be able to complete the next change of direction in this lane.

Recommended lane ④: in this lane you will be able to complete the next change of direction and the one after that.

**Change of direction without lane recommendation**

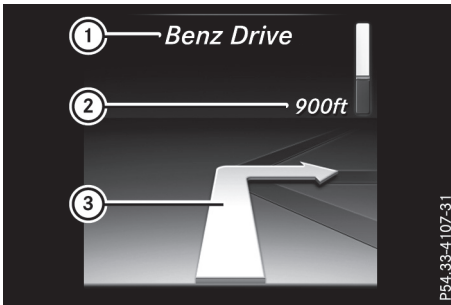

- ① Road into which the change of direction leads
- ② Distance to change of direction and visual distance display
- ③ Change-of-direction symbol

When a change of direction is to be made, you will see symbol ③ for the change of direction and distance graphic ②. The distance indicator shortens towards the top of the display as you approach the point of the announced change of direction. The change of direction starts once the distance display reaches zero.

**Change of direction with lane recommendation**

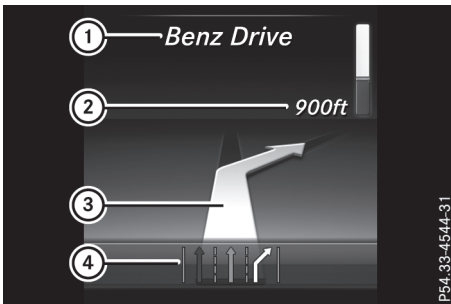

- ① Road into which the change of direction leads
- ② Distance to change of direction and visual distance display
- ③ Change-of-direction symbol
- ④ Lane recommendation

**Other status indicators of the navigation system**



- ① Additional information

Other possible additional information:

- **New Route...** or **Calculating Route...**  
A new route is calculated.
- **Road Not Mapped**

The vehicle position is inside the area of the digital map but the road is not recognized, e.g. newly built streets, car parks or private land.

- **No Route**  
No route could be calculated to the selected destination.
-  **No Route**  
You have reached the destination or an intermediate destination.

**Radio menu**

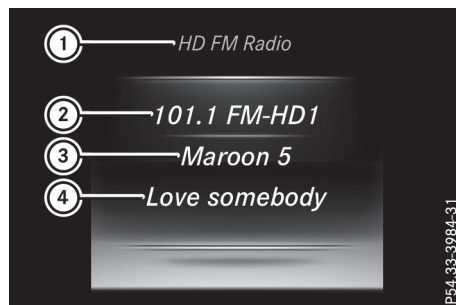















- ① Frequency range
- ② Station frequency with memory position
- ③ Name of artist
- ④ Name of track

The multifunction display shows station ② with station frequency or station name. The preset

position is only displayed along with station ② if this has been stored.

You can store TV channels ② in the multimedia system.

- ▶ Switch on the multimedia system (see the Digital Operator's Manual)
- ▶ Press  on the steering wheel to open the menu list.
- ▶ Press  or  on the steering wheel to select the **Radio** menu.
- ▶ Confirm by pressing  on the steering wheel. Currently set station ② appears in the multi-function display.
- ▶ **To open the station list:** press  or  briefly.
- ▶ **To select a station in the station list:** press  or  briefly.
- ▶ **To select a station in the station list using rapid scroll:** press and hold  or .
- ▶ **To select the frequency range or station memory:** press  briefly.
- ▶ Press  or  to select the frequency range or station memory.
- ▶ Press  to confirm your selection.





**i** SIRIUS XM satellite radio functions like a normal radio.

Further information on radio mode can be found in the multimedia system (see the Digital Operator's Manual).

## Media menu

### Changing the media source

You can change the media source and playback mode (audio or video) at any time in the **Media** menu.

- ▶ Switch on the multimedia system (see the Digital Operator's Manual)
- ▶ Press  on the steering wheel to open the menu list.
- ▶ Press  or  on the steering wheel to select the **Media** menu.
- ▶ Confirm by pressing  on the steering wheel.
- ▶ **To open/close the media sources list:** press  briefly. The list shows the following media sources, for example:

- Disc (CD/DVD) (DVD COMAND only)
- SD card (COMAND)
- Media Register (COMAND)
- USB storage device
- Bluetooth® capable audio device











Please observe further information on media support and media operation in the multimedia system (see the Digital Operator's Manual).

### Operating an audio player or audio media



- ① Media source, e.g. name of USB memory stick
- ② Current title
- ③ Name of artist
- ④ Name of album
- ⑤ Folder name

Audio data from various audio devices or media can be played, depending on the equipment installed in the vehicle.

- ▶ Switch on the multimedia system (see the Digital Operator's Manual)
- ▶ Use  on the steering wheel to call up the list of menus.
- ▶ Press  or  on the steering wheel to select the **Media** menu.
- ▶ Confirm by pressing  on the steering wheel.
- ▶ **To select audio player or data carrier:** press  briefly, to open the list of media sources.
- ▶ Press  or  to select the corresponding audio player or media.
- ▶ Press  to confirm.
- ▶ **To open the track list:** press  or  briefly.

- ▶ **To select to next or previous track in the track list:** press or briefly.
- ▶ **To select a track from the track list using rapid scrolling:** press and hold or until the desired track is reached.

If you press and hold the button, the speed of rapid scroll increases after a short time. Not all audio drives or data carriers support this function.

If the corresponding track information is stored on the audio drive or audio media, the multi-function display may display the following:

- track number
- track name
- artist
- album

### Video DVD operation

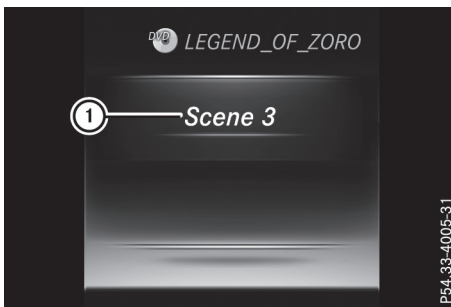

- ▶ Switch on the multimedia system (see the Digital Operator's Manual)
- ▶ Use on the steering wheel to call up the list of menus.
- ▶ Press or on the steering wheel to select the **Media** menu.
- ▶ Confirm by pressing on the steering wheel.
- ▶ **To select DVD single drive or data medium:** press briefly, to open the list of media sources.
- ▶ Press or to select the corresponding DVD single drive or disc.
- ▶ Press to confirm.
- ▶ **To open the scene list:** press or briefly.
- ▶ **To select the next or previous scene in the scene list:** press or briefly.

- ▶ **To select a scene from the scene list using rapid scrolling:** press and hold or until desired scene ① is reached.
- ▶ Press to confirm your selection.

### Telephone menu

#### Introduction

#### WARNING

If you operate information systems and communication equipment integrated in the vehicle when driving, you may be distracted from the traffic situation. You could also lose control of the vehicle. There is a risk of an accident.

Only operate this equipment when the traffic situation permits. If you are not sure that this is possible, park the vehicle paying attention to traffic conditions and operate the equipment when the vehicle is stationary.

When telephoning, you must observe the legal requirements for the country in which you are currently driving.

- ▶ Switch on the mobile phone (see the manufacturer's operating instructions).
- ▶ Switch on the multimedia system (see the Digital Operator's Manual)
- ▶ Establish a Bluetooth® connection to the multimedia system (see the Digital Operator's Manual).
- ▶ Press the button on the steering wheel to call up the list of menus.
- ▶ Press or on the steering wheel to select the **Telephone** menu.
- ▶ Confirm by pressing on the steering wheel.

You will see one of the following display messages in the multifunction display:

- **Phone READY** or the name of the network provider: the mobile phone has found a network and is ready to receive.
- **Phone No Service:** there is no network available or the mobile phone is searching for a network.

### Accepting a call

If someone calls you when you are in the **Telephone** menu, a display message appears in the multifunction display.

You can accept a call at any time, even if you are not in the **Telephone** menu.









- ▶ Press the  button on the steering wheel to accept an incoming call.

### Rejecting or ending a call



You can end or reject a call at any time even if you are not in the **Telephone** menu.



- ▶ Press the  button on the steering wheel to reject or end a call.

### Selecting an entry in the phone book

- ▶ Press  on the steering wheel to open the menu list.
- ▶ Press  or  on the steering wheel to select the **Telephone** menu.
- ▶ Confirm by pressing  on the steering wheel.
- ▶ Press the ,  or  button to switch to the phone book.
- ▶ Press  or  to select the names one after the other.

or







- ▶ **To start rapid scrolling:** press and hold  or  for longer than one second. The names in the phone book are displayed quickly one after the other.

If you press and hold the  or  button for longer than five seconds, the name appears with the next or previous letter initial letter in the alphabet.



Rapid scrolling stops when you release the button or reach the end of the list.

- ▶ **If only one telephone number is stored for a name:** press the  or  button to start dialing.

or









- ▶ **If there is more than one number for a particular name:** press the  or  button to display the numbers.
- ▶ Press the  or  button to select the number you want to dial.
- ▶ Press the  or  button to start dialing.

or



- ▶ **To exit the phone book:** press the  or  button.

### Redialing

The on-board computer saves the last names or numbers dialed in the redial memory.





- ▶ Press  on the steering wheel to open the menu list.
- ▶ Press  or  on the steering wheel to select the **Telephone** menu.
- ▶ Confirm by pressing  on the steering wheel.
- ▶ Press the  button to switch to the redial memory.
- ▶ Press the  or  button to select the desired name or number.
- ▶ Press the  or  button to start dialing.

or

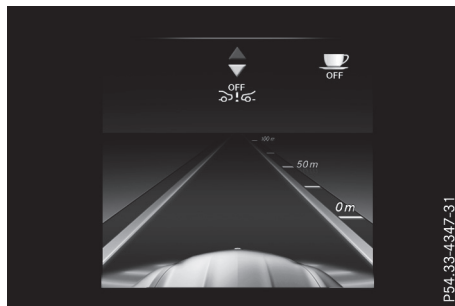
- ▶ **To exit the redial memory:** press the  or  button.

### Assistance graphic menu



- ▶ Use  on the steering wheel to call up the list of menus.
- ▶ Press the  or  button on the steering wheel to select the **Assistance Graphic** menu.
- ▶ Confirm by pressing  on the steering wheel. The multifunction display shows the Distance Pilot DISTRONIC distance display in the assistance graphic display.

The assistance graphic displays the status of and information from the following driving systems or driving safety systems:

- Distance Pilot DISTRONIC (▷ page 127)
  - Distance warning function of Active Brake Assist (▷ page 57)
  - Blind Spot Assist (▷ page 146)
  - ATTENTION ASSIST (▷ page 144)
  - Lane Keeping Assist (▷ page 148)
- ▶ Press  to display the ATTENTION ASSIST assessment.

### Service menu

Depending on the equipment installed in the vehicle, you have the following options in the **Service** menu:

- Calling up display messages in message memory (▷ page 165)
- Checking the tire pressure electronically (▷ page 259)
- Calling up the service due date (▷ page 232)
- Checking the engine oil level using the on-board computer (▷ page 228)

### Settings menu







#### Introduction





Depending on the equipment installed in the vehicle, you have the following options in the **Settings** menu:

- Changing assistance settings (▷ page 159)
- Changing the light settings (▷ page 160)
- Changing the instrument cluster settings (▷ page 160)
- Restoring the factory settings (▷ page 161)

#### Assistance submenu

#### Activating or deactivating Active Brake Assist

- ▶ Press  on the steering wheel to open the menu list.
- ▶ Press  or  on the steering wheel to select the **Settings** menu.
- ▶ Confirm by pressing  on the steering wheel.
- ▶ Press  or  to select the **DriveAssist** submenu.











- ▶ Press  to confirm.
  - ▶ Select **Brake Assist** with  or .
  - ▶ Press  to confirm.
- The current selection appears.

- ▶ **To activate/deactivate:** press the  button again.

When Active Brake Assist is deactivated, the  symbol appears in the **Assistance Graphic** menu of the multifunction display.

Further information on Active Brake Assist (▷ page 57).

#### Activating/deactivating Blind Spot Assist

- ▶ Press  on the steering wheel to open the menu list.
- ▶ Press  or  on the steering wheel to select the **Settings** menu.
- ▶ Confirm by pressing  on the steering wheel.
- ▶ Press  or  to select the **DriveAssist** submenu.
- ▶ Press  to confirm.
- ▶ Press  or  to select **Blind Spot Assist**.
- ▶ Press  to confirm.











The current selection appears.

- ▶ **To activate/deactivate:** press the  button again.





When Blind Spot Assist is activated, gray radar waves propagating backwards appear next to the vehicle in the **Assistance Graphic** menu in the multifunction display.

For further information about Blind Spot Assist, see (▷ page 146).

#### Setting ATTENTION ASSIST













- ▶ Press  on the steering wheel to open the menu list.
- ▶ Press  or  on the steering wheel to select the **Settings** menu.
- ▶ Confirm by pressing  on the steering wheel.
- ▶ Press  or  to select the **DriveAssist** submenu.
- ▶ Press  to confirm.
- ▶ Select **Attention Assist** with  or .
- ▶ Press  to confirm.



- ▶ Press  or  to select **Off, Standard** or **Sensitive**.
- ▶ Press  to confirm the selection. When ATTENTION ASSIST is deactivated, the  symbol appears in the **Assistance Graphic** menu in the multifunction display.

For further information about ATTENTION ASSIST, see (▷ page 144).

### Setting Lane Keeping Assist











- ▶ Press the  button on the steering wheel to open the menu list.
- ▶ Press the  or  button on the steering wheel to select the **Settings** menu.
- ▶ Confirm by pressing  on the steering wheel.
- ▶ Press  or  to select the **DriveAssist** submenu.
- ▶ Press  to confirm.
- ▶ Press  or  to select **Lane Keeping Assist**.
- ▶ Press  to confirm. Press  or  to select **Off, Standard** or **Adaptive**.
- ▶ **To change the setting:** press  again.

Further information about Lane Keeping Assist (▷ page 148).

### Light submenu

#### Switching the daytime running lamps on/off

This function is not available in Canada.











- ▶ Press  on the steering wheel to open the menu list.
- ▶ Press  or  on the steering wheel to select the **Settings** menu.
- ▶ Confirm by pressing  on the steering wheel.
- ▶ Press  or  to select the **Lights** submenu.
- ▶ Press  to confirm.
- ▶ Using  or , select the **Daytime Running Lights** function. If the **Daytime Running Lights** function has been switched on, the cone of light and the  symbol in the multifunction display are shown in white.
- ▶ Press the  button to save the setting.

Further information about **Daytime Running Lights**(▷ page 87).





### Instrument cluster submenu

#### Setting the brightness of the display/switch

You can use the **Brightness** function to set the brightness of the multifunction display and the switches in the vehicle in increments.











- ▶ Press the  button on the steering wheel to open the menu list.
- ▶ Press  or  on the steering wheel to select the **Settings** menu.
- ▶ Confirm by pressing  on the steering wheel.
- ▶ Press  or  to select the **Instrument Cluster** submenu.
- ▶ Press  to confirm.
- ▶ Using  or , select the **Brightness** function.
- ▶ Press  to confirm.

You can see the selected setting **Level** with a value between 0 and 10. Level 0 corresponds to a dim light and level 10 corresponds to a bright light.

- ▶ Press the  or  button to change the brightness. The brightness is set simultaneously with the selection.
- ▶ Press the  or  button to save the setting.

#### Selecting the distance unit

The **Display Unit Speed-/Odometer**: function allows you to choose whether certain displays appear in kilometers or miles in the multifunction display.

- ▶ Use  on the steering wheel to call up the list of menus.
- ▶ Press the  or  button on the steering wheel to select the **Settings** menu.
- ▶ Confirm by pressing  on the steering wheel.
- ▶ Press the  or  button to select the **Instrument Cluster** submenu.
- ▶ Press  to confirm.
- ▶ Press the  or  button to select the **Display Unit Speed-/Odometer** function. You will see the selected setting: **km** or **Miles**.
- ▶ Press the  button to save the setting.











The selected unit of measurement for distance applies to:

- Digital speedometer in the **Trip** menu
- Odometer and the trip odometer
- Trip computer
- Range
- Navigation instructions in the **Navi** menu
- Cruise control
- Distance Pilot DISTRONIC
- ASSYST PLUS service interval display







### Switching the additional speedometer on/off



If the additional speedometer is switched on, the speed is shown in the status bar in the multifunction display instead of the outside temperature.

The additional speedometer displays the speed in the respective unit that is not shown in the multifunction display.

- ▶ Press the  button on the steering wheel to open the menu list.
- ▶ Press  or  on the steering wheel to select the **Settings** menu.
- ▶ Confirm by pressing  on the steering wheel.
- ▶ Press  or  to select the **Instrument Cluster** submenu.
- ▶ Press  to confirm.
- ▶ Using  or , select the **Additional Speedometer [km/h]** function. The current selection appears.
- ▶ **To activate/deactivate:** press the  button again.

### Restoring the factory settings

- ▶ Press  on the steering wheel to open the menu list.
- ▶ Press  or  on the steering wheel to select the **Settings** menu.
- ▶ Confirm by pressing  on the steering wheel.
- ▶ Press  or  to select the **Factory Settings** submenu.
- ▶ Press  to confirm. The **Reset All Settings?** function appears.





- ▶ Press  or  to select **No** or **Yes**.
- ▶ Press  to confirm the selection. If you have selected **Yes**, the multifunction display shows a confirmation message.

For safety reasons, the **Daytime Running Lights** function in the **Lights** submenu is only reset when the vehicle is stationary.

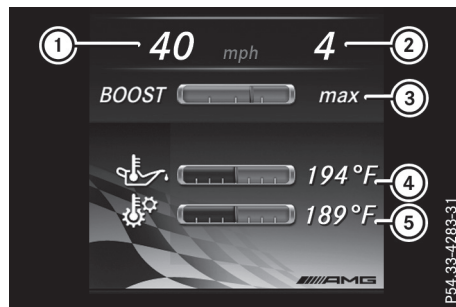
### AMG menu

#### Warm-up



- ① Digital speedometer
- ② Gear indicator
- ③ Charge-air pressure
- ④ Engine oil temperature
- ⑤ Transmission oil temperature
- ▶ Use  on the steering wheel to call up the list of menus.
- ▶ Press the  or  button on the steering wheel to select the **AMG** menu.
- ▶ Confirm by pressing  on the steering wheel.

**Engine and transmission oil temperatures:** when the engine and transmission are at normal operating temperature, oil temperatures ④ and ⑤ are displayed in white in the multifunction display.

If the multifunction display shows oil temperature ④ or ⑤ in blue, the engine or the transmission are not yet at normal operating temperature. Avoid driving at full engine output during this time.

P54.33-4283-31

## G-Meter

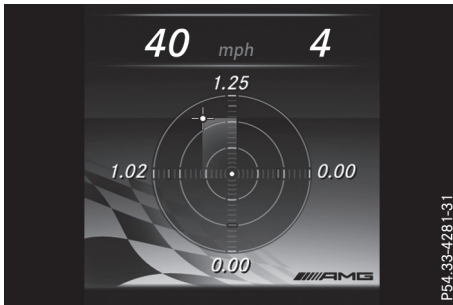

The G-Meter shows you the forces that are exerted on the driver during the journey, both laterally and in the direction of travel.

The maximum values are indicated in red in the guideline system.

- ▶ Press on the steering wheel to open the menu list.
- ▶ Press the or button on the steering wheel to select the **AMG** menu.
- ▶ Confirm by pressing on the steering wheel.
- ▶ Press the button repeatedly until the G-Meter appears.  
The maximum values of the G-Meter are saved.
- ▶ **To reset the G-Meter:** press again.
- ▶ Using or select **Yes** on the steering wheel.
- ▶ Press to confirm.  
The maximum values of the G-Meter are deleted.

If the ignition remains switched off for longer than four hours, the G-Meter will be automatically reset.

## SETUP

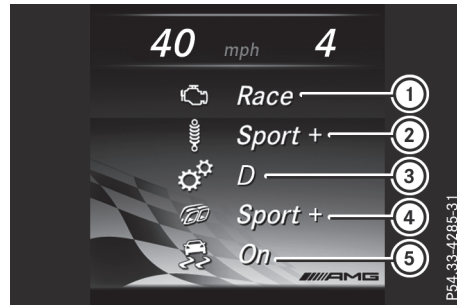

- ① Drive **Comfort/Sport/Sport +/ Race**
- ② Chassis **Comfort/Sport/Sport +**
- ③ Transmission **D/M**
- ④ Exhaust system **Comfort/Sport +**
- ⑤ ESP® **On/Off** or SPORT handling mode **Sport**

SETUP displays the following information and functions:

- the gear indicator
- the digital speedometer
- the drive system setting
- the suspension mode
- the transmission position
- the exhaust flap position
- the ESP® (Electronic Stability Program) status
- ▶ Use on the steering wheel to call up the list of menus.
- ▶ Press the or button on the steering wheel to select the **AMG** menu.
- ▶ Confirm by pressing on the steering wheel.
- ▶ Press the button repeatedly until SETUP is displayed.

Further information on the upshift indicator and gear indicator (▷ page 114).

## RACETIMER

### Displaying and starting RACETIMER

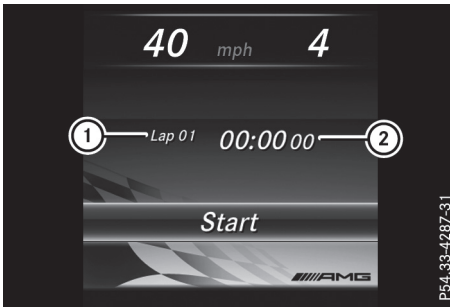

P54.33-4287-31

- ① Lap
- ② RACETIMER

The RACETIMER is only intended for use on a closed race circuit. Do not use the function on public roads.

You can start the RACETIMER when the engine is running or if the key is in position **2** in the ignition lock.

- ▶ Use on the steering wheel to call up the list of menus.
- ▶ Press the or button on the steering wheel to select the **AMG** menu.
- ▶ Confirm by pressing on the steering wheel.
- ▶ Press the or button repeatedly until the RACETIMER is shown.
- ▶ **To start:** press the button to start the RACETIMER.

### Starting a new lap



P54.33-4289-31

- ① Lap
- ② RACETIMER
- ③ Quickest lap time

- ▶ Press the or button to select **New Lap**.

- ▶ Press to confirm.

A maximum of 32 laps may be stored.

### Stopping the RACETIMER

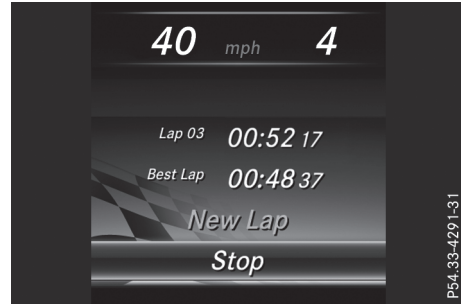

P54.33-4291-31

- ▶ Press the or button to select **Stop**.

- ▶ Press to confirm.

If you stop the vehicle and select key position **1**, the RACETIMER interrupts timing. If you select key position **3** with the Start/Stop button and then press **Start** to confirm, timing is continued.

### Continuing the RACETIMER

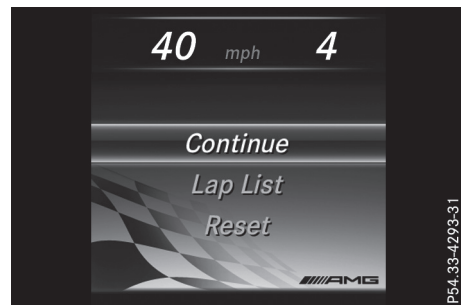

P54.33-4293-31

- ▶ Press the or button to select **Continue**.

- ▶ Press to confirm.

### Resetting the RACETIMER



- ▶ Press the or button to select **Stop**. The RACETIMER is stopped.
- ▶ Press the or button to select **Reset**.
- ▶ Press to confirm. All laps are deleted.

- ③ Average lap speed
- ④ Lap length

This function is only available if you have stored at least two laps and have stopped the RACETIMER.

- ▶ Use on the steering wheel to call up the list of menus.
- ▶ Press the or button on the steering wheel to select the **AMG** menu.
- ▶ Confirm by pressing on the steering wheel.
- ▶ Press or to select **Lap List**.
- ▶ Press to confirm. The lap statistics are displayed.
- ▶ Press the or button to select a different lap evaluation. The fastest lap is indicated by flashing symbol ①.

### Lap statistics

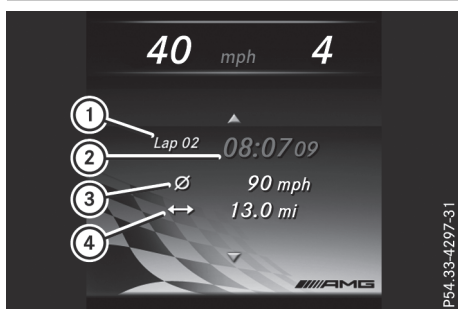

- ① Lap
- ② Lap time

## Display messages

### Introduction

#### General notes

Display messages appear in the multifunction display.

Display messages with graphic displays may be shown in simplified form in the Operator's Manual and may therefore differ from the multifunction display.

Please respond in accordance with the display messages and follow the additional notes in this Operator's Manual.

With certain display messages, you will also hear a warning tone.

You can hide the display messages. The display messages are then stored in the message memory. Rectify the cause of a display message as soon as possible.

When you stop and park the vehicle, please observe the notes on:

- HOLD function (▷ page 135)
- Parking (▷ page 118)

### Hiding display messages

---

- ▶ Press the  or  button on the steering wheel.  
The multifunction display hides the display message.









High-priority display messages are shown in red in the multifunction display. Some high-priority display messages cannot be hidden.

The multifunction display shows these messages continuously until the causes for the messages have been remedied.

### Message memory

---

The on-board computer saves certain display messages in the **message memory**. You can call up the display messages:

- ▶ Use  on the steering wheel to call up the list of menus.
- ▶ Press  or  on the steering wheel to select the **Service** menu.
- ▶ Confirm by pressing  on the steering wheel.
- ▶ Press the  or  button to select the message memory.  
If there are no display messages, the **No Messages** display appears in the multifunction display  
If there are display messages, the number of messages stored is shown.
- ▶ Press  to confirm.
- ▶ Press the  or  button to scroll through the display messages.

## Safety systems



## Display messages



Currently Unavailable See Operator's Manual

## Possible causes/consequences and ► Solutions

ABS (Anti-lock Braking System) and ESP<sup>®</sup> (Electronic Stability Program) are temporarily not available.  
Other driving systems and driving safety systems may also malfunction.

In addition, the  and  warning lamps light up in the instrument cluster.

For example, the on-board voltage may be insufficient.

 **WARNING**

The brake system continues to function normally, but without the functions listed above. The wheels could therefore lock if you brake hard, for example.

The steerability and braking characteristics may be severely affected. The braking distance in an emergency braking situation can increase.

If ESP<sup>®</sup> is not operational, ESP<sup>®</sup> is unable to stabilize the vehicle.

There is an increased risk of skidding and an accident.

► Drive on carefully.

Carefully drive on a suitable stretch of road, making slight steering movements at a speed above 12 mph (20 km/h).

If the display message disappears, the functions mentioned above are available again.

If the multifunction display still shows the display message:

► Drive on carefully.





► Visit a qualified specialist workshop immediately.



Inoperative See Operator's Manual

ABS and ESP<sup>®</sup> are malfunctioning.

Other driving systems and driving safety systems may also malfunction.

The  (USA only) or  (Canada only),  and  warning lamps in the instrument cluster may also light up.

 **WARNING**

The brake system continues to function normally, but without the functions listed above. The wheels could therefore lock if you brake hard, for example.

The steerability and braking characteristics may be severely affected. The braking distance in an emergency braking situation can increase.







If ESP<sup>®</sup> is not operational, ESP<sup>®</sup> is unable to stabilize the vehicle.















There is an increased risk of skidding and an accident.







► Drive on carefully.













► Visit a qualified specialist workshop immediately.

















| Display messages   | Possible causes/consequences and ► Solutions   |
|--|--|
|  <p>Inoperative See Operator's Manual</p>           | <p>ESP® is malfunctioning.<br/>Other driving systems and driving safety systems may also malfunction.<br/>The  warning lamp also lights up in the instrument cluster.</p> <p> <b>WARNING</b></p> <p>The brake system continues to function normally, but without the functions listed above.<br/>The braking distance in an emergency braking situation can thus increase.<br/>If ESP® is not operational, ESP® is unable to stabilize the vehicle. There is an increased risk of skidding and an accident.</p> <ul style="list-style-type: none"> <li>► Drive on carefully.</li> <li>► Visit a qualified specialist workshop immediately.</li> </ul>  |
|  <p>Currently Unavailable See Operator's Manual</p> | <p>ESP® is temporarily unavailable.<br/>Other driving systems and driving safety systems may also malfunction.<br/>The  warning lamp also lights up in the instrument cluster.<br/>The self-diagnosis function might not be complete, for example.</p> <p> <b>WARNING</b></p> <p>The brake system continues to function normally, but without the functions listed above. The wheels could therefore lock if you brake hard, for example.<br/>The braking distance in an emergency braking situation can thus increase.<br/>If ESP® is not operational, ESP® is unable to stabilize the vehicle. There is an increased risk of skidding and an accident.</p> <ul style="list-style-type: none"> <li>► Carefully drive on a suitable stretch of road, making slight steering movements at a speed above 12 mph (20 km/h).<br/>If the display message disappears, the functions mentioned above are available again.</li> </ul> <p>If the multifunction display still shows the display message:</p> <ul style="list-style-type: none"> <li>► Drive on carefully.</li> <li>► Visit a qualified specialist workshop immediately.</li> </ul> |







| Display messages   | Possible causes/consequences and ► Solutions   |
|--|--|
|    <p data-bbox="181 360 385 413">Inoperative See Operator's Manual</p> | <p data-bbox="438 270 1102 324">EBD (electronic brake force distribution), ABS and ESP<sup>®</sup> are malfunctioning.</p> <p data-bbox="438 327 1096 381">Other driving systems and driving safety systems may also malfunction.</p> <p data-bbox="438 385 1096 439">In addition, the  and  warning lamps light up in the instrument cluster and a warning tone sounds.</p> <p data-bbox="448 449 602 476"><b>▲ WARNING</b></p> <p data-bbox="438 489 1102 569">The brake system continues to function normally, but without the functions listed above. The front and rear wheels could therefore lock if you brake hard, for example.</p> <p data-bbox="438 573 1102 654">The steerability and braking characteristics may be severely affected. The braking distance in an emergency braking situation can increase. If ESP<sup>®</sup> is not operational, ESP<sup>®</sup> is unable to stabilize the vehicle.</p> <p data-bbox="438 657 964 684">There is an increased risk of skidding and an accident.</p> <ul data-bbox="438 693 938 754" style="list-style-type: none"> <li>► Drive on carefully.</li> <li>► Visit a qualified specialist workshop immediately.</li> </ul> |
|  <p data-bbox="181 827 389 854">Brake Immediately</p>   | <p data-bbox="438 779 1102 833">A malfunction has occurred while the HOLD function or Distance Pilot DISTRONIC was activated.</p> <p data-bbox="438 836 1102 890">A tone may also sound at regular intervals. If you attempt to lock the vehicle, the tone becomes louder.</p> <p data-bbox="438 894 714 921">You cannot start the engine.</p> <ul data-bbox="438 930 1096 1008" style="list-style-type: none"> <li>► Paying attention to the traffic situation, immediately depress the brake pedal firmly and hold until the display message disappears.</li> <li>► Secure the vehicle against rolling away (▷ page 118).</li> </ul>   |
| <p data-bbox="190 1035 330 1071"><b>PARK</b> (USA only)</p> <p data-bbox="240 1080 411 1143"> (Canada only)</p> <p data-bbox="181 1148 411 1227">Turn On the Ignition to Release the Parking Brake</p>                                  | <p data-bbox="438 1030 1102 1084">The red  (USA only) or  (Canada only) indicator lamp lights up.</p> <p data-bbox="438 1087 1102 1141">You attempted to release the electric parking brake while the ignition was switched off.</p> <ul data-bbox="438 1150 681 1177" style="list-style-type: none"> <li>► Switch on the ignition.</li> </ul>   |
| <p data-bbox="190 1250 330 1286"><b>PARK</b> (USA only)</p> <p data-bbox="240 1295 411 1358"> (Canada only)</p> <p data-bbox="181 1363 418 1412">Please Release Parking Brake</p>   | <p data-bbox="438 1245 1102 1326">The red  (USA only) or  (Canada only) indicator lamp flashes and a warning tone sounds. A condition for automatic release of the electric parking brake is not fulfilled (▷ page 120).</p> <p data-bbox="438 1329 964 1356">You are driving with the electric parking brake applied.</p> <ul data-bbox="438 1365 892 1392" style="list-style-type: none"> <li>► Release the electric parking brake manually.</li> </ul> <p data-bbox="438 1406 1102 1460">The red  (USA only) or  (Canada only) indicator lamp flashes and a warning tone sounds.</p> <p data-bbox="438 1464 1050 1517">You are using the electric parking brake for emergency braking (▷ page 120).</p>   |

| Display messages   | Possible causes/consequences and ► Solutions   |
|--|--|
| <p><b>PARK</b> (USA only)  (Canada only)</p> <p><a href="#">Parking Brake See Operator's Manual</a></p> | <p>The yellow  warning lamp lights up.<br/>The electric parking brake is malfunctioning.</p> <p><b>To apply:</b></p> <ul style="list-style-type: none"> <li>► Switch the ignition off.</li> <li>► Press the electric parking brake handle for at least ten seconds.</li> <li>► Shift the transmission to position <b>P</b>.</li> <li>► Consult a qualified specialist workshop.</li> </ul> <hr/> <p>The yellow  warning lamp and the red <b>PARK</b> (USA only) or  (Canada only) indicator lamp light up.<br/>The electric parking brake is malfunctioning.</p> <p><b>To release:</b></p> <ul style="list-style-type: none"> <li>► Switch off the ignition and turn it back on.</li> <li>► Release the electric parking brake manually.</li> </ul> <p>or</p> <ul style="list-style-type: none"> <li>► Release the electric parking brake automatically (► page 120).</li> </ul> <p>If the electric parking brake still cannot be released:</p> <ul style="list-style-type: none"> <li>► Do not drive on.</li> <li>► Consult a qualified specialist workshop.</li> </ul> <hr/> <p>The red <b>PARK</b> (USA only) or  (Canada only) indicator lamp flashes and the yellow  warning lamp lights up.<br/>The electric parking brake is malfunctioning.</p> <p><b>To release:</b></p> <ul style="list-style-type: none"> <li>► Switch off the ignition and turn it back on.</li> <li>► Release the electric parking brake manually.</li> </ul> <p><b>To apply:</b></p> <ul style="list-style-type: none"> <li>► Switch off the ignition and turn it back on.</li> <li>► Apply the electric parking brake manually.</li> </ul> <p>If the red <b>PARK</b> (USA only) or  (Canada only) indicator lamp continues to flash:</p> <ul style="list-style-type: none"> <li>► Do not drive on.</li> <li>► Secure the vehicle against rolling away (► page 271).</li> <li>► Shift the transmission to position <b>P</b>.</li> <li>► Turn the front wheels towards the curb.</li> <li>► Consult a qualified specialist workshop.</li> </ul> |

| Display messages   | Possible causes/consequences and ► Solutions   |
|--|--|
|  | <p>The yellow  warning lamp lights up. The red  (USA only) or  (Canada only) indicator lamp flashes for about ten seconds after the electric parking brake has been applied or released. It then goes out or remains lit.</p> <p>The electric parking brake is malfunctioning.</p> <ul style="list-style-type: none"> <li>► Switch off the ignition and turn it back on.</li> <li>► Apply the electric parking brake.</li> </ul> <p>If it is not possible to engage the electric parking brake:</p> <ul style="list-style-type: none"> <li>► Shift the transmission to position .</li> <li>► Visit a qualified specialist workshop.</li> </ul> <p>If it is not possible to release the electric parking brake manually:</p> <ul style="list-style-type: none"> <li>► Release the electric parking brake automatically (&gt; page 120).</li> </ul> <p>If the electric parking brake still cannot be released:</p> <ul style="list-style-type: none"> <li>► Consult a qualified specialist workshop.</li> </ul>  |
| <p> (USA only)  (Canada only)</p> <p>Parking Brake Inoperative</p> | <p>The yellow  warning lamp lights up. If you manually apply or release the electric parking brake, the red  (USA only) or  (Canada only) indicator lamp flashes.</p> <p>The electric parking brake is malfunctioning. It is not possible to apply the electric parking brake manually.</p> <ul style="list-style-type: none"> <li>► Shift the transmission to position  as the electric parking brake is not applied automatically.</li> <li>► Visit a qualified specialist workshop.</li> </ul> <p>If it is not possible to release the electric parking brake manually:</p> <ul style="list-style-type: none"> <li>► Release the electric parking brake automatically (&gt; page 120).</li> </ul> <p>The yellow  warning lamp lights up. The red  (USA only) or  (Canada only) indicator lamp flashes for about ten seconds after the electric parking brake has been applied or released. It then goes out or remains lit.</p> <p>The electric parking brake is malfunctioning, e.g. because of overvoltage or undervoltage.</p> <ul style="list-style-type: none"> <li>► Remove the cause for the overvoltage or undervoltage, e.g. by charging the battery or restarting the engine.</li> <li>► Engage or release the electric parking brake.</li> </ul> <p>If it remains impossible to apply or release the electric parking brake:</p> <ul style="list-style-type: none"> <li>► Switch off the ignition and turn it back on.</li> <li>► Engage or release the electric parking brake.</li> </ul> <p>If the electric parking brake still cannot be released:</p> <ul style="list-style-type: none"> <li>► Consult a qualified specialist workshop.</li> </ul> <p>If the electric parking brake still cannot be applied:</p> <ul style="list-style-type: none"> <li>► Visit a qualified specialist workshop.</li> </ul> |

| Display messages  | Possible causes/consequences and ► Solutions   |
|---|--|
|   | <p>The yellow  warning lamp lights up and the red  (USA only) or  (Canada only) indicator lamp flashes.</p> <p>It is not possible to apply the electric parking brake manually.</p> <ul style="list-style-type: none"> <li>► Shift the transmission to position .</li> <li>► Visit a qualified specialist workshop.</li> </ul>  |
| <p> (USA only)<br/>  (Canada only)<br/>                     Check Brake Fluid Level</p> | <p>There is not enough brake fluid in the brake fluid reservoir.</p> <p>In addition, the  (USA only) or  (Canada only) warning lamp lights up in the instrument cluster and a warning tone sounds.</p> <p> <b>WARNING</b></p> <p>The braking effect may be impaired.<br/>                     There is a risk of an accident.</p> <ul style="list-style-type: none"> <li>► Pull over and stop the vehicle safely as soon as possible, paying attention to road and traffic conditions. Do not continue driving under any circumstances.</li> <li>► Secure the vehicle against rolling away (▷ page 118).</li> <li>► Consult a qualified specialist workshop.</li> <li>► Do not add brake fluid. This does not correct the malfunction.</li> </ul> |
| <p><br/>                     Check Brake Pad Wear</p>  | <p>The brake pads/linings have reached their wear limit.</p> <p>USA only: the red  brake system warning lamp also lights up while the engine is running.</p> <ul style="list-style-type: none"> <li>► Visit a qualified specialist workshop.</li> </ul>   |
| <p><br/>                     Inoperative</p>  | <p>One or more main features of the mbrace system are malfunctioning.</p> <ul style="list-style-type: none"> <li>► Have the mbrace system checked immediately at a qualified specialist workshop.</li> </ul>   |
| <p>Active Brake Assist Functions Currently Limited See Operator's Manual</p>  | <p>Active Brake Assist is temporarily inoperative.</p> <p>Possible causes are:</p> <ul style="list-style-type: none"> <li>• The radar sensor system is temporarily inoperative, e.g. due to electromagnetic radiation emitted by nearby TV or radio stations or other sources of electromagnetic radiation.</li> <li>• The system is outside the operating temperature range.</li> <li>• The on-board voltage is too low.</li> </ul> <p>When the causes stated above no longer apply, the display message disappears.</p> <p>Active Brake Assist is operational again.</p> <p>If the display message does not disappear:</p> <ul style="list-style-type: none"> <li>► Pull over and stop the vehicle safely as soon as possible, paying attention to road and traffic conditions.</li> <li>► Secure the vehicle against rolling away (▷ page 118).</li> <li>► Restart the engine.</li> </ul>   |

| Display messages  | Possible causes/consequences and ► Solutions  |
|---|---|
| Active Brake Assist Functions Limited<br>See Operator's Manual  | Active Brake Assist is unavailable due to a malfunction. Situation-dependent braking assistance may also have failed.<br>► Visit a qualified specialist workshop immediately.   |
| PRE-SAFE Inoperative<br>See Operator's Manual   | Important functions of PRE-SAFE® have failed. All other occupant safety systems, e.g. air bags, remain available.<br>► Visit a qualified specialist workshop immediately.   |
| Radar Sensors Dirty<br>See Operator's Manual  | At least one of the following driving systems or driving safety systems is temporarily restricted or inoperative:<br><ul style="list-style-type: none"> <li>• Active Brake Assist</li> </ul> Possible causes are:<br><ul style="list-style-type: none"> <li>• The sensors in the radiator trim and/or in the bumpers are dirty.</li> <li>• The function of the driving system or driving safety system is impaired due to heavy rain or snow.</li> </ul> A warning tone also sounds.<br>When the causes stated above no longer apply, the display message disappears. All driving systems or driving safety systems are operative again.<br>If the display message does not disappear:<br><ul style="list-style-type: none"> <li>► Pull over and stop the vehicle safely as soon as possible, paying attention to road and traffic conditions.</li> <li>► Secure the vehicle against rolling away (▷ page 118).</li> <li>► Switch off the engine.</li> <li>► Clean the sensors in the following locations (▷ page 236):               <ul style="list-style-type: none"> <li>• in the radiator trim</li> <li>• in the front bumper</li> <li>• in the rear bumper, particularly in the center of the rear bumper</li> </ul> </li> <li>► Restart the engine.<br/>The display message disappears.</li> </ul> |
| <br>SRS Malfunction Service Required | The restraint system is malfunctioning. The  warning lamp also lights up in the instrument cluster.<br><b>▲ WARNING</b><br>The air bags or Emergency Tensioning Devices may either be triggered unintentionally or, in the event of an accident, may not be triggered. This poses an increased risk of injury or even fatal injury.<br>► Visit a qualified specialist workshop immediately.<br>For further information about the restraint system, see (▷ page 38).  |

| Display messages   | Possible causes/consequences and ► Solutions  |
|--|---|
|  <p>Front Left Malfunction Service Required or Front Right Malfunction Service Required</p>                             | <p>The restraint system is malfunctioning at the front on the left or right. The  warning lamp also lights up in the instrument cluster.</p> <p> <b>WARNING</b></p> <p>The air bags or Emergency Tensioning Devices may either be triggered unintentionally or, in the event of an accident, may not be triggered. This poses an increased risk of injury or even fatal injury.</p> <p>► Visit a qualified specialist workshop immediately.</p> |
|  <p>Left Side Curtain Airbag Malfunction Service Required or Right Side Curtain Airbag Malfunction Service Required</p> | <p>The left-hand or right-hand window curtain air bag is malfunctioning. The  warning lamp also lights up in the instrument cluster.</p> <p> <b>WARNING</b></p> <p>The left or right window curtain air bag may either be triggered unintentionally or, in the event of an accident, may not be triggered. There is an increased risk of injury.</p> <p>► Visit a qualified specialist workshop immediately.</p>                                |











| Display messages  | Possible causes/consequences and ► Solutions  |
|---|---|
| <p>Front Passenger Air-bag Disabled See Operator's Manual</p> | <p>The front-passenger front air bag is deactivated during the journey, even though:</p> <ul style="list-style-type: none"> <li>• an adult</li> <li>or</li> <li>• a person of the corresponding stature is on the front-passenger seat</li> </ul> <p>If additional forces are applied to the seat, the system may interpret the occupant's weight as lower than it actually is.</p> <p><b>⚠ WARNING</b></p> <p>The front-passenger air bag does not deploy during an accident. There is an increased risk of injury.</p> <ul style="list-style-type: none"> <li>► Pull over and stop the vehicle safely as soon as possible, paying attention to road and traffic conditions.</li> <li>► Secure the vehicle against rolling away (► page 118).</li> <li>► Switch the ignition off.</li> <li>► Have the occupant on the front-passenger seat get out of the vehicle.</li> <li>► Keep the seat unoccupied, close the front-passenger door and switch on the ignition.</li> <li>► Observe the PASSENGER AIR BAG indicator lamps in the center console and the multifunction display and check the following: <ul style="list-style-type: none"> <li>Seat unoccupied and ignition switched on: <ul style="list-style-type: none"> <li>• a self-diagnosis is carried out. The PASSENGER AIR BAG OFF and PASSENGER AIR BAG ON indicator lamps must light up simultaneously for approximately six seconds</li> <li>• the PASSENGER AIR BAG OFF indicator lamp must then light up and remain lit after the self-diagnosis. If the indicator lamp is on, OCS (Occupant Classification System) has disabled the front-passenger front air bag (► page 46)</li> <li>• the display messages <a href="#">Front Passenger Airbag Enabled See Operator's Manual</a> or <a href="#">Front Passenger Airbag Disabled See Operator's Manual</a> must not appear in the multifunction display</li> </ul> </li> </ul> </li> <li>► Wait for a period of at least 60 seconds until the necessary system checks have been completed.</li> <li>► Make sure that the display messages do not appear in the multifunction display.</li> </ul> <p>If these conditions are fulfilled, the front-passenger seat can be occupied again. Whether the PASSENGER AIR BAG OFF indicator lamp remains lit or goes out depends on how OCS classifies the occupant. If the conditions are not fulfilled, the system is not operating correctly.</p> <ul style="list-style-type: none"> <li>► Visit a qualified specialist workshop immediately.</li> </ul> <p>For further information about the Occupant Classification System, see (► page 46).</p> |







| Display messages   | Possible causes/consequences and ► Solutions   |
|--|--|
| <p>Front Passenger Air-bag Enabled See Operator's Manual</p> | <p>The front-passenger front air bag and front-passenger knee bag are enabled during the journey, although:</p> <ul style="list-style-type: none"> <li>• a child, a small adult or an object weighing less than the system's weight threshold is located on the front-passenger seat</li> <li>or</li> <li>• the front-passenger seat is unoccupied</li> </ul> <p>The system may detect objects or forces applying additional weight on the seat.</p> <p> <b>WARNING</b></p> <p>The front-passenger front air bag and the front-passenger knee bag may be triggered unintentionally.</p> <p>There is an increased risk of injury.</p> <ul style="list-style-type: none"> <li>► Pull over and stop the vehicle safely as soon as possible, paying attention to road and traffic conditions.</li> <li>► Secure the vehicle against rolling away (▷ page 118).</li> <li>► Switch the ignition off.</li> <li>► Open the front-passenger door.</li> <li>► Remove the child and the child restraint system from the front-passenger seat.</li> <li>► Make sure that there are no objects on the seat adding to the weight.</li> </ul> <p>The system might otherwise detect the additional weight and interpret the seat occupant's weight as greater than it actually is.</p> <ul style="list-style-type: none"> <li>► Keep the seat unoccupied, close the front-passenger door and switch on the ignition.</li> <li>► Observe the PASSENGER AIR BAG indicator lamps in the center console and the multifunction display and check the following: Seat unoccupied and ignition switched on: <ul style="list-style-type: none"> <li>• a self-diagnosis is carried out. The PASSENGER AIR BAG OFF and PASSENGER AIR BAG ON indicator lamps must light up simultaneously for approximately six seconds</li> <li>• the PASSENGER AIR BAG OFF indicator lamp must then light up and remain lit after the self-diagnosis. If the indicator lamp is on, OCS has deactivated the front-passenger front air bag and front-passenger knee bag (▷ page 46)</li> <li>• the display messages <a href="#">Front Passenger Airbag Enabled See Operator's Manual</a> or <a href="#">Front Passenger Airbag Disabled See Operator's Manual</a> must not appear in the multifunction display</li> </ul> </li> <li>► Wait for a period of at least 60 seconds until the necessary system checks have been completed.</li> <li>► Make sure that the display messages do not appear in the multifunction display.</li> </ul> <p>If these conditions are fulfilled, the front-passenger seat can be occupied again. Whether the PASSENGER AIR BAG OFF or ON indicator lamp remains lit or goes out depends on how OCS classifies the occupant.</p> |





| Display messages | Possible causes/consequences and ► Solutions   |
|------------------|--|
|                  | <p>If the conditions are not fulfilled, the system is not operating correctly.</p> <p>► Visit a qualified specialist workshop immediately.</p> <p>For further information about the Occupant Classification System, see (▷ page 46).</p> |

## Lights



| Display messages  | Possible causes/consequences and ► Solutions   |
|---|--|
| <br>Check Left Low Beam<br>(example)     | <p>The corresponding bulb is faulty.</p> <p>► Visit a qualified specialist workshop.</p> <p><b>i</b> LED light sources: the display message for the corresponding lamp only appears when all the LEDs in the lamp have failed.</p>   |
| <br>Malfunction See<br>Operator's Manual | <p>The exterior lighting is faulty.</p> <p>► Visit a qualified specialist workshop.</p>  |
| <br>Auto Lamp Function<br>Inoperative    | <p>The light sensor is defective.</p> <p>► Visit a qualified specialist workshop.</p>  |
| <br>Switch Off Lights                    | <p>The lights are still switched on when you leave the vehicle. A warning tone also sounds.</p> <p>► Turn the light switch to the <b>AUTO</b> or  position.</p>  |
| Adaptive Highbeam Assist Inoperative  | <p>Adaptive Highbeam Assist is faulty.</p> <p>► Visit a qualified specialist workshop.</p>   |
| Adaptive Highbeam Assist Currently Unavailable See Operator's Manual  | <p>Adaptive Highbeam Assist is deactivated and temporarily inoperative. Possible causes are:</p> <ul style="list-style-type: none"> <li>• The windshield in the camera's field of vision is dirty.</li> <li>• Visibility is impaired due to heavy rain, snow or fog.</li> </ul> <p>► Clean the windshield.</p> <p>If the system detects that the camera is fully operational, the <b>Adaptive Highbeam Assist Now Available</b> display message is shown. Adaptive Highbeam Assist is operational again.</p> |

| Engine  |   |
|---|---|
| Display messages  | Possible causes/consequences and ► Solutions  |
|  <p>Check Coolant Level<br/>See Operator's Manual</p>    | <p>The coolant level is too low.</p> <p><b>!</b> Avoid making long journeys with too little coolant in the engine cooling system. The engine will otherwise be damaged.</p> <ul style="list-style-type: none"> <li>► Add coolant, observing the warning notes before doing so (► page 230).</li> <li>► If coolant needs to be added more often than usual, have the engine coolant system checked at a qualified specialist workshop.</li> </ul>  |
|    | <p>The fan motor is malfunctioning.</p> <ul style="list-style-type: none"> <li>► At coolant temperatures below 248 °F (120 °C), drive to the nearest qualified specialist workshop.</li> <li>► Avoid heavy loads on the engine as you do so, e.g. driving in mountainous terrain and stop-and-go traffic.</li> </ul>  |
|  <p>Coolant Too Hot<br/>Stop Vehicle Turn Engine Off</p> | <p>The coolant is too hot.<br/>A warning tone also sounds.</p> <p><b>▲ WARNING</b></p> <p>Do not drive when your engine is overheated. This can cause some fluids which may have leaked into the engine compartment to catch fire.</p> <p>Steam from the overheated engine can also cause serious burns which can occur just by opening the hood.</p> <p>There is a risk of injury.</p> <ul style="list-style-type: none"> <li>► Pull over and stop the vehicle safely and switch off the engine, paying attention to road and traffic conditions.</li> <li>► Secure the vehicle against rolling away (► page 118).</li> <li>► Wait until the engine has cooled down.</li> <li>► Make sure that the air supply to the engine radiator is not blocked, e.g. by snow, slush or ice.</li> <li>► Do not start the engine again until the display message goes out and the coolant temperature is below 248 °F (120 °C). Otherwise, the engine could be damaged.</li> <li>► Pay attention to the coolant temperature gauge.</li> <li>► If the temperature increases again, visit a qualified specialist workshop immediately.</li> </ul> <p>Under normal operating conditions and with the specified coolant level, the coolant temperature may rise to 248 °F (120 °C).</p> |

| Display messages   | Possible causes/consequences and ► Solutions  |
|--|---|
|  <p data-bbox="181 317 413 365">See Operator's Manual</p>                                 | <p data-bbox="439 267 758 292">The battery is not being charged.</p> <p data-bbox="439 301 711 326">A warning tone also sounds.</p> <p data-bbox="439 333 636 358">Possible causes are:</p> <ul data-bbox="439 367 768 453" style="list-style-type: none"> <li>• a defective alternator</li> <li>• a torn poly-V-belt</li> <li>• a malfunction in the electronics</li> </ul> <p data-bbox="439 467 1077 492"><b>!</b> Do not continue driving. The engine could otherwise overheat.</p> <ul data-bbox="439 503 1100 625" style="list-style-type: none"> <li>► Pull over and stop the vehicle safely and switch off the engine, paying attention to road and traffic conditions.</li> <li>► Secure the vehicle against rolling away (▷ page 118).</li> <li>► Consult a qualified specialist workshop.</li> </ul> |
|  <p data-bbox="181 706 386 754">Stop Vehicle See Operator's Manual</p>                    | <p data-bbox="439 655 1100 704">The battery is no longer being charged and the condition of charge is too low.</p> <p data-bbox="439 713 711 738">A warning tone also sounds.</p> <ul data-bbox="439 747 1100 912" style="list-style-type: none"> <li>► Pull over and stop the vehicle safely and switch off the engine, paying attention to road and traffic conditions.</li> <li>► Secure the vehicle against rolling away (▷ page 118).</li> <li>► Observe the instructions in the  See Operator's Manual display message.</li> <li>► Consult a qualified specialist workshop.</li> </ul>   |
|  <p data-bbox="181 987 386 1035">Start Engine See Operator's Manual</p>                   | <p data-bbox="439 937 1050 962">The engine is off and the battery condition of charge is too low.</p> <ul data-bbox="439 971 1100 1075" style="list-style-type: none"> <li>► Switch off electrical consumers that you do not need, such as the rear window defroster and interior lighting.</li> <li>► Leave the engine running for a few minutes or drive a long distance. The battery is being charged.</li> </ul>  |
|  <p data-bbox="181 1150 413 1198">Check Engine Oil Level (Add 1 quart)</p>              | <p data-bbox="439 1100 965 1125">The engine oil level has dropped to the minimum level.</p> <p data-bbox="439 1139 1100 1188"><b>!</b> Avoid long journeys with too little engine oil. The engine will otherwise be damaged.</p> <ul data-bbox="439 1202 1100 1313" style="list-style-type: none"> <li>► Check the oil level when next refueling, at the latest (▷ page 227).</li> <li>► If necessary, add engine oil (▷ page 229).</li> <li>► Have the engine checked at a qualified specialist workshop if engine oil needs to be added more often than usual.</li> </ul> <p data-bbox="439 1327 1100 1395">Information on approved engine oils can be obtained from a qualified specialist workshop or on the Internet at <a href="http://bevo.mercedes-benz.com">http://bevo.mercedes-benz.com</a>.</p>     |
|  <p data-bbox="181 1476 379 1550">Engine Oil Level Low Stop Vehicle Turn Engine Off</p> | <p data-bbox="439 1426 1054 1451">The engine oil level is too low. There is a risk of engine damage.</p> <ul data-bbox="439 1460 1100 1602" style="list-style-type: none"> <li>► Pull over and stop the vehicle safely and switch off the engine, paying attention to road and traffic conditions.</li> <li>► Secure the vehicle against rolling away (▷ page 118).</li> <li>► Check the engine oil level (▷ page 227).</li> <li>► If necessary, add engine oil (▷ page 229).</li> </ul>  |

| Display messages   | Possible causes/consequences and ► Solutions  |
|--|---|
| <br>Engine Oil Reduce Oil Level         | You have added too much engine oil. The engine or catalytic converter may be damaged.<br>► Siphon off excess engine oil until it is at the specified level. Observe the legal requirements.   |
| <br>Engine Oil Level Cannot Be Measured | The measuring system is faulty.<br>► Visit a qualified specialist workshop.   |
| <br>Fuel Level Low                      | The fuel level has dropped into the reserve range.<br>► Refuel at the nearest gas station.  |
| <br>Fuel Level Low                      | There is only a very small amount of fuel in the fuel tank.<br>► Refuel at the nearest gas station without fail.  |
| <br>Gas Cap Loose                       | The fuel filler cap is not closed correctly or the fuel system is leaking.<br>► Check that the fuel filler cap is correctly closed.<br><b>If the fuel filler cap is not correctly closed:</b><br>► Close the fuel filler cap.<br><b>If the fuel filler cap is correctly closed:</b><br>► Visit a qualified specialist workshop. |

**Driving systems**

| Display messages   | Possible causes/consequences and ► Solutions  |
|--|---|
| <br>ATTENTION ASSIST: Take a Break! | Based on certain criteria, ATTENTION ASSIST has detected fatigue or a lack of concentration on the part of the driver. A warning tone also sounds.<br>► If necessary, take a break.<br><br>During long journeys, take regular breaks in good time so you get enough rest. |
| <br>ATTENTION ASSIST Inoperative    | ATTENTION ASSIST is inoperative.<br>► Visit a qualified specialist workshop.  |
| <br>Malfunction                     | There is a malfunction in the chassis. The vehicle's handling characteristics may be affected.<br>► Visit a qualified specialist workshop.  |

| Display messages   | Possible causes/consequences and ► Solutions   |
|--|--|
| Lane Keeping Assist<br>Currently Unavailable<br>See Operator's<br>Manual | <p>Lane Keeping Assist is deactivated and temporarily inoperative.<br/>Possible causes are:</p> <ul style="list-style-type: none"> <li>• The windshield in the camera's field of vision is dirty.</li> <li>• Visibility is impaired due to heavy rain, snow or fog.</li> <li>• There have been no lane markings for an extended period</li> <li>• The lane markings are worn away, dark or covered up, e.g. by dirt or snow</li> </ul> <p>When the causes stated above no longer apply, the display message disappears.<br/>Lane Keeping Assist is operational again.<br/>If the display message does not disappear:</p> <ul style="list-style-type: none"> <li>► Pull over and stop the vehicle safely as soon as possible, paying attention to road and traffic conditions.</li> <li>► Secure the vehicle against rolling away (▷ page 118).</li> <li>► Clean the windshield.</li> </ul> |
| Lane Keeping Assist<br>Inoperative                                       | <p>Lane Keeping Assist is faulty.</p> <ul style="list-style-type: none"> <li>► Visit a qualified specialist workshop.</li> </ul>   |
| Blind Spot Assist<br>Currently Unavailable<br>See Operator's<br>Manual   | <p>Blind Spot Assist is temporarily inoperative.<br/>Possible causes are:</p> <ul style="list-style-type: none"> <li>• The radar sensor system is outside the operating temperature range.</li> <li>• The radar sensor system is temporarily inoperative, e.g. due to electromagnetic radiation emitted by nearby TV or radio stations or other sources of electromagnetic radiation.</li> </ul> <p>When the causes stated above no longer apply, the display message disappears.<br/>Blind Spot Assist is operational again.<br/>If the display message does not disappear:</p> <ul style="list-style-type: none"> <li>► Pull over and stop the vehicle safely as soon as possible, paying attention to road and traffic conditions.</li> <li>► Secure the vehicle against rolling away (▷ page 118).</li> <li>► Restart the engine.</li> </ul>   |
| Blind Spot Assist<br>Inoperative   | <p>Blind Spot Assist is faulty.</p> <ul style="list-style-type: none"> <li>► Visit a qualified specialist workshop.</li> </ul>   |
| <b>HOLD</b><br>Off   | <p>The HOLD function is deactivated. The vehicle is skidding.<br/>A warning tone also sounds.</p> <ul style="list-style-type: none"> <li>► Reactivate the HOLD function later (▷ page 135).</li> </ul>   |



| Display messages   | Possible causes/consequences and ► Solutions   |
|--|--|
|  | <p>The HOLD function is deactivated. When the brake pedal is firmly depressed, an activation condition is not fulfilled.<br/>A warning tone also sounds.</p> <p>► Check the activation conditions for the HOLD function (▷ page 135).</p>  |
| Distance Pilot Off   | <p>Distance Pilot DISTRONIC is deactivated (▷ page 127).<br/>If it was not deactivated by the driver, a warning tone also sounds.</p>  |
| Distance Pilot Now Available                               | <p>Distance Pilot DISTRONIC is operational again after having been temporarily unavailable. You can now reactivate Distance Pilot DISTRONIC (▷ page 127).</p>  |
| Distance Pilot Currently Unavailable See Operator's Manual | <p>Distance Pilot DISTRONIC is temporarily inoperative.<br/>Possible causes are:</p> <ul style="list-style-type: none"> <li>• The radar sensor system is temporarily inoperative, e.g. due to electromagnetic radiation emitted by nearby TV or radio stations or other sources of electromagnetic radiation.</li> <li>• The system is outside the operating temperature range.</li> <li>• The on-board voltage is too low.</li> </ul> <p>A warning tone also sounds.<br/>When the causes stated above no longer apply, the display message disappears.<br/>Distance Pilot DISTRONIC is operational again.<br/>If the display message does not disappear:</p> <p>► Pull over and stop the vehicle safely as soon as possible, paying attention to road and traffic conditions.<br/>► Secure the vehicle against rolling away (▷ page 118).<br/>► Restart the engine.</p> |
| Distance Pilot Inoperative                                 | <p>Distance Pilot DISTRONIC is malfunctioning.<br/>A warning tone also sounds.</p> <p>► Visit a qualified specialist workshop.</p>   |
| Distance Pilot Suspended                                   | <p>You have depressed the accelerator pedal. Distance Pilot DISTRONIC is no longer controlling the speed of the vehicle.</p> <p>► Remove your foot from the accelerator pedal.</p>   |
| Distance Pilot - - - mph                                   | <p>A condition for activating Distance Pilot DISTRONIC has not been met.</p> <p>► Check the activation conditions for Distance Pilot DISTRONIC (▷ page 127).</p>   |
| Cruise Control Inoperative                                 | <p>Cruise control is malfunctioning.<br/>A warning tone also sounds.</p> <p>► Visit a qualified specialist workshop.</p>   |



| Display messages            | Possible causes/consequences and ► Solutions  |
|-----------------------------|---|
| Cruise Control<br>- - - mph | <ul style="list-style-type: none"> <li>• A condition for activating cruise control has not been fulfilled. You have tried to store a speed below 20 mph (30 km/h), for example.</li> <li>• ESP® is deactivated. The yellow ESP® OFF warning lamp is lit.</li> </ul> <p>► If conditions permit, drive at a speed faster than 20 mph (30 km/h) and store the speed.</p> <p>or</p> <p>► Check the activation conditions for cruise control (▷ page 125).</p> <p>or</p> <p>► Reactivate ESP® (▷ page 60).</p> |
| Cruise Control Off          | <p>Cruise control has been deactivated.</p> <p>If a warning tone also sounds, cruise control has deactivated automatically (▷ page 125).</p>  |





## Tires



| Display messages             | Possible causes/consequences and ► Solutions   |
|------------------------------|--|
| Please Correct Tire Pressure | <p>The tire pressure is too low in at least one of the tires, or the tire pressure difference between the wheels is too great.</p> <p>► Check the tire pressures at the next opportunity (▷ page 258).</p> <p>► If necessary, correct the tire pressure.</p> <p>► Restart the tire pressure monitor (▷ page 260).</p>  |
| Check Tires                  | <p>The tire pressure in one or more tires has dropped significantly. The wheel position is displayed in the multifunction display. A warning tone also sounds.</p> <p> <b>WARNING</b></p> <p>Tire pressures that are too low pose the following hazards:</p> <ul style="list-style-type: none"> <li>• they may burst, especially as the load and vehicle speed increase.</li> <li>• they may wear excessively and/or unevenly, which may greatly impair tire traction.</li> <li>• the driving characteristics, as well as steering and braking, may be greatly impaired.</li> </ul> <p>There is a risk of an accident.</p> <p>► Stop the vehicle without making any sudden steering or braking maneuvers. Pay attention to the traffic conditions as you do so.</p> <p>► Secure the vehicle against rolling away (▷ page 118).</p> <p>► Check the tires and, if necessary, follow the instructions for a flat tire (▷ page 240).</p> <p>► Check the tire pressure (▷ page 258).</p> <p>► If necessary, correct the tire pressure.</p> |

| Display messages                                   | Possible causes/consequences and ► Solutions   |
|--|--|
| Warning Tire Malfunction                           | <p>The tire pressure in one or more tires has dropped suddenly. The wheel position is shown in the multifunction display.</p> <p> <b>WARNING</b></p> <p>Driving with a flat tire poses a risk of the following hazards:</p> <ul style="list-style-type: none"> <li>• a flat tire affects the ability to steer or brake the vehicle</li> <li>• you could lose control of the vehicle</li> <li>• continued driving with a flat tire will cause excessive heat build-up and possibly a fire</li> </ul> <p>There is a risk of an accident.</p> <ul style="list-style-type: none"> <li>► Stop the vehicle without making any sudden steering or braking maneuvers. Pay attention to the traffic conditions as you do so.</li> <li>► Secure the vehicle against rolling away (► page 118).</li> <li>► Check the tires and, if necessary, follow the instructions for a flat tire (► page 240).</li> </ul> |
| Tire Press. Monitor Currently Unavailable          | <p>Because there is interference from a strong source of radio waves, no signals from the tire pressure sensors are detected. The tire pressure monitor is temporarily malfunctioning.</p> <ul style="list-style-type: none"> <li>► Drive on.<br/>The tire pressure monitor restarts automatically as soon as the problem has been resolved.</li> </ul>  |
| TirePress. Sensor(s) Missing                       | <p>There is no signal from the tire pressure sensor of one or several tires. The pressure of the affected tire is not displayed in the multifunction display.</p> <ul style="list-style-type: none"> <li>► Have the faulty tire pressure sensor replaced at a qualified specialist workshop.</li> </ul>  |
| Tire Pressure Monitor Inoperative No Wheel Sensors | <p>The wheels mounted do not have a suitable tire pressure sensor. The tire pressure monitor is deactivated.</p> <ul style="list-style-type: none"> <li>► Mount wheels with suitable tire pressure sensors.<br/>The tire pressure monitor is activated automatically after driving for a few minutes.</li> </ul>   |
| Tire Press. Monitor Inoperative                    | <p>The tire pressure monitor is faulty.</p> <ul style="list-style-type: none"> <li>► Visit a qualified specialist workshop.</li> </ul>   |





| Vehicle   |   |
|---|---|
| Display messages  | Possible causes/consequences and ► Solutions  |
| Shift to 'P' or 'N' to Start Engine                                     | You have attempted to start the engine with the transmission in position <b>R</b> or <b>D</b> .<br>► Shift the selector lever to <b>P</b> or <b>N</b> .   |
| Apply Brake to Shift from 'P'   | You have attempted to shift the selector lever to position <b>D</b> , <b>R</b> or <b>N</b> without applying the brakes.<br>► Depress the brake pedal.   |
| To Deselect P or N, Depress Brake and Start Engine                      | With the engine switched off, you have attempted to shift the selector lever out of position <b>P</b> or <b>N</b> into another transmission position.<br>► Depress the brake pedal.<br>► Start the engine.  |
| To Engage Transmiss. Position R First Depress the Brake                 | You have attempted to shift from position <b>D</b> to position <b>R</b> without applying the brakes.<br>► Depress the brake pedal.<br>► Shift the transmission to position <b>R</b> .   |
| Driver's Door Open & Transmission Not in P Risk of Vehicle Rolling Away | The driver's door is open or not fully closed and the transmission is in position <b>R</b> , <b>N</b> or <b>D</b> .<br>A warning tone also sounds.<br><b>⚠ WARNING</b><br>The vehicle may roll away.<br>There is a risk of an accident.<br>► Shift the transmission to position <b>P</b> .<br>► Secure the vehicle against rolling away (▷ page 118).<br>► Close the driver's door completely.  |
| Only Shift to 'P' when Vehicle is Stationary                            | The vehicle is moving.<br>► Pull over and stop the vehicle safely as soon as possible, paying attention to road and traffic conditions.<br>► Shift the transmission to position <b>P</b> .  |
| Service Required Do Not Shift Gears Visit Dealer                        | You cannot change the transmission position due to a malfunction. A warning tone also sounds.<br>If transmission position <b>D</b> is selected:<br>► Drive to a qualified specialist workshop without shifting the transmission from position <b>D</b> .<br>If position <b>R</b> , <b>N</b> or <b>P</b> is selected:<br>► Secure the vehicle against rolling away (▷ page 271).<br>► Notify a qualified specialist workshop or breakdown service. |

| Display messages   | Possible causes/consequences and ► Solutions   |
|--|--|
| Reversing Not Possible Service Required  | <p>The sub-transmission with the even gears has failed. You can no longer engage reverse gear. The smoothness of the gear change is restricted. The transmission is in emergency mode.</p> <p>A warning tone also sounds.</p> <ul style="list-style-type: none"> <li>► Visit a qualified specialist workshop.</li> </ul>   |
| Transmission Malfunction Stop  | <p>A malfunction has occurred in the mechanical transmission components.</p> <p>A warning tone also sounds. The transmission shifts automatically to position <b>N</b>.</p> <ul style="list-style-type: none"> <li>► Pull over and stop the vehicle safely as soon as possible, paying attention to road and traffic conditions.</li> <li>► Shift the selector lever to position <b>P</b>.</li> <li>► Secure the vehicle against rolling away (▷ page 118).</li> <li>► Notify a qualified specialist workshop or breakdown service.</li> </ul> |
| Depress Brake to Start Engine  | <p>You cannot start the engine. The engine has been switched off in <b>D</b> or <b>R</b>.</p> <ul style="list-style-type: none"> <li>► Depress the brake pedal and start the engine.</li> </ul>  |
| Only Shift to 'P' when Vehicle is Stationary   | <p>The vehicle is moving.</p> <ul style="list-style-type: none"> <li>► Pull over and stop the vehicle safely as soon as possible, paying attention to road and traffic conditions.</li> <li>► Shift the transmission to position <b>P</b>.</li> </ul>  |
|  Parking Lock Malfunction. Apply Parking Brake | <p>The transmission position <b>P</b> cannot be selected.</p> <ul style="list-style-type: none"> <li>► Make sure that the electric parking brake is applied.</li> <li>► Prevent the vehicle from rolling away before you leave it (▷ page 271).</li> <li>► Visit a qualified specialist workshop.</li> </ul>   |
|  Transmission Oil Cooling Malfunction         | <p>The transmission coolant pump is faulty. The transmission may overheat.</p> <ul style="list-style-type: none"> <li>► In the on-board computer, select the <b>AMG</b> menu and check the transmission oil temperature (▷ page 161).</li> <li>► Avoid excessive loading, e.g. due to dynamic driving.</li> <li>► If the transmission oil temperature is below 248 °F (120 °C), drive on to the nearest qualified specialist workshop.</li> </ul>  |
|  Trans. Oil Overheated Drive on with Care     | <p>The transmission oil has overheated.</p> <p>Manual mode <b>M</b> and temporary manual drive program are no longer available. Only the <b>Comfort</b> setting is available for the transmission. The engine output is reduced according to the degree of overheating.</p> <ul style="list-style-type: none"> <li>► Allow the transmission oil to cool by adopting a defensive driving style.</li> </ul>  |
| Electronic Rear Axle Differential Lock Inoperative   | <p>The electronic rear axle differential lock is inoperative.</p> <ul style="list-style-type: none"> <li>► Visit a qualified specialist workshop.</li> </ul>   |



| Display messages  | Possible causes/consequences and ► Solutions  |
|---|---|
| Electronic Rear Axle Differential Lock Currently Unavailable  | <p>The electronic rear axle differential lock motor has overheated.</p> <ul style="list-style-type: none"> <li>► Allow electronic rear axle differential lock to cool by adopting a defensive driving style.</li> </ul>   |
|    | <p>The tailgate is open.</p> <p><b>⚠ WARNING</b></p> <p>When the engine is running, exhaust gases can enter the vehicle interior if the tailgate is open. There is a risk of poisoning.</p> <ul style="list-style-type: none"> <li>► Close the tailgate.</li> </ul>   |
|    | <p>The hood is open. A warning tone also sounds.</p> <p><b>⚠ WARNING</b></p> <p>The open hood may block your view when the vehicle is in motion. There is a risk of an accident.</p> <ul style="list-style-type: none"> <li>► Pull over and stop the vehicle safely as soon as possible, paying attention to road and traffic conditions.</li> <li>► Secure the vehicle against rolling away (▷ page 118).</li> <li>► Close the hood.</li> </ul>  |
|    | <p>At least one door is open. A warning tone also sounds.</p> <ul style="list-style-type: none"> <li>► Close all the doors.</li> </ul>  |
|  <p>Inoperative Caution, Reduced Ground Clearance</p>       | <p><b>!</b> Take the restricted ground clearance into account when the active aerodynamics profile is extended.</p> <p>The active aerodynamics profile cannot fully extend or retract and reverses when possible.</p> <p>When extension/retraction of the active aerodynamics profile is blocked:</p> <ul style="list-style-type: none"> <li>► Make sure that the cause of the block is eliminated.</li> <li>► Switch off the engine and lock the vehicle.</li> <li>► Start the vehicle after waiting a few minutes. The active aerodynamics profile returns to the original position.</li> </ul> <p>If this problem persists or the cause cannot be identified:</p> <ul style="list-style-type: none"> <li>► Visit a qualified specialist workshop.</li> </ul> |
|  <p>Traction Control Inoperative See Operator's Manual</p> | <p>The traction control system is malfunctioning.</p> <ul style="list-style-type: none"> <li>► Visit a qualified specialist workshop.</li> </ul>  |

| Display messages  | Possible causes/consequences and ► Solutions   |
|---|--|
|  <p>Power Steering Malfunction See Operator's Manual</p> | <p>The power steering is malfunctioning.<br/>A warning tone also sounds.</p> <p> <b>WARNING</b></p> <p>You will need to use more force to steer.<br/>There is a risk of an accident.</p> <ul style="list-style-type: none"> <li>► Check whether you are able to apply the extra force required.</li> <li>► <b>If you are able to steer safely:</b> carefully drive on to a qualified specialist workshop.</li> <li>► <b>If you are unable to steer safely:</b> do not drive on. Contact the nearest qualified specialist workshop.</li> </ul> |
| <p>Phone No Service</p>   | <p>Your vehicle is outside the network provider's transmitter/receiver range.</p> <ul style="list-style-type: none"> <li>► Wait until the mobile phone operational readiness symbol appears in the multifunction display.</li> </ul>   |
|  <p>Check Washer Fluid</p>                               | <p>The washer fluid level in the washer fluid reservoir has dropped below the minimum.</p> <ul style="list-style-type: none"> <li>► Add washer fluid (&gt; page 231).</li> </ul>   |

### SmartKey

| Display messages  | Possible causes/consequences and ► Solutions  |
|---|---|
|  <p>Key Does Not Belong to Vehicle</p> | <p>You have put the wrong SmartKey in the ignition lock.</p> <ul style="list-style-type: none"> <li>► Use the correct SmartKey.</li> </ul>  |
|  <p>Take Your Key from Ignition</p>    | <p>The SmartKey is in the ignition lock.</p> <ul style="list-style-type: none"> <li>► Remove the SmartKey.</li> </ul>   |
|  <p>Obtain a New Key</p>               | <p>The SmartKey needs to be replaced.</p> <ul style="list-style-type: none"> <li>► Visit a qualified specialist workshop.</li> </ul>  |
|  <p>Replace Key Battery</p>            | <p>The SmartKey battery is discharged.</p> <ul style="list-style-type: none"> <li>► Change the batteries (&gt; page 67).</li> </ul>   |
|  <p>Don't Forget Your Key</p>          | <p>The SmartKey is not in the ignition lock. You have opened the driver's door with the engine switched off.<br/>This display message is displayed for a maximum of 60 seconds and is simply a reminder.</p> <ul style="list-style-type: none"> <li>► Take the SmartKey with you when you leave the vehicle.</li> </ul> |



| Display messages  | Possible causes/consequences and ► Solutions   |
|---|--|
|  <p>Key Not Detected<br/>(white display message)</p> | <p>The SmartKey is currently undetected.</p> <ul style="list-style-type: none"> <li>► Change the location of the SmartKey in the vehicle.</li> </ul> <p>If the SmartKey still cannot be detected:</p> <ul style="list-style-type: none"> <li>► Insert the SmartKey into the ignition lock and turn it to the desired position.</li> </ul>  |
|  <p>Key Not Detected<br/>(red display message)</p>   | <p>The SmartKey is not in the vehicle.<br/>A warning tone also sounds.</p> <p>If the engine is switched off, you can no longer lock the vehicle centrally or start the engine.</p> <ul style="list-style-type: none"> <li>► Pull over and stop the vehicle safely as soon as possible, paying attention to road and traffic conditions.</li> <li>► Secure the vehicle against rolling away (► page 118).</li> <li>► Locate the SmartKey.</li> <li>► Press <b>OK</b> on the steering wheel to confirm the display message.</li> </ul> <p>Because there is interference from a strong source of radio waves, the SmartKey is not detected whilst the engine is running.<br/>A warning tone also sounds.</p> <ul style="list-style-type: none"> <li>► Pull over and stop the vehicle safely as soon as possible, paying attention to road and traffic conditions.</li> <li>► Secure the vehicle against rolling away (► page 118).</li> <li>► Insert the SmartKey into the ignition lock and drive in SmartKey mode.</li> </ul> |
|  <p>Insert Key</p>                                  | <p>The SmartKey is continually undetected.<br/>The SmartKey detection function has a temporary malfunction or is faulty. A warning tone also sounds.</p> <ul style="list-style-type: none"> <li>► Insert the SmartKey into the ignition lock and turn it to the desired position.</li> <li>► Visit a qualified specialist workshop.</li> </ul>   |

### Warning and indicator lamps in the instrument cluster





#### General notes

Some systems carry out a self-diagnosis when the ignition is switched on. Therefore, some

indicator and warning lamps may light up or flash temporarily. This behavior is non-critical. These indicator and warning lamps only indicate a malfunction if they light up or flash after starting the engine or whilst driving.

## Safety

## Seat belts

| Warning/<br>indicator<br>lamp   | ▷ Signal type<br>Possible causes/consequences and ▶ Solutions   |
|---|---|
|    | <p>▷ After starting the engine, the red seat belt warning lamp lights up for 6 seconds. The seat belt warning lamp reminds the driver and front passenger to fasten their seat belts.</p> <p>▶ Fasten your seat belt (▷ page 42).</p>   |
|    | <p>▷ After starting the engine, the red seat belt warning lamp lights up. In addition, a warning tone sounds for up to 6 seconds. The driver's seat belt is not fastened.</p> <p>▶ Fasten your seat belt (▷ page 42).<br/>The warning tone ceases.</p>  |
|    | <p>▷ The red seat belt warning lamp lights up after the engine starts, as soon as the driver's or the front-passenger door is closed. The driver or front passenger has not fastened their seat belt.</p> <p>▶ Fasten your seat belt (▷ page 42).<br/>The warning lamp goes out.</p> <p>There are objects on the front-passenger seat.</p> <p>▶ Remove the objects from the front-passenger seat and stow them in a secure place.<br/>The warning lamp goes out.</p>  |
|  | <p>▷ The red seat belt warning lamp flashes and an intermittent audible warning sounds.</p> <p>The driver or front passenger has not fastened their seat belt. The vehicle is being driven faster than 15 mph (25 km/h) or has briefly been driven faster than 15 mph (25 km/h).</p> <p>▶ Fasten your seat belt (▷ page 42).<br/>The warning lamp goes out and the intermittent warning tone ceases.</p> <p>There are objects on the front-passenger seat. The vehicle is being driven faster than 15 mph (25 km/h) or has briefly been driven faster than 15 mph (25 km/h).</p> <p>▶ Remove the objects from the front-passenger seat and stow them in a secure place.<br/>The warning lamp goes out and the intermittent warning tone ceases.</p> |

## Safety systems

Warning/  
indicator  
lamp

## ▷ Signal type

## Possible causes/consequences and ► Solutions



▷ **BRAKE** (USA only), (Canada only): the red brake system warning lamp is lit while the engine is running. A warning tone also sounds.

**WARNING**

The brake boosting effect is malfunctioning and the braking characteristics may be affected.

There is a risk of an accident.

- ▶ Pull over and stop the vehicle safely as soon as possible, paying attention to road and traffic conditions. Do not continue driving under any circumstances.
- ▶ Secure the vehicle against rolling away (▷ page 118).
- ▶ Visit a qualified specialist workshop immediately.
- ▶ Observe the additional display messages in the multifunction display.



▷ **BRAKE** (USA only), (Canada only): the red brake system warning lamp is lit while the engine is running. A warning tone also sounds.

There is not enough brake fluid in the brake fluid reservoir.

**WARNING**

The braking effect may be impaired.

There is a risk of an accident.

- ▶ Pull over and stop the vehicle safely as soon as possible, paying attention to road and traffic conditions. Do not continue driving under any circumstances.
- ▶ Secure the vehicle against rolling away (▷ page 118).
- ▶ Do not add brake fluid. Adding more will not correct the malfunction.
- ▶ Consult a qualified specialist workshop.
- ▶ Observe the additional display messages in the multifunction display.



▷ USA only: the red brake system warning lamp is lit while the engine is running. The multifunction display also shows a display message with the symbol.

The brake pads/linings have reached their wear limit.

- ▶ Visit a qualified specialist workshop.

Warning/  
indicator  
lamp

## ▷ Signal type

## Possible causes/consequences and ▶ Solutions



▷ The yellow ABS warning lamp is lit while the engine is running. ABS (anti-lock braking system) is malfunctioning. If there is an additional warning tone, the EBD (electronic brake force distribution) is malfunctioning. Other driving systems and driving safety systems may also malfunction.

**WARNING**

The brake system continues to function normally, but without the functions listed above. The front and rear wheels could therefore lock if you brake hard, for example.

The steerability and braking characteristics may be severely affected. The braking distance in an emergency braking situation can increase.

If ESP® is not operational, ESP® is unable to stabilize the vehicle.

There is an increased risk of skidding and an accident.

▶ Observe the additional display messages in the multifunction display.

▶ Drive on carefully.

▶ Visit a qualified specialist workshop immediately.

If the ABS control unit is faulty, there is also a possibility that other systems, such as the navigation system or the automatic transmission, will not be available.



▷ (USA only), (Canada only): the red brake warning lamp and the yellow ESP® and ABS warning lamps are lit while the engine is running.

ABS and ESP® are malfunctioning.

Other driving systems and driving safety systems may also malfunction.

**WARNING**

The brake system continues to function normally, but without the functions listed above. The front and rear wheels could therefore lock if you brake hard, for example.

The steerability and braking characteristics may be severely affected. The braking distance in an emergency braking situation can increase.

If ESP® is not operational, ESP® is unable to stabilize the vehicle.

There is an increased risk of skidding and an accident.

▶ Observe the additional display messages in the multifunction display.

▶ Drive on carefully.

▶ Visit a qualified specialist workshop immediately.

Warning/  
indicator  
lamp

## ▷ Signal type

## Possible causes/consequences and ► Solutions



- ▷ The yellow ESP<sup>®</sup> warning lamp flashes while the vehicle is in motion. ESP<sup>®</sup> or traction control has intervened because there is a risk of skidding or at least one wheel has started to spin. Cruise control or Distance Pilot DISTRONIC is deactivated.
- ▶ When pulling away, only depress the accelerator pedal as far as necessary.
  - ▶ Ease off the accelerator pedal while the vehicle is in motion.
  - ▶ Adapt your driving style to suit the road and weather conditions.
  - ▶ Do not deactivate ESP<sup>®</sup>.  
In rare cases (▷ page 60), it may be best to deactivate ESP<sup>®</sup>.  
Observe the important safety notes on ESP<sup>®</sup> (▷ page 60).



- ▷ The yellow ESP<sup>®</sup> warning lamp is lit while the engine is running. ESP<sup>®</sup> is malfunctioning. Other driving systems and driving safety systems may also malfunction.

**WARNING**

The brake system continues to function normally, but without the functions listed above.

The braking distance in an emergency braking situation can thus increase.

If ESP<sup>®</sup> is not operational, ESP<sup>®</sup> is unable to stabilize the vehicle.

There is an increased risk of skidding and an accident.

- ▶ Observe the additional display messages in the multifunction display.
- ▶ Drive on carefully.
- ▶ Visit a qualified specialist workshop immediately.



- ▷ The yellow ESP<sup>®</sup> OFF warning lamp is lit while the engine is running or the ECO start/stop function is activated. ESP<sup>®</sup> is deactivated.

**WARNING**









If ESP<sup>®</sup> is switched off, ESP<sup>®</sup> is unable to stabilize the vehicle.

There is an increased risk of skidding and an accident.

- ▶ Reactivate ESP<sup>®</sup>.  
In rare cases (▷ page 60), it may be best to deactivate ESP<sup>®</sup>.  
Observe the important safety notes on ESP<sup>®</sup> (▷ page 60).
- ▶ Adapt your driving style to suit the road and weather conditions.

If ESP<sup>®</sup> cannot be activated:

- ▶ Drive on carefully.
- ▶ Have ESP<sup>®</sup> checked at a qualified specialist workshop.

| Warning/<br>indicator<br>lamp   | ▷ Signal type<br>Possible causes/consequences and ▶ Solutions  |
|---|--|
|    | <p>▷ The yellow SPORT handling mode warning lamp is lit while the engine is running. SPORT handling mode is activated.</p> <p> <b>WARNING</b></p> <p>When SPORT handling mode is switched on, ESP<sup>®</sup> is unable to stabilize the vehicle. There is an increased risk of skidding and an accident.</p> <p>▶ Only switch to SPORT handling mode in accordance with the conditions described in the "Activating/deactivating ESP" section (▷ page 60).</p>   |
|   | <p>▷  (USA only),  (Canada only): the red indicator lamp for the electric parking brake flashes or is lit and/or the yellow warning lamp for the electric parking brake is lit.</p> <p>▶ Observe the additional display messages in the multifunction display.</p>   |
|    | <p>▷ The red restraint system warning lamp is lit while the engine is running. The restraint system is malfunctioning.</p> <p> <b>WARNING</b></p> <p>The air bags or Emergency Tensioning Devices may either be triggered unintentionally or, in the event of an accident, may not be triggered. There is an increased risk of injury.</p> <p>▶ Observe the additional display messages in the multifunction display.</p> <p>▶ Drive on carefully.</p> <p>▶ Have the restraint system checked immediately at a qualified specialist workshop.</p> <p>For further information about the restraint system, see (▷ page 38).</p> |

## Engine

Warning/  
indicator  
lamp

## ▷ Signal type

## Possible causes/consequences and ▶ Solutions



▷ The yellow Check Engine warning lamp lights up while the engine is running. There may be a malfunction, for example:

- in the engine management
- in the fuel injection system
- in the exhaust system
- in the ignition system
- in the fuel system

The emission limit values may be exceeded and the engine may be in emergency mode.

▶ Have the vehicle checked as soon as possible at a qualified specialist workshop.

In some states, you must immediately visit a qualified specialist workshop as soon as the yellow Check Engine warning lamp lights up. This is due to the legal requirements in effect in these states. If in doubt, check whether such legal regulations apply in the state in which you are currently driving.



▷ The yellow reserve fuel warning lamp lights up while the engine is running. The fuel level has dropped into the reserve range.

▶ Refuel at the nearest gas station.



▷ The yellow reserve fuel warning lamp flashes while the vehicle is in motion. In addition, the  Check Engine warning lamp may light up.

The fuel filler cap is not closed correctly or the fuel system is leaking.

▶ Check that the fuel filler cap is correctly closed.

▶ **If the fuel filler cap is not correctly closed:** close the fuel filler cap.

▶ **If the fuel filler cap is closed:** visit a qualified specialist workshop.



▷ The red coolant warning lamp lights up while the engine is running and the coolant temperature gauge is at the start of the scale.

The temperature sensor for the coolant temperature gauge is defective.

The coolant temperature is no longer being monitored. There is a risk of engine damage if the coolant temperature is too high.

▶ Pull over and stop the vehicle safely and switch off the engine, paying attention to road and traffic conditions. Do not continue driving under any circumstances.

▶ Secure the vehicle against rolling away (▷ page 118).

▶ Consult a qualified specialist workshop.



Warning/  
indicator  
lamp▷ Signal type  
Possible causes/consequences and ▷ Solutions

- ▷ The red coolant warning lamp comes on while the engine is running. The coolant level is too low.
- If the coolant level is correct, the airflow to the engine radiator may be blocked or the electric engine radiator fan may be malfunctioning.
- The coolant is too hot and the engine is no longer being cooled sufficiently.
- ▶ Observe the additional display messages in the multifunction display.
  - ▶ Pull over and stop the vehicle safely and switch off the engine, paying attention to road and traffic conditions.
  - ▶ Secure the vehicle against rolling away (▷ page 118).
  - ▶ Leave the vehicle and keep a safe distance from the vehicle until the engine has cooled down.
  - ▶ Check the coolant level and add coolant, observing the warning notes (▷ page 230).
  - ▶ If you need to add coolant more often than usual, have the engine coolant system checked.
  - ▶ Make sure that the air supply to the engine radiator is not blocked, e.g. by snow, slush or ice.
  - ▶ Do not start the engine again until the coolant temperature is below 248 °F (120 °C). Otherwise, the engine could be damaged.
  - ▶ Drive to the nearest qualified specialist workshop.
  - ▶ Avoid subjecting the engine to heavy loads, e.g. driving in mountainous terrain, and stop-and-go traffic.



- ▷ The red coolant warning lamp comes on while the engine is running. A warning tone also sounds.
- The coolant temperature has exceeded 248 °F (120 °C). The airflow to the engine radiator may be blocked or the coolant level may be too low.

**WARNING**

- The engine is not being cooled sufficiently and may be damaged.
- Do not drive when your engine is overheated. This can cause some fluids which may have leaked into the engine compartment to catch fire.
- Steam from the overheated engine can also cause serious burns which can occur just by opening the hood.
- There is a risk of injury.
- ▶ Observe the additional display messages in the multifunction display.
  - ▶ Pull over and stop the vehicle safely and switch off the engine, paying attention to road and traffic conditions.
  - ▶ Secure the vehicle against rolling away (▷ page 118).
  - ▶ Leave the vehicle and keep a safe distance from the vehicle until the engine has cooled down.
  - ▶ Check the coolant level and add coolant, observing the warning notes (▷ page 230).
  - ▶ If you need to add coolant more often than usual, have the engine coolant system checked.

**Warning/  
indicator  
lamp****▷ Signal type****Possible causes/consequences and ▶ Solutions**

- ▶ Make sure that the air supply to the engine radiator is not blocked, e.g. by snow, slush or ice.
- ▶ At coolant temperatures below 248 °F (120 °C), drive to the nearest qualified specialist workshop.
- ▶ Avoid subjecting the engine to heavy loads, e.g. driving in mountainous terrain, and stop-and-go traffic.

**Driving systems****Warning/  
indicator  
lamp****▷ Signal type****Possible causes/consequences and ▶ Solutions**

▷ The red distance warning lamp lights up while the vehicle is in motion. A warning tone also sounds.

You are approaching a vehicle or a stationary obstacle in your line of travel at too high a speed.

- ▶ Be prepared to brake immediately.
- ▶ Pay careful attention to the traffic situation. You may have to brake or take evasive action.

Further information on the distance warning function of Active Brake Assist (▷ page 57).

## Tires

Warning/  
indicator  
lamp

## ▷ Signal type

## Possible causes/consequences and ▶ Solutions



▷ The yellow tire pressure monitor warning lamp (pressure loss/malfunction) is lit. The tire pressure monitor has detected a loss of pressure in at least one of the tires.

 **WARNING**

Tire pressures that are too low pose the following hazards:

- they may burst, especially as the load and vehicle speed increase.
  - they may wear excessively and/or unevenly, which may greatly impair tire traction.
  - the driving characteristics, as well as steering and braking, may be greatly impaired.  
There is a risk of an accident.
- ▶ Stop the vehicle without making any sudden steering or braking maneuvers. Pay attention to the traffic conditions as you do so.
- ▶ Secure the vehicle against rolling away (▷ page 118).
- ▶ Observe the additional display messages in the multifunction display.
- ▶ Check the tires and, if necessary, follow the instructions for a flat tire (▷ page 240).
- ▶ Check the tire pressure (▷ page 258).
- ▶ If necessary, correct the tire pressure.



▷ The yellow tire pressure monitor warning lamp (pressure loss/malfunction) flashes for approximately one minute and then remains lit.

The tire pressure monitor is faulty.

 **WARNING**

The system is possibly unable to recognize or register low tire pressure. There is a risk of an accident.

- ▶ Observe the additional display messages in the multifunction display.
- ▶ Visit a qualified specialist workshop immediately.

## Vehicle

Warning/  
indicator  
lamp

## ▷ Signal type

## Possible causes/consequences and ► Solutions



▷ The red power steering warning lamp is lit while the engine is running. The power steering is malfunctioning. A warning tone also sounds.

 **WARNING**

You will need to use more force to steer. There is a risk of an accident.

- ▶ Check whether you are able to apply the extra force required.
- ▶ **If you are able to steer safely:** carefully drive on to a qualified specialist workshop.
- ▶ **If you are unable to steer safely:** do not drive on. Contact the nearest qualified specialist workshop.

### General notes

The multimedia system section in this Operator's Manual describes the basic principles for operation. More information can be found in the Digital Operator's Manual.

### Important safety notes

#### WARNING

If you operate information systems and communication equipment integrated in the vehicle when driving, you may be distracted from the traffic situation. You could also lose control of the vehicle. There is a risk of an accident.

Only operate this equipment when the traffic situation permits. If you are not sure that this is possible, park the vehicle paying attention to traffic conditions and operate the equipment when the vehicle is stationary.

You must observe the legal requirements for the country in which you are currently driving when operating the multimedia system.

The multimedia system calculates the route to the destination without taking the following into account, for example:

- traffic lights
- stop and yield signs
- parking or stopping restrictions
- road narrowing
- other road and traffic rules and regulations

The multimedia system may give incorrect navigation recommendations if the actual street/traffic situation does not correspond with the digital map's data.

For example:

- a diverted route
- the road layout or the direction of a one-way street has been changed

For this reason, you must always observe road and traffic rules and regulations during your journey. Road and traffic rules and regulations always have priority over multimedia system driving recommendations.

Navigation announcements are intended to direct you while driving without diverting your attention from the road and driving.

Please always use this feature instead of consulting the map display for directions. Looking at the icons or map display can distract you from traffic conditions and driving, and increase the risk of an accident.

This equipment complies with FCC radiation exposure limits set forth for uncontrolled equipment and meets the FCC radio frequency (RF) Exposure Guidelines in Supplement C to OET65.

This equipment has very low levels of RF energy that is deemed to comply without maximum permissive exposure evaluation (MPE). However, it is recommended to install it at a distance of at least 8 inches (approx. 20 cm) between the radiation source and a person's body (not including limbs such as hands, wrists, feet and legs).

#### WARNING

Modifications to electronic components, their software as well as wiring can impair their function and/or the function of other networked components. In particular, systems relevant to safety could also be affected. As a result, these may no longer function as intended and/or jeopardize the operating safety of the vehicle. There is an increased risk of an accident and injury.

Never tamper with the wiring as well as electronic components or their software. You should have all work to electrical and electronic equipment carried out at a qualified specialist workshop.

### Function restrictions

For safety reasons, some functions are restricted or unavailable while the vehicle is in motion. You will notice this, for example, because either you will not be able to select certain menu items or a message will appear to this effect.

## Operating system

### Overview

#### General notes

Wearing polarized sunglasses may impair your ability to read the display.

The display has an automatic temperature-controlled switch-off feature. The brightness is automatically reduced if the temperature is too high. The display may temporarily switch off completely.

#### Cleaning instructions

**!** Do not touch the display. The display has a very sensitive high-gloss surface; there is a risk of scratching. If you have to clean the screen, however, use a mild cleaning agent and a soft, lint-free cloth.

The display must be switched off and have cooled down before you start cleaning. Do not apply pressure to the display surface when cleaning it, as this could cause irreversible damage to the display.

#### Switching the multimedia system on/off

► Press the  control knob which is located on the center console to the right of the controller.



#### Adjusting the volume

► Turn the  control knob which is located on the center console to the right of the controller.

The volume is adjusted:

- for the currently selected media source
- during traffic or navigation announcements
- in hands-free mode during a phone call

#### Switching the sound on or off

► Press the  button on the multifunction steering wheel.  
If the audio output is switched off, the status line will show the  symbol. If you switch

the media source or change the volume, the sound is automatically switched on.

**i** You will hear navigation messages even when the sound is muted (COMAND).

#### Functions

The multimedia system has the following functions:





- Radio mode
- Media mode with media search
- Sound systems
- Navigation system (COMAND):
- Communication functions
- SIRIUS Weather (COMAND)
- Vehicle functions with system settings
- Favorites functions

#### Controller

The controller in the center console lets you:



- select menu items on the display
- enter characters
- select a destination on the map
- save entries

The controller can be:

- turned 
- slid left or right 
- slid forwards or back 
- slid diagonally 
- pressed briefly or pressed and held 

#### Back button

You can use the  button to exit a menu or to call up the basic display of the current operating mode.

- **To exit the menu:** briefly press the  button.  
The multimedia system changes to the next higher menu level in the current operating mode.
- **To call up the basic display:** press the  button for longer than two seconds.  
The multimedia system changes to the basic display of the current operating mode.

## Touchpad

### Switching the touchpad on/off

Multimedia system:

- ▶ Select **Vehicle** → **System Settings** → **Touchpad** → **Activate Touchpad**.  
The touchpad is switched on  or off .

### Operating the touchpad

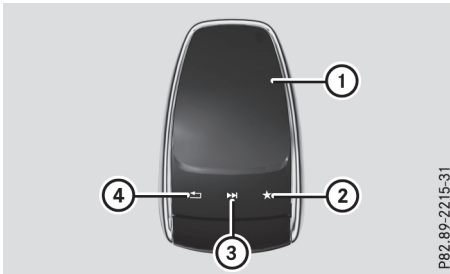

P82.89-2215-31

- 1 Touch-sensitive surface
- 2 Favorites button
- 3 Calls up quick access for audio
- 4 Back button

Navigating in menus and lists can be done via touch-sensitive surface ① by **swiping with your finger**.

- ▶ **To select the menu item:** swipe up, down, to the left or right.
- ▶ Press the touchpad.
- ▶ **To move the digital map:** swipe in all directions.

**Swiping with two fingers**, e.g. using this function:

- ▶ **To show or hide the audio menu:** swipe up or down with two fingers.
- ▶ **To increase or reduce the vehicle and sound settings:** turn two fingers to the right or left.
- ▶ **To zoom in and out of the map (COMAND):** move two fingers together or apart.

## Character entry with handwriting recognition

### Entering characters

- ▶ Use one finger to write characters on the surface.  
The character is entered in the input line. If the character that you have entered can be interpreted in different ways, these character suggestions are displayed.
- ▶ If character suggestions are shown, turn and press the controller.
- ▶ Resume the character entry on the touchpad.

### Handwriting recognition

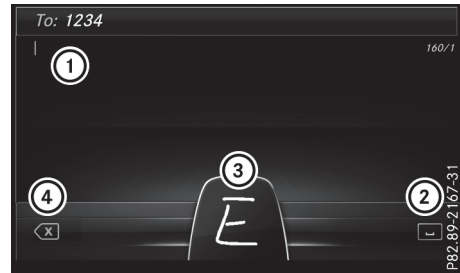

P82.89-2167-31

- 1 Active input line
- 2 Inserts a space
- 3 Character entered on the touchpad
- 4 Deletes characters (Example: COMAND)

- ▶ **To display the menu:** press the touchpad.



P82.89-0784-31

- 1 To exit the menu
- 2 To return to handwriting recognition
- 3 To use the phone book or text templates (COMAND)
- 4 To select the input line or changes the position of the cursor
- 5 To switch the language
- 6 To finish character entry



- ▶ **To select the input line:** select **[T]**.
- ▶ Swipe up or down.
- ▶ **To move the cursor within the input line:** select **[T/]**.
- ▶ Swipe to the left or right.
- ▶ **To delete characters:** swipe to the left if an input line is selected.
- ▶ **To confirm the entry:** press the touchpad.

### Switching the text reader function of the handwriting recognition on/off

Multimedia system:

- ▶ Select **Vehicle** → **System Settings** → **Touchpad** → **Read Out Handwriting Recognition**.  
The read-aloud function is switched on  or off .

### Quick access for audio

#### Changing the station/music track

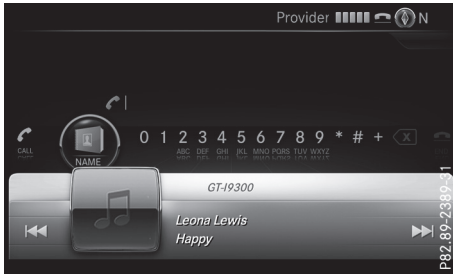

Depending on the audio source that is currently activated, you can use this function to select the next station or music track.

- ▶ Swipe upwards with two fingers on the touchpad.  
The current audio source is displayed.
- ▶ **To select the previous or next station/music track:** glide to the right or left.  
The selected station/music track is played.

### Switching the character entry between touchpad and controller

Requirement: an input line for text, numbers or characters has been selected.

- ▶ **To switch to the controller:** press the controller.  
Character entry using the controller is active.
- ▶ **To switch to the touchpad:** press the touchpad with your finger.  
Handwriting recognition on the touchpad is active.

## Favorites

### Calling up and exiting favorites

- ▶ **To call up:** press the **[\*]** button on the controller or on the touchpad.
- ▶ Select a favorite, e.g. **Vehicle**.  
The favorites are displayed.
- ▶ **To exit:** press the **[\*]** button again.

### Adding favorites

#### Adding a predefined favorite

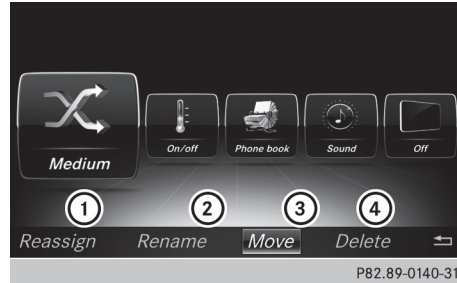

- ① Adds a new favorite
- ② Renames a selected favorite
- ③ Moves a selected favorite
- ④ Deletes a selected favorite

- ▶ Press the **[\*]** button.
- ▶ Slide **⊙↓** the controller.  
The menu bar is shown.
- ▶ Select **Reassign**.  
The categories are displayed.
- ▶ Select a category.  
The favorites are displayed.
- ▶ Select a favorite.
- ▶ Add a favorite at the desired position.  
If a favorite has already been added at this position, it will be overwritten.

### Adding your own favorite

- ▶ Select **Vehicle** → **Climate Control**.
- ▶ Press and hold the  button until the favorites are displayed.
- ▶ Add a favorite at the desired position.  
If a favorite has already been added at this position, it will be overwritten.

## Climate control settings

### General notes

You can adjust the climate control settings using the climate control bar or the climate control menu.

Important climate control functions can be set in the climate control bar:

- Temperature
- Airflow
- Air distribution

The climate control bar is visible in most displays.

You can find all available climate control functions in the climate control menu. You can use the climate control bar to switch to the climate control menu.

### Overview

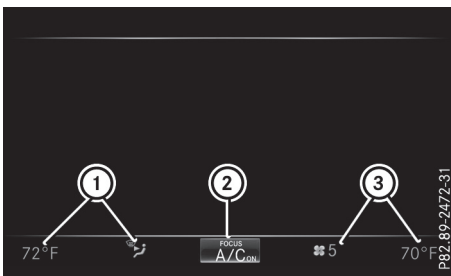

Climate control bar (COMAND)

- ① Adjusts temperature, air distribution, displays the current settings
- ② Calls up the climate control menu, displays the current cooling and climate mode settings
- ③ Adjusts airflow and temperature, displays the current settings

There may be fewer settings or none depending on your vehicle's equipment.

### Calling up the climate control bar

Multimedia system:

- ▶ Select **Vehicle**.  
The vehicle menu is displayed.
- ▶ Slide  the controller repeatedly until the climate control bar is activated.

### Calling up the climate control menu

Multimedia system:

- ▶ Select **Vehicle**.  
The vehicle menu is displayed.
- ▶ Slide  the controller repeatedly until the climate control bar is activated.
- ▶ To select from climate control bar ②: turn and press the controller.  
The menu for selecting the climate control function is activated.
- ▶ To select the climate control function: turn and press the controller.  
The selected climate control function appears.

### Settings in the climate menu

#### Adjusting the climate mode settings

The climate mode determines the type of airflow. The setting is active when the air-conditioning system is set to **AUTO** (▶ page 96).

- ▶ Call up the climate control menu (▶ page 203).
- ▶ To select **Climate Mode**: turn and press the controller.
- ▶ To change the setting: turn the controller.
- ▶ **To exit the menu**: press the  button.

The climate mode bar displays the current airflow setting: **DIFFUSE**, **MEDIUM** or **FOCUS**.

#### Settings in the bottom bar of the climate control menu

#### Switching cooling with air dehumidification on/off

- ▶ Call up the climate control menu (▶ page 203).
- ▶ Slide  the controller repeatedly until the bottom bar is activated.

- ▶ To select  **A/C**: turn and press the controller.
- ▶ Switch cooling with air dehumidification on  or off .
- i** The current status of the cooling function is displayed in the climate control bar: A/C ON – activated, A/C OFF – deactivated.
- i** Deactivating the cooling with air dehumidification function reduces fuel consumption.

### Synchronizing the climate control settings

Use  **Sync** (synchronization) to select the climate control setting for all zones together  or separately .

- ▶ Call up the climate control menu (▷ page 203).
- ▶ Slide  the controller repeatedly until the bottom bar is activated.
- ▶ To select  **Sync**: turn and press the controller.
- ▶ Switch the synchronization function on  or off .

For further information on synchronizing climate control settings, see (▷ page 97).

### Navigation mode

#### Important safety notes

##### **WARNING**

If you operate information systems and communication equipment integrated in the vehicle when driving, you may be distracted from the traffic situation. You could also lose control of the vehicle. There is a risk of an accident.

Only operate this equipment when the traffic situation permits. If you are not sure that this is possible, park the vehicle paying attention to traffic conditions and operate the equipment when the vehicle is stationary.

You must observe the legal requirements for the country in which you are currently driving when operating the navigation system.

### General notes

Among other things, correct functioning of the navigation system depends on GPS reception. In certain situations, GPS reception may be impaired, there may be interference or there may be no reception at all, e.g. in tunnels or parking garages.

The following descriptions apply to navigation with COMAND. Further information can be found in the Digital Operator's Manual.

### Selecting a route type and route options

Multimedia system:

- ▶ Select **Navi** → **Navigation**.
- ▶ Select **Options** → **Route Settings**.
- i** If route guidance is active, first slide  the controller and show the menu.
- ▶ Select a route type.

Notes for route types:

- **Eco Route**  
Calculates an economic route.
- **Dynamic Traffic Route** (only available in the USA)  
Traffic reports on the route for the route guidance are taken into account.
- **Calculate Alternative Routes**  
Different routes are being calculated. Instead of **Start**, select the **Continue** menu item.
- ▶ **To avoid/use route options**: select **Avoid Options**.
- ▶ Select a route option.

Notes for route options:

- **Use Toll Roads**  
The route calculation includes roads which require you to pay a usage fee (toll).
- **Use Carpool Lanes** (only available in the USA)  
Prerequisite: your vehicle meets the access conditions for carpool lanes.  
Carpool lanes will be included if the carpool lanes option is activated.



### Entering an address

Multimedia system:

- ▶ Select **Navi** → **Navigation**.
- ▶ Select **Destination** → **Address Entry**.

- i** If route guidance is active, first slide  the controller and show the menu.

Enter an address, e.g. as follows:

- city or ZIP code, street, house number
- country, city or ZIP code
- city or ZIP code, center
- street, city or ZIP code, intersection
- ▶ Select **City**.  
The city in which the vehicle is currently located (current vehicle position) is at the top. Below this, you will see locations for which route guidance has already been carried out.
- ▶ Enter the city.  
The  symbol: the location is contained on the digital map multiple times.
- ▶ **To switch to the list:** slide the  controller.
- ▶ Select the location.  
If available, the ZIP code is shown. If there are different ZIP codes available for the location, the corresponding digits are displayed with an **X**.
- ▶ Enter the street and house number.  
The address is in the menu.

#### Further options for destination entry:

- keyword search  
The keyword search finds destinations using fragments of words.
- select the last destination
- select a contact
- select a POI  
You can search for a POI by location, name or telephone number.
- select destination on the map
- enter intermediate destination  
You can map the route to the destination yourself with up to four intermediate destinations.
- select destinations from Mercedes-Benz Apps
- select geo-coordinates

#### Calculating the route

Prerequisite: the address has been entered and is in the menu.

- ▶ Select **Start** or **Continue**.  
The route is calculated with the selected route type and the selected route options.

If route guidance has already been activated, a prompt will appear asking whether you wish to end the current route guidance.

- ▶ Select **Yes** or **Set as Intermediate Destination**.

**Yes** cancels the current route guidance and starts route calculation to the new destination.

**Set as Intermediate Destination** adds the new destination in addition to the existing destination and opens the intermediate destinations list.

### Connecting a mobile phone

#### Requirements

For telephony via the Bluetooth® interface, you require a Bluetooth®-capable mobile phone. The mobile phone must support Hands-Free Profile 1.0 or above.

Multimedia system:

- ▶ Select **Vehicle** → **System Settings** → **Activate Bluetooth**.
- ▶ Activate Bluetooth® .

Mobile phone:

- ▶ Activate Bluetooth® and, if necessary, Bluetooth® visibility for other devices (see the manufacturer's operating instructions).

The Bluetooth® device names for all of one manufacturer's products might be identical. To make it possible to clearly identify your mobile phone, change the device name (see the manufacturer's operating instructions).

If the mobile phone supports the PBAP (**Phone Book Access Profile**) and MAP (**Message Access Profile**) Bluetooth® profiles, the following information will be transmitted after you connect:

- Phone book
- Call lists
- Messages

- i** Further information on suitable mobile phones can be obtained on the Internet at: <http://www.mercedes-benz.com/connect>

- i** In the USA, you can get in touch with the Mercedes-Benz Customer Assistance Center on 1-800-FOR-MERCEdes (1-800-367-6372). In Canada, you can get in touch with the Customer Relations Center on 1-800-387-0100.

### Searching for and authorizing a mobile phone

Before using your mobile phone with the multimedia system for the first time, you will need to search for the phone and then authorize (connect) it. Depending on the mobile phone, authorization either takes place by means of Secure Simple Pairing or by entering a passkey. The multimedia system automatically makes the procedure that is relevant for your mobile phone available. The mobile phone is always connected automatically after authorization. Further information on using a mobile phone with the multimedia system (see the Digital Operator's Manual).

If the multimedia system does not detect your mobile phone, this may be due to particular security settings on your mobile phone (see the manufacturer's operating instructions).

Only one mobile phone can be connected to the multimedia system at any one time.



#### Searching for a mobile phone

COMAND:

- ▶ Select **Phone** → **Connect Device** → **Search for Phones** → **Start Search**.

The available mobile phones are displayed.

#### Symbols in the device list

| Symbol  | Explanation                                       |
|---|---|
|  | New mobile phone found, not yet authorized.       |
|  | Mobile phone is authorized, but is not connected. |
| •   | Mobile phone is authorized and connected.         |

#### Connecting a mobile phone

Authorization using Secure Simple Pairing:

- ▶ Select mobile phone.  
A code is displayed in the multimedia system and on the mobile phone.
- ▶ **If codes match:** select **Yes** on the multimedia system.
- ▶ Confirm code on the mobile phone. Depending on the mobile phone used, confirm the connection to the multimedia system and for the PBAP and MAP Bluetooth® profiles. The prompt to confirm may take up to two minutes to be displayed (see the manufacturer's operating instructions).
- ▶ **If the codes are different:** select **No** on the multimedia system.  
The process is canceled.  
Repeat authorization.

Authorization by entering a passkey (passcode):

- ▶ Select Bluetooth® name of the mobile phone. The input menu for the passkey is displayed.
- ▶ Choose a one to sixteen-digit number combination as a passkey.
- ▶ Enter the passkey on the multimedia system.
- ▶ Press **ok** to confirm.
- ▶ Enter and confirm the passkey on the mobile phone. Depending on the mobile phone used, confirm the connection to the multimedia system and for the PBAP and MAP Bluetooth® profiles. The prompt to confirm may take up to two minutes to be displayed (see the manufacturer's operating instructions).

### Switching between mobile phones

If you have authorized more than one mobile phone, you can switch between the individual phones.

Multimedia system:

- ▶ Select **Connect Device**.
- ▶ Select a mobile phone from the device list.

### Media mode

#### General notes

If you wish to play external media sources, the appropriate media mode must already be turned on. Further information on media mode (see the Digital Operator's Manual).

The following external media sources can be used:

- Apple® devices (e.g. iPhone®)
- USB devices (e.g. USB stick, MP3 player)
- CD/DVD (COMAND)
- SD cards (COMAND)
- via devices connected by Bluetooth®

**i** Information on the single DVD drive (see the Digital Operator's Manual).

### Activating media mode

Multimedia system:

- ▶ Select **Media** → **Devices**.  
The available media sources will be shown.
- ▶ Select the media source.  
Playable files are played.

### Inserting and removing the SD card (COMAND)

#### Important safety notes

##### **WARNING**

SD cards are small parts. They can be swallowed and cause choking. This poses an increased risk of injury or even fatal injury.

Keep the SD card out of the reach of children. If a SD card is swallowed, seek medical attention immediately.

**L** If you are no longer using the SD card, you should remove it and store it outside the vehicle. High temperatures can damage the card.

#### Inserting an SD card

The SD card slot is located in the stowage compartment under the armrest.

- ▶ Insert the SD card into the SD card slot until the SD card engages. The side with the contacts must face down.
- ▶ Select the media source (▷ page 207).

#### Removing an SD card

- ▶ Press the SD card.  
The SD card is ejected.
- ▶ Remove the SD card.

### Connecting USB devices

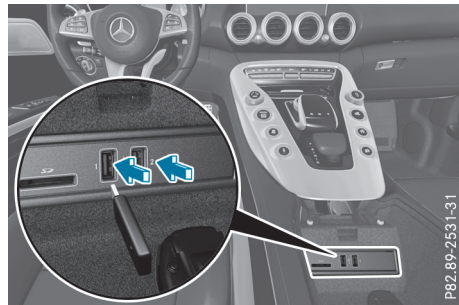

There are two USB ports in the stowage space under the armrest.

- ▶ Connect the USB device to the USB port.
- ▶ Select the media source (▷ page 207).

## Stowage areas

### Loading guidelines

#### WARNING

Combustion engines emit poisonous exhaust gases such as carbon monoxide. If the tailgate is open when the engine is running, particularly if the vehicle is moving, exhaust fumes could enter the passenger compartment. There is a risk of poisoning.

Turn off the engine before opening the tailgate. Never drive with the tailgate open.

#### WARNING

If objects, luggage or loads are not secured or not secured sufficiently, they could slip, tip over or be flung around and thereby hit vehicle occupants. There is a risk of injury, particularly in the event of sudden braking or a sudden change in direction.

Always store objects so that they cannot be flung around. Secure objects, luggage or loads against slipping or tipping before the journey.

#### WARNING

The exhaust tail pipe and tail pipe trim can become very hot. If you come into contact with these parts of the vehicle, you could burn yourself. There is a risk of injury.

Always be particularly careful around the exhaust tail pipe and the tail pipe trim. Allow these components to cool down before touching them.

**!** This vehicle is not designed to transport items on the roof. Roof carriers and other devices which are mounted on the roof that have not been specifically approved for this model by Mercedes-Benz must not be used as they could damage the vehicle and the retractable hardtop (vario-roof).

At the time of going to print, Mercedes-Benz does not offer any roof carrier or other roof-installed devices for this model.

**!** This vehicle is not designed for objects such as luggage carriers or other devices to be installed or transported on the trunk lid.

The handling characteristics of a laden vehicle are dependent on the distribution of the load within the vehicle. For this reason, you should observe the following notes when transporting a load:

- Never exceed the maximum permissible gross vehicle mass or the gross axle weight rating for the vehicle (including occupants). The values are specified on the vehicle identification plate on the B-pillar of the driver's door.
- The cargo compartment is the preferred place to carry objects.
- Position heavy loads as far forward as possible and as low down in the cargo compartment as possible.
- The load must not protrude above the upper edge of the seat backrests.
- Hook in the cargo net when loading.
- Secure the load with sufficiently strong and wear-resistant tie-downs. Pad sharp edges for protection.

## Stowage spaces

### Important safety notes

#### WARNING

If you transport objects in the vehicle interior and these are not adequately secured, they could slip or be flung around and thereby strike vehicle occupants. In addition, cup holders, open stowage spaces and mobile phone brackets may not always be able to hold the objects placed in them in the event of an accident. There is a risk of injury, particularly in the event of sharp braking or sudden changes of direction.

- Always stow objects in such a way that they cannot be tossed about in these or similar situations.
- Always make sure that objects do not protrude out of the stowage spaces, luggage nets or stowage nets.



- Ensure that closable stowage spaces are shut before beginning your journey.
- Always stow and secure heavy, hard, pointed, sharp-edged, fragile or large objects in the cargo compartment.

Observe the loading guidelines (▷ page 208).

### Glove box

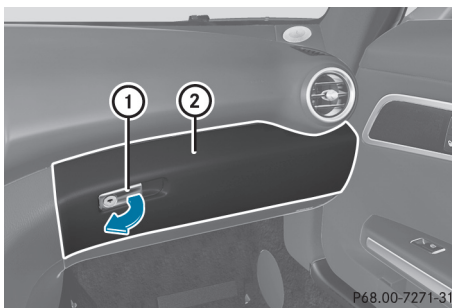

- ▶ **To open:** pull handle ① and open glove box flap ②.
- ▶ **To close:** fold glove box flap ② up until it engages.

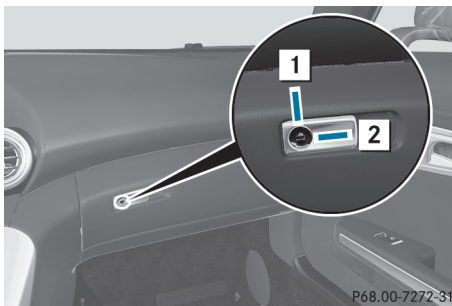

The glove box can be locked and unlocked using the mechanical key.

- ▶ **To lock:** insert the mechanical key into the lock and turn it to key position ②.
- ▶ **To unlock:** insert the mechanical key into the lock and turn it to key position ①.

### Stowage compartment in front of the armrest



- ▶ **To open:** slide cover ① forwards.

### Stowage compartment under armrest

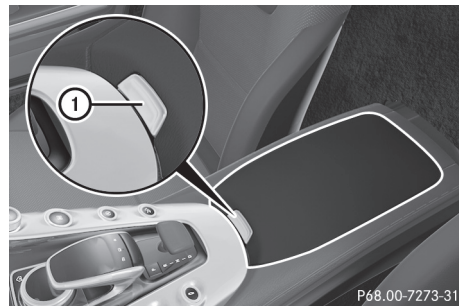

- ▶ **To open:** press button ①.  
The stowage compartment opens from the rear.

Depending on the vehicle's equipment, the following may be in the stowage space:

- a multimedia connector unit with an SD card slot and two USB ports, for example, for use with an iPod®, iPhone® or MP3 player (see the Digital Operator's Manual).

The ignition lock for starting the engine with the SmartKey is in the stowage compartment (▷ page 102).

### Additional stowage space

Depending on the equipment, the following additional stowage areas are available in the vehicle:

- open stowage compartments in the doors
- stowage net in the front-passenger footwell

- i** Reflective safety jackets can be stored in the door stowage compartments.

Observe the safety guidelines for stowage spaces (► page 208).

### Cargo compartment cover

#### Important safety notes

##### **⚠ WARNING**

On its own, the cargo compartment cover cannot secure or restrain heavy objects, items of luggage and heavy loads. You could be hit by an unsecured load during sudden changes in direction, braking or in the event of an accident. There is an increased risk of injury or even fatal injury.

Always store objects so that they cannot be flung around. Secure objects, luggage or loads against slipping or tipping over, e.g. by using tie downs, even if you are using the cargo compartment cover.

The cargo compartment cover conceals objects in the vehicle's cargo compartment.

#### Attaching and detaching the cargo compartment cover

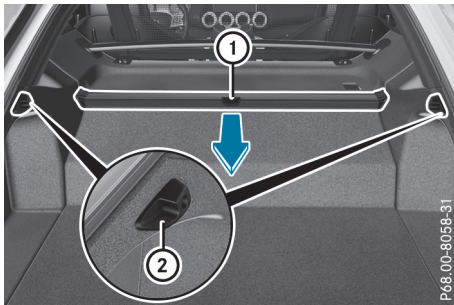

- **To attach:** pull the cargo compartment cover by grab handle ① and attach it to retainers ② on the left and right-hand sides.
- **To detach:** detach the cargo compartment cover from retainers ② and guide it forwards by grab handle ① above retainers ②, until it is completely rolled up.

### Cargo net

#### Important safety notes

##### **⚠ WARNING**

On its own, the cargo net cannot secure or restrain heavy objects, items of luggage and heavy loads. You could be hit by an unsecured load during sudden changes in direction, braking or in the event of an accident. There is an increased risk of injury or even fatal injury.

Always store objects so that they cannot be flung around. Secure objects, luggage or loads against slipping or tipping over, e.g. by using tie downs, even if you are using the cargo net.

It is important to use a cargo net if you load the vehicle with small objects above the seat backrests. For safety reasons, always use a cargo net when transporting loads.

Remove the cargo net from the bag supplied in the cargo compartment.

- Unroll and unfold the cargo net.

#### Attaching and tightening the cargo net

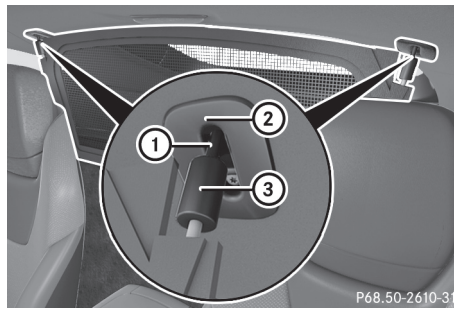

- **To attach and tighten:** push the seats as far back as possible.
- From the vehicle interior, insert hooks ① into upper retainers ② and turn back by 90°. Upper tensioning hook ③ stretches the cargo net automatically.

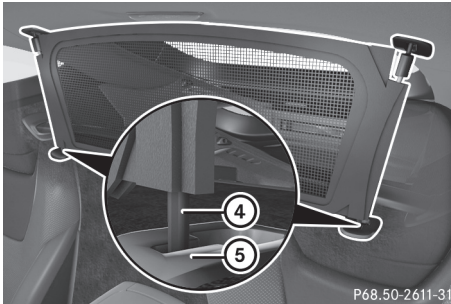

P68.50-2611-31

- ▶ Attach hooks ④ to lower retainers ⑤.
- ▶ After driving a short distance, check the tension of the cargo net.
- ▶ **To loosen and detach:** turn back hooks ① by 90° and detach from upper retainer ②.
- ▶ Detach hooks ④ from lower retainers ⑤.
- ▶ **To stow:** fold the cargo net, roll it up and stow it in the in bag supplied.

## Features

### Cup holder

#### Important safety notes

##### WARNING

If you transport objects in the vehicle interior and these are not adequately secured, they could slip or be flung around and thereby strike vehicle occupants. In addition, cup holders, open stowage spaces and mobile phone brackets may not always be able to hold the objects placed in them in the event of an accident. There is a risk of injury, particularly in the event of sharp braking or sudden changes of direction.

- Always stow objects in such a way that they cannot be tossed about in these or similar situations.
- Always make sure that objects do not protrude out of the stowage spaces, luggage nets or stowage nets.

- Ensure that closable stowage spaces are shut before beginning your journey.
- Always stow and secure heavy, hard, pointed, sharp-edged, fragile or large objects in the cargo compartment.

**!** Only use the cup holders for containers of the right size and which have lids. The drinks could otherwise spill.

#### Cup holder in the center console

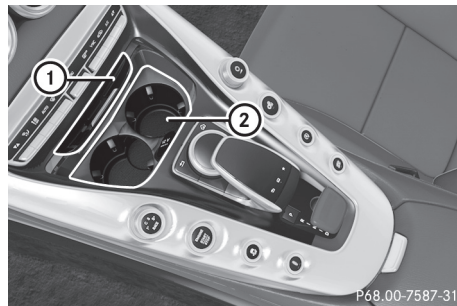

P68.00-7587-31

- ▶ **To open:** slide cover ① forward until it engages.

The divider in the cup holder can be removed, e.g. for inserting smaller drinks cans.

- ▶ **To remove:** pull the divider up and remove it.
- ▶ **To install:** re-insert the divider and push it down until it engages.

You can remove the rubber mat of cup holder ② to clean it. Clean with clear, lukewarm water only.

### Sun visors

#### Important safety notes

##### WARNING

If the mirror cover of the vanity mirror is folded up when the vehicle is in motion, you could be blinded by incident light. There is a risk of an accident.

Always keep the mirror cover folded down while driving.

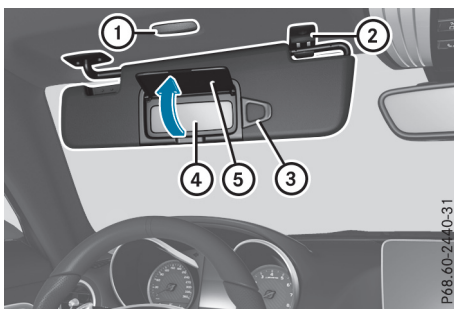
**Sun visor (variant 1)**

- ① Mirror light
- ② Retainer
- ③ Retaining clip, e.g. for a car park ticket
- ④ Vanity mirror
- ⑤ Mirror cover

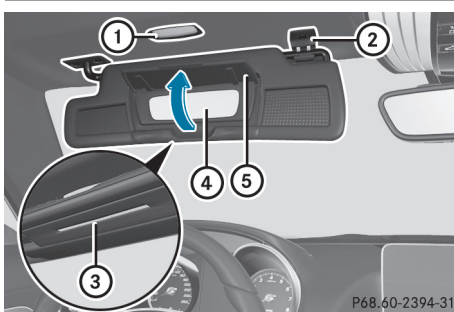
**Sun visor (variant 2)**

- ① Mirror light
- ② Retainer
- ③ Retaining strip, e.g. for a parking lot ticket
- ④ Vanity mirror
- ⑤ Mirror cover

**Vanity mirror in the sun visor**

Mirror light ① only functions if the sun visor is clipped into retainer ② and mirror cover ⑤ has been folded up.

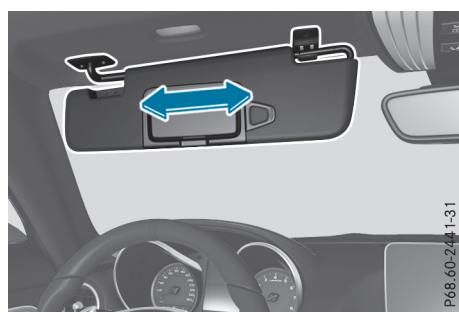
**Moving the sun visor (sun visor variant 1 only)**

- ▶ Fold down the sun visor.
- ▶ Slide the sun visor horizontally as desired.

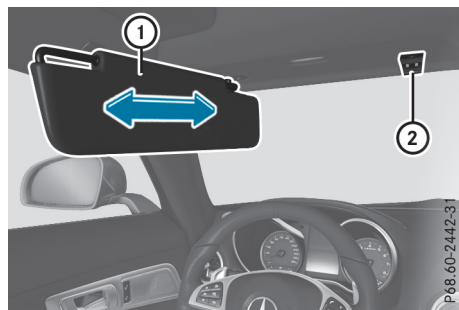
**Glare from the side**

- ▶ Fold down sun visor ①.
- ▶ Pull sun visor ① out of bracket ②.
- ▶ Swing sun visor ① to the side.
- ▶ Slide sun visor ① horizontally as required.

**Ashtray**

- ❗ The stowage space under the ashtray is not heat resistant. Before placing lit cigarettes in the ashtray, make sure that the ashtray is properly engaged. Otherwise, the stowage space could be damaged.

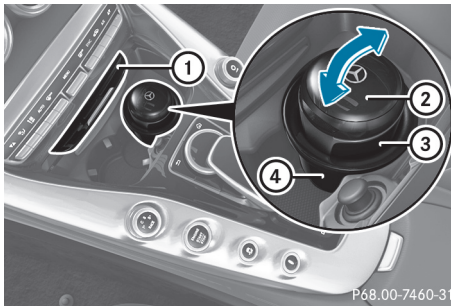

P68.00-7460-31

You can place insert (4) into the cup holder on the left-hand or right-hand side.

- ▶ Slide cover (1) forwards until it engages.
- ▶ **To open:** lift up lid (2).
- ▶ **To close:** press lid (2) downwards.
- ▶ **To remove:** pull ashtray (3) up and out of insert (4).
- ▶ **To insert:** place ashtray (3) into insert (4).

Remove insert (4) to be able to use the entire cup holder. Store removed insert (4) and ashtray (3) in a suitable place. Observe the loading guidelines (> page 208).

### Cigarette lighter

#### WARNING

You can burn yourself if you touch the hot heating element or the socket of the cigarette lighter.

In addition, flammable materials can ignite if:

- the hot cigarette lighter falls
- a child holds the hot cigarette lighter to objects, for example

There is a risk of fire and injury.

Always hold the cigarette lighter by the knob. Always make sure that the cigarette lighter is out of reach of children. Never leave children unsupervised in the vehicle.

Your attention must always be focused on the traffic conditions. Only use the cigarette lighter when road and traffic conditions permit.

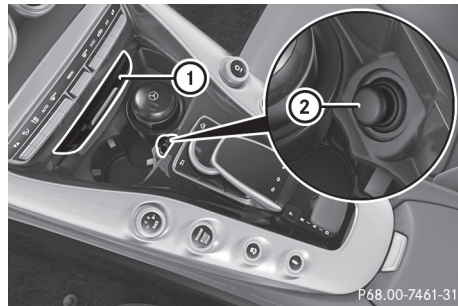

P68.00-7461-31

- ▶ Select key position (2) with the Start/Stop button (> page 102).
- ▶ **To open:** slide cover (1) forward until it engages.
- ▶ Press in cigarette lighter (2). Cigarette lighter (2) will pop out automatically when the heating element is red-hot.
- ▶ **To close:** briefly press cover (1) at the front.

### 12 V sockets

#### General notes

- ▶ Select key position (1) with the Start/Stop button (> page 102).

The sockets can be used for accessories with a maximum draw of 180 W (15 A). Accessories include such items as chargers for mobile phones.

If you use the sockets for long periods when the engine is switched off, the battery may discharge.

An emergency cut-out ensures that the on-board voltage does not drop too low. If the on-board voltage is too low, the power to the sockets is automatically cut. This ensures that there is sufficient power to start the engine.



### Socket in the cargo compartment

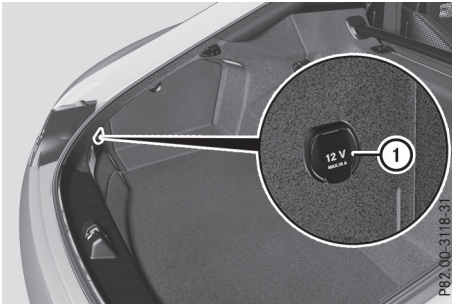

- ▶ Lift up the cover of socket ①.

### mbrace

#### General notes

The mbrace system is only available in the USA. A license agreement must be in place in order to activate the mbrace service. Make sure that your system is activated and operational. To register, press the  Info call button. If any of the steps mentioned are not carried out, the system may not be activated.

If you have questions about the activation, contact one of the following telephone hotlines: Mercedes-Benz Customer Assistance Center at 1-800-FOR-MERCEdes (1-800-367-6372) or 1-866-990-9007

Shortly after successfully registering with the mbrace service, a user ID and password will be sent to you by mail. You can use this password to log onto the mbrace area under "Owners Online" at <http://www.mbusa.com>.

The system is available if:

- it has been activated and is operational
- the corresponding mobile phone network is available for transmitting data to the Customer Center
- a service subscription is available

Determining the location of the vehicle on a map is only possible if:

- GPS reception is available
- the vehicle position can be forwarded to the Customer Assistance Center

### The mbrace system

To adjust the volume during a call, proceed as follows:

- ▶ Press the  or  button on the multi-function steering wheel.

or

- ▶ Use the multimedia system volume control.

The system offers various services, e.g.:





- Automatic and manual emergency call
- Roadside Assistance call
- Info call

You can find information and a description of all available features under "Owners Online" at <http://www.mbusa.com>.

### System self-test

After you have switched on the ignition, the system carries out a self-diagnosis.

A malfunction in the system has been detected if one of the following occurs:

- The indicator lamp in the SOS button does not come on during the system self-test.
- The indicator lamp in the  Roadside Assistance button does not light up during self-diagnosis of the system.
- The indicator lamp in the  Info call button does not light up during the system self-diagnosis.
- The indicator lamp in one or more of the following buttons continues to light up red after the system self-diagnosis:
  - SOS button
  -  Roadside Assistance call button
  -  Info call button
- The **Inoperative** or the **Service Not Activated** message appears in the multi-function display after the system self-diagnosis.

If a malfunction is indicated as outlined above, the system may not operate as expected. In the event of an emergency, help will have to be summoned by other means.

Have the system checked at the nearest authorized Mercedes-Benz Center or call the following telephone assistance services:

Mercedes-Benz Customer Assistance Center at 1-800-FOR-MERCEdes (1-800-367-6372) or 1-866-990-9007.

## Emergency call

### Important safety notes

#### WARNING

It can be dangerous to remain in the vehicle, even if you have pressed the SOS button in an emergency if:

- you see smoke inside or outside of the vehicle, e.g. if there is a fire after an accident
- the vehicle is on a dangerous section of road
- the vehicle is not visible or cannot easily be seen by other road users, particularly when dark or in poor visibility conditions

There is a risk of an accident and injury.

Leave the vehicle immediately in this or similar situations as soon as it is safe to do so.

Move to a safe location along with other vehicle occupants. In such situations, secure the vehicle in accordance with national regulations, e.g. with a warning triangle.

### General notes

Observe the notes on system activation (▷ page 214).

The emergency call is triggered automatically if an air bag is deployed or an Emergency Tensioning Device is triggered. You cannot end an automatically triggered emergency call yourself.

An emergency call can also be initiated manually.

As soon as the emergency call has been initiated, the indicator lamp in the SOS button flashes. The **Connecting Call** message appears in the multifunction display.

The audio output is muted.

Once the connection has been made, the **Call Connected** message appears in the multifunction display.

All important information on the emergency is transmitted, for example:

- Current location of the vehicle (as determined by the GPS system)
- Vehicle identification number
- Information on the severity of the accident

Shortly after the emergency call has been initiated, a voice connection is automatically estab-

lished between the Customer Assistance Center and the vehicle occupants.

- If the vehicle occupants respond, the Mercedes-Benz Customer Assistance Center attempts to get more information on the emergency.
- If there is no response from the vehicle occupants, an ambulance is immediately sent to the vehicle.
- If the relevant mobile phone network is not available, no emergency call can be initiated. The indicator lamp in the SOS button flashes continuously.

No voice connection can be established to the Mercedes-Benz Customer Assistance Center.

The **Call Failed** message appears on the multifunction display and must be confirmed.

In this case, summon assistance by other means.

### Making an emergency call



P82.95-3052-31

- ▶ **To initiate an emergency call manually:** press cover ① briefly to open.
- ▶ Press and hold the SOS button for at least one second ②. The indicator lamp in SOS button ② flashes until the emergency call is concluded.
- ▶ Wait for a voice connection to the Mercedes-Benz Customer Assistance Center.
- ▶ After the emergency call, close cover ①.

If the mobile phone network is unavailable, mbrace will not be able to make the emergency call. If you leave the vehicle immediately after pressing SOS button ②, you do not know if mbrace has successfully made the emergency call. In this case, always summon assistance by other means.



### Roadside Assistance button



P82.95-3053-31

- **To call:** press Roadside Assistance button ①. This initiates a call to the Mercedes-Benz Customer Assistance Center.

The indicator lamp in Roadside Assistance button ① flashes while the call is active. The **Connecting Call** message appears in the multifunction display. The audio output is muted.

If a connection can be established, the **Call Connected** message appears in the multifunction display.

If a mobile phone network and GPS reception are available, the system transfers data to the Mercedes-Benz Customer Assistance Center, for example:

- Current location of the vehicle
- Vehicle identification number

The multimedia system display indicates that a call is active. During the call, you can change to the navigation menu by pressing the NAVI button on the multimedia system, for example. Voice output is not available in this case.

A voice connection is established between the Mercedes-Benz Customer Assistance Center and the vehicle occupants.

From the remote malfunction diagnosis, the Mercedes-Benz Customer Assistance Center can ascertain the nature of the problem (► page 219).

The Mercedes-Benz Customer Assistance Center either sends a qualified Mercedes-Benz technician or makes arrangements for your vehicle to be transported to the nearest Mercedes-Benz Service Center.

You may be charged for services such as repair work and/or towing.

You can find more information in the separate owner's manual.

The system has not been able to initiate a Roadside Assistance call, if:

- the indicator lamp for the Roadside Assistance call button is flashing continuously.
- no voice connection to the Mercedes-Benz Customer Assistance Center was established.

This can occur if the relevant mobile phone network is not available, for example.

The **Call Failed** message appears in the multifunction display.

- **To end a call:** press the button on the multifunction steering wheel.

or

- Press the corresponding multimedia system button for ending a phone call.

### Info call button



P82.95-3054-31

- **To call:** press Info call button ①. This initiates a call to the Mercedes-Benz Customer Assistance Center.

The indicator lamp in Info call button ① flashes while the connection is being made. The **Connecting Call** message appears in the multifunction display. The audio output is muted.

If a connection can be established, the **Call Connected** message appears in the multifunction display.

If a mobile phone network and GPS reception are available, the system transfers data to the Mercedes-Benz Customer Assistance Center, for example:

- Current location of the vehicle
- Vehicle identification number

The multimedia system display indicates that a call is active. During the call, you can change to the navigation menu by pressing the NAVI button on COMAND, for example.

Voice output is not available in this case.

A voice connection is established between the Mercedes-Benz Customer Assistance Center and the vehicle occupants.

You receive information about operating your vehicle, about the nearest Mercedes-Benz Service Center and about other products and services from Mercedes-Benz.

You can find further information on the mbrace system under "Owners Online" at <http://www.mbusa.com>.

The system was unable to initiate an Info call if:

- the indicator lamp in the  Info call button is flashing continuously.
- no voice connection to the Mercedes-Benz Customer Assistance Center has been established.

This can occur if the relevant mobile phone network is not available, for example.

The **Call Failed** message appears in the multifunction display.

▶ **To end a call:** press the  button on the multifunction steering wheel.

or

▶ Press the corresponding multimedia system button for ending a phone call.

## Call priority

When service calls are active, e.g. Roadside Assistance or Info calls, an emergency call can still be initiated. In this case, an emergency call will take priority and override all other active calls.

The indicator lamp of the respective button flashes until the call is ended.

An emergency call can only be terminated by the Mercedes-Benz Customer Assistance Center.

All other calls can be ended by pressing:

- the  button on the multifunction steering wheel
- the corresponding button in the multimedia system to end the voice call

When a call is initiated, the audio system is muted.

The mobile phone is no longer connected to the multimedia system.

However, if you want to use your mobile phone, do so only when the vehicle is stationary and in a safe location.



## Downloading destinations in COMAND

### Downloading destinations

Downloading destinations gives you access to a database with over 15 million points of interest (POIs). These can be downloaded on the navigation system in your vehicle. If you know the destination, the address can be downloaded. Alternatively, you can obtain the location of Points of Interest (POIs)/important destinations in the vicinity.

Furthermore, you can download routes with up to four way points.

You are prompted to confirm route guidance to the address entered.

▶ Select **Yes** by turning  or sliding  the controller and confirm with .

The system calculates the route and subsequently starts the route guidance with the address entered.

If you select **No** the address can be stored in the address book.

The destination download function is available if:

- the vehicle is equipped with a navigation system.
- the relevant mobile phone network is available and data transfer is possible.

### Route Assistance

This service is part of the mbrace PLUS Package and cannot be purchased separately.

You can use the Route Assistance function even if the vehicle is not equipped with a navigation system.

Within the framework of this service, you receive a professional and reliable form of navigation support without having to leave your vehicle.

The customer service representative finds a suitable route depending on your vehicle's current position and the desired destination. You will then be guided live through the current route section.

## Search and Send

### General notes

To use "Search & Send", your vehicle must be equipped with mbrace and a navigation system. Additionally, an mbrace service subscription must be completed.

"Search & Send" is a service for entering destinations in the navigation system. A destination address which is found on Google Maps® can be transferred via mbrace directly to your vehicle's navigation system.

### Specifying and sending the destination address

- ▶ Go to the website <http://maps.google.com> and enter a destination address into the entry field.
- ▶ **To send the destination address to the e-mail address of your mbrace account:** click on the corresponding button on the website.

Example:

If you select 'Send to vehicle' and then 'Mercedes-Benz', the destination address will be sent to your vehicle.

- ▶ When the "Send" dialog window appears: Enter the e-mail address you specified when setting up your mbrace account into the corresponding field.
- ▶ Click "Send".

Information on specific commands such as "Address entry" or "Send" can be found on the website.

### Calling up a transmitted destination address

- ▶ Turn the SmartKey to position **2** in the ignition lock (> page 102). The transmitted destination address is loaded into the vehicle's navigation system. A display message appears, asking whether navigation should be started.
- ▶ Select **Yes** by turning **ⓘ** or sliding **↔** or sliding **↔** the controller and confirm with **Ⓜ**. The system calculates the route and subsequently starts the route guidance with the address entered. If you select **No** the address can be stored in the address book.

If you have sent more than one destination address, each individual destination must be confirmed separately.

Destination addresses are loaded in the same order as the order in which they were sent.

If you have multiple Mercedes-Benz vehicles with mbrace and active mbrace accounts:

If multiple vehicles are registered under the same e-mail address, the destination will be sent to all the vehicles.

## Vehicle remote opening

You can use the vehicle remote unlocking if you have unintentionally locked your vehicle and a replacement SmartKey is not available.

The vehicle can then be unlocked by the Mercedes-Benz Customer Assistance Center.

The vehicle can be immediately unlocked remotely within four days of the ignition being turned off. After this time, the remote unlocking may be delayed by 15 to 60 minutes. After 30 days, the vehicle can no longer be unlocked remotely.

The vehicle remote unlocking feature is available if the relevant mobile phone network is available and a data connection is possible.

- ▶ Contact the following service hotlines: Mercedes-Benz Customer Assistance Center at 1-800-FOR-MERcedes (1-800-367-6372) or 1-866-990-9007. You will be asked for your password.
- ▶ Return to your vehicle at the time agreed upon with the Mercedes-Benz Customer Assistance Center.

Alternatively, the vehicle can be opened via:

- the Internet, under the "Owners Online" section
- telephone applications (e.g. for iPhone®, Android™)

To do this, you will need your identification number and password.

## Vehicle remote closing

The vehicle remote closing feature can be used when you have forgotten to lock the vehicle and you are no longer nearby.

The vehicle can then be locked by the Mercedes-Benz Customer Assistance Center.

The vehicle can be immediately remotely locked within four days of the ignition being turned off. After this time, remote closing may be delayed by 15 to 60 minutes. After 30 days the vehicle can no longer be locked remotely.

The vehicle remote closing feature is available if the relevant mobile phone network is available and a data connection is possible.

- ▶ Contact the following service hotlines:  
Mercedes-Benz Customer Assistance Center at 1-800-FOR-MERCEdes (1-800-367-6372) or 1-866-990-9007  
You will be asked for your password.

The next time you are inside the vehicle and you switch on the ignition, the **Doors Locked Remotely** message appears in the multifunction display.

Alternatively, the vehicle can be locked via:

- the Internet, under the "Owners Online" section
- telephone applications (e.g. for iPhone®, Android™)

To do this, you will need your identification number and password.

### Stolen vehicle recovery service

If your vehicle has been stolen:

- ▶ Notify the police.  
The police will issue a numbered incident report.
- ▶ Forward this number to the Mercedes-Benz Customer Assistance Center along with your PIN.  
The Mercedes-Benz Customer Assistance Center then tries to locate the system. The Mercedes-Benz Customer Assistance Center contacts you and the local law enforcement agency if the vehicle is located.  
However, only the law enforcement agency is informed of the location of the vehicle.

If the anti-theft alarm system is activated for longer than 30 seconds, mbrace automatically notifies the Mercedes-Benz Customer Assistance Center.

### Vehicle Health Check

With the Vehicle Health Check, the Customer Assistance Center can provide improved support for problems with your vehicle. During an

existing call, vehicle data is transferred to the Customer Assistance Center.

The customer service representative can use the received data to decide what kind of assistance is required. You are then, for example, guided to the nearest Mercedes-Benz Service Center or a recovery vehicle is called.

If vehicle data need to be transferred during an Info call or a Roadside Assistance call, this is initiated by the Customer Assistance Center.

The **Roadside Assistance Connected** message appears in the display. If the Vehicle Health Check can be started, the **Request for Vehicle Diagnostics Received Start vehicle diagnostics?** message appears in the display.

- ▶ Press the **Yes** button to confirm the message.
- ▶ If the **Vehicle Diagnostics Please Start Ignition** message appears: turn the SmartKey to key position **2** in the ignition lock (> page 102).
- ▶ If the **Please follow the instructions received by phone and move your vehicle to a safe position.** message appears: please follow the instructions received by phone and move your vehicle to a safe position.  
The message in the display disappears.  
The vehicle operating state check begins. During this procedure, you will see the **Vehicle Diagnostics Active** message.  
If you select **Cancel**, the Vehicle Health Check is canceled completely.

When the check is complete, the **Sending vehicle diagnostics data. (Voice connection may be interrupted during data transfer)** message appears. The vehicle data can now be sent.

- ▶ Press the **OK** button to confirm the message.  
The voice connection with the Customer Assistance Center is terminated.  
The **Vehicle Diagnostics: Transferring Data...** message appears.  
The vehicle data is sent to the Customer Assistance Center.

Depending on what the customer service representative agreed with you, the voice connection is re-established after the transfer is complete. If necessary, you will be contacted at a later time by another means, e.g. by e-mail or phone.

Another function of the Vehicle Health Check is the transfer of service data to the Customer Assistance Center. If a service is due, the display shows a message to this effect together with information about any special offers at your workshop.

This information can also be called up under "Owners Online" at <http://www.mbusa.com>.

Information on the data stored in the vehicle (▷ page 28).

Information on Roadside Assistance (▷ page 25).

### Downloading routes

Downloading routes allows you to transfer and save predefined routes in the navigation system.

A route can be prepared and sent either by a customer service representative or under "Owners Online" at <http://www.mbusa.com>.

Each route can include up to four way points.

Once a route has been received by the navigation system, you will see the **Do you want to start route guidance? Destination Received destination has been saved in "Previous destinations"**. message on the multimedia system display.

The route is saved.

- ▶ **To start route guidance:** select **Yes**.

An overview of the route is shown in the display.

If you select **No**, the saved route can be called up later in the navigation menu.

- ▶ Select **Start**.

Route guidance starts.

Downloaded and saved routes can be called up again.

### Speed alert

You can define the upper speed limit, which must not be exceeded by the vehicle.

If the vehicle exceeds the set speed, a message is sent to the Customer Assistance Center. The Customer Assistance Center then forwards this information to you.

You can select the way in which you receive this information beforehand. Possible options include text message, e-mail or an automated call.

The data you receive contains the following information:

- the location where the speed limit was exceeded
- the time at which the speed limit was exceeded
- the selected speed limit which was exceeded

### Geo fencing

Geo fencing allows you to select areas which the vehicle should not enter or leave. You will be informed if the vehicle crosses the boundaries of the selected areas. You can select the way in which you receive this information beforehand. Possible options include text message, e-mail or an automated call.

The area can be determined as either a circle or a polygon with a maximum of ten corners. You can specify up to ten areas simultaneously. Different settings are possible for each area.

These settings can be called up under "Owners Online" at <http://www.mbusa.com>.

Alternatively, you can also trigger an Info call and notify the customer service representative that you wish to activate geo-fencing.

Currently inactive areas can be activated by text message.

### Triggering the vehicle alarm

With this function, you can trigger the vehicle's panic alarm via text message. An alarm sounds and the exterior lighting flashes. Depending on the setting, the panic alarm lasts five or ten seconds. Afterwards, the alarm switches off.

## Active aerodynamics profile

### Overview

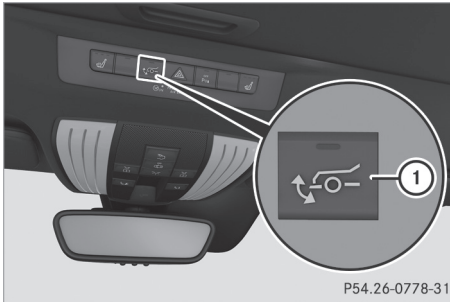

The active aerodynamics profile is located at the front end of the vehicle on the underbody. It improves the vehicle's aerodynamics depending on the vehicle speed.

Only use button ① to extend and retract the active aerodynamics profile manually for cleaning.

Button ① is not used to operate the active aerodynamics profile.

The active aerodynamics profile is extended automatically if you drive faster than:

- 75 mph (120 km/h) in drive programs **C**, **S** and **S+**
- 50 mph (80 km/h) in the **RACE** drive program

Button ① flashes until the active aerodynamics profile has extended and then lights up red.

The active aerodynamics profile is retracted automatically if you drive slower than:

- 50 mph (80 km/h) in drive programs **C**, **S** and **S+**
- 38 mph (60 km/h) in the **RACE** drive program

Button ① flashes until the active aerodynamics profile has retracted and then goes out.

### Extending and retracting the active aerodynamics profile manually

#### **WARNING**

Body parts could become trapped if you manually retract the active aerodynamics profile. There is a risk of injury.

When retracting the active aerodynamics profile, make sure that nobody is within the range of movement of it. Release the switch immediately if somebody becomes trapped. The active aerodynamics profile then extends again.

When leaving the vehicle, always take the SmartKey with you and lock the vehicle. Never leave children unsupervised in the vehicle.

**!** Take the restricted ground clearance into account when the active aerodynamics profile is extended.

You can extend and retract the active aerodynamics profile manually for cleaning.

► Select key position ② with the Start/Stop button (▷ page 102).

► **To extend:** press and hold button ① until the active aerodynamics profile is fully extended. Button ① flashes until the active aerodynamics profile has extended and then lights up in red.

**Extending Spoilers Press and Hold Switch** appears in the display.

► **To retract:** press and hold button ① until the active aerodynamics profile is fully retracted. Button ① flashes until the active aerodynamics profile has retracted and then goes out.

**Retracting Spoilers Press and Hold Switch** appears in the display.

If you release button ① while retracting the active aerodynamics profile, retracting stops. Retracting continues when you press the button again.

If you release button ① while extending the active aerodynamics profile, extending stops. Extending continues when you press the button again.



### Problems with the active aerodynamics profile

| Problem   | Possible causes/consequences and ► Solutions   |
|---|--|
| The active aerodynamics profile stops moving when retracting or extending manually. | You have switched off the ignition.<br>► Switch the ignition back on.<br>► Press button ①.<br>The active aerodynamics profile then retracts or extends.  |
| The active aerodynamics profile does not extend manually.                           | The active aerodynamics profile can only be retracted or extended manually when the vehicle is stationary and position <b>P</b> is engaged.<br>The active aerodynamics profile retracts automatically, as soon as the vehicle starts moving. |
| The active aerodynamics profile does not retract or extend automatically.           | The active aerodynamics profile's movement is blocked, e.g. by a trapped object.<br>► Remove the object.   |

### Permanently mounted rear spoiler

The rear spoiler improves vehicle downforce, and consequently improves driving stability.

The rear spoiler can be set to a steep or flat position.

When the rear spoiler is set to the inclined position, rear axle downforce increases and air resistance increases.

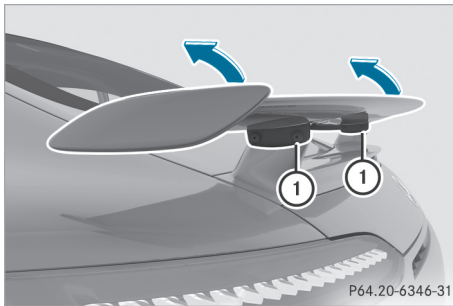

Setting the position:

- Unscrew screws ① with a socket wrench.
- Move the rear spoiler to the upper or lower stop limit.
- Cover screws ① with a soluble, medium-strength screw locking material and tighten them again.

Tightening torque: 7.37 ft-lb (10 Nm)

### Garage door opener

#### General notes

The HomeLink® garage door opener integrated in the rear-view mirror allows you to operate up to three different door and gate systems.

Use the integrated garage door opener only on garage doors that:

- have safety stop and reverse features and
- meet current U.S. federal safety standards

Once programmed, the integrated garage door opener in the rear-view mirror will assume the function of the garage door system's remote control. Please also read the operating instructions for the garage door system.

When programming a garage door opener, park the vehicle outside the garage. Do not run the engine while programming.

Certain garage door drives are incompatible with the integrated garage door opener. If you have difficulty programming the integrated garage door opener, contact a Mercedes-Benz Service Center.

Alternatively, you can call the following telephone assistance services:

- **USA:** Mercedes-Benz Customer Assistance Center at 1-800-FOR-MERcedes
- **Canada:** Customer Service at 1-800-387-0100
- HomeLink® hotline 1-800-355-3515 (free of charge)



More information on HomeLink® and/or compatible products is also available online at <http://www.homelink.com>.

Notes on the declaration of conformity (▷ page 26).

USA: FCC ID: CB2HMIHL4

Canada: IC: 279B-HMIHL4

### Important safety notes

#### WARNING

When you operate or program the garage door with the integrated garage door opener, persons in the range of movement of the garage door can become trapped or struck by the garage door. There is a risk of injury.

When using the integrated garage door opener, always make sure that nobody is within the range of movement of the garage door.

#### WARNING

Combustion engines emit poisonous exhaust gases such as carbon monoxide. Inhaling these exhaust gases leads to poisoning. There is a risk of fatal injury. Therefore never leave the engine running in enclosed spaces without sufficient ventilation.

### Programming

#### Programming buttons

Pay attention to the "Important safety notes" (▷ page 223).

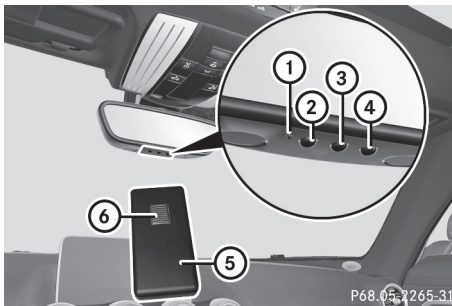

Garage door remote control ⑤ is not included with the integrated garage door opener.

▶ Select key position ② with the Start/Stop button (▷ page 102).

▶ Select one of buttons ② to ④ to use to control the garage door drive.

▶ **To start programming mode:** press and hold one of buttons ② to ④ on the integrated garage door opener.

The garage door opener is now in programming mode. After a short time, indicator lamp ① lights up yellow.

Indicator lamp ① lights up yellow as soon as button ②, ③ or ④ is stored for the first time. If the selected button has already been programmed, indicator lamp ① will only light up yellow after ten seconds have elapsed.

▶ Release button ②, ③ or ④. Indicator lamp ① flashes yellow.

▶ **To program the remote control:** point garage door remote control ⑤ towards buttons ② to ④ on the rear-view mirror at a distance of 2 to 8 in (5 to 20 cm).

▶ Press and hold button ⑥ on remote control ⑤ until indicator lamp ① lights up green. When indicator lamp ① lights up green: programming is finished.

When indicator lamp ① flashes green: programming was successful. The next step is to synchronize the rolling code (▷ page 223).

▶ Release button ⑥ on remote control ⑤ for the garage door drive system. If indicator lamp ① lights up red: repeat the programming procedure for the corresponding button on the rear-view mirror. When doing so, vary the distance between remote control ⑤ and the rear-view mirror.

The required distance between remote control ⑤ and the integrated garage door opener depends on the garage door drive system. Several attempts might be necessary. You should test every position for at least 25 seconds before trying another position.

#### Synchronizing the rolling code

Pay attention to the "Important safety notes" (▷ page 223).

If the garage door system uses a rolling code, you will also have to synchronize the garage door system with the integrated garage door opener in the rear-view mirror. To do this you will need to use the programming button on the door drive control panel. The programming button may be located in different places depending on

the manufacturer. It is usually located on the door drive unit on the garage ceiling.

Familiarize yourself with the garage door drive operating instructions, e.g. under "Programming additional remote controls", before carrying out the following steps.

Your vehicle must be within reach of the garage door or gate opener drive. Make sure that neither your vehicle nor any persons/objects are present within the sweep of the door or gate.

- ▶ Select key position **2** with the Start/Stop button (▷ page 102).
- ▶ Get out of the vehicle.
- ▶ Press the programming button on the door drive unit.  
You now have 30 seconds to initiate the next step.
- ▶ Get into the vehicle.
- ▶ Press previously programmed button **2**, **3** or **4** on the integrated garage door opener repeatedly until the door closes.  
The rolling code synchronization is then complete.

#### Notes on programming the remote control

Canadian radio frequency laws require a "break" (or interruption) of the transmission signals after broadcasting for a few seconds. Therefore, these signals may not last long enough for the integrated garage door opener. The signal is not recognized during programming. Comparable with Canadian law, some U.S. garage door openers also feature a "break".

Proceed as follows:

- if you live in Canada.
- if you have difficulties programming the garage door opener (regardless of where you live) when following the programming steps.
- ▶ Press and hold one of buttons **2** to **4** on the integrated garage door opener.  
After a short time, indicator lamp **1** lights up yellow.
- ▶ Release the button.  
Indicator lamp **1** flashes yellow.
- ▶ Press button **6** of garage door remote control **5** for two seconds, then release it for two seconds.
- ▶ Press button **6** again for two seconds.

- ▶ Repeat this sequence on button **6** of remote control **5** until indicator lamp **1** lights up green.

When indicator lamp **1** lights up green: programming is finished.

When indicator lamp **1** flashes green: programming was successful. The next step is to synchronize the rolling code.

- ▶ Release button **6** of remote control **5** of the garage door drive.

When indicator lamp **1** lights up red: repeat the programming process for the corresponding button on the rear-view mirror. When doing so, vary the distance between remote control **5** and the rear-view mirror.

The required distance between remote control **5** and the integrated garage door opener depends on the garage door drive system. Several attempts might be necessary. You should test every position for at least 25 seconds before trying another position.

#### Problems when programming

If you are experiencing problems programming the integrated garage door opener on the rear-view mirror, take note of the following instructions:

- Check the transmitter frequency used by garage door drive remote control **5** and whether it is supported. The transmitter frequency can usually be found on the back of remote control **5** for the garage door drive.  
The integrated garage door opener is compatible with devices that have units which operate in the frequency range of 280 to 433 MHz.
- Replace the batteries in garage door remote control **5**. This increases the likelihood that garage door remote control **5** will transmit a strong and precise signal to the integrated garage door opener.
- When programming, hold remote control **5** at varying distances and angles and from buttons **2** to **4** which you are programming. Try various angles at a distance between 2 and 8 inches (5 to 20 cm) or at the same angle but at varying distances.
- If a further remote control **5** is available for the same garage door drive, repeat the same programming steps with this remote control **5**. Before performing these steps, make sure that new batteries have been installed in garage door drive remote control **5**.

- Note that some remote controls only transmit for a limited amount of time (the indicator lamp on the remote control goes out). Press button ④ on remote control ⑤ again before transmission ends.
- Align the antenna cable of the garage door opener unit. This can improve signal reception/transmission.

### Opening/closing the garage door

After it has been programmed, the integrated garage door opener performs the function of the garage door system remote control. Please also read the operating instructions for the garage door system.

- ▶ Select key position ② with the Start/Stop button (▷ page 102).
- ▶ Press button ②, ③ or ④ which you programmed to operate the garage door.
  - Garage door system with a fixed code: indicator lamp ① lights up green.
  - Garage door system with a rolling code: indicator lamp ① flashes green.

The transmitter will transmit a signal as long as the button is pressed. The transmission is halted after a maximum of ten seconds and indicator lamp ① lights up yellow.
- ▶ Press button ②, ③ or ④ again if necessary.

### Clearing the memory

Make sure that you clear the memory of the integrated garage door opener before selling the vehicle.

- ▶ Select key position ② with the Start/Stop button (▷ page 102).
- ▶ Press and hold buttons ② and ④. Indicator lamp ① initially lights up yellow and then green.
- ▶ Release buttons ② and ④. The memory of the integrated garage door opener in the rear-view mirror is cleared.

### Floormats

#### WARNING

Objects in the driver's footwell can restrict the pedal travel or obstruct a depressed pedal.

The operating and road safety of the vehicle is jeopardized. There is a risk of an accident. Make sure that all objects in the vehicle are stowed correctly, and that they cannot enter the driver's footwell. Install the floormats securely and as specified in order to ensure sufficient clearance for the pedals. Do not use loose floormats and do not place floormats on top of one another.

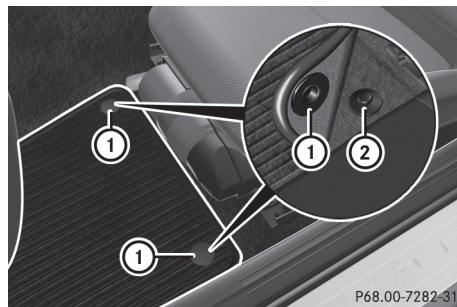

- ▶ Slide the driver's seat backwards.
- ▶ **To install:** place the floor mat in position.
- ▶ Press studs ① onto retainers ②.
- ▶ **To remove:** pull the floor mat off retainers ②.
- ▶ Remove the floor mat.

## Engine compartment

### Hood

#### Important safety notes

##### WARNING

If the hood is unlatched, it may open up when the vehicle is in motion and block your view. There is a risk of an accident.

Never unlatch the hood while driving. Before every trip, ensure that the hood is locked.

##### WARNING

When opening and closing the hood, it may suddenly fall into the closed position. There is a risk of injury to persons within range of movement of the hood.

Open and close the hood only when no one is within its range of movement.

##### WARNING

Opening the hood when the engine is overheated or when there is a fire in the engine compartment could expose you to hot gases or other service products. There is a risk of injury.

Let an overheated engine cool down before opening the hood. If there is a fire in the engine compartment, keep the hood closed and contact the fire department.

##### WARNING

The engine compartment contains moving components. Certain components, such as the radiator fan, may continue to run or start again suddenly when the ignition is off. There is a risk of injury.

If you need to do any work inside the engine compartment:

- switch off the ignition
- never reach into the area where there is a risk of danger from moving components, such as the fan rotation area

- remove jewelry and watches
- keep items of clothing and hair, for example, away from moving parts

##### WARNING

The ignition system and the fuel injection system work under high voltage. If you touch components which are under voltage, you could get an electric shock. There is a risk of injury.

Never touch components of the ignition system or fuel injection system when the ignition is switched on.

#### Opening the hood

##### WARNING

Certain components in the engine compartment, such as the engine, radiator and parts of the exhaust system, can become very hot. Working in the engine compartment poses a risk of injury.

Where possible, let the engine cool down and touch only the components described in the following.

##### WARNING

When the hood is open and the windshield wipers are set in motion, you can be injured by the wiper linkage. There is a risk of injury.

Always switch off the windshield wipers and the ignition before opening the hood.

- ❗ Make sure that the windshield wipers are not folded away from the windshield. You could otherwise damage the windshield wipers or the hood.

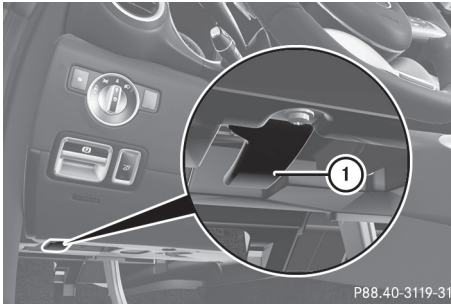

P88.40-3119-31

- ▶ Make sure that the windshield wipers are turned off.
- ▶ Pull release lever ① on the hood. The hood is released.

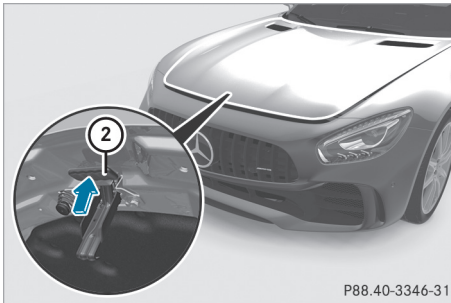

P88.40-3346-31

- ▶ Reach into the gap, pull hood catch handle ② up and lift the hood. If you lift the hood by approximately 15 in (40 cm), the hood is opened and held open automatically by the gas-filled strut.

### Closing the hood

#### WARNING

When closing the hood be careful that nobody becomes trapped.

- ▶ Lower the hood and let it fall from a height of approximately 8 in (20 cm).
- ▶ Check that the hood has engaged properly. If the hood can be raised slightly, it is not properly engaged. Open it again and close it with a little more force.

### Engine oil

#### Notes on the oil level

Depending on your driving style, the vehicle consumes up to 0.9 US qt (0.8 liters) of oil per 600 miles (1,000 km). The oil consumption may be higher than this when the vehicle is new or if you frequently drive at high engine speeds.

Depending on the engine, the oil dipstick may be in a different location.

It is only possible to correctly measure the oil level when:

- the engine is at normal operating temperature
- the vehicle is parked on a level surface
- the engine is left running in neutral for at least 30 seconds before switching off

This applies when checking the oil level using the oil dipstick or on-board computer.

#### Checking the oil level using the oil dipstick

#### WARNING

Certain components in the engine compartment, such as the engine, radiator and parts of the exhaust system, can become very hot. Working in the engine compartment poses a risk of injury.

Where possible, let the engine cool down and touch only the components described in the following.

It is only possible to correctly measure the oil level with the oil dipstick when the engine is at normal operating temperature and in a period of 2 to minutes after the engine has been switched off.

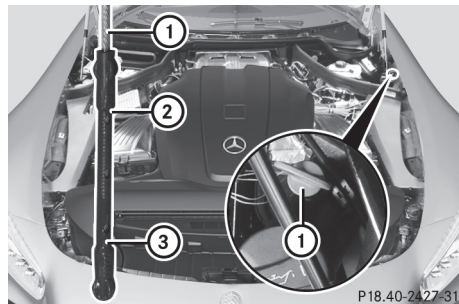







P18.40-2427-31

- ▶ Pull oil dipstick ① out of the dipstick guide tube.
- ▶ Wipe off oil dipstick ①.
- ▶ Slowly slide oil dipstick ① into the guide tube to the stop, and take it out again. If the level is between MIN mark ③ and MAX mark ②, the oil level is correct.
- ▶ If the oil level has dropped to MIN mark ③ or below, add 1.1 US qt (1.0 liter) engine oil.

### Checking the oil level using the on-board computer

#### Calling up the oil level measurement

- ▶ Select key position ② with the Start/Stop button.
- ▶ Use  on the steering wheel to call up the list of menus.
- ▶ Press the  or  button on the steering wheel to select the **Service** menu.
- ▶ Confirm by pressing  on the steering wheel.
- ▶ Use  or  to select the **Engine Oil Level** submenu.
- ▶ Press  to confirm the selection. The **Measuring Engine Oil Level Accurate Only When Vehicle Is Level** message appears in the multifunction display.

The measurement takes a few seconds. You will see a message in the multifunction display. The messages are explained in the following chapter.

#### Oil level display messages

| Display messages                                    | Possible causes/consequences and ▶ Solutions   |
|---|--|
| Engine Oil Level OK                                 | The oil level is correct.  |
| Check Engine Oil Level (Add 1 Liter)                | The oil level is too low.<br>▶ Add 1.1 US qt (1.0 liter) of engine oil.  |
| Reduce Engine Oil Level                             | The engine oil level is too high.<br>▶ Have excess engine oil siphoned off.  |
| For Engine Oil Level Ignition Must Be On            | The ignition is switched off.<br>▶ Select key position ② with the Start/Stop button.   |
| Need More Time to Check Engine Oil Level            | The required waiting period was not observed.<br>▶ The engine must be at regular operating temperature. It is only possible to make a correct measurement within the first 4 minutes after the engine has been switched off. |
| Engine Oil Level Not Measurable with Engine Running | The engine is running; oil level measurement is not possible.<br>▶ Switch off the engine.<br>▶ Repeat the measurement. Observe the required waiting period.  |



| Display messages  | Possible causes/consequences and ► Solutions   |
|---|--|
| Engine Oil Level Correct Measurement Only if Vehicle Is on Level Ground | The vehicle is not parked on a level surface.<br>► Park the vehicle on a level surface.  |
| Engine Oil Level Not Measurable   | Oil level measurement with the oil dipstick is possible. The measuring system is malfunctioning.<br>► Visit a qualified specialist workshop. |

### Adding engine oil

#### WARNING

Certain components in the engine compartment, such as the engine, radiator and parts of the exhaust system, can become very hot. Working in the engine compartment poses a risk of injury.

Where possible, let the engine cool down and touch only the components described in the following.

#### WARNING

If engine oil comes into contact with hot components in the engine compartment, it may ignite. There is a risk of fire and injury.

Make sure that engine oil is not spilled next to the filler neck. Let the engine cool down and thoroughly clean the engine oil off the components before starting the engine.

#### Environmental note

When adding oil, take care not to spill any. If oil enters the soil or waterways, it is harmful to the environment.

-  Use only engine oils and oil filters that are approved for vehicles with a service system. A list of the engine oils and oil filters that have been tested and approved in accordance with Mercedes-Benz Specifications for Service Products is available at any authorized Mercedes-Benz Center.

The following cause engine failure or damage to the exhaust system:

- Use of engine oils and oil filters that have not been expressly approved for the service system
- Replacement of engine oil and oil filter after the replacement interval specified by the service system has expired
- Use of engine oil additives

-  Do not add too much oil. If the oil level is above the "max" mark on the dipstick, too much oil has been added. This can lead to damage to the engine or the catalytic converter. Have excess oil siphoned off.

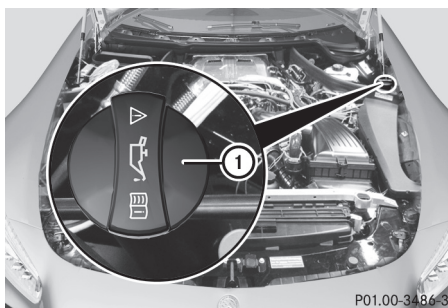

Example: engine oil cap

- Turn cap ① counter-clockwise and remove it.
- Add engine oil.  
If the oil level is at or below the MIN mark on the oil dipstick, add 1.1 US qt (1.0 liter) of engine oil.
- Replace cap ① on the filler neck and turn clockwise.  
Ensure that the cap locks into place securely.
- Check the oil level again with the oil dipstick (► page 227).

Further information on engine oil (► page 280).



### Additional service products

#### Checking coolant level

##### WARNING

Certain components in the engine compartment, such as the engine, radiator and parts of the exhaust system, can become very hot. Working in the engine compartment poses a risk of injury.

Where possible, let the engine cool down and touch only the components described in the following.

##### WARNING

The cooling system is pressurized, particularly when the motor is warm. If you open the cap, you could be scalded if hot coolant sprays out. There is a risk of injury.

Let the engine cool down before you open the cap. Wear gloves and eye protection. Slowly open the cap to relieve pressure.

**!** Before starting your journey, make sure that all engine covers are installed. Otherwise, the engine can be damaged, e.g. through overheating.

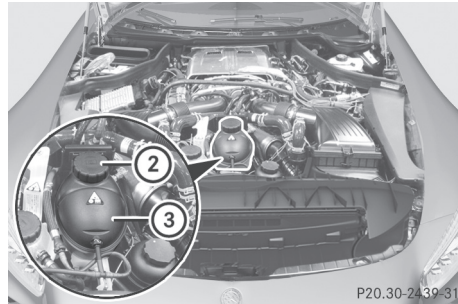
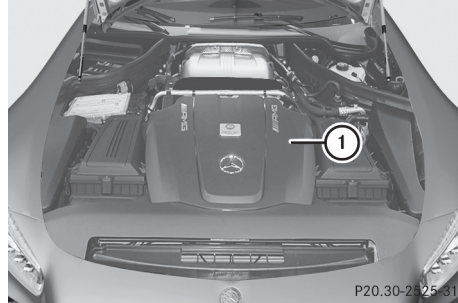

#### Checking the coolant level (example)

- ▶ Park the vehicle on a level surface.  
Only check the coolant level when the vehicle is on a level surface and the engine has cooled down.
- ▶ Select key position **2** with the Start/Stop button.
- ▶ Check the coolant temperature display in the instrument cluster.  
The coolant temperature must be below 158 °F (70 °C).
- ▶ Select key position **0** with the Start/Stop button.
- ▶ Remove the engine cover **1**.
- ▶ Slowly turn cap **2** half a turn counter-clockwise to allow excess pressure to escape.
- ▶ Turn cap **2** further counter-clockwise and remove it.  
If the coolant is at the level of the marker bar in the filler neck when cold, there is enough coolant in coolant expansion tank **3**.  
If the coolant level is approximately 0.6 in (1.5 cm) above the marker bar in the filler neck when warm, there is enough coolant in coolant expansion tank **3**.
- ▶ If necessary, add coolant that has been tested and approved by Mercedes-Benz.

- ▶ Replace cap ② and turn it clockwise as far as it will go.
- ▶ Replace engine cover ①.

For further information on coolant, see (▷ page 281).

### Windshield washer system

#### WARNING

Certain components in the engine compartment, such as the engine, radiator and parts of the exhaust system, can become very hot. Working in the engine compartment poses a risk of injury.

Where possible, let the engine cool down and touch only the components described in the following.

#### WARNING

Windshield washer concentrate could ignite if it comes into contact with hot engine components or the exhaust system. There is a risk of fire and injury.

Make sure that no windshield washer concentrate is spilled next to the filler neck.

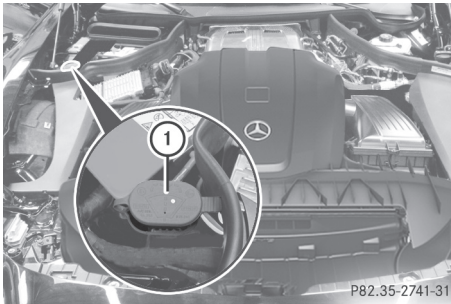

Example

- ▶ **To open:** pull cap ① upwards by the tab.
- ▶ Add the premixed washer fluid.
- ▶ **To close:** press cap ① onto the filler neck until it engages.

If the washer fluid level drops below the recommended minimum of 1 liter, a message appears in the multifunction display prompting you to add washer fluid (▷ page 187).

Further information on windshield washer fluid/antifreeze (▷ page 281).

### ASSYST PLUS

#### Service message

-  If the scheduled service intervals are exceeded, this may result in damage to the vehicle.

You can obtain up-to-date information concerning the servicing of your vehicle from a qualified specialist workshop, e.g. an authorized Mercedes-Benz Center or at <http://www.mbusa.com> (USA only).

The ASSYST PLUS service interval display informs you of the next service due date.

-  The ASSYST PLUS service interval display does not show any information on the engine oil level. Observe the notes on the engine oil level (▷ page 227).

The multifunction display shows a service message for several seconds, e.g.:

- Service A in XX Days
- Service A Due
- Service A Overdue by XX Days

Depending on the operating conditions of the vehicle, the remaining time or distance until the next service due date is displayed.

The letter **A** or **B**, possibly in connection with a number or another letter, shows the type of service. **A** stands for a minor service and **B** for a major service.

You can obtain further information from an authorized Mercedes-Benz Center.

The ASSYST PLUS service interval display does not take into account any periods of time during which the battery is disconnected.

Maintaining the time-dependent service schedule:

- ▶ Note down the service due date displayed in the multifunction display before disconnecting the battery.







or

- ▶ After reconnecting the battery, subtract the battery disconnection periods from the service date shown on the display.

#### Hiding a service message

- ▶ Press the  or  button on the steering wheel.

### Displaying service messages

- ▶ Switch on the ignition.
- ▶ Use  on the steering wheel to call up the list of menus.
- ▶ Press  or  on the steering wheel to select the **Service** menu and confirm with .
- ▶ Press  or  on the steering wheel to select the **ASSYST PLUS** submenu and confirm with .
 

The service due date appears in the multi-function display.

### Information about Service

#### Resetting the ASSYST PLUS service interval display

**!** If the ASSYST PLUS service interval display has been inadvertently reset, this setting can be corrected at a qualified specialist workshop.

Have service work carried out as described in the Maintenance Booklet. This may otherwise lead to increased wear and damage to the major assemblies or the vehicle.

A qualified specialist workshop, e.g. an authorized Mercedes-Benz Center, will reset the ASSYST PLUS service interval display after the service work has been carried out. You can also obtain further information on maintenance work, for example.

#### Special service requirements

The specified maintenance interval takes only the normal operation of the vehicle into account. Under arduous operating conditions or increased load on the vehicle, maintenance work must be carried out more frequently, for example:

- Regular city driving with frequent intermediate stops
- If the vehicle is primarily used to travel short distances
- Use in mountainous terrain or on poor road surfaces
- If the engine is often left idling for long periods
- In racetrack mode

Under these or similar conditions, have, for example, the air filter, engine oil and oil filter replaced or changed more frequently. Under arduous operating conditions, the tires must be checked more often. Further information can be obtained at a qualified specialist workshop, e.g. an authorized Mercedes-Benz Center.

**i** In racetrack mode, the vehicle is subject to higher loads, meaning that additional maintenance work is required. If you plan racetrack use, consult a qualified specialist workshop first. Mercedes-Benz recommends that you use an authorized Mercedes-Benz Center for this purpose.

### Driving abroad

An extensive Mercedes-Benz Service network is also available in other countries. You can obtain further information from any authorized Mercedes-Benz Center.

### Care

#### General notes

##### Environmental note

Dispose of empty packaging and cleaning cloths in an environmentally responsible manner.

**!** For cleaning your vehicle, do not use any of the following:

- dry, rough or hard cloths
- abrasive cleaning agents
- solvents
- cleaning agents containing solvents

Do not scrub.

Do not touch the surfaces or protective films with hard objects, e.g. a ring or ice scraper. You could otherwise scratch or damage the surfaces and protective film.

**!** Do not park your vehicle for a long period of time directly after cleaning, particularly after cleaning the wheel rim with wheel cleaner. Wheel cleaner can lead to the increased corrosion of the brake discs and pads. Therefore, drive for a few minutes after cleaning. By heating up the brakes, the brake discs and pads dry. The vehicle can then be parked for a long period of time.

Regular care of your vehicle is a condition for retaining the quality in the long term.

Use care products and cleaning agents recommended and approved by Mercedes-Benz.

## Washing the vehicle and cleaning the paintwork

### Automatic car wash

#### WARNING

Braking efficiency is reduced after washing the vehicle. There is a risk of an accident.

After the vehicle has been washed, brake carefully while paying attention to the traffic conditions until full braking power is restored.

- !** Never clean your vehicle in a Touchless Automatic Car Wash as these use special cleaning agents. These cleaning agents can damage the paintwork or plastic parts.
- If you have your vehicle cleaned in a high-pressure automatic car wash, small amounts of water may enter the vehicle.

- !** If the SmartKey is within the rear detection range of KEYLESS-GO, the following situations, for example, could lead to the unintentional opening of the tailgate:

- using a car wash
- using a power washer

Make sure that the SmartKey is at least 10 ft (3 m) away from the vehicle.

- !** Make sure that:
  - the side windows are fully closed.
  - the blower for the ventilation/heating is switched off.
  - the windshield wiper switch is at position **0**.
  - the rear view camera is switched off.

The vehicle may otherwise be damaged.

- !** When washing your vehicle in a tow-through car wash, use the SmartKey instead of the Start/Stop button.

Start the engine using the SmartKey. Set the transmission to **N** with the E-SELECT selector lever. Switch the engine off again with the SmartKey by turning the SmartKey to position **2**. Make sure that you then leave the SmartKey in position **2**. You may otherwise dam-

age the vehicle, the transmission or the car wash.

Check the transmission position in the instrument cluster.

- !** Before switching off the engine, set the transmission to **N** using the E-SELECT selector lever. If you open the driver's door or front-passenger door, the transmission remains in this position for up to 30 minutes if the SmartKey is in the ignition, even if the engine is switched off. If you do not shift the transmission to **N** using the E-SELECT selector lever beforehand, it shifts automatically to parking position **P** and locks the wheels if the driver's door or front-passenger door is opened and the engine is switched off. This may damage the vehicle, the transmission or the car wash.

You can wash the vehicle in an automatic car wash from the very start.

If the vehicle is very dirty, pre-wash it before cleaning it in an automatic car wash.

After using an automatic car wash, wipe off wax from the windshield and the wiper blades. This will prevent smears and reduce wiping noises caused by residue on the windshield.

### Washing by hand

In some countries, washing by hand is only allowed at specially equipped washing bays. Observe the legal requirements in each country.

- ▶ Do not use hot water and do not wash the vehicle in direct sunlight.
- ▶ Use a soft sponge to clean.
- ▶ Use a mild cleaning agent, such as a car shampoo approved by Mercedes-Benz.
- ▶ Thoroughly hose down the vehicle with a gentle jet of water.
- ▶ Do not point the water jet directly towards the air inlet.
- ▶ Use plenty of water and rinse out the sponge frequently.
- ▶ Rinse the vehicle with clean water and dry thoroughly with a chamois.
- ▶ Do not let the cleaning agent dry on the paintwork.

Carefully remove all deposits of road salt as soon as possible when driving in winter.

## Power washers

### WARNING

The water jet from a circular jet nozzle (dirt blasters) can cause invisible exterior damage to the tires or chassis components. Components damaged in this way may fail unexpectedly. There is a risk of an accident.

Do not use power washers with circular jet nozzles to clean the vehicle. Have damaged tires or chassis components replaced immediately.

- !** Always maintain a distance of at least 11.8 in (30 cm) between the vehicle and the power washer nozzle. Information about the correct distance is available from the equipment manufacturer.

Move the power washer nozzle around when cleaning your vehicle.

Do not aim directly at any of the following:

- Tires
- Door gaps, roof gaps, joints, etc.
- Electrical components
- Battery
- Connectors
- Lamps
- Seals
- Trim
- Ventilation slots

Damaged seals or electrical components can lead to leaks or failures.

- !** Vehicles with decorative film: parts of your vehicle are covered with a decorative film. Maintain a distance of at least 27.5 in (70 cm) between the parts of the vehicle covered with the film and the nozzle of the high pressure cleaner.

Information about the correct distance is available from the equipment manufacturer.

Move the power washer nozzle around when cleaning your vehicle.

- !** If the SmartKey is within the rear detection range of KEYLESS-GO, the following situations, for example, could lead to the unintentional opening of the tailgate:

- using a car wash
- using a power washer

Make sure that the SmartKey is at least 10 ft (3 m) away from the vehicle.

## Cleaning the paintwork

- !** Do not affix:

- stickers
- films
- magnetic plates or similar items to painted surfaces. You could otherwise damage the paintwork.

Scratches, corrosive deposits, areas affected by corrosion and damage caused by inadequate care cannot always be completely repaired. In such cases, visit a qualified specialist workshop.

- ▶ Remove dirt immediately, where possible, while avoiding rubbing too hard.
- ▶ Soak insect remains with insect remover and rinse off the treated areas afterwards.
- ▶ Soak bird droppings with water and rinse off the treated areas afterwards.
- ▶ Remove coolant, brake fluid, tree resin, oils, fuels and greases by rubbing gently with a cloth soaked in petroleum ether or lighter fluid.
- ▶ Use tar remover to remove tar stains.
- ▶ Use silicone remover to remove wax.

If water no longer forms "beads" on the paint surface, use the paint care products recommended and approved by Mercedes-Benz. This is the case approximately every three to five months, depending on the climate conditions and the care product used.

If dirt has penetrated the paint surface or if the paint has become dull, the paint cleaner recommended and approved by Mercedes-Benz should be used.

Do not use these care products in the sun or on the hood while the hood is hot.

- ▶ Use a suitable touch-up stick, e.g. MB Touch-Up Stick, to repair slight damage to the paintwork quickly and provisionally.

## Matte finish care

- !** Never polish the vehicle or the light alloy wheels. Polishing causes the finish to shine.

**!** The following may cause the paint to become shiny and thus reduce the matte effect:

- strong rubbing of the paintwork with unsuitable materials
- frequent use of automatic car washes
- washing the vehicle in direct sunlight

**!** Never use paint cleaner, buffing or polishing products, or gloss preserver, e.g. wax, for the purpose of paintwork care. These products are only suitable for high-gloss surfaces. Their use on vehicles with matte paintwork leads to considerable surface damage or, more specifically, to shiny, spotted areas.

Always have paintwork repairs carried out at a qualified specialist workshop.

**!** Do not use wash programs with a hot wax treatment under any circumstances.

Observe these notes if your vehicle has a clear matte finish. This will help you to avoid damage to the paintwork due to incorrect treatment.

These notes also apply to light alloy wheels with a clear matte finish.

- i** The vehicle should ideally be washed by hand using a soft sponge, car shampoo and plenty of water.
- i** Use only insect remover and car shampoo from the range of recommended and approved Mercedes-Benz care products.

## Cleaning the vehicle parts

### Cleaning the wheels

#### **!** WARNING

The water jet from a circular jet nozzle (dirt blasters) can cause invisible exterior damage to the tires or chassis components. Components damaged in this way may fail unexpectedly. There is a risk of an accident.

Do not use power washers with circular jet nozzles to clean the vehicle. Have damaged tires or chassis components replaced immediately.

**!** Do not use acidic wheel cleaning products to remove brake dust. This could damage wheel bolts and brake components.

**!** Do not park your vehicle for a long period of time directly after cleaning, particularly after cleaning the wheel rim with wheel cleaner. Wheel cleaner can lead to the increased corrosion of the brake discs and pads. Therefore, drive for a few minutes after cleaning. By heating up the brakes, the brake discs and pads dry. The vehicle can then be parked for a long period of time.

### Cleaning the windows

#### **!** WARNING

You could become trapped by the windshield wipers if they start moving while cleaning the windshield or wiper blades. There is a risk of injury.

Always switch off the windshield wipers and the ignition before cleaning the windshield or wiper blades.

**!** Do not use dry cloths, abrasive products, solvents or cleaning agents containing solvents to clean the inside of the windows. Do not touch the insides of the windows with hard objects, e.g. an ice scraper or ring. There is otherwise a risk of damaging the windows.

**!** Clean the water drainage channels of the windshield and the rear window at regular intervals. Deposits such as leaves, petals and pollen may under certain circumstances prevent water from draining away. This can lead to corrosion damage and damage to electronic components.

► Clean the inside and outside of the windows with a damp cloth and a cleaning product that is recommended and approved by Mercedes-Benz.

### Cleaning wiper blades

#### **!** WARNING

You could become trapped by the windshield wipers if they start moving while cleaning the windshield or wiper blades. There is a risk of injury.

Always switch off the windshield wipers and the ignition before cleaning the windshield or wiper blades.



- ❗ Do not pull the wiper blade. Otherwise, the wiper blade could be damaged.
- ❗ Do not clean wiper blades too often and do not rub them too hard. Otherwise, the graphite coating could be damaged. This could cause wiper noise.
- ❗ Hold the wiper arm securely when folding back. The windshield could be damaged if the wiper arm smacks against it suddenly.
- ▶ Fold the windshield wiper arms away from the windshield.
- ▶ Carefully clean the wiper blades with a damp cloth.
- ▶ Fold the windshield wiper arms back again before switching on the ignition.

### Cleaning the exterior lighting

- ❗ Only use cleaning agents or cleaning cloths which are suitable for plastic light lenses. Unsuitable cleaning agents or cleaning cloths could scratch or damage the plastic light lenses.
- ▶ Clean the plastic lenses of the exterior lighting using a wet sponge and a mild cleaning agent, e.g. Mercedes-Benz car shampoo or cleaning cloths.

### Cleaning the mirror turn signals

- ❗ Only use cleaning agents or cleaning cloths that are suitable for plastic lenses. Unsuitable cleaning agents or cleaning cloths could scratch or damage the plastic lenses of the mirror turn signals.
- ▶ Clean the plastic lenses of the mirror turn signals in the exterior mirror housing using a wet sponge and mild cleaning agent, e.g. Mercedes-Benz car shampoo or cleaning cloths.

### Cleaning the sensors

- ❗ If you clean the sensors with a power washer, make sure that you keep a distance of at least 11.8 in (30 cm) between the vehicle and the power washer nozzle. Information about the correct distance is available from the equipment manufacturer.

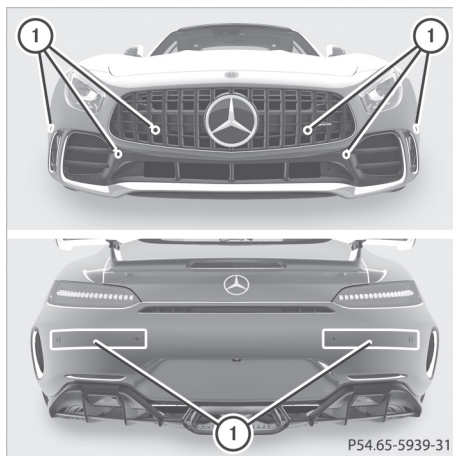

- ▶ Clean sensors ① of the driving systems with water, car shampoo and a soft cloth.

### Cleaning the rear view camera

- ❗ Do not clean the camera lens and the area around the rear view camera with a power washer.

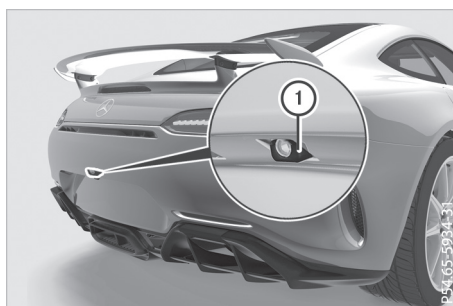

- ▶ Use clear water and a soft cloth to clean camera lens ①.

### Cleaning the exhaust pipe

#### ⚠ WARNING

The exhaust tail pipe and tail pipe trim can become very hot. If you come into contact with these parts of the vehicle, you could burn yourself. There is a risk of injury.

Always be particularly careful around the exhaust tail pipe and the tail pipe trim. Allow



these components to cool down before touching them.

- ❗ Do not clean the exhaust pipe with acid-based cleaning agents, such as bathroom cleaner or wheel cleaner.
- ❗ Vehicles with black exhaust pipes: black chromed screens should not be polished with a chrome polish. They will otherwise lose their black shine. For optimal care, the screens should be rubbed with a lightly oiled cloth after every car wash. Commercially available engine and care oils are suitable for this. For heavier soiling, you can apply a fine paintwork polish with a microfiber cloth. Remove the excess polish residue after polishing.
- ▶ Clean the exhaust pipe with a chrome care product tested and approved by Mercedes-Benz.

Impurities combined with the effects of road grit and corrosive environmental factors may cause flash rust to form on the surface. You can restore the original shine of the exhaust pipe by cleaning it regularly, especially in winter and after washing.

### Interior care

#### Cleaning the display

- ❗ For cleaning, do not use any of the following:
    - alcohol-based thinner or gasoline
    - abrasive cleaning agents
    - commercially-available household cleaning agents
- These may damage the display surface. Do not put pressure on the display surface when cleaning. This could lead to irreparable damage to the display.
- ▶ Before cleaning the display, make sure that it is switched off and has cooled down.
  - ▶ Clean the display surface using a commercially available microfiber cloth and TFT/LCD display cleaner.
  - ▶ Dry the display surface using a dry microfiber cloth.

#### Cleaning the plastic trim

##### ⚠ WARNING

Care products and cleaning agents containing solvents cause surfaces in the cockpit to become porous. As a result, plastic parts may come loose in the event of air bag deployment. There is a risk of injury.

Do not use any care products and cleaning agents to clean the cockpit.

- ❗ Never attach the following to plastic surfaces:
  - stickers
  - films
  - perfume oil container or similar
 You could otherwise damage the plastic.
- ❗ Do not allow cosmetics, insect repellent or sunscreen to come into contact with the plastic trim. This maintains the high-quality look of the surfaces.
- ▶ Wipe the plastic trim with a damp, lint-free cloth, e.g. a microfiber cloth.
- ▶ **Heavy soiling:** use care and cleaning products recommended and approved by Mercedes-Benz. The surface may change color temporarily. Wait until the surface is dry again.

#### Cleaning the steering wheel and gear or selector lever

- ▶ Thoroughly wipe with a damp cloth or use leather care agents that have been recommended and approved by Mercedes-Benz.

#### Cleaning the trim elements

- ❗ Do not use solvent-based cleaning agents such as tar remover, wheel cleaners, polishes or waxes. There is otherwise a risk of damaging the surface.
- ❗ Do not use chrome polish on trim pieces. The trim pieces have a chrome look but are mostly made of anodized aluminum and can lose their shine if chrome polish is used. Use a damp, lint-free cloth instead when cleaning the trim pieces. If the chrome-plated trim pieces are very dirty, you can use a chrome polish. If you are

unsure as to whether the trim pieces are chrome-plated or not, consult an authorized Mercedes-Benz Center.

- ▶ Wipe the trim elements with a damp, lint-free cloth, e.g. a microfiber cloth.
- ▶ **Heavy soiling:** use care and cleaning products recommended and approved by Mercedes-Benz.

### Cleaning the seat covers

#### General notes

❗ Do not use a microfiber cloth to clean covers made out of real leather, artificial leather or DINAMICA. If used often, these can damage the cover.

i Note that regular care is essential to ensure that the appearance and comfort of the covers is retained over time.

#### Genuine leather seat covers

❗ To retain the natural appearance of the leather, observe the following cleaning instructions:

- Clean genuine leather covers carefully with a damp cloth and then wipe the covers down with a dry cloth.
- Make sure that the leather does not become soaked. It may otherwise become rough and cracked.
- Only use leather care agents that have been tested and approved by Mercedes-Benz. You can obtain these from a qualified specialist workshop.

Leather is a natural product.

It exhibits natural surface characteristics, for example:

- differences in the texture
- marks caused by growth and injury
- slight nuances of color

These are characteristics of leather and not material defects.

### Seat covers of other materials

❗ Observe the following when cleaning:

- clean artificial leather covers with a cloth moistened with a solution containing 1% detergent (e.g. dish washing liquid).
- clean cloth covers with a microfiber cloth moistened with a solution containing 1% detergent (e.g. dish washing liquid). Rub carefully and always wipe entire seat sections to avoid leaving visible lines. Leave the seat to dry afterwards. Cleaning results depend on the type of dirt and how long it has been there.
- clean DINAMICA covers with a damp cloth. Make sure that you wipe entire seat sections to avoid leaving visible lines.

### Cleaning the seat belts

#### ⚠ WARNING

Seat belts can become severely weakened if bleached or dyed. This could cause the seat belts to tear or fail, for instance, in the event of an accident. This poses an increased risk of injury or fatal injury.

Never bleach or dye the seat belts.

- ❗ Do not clean the seat belts using chemical cleaning agents. Do not dry the seat belts by heating at temperatures above 176 °F (80 °C) or in direct sunlight.
- ▶ Use clean, lukewarm water and soap solution.

### Cleaning the headliner and carpets

- ▶ **Headliner:** if it is very dirty, use a soft brush or dry shampoo.
- ▶ **Carpets:** use the carpet and textile cleaning agents recommended and approved by Mercedes-Benz.

## Where will I find...?

## Reflective safety jacket

## Removing/replacing the reflective safety jacket

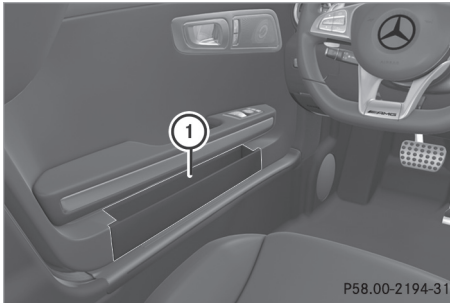

The reflective safety jackets are located in front door stowage compartments ①.

- ▶ **To remove:** pull out the safety jacket bag containing the reflective safety jacket.
- ▶ Open the safety jacket bag and pull out the reflective safety jacket.
- ▶ **To stow:** fold the reflective safety jacket, roll it up and stow it in safety jacket bag .
- ▶ Replace the safety jacket bag into stowage compartment ①.

**i** Remove a new reflective safety jacket from its packaging material before sliding it into the stowage compartment. The packaging material may otherwise cause it to slip out or make removing it difficult.

Observe the legal requirements in each country.

## Information on reflective safety jackets

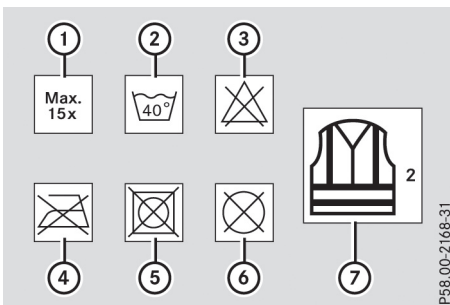

- ① Maximum number of washes
- ② Maximum wash temperature
- ③ Do not bleach

- ④ Do not iron
- ⑤ Do not use a laundry dryer
- ⑥ Do not dry-clean
- ⑦ This is a class 2 jacket

- The reflective safety jackets meet the requirements defined by the legal standard only:
  - if the correct size is used
  - if the reflective safety jackets are correctly fastened
- Before use, ensure that the reflective safety jackets are clean and intact. The special properties may otherwise be compromised.
- The reflective safety jackets should be stored in their original packaging in a dry place away from sources of heat and light.
- The maximum number of washes specified is not the only factor influencing the life span of the reflective safety jackets. Their life span also depends on use, care, storage, etc.
- The reflective safety jackets should be disposed of and replaced with new ones:
  - after 15 washes, and/or
  - if the reflective strips have become scratched, and/or
  - if the backing material and/or reflective strips have become soiled and cannot be cleaned off, and/or
  - if the fluorescence has faded e.g. due to the effects of sunlight
- Dispose of reflective safety jackets in an environmentally responsible manner. To do so, contact your local waste disposal company.

## Vehicle tool kit

## General notes

Apart from certain country-specific variations, the vehicles are not equipped with a tire-change tool kit. If the vehicle is equipped with tire-changing tools, these are located in the left-hand stowage compartment behind the service flap in the cargo compartment. Some tools for changing a wheel are specific to the vehicle. For more information on which tire changing tools are required and approved to perform a wheel change on your vehicle, consult a qualified specialist workshop.

Tools required for changing a wheel may include, for example:

- Jack
- Wheel chock
- Lug wrench
- Ratchet wrench
- Alignment bolt

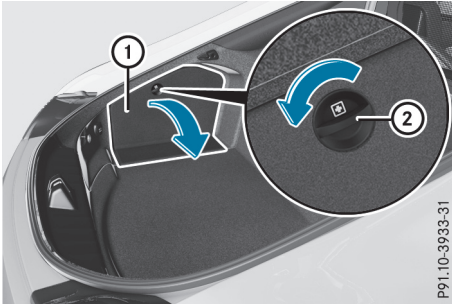

The vehicle tool kit is located in the left-hand storage compartment behind service flap ① in the cargo compartment.

- ▶ Open the tailgate.
- ▶ Turn fastener ② on the service flap to the left.
- ▶ Open service flap ①.

#### Vehicles with a TIREFIT kit

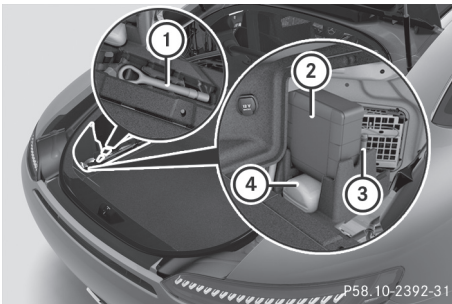

- ① Towing eye
- ② Tire inflation compressor
- ③ Alignment bolt
- ④ Tire sealant filler bottle

- ▶ Use the TIREFIT kit (▷ page 241).

#### Vehicles with a tire-change tool kit

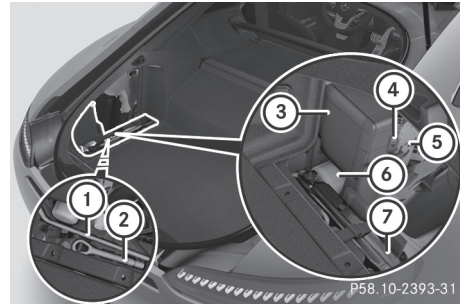

- ① Lug wrench
- ② Towing eye
- ③ Tire inflation compressor
- ④ Alignment bolt
- ⑤ Folding wheel chock
- ⑥ Tire sealant filler bottle
- ⑦ Jack

- ▶ Use the TIREFIT kit (▷ page 241).

**i** Example: equipment and country-specific variations possible.

#### Flat tire

##### Preparing the vehicle

Your vehicle may be equipped with:

- a TIREFIT kit (▷ page 239)

Information on changing and mounting wheels (▷ page 270).

- ▶ Stop the vehicle on solid, non-slippery and level ground, as far away as possible from traffic.
- ▶ Switch on the hazard warning lamps.
- ▶ Secure the vehicle against rolling away (▷ page 118).
- ▶ If possible, bring the front wheels into the straight-ahead position.
- ▶ Switch off the engine.

- ▶ **With KEYLESS-GO start function or vehicles with KEYLESS-GO:** open the driver's door.

The vehicle electronics are now in key position **[0]**. This is the same as the key having been removed.

or

- ▶ Remove the SmartKey from the ignition lock.
- ▶ Make sure that the passengers are not endangered as they do so. Make sure that no one is near the danger area while a wheel is being changed. Anyone who is not directly assisting in the wheel change should, for example, stand behind the barrier.
- ▶ Get out of the vehicle. Pay attention to traffic conditions when doing so.
- ▶ Close the driver's door.

### TIREFIT kit

#### Important safety notes

TIREFIT is a tire sealant.

You can use TIREFIT to seal punctures of up to 0.16 in (4 mm), particularly those in the tire tread. You can use TIREFIT at outside temperatures down to -4 °F (-20 °C).

#### WARNING

In the following situations, the tire sealant is unable to provide sufficient breakdown assistance, as it is unable to seal the tire properly:

- there are cuts or punctures in the tire larger than those mentioned above.
- the wheel rim is damaged.
- you have driven at very low tire pressures or on a flat tire.

There is a risk of an accident.

Do not drive the vehicle. Contact a qualified specialist workshop.

#### WARNING

The tire sealant is harmful and causes irritation. It must not come into contact with your skin, eyes or clothing or be swallowed. Do not inhale TIREFIT fumes. Keep tire sealant away from children. There is a risk of injury.

If you come into contact with the tire sealant, observe the following:

- Rinse off the tire sealant from your skin immediately with water.
- If the tire sealant comes into contact with your eyes, immediately rinse them thoroughly with clean water.
- If tire sealant is swallowed, immediately rinse your mouth out thoroughly and drink plenty of water. Do not induce vomiting, and seek medical attention immediately.
- Immediately change out of clothing which has come into contact with tire sealant.
- If an allergic reaction occurs, seek medical attention immediately.

- ⚠ Do not operate the tire inflation compressor for longer than ten minutes at a time without a break. It may otherwise overheat.

The tire inflation compressor can be operated again once it has cooled down.

Comply with the manufacturer's safety instructions on the tire inflation compressor label and on the tire sealant bottle.

#### Using the TIREFIT kit

- ▶ Do not remove any foreign objects which have penetrated the tire, e.g. screws or nails.
- ▶ Remove the tire sealant bottle, the accompanying TIREFIT sticker and the tire inflation compressor from the stowage compartment in the cargo compartment (▷ page 239).

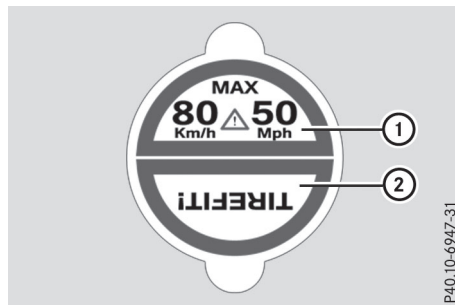

P40.10-6947-31

- ▶ Affix part ① of the TIREFIT sticker to the instrument cluster within the driver's field of vision.
- ▶ Affix part ② of the TIREFIT sticker near the valve on the wheel with the defective tire.

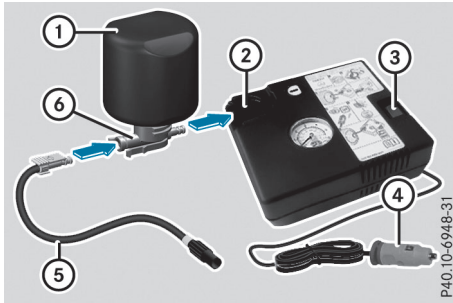

- ① Tire sealant filler bottle
- ② Recess
- ③ On/off switch
- ④ Connector
- ⑤ Hose
- ⑥ Flange

- ▶ Pull connector ④ with cable and hose ⑤ out of the tire inflation compressor housing.
- ▶ Push connector on hose ⑤ into flange ⑥ on tire sealant bottle ① until the connector engages.
- ▶ Place tire sealant bottle ① head down into recess ② of the tire inflation compressor.

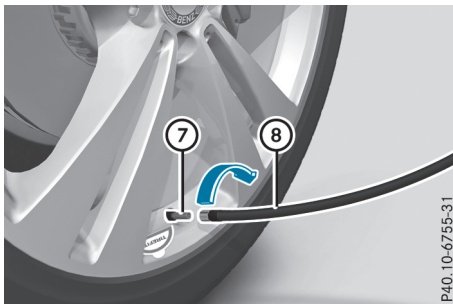

- ▶ Remove the cap from valve ⑦ on the faulty tire.
- ▶ Screw filler hose ⑧ onto valve ⑦.

- ▶ Insert plug ④ into cigarette lighter socket (▷ page 213) or into another 12 V socket in your vehicle (▷ page 213).
- ▶ Switch on the ignition with the Start/Stop button.

or

- ▶ Turn the SmartKey to position 1 in the ignition lock (▷ page 102).
- ▶ Press on and off switch ③ on the tire inflation compressor. The tire inflation compressor is switched on. The tire is inflated.

First, tire sealant is pumped into the tire. The pressure may briefly rise to approximately 500 kPa (5 bar/73 psi).

**Do not switch off the tire inflation compressor during this phase.**

- ▶ Let the tire inflation compressor run for a maximum of ten minutes. The tire should then have attained a pressure of at least 180 kPa (1.8 bar/26 psi).

If a pressure of 180 kPa (1.8 bar/26 psi) has been attained after five minutes, see "Tire pressure reached" (▷ page 243).

If a tire pressure of 180 kPa (1.8 bar/26 psi) has not been attained after five minutes, see "Tire pressure not reached" (▷ page 242).

If tire sealant has escaped, clean it off affected areas as quickly as possible. Use plain water if possible.

If your clothes are soiled with tire sealant, have them cleaned with perchloroethylene at a dry cleaner as soon as possible.

### Tire pressure not reached

If a pressure of 180 kPa (1.8 bar/26 psi) has not been attained after five minutes:

- ▶ Switch off the tire inflation compressor.
- ▶ Unscrew the filler hose from the valve of the faulty tire. Tire sealant may escape when the filler hose is unscrewed.
- ▶ Very slowly drive forwards or reverse approximately 30 ft (10 m).
- ▶ Pump up the tire again.

After a maximum of ten minutes, the tire pressure must be at least 180 kPa (1.8 bar/26 psi).



**⚠ WARNING**

If the required tire pressure is not reached after the specified time, the tire is too badly damaged. The tire sealant cannot repair the tire in this instance. Damaged tires and a tire pressure that is too low can significantly impair the vehicle's braking and driving characteristics. There is a risk of accident.

Do not continue driving. Contact a qualified specialist workshop.

**Tire pressure reached****⚠ WARNING**

A tire temporarily sealed with tire sealant impairs the driving characteristics and is not suitable for higher speeds. There is a risk of accident.

You should therefore adapt your driving style accordingly and drive carefully. Do not exceed the specified maximum speed with a tire that has been repaired using tire sealant.

The maximum permissible speed for a tire sealed with tire sealant is 50 mph (80 km/h). The upper part of the TIREFIT sticker must be affixed to the instrument cluster in the driver's field of vision.

**!** Residue from the tire sealant may come out of the filler hose after use. This could cause stains.

Therefore, place the filler hose in the plastic bag which contained the TIREFIT kit.

**♻ Environmental note**

Have the used tire sealant bottle disposed of professionally, e.g. at a qualified specialist workshop.

If a tire pressure of 180 kPa (1.8 bar/26 psi) has been attained after five minutes:

- ▶ Switch off the tire inflation compressor.
- ▶ Unscrew the filler hose from the valve of the faulty tire.  
Tire sealant may escape when the filler hose is unscrewed.
- ▶ Stow the tire sealant bottle and the tire inflation compressor.

**▶ Pull away immediately.**

- ▶ Stop after driving for approximately ten minutes and check the tire pressure with the tire inflation compressor.  
The tire pressure must now be at least 130 kPa (1.3 bar/19 psi).

**⚠ WARNING**

If the required tire pressure is not reached after driving for a short period, the tire is too badly damaged. The tire sealant cannot repair the tire in this instance. Damaged tires and a tire pressure that is too low can significantly impair the vehicle's braking and driving characteristics. There is a risk of accident.

Do not continue driving. Contact a qualified specialist workshop.

**i** In cases such as the one mentioned above, contact an authorized Mercedes-Benz Center. Or call 1-800-FOR-MERCEDES (in the USA) or 1-800-387-0100 (in Canada).

- ▶ Correct the tire pressure if it is still at least 130 kPa (1.3 bar/19 psi). See the Tire and Loading Information placard on the driver's side B-pillar or the tire pressure table in the fuel filler flap for values.
- ▶ **To increase the tire pressure:** switch on the tire inflation compressor.

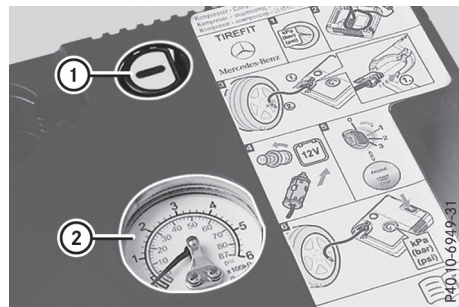

- ▶ **To reduce the tire pressure:** depress pressure release button ① next to pressure gauge ②.
- ▶ When the tire pressure is correct, unscrew the filler hose from the valve of the sealed tire. Tire sealant may escape when the filler hose is unscrewed.
- ▶ Screw the valve cap onto the tire valve of the sealed tire.



- ▶ Pull the tire sealant bottle out of the tire inflation compressor.  
The filler hose remains attached to the tire sealant bottle.
- ▶ Drive to the nearest qualified specialist workshop and have the tire changed there.
- ▶ Have the tire sealant bottle replaced as soon as possible at a qualified specialist workshop.
- ▶ Have the tire sealant bottle replaced every four years at a qualified specialist workshop.

### Battery (vehicle)

#### Important safety notes

Special tools and expert knowledge are required when working on the battery, e.g. removal and installation. You should therefore have all work involving the battery carried out at a qualified specialist workshop.

#### WARNING

Work carried out incorrectly on the battery can lead, for example, to a short circuit and thus damage the vehicle electronics. This can lead to function restrictions applying to safety-relevant systems, e.g. the lighting system, the ABS (anti-lock braking system) or the ESP® (Electronic Stability Program). The operating safety of your vehicle may be restricted.

You could lose control of the vehicle, for example:

- when braking
- in the event of abrupt steering maneuvers and/or when the vehicle's speed is not adapted to the road conditions

There is a risk of an accident.

In the event of a short circuit or a similar incident, contact a qualified specialist workshop immediately. Do not drive any further. You should have all work involving the battery carried out at a qualified specialist workshop.

For further information about ABS (▷ page 56) and ESP® (▷ page 59).

#### Environmental note



Batteries contain dangerous substances. It is against the law to dispose of them with the household rubbish. They must be collected separately and recycled to protect the environment.



Dispose of batteries in an environmentally friendly manner. Take discharged batteries to a qualified specialist workshop or a special collection point for used batteries.

-  Have the battery regularly checked at a qualified specialist workshop.  
For more information, please contact a qualified specialist workshop.

-  Always have work on batteries carried out at a qualified specialist workshop.  
Should it, in exceptional circumstances, be absolutely necessary to disconnect the 12-volt battery yourself, please observe the following:

- Secure the vehicle to prevent it from rolling away.
- Switch off the ignition.
- Disconnect the negative terminal first and then the positive terminal.

The transmission is locked in position **P** after disconnecting the battery.

After the work has been done, install the battery and replace the cover of the positive terminal clamp firmly.

Comply with safety precautions and take protective measures when handling batteries.



Risk of explosion.



Fire, open flames and smoking are prohibited when handling the battery. Avoid creating sparks.



The electrolyte of the battery is corrosive. Avoid contact with skin, eyes or clothing.

Wear suitable protective clothing, especially gloves, apron and face-guard.

Immediately rinse electrolyte splashes off with clean water. Contact a physician if necessary.



Wear eye protection.



Keep children away.



Observe this Operator's Manual.

For safety reasons, Mercedes-Benz recommends that you only use batteries which have been tested and approved for your vehicle by Mercedes-Benz. These batteries provide increased impact protection to prevent vehicle occupants from suffering acid burns should the battery be damaged in the event of an accident. In order for the battery to achieve the maximum possible service life, it must always be sufficiently charged.

Like other batteries, the vehicle battery may discharge over time if you do not use the vehicle. In this case, have the battery disconnected at a qualified specialist workshop. You can also charge the battery with a special charger recommended by Mercedes-Benz. Contact a qualified specialist workshop for further information.

Have the battery condition of charge checked more frequently if you use the vehicle mainly for short trips or if you leave it standing idle for a lengthy period. Consult a qualified specialist workshop if you wish to leave your vehicle parked for a long period of time.

When you use the SmartKey in the ignition and you park the car, remove the SmartKey if you do

not require any electrical consumers. The vehicle will then use very little energy, thus conserving battery power.

If the power supply has been interrupted, e.g. if you reconnect the battery, you will have to:

- reset the function for automatically folding the exterior mirrors in/out by folding the mirrors out once (▷ page 84)
- reset the side windows, see (▷ page 75)

### Charging the battery

**!** Only use battery chargers with a maximum charging voltage of 14.4 V.

**!** Only charge the battery using the jump-starting connection point.

The jump-starting connection point is in the engine compartment (▷ page 245).

► Open the hood.

► Connect the battery charger to the positive terminal and ground point in the same order as when connecting the donor battery in the jump-starting procedure (▷ page 245).

Keep away from fire and open flames. Do not lean over a battery. Never charge the battery if it is still installed in the vehicle, unless you use a battery charger which has been tested and approved by Mercedes-Benz. A battery charger unit specially adapted for Mercedes-Benz vehicles and tested and approved by Mercedes-Benz is available as an accessory. It permits the charging of the battery in its installed position. Contact an authorized Mercedes-Benz Center for further information and availability. Read the battery charger's operating instructions before charging the battery.

Do not charge a battery which has been removed at low temperatures with a battery charger. Allow the battery to warm up gently first, if necessary. Otherwise, the service life can be shortened and the starting characteristics impaired, especially at low temperatures.

## Jump-starting

For the jump-starting procedure, use only the jump-starting connection point in the engine compartment, consisting of a positive terminal and a ground point.

**!** Avoid repeated and lengthy starting attempts. Otherwise, the catalytic converter could be damaged by the non-combusted fuel.

Do not start the vehicle using a rapid charging device. If your vehicle's battery is discharged, the engine can be jump-started from another vehicle or from a second battery using jumper cables. Observe the following points:

- The battery is not accessible in all vehicles. If the other vehicle's battery is not accessible, jump-start the vehicle using a second battery or a jump-starting device.
- You may only jump-start the vehicle when the engine and exhaust system are cold.
- Only jump-start from batteries with a 12 V voltage rating.
- Only use jumper cables which have a sufficient cross-section and insulated terminal clamps.
- If the battery is fully discharged, leave the battery that is being used to jump-start connected for a few minutes before attempting to start. This charges the battery slightly.
- Make sure that the two vehicles do not touch.

Make sure that:

- The jumper cables are not damaged.
- Bare parts of the terminal clamp do not come into contact with other metal parts while the jumper cables are connected to the battery.
- The jumper cables cannot come into contact with parts which can move when the engine is running, such as the V-belt pulley or the fan.
- ▶ Secure the vehicle by applying the electric parking brake.
- ▶ Shift the transmission to position **P**.
- ▶ Make sure that the ignition is switched off. All indicator lamps in the instrument cluster must be off. When using the SmartKey, turn the SmartKey to position **0** in the ignition lock and remove it (> page 102).
- ▶ Switch off all electrical consumers, e.g. rear window defroster, lighting, etc.
- ▶ Open the hood.

**Vehicles with carbon engine cover:**

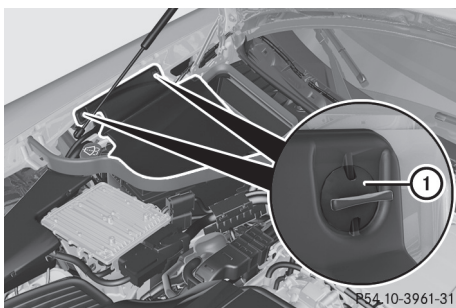

- ▶ Turn fasteners ① one ¼ turn and remove.
- ▶ Remove cover.

**All vehicles:**

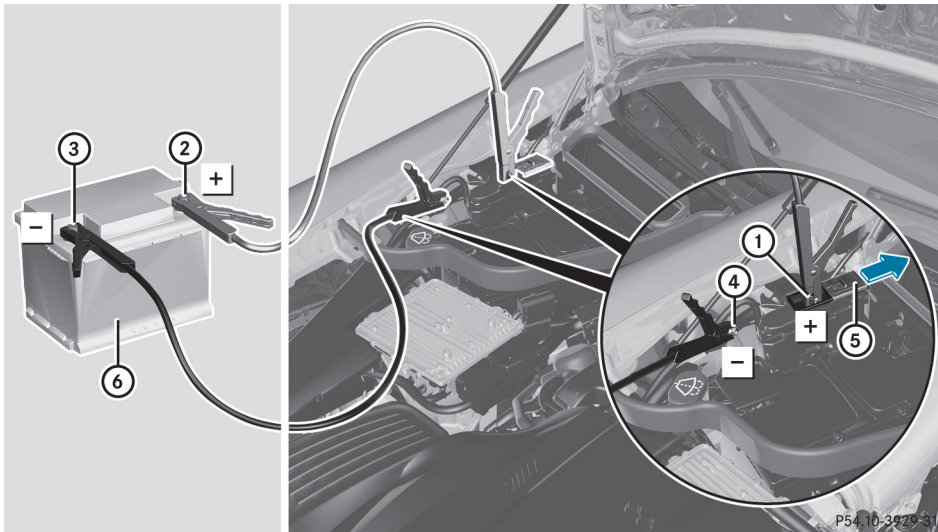

Position number ⑥ identifies the charged battery of the other vehicle or an equivalent jump-starting device.

- ▶ Slide cover ⑤ of positive terminal ① in the direction of the arrow.
- ▶ Connect positive terminal ① on your vehicle to positive terminal ② of donor battery ⑥ using the jumper cable. Always begin with positive terminal ① on your own vehicle first.
- ▶ Start the engine of the donor vehicle and run it at idling speed.
- ▶ Connect negative terminal ③ of donor battery ⑥ to ground point ④ of your vehicle using the jumper cable, connecting the jumper cable to donor battery ⑥ first.
- ▶ Start the engine.
- ▶ Before disconnecting the jumper cables, let the engine run for several minutes.
- ▶ First, remove the jumper cables from ground point ④ and negative terminal ③, then from positive clamp ① and positive terminal ②. Begin each time at the contacts on your own vehicle first.
- ▶ After removing the jumper cables, close cover ⑤ of positive terminal ①.

#### Vehicles with carbon engine cover:

- ▶ Replace the jump-starting connection point cover. Make sure all mountings for the fasteners are positioned precisely behind the corresponding recesses in the cover.
- ▶ Press the fasteners into the mountings. Turn the fasteners by  $\frac{1}{4}$  of a turn to engage.

#### All vehicles:

- ▶ Have the battery checked at a qualified specialist workshop.

Jump-starting is not considered to be a normal operating condition.

- ▶ **i** Jumper cables and further information regarding jump-starting can be obtained at any qualified specialist workshop.

## Towing and tow-starting

### Important safety notes

#### WARNING

The rear axle locks when:

- the engine is not running
- the engine stalls while the vehicle is being towed
- there is a malfunction in the power supply or the vehicle's electrical system

There is a risk of an accident.

In the event of a breakdown, you should always have the vehicle transported.

#### WARNING

If the brake system or power steering is malfunctioning and your vehicle is then towed away, significantly more effort may be required to steer and brake than is normally required. There is a risk of an accident.

In such cases, use a tow bar. Before towing, make sure that the steering moves freely.

#### WARNING

When towing or tow-starting another vehicle and its weight is greater than the permissible gross weight of your vehicle, the:

- the towing eye could detach itself
- the vehicle/trailer combination could roll-over.

There is a risk of an accident.

When towing or tow-starting another vehicle, its weight should not be greater than the permissible gross weight of your vehicle.

Details on the permissible gross vehicle weight of your vehicle can be found on the vehicle identification plate (▷ page 276).

-  Use the SmartKey instead of the Start/Stop button when towing the vehicle.

Start the engine and keep it running. The SmartKey is in position **[2]** in the ignition lock. Set the transmission to **[N]** using the E-SELECT selector lever. Make sure that you then leave the SmartKey in position **[2]**.

Check the transmission position in the instrument cluster.

-  Make sure that the electric parking brake is released. If the electric parking brake is faulty, visit a qualified specialist workshop.

-  Secure the tow rope or tow bar to the towing eye only. Otherwise, the vehicle could become damaged.

-  When Active Brake Assist, Distance Pilot DISTRONIC or the HOLD function is activated, the vehicle brakes automatically in certain situations.

To avoid damage to the vehicle, deactivate these systems in the following or similar situations:

- when towing the vehicle
- in the car wash

-  Do not use the towing eyes for recovery purposes as this could damage the vehicle. If in doubt, recover the vehicle with a crane.

-  When towing, pull away slowly and smoothly. If the tractive power is too high, the vehicles could be damaged.

-  Shift the automatic transmission to position **[N]** and do not open the driver's or front-passenger door when towing the vehicle away. Otherwise, the automatic transmission may shift to position **[P]** which can cause damage to both vehicles.

-  Do not tow with sling-type equipment. This could damage the vehicle.

-  The vehicle can be towed a maximum of 30 miles (50km). The towing speed of 30 mph (50 km/h) must not be exceeded.

If the vehicle has to be towed more than 30 miles (50km), the entire vehicle must be raised and transported.

-  Observe the transmission fluid temperature (AMG menu) in the on-board computer when towing. The transmission fluid temperature must not exceed 250 °F (120 °C). If this occurs, you must stop towing immediately.

-  Tow-starting the vehicle is not permitted. The transmission may otherwise be damaged.

Also observe the following notes:

- If the engine does not start, try jump-starting it (▷ page 245). Tow-starting the vehicle is not permitted.
- If it is not possible to jump-start the vehicle, have it transported to the nearest qualified specialist workshop, e.g. an authorized Mercedes-Benz Center.

If the vehicle can no longer be driven because of an accident or breakdown, you have the following options:

- transporting the vehicle  
As a rule, you should have the vehicle transported.
- towing the vehicle with a tow rope or tow bar  
Only tow the vehicle in exceptional cases. The engine must be running if you tow the vehicle with a tow rope or tow bar.

If the vehicle has suffered transmission damage, have it transported on a transporter or trailer. Observe the display messages in the instrument cluster.

The battery must be connected and charged. Otherwise, you:

- will not be able to switch on the ignition with the Start/Stop button
- cannot start the engine
- cannot release the electric parking brake
- cannot shift the automatic transmission to position **N**

Disarm the automatic locking feature before the vehicle is towed (▷ page 70). You could otherwise be locked out when pushing or towing the vehicle.

### Installing/removing the towing eye

#### Installing the towing eye

The bracket for the screw-in towing eye is behind the radiator trim.

- ▶ Remove the towing eye from the vehicle tool kit (▷ page 239).

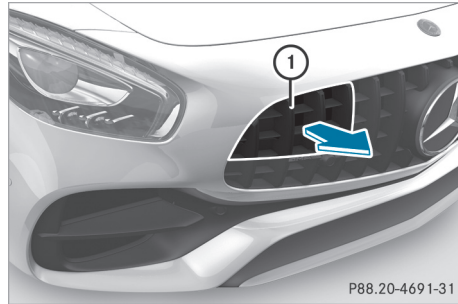

- ▶ Pull out cover ①.
- ▶ Screw in the towing eye clockwise to the stop.

#### Removing the towing eye

- ▶ Unscrew and remove the towing eye.
- ▶ Fully reinsert the cover.
- ▶ Put the towing eye back into the vehicle tool kit.

### Towing a vehicle with both axles on the ground

It is important that you observe the safety instructions when towing away your vehicle (▷ page 248).

The automatic transmission automatically shifts to position **P** when you open the driver's or front-passenger door or when you remove the SmartKey from the ignition lock. In order to ensure that the automatic transmission stays in position **N** when towing away the vehicle, you must observe the following points:

- ▶ Insert the SmartKey into the ignition lock. You must use the SmartKey instead of the Start/Stop button (▷ page 102).
- ▶ Start the engine and leave it running during the entire towing procedure.
- ▶ Depress and hold the brake pedal.
- ▶ Move the transmission to position **N** with the E-SELECT lever.
- ▶ Check the transmission position using the indicator in the multifunction display (▷ page 110).
- ▶ Release the brake pedal.
- ▶ Release the electric parking brake.
- ▶ Switch on the hazard warning lamps (▷ page 89).



In order to signal a change of direction when towing the vehicle with the hazard warning lamps switched on, use the combination switch as usual. In this case, only the indicator lamps for the direction of travel flash. After resetting the combination switch, the hazard warning lamp starts flashing again.

### Transporting the vehicle

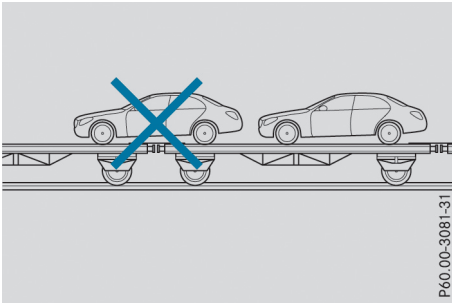

**!** When the vehicle is loaded for transport, the front and rear axles must be stationary and on the same transportation vehicle. Positioning over the connection point of the transport vehicle is not permitted. The drive train may otherwise be damaged.

**!** You may only secure the vehicle by the wheels, not by parts of the vehicle such as axle or steering components. Otherwise, the vehicle could be damaged.

The towing eye can be used to pull the vehicle onto a trailer or transporter for transporting purposes.

- ▶ Insert the SmartKey into the ignition lock. You must use the SmartKey instead of the Start/Stop button (▷ page 102).
- ▶ Start the engine and leave it running during the entire loading operation.
- ▶ Move the transmission to position **N** with the E-SELECT lever.
- ▶ Check the transmission position using the indicator in the multifunction display (▷ page 110).

#### As soon as the vehicle has been loaded:

- ▶ Prevent the vehicle from rolling away by applying the electric parking brake.
- ▶ Shift the automatic transmission to position **P**.

- ▶ Turn the SmartKey to key position **0** in the ignition lock and remove it.
- ▶ Secure the vehicle.

### Tow-starting (emergency engine starting)

**!** Vehicles with automatic transmission must not be tow-started. You could otherwise damage the automatic transmission.

**i** You can find information on "Jump-starting" under (▷ page 245).

## Fuses

### Important safety notes

#### **!** WARNING

If you manipulate or bridge a faulty fuse or if you replace it with a fuse with a higher amperage, the electric cables could be overloaded. This could result in a fire. There is a risk of an accident and injury.

Always replace faulty fuses with the specified new fuses having the correct amperage.

Blown fuses must be replaced with fuses of the same rating, which you can recognize by the color and value. The fuse ratings are listed in the fuse allocation chart.

The fuse allocation chart is on the fuse box in the cargo compartment (▷ page 251).

If a newly inserted fuse also blows, have the cause traced and rectified at a qualified specialist workshop, e.g. an authorized Mercedes-Benz Center.

**!** Only use fuses that have been approved for Mercedes-Benz vehicles and which have the correct fuse rating for the system concerned. Otherwise, components or systems could be damaged.

**!** Make sure that no moisture can enter the fuse box when the cover is open.

**!** When closing the cover, make sure that it is lying correctly on the fuse box. Moisture seeping in or dirt could otherwise impair the operation of the fuses.



The fuses in your vehicle serve to close down faulty circuits. If a fuse blows, all the components on the circuit and their functions stop operating.

### Before changing a fuse

- ▶ Switch off the engine.
- ▶ Switch off all electrical consumers.
- ▶ Open the driver's door.  
The on-board electronics are now in key position **0**. This is the same as the key having been removed.

or, if the SmartKey is inserted in the ignition lock:

- ▶ Remove the SmartKey from the ignition lock.
- ▶ Secure the vehicle against rolling away (> page 118).

All indicator lamps in the instrument cluster must be off.

### Fuse box in the front-passenger footwell

**!** The floor panel must be installed properly, otherwise moisture or dirt could impair the function of the fuses.

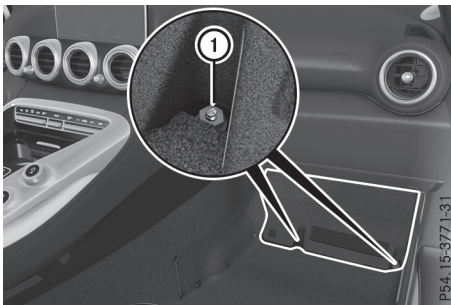

- ▶ Open the front-passenger door.
- ▶ **To open:** remove the carpet over the footrest.
- ▶ Loosen screws **1** on the floor panel using a suitable tool.
- ▶ Remove the floor panel.
- ▶ **To close:** install the floor panel again.
- ▶ Screw in and tighten screws **1**.
- ▶ Put in the carpet and press to secure.

### Fuse box in the cargo compartment

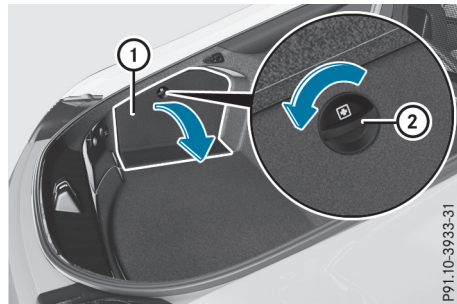

- ▶ Open the tailgate.
- ▶ **To open:** turn fastener **2** on the service flap to the left.
- ▶ Open service flap **1**.

**i** The fuse allocation chart is located in a recess at the side of the fuse box. You can find the corresponding fuse rating and fuse type on the fuse allocation chart.

**Important safety notes** **WARNING**

If wheels and tires of the wrong size are used, the wheel brakes or suspension components may be damaged. There is a risk of an accident.

Always replace wheels and tires with those that fulfill the specifications of the original part.

When replacing wheels, make sure to use the correct:

- designation
- model

When replacing tires, make sure to use the correct:

- designation
- manufacturer
- model

 **WARNING**

A flat tire severely impairs the driving, steering and braking characteristics of the vehicle. There is a risk of accident.

Tires without run-flat characteristics:

- do not drive with a flat tire.
- immediately replace the flat tire with your emergency spare wheel or spare wheel, or consult a qualified specialist workshop.

Tires with run-flat characteristics:

- pay attention to the information and warning notices on MOExtended tires (tires with run-flat characteristics).

Accessories that are not approved for your vehicle by Mercedes-Benz or are not being used correctly can impair the operating safety.

Before purchasing and using non-approved accessories, visit a qualified specialist workshop and inquire about:

- suitability
- legal stipulations
- factory recommendations

Information on the sizes and types of wheels and tires for your vehicle can be found under "Wheel/tire combinations" (▷ page 274).

Tire pressure information can be found:

- on the Tire and Loading Information placard on the B-pillar on the driver's side (▷ page 260)
- in the tire pressure table in the fuel filler flap (▷ page 117)
- in the "Tire pressure" section

**Operation****Information on driving**

Check the tire pressure when the vehicle is heavily laden and adjust prior to a trip.

While driving, pay attention to vibrations, noises and unusual handling characteristics, e.g. pulling to one side. This may indicate that the wheels or tires are damaged. If you suspect that a tire is defective, reduce your speed immediately. Stop the vehicle as soon as possible to check the wheels and tires for damage. Hidden tire damage could also be causing the unusual handling characteristics. If you find no signs of damage, have the tires and wheels checked at a qualified specialist workshop.

When parking your vehicle, make sure that the tires do not get deformed by the curb or other obstacles. If they cannot be avoided, drive over obstacles such as curbs slowly and at an obtuse angle. Otherwise, you may damage the wheels or tires.

**Notes on high performance tires** **WARNING**

Due to the special tire tread in combination with the optimized rubber compound, there is an increased risk of hydroplaning and skidding on a damp or wet road surface. Tire grip is also noticeably reduced at low outside temperatures and low tire operating temperatures. There is a risk of an accident.

Turn on ESP® and adapt your driving style accordingly. When the outside temperature falls below 10 °C, use M+S tires.

- i** Different driving styles may lead to high tire wear and the tires may reach the minimum tire tread depth after only a short time.

### Regular checking of wheels and tires

#### **⚠ WARNING**

Damaged tires can cause tire inflation pressure loss. As a result, you could lose control of your vehicle. There is a risk of accident.

Check the tires regularly for signs of damage and replace any damaged tires immediately.

Check wheels and tires for damage at least once a month. Check wheels and tires after driving off-road or on rough roads. Damaged wheels can cause a loss of tire pressure. Pay particular attention to damage such as:

- Cuts in the tires
- Punctures in the tires
- Tears in the tires
- Bulges on tires
- Deformation or severe corrosion on wheels

Regularly check the tire tread depth and the condition of the tread across the whole width of the tire (▷ page 253). If necessary, turn the front wheels to full lock in order to inspect the inner side of the tire surface.

All wheels must have a valve cap to protect the valve against dirt and moisture. Do not mount anything onto the valve other than the standard valve cap or other valve caps approved by Mercedes-Benz for your vehicle. Do not use any other valve caps or systems, e.g. tire pressure monitoring systems.

Regularly check the pressure of all the tires particularly prior to long trips. Adjust the tire pressure as necessary (▷ page 255).

The service life of tires depends, among other things, on the following factors:

- Driving style
- Tire pressure
- Distance covered

### Notes on tire tread

#### **⚠ WARNING**

Insufficient tire tread will reduce tire traction. The tire is no longer able to dissipate water. This means that on wet road surfaces, the risk of hydroplaning increases, in particular where speed is not adapted to suit the driving conditions. There is a risk of accident.

If the tire pressure is too high or too low, tires may exhibit different levels of wear at different locations on the tire tread. Thus, you should regularly check the tread depth and the condition of the tread across the entire width of all tires.

Minimum tire tread depth for:

- Summer tires:  $\frac{1}{8}$  in (3 mm)
- M+S tires:  $\frac{1}{6}$  in (4 mm)

For safety reasons, replace the tires before the legally prescribed limit for the minimum tire tread depth is reached.

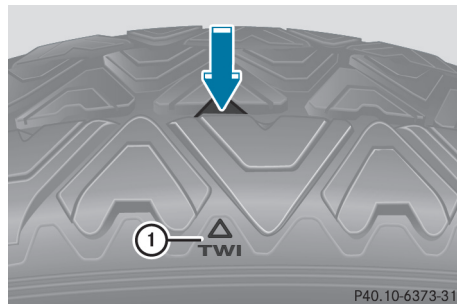

Marking ① shows where the bar indicator (arrow) for tread wear is integrated into the tire tread.

Treadwear indicators (TWI) are required by law. Six indicators are positioned on the tire tread. They are visible once a tread depth of approximately  $\frac{1}{16}$  in (1.6 mm) has been reached. If this is the case, the tire is so worn that it must be replaced.

### Selecting, mounting and replacing tires

- Only mount tires and wheels of the same type and make.

Exception: it is permissible to install a different type or make in the event of a flat tire.

- Only mount tires of the correct size onto the wheels.
- Break in new tires at moderate speeds for the first 60 miles (100 km). The new tires only reach their full performance after this distance.
- Do not drive with tires which have too little tread depth, as this significantly reduces the traction on wet roads (hydroplaning).
- Replace the tires after six years at the latest, regardless of wear.

## Winter operation

### General notes

Have your vehicle winter-proofed at a qualified specialist workshop at the onset of winter.

Observe the notes in the "Changing a wheel" section (▷ page 270).

### Driving with summer tires

At temperatures below 45 °F (+7 °C), summer tires lose elasticity and therefore traction and braking power. Change the tires on your vehicle to M+S tires. Using summer tires at very cold temperatures could cause cracks to form, thereby damaging the tires permanently. Mercedes-Benz cannot accept responsibility for this type of damage.

#### WARNING

Damaged tires can cause tire inflation pressure loss. As a result, you could lose control of your vehicle. There is a risk of accident.

Check the tires regularly for signs of damage and replace any damaged tires immediately.

### M+S tires

#### WARNING

M+S tires with a tire tread depth of less than  $\frac{1}{8}$  in (4 mm) are not suitable for use in winter and do not provide sufficient traction. There is a risk of an accident.

M+S tires with a tread depth of less than  $\frac{1}{8}$  in (4 mm) must be replaced immediately.

At temperatures below 45 °F (+7 °C), use winter tires or all-season tires. Both types of tire are identified by the M+S marking.

Only winter tires bearing the  snowflake symbol in addition to the M+S marking provide the best possible grip in wintry road conditions. Only these tires will allow driving safety systems such as ABS and ESP® to function optimally in winter. These tires have been developed specifically for driving in snow.

Use M+S tires of the same make and tread on all wheels to maintain safe handling characteristics.

Always observe the maximum permissible speed specified for the M+S tires you have mounted.

When you have mounted the M+S tires:

- ▶ Check the tire pressures (▷ page 255).
- ▶ Restart the tire pressure monitor (▷ page 260).

### Snow chains

#### WARNING

If snow chains are installed to the front wheels, they may drag against the vehicle body or chassis components. This could cause damage to the vehicle or the tires. There is a risk of an accident.

To avoid hazardous situations:

- never install snow chains to the front wheels
- always install snow chains in pairs to the rear wheels.

For safety reasons, Mercedes-Benz recommends that you only use snow chains that have been specially approved for your vehicle by Mercedes-Benz, or are of a corresponding standard of quality. For more information, please contact a qualified specialist workshop.

If you intend to mount snow chains, please bear the following points in mind:

- Snow chains may not be mounted on all wheel/tire combinations. Permissible wheel-tire combinations (▷ page 274).
- Only use snow chains when driving on roads completely covered by snow. Remove the snow chains as soon as possible when you come to a road that is not snow-covered.
- Local regulations may restrict the use of snow chains. Observe the appropriate regulations if you wish to mount snow chains.
- Do not exceed the maximum permissible speed of 30 mph (50 km/h).

You may wish to deactivate ESP® when pulling away with snow chains installed (▷ page 60). You can thereby allow the wheels to spin in a controlled manner, achieving an increased driving force (cutting action).

## Tire pressure

### Tire pressure specifications

#### Important safety notes

##### WARNING

Underinflated or overinflated tires pose the following risks:

- the tires may burst, especially as the load and vehicle speed increase.
- the tires may wear excessively and/or unevenly, which may greatly impair tire traction.
- the driving characteristics, as well as steering and braking, may be greatly impaired.

There is a risk of an accident.

Follow recommended tire inflation pressures and check the pressure of all the tires including the spare wheel:

- monthly, at least
- if the load changes
- before beginning a long journey
- under different operating conditions, e.g. off-road driving

If necessary, correct the tire pressure.

The data on the Tire and Loading Information placard and tire pressure table shown here are examples. Tire pressure specifications are vehicle-specific and may deviate from the data shown here. The tire pressure specifications that are valid for your vehicle can be found on the Tire and Loading Information placard and tire pressure table on the vehicle.

#### General notes

The recommended tire pressures for the tires mounted at the factory can be found on the labels described here.

Further information on tire pressures can be obtained at a qualified specialist workshop.

#### Tire and Loading Information placard

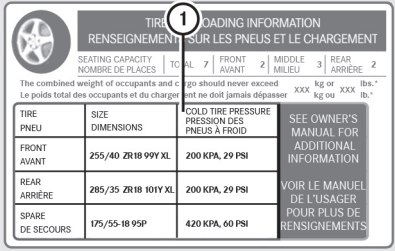

**TIRE AND LOADING INFORMATION**  
RENSEIGNEMENTS SUR LES PNEUS ET LE CHARGEMENT

SEATING CAPACITY / NOMBRE DE PLACES: 7  
FRONT / AVANT: 2  
MIDDLE / MILIEU: 3  
REAR / ARRIERE: 2

The combined weight of occupants and cargo should never exceed XXX kg or XXX lbs. Le poids total des occupants et du chargement ne doit jamais dépasser XXX kg ou XXX lb.

| TIRE / PNEU        | SIZE / DIMENSIONS   | COLD TIRE PRESSURE / PRESSION DES PNEUS À FROID | SEE OWNER'S MANUAL FOR ADDITIONAL INFORMATION / VOIR LE MANUEL DE L'USAGER POUR PLUS DE RENSEIGNEMENTS |
|--------------------|---------------------|---|--|
| FRONT / AVANT      | 255/40 ZR18 99Y XL  | 200 KPA, 29 PSI                                 |  |
| REAR / ARRIERE     | 285/35 ZH18 101Y XL | 200 KPA, 29 PSI                                 |  |
| SPARE / DE SECOURS | 175/55-18 95P       | 420 KPA, 60 PSI                                 |  |
|                    |                     |   |  |

P40.00-2223-31

##### ① Recommended tire pressures

The Tire and Loading Information placard is on the B-pillar on the driver's side (▷ page 260).

The Tire and Loading Information placard contains the recommended tire pressures for cold tires. The recommended tire pressures are valid for the maximum permissible load and up to the maximum permissible vehicle speed.

#### Tire pressure table

The tire pressure table is on the inside of the fuel filler flap. It shows the tire pressure for all tires permitted at the factory for this vehicle; see illustration (example).

If a tire size precedes a tire pressure, the tire pressure information following is only valid for that tire size.

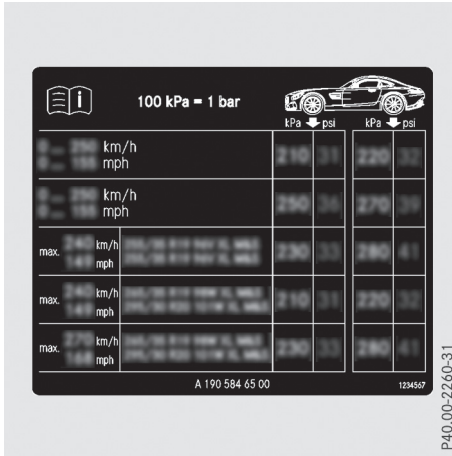

If the tire pressures have been set to the lower values for lighter loads and/or lower road speeds, the pressures should be reset to the higher values:

- if you want to drive with an increased load and/or
- if you want to drive at higher road speeds

The tire pressures for increased loads and/or higher road speeds, shown in the tire pressure table, may have a negative effect on driving comfort.

If the tire pressure is not set correctly, this can lead to an excessive build up of heat and a sudden loss of pressure.

For more information, contact a qualified specialist workshop.

### Important notes on tire pressure

#### WARNING

If the tire pressure drops repeatedly, the wheel, valve or tire may be damaged. Tire pressure that is too low may result in a tire blow-out. There is a risk of an accident.

- Check the tire for foreign objects.
- Check whether the wheel is losing air or the valve is leaking.

If you are unable to rectify the damage, contact a qualified specialist workshop.

#### WARNING

If you fit unsuitable accessories onto tire valves, the tire valves may be overloaded and malfunction, which can cause tire pressure loss. Due to their design, retrofitted tire pressure monitors keep the tire valve open. This can also result in tire pressure loss. There is a risk of an accident.

Only screw the standard valve cap or other valve caps approved by Mercedes-Benz for your vehicle onto the tire valve.

Use a suitable pressure gauge to check the tire pressure. The outer appearance of a tire does not permit any reliable conclusion about the tire pressure. On vehicles equipped with the electronic tire pressure monitor, the tire pressure can be checked in the on-board computer.

The tire temperature and pressure increase when the vehicle is in motion. This is dependent on the driving speed and the load.

Therefore, you should only correct tire pressures when the tires are cold.

The tires are cold:

- if the vehicle has been parked with the tires out of direct sunlight for at least three hours and
- if the vehicle has not been driven further than 1 mile (1.6 km)

The tire temperature changes depending on the outside temperature, the vehicle speed and the tire load. If the tire temperature changes by 18 °F (10 °C), the tire pressure changes by approximately 10 kPa (0.1 bar/1.5 psi). Take this into account when checking the pressure of warm tires. Only correct the tire pressure if it is too low for the current operating conditions. If you check the tire pressure when the tires are warm, the resulting value will be higher than if the tires were cold. This is normal. Do not reduce the tire pressure to the value specified for cold tires. The tire pressure would otherwise be too low.

Observe the recommended tire pressures for cold tires:

- on the Tire and Loading Information placard on the B-pillar on the driver's side
- in the tire pressure table in the fuel filler flap (▷ page 117).

## Underinflated or overinflated tires

### Underinflated tires

#### WARNING

Tires with pressure that is too low can overheat and burst as a consequence. In addition, they also suffer from excessive and/or irregular wear, which can severely impair the braking properties and the driving characteristics. There is a risk of an accident.

Avoid tire pressures that are too low in all the tires, including the spare wheel.

Underinflated tires may:

- overheat, leading to tire defects
- adversely affect handling
- wear excessively and/or unevenly
- have an adverse effect on fuel consumption

### Overinflated tires

#### WARNING

Tires with excessively high pressure can burst because they are damaged more easily by road debris, potholes etc. In addition, they also suffer from irregular wear, which can severely impair the braking properties and the driving characteristics. There is a risk of an accident.

Avoid tire pressures that are too high in all the tires, including the spare wheel.

Overinflated tires may:

- increase the braking distance
- adversely affect handling
- wear excessively and/or unevenly
- have an adverse effect on ride comfort
- be more susceptible to damage

## Maximum tire pressures

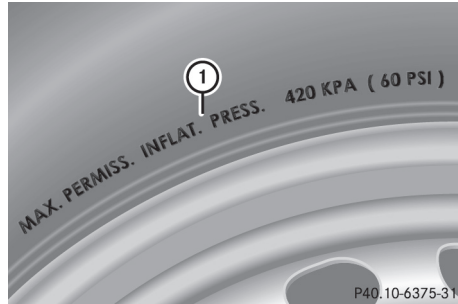

- ① Example: maximum permissible tire pressure

Never exceed the maximum permissible tire inflation pressure. Always observe the recommended tire pressure for your vehicle when adjusting the tire pressure (> page 255).

- i** The actual values for tires are vehicle-specific and may deviate from the values in the illustration.

## Checking the tire pressures

### Important safety notes

Observe the notes on tire pressure (> page 255).

Information on air pressure for the tires on your vehicle can be found:

- on the vehicle's Tire and Loading Information placard on the B-pillar
- in the tire pressure table in the fuel filler flap (> page 117)
- in the "Tire pressure" section

### Checking tire pressures manually

To determine and set the correct tire pressure, proceed as follows:

- ▶ Remove the valve cap of the tire that is to be checked.
- ▶ Press the tire pressure gage securely onto the valve.
- ▶ Read the tire pressure and compare it to the recommended value on the Tire and Loading Information placard or the tire pressure table (> page 255).



- ▶ If the tire pressure is too low, increase the tire pressure to the recommended value.
- ▶ If the tire pressure is too high, release air. To do so, press down the metal pin in the valve, using the tip of a pen for example. Then check the tire pressure again using the tire pressure checker.
- ▶ Screw the valve cap onto the valve.
- ▶ Repeat these steps for the other tires.

### Tire pressure monitor

#### General notes

If a tire pressure monitor is installed, the vehicle's wheels have sensors that monitor the tire pressures in all four tires. The tire pressure monitor warns you if the pressure drops in one or more of the tires. The tire pressure monitor only functions if the corresponding sensors are installed in all wheels.

Information on tire pressures is displayed in the multifunction display. After a few minutes of driving, the current tire pressure of each tire is shown in the **Service** menu of the multifunction display; see illustration (example).

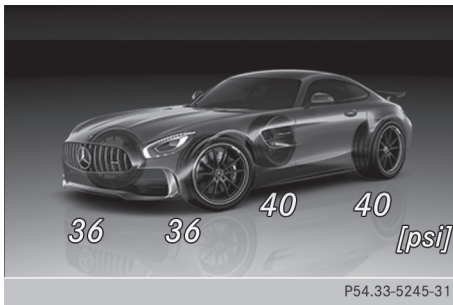

P54.33-5245-31

For information on the message display, refer to the "Checking the tire pressure electronically" section (▶ page 259).

#### Important safety notes

##### WARNING

Each tire, including the spare (if provided), should be checked at least once every two weeks when cold and inflated to the pressure recommended by the vehicle manufacturer on the Tire and Loading Information placard

on the driver's door B-pillar or the tire pressure label on the inside of the fuel filler flap. If your vehicle has tires of a different size than the size indicated on the Tire and Loading Information placard or, if available, the tire pressure label, you should determine the proper tire pressure for those tires.

As an added safety feature, your vehicle has been equipped with a tire pressure monitoring system (TPMS) that illuminates a low tire pressure telltale when one or more of your tires are significantly underinflated. Accordingly, when the low tire pressure telltale lights up, you should stop and check your tires as soon as possible, and inflate them to the proper pressure. Driving on a significantly underinflated tire causes the tire to overheat and can lead to tire failure.

Underinflation also reduces fuel efficiency and tire tread life, and may affect the vehicle's handling and stopping ability. Please note that the TPMS is not a substitute for proper tire maintenance, and it is the driver's responsibility to maintain correct tire pressure, even if underinflation has not reached the level to trigger illumination of the TPMS low tire pressure telltale.

Your vehicle has also been equipped with a TPMS malfunction indicator to indicate when the system is not operating properly. The TPMS malfunction indicator is combined with the low tire pressure telltale. When the system detects a malfunction, the warning lamp will flash for approximately a minute and then remain continuously illuminated. This sequence will be repeated every time the vehicle is started as long as the malfunction exists. When the malfunction indicator is illuminated, the system may not be able to detect or signal low tire pressure as intended.

TPMS malfunctions may occur for a variety of reasons, including the installation of incompatible replacement or alternate tires or wheels on the vehicle that prevent the TPMS from functioning properly. Always check the TPMS malfunction telltale after replacing one or more tires or wheels on your vehicle to

ensure that the replacement or alternate Tires and wheels allow the TPMS to continue to function properly.

It is the driver's responsibility to set the tire pressure to that recommended for cold tires which is suitable for the operating situation (▷ page 255). Note that the correct tire pressure for the current operating situation must first be taught-in to the tire pressure monitor. If a substantial loss of pressure occurs, the warning threshold for the warning message is aligned to the taught-in reference values. Restart the tire pressure monitor after adjusting the pressure of the cold tires (▷ page 260). The current pressures are saved as new reference values. As a result, a warning message will appear if the tire pressure drops significantly.

The tire pressure monitor does not warn you of an incorrectly set tire pressure. Observe the notes on the recommended tire pressure (▷ page 255).

The tire pressure monitor is not able to warn you of a sudden loss of pressure, e.g. if the tire is penetrated by a foreign object. In the event of a sudden loss of pressure, bring the vehicle to a halt by braking carefully. Avoid abrupt steering movements.

The tire pressure monitor has a yellow warning lamp in the instrument cluster for indicating pressure loss or a malfunction. Whether the warning lamp flashes or lights up indicates whether a tire pressure is too low or the tire pressure monitor is malfunctioning:

- if the warning lamp is lit continuously, the tire pressure on one or more tires is significantly too low. The tire pressure monitor is not malfunctioning.
- if the warning lamp flashes for around a minute and then remains lit constantly, the tire pressure monitor is malfunctioning.







In addition to the warning lamp, a message appears in the multifunction display. Observe the information on display messages (▷ page 182).

It may take up to ten minutes for a malfunction of the tire pressure monitor to be indicated. A malfunction will be indicated by the tire pressure warning lamp flashing for approximately one minute and then remaining lit. When the malfunction has been rectified, the tire pressure warning lamp goes out after a few minutes of driving.

The tire pressure values indicated by the on-board computer may differ from those measured at a gas station with a pressure gauge. The tire pressures shown by the on-board computer refer to those measured at sea level. At high altitudes, the tire pressure values indicated by a pressure gauge are higher than those shown by the on-board computer. In this case, do not reduce the tire pressures.

The operation of the tire pressure monitor can be affected by interference from radio transmitting equipment (e.g. radio headphones, two-way radios) that may be being operated in or near the vehicle.

### Checking the tire pressure electronically

- ▶ Switch on the ignition (▷ page 102).
- ▶ Use  on the steering wheel to call up the list of menus.
- ▶ Press  or  on the steering wheel to select the **Service** menu.
- ▶ Press the  button.
- ▶ Press  or  to select **Tire Pressure**.
- ▶ Press the  button.  
The current tire pressure of each tire is shown in the multifunction display.

If the vehicle was parked for longer than 20 minutes, the following message appears: **Tire pressure will be displayed after driving a few minutes.**

After a teach-in process, the tire pressure monitor automatically detects new wheels or new sensors. As long as a clear allocation of the tire pressure value to the individual wheels is not possible, the **Tire Pressure Monitor Active** message is shown instead of the tire pressure display. The tire pressures are already being monitored.

### Tire pressure monitor warning messages

If the tire pressure monitor detects a pressure loss in one or more tires, a warning message is shown in the multifunction display. The yellow tire pressure warning lamp then lights up.

- If the **Please Correct Tire Pressure** message appears in the multifunction display, the tire pressure in at least one tire is too low.

The tire pressure must be corrected when the opportunity arises.

- If the **Check Tires** message appears in the multifunction display, the tire pressure in at least one tire has dropped significantly. The tires must be checked.
- If the **Warning Tire Malfunction** message appears in the multifunction display, the tire pressure in at least one tire has dropped suddenly. The tires must be checked.

Observe the instructions and safety notes in the display messages in the "Tires" section (▷ page 182).







If the wheel positions on the vehicle are rotated, the tire pressures may be displayed for the wrong positions for a short time. This is rectified after a few minutes of driving, and the tire pressures are displayed for the correct positions.

### Restarting the tire pressure monitor

When you restart the tire pressure monitor, all existing warning messages are deleted and the warning lamps go out. The monitor uses the currently set tire pressures as the reference values for monitoring. In most cases, the tire pressure monitor will automatically detect the new reference values after you have changed the tire pressure. However, you can also set reference values manually as described here. The tire pressure monitor then monitors the new tire pressure values.

- ▶ Set the tire pressure to the value recommended for the corresponding driving situation on the Tire and Loading Information placard on the driver's side B-pillar (▷ page 255).

You can find more tire pressure values for various operating conditions in the tire pressure table inside the fuel filler flap (▷ page 255).

- ▶ Make sure that the tire pressure is correct on all four wheels.
- ▶ Switch on the ignition (▷ page 102).
- ▶ Use  on the steering wheel to call up the list of menus.
- ▶ Press  or  on the steering wheel to select the **Service** menu.
- ▶ Press the  button.
- ▶ Press  or  to select **Tire Pressure**.

- ▶ Press the  button.

The current tire pressure for each wheel or the **Tire pressure will be displayed after driving a few minutes** message will be displayed in the multifunction display.

- ▶ Press the  button.

The **Use Current Pressures as New Reference Values** message appears in the multifunction display.

#### If you wish to confirm the restart:

- ▶ Press the  button.

The **Tire Press. Monitor Restarted** message appears on the multifunction display.

After driving for a few minutes, the system checks whether the current tire pressures are within the specified range. The new tire pressures are then accepted as reference values and monitored.

#### If you wish to cancel the restart:

- ▶ Press the  button.

The tire pressure values stored at the last restart will continue to be monitored.

## Loading the vehicle

### Instruction labels for tires and loads

#### WARNING

Overloaded tires can overheat, causing a blowout. Overloaded tires can also impair the steering and driving characteristics and lead to brake failure. There is a risk of accident.

Observe the load rating of the tires. The load rating must be at least half of the GAWR of your vehicle. Never overload the tires by exceeding the maximum load.

Two instruction labels on your vehicle show the maximum possible load.

- (1) The Tire and Loading Information placard is on the B-pillar on the driver's side. The Tire and Loading Information placard shows the permissible number of vehicle occupants and the maximum permissible load of the vehicle. It also contains details of the tire

sizes and corresponding pressures for tires mounted at the factory.

- (2) The vehicle identification plate is on the B-pillar on the driver's side. The vehicle identification plate informs you of the gross vehicle weight rating. It is made up of the vehicle weight, all vehicle occupants, the fuel and the cargo. You can also find information about the maximum gross axle weight rating on the front and rear axle.

The maximum gross axle weight rating is the maximum weight that can be carried by one axle (front or rear axle). Do not exceed the maximum gross vehicle weight or the maximum gross axle weight rating for the front or rear axle.



① B-pillar, driver's side

**Maximum permissible mass.**

| TIRE RENSEIGNEMENT  |                     | ① LOADING INFORMATION                            |                    |   |
|---|---------------------|--|--------------------|---|
| SUR LES PNEUS ET LE CHARGEMENT  |                     |  |                    |   |
| SEATING CAPACITY<br>NOMBRE DE PLACES  | TOTAL               | 7 FRONT<br>AVANT                                 | 2 MIDDLE<br>MILIEU | 3 REAR<br>ARRIERE   |
| The combined weight of occupants and cargo should never exceed XXX kg or XXX lbs.<br>Le poids total des occupants et du chargement ne doit jamais dépasser XXX kg ou XXX lb.* |                     |  |                    |   |
| TIRE PNEU   | SIZE DIMENSIONS     | COLD TIRE PRESSURE<br>PRESSION DES PNEUS À FROID |                    | SEE OWNER'S<br>MANUAL FOR<br>ADDITIONAL<br>INFORMATION          |
| FRONT<br>AVANT  | 255/40 ZR18 99Y XL  | 200 KPA, 29 PSI                                  |                    | VOIR LE MANUEL<br>DE L'USAGER<br>POUR PLUS DE<br>RENSEIGNEMENTS |
| REAR<br>ARRIERE   | 285/35 ZR18 101Y XL | 200 KPA, 29 PSI                                  |                    |   |
| SPARE<br>DE SECOURS   | 175/55-18 95P       | 420 KPA, 60 PSI                                  |                    |   |

P40.00-2224-31

- ▶ Maximum permissible gross vehicle weight ① is listed on the Tire and Loading Information placard: "The combined weight of occupants and cargo should never exceed XXX kilograms or XXX lbs."

The gross weight of all vehicle occupants, load and luggage must not exceed the specified value.

- ① The specifications shown on the Tire and Loading Information placard in the illustration are examples. The maximum permissible load is vehicle-specific and may deviate from the data shown here. The maximum permissible load that applies for your vehicle can be found on your vehicle's Tire and Loading Information placard.

**Number of seats**

| TIRE RENSEIGNEMENT  |                     | ① LOADING INFORMATION                            |                    |   |
|---|---------------------|--|--------------------|---|
| SUR LES PNEUS ET LE CHARGEMENT  |                     |  |                    |   |
| SEATING CAPACITY<br>NOMBRE DE PLACES  | TOTAL               | 7 FRONT<br>AVANT                                 | 2 MIDDLE<br>MILIEU | 3 REAR<br>ARRIERE   |
| The combined weight of occupants and cargo should never exceed XXX kg or XXX lbs.<br>Le poids total des occupants et du chargement ne doit jamais dépasser XXX kg ou XXX lb.* |                     |  |                    |   |
| TIRE PNEU   | SIZE DIMENSIONS     | COLD TIRE PRESSURE<br>PRESSION DES PNEUS À FROID |                    | SEE OWNER'S<br>MANUAL FOR<br>ADDITIONAL<br>INFORMATION          |
| FRONT<br>AVANT  | 255/40 ZR18 99Y XL  | 200 KPA, 29 PSI                                  |                    | VOIR LE MANUEL<br>DE L'USAGER<br>POUR PLUS DE<br>RENSEIGNEMENTS |
| REAR<br>ARRIERE   | 285/35 ZR18 101Y XL | 200 KPA, 29 PSI                                  |                    |   |
| SPARE<br>DE SECOURS   | 175/55-18 95P       | 420 KPA, 60 PSI                                  |                    |   |

P40.00-2225-31

Maximum number of seats ① indicates the maximum number of occupants allowed to travel in the vehicle. This information can be found on the Tire and Loading Information placard.

- ① The specifications shown on the Tire and Loading Information placard in the illustration are examples. The number of seats is vehicle-specific and can differ from the details shown. The number of seats in your vehicle can be found on the Tire and Loading Information placard.

**Determining the correct load limit**

**Step-by-step instructions**

The following steps have been developed as required of all manufacturers under Title 49, Code of U.S. Federal Regulations, Part 575 pursuant to the "National Traffic and Motor Vehicle Safety Act of 1966".

- ▶ **Step 1:** Locate the statement "The combined weight of occupants and cargo should never

exceed XXX kg or XXX lbs." on your vehicle's Tire and Loading Information placard.

- ▶ **Step 2:** Determine the combined weight of the driver and passengers that will be riding in your vehicle.
- ▶ **Step 3:** Subtract the combined weight of the driver and passengers from XXX kilograms or XXX lbs.
- ▶ **Step 4:** The resulting figure equals the available amount of cargo and luggage load capacity.

city. For example, if the "XXX" amount equals 1400 lbs and there will be five 150-lb passengers in your vehicle, the amount of available cargo and luggage load capacity is 650 lbs (1400 - 750 (5 x 150) = 650 lbs).

- ▶ **Step 5:** Determine the combined weight of luggage and cargo being loaded on the vehicle. That weight may not safely exceed the available cargo and luggage load capacity calculated in step 4.

### Example: steps 1 to 3

The following table shows examples of how to calculate total and cargo load capacities with varying seating configurations and different numbers and weights of vehicle occupants. The following examples use a load limit of 1500 lbs (680 kg). **This is for illustration purposes only.** Make sure you are using the actual load limit for your vehicle stated on your vehicle's Tire and Loading Information placard (▷ page 260).

The higher the weight of all the vehicle occupants, the smaller the maximum load for luggage.

#### Step 1

|   | Example 1         | Example 2         | Example 3         |
|---|-------------------|-------------------|-------------------|
| <b>Combined maximum weight of vehicle occupants and load (data from the Tire and Loading Information placard)</b> | 1500 lbs (680 kg) | 1500 lbs (680 kg) | 1500 lbs (680 kg) |

#### Step 2

|   | Example 1           | Example 2           | Example 3 |
|---|---------------------|---------------------|-----------|
| <b>Number of people in the vehicle (driver and occupants)</b> | 5                   | 3                   | 1         |
| <b>Distribution of the occupants</b>                          | Front: 2<br>Rear: 3 | Front: 1<br>Rear: 2 | Front: 1  |

|                                      | Example 1   | Example 2   | Example 3                   |
|--------------------------------------|---|---|-----------------------------|
| <b>Weight of the occupants</b>       | Occupant 1: 150 lbs (68 kg)<br>Occupant 2: 180 lbs (82 kg)<br>Occupant 3: 160 lbs (73 kg)<br>Occupant 4: 140 lbs (63 kg)<br>Occupant 5: 120 lbs (54 kg) | Occupant 1: 200 lbs (91 kg)<br>Occupant 2: 190 lbs (86 kg)<br>Occupant 3: 150 lbs (68 kg) | Occupant 1: 150 lbs (68 kg) |
| <b>Gross weight of all occupants</b> | 750 lbs (340 kg)  | 540 lbs (245 kg)  | 150 lbs (68 kg)             |

**Step 3**

|   | Example 1   | Example 2   | Example 3   |
|---|---|---|---|
| <b>Permissible load (maximum gross vehicle weight rating from the Tire and Loading Information placard minus the gross weight of all occupants)</b> | 1500 lbs (680 kg) - 750 lbs (340 kg) = 750 lbs (340 kg) | 1500 lbs (680 kg) - 540 lbs (245 kg) = 960 lbs (435 kg) | 1500 lbs (680 kg) - 150 lbs (68 kg) = 1350 lbs (612 kg) |

**Vehicle identification plate**

Even if you have calculated the total load carefully, you should still make sure that the gross vehicle weight rating and the gross axle weight rating are not exceeded. Details can be found on the vehicle identification plate on the B-pillar on the driver's side of the vehicle (> page 260).

**Gross vehicle weight:** the gross weight of the vehicle, all vehicle occupants, load and trailer load/noseweight (if applicable) must not exceed the gross vehicle weight rating.

**Gross Axle Weight Rating (GAWR):** the maximum permissible load that can be carried by one axle (front or rear axle).

To ensure that your vehicle does not exceed the gross vehicle weight and maximum gross axle weight rating, have your loaded vehicle (including driver, vehicle occupants, load and full trailer load if applicable) weighed on a suitable vehicle weighbridge.

**All about wheels and tires**

**Uniform Tire Quality Grading Standards**

**Overview of Tire Quality Grading Standards**

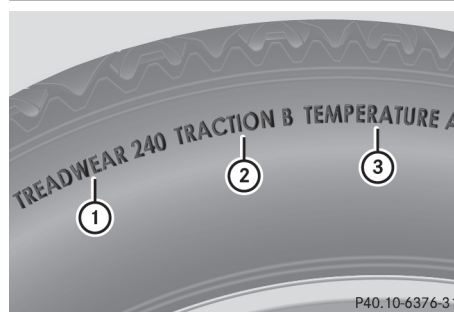

Uniform Tire Quality Grading Standards are U.S. government specifications. Their purpose is to provide drivers with uniform reliable information on tire performance data. Tire manufacturers have to grade tires using three performance fac-

tors: ① tread wear grade, ② traction grade and ③ temperature grade. These regulations do not apply to Canada. Nevertheless, all tires sold in North America are provided with the corresponding quality grading markings on the sidewall of the tire.

Quality grades can be found, where applicable, on the tire sidewall between tread shoulder and maximum section width.

Example:

- **Treadwear grade:** 200
- **Traction grade:** AA
- **Temperature grade:** A

All passenger car tires must conform to the statutory safety requirements in addition to these grades.

**i** The actual values for tires are vehicle-specific and may deviate from the values in the illustration.

### Treadwear

The treadwear grade is a comparative rating based on the wear rate of the tire when tested under controlled conditions on a specified U.S. government course. For example, a tire graded 150 would wear one and one-half times as well on the government course as a tire graded 100.

The relative performance of tires depends upon the actual conditions of their use, however, and may depart significantly from the norm due to variations in driving habits, service practices and differences in road characteristics and climate.

### Traction

#### WARNING

The traction grade assigned to this tire is based on straight-ahead braking traction tests, and does not include acceleration, cornering, hydroplaning, or peak traction characteristics.

**!** Avoid wheelspin. This can lead to damage to the drive train.

The traction grades – from highest to lowest – are AA, A, B and C. Those grades represent the tire's ability to stop on wet pavement as measured under controlled conditions on specified government test surfaces of asphalt and con-

crete. A tire marked C may have poor traction performance.

The safe speed on a wet, snow covered or icy road is always lower than on dry road surfaces. You should pay special attention to road conditions when temperatures are around freezing point.

Mercedes-Benz recommends a minimum tread depth of  $\frac{1}{8}$  in (4 mm) on all four winter tires. Observe the legally required minimum tire tread depth (▷ page 253). Winter tires can reduce the braking distance on snow-covered surfaces in comparison with summer tires. The braking distance is still much further than on surfaces that are not icy or covered with snow. Take appropriate care when driving.

Further information on winter tires (M+S tires) (▷ page 254).

### Temperature

#### WARNING

The temperature grade for this tire is established for a tire that is properly inflated and not overloaded. Excessive speed, underinflation, or excessive loading, either separately or in combination, can cause excessive heat build-up and possible tire failure.

The temperature grades are A (the highest), B, and C, representing the tire's resistance to the generation of heat and its ability to dissipate heat when tested under controlled conditions on a specified indoor laboratory test wheel. Sustained high temperature can cause the material of the tire to degenerate and reduce tire life, and excessive temperature can lead to sudden tire failure. The grade C corresponds to a level of performance which all passenger car tires must meet under the Federal Motor Vehicle Safety Standard No. 109. Grades B and A represent higher levels of performance on the laboratory test wheel than the minimum required by law.



## Tire labeling

### Overview

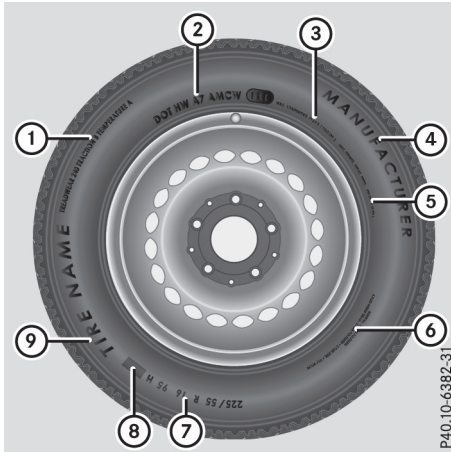

- ① Uniform Tire Quality Grading Standard (▷ page 268)
- ② DOT, Tire Identification Number (▷ page 267)
- ③ Maximum tire load (▷ page 267)
- ④ Maximum tire pressure (▷ page 257)
- ⑤ Manufacturer
- ⑥ Tire material (▷ page 268)
- ⑦ Tire size designation, load-bearing capacity and speed rating (▷ page 265)
- ⑧ Load index (▷ page 267)
- ⑨ Tire name

The markings described above are on the tire in addition to the tire name (sales designation) and the manufacturer's name.

**i** Tire data is vehicle-specific and may deviate from the data in the example.

### Tire size designation, load-bearing capacity and speed rating

#### **⚠ WARNING**

Exceeding the stated tire load-bearing capacity and the approved maximum speed could lead to tire damage or the tire bursting. There is a risk of accident.

Therefore, only use tire types and sizes approved for your vehicle model. Observe the

tire load rating and speed rating required for your vehicle.

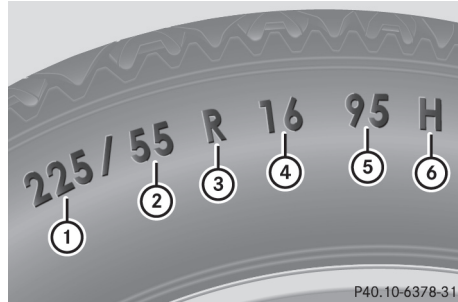

- ① Tire width
- ② Nominal aspect ratio in %
- ③ Tire code
- ④ Rim diameter
- ⑤ Load bearing index
- ⑥ Speed rating

**General:** depending on the manufacturer's standards, the size imprinted in the tire wall may not contain any letters or may contain one letter that precedes the size description.

If there is no letter preceding the size description (as shown above): these are passenger vehicle tires according to European manufacturing standards.

If "P" precedes the size description: these are passenger vehicle tires according to U.S. manufacturing standards.

If "LT" precedes the size description: these are light truck tires according to U.S. manufacturing standards.

If "T" precedes the size description: compact emergency wheels with high tire pressure that are only designed for temporary use in an emergency.

**Tire width:** tire width ① shows the nominal tire width in millimeters.

**Height-width ratio:** aspect ratio ② is the size ratio between the tire height and tire width and is shown in percent. The aspect ratio is calculated by dividing the tire width by the tire height.

**Tire code:** tire code ③ specifies the tire type. "R" represents radial tires; "D" represents diagonal tires; "B" represents diagonal radial tires.

Optionally, tires with a maximum design speed of over 149 mph (240 km/h) may have "ZR" in

the size description, depending on the manufacturer (e.g. 245/40 ZR 18).

**Rim diameter:** rim diameter ④ is the diameter of the bead seat, not the diameter of the rim flange. The rim diameter is specified in inches (in).

**Load-bearing index:** load-bearing index ⑤ is a numerical code that specifies the maximum load-bearing capacity of a tire.

Do not overload the tires by exceeding the specified load limit. The maximum permissible load can be found on the vehicle's Tire and Loading Information placard on the B-pillar on the driver's side (▷ page 260).

Example:

Load-bearing index 91 indicates a maximum load of 1,356 lb (615 kg) that the tires can bear. For further information on the maximum tire load in kilograms and lbs, see (▷ page 267).

For further information on the load bearing index, see "Load index" (▷ page 267).

**Speed rating:** speed rating ⑥ specifies the approved maximum speed of the tire.

**i** Tire data is vehicle-specific and may deviate from the data in the example.

Regardless of the speed rating, always observe the speed limits. Drive carefully and adapt your driving style to the traffic conditions.

#### Summer tires

| Index      | Speed rating             |
|------------|--------------------------|
| Q          | up to 100 mph (160 km/h) |
| R          | up to 106 mph (170 km/h) |
| S          | up to 112 mph (180 km/h) |
| T          | up to 118 mph (190 km/h) |
| H          | up to 130 mph (210 km/h) |
| V          | up to 149 mph (240 km/h) |
| W          | up to 168 mph (270 km/h) |
| Y          | up to 186 mph (300 km/h) |
| ZR...Y     | up to 186 mph (300 km/h) |
| ZR...(..Y) | over 186 mph (300 km/h)  |
| ZR         | over 149 mph (240 km/h)  |

- Optionally, tires with a maximum design speed of over 149 mph (240 km/h) may have "ZR" in the size description, depending on the manufacturer (e.g. 245/40 ZR 18).

The service specification is made up of load-bearing index ⑤ and speed rating ⑥.

- If the size description of your tire includes "ZR" and there are no service specifications, ask the tire manufacturer in order to find out the maximum design speed.

If a service specification is available, the maximum speed is limited according to the speed rating in the service specification. Example: 245/40 ZR 18 97 Y. In this example, "97 Y" is the service specification. The letter "Y" represents the speed rating. The maximum design speed of the tire is limited to 186 mph (300 km/h).

- The size description for all tires with maximum design speeds of over 186 mph (300 km/h) must include "ZR", **and** the service specification must be given in brackets. Example: 275/40 ZR 18 (99 Y). Speed rating "(Y)" indicates that the maximum design speed of the tire is over 186 mph (300 km/h). To find out the maximum design speed, ask the tire manufacturer.

#### All-weather tires and winter tires

| Index              | Speed rating             |
|--------------------|--------------------------|
| Q M+S <sup>1</sup> | up to 100 mph (160 km/h) |
| T M+S <sup>1</sup> | up to 118 mph (190 km/h) |
| H M+S <sup>1</sup> | up to 130 mph (210 km/h) |
| V M+S <sup>1</sup> | up to 149 mph (240 km/h) |

**i** Not all tires with the M+S marking provide the driving characteristics of winter tires. In addition to the M+S marking, winter tires also have the  snowflake symbol on the tire wall. Tires with this marking fulfill the requirements of the Rubber Manufacturers Association (RMA) and the Rubber Association of Canada (RAC) regarding the tire traction on snow. They have been especially developed for driving on snow.

An electronic speed limiter prevents your vehicle from exceeding a speed of 130 mph (210 km/h).

<sup>1</sup> Or M+S  for winter tires.

The speed rating of tires mounted at the factory may be higher than the maximum design speed permitted by the electronic speed limiter.

Make sure that your tires have the required speed rating, e.g. when buying new tires. The required speed rating for your vehicle can be found in the "Tires" section (▷ page 274).

Further information about reading tire data can be obtained from any qualified specialist workshop.

### Load index



In addition to the load-bearing index, load index ① may also be imprinted on the sidewall of the tire. You will find this after the letter that identifies the speed rating (▷ page 265).

- If no specification is given: no text (as in the example above), represents a standard load (SL) tire
- XL or Extra Load: represents a reinforced tire
- Light Load: represents a light load tire
- C, D, E: represents a load range that depends on the maximum load that the tire can carry at a certain pressure

**i** Tire data is vehicle-specific and may deviate from the data in the example.

### Maximum load rating

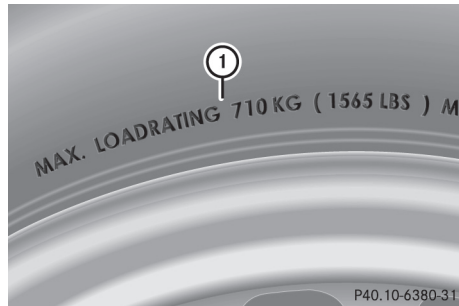

Maximum tire load ① is the maximum permissible weight for which the tire is approved.

Do not overload the tires by exceeding the specified load limit. The maximum permissible load can be found on the vehicle's Tire and Loading Information placard on the B-pillar on the driver's side (▷ page 260).

**i** The actual values for tires are vehicle-specific and may deviate from the values in the illustration.

### DOT, Tire Identification Number (TIN)

US tire regulations stipulate that every tire manufacturer or retreader must imprint a TIN in or on the sidewall of each tire produced.

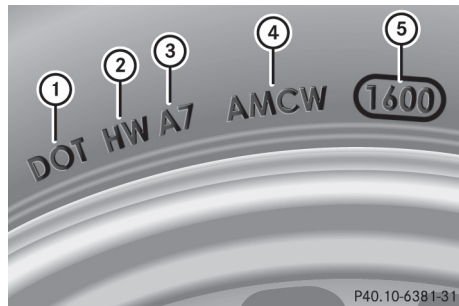

The TIN is a unique identification number. The TIN enables the tire manufacturers or retreaders to inform purchasers of recalls and other safety-relevant matters. It makes it possible for the purchaser to easily identify the affected tires.

The TIN is made up of manufacturer identification code ②, tire size ③, tire type code ④ and manufacturing date ⑤.

**DOT (Department of Transportation):** tire symbol ① marks that the tire complies with the

requirements of the U.S. Department of Transportation.

**Manufacturer identification code:** manufacturer identification code ② provides details on the tire manufacturer. New tires have a code with two symbols. Retreaded tires have a code with four symbols.

For further information about retreaded tires, see (> page 274).

**Tire size:** identifier ③ describes the tire size.

**Tire type code:** tire type code ④ can be used by the manufacturer as a code to describe specific characteristics of the tire.

**Date of manufacture:** date of manufacture ⑤ provides information about the age of a tire. The first and second positions represent the week of manufacture, starting with "01" for the first calendar week. Positions three and four represent the year of manufacture. For example, a tire that is marked "3214" was manufactured in week 32 in 2014.

- i** Tire data is vehicle-specific and may deviate from the data in the example.

### Tire characteristics

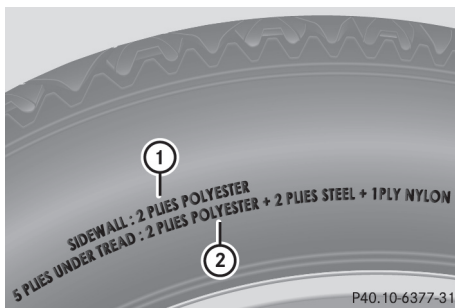

This information describes the type of tire cord and the number of layers in sidewall ① and under tire tread ②.

- i** Tire data is vehicle-specific and may deviate from the data in the example.

### Definition of terms for tires and loading

#### Tire ply composition and material used

Describes the number of plies or the number of layers of rubber-coated fabric in the tire tread and sidewall. These are made of steel, nylon, polyester and other materials.

#### Bar

Metric unit for tire pressure. 14.5038 pounds per square inch (psi) and 100 kilopascals (kPa) are the equivalent of 1 bar.

#### DOT (Department of Transportation)

DOT-marked tires fulfill the requirements of the U S Department of Transportation.

#### Normal occupant weight

The number of occupants for which the vehicle is designed multiplied by 68 kilograms (150 lbs).

#### Uniform Tire Quality Grading Standards

A uniform standard to grade the quality of tires with regards to tread quality, tire traction and temperature characteristics. The quality grading assessment is made by the manufacturer following specifications from the U.S. government. The ratings are molded into the sidewall of the tire.

#### Recommended tire pressures

The recommended tire pressure applies to the tires mounted at the factory.

The Tire and Loading Information placard contains the recommended tire pressures for cold tires on a fully loaded vehicle and for the maximum permissible vehicle speed.

The tire pressure table contains the recommended pressures for cold tires for various operating conditions, i.e. differing load and speed conditions.

#### Increased vehicle weight due to optional equipment

The combined weight of all standard and optional equipment available for the vehicle, regardless of whether it is actually installed on the vehicle or not.

#### Rim

This is the part of the wheel on which the tire is mounted.

#### GAWR (Gross Axle Weight Rating)

The GAWR is the maximum gross axle weight rating. The actual load on an axle must never exceed the gross axle weight rating. The gross axle weight rating can be found on the vehicle identification plate on the B-pillar on the driver's side.

**Speed rating**

The speed rating is part of the tire identification. It specifies the speed range for which the tire is approved.

**GVW (Gross Vehicle Weight)**

The gross vehicle weight includes the weight of the vehicle with fuel, tools, the spare wheel, accessories installed, vehicle occupants, luggage and the drawbar noseweight if applicable. The gross vehicle weight must not exceed the gross vehicle weight rating GVWR as specified on the vehicle identification plate on the B-pillar on the driver's side.

**GVWR (Gross Vehicle Weight Rating)**

The GVWR is the maximum permitted gross weight of the fully laden vehicle (weight of the vehicle including all accessories, vehicle occupants, fuel, luggage and the drawbar noseweight if applicable). The gross vehicle weight rating is specified on the vehicle identification plate on the B-pillar on the driver's side.

**Maximum loaded vehicle weight**

The maximum weight is the sum of:

- the curb weight of the vehicle
- the weight of the accessories
- the load limit
- the weight of the factory installed optional equipment

**Kilopascal (kPa)**

Metric unit for tire pressure. 6.9 kPa corresponds to 1 psi. Another unit for tire pressure is bar. 100 kilopascals (kPa) are the equivalent of 1 bar.

**Load index**

In addition to the load-bearing index, the load index may also be imprinted on the sidewall of the tire. This specifies the load-bearing capacity of the tire more precisely.

**Curb weight**

The weight of a vehicle with standard equipment including the maximum capacity of fuel, oil and coolant. It also includes the air-conditioning system and optional equipment if these are installed in the vehicle, but does not include passengers or luggage.

**Maximum load rating**

The maximum tire load is the maximum permissible weight in kilograms or lbs for which a tire is approved.

**Maximum permissible tire pressure**

Maximum permissible tire pressure for one tire.

**Maximum load on one tire**

Maximum load on one tire. This is calculated by dividing the maximum axle load of one axle by two.

**PSI (pounds per square inch)**

A standard unit of measure for tire pressure.

**Aspect ratio**

Relationship between tire height and tire width in percent.

**Tire pressure**

This is pressure inside the tire applying an outward force to each square inch of the tire's surface. The tire pressure is specified in pounds per square inch (psi), in kilopascal (kPa) or in bar. The tire pressure should only be corrected when the tires are cold.

**Cold tire pressure**

The tires are cold:

- if the vehicle has been parked with the tires out of direct sunlight for at least three hours and
- if the vehicle has not been driven further than 1 mile (1.6 km)

**Tread**

The part of the tire that comes into contact with the road.

**Bead**

The tire bead ensures that the tire sits securely on the wheel. There are several steel wires in the bead to prevent the tire from coming loose from the wheel rim.

**Sidewall**

The part of the tire between the tread and the bead.

**Weight of optional extras**

The combined weight of those optional extras that weigh more than the replaced standard parts and more than 5 lbs (2.3 kg). These optional extras, such as high-performance brakes, level control, a roof rack or a high-voltage battery, are not included in the curb weight and the weight of the accessories.

**TIN (Tire Identification Number)**

This is a unique identifier which can be used by a tire manufacturer to identify tires, for example for a product recall, and thus identify the purchasers. The TIN is made up of the manufacturer's identity code, tire size, tire type code and the manufacturing date.

**Load bearing index**

The load bearing index (also load index) is a code that contains the maximum load bearing capacity of a tire.

**Traction**

Traction is the result of friction between the tires and the road surface.

**Treadwear indicators**

Narrow bars (tread wear bars) that are distributed over the tire tread. If the tire tread is level with the bars, the wear limit of  $\frac{1}{16}$  in (1.6 mm) has been reached.

**Occupant distribution**

The distribution of occupants in a vehicle at their designated seating positions.

**Total load limit**

Nominal load and luggage load plus 68 kg (150 lbs) multiplied by the number of seats in the vehicle.

**Changing a wheel****Flat tire**

The "Breakdown assistance" section (> page 240) contains information and notes on how to deal with a flat tire.

**Rotating the wheels****⚠ WARNING**

Interchanging the front and rear wheels may severely impair the driving characteristics if the wheels or tires have different dimensions. The wheel brakes or suspension components may also be damaged. There is a risk of accident.

Rotate front and rear wheels only if the wheels and tires are of the same dimensions.

**!** On vehicles equipped with a tire pressure monitor, electronic components are located in the wheel.

Tire-mounting tools should not be used near the valve. This could damage the electronic components.

Only have tires changed at a qualified specialist workshop.

Always observe the instructions and safety notes in the "Mounting a wheel" section (> page 271).

The wear patterns on the front and rear tires differ, depending on the operating conditions. Rotate the wheels before a clear wear pattern has formed on the tires. Front tires typically wear more on the shoulders and the rear tires in the center.

On vehicles that have the same size front and rear wheels, you can rotate the wheels according to the intervals in the tire manufacturer's warranty book in your vehicle documents. If no warranty book is available, the tires should be rotated every 3,000 to 6,000 miles (5,000 to 10,000 km). Depending on tire wear, this may be required earlier. Do not change the direction of wheel rotation.

Clean the contact surfaces of the wheel and the brake disc thoroughly every time a wheel is rotated. Check the tire pressure and reactivate the tire pressure monitor if necessary.

**Direction of rotation**

Tires with a specified direction of rotation have additional benefits, e.g. if there is a risk of hydroplaning. These advantages can only be gained if the tires are installed corresponding to the direction of rotation.



An arrow on the sidewall of the tire indicates its correct direction of rotation.

## Storing wheels

Store wheels that are not being used in a cool, dry and preferably dark place. Protect the tires from oil, grease, gasoline and diesel.

## Mounting a wheel

### Preparing the vehicle

- ▶ Stop the vehicle on solid, non-slippery and level ground.
- ▶ Apply the electric parking brake manually.
- ▶ Bring the front wheels into the straight-ahead position.
- ▶ Shift the transmission to position **P**.
- ▶ Switch off the engine.
- ▶ **With KEYLESS-GO start function or vehicles with KEYLESS-GO:** open the driver's door.

The vehicle electronics are now in key position **0**. This is the same as the SmartKey having been removed.

or

- ▶ Remove the SmartKey from the ignition lock.
- ▶ If included in the vehicle equipment, remove the tire-change tool kit from the vehicle.
- ▶ Safeguard the vehicle against rolling away.

### Securing the vehicle to prevent it from rolling away

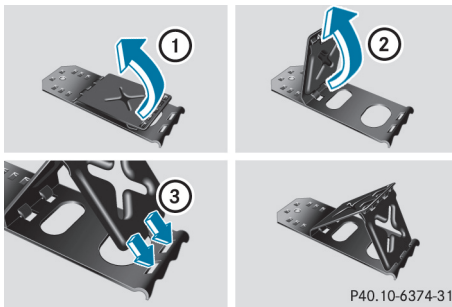

If your vehicle is equipped with a wheel chock, it can be found in the tire-change tool kit (▶ page 239).

The folding wheel chock is an additional safety measure to prevent the vehicle from rolling away, for example when changing a wheel.

- ▶ Fold both plates up ①.
- ▶ Fold out lower plate ②.
- ▶ Guide the lugs on the lower plate fully into the openings in base plate ③.

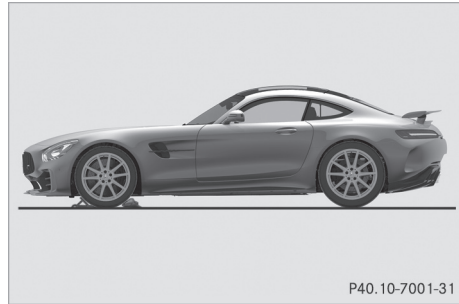

P40.10-7001-31

- ▶ Place chocks or other suitable items under the front and rear of the wheel that is diagonally opposite the wheel you wish to change.

### Raising the vehicle

#### WARNING

If you do not position the jack correctly at the appropriate jacking point of the vehicle, the jack could tip over with the vehicle raised. There is a risk of injury.

Only position the jack at the appropriate jacking point of the vehicle. The base of the jack must be positioned vertically, directly under the jacking point of the vehicle.

- ! Only position the jack at the appropriate jacking point of the vehicle. Otherwise, you could damage the vehicle.

#### Observe the following when raising the vehicle:

- To raise the vehicle, only use the vehicle-specific jack that has been tested and approved by Mercedes-Benz. If used incorrectly, the jack could tip over with the vehicle raised.
- The jack is designed only to raise and hold the vehicle for a short time while a wheel is being changed. It must not be used for performing maintenance work under the vehicle.
- Avoid changing the wheel on uphill and downhill slopes.



- ▶ Before raising the vehicle, secure it from rolling away by applying the parking brake and inserting wheel chocks. Do not disengage the parking brake while the vehicle is raised.
- ▶ The jack must be placed on a firm, flat and non-slip surface. On a loose surface, a large, flat, load-bearing underlay must be used. On a slippery surface, a non-slip underlay must be used, e.g. rubber mats.
- ▶ Do not use wooden blocks or similar objects as a jack underlay. Otherwise, the jack will not be able to achieve its load-bearing capacity due to the restricted height.
- ▶ Make sure that the distance between the underside of the tires and the ground does not exceed 1.2 in (3 cm).
- ▶ Do not place your hands or feet under the raised vehicle.
- ▶ Do not lie under the vehicle.
- ▶ Do not start the engine when the vehicle is raised.
- ▶ Never open or close a door or the tailgate when the vehicle is raised.
- ▶ Make sure that no persons are present in the vehicle when the vehicle is raised.

**Vehicles with hub caps:** the hub cap covers the wheel bolts. Before you can unscrew the wheel bolts, you must remove the hub cap.

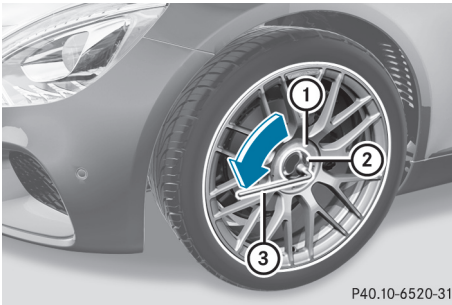

- ▶ **To remove:** take socket (2) and lug wrench (3) from the vehicle tool kit (▶ page 239).
- ▶ Position socket (2) on hub cap (1).
- ▶ Position lug wrench (3) on socket (2).
- ▶ Using lug wrench (3), turn hub cap (1) counter-clockwise and remove it.
- ▶ **To install:** before installing, check hub cap (1) and the wheel area for soiling and clean if necessary.
- ▶ Put hub cap (1) in position and turn until it is in the right position.

- ▶ Position socket (2) on hub cap (1).
- ▶ Attach lug wrench (3) to socket (2) and tighten hub cap (1).

The tightening torque must be **18 lb-ft (25 Nm)**.

- ▶ **Note** that the hub cap should be tightened to the specified torque of **18 lb-ft (25 Nm)**. Mercedes-Benz recommends that you have the hub cap installed at a qualified specialist workshop.

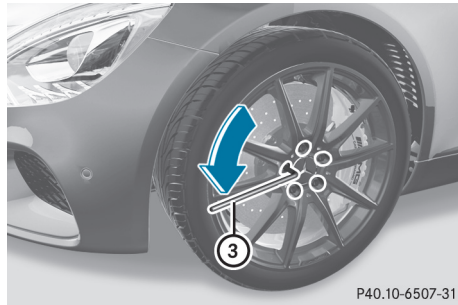

- ▶ Using lug wrench (3), loosen the bolts on the wheel you wish to change by about one full turn. Do not unscrew the bolts completely.

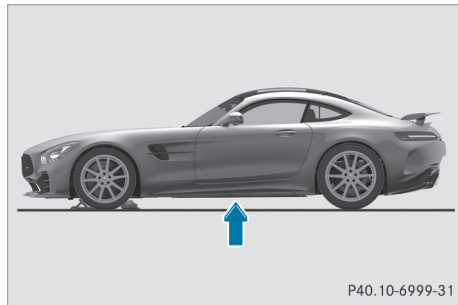

The jacking point is centered between the front and rear wheel arches (arrow).

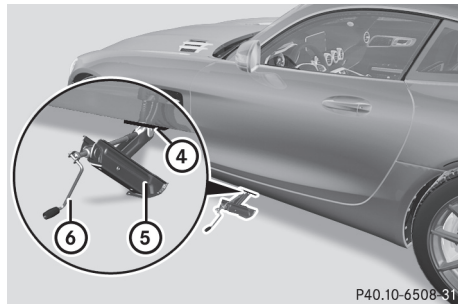

- ▶ Position jack ⑤ at jacking point ④.

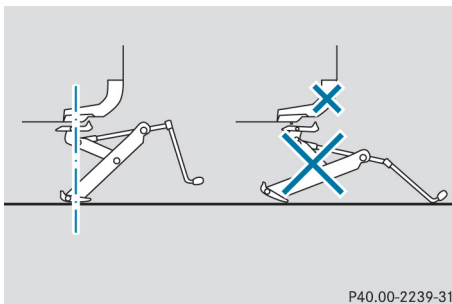

P40.00-2239-31

- ▶ Make sure that the base of the jack is positioned directly under the jacking point.
- ▶ Turn crank ⑥ clockwise until jack ⑤ sits completely on jacking point ④ and the base of the jack lies evenly on the ground.
- ▶ Turn crank ⑥ until the tire is raised a maximum of 1.2 in (3 cm) off the ground.

## Removing a wheel

**!** AMG ceramic high performance composite brake system:

When detaching or attaching the wheel, the wheel rim may hit against the ceramic brake disc and damage it.

Proceed with caution and seek the assistance of a second person.

**!** Do not place wheel bolts in sand or on a dirty surface. The bolt and wheel hub threads could otherwise be damaged when you screw them in.

When mounting/removing wheels, and for as long as the wheels are removed, avoid applying any external force on the brake disks. This could impair the level of comfort when braking.

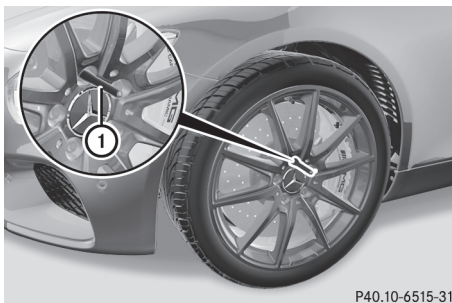

P40.10-6515-31

- ▶ Unscrew the uppermost wheel bolt completely.
- ▶ Screw alignment bolt ① into the thread instead of the wheel bolt.
- ▶ Unscrew the remaining wheel bolts fully.
- ▶ Remove the wheel.

## Mounting a new wheel

### **⚠ WARNING**

Oiled or greased wheel bolts or damaged wheel bolts/hub threads can cause the wheel bolts to come loose. As a result, you could lose a wheel while driving. There is a risk of accident.

Never oil or grease wheel bolts. In the event of damage to the threads, contact a qualified specialist workshop immediately. Have the damaged wheel bolts or hub threads replaced/renewed. Do not continue driving.

### **⚠ WARNING**

If you tighten the wheel bolts or wheel nuts when the vehicle is raised, the jack could tip over. There is a risk of injury.

Only tighten the wheel bolts or wheel nuts when the vehicle is on the ground.

Always pay attention to the instructions and safety notes in the "Changing a wheel" section (> page 270).

Only use wheel bolts that have been designed for the wheel and the vehicle. For safety reasons, Mercedes-Benz recommends that you only use wheel bolts which have been approved for Mercedes-Benz vehicles and the respective wheel.

**!** AMG ceramic high performance composite brake system:

When detaching or attaching the wheel, the wheel rim may hit against the ceramic brake disc and damage it.

Proceed with caution and seek the assistance of a second person.

**!** To prevent damage to the paintwork, hold the wheel securely against the wheel hub while screwing in the first wheel bolt.

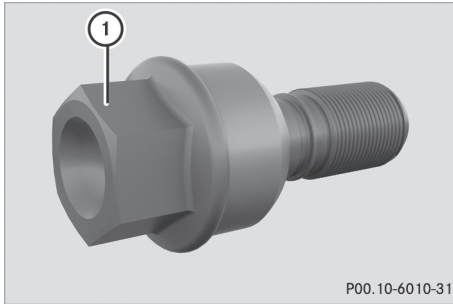

P00.10-6010-31

① Wheel bolt

- ▶ Clean the wheel and wheel hub contact surfaces.



P40.10-6510-31

- ▶ Slide the wheel to be mounted onto the alignment bolt and push it on.

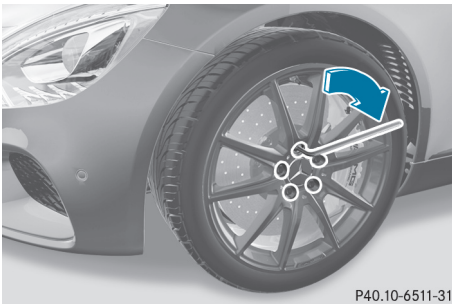

P40.10-6511-31

- ▶ Tighten the wheel bolts until they are finger-tight.
- ▶ Unscrew the alignment bolt.
- ▶ Tighten the last wheel bolt until it is finger-tight.

## Lowering the vehicle

### ⚠ WARNING

The wheels could work loose if the wheel nuts and bolts are not tightened to the specified tightening torque. There is a risk of accident. Have the tightening torque immediately checked at a qualified specialist workshop after a wheel is changed.

- ▶ Turn the crank of the jack counter-clockwise until the vehicle is once again standing firmly on the ground.
- ▶ Place the jack to one side.

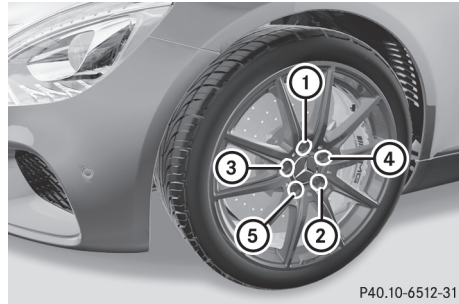

P40.10-6512-31

- ▶ Tighten the wheel bolts evenly in a crosswise pattern in the sequence indicated (① to ⑤). The specified tightening torque is **133 lb-ft (180 Nm)**.
- ▶ Turn the jack back to its initial position.
- ▶ Stow the jack and the rest of the tire-change tool kit in the cargo compartment again.
- ▶ Check the tire pressure of the newly mounted wheel and adjust it if necessary. Observe the recommended tire pressure (▷ page 255).

When you are driving with the emergency spare wheel mounted, the tire pressure monitor cannot function reliably. Only restart the tire pressure monitor when the defective wheel has been replaced with a new wheel. All wheels mounted must be equipped with functioning sensors.

## Wheel and tire combinations

You can obtain information regarding permitted wheel/tire combinations at a qualified specialist workshop.

**!** For safety reasons, Mercedes-Benz recommends that you only use tires and wheels which have been approved by Mercedes-Benz specifically for your vehicle.

These tires have been specially adapted for use with the control systems, such as ABS or ESP®, and are marked as follows:

- MO = Mercedes-Benz Original
- MOE = Mercedes-Benz Original Extended (tires featuring run-flat characteristics)
- MO1 = Mercedes-Benz Original (only certain AMG tires)

Mercedes-Benz Original Extended tires may only be used on wheels that have been specifically approved by Mercedes-Benz.

Only use tires, wheels or accessories tested and approved by Mercedes-Benz. Certain characteristics, e.g. handling, vehicle noise emissions or fuel consumption, may otherwise be adversely affected. In addition, when driving with a load, tire dimension variations could cause the tires to come into contact with the bodywork and axle components. This could result in damage to the tires or the vehicle.

Mercedes-Benz accepts no liability for damage resulting from the use of tires, wheels or accessories other than those tested and approved.

Information on tires, wheels and approved combinations can be obtained from any qualified specialist workshop.

**!** Retreaded tires are neither tested nor recommended by Mercedes-Benz, since previous damage cannot always be detected on retreaded tires. As a result, Mercedes-Benz cannot guarantee vehicle safety if retreaded tires are mounted. Do not mount used tires if you have no information about their previous usage.

The recommended pressures for various operating conditions can be found:

- on the Tire and Loading Information placard on the B-pillar on the driver's side
- in the tire pressure table in the fuel filler flap

Observe the notes on recommended tire pressures under various operating conditions (▷ page 255).

Check tire pressures regularly, and only when the tires are cold. Comply with the maintenance

recommendations of the tire manufacturer in the vehicle document wallet.

Notes on equipping the vehicle:

- Always mount tires of the same size across an axle (left/right)
- Always mount the same type of tires on all wheels at a given time (summer tires, winter tires)

Exception: it is permissible to install a different type or make in the event of a flat tire.

### Information regarding technical data

**i** The data stated here specifically refers to a vehicle with standard equipment. Consult an authorized Mercedes-Benz Center for the data for all vehicle variants and trim levels.

### Vehicle electronics

#### Tampering with the engine electronics

**!** Only have work carried out on the engine electronics and its associated parts, such as control units, sensors, actuating components and connector leads, at a qualified specialist workshop. Vehicle components may otherwise wear more quickly and the vehicle's operating permit may be invalidated.

#### Installing two-way radios and mobile phones (RF transmitters)

If you have questions about the installation of RF transmitters, consult an authorized Mercedes-Benz Center.

#### **⚠** WARNING

The electromagnetic radiation from modified or incorrectly retrofitted RF-transmitters can interfere with the vehicle electronics. This can compromise the operational safety of the vehicle. There is a risk of an accident.

You should have all work to electrical and electronic equipment carried out at a qualified specialist workshop.

#### **⚠** WARNING

The electromagnetic radiation from incorrectly operated RF transmitters can interfere with the vehicle electronics, for example:

- if the RF transmitter is not connected with an exterior antenna
- the exterior antenna has been installed incorrectly or is not a low-reflection type

This can compromise the operational safety of the vehicle. There is a risk of an accident.

Have the low-reflection exterior antenna mounted at a qualified specialist workshop. When operating RF transmitters in the vehicle, always connect them with the low-reflection exterior antenna.

**!** The operating permit may be invalidated if the instructions for installation and use of RF transmitters are not observed.

Excessive levels of electromagnetic radiation may cause damage to your health and the health of others. Using an exterior antenna takes into account current scientific discussions relating to the possible health hazards that may result from electromagnetic fields.

The following can be used in the vehicle without restrictions:

- RF transmitters with a maximum transmission output of up to 100 mW
- Mobile phones (2G/3G/4G)

### Identification plates

#### Vehicle identification plate with vehicle identification number (VIN)

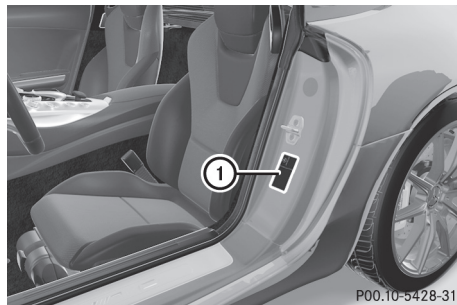

P00.10-5428-31

- ▶ Open the driver's door. You will see vehicle identification plate ①.



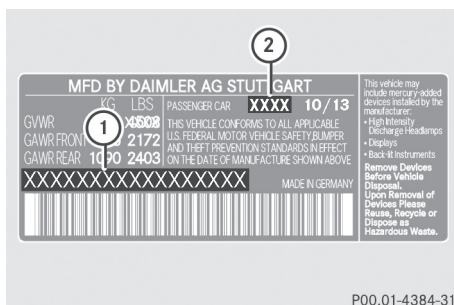

Example: vehicle identification plate (USA only)

- ① VIN
- ② Vehicle model

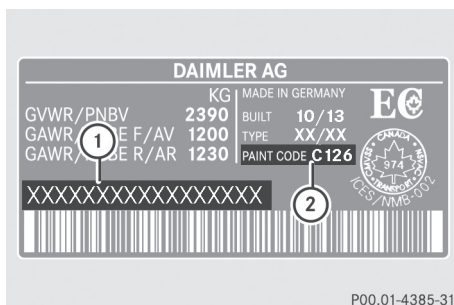

Example: vehicle identification plate (Canada only)

- ① VIN
- ② Paint code

**i** The data shown on the vehicle identification plate is used only as an example. This data is different for every vehicle and can deviate from the data shown here. You can find the data applicable to your vehicle on the vehicle identification plate.

### Vehicle identification number (VIN)

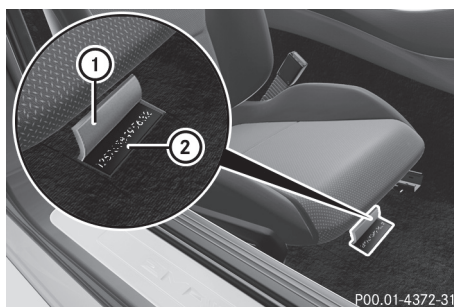

- ▶ Slide the right-hand front seat to its rearmost position.
- ▶ Fold floor covering ① upwards. You will see VIN ②.

The VIN can be found on the vehicle identification plate (▷ page 276).

The VIN can also be found at the lower edge of the windshield (▷ page 277).

### Engine number

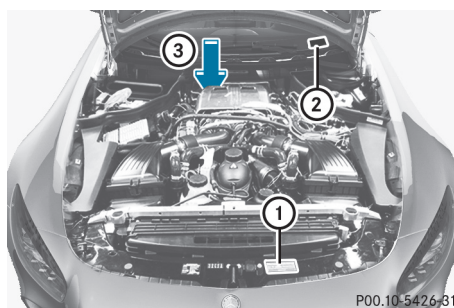

- ① Emission control information plate, including the certification of both federal and Californian emissions standards
- ② VIN (on the lower edge of the windshield)
- ③ Engine number (stamped into the crankcase)

### Service products and filling capacities

#### Important safety notes

#### **⚠ WARNING**

Service products may be poisonous and hazardous to health. There is a risk of injury. Comply with instructions on the use, storage and disposal of service products on the labels of the respective original containers. Always store service products sealed in their original containers. Always keep service products out of the reach of children.

#### **♻ Environmental note**

Dispose of service products in an environmentally responsible manner.

Service products include the following:

- Fuels
- Lubricants (e.g. engine oil, transmission oil)
- Coolant
- Brake fluid
- Windshield washer fluid
- Climate control system refrigerant

Components and service products must match. Only use products recommended by Mercedes-Benz. Damage which is caused by the use of products which have not been recommended is not covered by the Mercedes-Benz warranty or goodwill gestures. They are listed in this Mercedes-Benz Operator's Manual in the appropriate section.

Information on tested and approved products can be obtained at an authorized Mercedes-Benz Center or on the Internet at <http://bevo.mercedes-benz.com>.

You can recognize service products approved by Mercedes-Benz by the following inscription on the containers:

- MB-Freigabe (e.g. MB-Freigabe 229.51)
- MB-Approval (e.g. MB-Approval 229.51)

Other designations or recommendations indicate a level of quality or a specification in accordance with an MB Sheet Number (e.g. MB 229.5). They have not necessarily been approved by Mercedes-Benz.

Other identifications, for example:

- 0 W-30
- 5 W-30
- 5 W-40

## Fuel

### Important safety notes

#### WARNING

Fuel is highly flammable. If you handle fuel incorrectly, there is a risk of fire and explosion.

You must avoid fire, open flames, creating sparks and smoking. Switch off the engine and, if applicable, the auxiliary heating before refueling.

#### WARNING

Fuel is poisonous and hazardous to health. There is a risk of injury.

You must make sure that fuel does not come into contact with your skin, eyes or clothing and that it is not swallowed. Do not inhale fuel vapors. Keep fuel away from children.

If you or others come into contact with fuel, observe the following:

- Wash away fuel from skin immediately using soap and water.
- If fuel comes into contact with your eyes, immediately rinse them thoroughly with clean water. Seek medical assistance without delay.
- If fuel is swallowed, seek medical assistance without delay. Do not induce vomiting.
- Immediately change out of clothing which has come into contact with fuel.

### Tank capacity

| Model      | Total capacity          |
|------------|-------------------------|
| All models | 19.8 US gal<br>(75.0 l) |

| Model      | Of which reserve                  |
|------------|-----------------------------------|
| All models | Approx.<br>3.2 US gal<br>(12.0 l) |

### Gasoline

#### Fuel grade

- ❗ Do not use diesel to refuel vehicles with a gasoline engine. Do not switch on the ignition if you accidentally refuel with the wrong fuel. Otherwise, the fuel will enter the fuel system. Even small amounts of the wrong fuel could result in damage to the fuel system and the engine. Notify a qualified specialist workshop and have the fuel tank and fuel lines drained completely.



**!** Only refuel using unleaded premium grade gasoline with at least 91 AKI/95 RON.

**i** E10 fuel contains up to 10% bioethanol. Your vehicle is E10-compatible. You can refuel your vehicle using E10 fuel.

**!** Only use the fuel recommended. Operating the vehicle with other fuels can lead to damage to the fuel system, engine and exhaust system.

**!** Do not use the following:

- Gasoline with more than 10% ethanol
- E100 (100% ethanol)
- Gasoline with methanol
- M100 (100% methanol)
- Gasoline with metalliferous additives
- Diesel

Do not mix such fuels with the fuel recommended for your vehicle.

**!** To ensure the longevity and full performance of the engine, only premium-grade unleaded gasoline must be used.

If standard unleaded gasoline is unavailable and you have to refuel with unleaded gasoline of a lower grade, observe the following precautions:

- Only fill the fuel tank to half full with regular unleaded gasoline and fill the rest with premium-grade unleaded gasoline as soon as possible.
- Do not drive at the maximum speed.
- Avoid sudden acceleration and engine speeds over 3,000 rpm.

Reformulated Gasoline (RFG) and/or unleaded gasoline with additives can be used. The concentration of additives in the fuel, however, must not exceed 10%, for example:

- Ethanol
- TAME
- ETBE
- IPA
- TBA

For MTBE, the concentration should not exceed 15%.

The concentration of methanol in gasoline, including other additives, must not exceed 3%.

All of these blends must fulfill the fuel requirements, for example:

- knock resistance
- boiling point
- vapor pressure

You will usually find information about the fuel grade on the fuel pump. If you cannot find the label on the fuel pump, ask the gas station staff.

**i** For further information, consult a qualified specialist workshop or visit <http://www.mbusa.com> (USA only).

Information on refueling (▷ page 117).

### Additives

**!** Operating the engine with fuel additives added later can lead to engine failure. Do not mix fuel additives with fuel. This does not include additives for the removal and prevention of residue buildup. Gasoline must only be mixed with additives recommended by Mercedes-Benz. Comply with the instructions for use on the product label. More information about recommended additives can be obtained from any authorized Mercedes-Benz Center.

Mercedes-Benz recommends that you use branded fuels that have additives.

The fuel quality available in some countries may not be sufficient. Residue could build up in the fuel injection system as a result. In such cases, and in consultation with an authorized Mercedes-Benz Center, the fuel may be mixed with the cleaning additive recommended by Mercedes-Benz. You must observe the notes and mixing ratios specified on the container.

## Engine oil

### General notes



**!** Do not use engine oil or an oil filter with specifications deviating from those expressly required for the prescribed service intervals. Do not change the engine oil or oil filter in order to set replacement intervals longer than those prescribed. This could otherwise cause damage to the engine or exhaust gas after-treatment.

Follow the instructions on the service interval display for changing the engine oil. This could otherwise cause damage to the engine or exhaust gas aftertreatment.

When handling engine oil, observe the important safety notes on service products (> page 277). The engine oils are matched to the performance of Mercedes-Benz engines and service intervals. You should therefore only use engine oils and oil filters that are approved for vehicles with maintenance systems.

For a list of approved engine oils and oil filters, consult an authorized Mercedes-Benz Center. Or visit the website <http://bevo.mercedes-benz.com>.

The table shows which engine oils have been approved for your vehicle.

|            | MB-Freigabe or MB-Approval |
|------------|----------------------------|
| All models | 229.5, 229.51              |

**i** MB approval is indicated on the oil containers.

### Filling capacities

The following values refer to an oil change including the oil filter.

|            | Capacity          |
|------------|-------------------|
| All models | 7.4 US qt (7.0 l) |

### Additives

**!** Do not use any additives in the engine oil. This could damage the engine.

### Brake fluid

#### **⚠** WARNING

The brake fluid constantly absorbs moisture from the air. This lowers the boiling point of the brake fluid. If the boiling point of the brake fluid is too low, vapor pockets may form in the brake system when the brakes are applied hard. This would impair braking efficiency. There is a risk of an accident.

You should have the brake fluid renewed at the specified intervals.

Comply with the important safety notes for service products when handling brake fluid (> page 277).

Only use brake fluid approved by Mercedes-Benz in accordance with MB-Freigabe or MB-Approval 331.0.

Information about approved brake fluid can be obtained at any qualified specialist workshop or on the Internet at <http://bevo.mercedes-benz.com>.

**i** Have the brake fluid regularly replaced at a qualified specialist workshop in accordance with the replacement intervals and the replacement confirmed in the service report.

## Coolant

### Important safety notes

#### WARNING

If antifreeze comes into contact with hot components in the engine compartment, it may ignite. There is a risk of fire and injury.

Let the engine cool down before you add antifreeze. Make sure that antifreeze is not spilled next to the filler neck. Thoroughly clean the antifreeze from components before starting the engine.

**!** Only add coolant that has been premixed with the desired antifreeze protection. You could otherwise damage the engine.

Further information on coolants can be found in the Mercedes-Benz Specifications for Service Products, MB BeVo 3 10. 1, e.g. on the Internet at <http://bevo.mercedes-benz.com>. Or contact a qualified specialist workshop.

**!** Always use a suitable coolant mixture, even in countries where high temperatures prevail. Otherwise, the engine cooling system is not sufficiently protected from corrosion and overheating.

**i** Have the coolant regularly replaced at a qualified specialist workshop and the replacement confirmed in the service report.

Comply with the important safety notes for service products when handling coolant (▷ page 277).

The coolant is a mixture of water and antifreeze/corrosion inhibitor. It performs the following tasks:

- Anti-corrosion protection
- Antifreeze protection
- Raising the boiling point

If the coolant has antifreeze protection down to -35 °F (-37 °C), the boiling point of the coolant during operation is approximately 266 °F (130 °C).

The antifreeze concentrate/corrosion inhibitor concentration in the engine cooling system should:

- be at least 50%. This will protect the engine cooling system against freezing down to approximately -35 °F (-37 °C).
- not exceed 55% (antifreeze protection down to -49 °F [-45 °C]). Otherwise, heat will not be dissipated as effectively.

Mercedes-Benz recommends an antifreeze/corrosion inhibitor concentrate in accordance with MB Specifications for Service Products 3 10. 1.

The coolant is checked with every maintenance interval at a qualified specialist workshop.

**i** When the vehicle is first delivered, it is filled with a coolant mixture that ensures adequate antifreeze and anti-corrosion protection.

**i** The coolant is checked at specified intervals at a qualified specialist workshop.

### Filling capacities

| Model             | Capacity            |
|-------------------|---------------------|
| Mercedes-AMG GT R | 14.0 US qt (13.3 l) |

## Windshield washer system

### Important safety notes

#### WARNING

Windshield washer concentrate could ignite if it comes into contact with hot engine components or the exhaust system. There is a risk of fire and injury.

Make sure that no windshield washer concentrate is spilled next to the filler neck.

**!** Only use washer fluid that is suitable for plastic lamp lenses, e.g. MB SummerFit or MB WinterFit. Unsuitable washer fluid could damage the plastic lenses of the headlamps.

**!** Only MB SummerFit and MB WinterFit washer fluid should be mixed together. The spray nozzles may otherwise become blocked.

Do not use distilled or de-ionized water. Otherwise, the level sensor may give a false reading.

At temperatures above freezing:

- Fill the washer fluid reservoir with a mixture of water and windshield washer fluid, e.g. MB SummerFit.

Add 1 part MB SummerFit to 100 parts water.

At temperatures below freezing:

- Fill the washer fluid reservoir with a mixture of water and washer fluid, e.g. MB WinterFit.

For the correct mixing ratio refer to the information on the antifreeze reservoir.

- ❗ Add windshield washer fluid, e.g. MB SummerFit or MB WinterFit, to the washer fluid all year round.

### Climate control system refrigerant

#### Important safety notes

The instruction label regarding the refrigerant type used can be found on the radiator cross member. Further information can be found in the currently valid service information.

Service work, such as refilling with refrigerant or replacing component parts, may only be carried out by a qualified specialist workshop. All applicable regulations must be adhered to, SAE standard J639 included.

Always have work on the climate control system carried out at a qualified specialist workshop.

#### Refrigerant instruction label

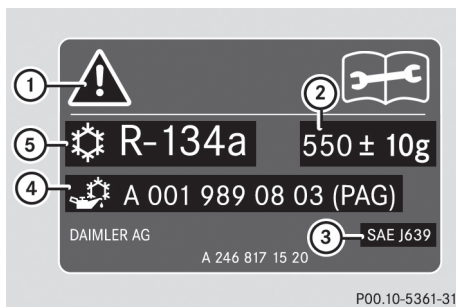

Example: refrigerant instruction label

- ① Warning symbol
- ② Refrigerant filling capacity
- ③ Applicable standards

- ④ PAG oil part number

- ⑤ Type of refrigerant

Warning symbol ① advises you about:

- Possible dangers
- Having service work carried out at a qualified specialist workshop

#### Filling capacities

Missing values were not available at time of going to print.

| Mercedes-AMG GT R | Capacity                      |
|-------------------|-------------------------------|
| Refrigerant       | 22.6 ± 0.4 oz<br>(640 ± 10 g) |
| PAG oil           | 4.2 oz<br>(120 g)             |

### Vehicle data

#### General notes

Please note that for the specified vehicle data:

- The heights specified may vary as a result of:
  - Tires
  - Load
  - Condition of the suspension
  - Optional equipment
- Optional equipment reduces the maximum payload.

#### Dimensions and weights



Missing values were not available at time of going to print.

|                   | ① Height when opened |
|-------------------|----------------------|
| Fixed rear fender | 84.0 in<br>2134 mm   |

Missing values were not available at time of going to print.

| Mercedes-AMG GT R                        |                    |
|--|--------------------|
| Vehicle length                           | 179.7 in (4565 mm) |
| Vehicle width including exterior mirrors | 81.7 in (2075 mm)  |
| Vehicle width without exterior mirrors   | 87.5 in (1996 mm)  |
| Vehicle height                           | 50.5 in (1284 mm)  |
| Wheelbase                                | 103.5 in (2630 mm) |
| Turning radius                           |                    |
| Maximum trunk load                       |                    |

