



#### Digital – in the vehicle

Familiarize yourself with the contents of the Operator's Manual directly via the vehicle's multimedia system (menu item "Vehicle"). Start with the quick guide, discover your vehicle's highlights or broaden your knowledge with useful tips.



#### Vehicle document wallet

Here you can find comprehensive information about operating your vehicle and about services and warranties in printed form.



#### Digital – on the Internet

You can find the Operator's Manual on the Mercedes-Benz homepage.



#### Digital – as an App

The Mercedes-Benz Guides App is available free-of-charge in familiar App stores.



2135844402

Order no. P213 0223 13 Part no. 213 584 44 02  
Edition E-2017 H



Apple® iOS



Android™

E-Class

Mercedes-Benz



## E-Class

Operator's Manual

Mercedes-Benz



## Symbols

In this Operator's Manual, you will find the following symbols:

**⚠ DANGER** Danger due to failure to observe warning notices

Warning notices draw your attention to hazards that may endanger your health or life, or the health or life of others.

▶ Please observe the warning notices in these instructions.

**ℹ ENVIRONMENTAL NOTE** Environmental damage due to failure to observe environmental notes

Environmental notes include information on environmentally responsible behavior or environmentally responsible disposal.



▶ Observe environmental notes.

**ℹ NOTE** Damage to property due to failure to observe notes on material damage

Notes on material damage inform you of risks which may lead to your vehicle being damaged.

▶ Observe notes on material damage.

**ℹ** Useful instructions or further information that could be helpful to you.

- ▶ Instruction
- ( → Page) Further information on a topic
- Display** Information in the multifunction display/multimedia display
-  Highest menu level, which is to be selected in the multimedia system
-  Corresponding submenus, which are to be selected in the multimedia system
- \* Indicates a cause

## Publication details

### Internet

Further information about Mercedes-Benz vehicles and about Daimler AG can be found on the following websites:

<http://www.mbusa.com> (USA only)

<http://www.mercedes-benz.ca> (Canada only)

### Editorial office

©Daimler AG: Not to be reprinted, translated or otherwise reproduced, in whole or in part, without written permission from Daimler AG.

### Vehicle manufacturer

Daimler AG

Mercedesstrasse 137

70327 Stuttgart

Germany

## Welcome to the world of Mercedes-Benz

Before you first drive off, read this Operator's Manual carefully and familiarize yourself with your vehicle. For your own safety and a longer vehicle life, follow the instructions and warning notices in this manual. Disregarding them may lead to damage to the vehicle or personal injury.

Vehicle damage resulting from the instructions being ignored is not covered by the Mercedes-Benz Limited Warranty.

The equipment or product designation of your vehicle may vary according to:

- Model
- Order
- National version
- Availability

Mercedes-Benz reserves the right to introduce changes in the following areas:

- Design
- Equipment
- Technical features

Therefore, the description given may vary in certain cases from the equipment in your vehicle.

The following are integral parts of the vehicle:

- Digital Operator's Manual
- Printed Operator's Manual
- Maintenance Booklet
- Equipment-dependent Supplements

Keep these documents in the vehicle at all times. If you sell the vehicle, always pass all of the documents on to the new owner.

Mercedes-Benz USA, LLC  
Mercedes-Benz Canada, Inc.  
A Daimler Company

2135844402



<b>At a glance</b> .....	6	QR code for rescue card .....	26	Seats .....	82
Cockpit .....	6	Vehicle data storage .....	26	Steering wheel .....	91
Warning and indicator lamps .....	8	Copyright .....	28	Using the memory function .....	93
Overhead control panel .....	12			Stowage areas .....	94
Door control panel and seat adjustment .....	14	<b>Occupant safety</b> .....	<b>30</b>	Cup holder .....	103
Emergencies and breakdowns .....	16	Restraint system .....	30	Ashtray and cigarette lighter .....	105
		Seat belts .....	32	Sockets .....	106
		Airbags .....	37	Wireless charging of the mobile phone and connection with the exterior antenna ..	108
<b>Digital Operator's Manual</b> .....	<b>18</b>	PRE-SAFE® .....	44	Installing/removing floor mats .....	109
Calling up the Digital Operator's Manual .....	18	Children in the vehicle .....	45		
		Pets in the vehicle .....	54	<b>Light and visibility</b> .....	<b>111</b>
				Exterior lighting .....	111
<b>General notes</b> .....	<b>19</b>	<b>Opening and closing</b> .....	<b>55</b>	Interior lighting .....	115
Protecting the environment .....	19	SmartKey .....	55	Windshield wiper and windshield washer system .....	116
Mercedes-Benz GenuineParts .....	19	Doors .....	60	Mirrors .....	119
Operator's Manual .....	20	Trunk .....	63	Operating the sun visors .....	121
Service and vehicle operation .....	21	Roller sun blinds .....	69	Infrared reflective windshield .....	122
Operating safety .....	22	Side windows .....	70		
Declaration of conformity for wireless vehicle components .....	23	Sliding sunroof .....	74		
Diagnostics connection .....	24	Anti-theft protection .....	79		
Qualified specialist workshop .....	25			<b>Climate control</b> .....	<b>123</b>
Correct use of the vehicle .....	25	<b>Seats and stowing</b> .....	<b>81</b>	Overview of climate control systems .....	123
Problems with your vehicle .....	25	Correct driver's seat position .....	81	Operating the climate control system .....	123
Reporting safety defects .....	25				
Limited Warranty .....	26				

<b>Driving and parking</b> .....	<b>128</b>	<b>Multimedia system</b> .....	<b>219</b>	<b>Wheels and tires</b> .....	<b>332</b>
Driving .....	128	Overview and operation .....	219	Noise or unusual handling characteris- tics .....	332
DYNAMIC SELECT switch .....	135	System settings .....	227	Regular checking of wheels and tires .....	332
Automatic transmission .....	136	Navigation .....	235	Notes on snow chains .....	333
Refueling .....	139	Telephone .....	255	Tire pressure .....	333
Parking .....	141	Online and Internet functions .....	269	Loading the vehicle .....	340
Driving and driving safety systems .....	149	Media .....	276	Tire labeling .....	344
		Radio .....	289	Definitions for tires and loading .....	349
		Sound .....	296	Changing a wheel .....	352
<b>Instrument Display and on-board computer</b> .....	<b>195</b>	<b>Maintenance and care</b> .....	<b>299</b>	<b>Technical data</b> .....	<b>362</b>
Instrument display overview .....	195	ASSYST PLUS service interval display .....	299	Notes on technical data .....	362
Overview of the buttons on the steering wheel .....	196	Engine compartment .....	300	Vehicle electronics .....	362
Operating the on-board computer .....	197	Cleaning and care .....	306	Vehicle identification plate, VIN and engine number .....	364
Displays in the multifunction display .....	198			Operating fluids .....	366
Adjusting the instrument lighting .....	199	<b>Breakdown assistance</b> .....	<b>314</b>	Vehicle data .....	372
Menus and submenus .....	199	Emergency .....	314		
Head-up Display .....	206	Flat tire .....	314		
		Battery (vehicle) .....	320		
		Tow starting or towing away .....	325	<b>Display messages and warning/indi- cator lamps</b> .....	<b>374</b>
<b>Voice Control System</b> .....	<b>208</b>	Electrical fuses .....	328	Display messages .....	374
Operating safety .....	208			Warning and indicator lamps .....	417
Operation .....	208				
Using Voice Control System effectively .....	210				
Essential commands .....	210				

## 4 Contents

---

**Index** ..... 435

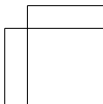
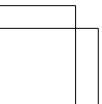
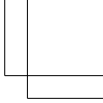
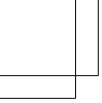

6 At a glance – Cockpit

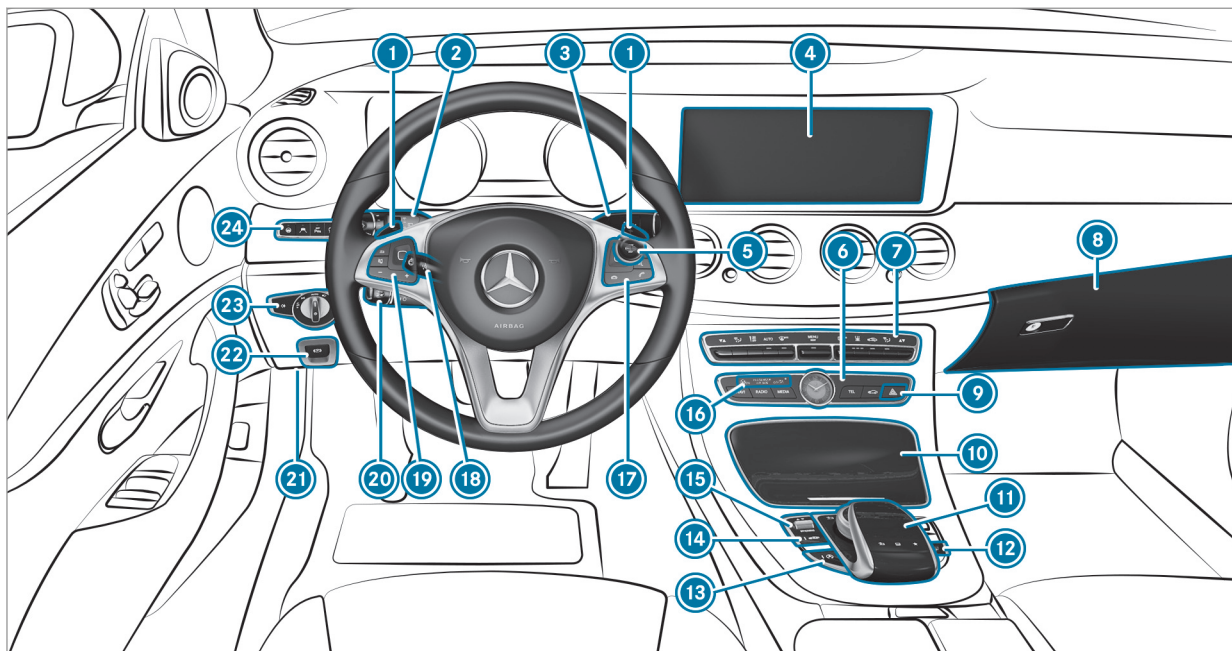





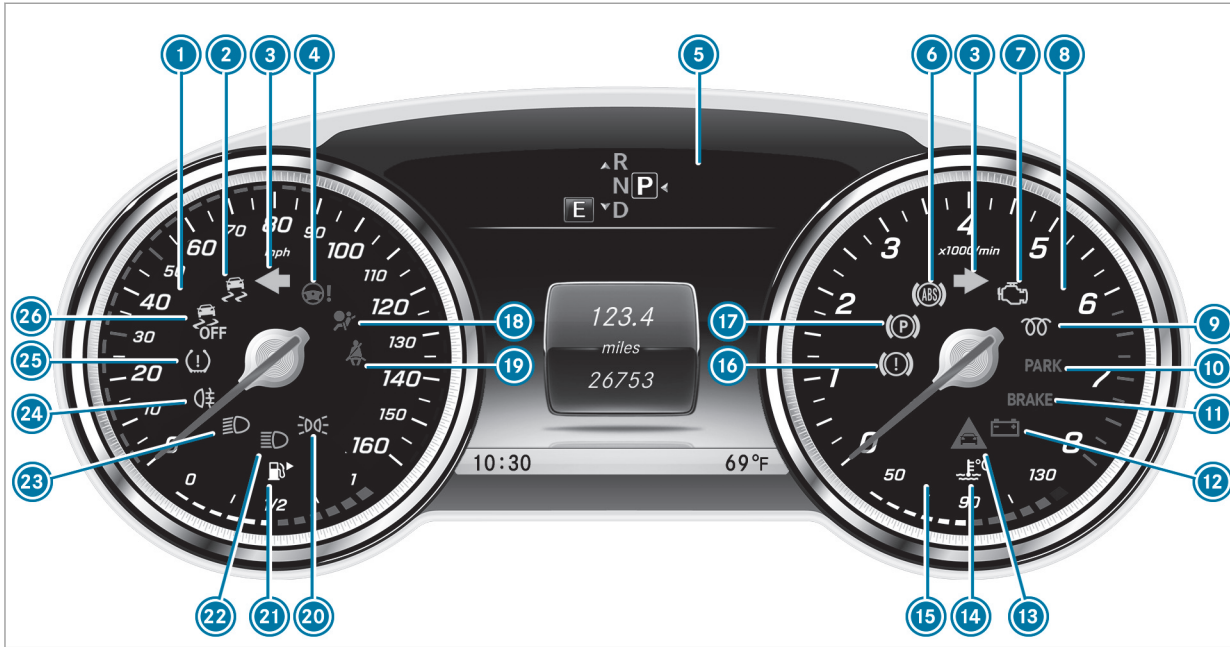





















① Steering wheel gearshift paddle	→	138	⑮ DYNAMIC SELECT switch	→	135
② Combination switch	→	112	⑯ PASSENGER AIR BAG indicator lamp	→	,41
③ DIRECT SELECT lever	→	136	⑰ Control panel for multimedia system	→	196
④ Display (multimedia system)	→	219	⑱ Adjusts the steering wheel	→	92
⑤ Start/Stop button	→	129	⑲ Control panel for on-board computer	→	196
⑥ Control panel for multimedia system	→	219	⑳ Cruise control lever	→	158
⑦ Climate control systems	→	123	㉑ To unlock the hood	→	300
⑧ Glove box	→	96	㉒ Electric parking brake	→	146
⑨ Hazard warning lights	→	113	㉓ Light switch	→	111
⑩ Stowage compartment	→	96	㉔ Control panel for:		
⑪ Controls for the multimedia system	→	219	Steering Pilot	→	168
⑫ Rear window roller sunblind	→	69	Active Lane Keeping Assist	→	193
⑬ ECO start/stop function	→	134	Parking Assist PARKTRONIC	→	174
⑭ To set the vehicle level	→	171	Head-up Display	→	207
Parking Pilot	→	182			









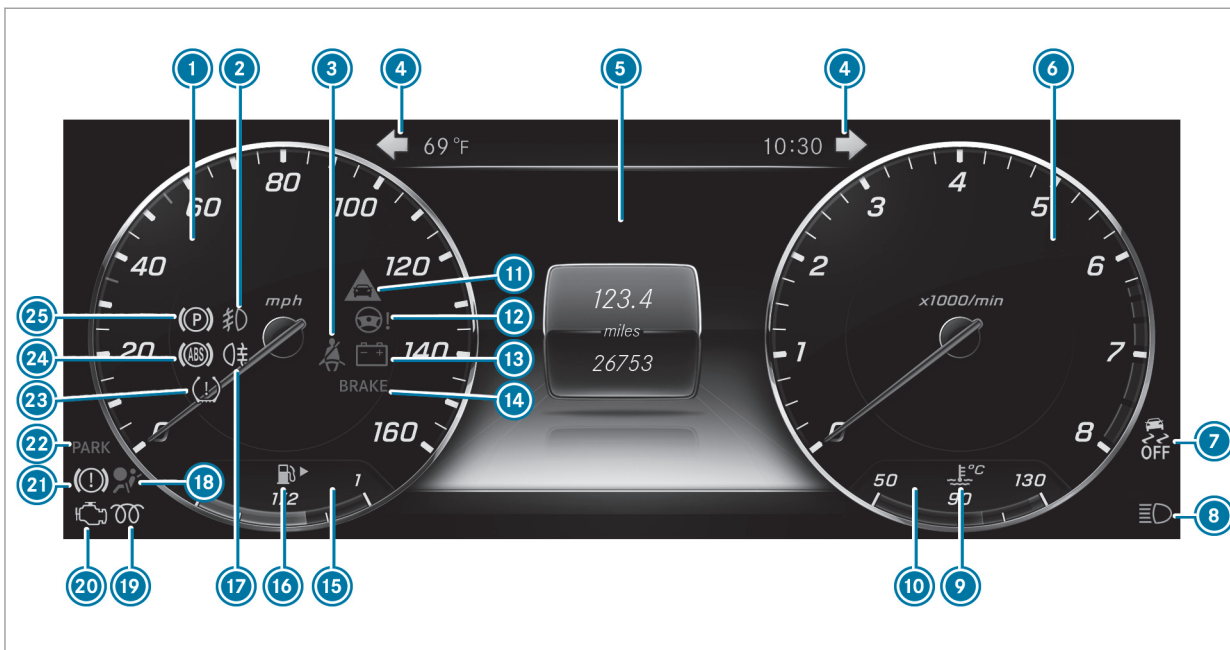





Instrument Display (standard)













1	 Speedometer	→	195
2	 ESP®		
3	 Turn signal light	→	112
4	 Steering assistance malfunction		
5	Multifunction display	→	198
6	 ABS malfunction		
7	 Engine diagnosis		
8	Tachometer	→	195
9	 This indicator lamp has no function		
10	Electric parking brake applied (red)		
	 USA only		
	 Canada only		
11	Brakes (red)		
	 USA only		
	 Canada only		
12	 Electrical malfunction		
13	 Distance warning		
14	 Coolant too hot/cold		
15	Coolant temperature display	→	195
16	 Brakes (yellow)		
17	 Electric parking brake (yellow)		
18	 Restraint system	→	31
19	 Seat belt is not fastened		
20	 Parking lights	→	111
21	Fuel level display		
	 Fuel reserve with fuel filler flap location indicator		
22	 High beam	→	112
23	 Low beam	→	111
24	 Rear fog light	→	112
25	 Tire pressure monitoring system		
26	 ESP® OFF		

10 At a glance - Warning and indicator lamps







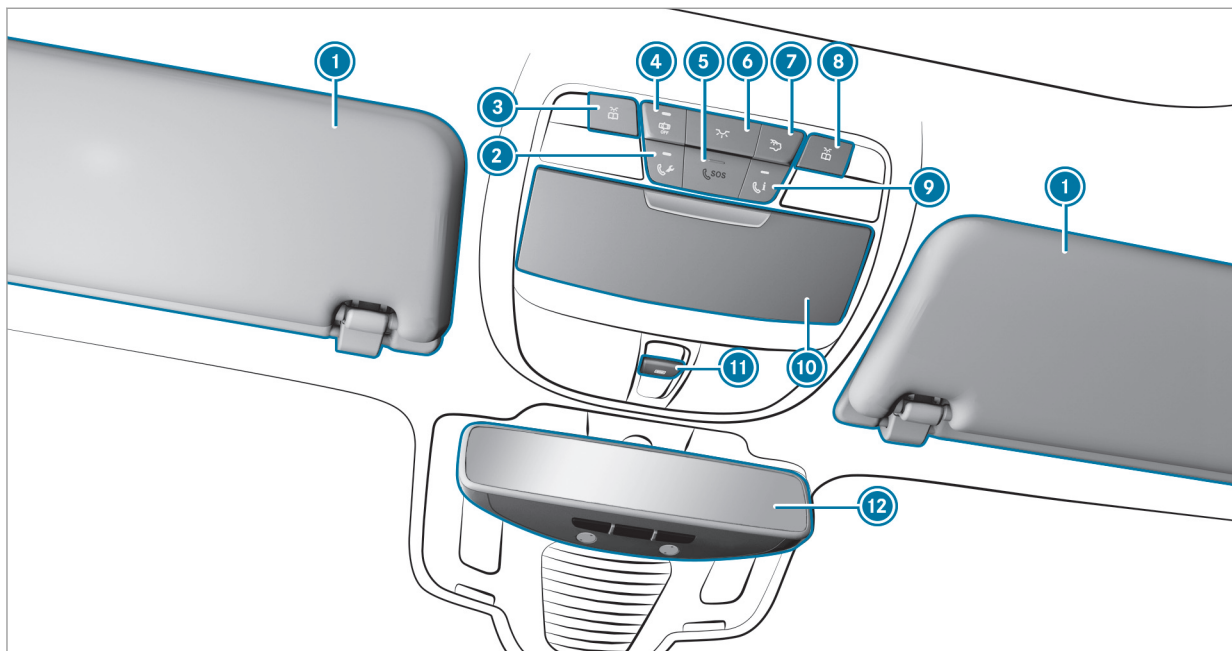

Instrument Display in the Widescreen Cockpit

①	Speedometer	→	195
②	Fog light		
③	 Seat belt is not fastened		
④	  Turn signal light	→	112
⑤	Multifunction display	→	198
⑥	Tachometer	→	195
⑦	 ESP® OFF		
	 ESP®		
⑧	 High beam	→	112
	 Low beam	→	111
	 Parking lights	→	111
⑨	 Coolant too hot/cold		
⑩	Coolant temperature display	→	195
⑪	 Distance warning		
⑫	 Steering assistance malfunction		
⑬	 Electrical malfunction		

⑭	Brakes (red)		
	 USA only		
	 Canada only		
⑮	Fuel level display		
⑯	 Fuel reserve with fuel filler flap location indicator		
⑰	 Rear fog light	→	112
⑱	 Restraint system	→	31
⑲	 This indicator lamp has no function		
⑳	 Engine diagnosis		
㉑	 Brakes (yellow)		
㉒	Electric parking brake applied (red)		
	 USA only		
	 Canada only		
㉓	 Tire pressure monitoring system		
㉔	 ABS malfunction		
㉕	 Electric parking brake (yellow)		

## 12 At a glance - Overhead control panel







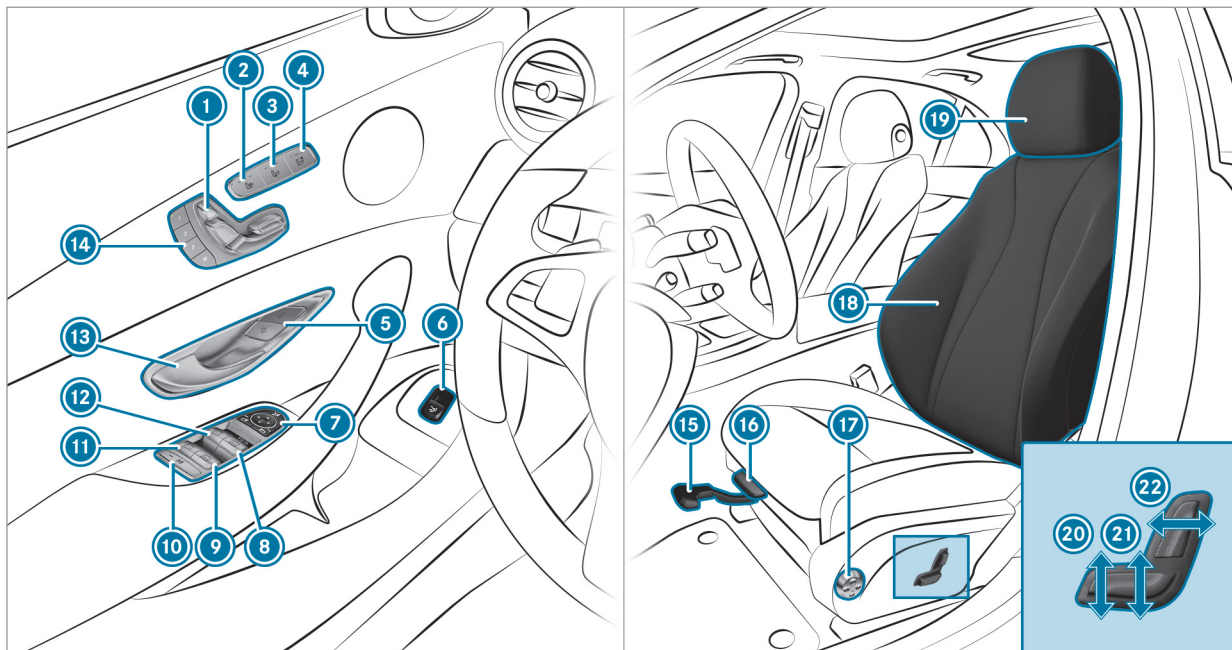

1	Sun visors	→	121	8	 Switches the right-hand reading lamp on/off	→	115
2	Roadside Assistance call button (mbrace®)	→	268	9	MB Info call button (mbrace®)	→	268
3	 Switches the left-hand reading lamp on/off	→	115	10	Eyeglasses box	→	96
4	 Switches the automatic lighting control on/off	→	115	11	 Opens/closes the panoramic sliding sunroof	→	74
5	SOS button (mbrace®)	→	267		Opens/closes the roller sun blinds	→	74
6	 Switches the front interior lighting on/off	→	115	12	Inside mirror	→	120
7	 Switches the rear interior lighting on/off	→	115				

14 At a glance - Door control panel and seat adjustment





①	Adjusts the seats electrically	→	85	⑫	 Opens/closes the left side window	→	70
②	Switches the seat heating on/off	→	90	⑬	Opens the door	→	60
③	Switches the seat ventilation on/off	→	90	⑭	Sets the memory function	→	93
④	Adjusts the front passenger seat from the driver's seat			⑮	Sets the seat fore-and-aft adjustment	→	84
⑤	  Locks/unlocks the vehicle	→	60	⑯	Adjusts the seat cushion length	→	84
⑥	Opens/closes the trunk lid	→	63	⑰	Adjusts the 4-way lumbar support	→	85
⑦	Adjusts and folds the outside mirrors out/in electrically	→	119	⑱	Seat adjustment using the multimedia system	→	87
⑧	 Opens/closes the right side window	→	70	⑲	Adjusts the head restraints	→	85
⑨	 Opens/closes the rear right side window	→	70	⑳	Adjusts the seat cushion inclination	→	84
⑩	Child safety lock for the rear side windows	→	54	㉑	Adjusts the seat height	→	84
⑪	 Opens/closes the rear left side window	→	70	㉒	Adjusts the seat backrest inclination	→	84

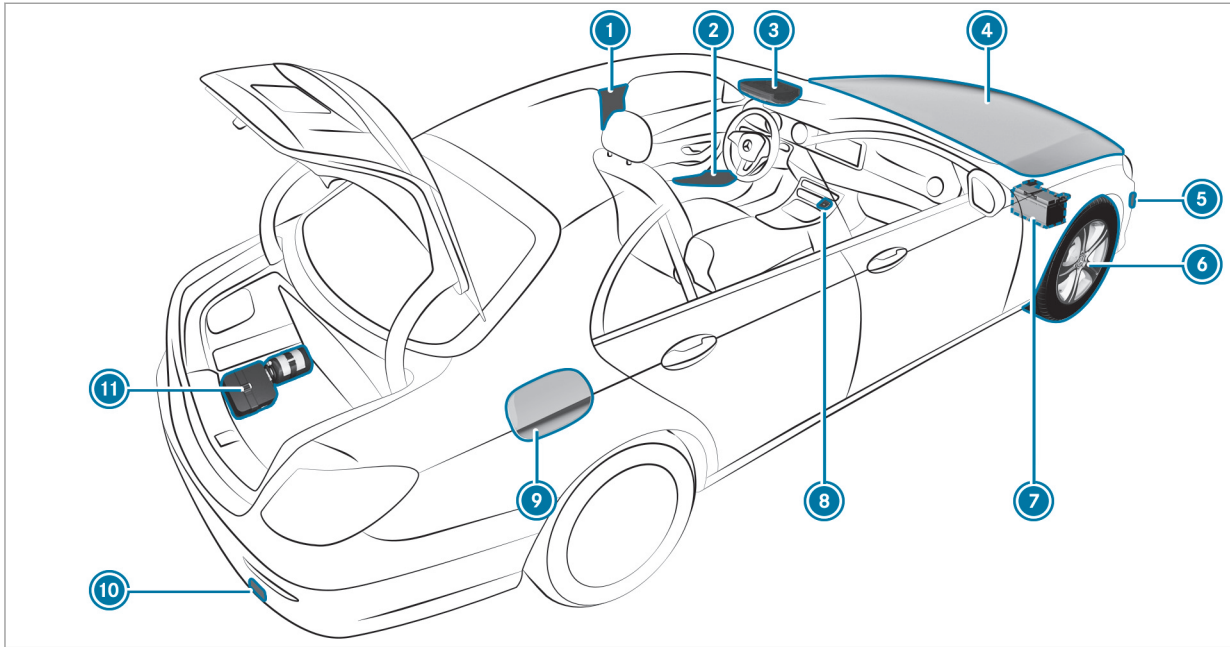

What to do in the event of an accident	
① QR code for accessing the rescue card	→ 26
② Safety vests	→ 314
③ Button for the SOS emergency call system and breakdown assistance	→ 267
④ Checking and topping up operating fluids	→ 366
⑤ Tow-starting and towing away	→ 325
⑥ Flat tire	→ 314

⑦ Starting assistance	→ 322
⑧ Hazard warning lights	→ 113
⑨ Fuel filler flap with instruction labels for tire pressure, fuel type and QR code for accessing the rescue card	→ 139
⑩ Tow-starting and towing away	→ 325
⑪ TIREFIT kit	→ 316

## Calling up the Digital Operator's Manual

Multimedia system:

→ Vehicle → ⓘ Operator's Manual



▶ Select a menu item.

In addition, you can also call up the Operator's Manual within a main function (e.g. via [Info on Phone](#)).

The Digital Operator's Manual describes the function and operation of:

- The vehicle
- The multimedia system

For safety reasons, the Digital Operator's Manual is deactivated while driving.

The Digital Operator's Manual contains the following menu items:

- **Search:** Allows you to search precisely for keywords.
- **Quick start:** Provides you with important information so that you can start using your vehicle immediately.
- **Tips:** Provides tips on how to use your vehicle in certain situations.
- **Highlights:** Shows you vehicle highlights using pictures and animations.
- **Messages:** Provides you with further information about the messages in the instrument cluster.
- **Bookmarks:** Provides you with a list of all the bookmarks you have stored yourself.

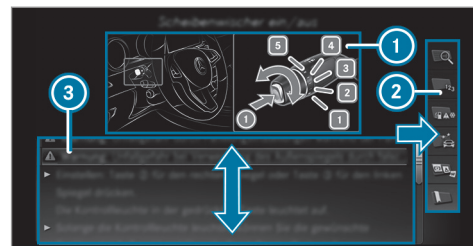

- ① Picture
- ② Menu
- ③ Navigation window

Some sections of the Digital Operator's Manual, such as warning notes, can be made visible by highlighting and pressing them.

- ⓘ The Operator's Manual can also be found in the Mercedes-Benz Guides App in all common App Stores.

## Protecting the environment

**!** **ENVIRONMENTAL NOTE** Environmental damage due to operating conditions and personal driving style

The pollutant emission of your vehicle is directly related to the way you operate your vehicle.

You can help to protect the environment by operating your vehicle in an environmentally-responsible manner. Please observe the following recommendations on operating conditions and personal driving style.

### Operating conditions:

- ▶ Make sure that the tire pressure is correct.
- ▶ Do not carry any unnecessary weight (e.g. roof luggage racks once you no longer need them).
- ▶ Adhere to the service intervals. A regularly serviced vehicle will contribute to environmental protection.

- ▶ Always have service work carried out at a qualified specialist workshop.

### Personal driving style:

- ▶ Do not depress the accelerator pedal when starting the engine.
- ▶ Do not warm up the engine while the vehicle is stationary.
- ▶ Drive carefully and maintain a suitable distance from the vehicle in front.
- ▶ Avoid frequent, sudden acceleration and braking.
- ▶ Change gear in good time and use each gear only up to  $\frac{2}{3}$  of its maximum engine speed.
- ▶ Switch off the engine in stationary traffic.
- ▶ Keep an eye on the vehicle's fuel consumption.

### Environmental issues and recommendations:

It is recommended that you re-use or recycle materials first instead of just disposing of them.

The relevant environmental regulations and guidelines serve to protect the environment and must be strictly observed.

## Mercedes-Benz GenuineParts

**!** **ENVIRONMENTAL NOTE** Environmental damage caused by the non-use of reconditioned components.

Daimler AG offers recycled reconditioned components and parts with the same quality as new parts. The same entitlement from the limited warranty is valid as for new parts.

- ▶ Use recycled reconditioned components and parts from Daimler AG.

**!** **NOTE** Impairment of the operating efficiency of the restraint systems from installing accessories or from repairs or welding

Airbags, Emergency Tensioning Devices, as well as control units and sensors for the restraint systems, may be installed in the following areas of your vehicle:

- Doors
- Door pillars
- Door sills
- Seats
- Cockpit
- Instrument cluster
- Center console

- ▶ Do not install accessories such as audio systems in these areas.
- ▶ Do not carry out repairs or welding.
- ▶ Have accessories retrofitted at a qualified specialist workshop.

You could jeopardize the operating safety of your vehicle if you use parts, tires and wheels as well as accessories relevant to safety which have not been approved by Mercedes-Benz. This could lead to malfunctions in safety-relevant systems, e.g. the brake system. Only use Mercedes-Benz GenuineParts or parts of equal quality. Only use tires, wheels and accessories that have been specifically approved for your vehicle model.

Mercedes-Benz GenuineParts are subject to strict quality control. Each part has been specially developed, manufactured or selected for Mercedes-Benz vehicles and fine-tuned for them. Therefore, only Mercedes-Benz GenuineParts should be used.

More than 300,000 different Mercedes-Benz GenuineParts are available for Mercedes-Benz models.

All Mercedes-Benz service centers maintain a supply of Mercedes-Benz GenuineParts for necessary service and repair work. In addition, strategically located parts-delivery centers provide for quick and reliable parts service.

Always specify the vehicle identification number (VIN) when ordering Mercedes-Benz GenuineParts .

### Operator's Manual

This Operator's Manual describes all models and all standard and optional equipment available for your vehicle at the time of this Operator's Manual going to press. Country-specific differences are possible. Note that your vehicle may not be equipped with all features described. This is also the case for systems and functions relevant to safety. Therefore, the equipment on your vehicle may differ from that in the descriptions and illustrations.

The original purchase contract documentation for your vehicle contains a list of all of the systems in your vehicle.

Should you have any questions concerning equipment and operation, please consult an authorized Mercedes-Benz service center.

The Operator's Manual and maintenance booklet are important documents and should be kept in the vehicle.

## Service and vehicle operation

### Vehicle operation outside the USA or Canada

When you are abroad with your vehicle, observe the following points:

- Service points or replacement parts may not be available immediately.
- Unleaded fuel may not be available for vehicles with a catalytic converter. Leaded fuel may cause damage to the catalytic converter.
- The fuel may have an extremely low octane number. Unsuitable fuel can cause engine damage.

Some Mercedes-Benz models are available in Europe through our European Delivery Program. For more information, please consult an authorized Mercedes-Benz service center, or write to one of the following address:

#### In the USA:

Mercedes-Benz USA, LLC  
European Delivery Department  
One Mercedes Drive  
Montvale, NJ 07645-0350

#### In Canada:

Mercedes-Benz Canada, Inc.  
European Delivery Department  
98 Vanderhoof Avenue  
Toronto, Ontario M4G 4C9

### Maintenance

Always bring the Maintenance Booklet with you when bringing the vehicle to an authorized Mercedes-Benz Center. The customer service advisor will record every service for you in the Maintenance Booklet.

### Roadside Assistance

The Mercedes-Benz Roadside Assistance Program offers technical help in the case of a breakdown. Your calls to the toll-free Roadside Assistance Hotline are answered by our agents 24 hours a day, 365 days a year.  
1-800-FOR-MERcedes (1-800-367-6372) (USA)  
1-800-387-0100 (Canada)

You can find further information in the Mercedes-Benz Roadside Assistance Program brochure (USA) or the "Roadside Assistance" section in the maintenance and warranty information booklet (Canada). You will find both in the vehicle document wallet.

### Change of address or change of ownership

In the event of a change of address, please send us the "Notification of address change" in the Service and Guarantee booklet or simply call the Mercedes-Benz Customer Assistance Center (USA) on the hotline number 1-800-FOR-MERcedes (1-800-367-6372) or Customer Service (Canada) on 1-800-387-0100. We can then reach you in a timely fashion, if necessary.

If you sell your Mercedes, please leave the entire literature in the vehicle so that it is available to the next owner. If you have purchased a used car, please send us the "Notice of Purchase of Used Car" in the Service and Guarantee booklet or simply call the Mercedes-Benz Customer Assistance Center (USA) on the hotline number

1-800-FOR-MERCEdes (1-800-367-6372) or Customer Service (Canada) on 1-800-387-0100.

### **Important notice for California retail buyers and lessees of Mercedes-Benz automobiles**

Under California law you may be entitled to a replacement of your vehicle or a refund of the purchase price or lease price, if after a reasonable number of repair attempts Mercedes-Benz USA, LLC and/or its authorized repair or service facilities fail to fix one or more substantial defects or malfunctions in the vehicle that are covered by its express warranty.

During a period of 18 months from original delivery of the vehicle or a kilometer/mileage reading of 18,000 miles (29,000 km), whichever occurs first, vehicle repair is presumed for a retail buyer or lessee if one or more of the following occurs:

- (1) the serious defect or damage can result in deadly or serious injury to the vehicle occupants while driving AND this defect has already been repaired at least twice AND

Mercedes-Benz, LLC has been informed in writing of the necessity of a repair.

- (2) the defect or damage, though less serious than (1) above, has already been repaired at least four times AND Mercedes-Benz has been informed in writing of the necessity of a repair.
- (3) the vehicle cannot be used for longer than 30 calendar days because of repair work resulting from this or other serious defects or damage.

Please send your written notice to:  
Mercedes-Benz USA, LLC  
Customer Assistance Center  
3 Mercedes Drive  
Montvale, NJ 07645-0350

### **Operating safety**

**⚠ WARNING** Risk of accident due to malfunctions or system failures

If you do not have the prescribed service/maintenance work or any required repairs carried out, this could result in malfunctions or system failures.

- ▶ Always have the prescribed service/maintenance work as well any required repairs carried out at a qualified specialist workshop.

**⚠ WARNING** Risk of fire due to flammable materials on hot parts of the exhaust system

Flammable material such as leaves, grass or twigs may ignite if they come into contact with hot parts of the exhaust system.

- ▶ When driving on unpaved roads or off-road, regularly check the vehicle underside.



- ▶ Remove trapped plants or other flammable material, in particular.
- ▶ If there is damage, consult a qualified specialist workshop immediately.

**⚠ WARNING** Risk of accident or injury due to incorrect modifications on electronic component parts

Modification to electronic components, their software or wiring could impair their function and/or the function of other networked component parts. In particular, systems relevant to safety could also be affected.

As a result, these may no longer function properly and/or jeopardize the operating safety of the vehicle.

- ▶ Never tamper with the wiring and electronic component parts or their software.
- ▶ You should have all work on electrical and electronic components carried out at a qualified specialist workshop.

**! NOTE** Damage to the vehicle

Damage to the vehicle may occur in the following cases:

- The vehicle becomes grounded, e.g. on a high curb or an unpaved road.
- The vehicle is driven too fast over an obstacle, e.g. a curb, speed bump or pothole.
- A heavy object strikes the underbody or parts of the chassis.

In situations such as this, the body, the underbody, chassis parts, wheels or tires could be damaged without the damage being visible. Components damaged in this way can unexpectedly fail or, in the case of an accident, no longer withstand the strain they are designed to.

If the underbody paneling is damaged, flammable materials such as leaves, grass or twigs can gather between the underbody and the underbody paneling. If these materials come into contact with hot parts on the exhaust system, they may catch fire.

- ▶ Have the vehicle checked and repaired immediately at a qualified specialist workshop.

or

- ▶ If driving safety is impaired while continuing your journey, pull over and stop the vehicle immediately, paying attention to road and traffic conditions, and contact a qualified specialist workshop.

**Declaration of conformity for wireless vehicle components**

**USA:** "The wireless devices of this vehicle comply with Part 15 of the FCC Rules. Operation is subject to the following two conditions: 1) These devices may not cause harmful interference, and 2) These devices must accept any interference received, including interference that may cause undesired operation. Changes or modifications not expressly approved by the party responsible for compliance could void the user's authority to operate the equipment."

**Canada:** "The wireless devices of this vehicle comply with Industry Canada license-exempt RSS standard(s). Operation is subject to the following two conditions: (1) These devices may not cause interference, and (2) These devices must accept any interference, including interference that may cause undesired operation of the device."

**USA:** "Wireless charging system for mobile devices (Model: D-WMI2015A): This Device complies with Part 18 of the FCC Rules."

The name and address of the responsible party is:

Continental Automotive Systems US Inc.  
2400 Executive Hills Drive  
Auburn Hills, MI 48326-2980  
United States of America

### Diagnosics connection

The diagnostics connection is only intended for the connection of diagnostic devices at a qualified specialist workshop.

**⚠ WARNING** Risk of accident due to connecting devices to the diagnostics connection

If you connect equipment to a diagnostics connection in the vehicle, it may affect the operation of vehicle systems.

As a result, the operating safety of the vehicle could be affected.

- ▶ Only connect equipment to a diagnostics connection in the vehicle which is approved for your vehicle by Mercedes-Benz.

**⚠ WARNING** Risk of accident due to objects in the driver's footwell

Objects in the driver's footwell may impede pedal travel or block a depressed pedal.

This jeopardizes the operating and road safety of the vehicle.

- ▶ Stow all objects in the vehicle securely so that they cannot get into the driver's footwell.

- ▶ Always install the floor mats securely and as prescribed in order to ensure that there is always sufficient room for the pedals.
- ▶ Do not use loose floor mats and do not place floor mats on top of one another.

**! NOTE** Battery discharging from using devices connected to the diagnostics connection

Using devices at the diagnostics connection drains the battery.

- ▶ Check the charge level of the battery.
- ▶ If the charge level is low, charge the battery, e.g. by driving a considerable distance.

Connecting equipment to the diagnostics connection can lead to emissions monitoring information being reset, for example. This may lead to the vehicle failing to meet the requirements of the next emissions inspection during the main inspection.

### Qualified specialist workshop

An authorized Mercedes-Benz Center is a qualified specialist workshop. It has the necessary specialist knowledge, tools and qualifications to correctly carry out the work required on your vehicle. This particularly applies to work relevant to safety.

For the following, always have your vehicle checked at an authorized Mercedes-Benz Center:

- Work relevant to safety
- Service and maintenance work
- Repair work
- Modifications, installations and conversions
- Work on electronic component parts

### Correct use of the vehicle

If you remove any warning stickers, you or others could fail to recognize certain dangers. Leave warning stickers in position.

Observe the following information when driving your vehicle:

- the safety notes in this manual
- the vehicle technical data
- traffic rules and regulations
- laws and safety standards pertaining to motor vehicles

### Problems with your vehicle

If you should experience a problem with your vehicle, particularly one that you believe may affect its safe operation, we urge you to contact an authorized Mercedes-Benz service center immediately to have the problem diagnosed and rectified. If the problem is not resolved to your satisfaction, please discuss the problem again with the authorized Mercedes-Benz service center or, if necessary, contact us at one of the following addresses.

#### In the USA:

Customer Assistance Center  
Mercedes-Benz USA, LLC

3 Mercedes Drive  
Montvale, NJ 07645-0350

#### In Canada:

Customer Relations Department  
Mercedes-Benz Canada, Inc.  
98 Vanderhoof Avenue  
Toronto, Ontario M4G 4C9

### Reporting safety defects

#### USA only:

The following text is published as required of manufacturers under Title 49, Code of U.S. Federal Regulations, Part 575 pursuant to the "National Traffic and Motor Vehicle Safety Act of 1966".

If you believe that your vehicle has a defect which could cause a crash or could cause injury or death, you should immediately inform the National Highway Traffic Safety Administration (NHTSA) in addition to notifying Mercedes-Benz USA, LLC.

If NHTSA receives similar complaints, it may open an investigation, and if it finds that a safety defect exists in a group of vehicles, it may order a recall and remedy campaign. However, NHTSA cannot become involved in individual problems between you, your dealer, or Mercedes-Benz USA, LLC.

To contact NHTSA, you may call the Vehicle Safety Hotline toll-free at 1-888-327-4236 (TTY: 1-800-424-9153) (inside the USA); go to <http://www.safercar.gov>; or write to: Administrator, NHTSA, 400 Seventh Street, SW., Washington, DC 20590, USA.

Further information on vehicle safety can be found at: <http://www.safercar.gov>

### Limited Warranty

**!** **NOTE** Damage to the vehicle arising from culpable violation of these operating instructions.

Damage to the vehicle can arise from culpable violation of these operating instructions.

This damage is not covered either by the Mercedes-Benz Limited Warranty or by the New Vehicle or Used Vehicle Warranty.

▶ Follow the instructions in this manual on proper operation of your vehicle as well as on possible vehicle damage.

### QR code for rescue card

The QR code is secured in the fuel filler flap and on the opposite side on the B-pillar. In the event of an accident, rescue services can use the QR code to quickly find the appropriate rescue card for your vehicle. The current rescue card contains the most important information about your vehicle in a compact form, e.g. the routing of the electric lines.

Further information can be obtained at <http://www.mercedes-benz.de/qr-code>.

### Vehicle data storage

#### Data acquisition

A wide range of electronic components in your vehicle contain data memories.

These data memories temporarily or permanently store technical information about:

- The vehicle's operating state
- Events
- Malfunctions

In general, the technical information documents the state of a component part, a module, a system or the surroundings.

These include, for example:

- Operating conditions of system components. For example, fluid levels.
- The vehicle's status messages and those of its individual components. For example, the number of wheel revolutions/speed, deceleration, lateral acceleration, accelerator pedal position.

- Malfunctions and defects in important system components. For example, lights, brakes.
- Vehicle reactions and operating conditions in special driving situations. For example, air bag deployment, intervention of stability control systems.
- Ambient conditions. For example, outside temperature.

This data is of an exclusively technical nature and can be used to:

- Assist in detecting and rectifying malfunctions and defects.
- Analyze vehicle functions, e.g. after an accident.
- Optimize vehicle functions.

The data cannot be used to trace the vehicle's movements.

When your vehicle is serviced, technical information can be read from the event data memory and malfunction data memory.

Services include, for example:

- Repair services
- Service processes
- Warranty cases

The vehicle is read out by employees of the service network (including the manufacturer) using special diagnostic devices. You can obtain more information there, if required.

After a malfunction has been rectified, the information is deleted from the malfunction memory or is continually overwritten.

When operating the vehicle, situations are conceivable in which this technical data, in connection with other information (if necessary, after consultation with an authorized expert), could be traced to a person.

Examples include:

- Accident reports
- Damage to the vehicle
- Witness statements

Further additional functions that have been contractually agreed upon with the customer allow

certain vehicle data to be conveyed by the vehicle as well. The additional functions include, for example, vehicle location in case of an emergency.

#### **COMAND/mbrace**

If the vehicle is equipped with COMAND or mbrace, additional data about the vehicle's operation, the use of the vehicle in certain situations, and the location of the vehicle may be compiled through COMAND or the mbrace system.

Additional information can be found in the multimedia system section and/or the mbrace Terms and Conditions.

#### **Event data recorders**

This vehicle is equipped with an event data recorder (EDR). The main purpose of an EDR is to record, in certain crash or near crash-like situations, such as an air bag deployment or hitting a road obstacle, data which will assist in understanding how a vehicle's systems performed. The EDR is designed to record data related to vehicle dynamics and safety systems for a short period of time, typically 30 seconds or less.

The EDR in this vehicle is designed to record such data as:

- How various systems in your vehicle were operating;
- Whether or not the driver and passenger safety belts were buckled/fastened;
- How far (if at all) the driver was depressing the accelerator and/or brake pedal; and,
- How fast the vehicle was traveling.

This data can help provide a better understanding of the circumstances in which accidents and injuries occur. NOTE: EDR data is recorded by your vehicle only if a non-trivial crash situation occurs; no data is recorded by the EDR under normal driving conditions and no personal data (e.g. name, gender, age and accident location) is recorded. However, other parties, such as law enforcement, could combine EDR data with the type of personally identifying data routinely acquired during a crash investigation.

Access to the vehicle and/or the EDR is needed to read data that is recorded by the EDR, and special equipment is required. In addition to the vehicle manufacturer, other parties that have the

special equipment, such as law enforcement, can read the information by accessing the vehicle or the EDR.

EDR data may be used in civil and criminal matters as a tool in accident reconstruction, accident claims and vehicle safety. Since the Crash Data Retrieval (CDR) tool that is used to extract data from the EDR is commercially available, Mercedes-Benz USA, LLC ("MBUSA") expressly disclaims any and all liability arising from the extraction of this information by unauthorized Mercedes-Benz personnel.

MBUSA will not share EDR data with others without the consent of the vehicle owner or, if the vehicle is leased, without the consent of the lessee. Exceptions to this representation include responses to subpoenas by law enforcement; by federal, state or local government; in connection with or arising out of litigation involving MBUSA or its subsidiaries and affiliates; or, as required by law.

Warning: the EDR is a component of the Restraint System Module. Tampering with, altering, modifying or removing the EDR component

may result in a malfunction of the Restraint System Module and other systems.

State laws or regulations regarding EDRs that conflict with federal regulation are pre-empted. This means that in the event of such conflict, the federal regulation governs. As of February 2013, 13 states have enacted laws relating to EDRs.

### Copyright

#### Free and open source software

Information on free and open source software licenses for your vehicle's software can be found on the data storage medium in your vehicle document wallet and on the Internet together with updates at:

<http://www.mercedes-benz.com/opensource>

#### Registered trademarks

- Bluetooth® is a registered trademark of Bluetooth SIG Inc.
- DTS™ is a registered trademark of DTS, Inc.

- Dolby® and MLP™ are registered trademarks of DOLBY Laboratories.
- BabySmart™, ESP® and PRE-SAFE® are registered trademarks of Daimler AG.
- HomeLink® is a registered trademark of Johnson Controls.
- iPod® and iTunes® are registered trademarks of Apple Inc.
- Burmester® is a registered trademark of Burmester Audiosysteme GmbH.
- Microsoft® and Windows Media® are registered trademarks of Microsoft Corporation.
- SIRIUS® is a registered trademark of Sirius XM Radio Inc.
- HD Radio™ is a registered trademark of iBiquity Digital Corporation.
- Gracenote® is a registered trademark of Gracenote, Inc.
- ZAGATSurvey® and related brands are registered trademarks of ZagatSurvey, LLC.

## Restraint system

### Protection by the restraint system

The restraint system includes the following:

- Seat belt system
- Airbags
- Child restraint system
- Child seat securing system

In the event of an accident, the restraint system can:

- Reduce the risk of vehicle occupants coming into contact with parts of the vehicle interior.
- Reduce the forces to which the vehicle occupants are subjected.

A seat belt can only provide the best level of protection if it is worn correctly. Depending on the detected accident situation, Emergency Tensioning Devices and/or airbags supplement the protection offered by a correctly worn seat belt. Emergency Tensioning Devices and/or airbags are not deployed in every accident.

So that the restraint system can provide protection, each vehicle occupant must:

- With the seat belt fastened correctly
- In an almost upright position with their back against the seat backrest
- Sit with their feet resting on the floor, if possible.
- Always be secured in an additional restraint system suitable for Mercedes-Benz vehicles if they are under 5 ft (1.50 m) tall.

However, no system available today can completely eliminate injuries and fatalities in every accident situation. In particular, the seat belt and airbag generally do not protect against objects penetrating the vehicle from the outside. A risk of injury caused by the airbag deploying can also not be completely ruled out.

### Reduced restraint system protection

**⚠ WARNING** Risk of injury or death from modifications to the restraint system

Modifications to the restraint system may cause it to no longer work as intended.

The restraint system may then not protect the vehicle occupants as intended by failing in an accident or triggering unexpectedly, for example

- ▶ Never alter the parts of the restraint system.
- ▶ Never tamper with the wiring or any electronic component parts or their software.

If it is necessary to modify the vehicle to accommodate a person with disabilities, contact a qualified specialist workshop. Mercedes-Benz recommends that you only use seat belts which have been approved specifically for your vehicle by Mercedes-Benz.

- Contact a Mercedes-Benz service center for details.





- **USA only:** For details, contact our Customer Assistance Center on 1-800-FOR-MERCEdes (1-800-367-6372).

### Restraint system functionality

When the ignition is switched on, a system self-test is performed, during which the  restraint system warning lamp lights up. It goes out no later than a few seconds after the vehicle is started. The components of the restraint system are then functional.

### Restraint system malfunction

- The  restraint system warning lamp does not light up when the ignition is switched on.
- The  restraint system warning lamp lights up continuously or repeatedly during a journey.

**⚠ WARNING** Risk of injury or fatal injury due to a malfunction in the restraint system

If the restraint system is malfunctioning, restraint system components may be triggered unintentionally or might not be triggered at all in the event of an accident. This may affect the Emergency Tensioning Device or airbag, for example.

- ▶ Have the restraint system checked and repaired immediately at a qualified specialist workshop.

### Function of the restraint system in an accident

How the restraint system works is determined by the severity of the impact detected and the type of accident anticipated:

- Frontal impact
- Rear impact
- Side impact
- Rollover

The activation thresholds for the components of the restraint system are determined based on the evaluation of the sensor values measured at various points in the vehicle. This process is pre-emptive in nature. The triggering/deployment of the components of the restraint system should take place in good time at the start of the collision.

Factors which can only be seen and measured after a collision has occurred cannot play a decisive role in airbag deployment. Nor do they provide an indication of airbag deployment.

The vehicle may be deformed significantly without an airbag being deployed. This is the case if only parts which are relatively easily deformed are affected and the rate of vehicle deceleration is not high. Conversely, an airbag may be deployed even though the vehicle suffers only minor deformation. If very rigid vehicle parts such as longitudinal members are hit, for example, this may result in sufficiently high levels of vehicle deceleration.

**The components of the restraint system can be activated or deployed independently of each other:**

Component	Detected deployment situation
Emergency Tensioning Devices	Frontal impact, rear impact, side impact, rollover
Driver's airbag, front passenger airbag, knee airbag	Frontal impact
Side airbag	Side impact
Window airbag	Side impact, rollover, frontal impact
Belt airbag	Frontal impact
PRE-SAFE® Impulse Side	Side impact

The front passenger airbag can only deploy in an accident if the PASSENGER AIRBAG OFF indicator lamp is off. If the front passenger seat is

occupied, make sure, both before and during the journey, that the status of the front passenger airbag is correct (→ page 41).

**⚠ WARNING** Risk of burns from hot airbag components

The airbag parts are hot after an airbag has been deployed.

- ▶ Do not touch the airbag parts.
- ▶ Have a deployed airbag replaced at a qualified specialist workshop as soon as possible.

Mercedes-Benz recommends that you have the vehicle towed to a qualified specialist workshop after an accident. Take this into account, particularly if an Emergency Tensioning Device was triggered or an airbag was deployed.

If the Emergency Tensioning Devices are triggered or an airbag is deployed, you will hear a bang, and a small amount of powder may also be released:

- The bang will not generally affect your hearing.

- In general, the powder released is not hazardous to health but may cause short-term breathing difficulties to persons suffering from asthma or other pulmonary conditions. Provided it is safe to do so, leave the vehicle immediately or open the window in order to prevent breathing difficulties.

Airbags and pyrotechnic Emergency Tensioning Devices contain perchlorate material, which may require special handling or environmental protection measures. National guidelines regarding waste disposal must be observed. In California, see <http://www.dtsc.ca.gov/HazardousWaste/Perchlorate/index.cfm>.

## Seat belts

### Protection provided by the seat belt

Always fasten your seat belt correctly before starting a journey. A seat belt can only provide the best level of protection if it is worn correctly.

**▲ WARNING** Risk of injury or death due to incorrectly fastened seat belt

If the seat belt is not worn correctly, it cannot perform its intended protective function. In addition, an incorrectly fastened seat belt can also cause injuries, for example, in the event of an accident or when braking or changing direction suddenly.

▶ Always ensure that all vehicle occupants have their seat belts fastened correctly and are sitting properly.

- The seat belt must:
  - Not be twisted and must fit tightly and snugly across your body.
  - Be routed across the center of your shoulder and as low down across your hips as possible.
- The shoulder section of the seat belt should not touch your neck nor be routed under your arm or behind your back.
- Avoid wearing bulky clothing, e.g. a winter coat.

- Push the lap belt down as far as possible across your hips and pull tight with the shoulder section of the belt. Never route the lap belt across your abdomen.
- Never route the seat belt across sharp, pointed, abrasive or fragile objects.
- Only one person should use each seat belt at any one time. Never allow babies and children to travel sitting on the lap of another vehicle occupant.
- Never secure objects with a seat belt if the seat belt is also being used by one of the vehicle's occupants. Always observe the instructions for loading the vehicle when securing objects, luggage or loads (→ page 94).

The seat belts on the following seats are equipped with a special seatbelt retractor:

- Front passenger seat
- Rear seats

Activating or deactivating the special seatbelt retractor of the seat belt (→ page 47)

If children are traveling in the vehicle, be sure to observe the instructions and safety notes on "Children in the vehicle" (→ page 45).

### Reduced protection

**▲ WARNING** Risk of injury due to an incorrect seat position

The seat belt does not offer the intended level of protection if you have not moved the seat backrest to an almost vertical position. When braking or in the event of an accident, you could slide underneath the seat belt and sustain abdomen or neck injuries, for example. This poses an increased risk of injury or even fatal injury.

- ▶ Adjust the seat correctly before starting the journey.
- ▶ Always ensure that the seat backrest is in an almost vertical position and that the shoulder section of your seat belt is routed across the center of your shoulder.

**⚠ WARNING** Risk of injury or death when additional restraint systems are not used for persons with a smaller build

Persons under 5 ft (1.50 m) tall cannot wear the seat belt correctly without a suitable additional restraint system.

If the seat belt is not worn correctly, it cannot perform its intended protective function. In addition, an incorrectly fastened seat belt can also cause injuries, for example, in the event of an accident or when braking or changing direction suddenly.

- ▶ Always secure persons under 5 ft (1.50 m) tall in a suitable restraint system.

**⚠ WARNING** Risk of injury or death due to blocked seat belt buckle or seat belt anchorage

Objects next to the front seat that block the seat belt buckle or the moving seat belt anchorage on the front seat impair the function of the Emergency Tensioning Devices.

The Emergency Tensioning Devices can, then, not function as intended and the seat belt can no longer provide the intended protection.

- ▶ Before starting the journey, make sure that there are no objects around the seat belt buckle or between the front seat and door.

**⚠ WARNING** Risk of injury or death due to damaged or modified seat belts

Seat belts cannot provide protection in the following situations:

- If the seat belts are damaged, modified, extremely dirty, bleached or dyed
- If the seat belt buckle is damaged or extremely dirty
- If the Emergency Tensioning Devices, seat belt anchorages or seat belt retractors have been modified

Seat belts may be damaged in an accident, although the damage may not be visible, e.g. due to splinters of glass.

Modified or damaged seat belts may tear or fail, e.g. in an accident.

Modified Emergency Tensioning Devices could accidentally trigger or fail to function as intended.

- ▶ Never modify the seat belts, Emergency Tensioning Devices, seat belt anchorages or seat belt retractors.
- ▶ Make sure that the seat belts are undamaged, not worn and clean.
- ▶ Always have the seat belts checked immediately after an accident at a qualified specialist workshop.

Only use seat belts that have been approved for your vehicle by Mercedes-Benz.

**⚠ WARNING** Risk of injury or death from deployed pyrotechnic Emergency Tensioning Devices

Pyrotechnic Emergency Tensioning Devices that have been deployed are no longer operational and are unable to perform their intended protective function.

- ▶ Therefore, have deployed pyrotechnic Emergency Tensioning Devices immediately replaced at a qualified specialist workshop.

Mercedes-Benz recommends that you have the vehicle towed to a qualified specialist workshop after an accident.

- ! **NOTE** Damage caused by trapping the seat belt

If an unused seat belt is not fully retracted, it may become trapped in the door or in the seat mechanism.

- ▶ Always ensure that an unused seat belt is fully retracted.

### Information on the belt air bag in the rear seat belt

The BELTBAG identification indicates that a rear seat belt is equipped with a belt air bag.

When activated, the belt air bag increases the protected area of the vehicle occupant's ribcage.

- ! **WARNING** Risk of injury or death through the use of a non-approved child restraint system

In an accident, the belt air bag may damage a non-approved child restraint system or a child restraint system which has not been approved for use in conjunction with the belt air bag.

As a result, the child restraint system may not be able to provide the intended level of protection.



- ▶ Therefore, always use LATCH-type (ISO-FIX) to fasten a child seat equipped with an integrated restraint system.
- ▶ For vehicles equipped with the optional rear seat belt air bags ("beltbag"), only use a Mercedes-Benz approved booster seat with integrated backrest.
- ▶ Never use an air bag equipped seat belt to fasten a front- or rear-facing child seat or a non-approved booster seat.

- ▶ Please contact an authorized Mercedes-Benz Center for information on approved child restraint systems.

### Fastening and adjusting seat belts

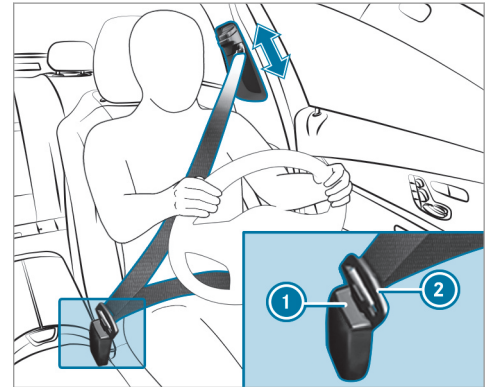
If the seat belt is pulled quickly or sharply, the seat belt retractor locks. The seat belt strap cannot be pulled out any further.



- ▶ Always engage seat belt tongue  of the seat belt into seat belt buckle  of the corresponding seat.
- ▶ Press and hold the seat belt outlet release and slide the seat belt outlet into the desired position.
- ▶ Let go of the belt outlet release and ensure that the seat belt outlet locks in position.

**Vehicles with PRE-SAFE®:** If the front seat belt is not pulled tight across your body, the seat belt adjustment may automatically apply a certain tightening force. Do not hold the seat belt tightly while it is adjusting. You can activate and deactivate the seat belt adjustment function using the multimedia system.

**NOTE** Deployment of the Emergency Tensioning Device when the front passenger seat is unoccupied

If the seat belt tongue is engaged in the seat belt buckle of the front passenger seat and the front passenger seat is unoccupied, the Emergency Tensioning Device may deploy in the event of an accident.

- ▶ Only one person should use each seat belt at any one time.

### Releasing seat belts

- ▶ Press the release button in the seat belt buckle and guide the seat belt back with the seat belt tongue.

### Activating or deactivating seat belt adjustment via the multimedia system

Multimedia system:

 [Vehicle](#) ▶  [Vehicle Settings](#) ▶ [Belt Adjustment](#)

- ▶ Activate  or deactivate  the function.

### Seat belt warning for the driver and front passenger

The  seat belt warning lamp in the Instrument Display is a reminder that all vehicle occupants must wear their seat belts correctly.

The  seat belt warning lamp lights up for six seconds after every engine start.

In addition, there may be a warning tone.

When the front doors are closed and the driver and front passenger have fastened their seat belts, the seat belt warning goes out.

During a journey, the seat belt warning lights up if:

- The vehicle speed exceeds 15 mph (25 km/h) and the driver's or front passenger seat belt is not fastened.
- The driver or front passenger unfastens their seat belt while the vehicle is in motion.

## Airbags

### Overview of air bags

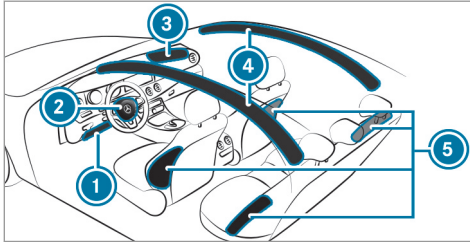

- ① Knee air bag
- ② Driver's air bag
- ③ Front-passenger front air bag
- ④ Window curtain air bag
- ⑤ Side air bag

The installation location of an air bag is identified by the AIRBAG symbol.

When activated, an air bag can provide additional protection for the respective vehicle occupant.

AIRBAG	Potential protection for ...
Knee air bag	Thigh, knee and lower leg
Driver's air bag, front passenger air bag	Head and ribcage
Window curtain air bag	Head
Side air bag	Ribcage, also pelvis for front seat occupants

The front-passenger front air bag can only deploy in an accident if the PASSENGER AIR BAG OFF indicator lamp is off. If the front passenger seat is occupied, make sure, both before and during the journey, that the status of the front passenger air bag is correct (→ page 41).

**!** **NOTE** Important points to remember if the front passenger seat is unoccupied

In an accident, the components of the restraint system may deploy unnecessarily on the front passenger side if:

- There are heavy objects on the front passenger seat.
- The seat belt tongue is engaged in the seat belt buckle of the front passenger seat and the front passenger seat is unoccupied.

- ▶ Stow objects in a suitable place.
- ▶ Only one person should use each seat belt at any one time.

### Protection by the airbags

Depending on the accident situation, an airbag can add to the protection offered by a correctly fastened seat belt.

**▲ WARNING** Risk of injury or death due to incorrect seat position

If you deviate from the correct seat position, the airbag cannot perform its intended protective function and deployment may even cause further injuries.

To avoid hazardous situations, always make sure that all vehicle occupants:

- Are seated properly and keep as far away as possible from the airbags.
- Observe the following information.

► Always make sure that there are no objects between the airbag and the vehicle occupant.

To avoid risks resulting from the deployment of the airbag:

- Before starting your journey, adjust your seat correctly; the driver's seat and front passenger seat should be moved as far back as possible.

When doing so, always observe the information on the correct driver's seat position (→ page 81).

- Only hold the steering wheel by the steering wheel rim. This allows the airbag to be fully deployed.
- Always lean against the seat backrest when the vehicle is in motion. Do not lean forwards or lean against the door or side window. You may otherwise be in the deployment area of the airbags.
- Always keep your feet on the floor. Do not put your feet on the cockpit, for example. Your feet may otherwise be in the deployment area of the airbag.
- If children are traveling in the vehicle, observe the additional notes (→ page 45).
- Always stow and secure objects correctly.

Objects in the vehicle interior may prevent an airbag from functioning correctly. Therefore always ensure that:

- There are no people, animals or objects between the vehicle occupants and an airbag.
- There are no objects between the seat, door and door pillar (B-pillar).
- No hard objects, e.g. coat hangers, are hanging on the grab handles or coat hooks.
- No accessories, such as cup holders, are attached to the vehicle within the deployment area of an airbag, e.g. to doors, side windows or side paneling.
- No heavy, sharp-edged or fragile objects are in the pockets of your clothing. Store such objects in a suitable place.



### Reduced airbag protection

**⚠ WARNING** Risk of injury from modifications to the airbag cover

If you modify an airbag cover or affix objects such as stickers to it, the airbag can no longer function correctly.

- ▶ Never modify an airbag cover and do not affix objects to it.

**⚠ WARNING** Risk of injury due to unsuitable seat covers

Unsuitable seat covers can obstruct or prevent the deployment of the airbags integrated into the seats.

Consequently, the airbags cannot protect vehicle occupants as they are designed to do. In addition, the operation of the automatic front passenger airbag shutoff system could be restricted. This poses an increased risk of injury or even fatal injury.

- ▶ You should only use seat covers that have been approved for the corresponding seats by Mercedes-Benz.

**⚠ WARNING** Risk of injury due to malfunctions of the sensors in the door paneling

Sensors to control the airbags are located in the doors. Modifications or work not performed correctly to the doors or door paneling, as well as damaged doors, can lead to the function of the sensors being impaired. The airbags might therefore not function properly any more.

Consequently, the airbags cannot protect vehicle occupants as they are designed to do.

- ▶ Never modify the doors or parts of the doors.
- ▶ Always have work on the doors or door paneling carried out at a qualified specialist workshop.

**⚠ WARNING** Risk of injury due to deployed airbag

A deployed airbag no longer has a protective function and cannot protect as intended in the event of an accident.

- ▶ Have the vehicle towed to a qualified specialist workshop in order to have the deployed airbag replaced.

Have deployed airbags replaced immediately.

### Status of the front passenger airbag

#### Points to remember when the front passenger seat is occupied

The automatic front passenger air bag shutoff is able to detect whether the front passenger seat is occupied by a person or a child restraint system. The front passenger air bag is enabled or deactivated accordingly.

When installing a child restraint system on the front passenger seat:

- Ensure that the child restraint system is positioned correctly .

- Always observe the child restraint system manufacturer's installation instructions.
- Never place objects under or behind the child restraint system, e.g. cushions.
- Fully retract the seat cushion length adjustment.
- The entire base of the child restraint system must always rest on the seat cushion of the front-passenger seat.
- The backrest of the forward-facing child restraint system must lie as flat as possible against the backrest of the front-passenger seat.
- The child restraint system must not touch the roof or be put under strain by the head restraints. Adjust the seat backrest inclination and the head restraint setting accordingly.

**▲ WARNING** Risk of injury or death due to objects between the sitting surface and the child restraint system

Objects between the sitting surface and the child restraint system could affect the function of the automatic front passenger airbag shutoff.

This could result in the front passenger airbag not functioning as intended during an accident.

- ▶ Do not place any objects between the sitting surface and the child restraint system.
- ▶ The entire base of the child restraint system must always rest on the sitting surface of the front passenger seat.
- ▶ The backrest of the forward-facing child restraint system must lie as flat as possible against the backrest of the front passenger seat.
- ▶ Always comply with the child restraint system manufacturer's installation instructions.

A person in the front passenger seat must:

- Have their seat belt fastened correctly.
- Sit in an almost upright position with their back against the seat backrest.
- Sit with their feet resting on the floor, if possible.

Otherwise, the front passenger air bag may be deactivated by mistake, for example because the front passenger:

- Transfers their weight by supporting themselves on a vehicle armrest.
- Sits in such a way that their weight is raised from the sitting surface.

**▲ WARNING** Risk of injury or death due to deactivated front passenger airbag

If the PASSENGER AIR BAG OFF indicator lamp is lit, the front passenger airbag is disabled. It will not be deployed in the event of an accident and cannot perform its intended protective function.

A person in the front passenger seat could then, for example, come into contact with the vehicle interior, especially if the person is sitting too close to the cockpit.

If the front passenger seat is occupied, always ensure that:

- The classification of the person in the front passenger seat is correct and the front passenger airbag is enabled or disabled in accordance with the person in the front passenger seat.
  - The front passenger seat has been moved as far back as possible.
  - The person is seated correctly.
- Ensure, both before and during the journey, that the status of the front passenger airbag is correct.

## PASSENGER AIRBAG indicator lamp

### System self-test

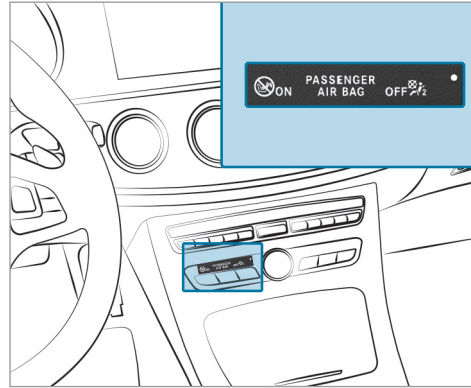

When the ignition is switched on, a system self-test is performed during which the two PASSENGER AIR BAG ON and OFF indicator lamps light up simultaneously.

The status of the front passenger airbag is then displayed:

- PASSENGER AIR BAG ON lights up for 60 seconds, subsequently both indicator lamps are off (PASSENGER AIR BAG ON and OFF): the front passenger airbag is able to deploy in the event of an accident.
- PASSENGER AIR BAG OFF lights up continuously: the front passenger airbag is disabled. It will then not be deployed in the event of an accident.

If the PASSENGER AIR BAG ON indicator lamp is off, only the PASSENGER AIR BAG OFF indicator lamp shows the status of the front passenger airbag. The PASSENGER AIR BAG OFF indicator lamp may be lit continuously or be off.

If the PASSENGER AIR BAG OFF indicator lamp and the  restraint system warning lamp light up simultaneously, the front passenger seat may not be used. Also in this case, do not install a child restraint system on the front passenger seat. Have the automatic front passenger airbag shutoff checked and repaired immediately at a qualified specialist workshop.

### Status display

If the front passenger seat is occupied, ensure, both before and during the journey, that the status of the front passenger airbag is correct for the prevailing situation.

### After installing a rearward-facing child restraint system on the front passenger seat:

PASSENGER AIRBAG OFF must be lit continuously.

**⚠ WARNING** Risk of injury or death caused by using a rearward-facing child restraint system when the front passenger airbag is enabled

If you secure a child in a rearward-facing child restraint system on the front passenger seat and the PASSENGER AIR BAG OFF indicator lamp is off, the front passenger airbag can deploy in the event of an accident.

The child could be struck by the airbag.

Always make sure that the front passenger airbag is disabled. The PASSENGER AIR BAG OFF indicator lamp must be lit.

When installing a child restraint system on the front passenger seat, observe the vehicle-specific information (→ page 39).

Depending on the child restraint system and the stature of the child, the PASSENGER AIRBAG OFF indicator lamp may be off. In this case, do not install the rearward-facing child restraint system on the front passenger seat.

Instead, install the rearward-facing child restraint system on a suitable rear seat.

### After installing a forward-facing child restraint system on the front passenger seat:

depending on the child restraint system and the stature of the child, PASSENGER AIRBAG OFF may be lit continuously or be off. Always observe the following information.

**⚠ WARNING** Risk of injury or death due to incorrect positioning of the forward-facing child restraint system

If you secure a child in a forward-facing child restraint system on the front passenger seat and you position the front passenger seat too close to the cockpit, in the event of an accident, the child could:

- Come into contact with parts of the vehicle interior if the PASSENGER AIR BAG OFF indicator lamp is lit, for example.
  - Be struck by the airbag if the PASSENGER AIR BAG OFF indicator lamp is off
- ▶ Always move the front passenger seat as far back as possible and fully retract the seat cushion length adjustment. Always make sure that the shoulder belt strap is correctly routed from the seat belt outlet on the vehicle to the shoulder belt guide on the child restraint system. The shoulder belt strap must be routed forwards and downwards from the seat belt outlet. If necessary, adjust

the seat belt outlet and the front passenger seat accordingly.

- ▶ Always observe the child restraint system manufacturer's installation instructions.

When installing a child restraint system on the front passenger seat, observe the vehicle-specific information (→ page 39).

**If a person is sitting in the front passenger seat:** PASSENGER AIRBAG OFF may be lit continuously or be off, depending on the person's stature. Always observe the following information.

If the front passenger seat is occupied by:

- An adult or a person with a build corresponding to that of an adult, the PASSENGER AIRBAG OFF indicator lamp must be off. This indicates that the front passenger airbag is enabled.

If the PASSENGER AIRBAG OFF indicator lamp is lit continuously, an adult or person with a build corresponding to that of an adult

should not use the front passenger seat. Instead, they should use a rear seat.

- A person with a smaller build (e.g. a teenager or small adult), the PASSENGER AIRBAG OFF indicator lamp either lights up and remains lit depending on the result of the classification or, alternatively, goes out.
  - PASSENGER AIRBAG OFF is off: move the front passenger seat as far back as possible or a person with a smaller build should use a rear seat.
  - PASSENGER AIRBAG OFF indicator lamp is lit continuously: a person with a smaller build should not use the front passenger seat.

**⚠ WARNING** Risk of injury or death when the PASSENGER AIR BAG OFF indicator lamp is lit

If the PASSENGER AIR BAG OFF indicator lamp remains lit after the system self-test, the front passenger air bag is deactivated. It will not be deployed in the event of an accident. In this case, the front passenger air bag

cannot perform its intended protective function, e.g. when a person is seated in the front passenger seat.

That person could, for example, come into contact with the vehicle interior, especially if the person is sitting too close to the cockpit.

If the front passenger seat is occupied, always ensure that:

- The classification of the person in the front passenger seat is correct and the front passenger air bag is enabled or deactivated in accordance with the person in the front passenger seat.
- The person is seated properly with a correctly fastened seat belt.
- The front passenger seat has been moved as far back as possible.

#### Further related subjects:

- Child restraint system on the front passenger seat (→ page 51).

## PRE-SAFE®

### Information on PRE-SAFE® (anticipatory occupant protection)

PRE-SAFE® is able to detect certain critical driving situations and implement pre-emptive measures to protect the vehicle occupants.

PRE-SAFE® can implement the following measures independently of each other:

- Tighten the seat belts on the driver's seat and front passenger seat.
- Close the side windows.
- **Vehicles with sliding sunroof:** Close the sliding sunroof.
- **Vehicles with memory function:** Move the front passenger seat to a more favorable seat position.
- **Vehicles with multicontour seat:** Increase the air pressure in the seat side bolsters of the seat backrest.
- PRE-SAFE® Sound: provided that the multimedia system is switched on, generates a

brief noise signal to stimulate the innate protective mechanism of a person's hearing.

**!** **NOTE** Damage caused by objects in the footwell or behind the seat

The automatic adjustment of the seat position may result in damage to the seat and/or the object.

▶ Stow objects in a suitable place.

### Reversing the PRE-SAFE® measures

**If an accident did not occur, the pre-emptive measures that were taken are reversed. You will need to perform certain settings yourself.**

▶ If the seat belt pre-tensioning is not reduced, move the seat backrest back slightly. The locking mechanism releases.

## PRE-SAFE® PLUS (anticipatory occupant protection plus)

PRE-SAFE® PLUS can detect certain impacts, particularly an imminent rear impact, and take pre-emptive measures to protect the vehicle occupants. These measures cannot necessarily prevent an imminent impact.

PRE-SAFE® PLUS can implement the following measures independently of each other:

- Tightening the seat belts on the driver's seat and front passenger seat.  
If an accident does not occur, the pre-emptive measures that were taken are reversed.
- Increasing brake pressure when the vehicle is stationary. This brake application is canceled automatically when the vehicle pulls away.

### PRE-SAFE® PLUS system limitations

- No measures are implemented:
  - If the vehicle is backing up.
- The brakes are not applied:
  - Whilst driving.

or

- When entering or exiting a parking space using Parking Pilot.

### Information on PRE-SAFE® Impulse Side

If an imminent side impact is detected, PRE-SAFE® Impulse Side can pre-emptively move the front-seat vehicle occupant's upper body towards the center of the vehicle. It does this by rapidly inflating an air cushion in the outer seat side bolster of the seat backrest on the side on which the impact is anticipated. This increases the distance between the door and the vehicle occupant.

If PRE-SAFE® Impulse Side has been deployed or is defective, the display message [PRE-SAFE Impulse Side Inoperative](#) See [Operator's Manual](#) is displayed (→ page 375).

## Children in the vehicle

### Notes on the safe transportation of children

**⚠ WARNING** Risk of accident and injury due to children left unattended in the vehicle

If you leave children unaccompanied in the vehicle, they may be able to set the vehicle in motion, for example by:

- Releasing the parking brake.
- Shifting the transmission out of park position **P**.
- Starting the engine.

In addition, they may operate vehicle equipment.

- ▶ Never leave children and animals unattended in the vehicle.
- ▶ When leaving the vehicle, always take the SmartKey with you and lock the vehicle.

**⚠ WARNING** Risk of fatal injury due to exposure to extreme heat or cold in the vehicle

If people – particularly children – are exposed to extreme heat or cold over an extended period of time, there is a risk of injury or even fatal injury.

- ▶ Never leave anyone – particularly children – unattended in the vehicle.

**⚠ WARNING** Risk of burns when the child seat is exposed to direct sunlight

If the child restraint system is exposed to direct sunlight or heat, parts could heat up. Children could suffer burns on these parts, particularly on metallic parts of the child restraint system.

- ▶ Always make sure that the child restraint system is not exposed to direct sunlight.
- ▶ Protect it with a blanket, for example.

- ▶ If the child restraint system has been exposed to direct sunlight, allow it to cool before securing a child into it.
- ▶ Never leave children unattended in the vehicle.

The use of seat belts and child restraint systems is required by law in:

- all 50 states
- the US territories
- the District of Columbia
- all Canadian provinces

All child restraint systems must meet the following standards:

- U.S. Federal Motor Vehicle Safety Standards 213 and 225
- Canadian Motor Vehicle Safety Standards 213 and 210.2

You can obtain further information about the correct child restraint system from any authorized Mercedes-Benz Center.

To improve protection for children younger than 12 years old and under 5 ft (1.50 m) in height, Mercedes-Benz recommends you observe the following notes:

- Only secure children using a child restraint system which is suitable and recommended for Mercedes-Benz vehicles, as well as appropriate to the height, age and weight of the child. Be sure to observe the instructions for correct use of the child restraint system.
- Always install a child restraint system on a rear seat if possible.
- Only use the following securing systems for child restraint systems:
  - the seat belt system
  - the LATCH-type (ISOFIX) mounting bracket
  - the Top Tether anchorages
- The manufacturer's installation instructions for the child restraint system.
- The warning labels in the vehicle interior and on the child restraint system.

**⚠ WARNING** Risk of injury caused by incorrect installation of the child restraint system

If the child restraint system is incorrectly installed on a suitable seating position, it cannot perform its intended protective function.

The child cannot be restrained in the event of an accident, heavy braking or a sudden change of direction. This poses an increased risk of injury or even fatal injury.

- ▶ Always comply with the manufacturer's installation instructions for the child restraint system and its correct use.
- ▶ Make sure that the entire base of the child restraint system always rests on the sitting surface of the seat.
- ▶ Never place objects under or behind the child restraint system, e.g. a cushion.
- ▶ Always use child restraint systems with the original cover designed for them.



- ▶ Always replace damaged covers with genuine covers.

**⚠ WARNING** Risk of accident caused by incorrectly installed child restraint systems

If the child restraint system is not correctly installed or secured, it could release in the event of an accident, sudden braking or a sudden change in direction.

The child restraint system could be flung around and hit vehicle occupants. This poses an increased risk of injury or even fatal injury.

- ▶ Always install child restraint systems correctly, even when not in use.
- ▶ Always comply with the child restraint system manufacturer's installation instructions.

**⚠ WARNING** Risk of injury caused by the use of damaged child restraint systems

Child restraint systems or their retaining systems that have been subjected to a load in an accident may then not be able to perform their intended protective function.

The child cannot be restrained in the event of an accident, heavy braking or a sudden change of direction. This poses an increased risk of injury or even fatal injury.

- ▶ Always replace child restraint systems immediately that have been damaged or involved in an accident.
- ▶ Have the securing systems for the child restraint systems checked at a qualified specialist workshop before installing a child restraint system again.

A booster seat may be necessary to achieve proper seat belt positioning for children over 40 lbs (18 kg) in weight until they reach a height where a three-point seat belt can be installed properly without a booster seat.

The following notes must be observed:

- When installing a child restraint system on the front passenger seat, the information on installing a child restraint system on the front passenger seat (→ page 51).
- Instructions and safety notes on the automatic front passenger air bag shutoff (→ page 39).
- Safety notes on the seat belt (→ page 32).
- Information on the correct use of the seat belt (→ page 36).

**Activating/deactivating the child seat safety feature of the seat belt**

**⚠ WARNING** Risk of injury or death if a seat belt is unfastened while the vehicle is in motion

If the seat belt is released while the vehicle is in motion, the child restraint system is no longer correctly secured. The child seat safety feature is deactivated and the seat belt is drawn in a bit by the inertia reel.

It is therefore not possible to engage the seat belt again.

- ▶ Pull over and stop the vehicle safely as soon as possible, paying attention to road and traffic conditions.
- ▶ Activate the child seat safety feature again and correctly secure the child restraint system.

When enabled, the special seatbelt retractor ensures that the seat belts of the rear seats do not slacken once the child restraint system is secured.

Always comply with the manufacturer's installation instructions when installing and removing the child restraint system.

#### Activating the child seat safety feature:

- ▶ Pull the seat belt out fully and let the inertia reel retract it again. When the child seat safety feature is activated, you should hear a ratcheting sound.
- ▶ Push the child restraint system down until the seat belt sits tightly.

#### Deactivating the child seat safety feature:

- ▶ Press the release button of the seat belt buckle.
- ▶ Hold the seat belt tongue and guide back to the seat belt outlet.

#### LATCH-type (ISOFIX) child seat attachment

##### Notes on LATCH-type (ISOFIX) child seat attachments

**⚠ WARNING** Risk of injury when using the LATCH-type (ISOFIX) child restraint system and exceeding the permissible weight

LATCH-type (ISOFIX) child restraint systems do not offer sufficient protection for children weighing more than 49 lb (22 kg) who are secured using the seat belt integrated in the child restraint system.

For example, the child may not be restrained correctly in the event of an accident. This poses an increased risk of injury or even fatal injury.

- ▶ If the child weighs more than 49 lb (22 kg), only use LATCH-type (ISOFIX) child restraint systems with which the child is secured using the seat belt of the vehicle seat.
- ▶ Also secure the child restraint system with the Top Tether belt, if available.

When installing a child restraint system, be sure to observe the manufacturer's installation instructions and the instructions for correct use of the child restraint system.

LATCH-type (ISOFIX) is a standardized securing system for special restraint systems. LATCH-type (ISOFIX) child restraint systems are approved in accordance with ECE R-44.

Only child restraint systems that have been approved in accordance with ECE R-44 may be attached to LATCH-type (ISOFIX) mounting brackets.



Symbol for installing a LATCH-type (ISOFIX) child restraint system

### Installing LATCH-type (ISOFIX) child seat attachments

**⚠ WARNING** Risk of injury when using the LATCH-type (ISOFIX) child restraint system and exceeding the permissible weight

LATCH-type (ISOFIX) child restraint systems do not offer sufficient protection for children weighing more than 49 lb (22 kg) who are secured using the seat belt integrated in the child restraint system.

For example, the child may not be restrained correctly in the event of an accident. This poses an increased risk of injury or even fatal injury.

- ▶ If the child weighs more than 49 lb (22 kg), only use LATCH-type (ISOFIX) child restraint systems with which the child is secured using the seat belt of the vehicle seat.
- ▶ Also secure the child restraint system with the Top Tether belt, if available.

When installing a child restraint system, be sure to observe the manufacturer's installation instructions and the instructions for correct use of the child restraint system.

Before every trip, make sure that the LATCH-type (ISOFIX) child restraint system is engaged correctly in both LATCH-type (ISOFIX) mounting brackets.

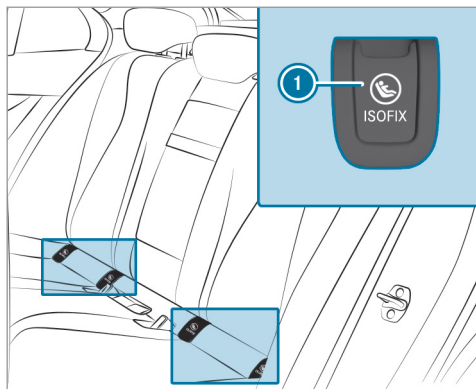

### ① LATCH-type (ISOFIX) mounting brackets

**!** **NOTE** Damage to the seat belt for the center seat

When installing a child restraint system, the seat belt for the center seat could be damaged.

▶ Make sure that the seat belt is not trapped.

- ▶ Remove each cover for LATCH-type (ISOFIX) mounting brackets ①.
- ▶ Attach the LATCH-type (ISOFIX) child restraint system to both LATCH-type (ISOFIX) mounting brackets ①.
- ▶ After removing the child seat, replace each cover for LATCH-type (ISOFIX) mounting brackets ①.

### Securing Top Tether

**!** **WARNING** Risk of injury if the seat backrests of the rear seats are not locked after installing the Top Tether belts

If the rear seat backrests are not locked, they could fold forwards in the event of an accident, heavy braking or sudden changes of direction.

As a result, child restraint systems cannot perform their intended protective function. Rear seat backrests that are not locked can also cause additional injuries, e.g. in the event of an accident. This poses an increased risk of injury or even fatal injury.

- ▶ Always lock the rear seat backrests after installing the Top Tether belts.
- ▶ Observe the lock verification indicator.

If the seat backrest is not engaged and locked, this will be shown in the multifunction display in the instrument cluster.

The risk of injury can be reduced by Top Tether as Top Tether provides an additional connection between the child restraint system secured with LATCH-type (ISOFIX) and the vehicle.

The child restraint system must be equipped with a Top Tether belt.

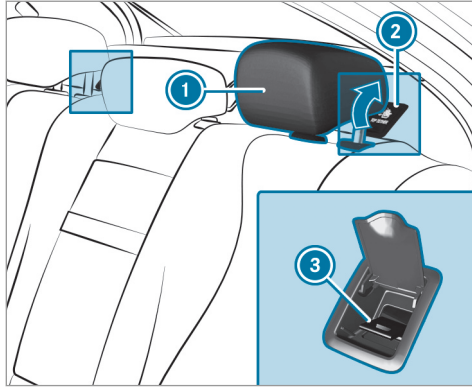

- ▶ If necessary, move head restraint ① upwards (→ page 87).
- ▶ Fold up cover ② of Top Tether anchorage ③.
- ▶ Install the LATCH-type (ISOFIX) child restraint system with Top Tether. Always comply with the child restraint system manufacturer's installation instructions when doing so.

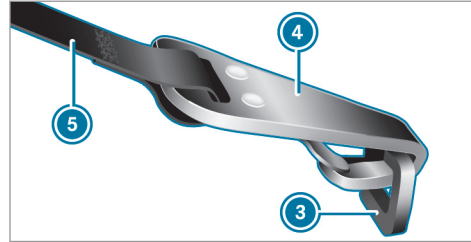

- ▶ Route Top Tether belt ⑤ under head restraint ① between the two head restraint bars.
- ▶ Hook Top Tether hook ④ of Top Tether belt ⑤ without twisting into Top Tether anchorage ③.
- ▶ Tension Top Tether belt ⑤. Always comply with the child restraint system manufacturer's installation instructions when doing so.
- ▶ Fold down cover ② of Top Tether anchorage ③.
- ▶ If necessary, move head restraint ① downwards (→ page 87). Make sure that you do

not interfere with the correct routing of Top Tether belt ⑤.

### Child restraint systems on the front passenger seat

#### Notes on child restraint systems on the front passenger seat

Accident statistics show that children secured in the rear seats are safer than children secured in front seats. For this reason, Mercedes-Benz strongly advises that you install a child restraint system on a rear seat.

If it is absolutely necessary to install a child restraint system on the front passenger seat, always observe the information on the automatic front passenger air bag shutoff (→ page 39).

By doing this, you can avoid risks caused by:

- A child restraint system that is not detected by the automatic front passenger air bag shutoff.
- The unintentionally deactivated front passenger air bag.

- Incorrect positioning of the child restraint system.

### Forward-facing and rearward-facing child restraint systems on the front passenger seat

When using a rearward-facing child restraint system on the front passenger seat, the front passenger airbag must always be disabled. This is only the case if the PASSENGER AIR BAG OFF indicator lamp is lit continuously (→ page 41).

When using a child restraint system on the front passenger seat, it is essential to observe the following:

- Move the front passenger seat as far back as possible.
- Retract the seat cushion length as far as possible.
- The entire base of the child restraint system must always rest on the sitting surface of the front passenger seat.
- The backrest of the forward-facing child restraint system must lie as flat as possible against the backrest of the front passenger seat. The child restraint system must not

touch the roof or be put under strain by the head restraints.

- Adjust the angle of the seat backrest and the head restraint position accordingly.
- Move the seat cushion inclination to the highest, most vertical position.
- Always make sure that the shoulder belt strap is correctly routed from the seat belt outlet of the vehicle to the shoulder belt guide on the child restraint system. The shoulder belt strap must be routed forwards and downwards from the seat belt outlet.
- If necessary, adjust the seat belt outlet and the front passenger seat accordingly.
- Never place objects under or behind the child restraint system, e.g. a cushion.

Always comply with the manufacturer's installation and operating instructions for the child restraint system used.

### Child safety locks

#### Activating/deactivating the child safety lock for the rear doors

**⚠ WARNING** Risk of accident and injury due to children left unattended in the vehicle

If you leave children unaccompanied in the vehicle, they may be able to set the vehicle in motion, for example by:

- Releasing the parking brake.
- Shifting the transmission out of park position **P**.
- Starting the engine.

In addition, they may operate vehicle equipment.

- ▶ Never leave children and animals unattended in the vehicle.
- ▶ When leaving the vehicle, always take the SmartKey with you and lock the vehicle.

**⚠ WARNING** Risk of fatal injury due to exposure to extreme heat or cold in the vehicle

If people – particularly children – are exposed to extreme heat or cold over an extended period of time, there is a risk of injury or even fatal injury.

- ▶ Never leave anyone – particularly children – unattended in the vehicle.

**⚠ WARNING** There is a risk of accident and injury if you leave children unattended in the vehicle

If children are traveling in the vehicle, they could:

- Open doors, thereby endangering other persons or road users.
- Get out of the vehicle and be hit by oncoming traffic.
- Operate vehicle equipment and become trapped, for example.

- ▶ Always activate the child safety locks available if children are traveling in the vehicle.
- ▶ Never leave children unattended in the vehicle.
- ▶ When leaving the vehicle, always take the SmartKey with you and lock the vehicle.

Child safety locks are available for the rear doors and for the rear side windows. The child safety lock on the rear doors secures each door separately. The doors can no longer be opened from the inside.

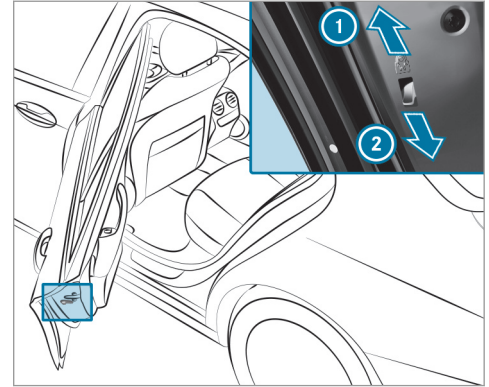

- ▶ Press the lever in direction **① (activate)** or **② (deactivate)**.
- ▶ Make sure that the child safety locks are working properly.

### Activating/deactivating the child safety lock for the rear side windows

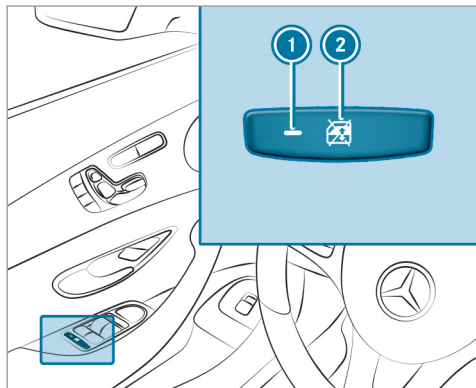

► **To activate/deactivate:** press button ②.

Opening/closing the side windows in the rear passenger compartment is possible:

- With indicator lamp ① lit: via the switch on the driver's door.

- With indicator lamp ① off: via the switch on the corresponding rear door or driver's door.

### Pets in the vehicle

**⚠ WARNING** Risk of accident and injury due to animals left unattended in the vehicle

If you leave animals in the vehicle unattended or unsecured, they could possibly press down buttons or switches.

Thereby an animal may:

- activate vehicle equipment and become trapped, for example.
- switch systems on or off and endanger other road users.

Unsecured animals may be thrown around in the vehicle in the event of an accident or sudden steering and braking maneuvers and injure vehicle occupants in the process.

- Never leave animals in the vehicle unattended.
- Always correctly secure animals while driving, e.g. using a suitable animal carrier.



## SmartKey

### Overview of key functions

**⚠ WARNING** - Danger of accident or injury if children are left unattended in the vehicle

If children are left unattended in the vehicle, they could:

- open doors, thereby endangering other persons or road users.
- get out of the vehicle and be hit by oncoming traffic.
- operate vehicle equipment.

Moreover, children could also set the vehicle in motion by, for example:

- releasing the parking brake.
- shifting the automatic transmission out of park position P **P** or shifting manual transmission into idle position.
- starting the engine.

- ▶ Never leave children and animals unattended in the vehicle.
- ▶ When leaving the vehicle, always take the key with you and lock the vehicle.
- ▶ Keep the vehicle key out of the reach of children.

**⚠ NOTE** Damage to the key caused by magnetic fields

- ▶ Keep the key away from strong magnetic fields.

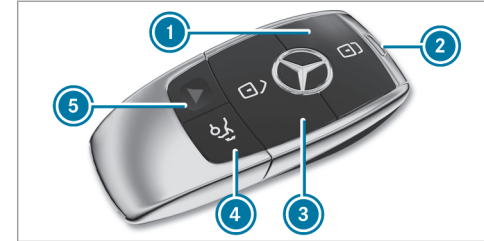

- ① Locks
- ② Battery check lamp
- ③ Unlocks
- ④ Opens/closes the trunk lid
- ⑤ Panic alarm

The SmartKey locks and unlocks the following components:

- The doors
- The trunk lid
- The fuel filler flap

If you do not open the vehicle within approximately 40 seconds after unlocking:

- The vehicle is locked again.
- Anti-theft protection is reactivated.

Do not keep the SmartKey together with electronic devices or metal objects. This can affect the functionality of the SmartKey.

**i** If battery check lamp **2** does not light up after pressing the  or  button, the battery is discharged.

### Activating/deactivating the acoustic locking verification signal

Multimedia system:

➔ Vehicle ➔  Vehicle Settings ➔ Acoustic Lock

▶ Activate  or deactivate  the function.

### Priming/deactivating the panic alarm

#### Prerequisites

- Ignition switched off.



▶ **To prime:** press button **1** for approximately one second.  
A visual and audible alarm is triggered.



▶ **To deactivate:** briefly press button **1** again.  
or

▶ Press the start/stop button on the cockpit (the SmartKey is inside the vehicle).

### Changing the unlocking settings

Possible unlocking functions of the key:

- Central unlocking
- Unlocking the driver's door and fuel filler flap

▶ **To switch between settings:** press the  and  buttons simultaneously for approximately six seconds until the battery check lamp flashes twice.

If the unlocking function for the driver's door and fuel filler flap has been selected:

- Pressing the  button a second time centrally unlocks the vehicle.
- **Vehicles with KEYLESS-GO:** If you touch the inner surface of the door handle on the driver's door, only the driver's door and fuel filler flap are unlocked.

### Reducing the energy consumption of the SmartKey

If you do not intend to use the vehicle for an extended period of time, you can deactivate the following functions on the SmartKey.

- KEYLESS-GO starting function
- KEYLESS-GO

- ▶ **To deactivate:** press the  button on the SmartKey twice in rapid succession. The battery check lamp of the SmartKey flashes twice briefly and lights up once.
- ▶ **To activate:** press any button on the SmartKey.
- ⓘ When the vehicle is started with the SmartKey in the stowage compartment of the center console (→ page 130), the SmartKey functions are automatically activated.

### Inserting/removing the emergency key

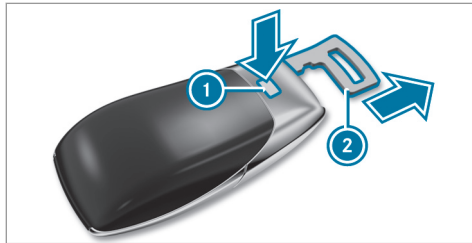

- ▶ Press release knob ①.
- ▶ Emergency key ② is pushed out slightly.
- ▶ Pull out emergency key ② until it engages.
- ⓘ You can use the emergency key in this position to attach the SmartKey onto a key ring.
- ▶ Press release knob ① again and remove the emergency key.
- ▶ **To insert:** insert the emergency key along the inside of the SmartKey until it engages.
- ▶ Press release knob ① and press in the emergency key fully until it engages.

### Replacing the SmartKey battery

**⚠ DANGER** Serious damage to health caused by swallowing batteries

Batteries contain toxic and corrosive substances. Swallowing batteries may cause serious damage to health.

There is a risk of fatal injury.

- ▶ Keep batteries out of the reach of children.
- ▶ If batteries are swallowed, seek medical attention immediately.

**!** **ENVIRONMENTAL NOTE** Environmental damage caused by improper disposal of batteries



Batteries contain pollutants. It is illegal to dispose of them with the household rubbish.



Dispose of batteries in an environmentally responsible manner. Take discharged batteries to a qualified specialist workshop or to a collection point for used batteries.

### Prerequisites

You require a CR 2032 3 V cell battery.

Mercedes-Benz recommends that you have the battery replaced at a qualified specialist workshop.

- ▶ Remove the emergency key (→ page 57).



- ▶ Press release button ② down fully and remove cover ①.
- ▶ Remove battery compartment ③.
- ▶ Insert the new battery into battery compartment ③. Observe the positive pole marking in the battery compartment and on the battery.
- ▶ Push in battery compartment ③.
- ▶ Replace cover ① so that it engages.

### Problems with the SmartKey

Problem	Possible causes/consequences and ▶ Solutions
You can no longer lock or unlock the vehicle.	Possible causes are: <ul style="list-style-type: none"><li>• The SmartKey battery is discharged or nearly discharged.</li><li>• There is interference from a powerful radio signal source.</li></ul>

Problem	Possible causes/consequences and ► Solutions
	<ul style="list-style-type: none"><li>• The SmartKey is faulty.</li><li>► Check the battery using the battery check lamp and replace if necessary .</li><li>► Use the emergency key to lock or unlock the vehicle .</li><li>► Have the SmartKey checked at a qualified specialist workshop.</li></ul>
You have lost a SmartKey.	<ul style="list-style-type: none"><li>► Have the SmartKey deactivated at a qualified specialist workshop.</li><li>► If necessary, have the mechanical locking mechanism changed as well.</li></ul>

## Doors

### Unlocking and opening doors from the inside

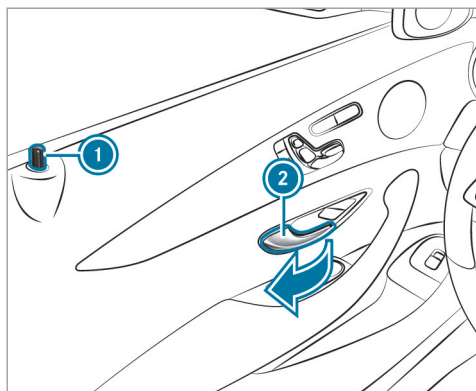

- ▶ **To unlock and open a front door:** pull door handle ②. Locking pin ① pops up when the door is unlocked.

- ▶ **To unlock a rear door:** pull the rear door handle. The locking pin pops up when the rear door is unlocked.
- ▶ **To open a rear door:** pull the rear door handle again.

### Locking/unlocking the vehicle centrally from the inside

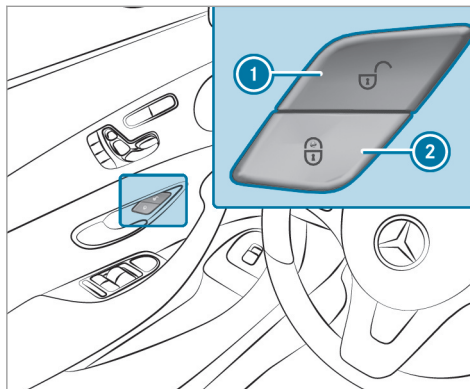

- ▶ **To unlock:** press button ①.
- ▶ **To lock:** press button ②.

This does not lock or unlock the fuel filler flap.

The vehicle is not unlocked:

- If you have locked the vehicle using the SmartKey.
- If you have locked the vehicle using KEY-LESS-GO.

### Locking and unlocking the vehicle with KEY-LESS-GO

#### Prerequisites

- The SmartKey must be outside the vehicle.
- The distance between the SmartKey and the vehicle must not exceed 3 ft (1 m).
- The driver's door and the door of the handle being used must both be closed.

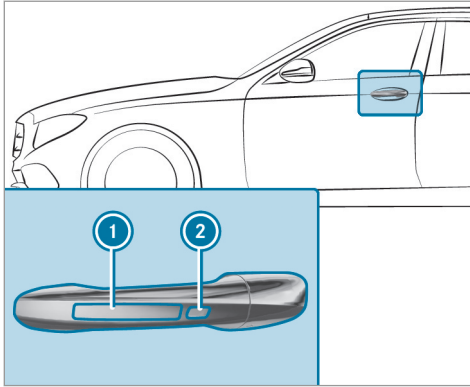

▶ **To unlock the vehicle:** touch the inner surface of the door handle.

▶ **To lock the vehicle:** touch sensor surface ① or ②.

▶ **Convenience closing:** touch recessed sensor surface ② for an extended period.

ⓘ For further information on convenience closing (→ page 72).

If you pull the handle of the trunk lid, the trunk lid is automatically unlocked.

### Problems with KEYLESS-GO

Problem	Possible causes/consequences and ▶ Solutions
<p>You can no longer lock or unlock the vehicle using KEYLESS-GO.</p>	<p>Possible causes are:</p> <ul style="list-style-type: none"> <li>• KEYLESS-GO has been deactivated (→ page 56).</li> <li>• The SmartKey battery is discharged or nearly discharged.</li> <li>• There is interference from a powerful radio signal source.</li> </ul>

Problem	Possible causes/consequences and ► Solutions
	<ul style="list-style-type: none"> <li>• The SmartKey is malfunctioning.</li> <li>► Activate KEYLESS-GO .</li> <li>► Check the battery using the battery check lamp and replace if necessary .</li> <li>► Use the mechanical key to lock or unlock the vehicle .</li> <li>► Have the vehicle and SmartKey checked at a qualified specialist workshop.</li> </ul>

### Switching the automatic locking feature on/off

The vehicle is locked automatically when the ignition is switched on and the wheels are turning faster than walking pace.

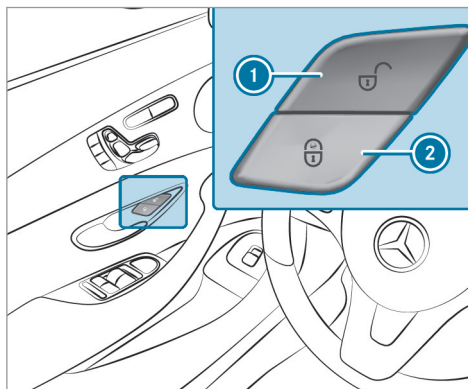

► **To deactivate:** press and hold button ① for approximately five seconds until an acoustic signal sounds.

► **To activate:** press and hold button ② for approximately five seconds until an acoustic signal sounds.

Danger of being locked out when the function is activated:

- If the vehicle is being tow started/pushed.
- On a roller dynamometer.



### Unlocking/locking the driver's door using the emergency key

- i** If you wish to lock the vehicle entirely using the emergency key, first press the button for locking from the inside while the driver's door is open. Then proceed to lock the driver's door using the emergency key.

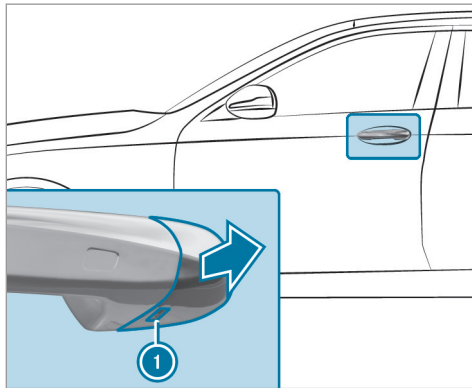

- ▶ Insert the emergency key into opening **1** in the cover.
- ▶ Pull and hold the door handle.
- ▶ Pull the cover on the emergency key as straight as possible away from the vehicle until it releases.
- ▶ Release the door handle.

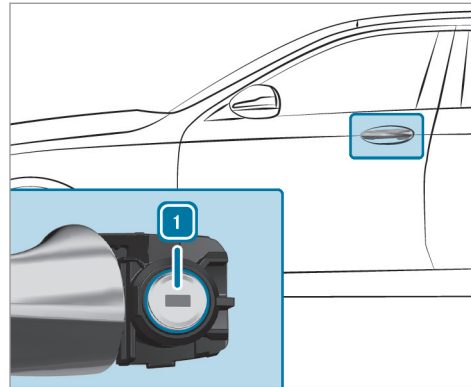

- ▶ **To unlock:** turn the emergency key counter-clockwise to position **1**.
- ▶ **To lock:** turn the emergency key clockwise to position **1**.
- ▶ Carefully press the cover onto the lock cylinder until it engages and is seated firmly.

### Trunk

#### Opening the trunk lid

#### **⚠ WARNING** Risk of exhaust gas poisoning

Combustion engines emit poisonous exhaust gases such as carbon monoxide. Exhaust gases can enter the vehicle interior if the trunk lid is open when the engine is running, especially if the vehicle is in motion.

- ▶ Always switch off the engine before opening the trunk lid.
- ▶ Never drive with the trunk lid open.

**NOTE** Damage to the trunk lid by obstacles above the vehicle

The trunk lid swings upwards when it is opened.

- ▶ Therefore, make sure that there is sufficient clearance above the trunk lid.

You have the following options to open the trunk lid:

- ▶ Pull the trunk lid handle.
- ▶ Press and hold the  button on the SmartKey.

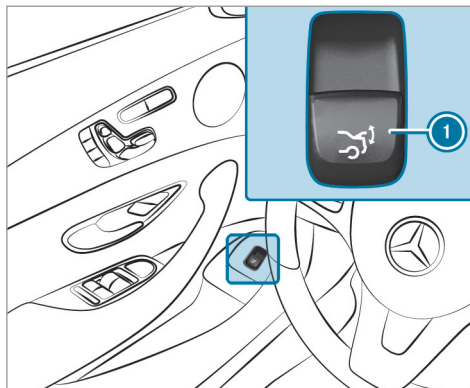

- ▶ Pull trunk lid remote operating switch ①.
- ▶ **Vehicles with HANDS-FREE ACCESS:** Move your foot below the bumper (→ page 66).

**Vehicles with trunk lid convenience closing:**

If an object restricts the trunk lid during the automatic opening process, the obstacle detection stops the trunk lid. The obstacle detection function is only an aid and is not a substitute for your attentiveness.

### Closing the trunk lid

**WARNING** Risk of injury from unsecured items in the vehicle

If objects, luggage or loads are not secured or not secured sufficiently, they could slip, tip over or be flung around and thereby hit vehicle occupants.

There is a risk of injury, particularly in the event of sudden braking or a sudden change in direction.

- ▶ Always store objects in such a way that they cannot be flung around.
- ▶ Before the journey, secure objects, luggage or loads against slipping or tipping over.

**WARNING** Risk of becoming trapped during automatic closing of the trunk lid

Parts of the body could become trapped during automatic closing of the trunk lid. Moreover, people, e.g. children, may be standing

in the closing area or may enter the closing area during the closing process.

- ▶ Make sure that nobody is in the vicinity of the closing area during the closing process.

Use one of the following options to stop the closing process:

- press the  button on the SmartKey.
- press or pull the remote operating switch on the driver's door.
- press the closing or locking button on the trunk lid.
- pull the trunk lid handle.

**Vehicles with HANDS-FREE ACCESS:** It is also possible to stop the closing process by performing a kicking movement under the rear bumper.

You have the following options to close the trunk lid:

- ▶ Pull the trunk lid down using the handle recess and push it closed.

▶ **Vehicles with trunk lid convenience closing:** Pull the trunk lid handle.

▶ **Vehicles with trunk lid convenience closing:** Press and hold the  button on the SmartKey (with the SmartKey in the vicinity of the vehicle).

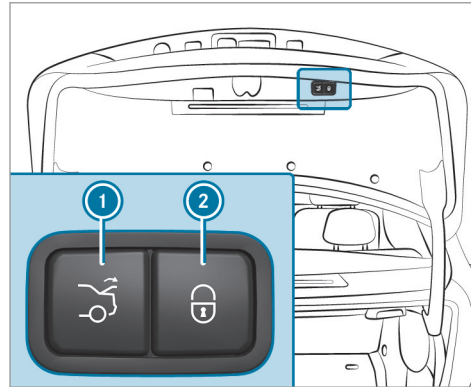

▶ **Vehicles with trunk lid convenience closing:** Press closing button  in the trunk lid.

▶ **Vehicles with trunk lid convenience closing and KEYLESS-GO:** Press locking button  in the trunk lid.

If a SmartKey is detected outside the vehicle, the trunk lid closes and the vehicle is locked.

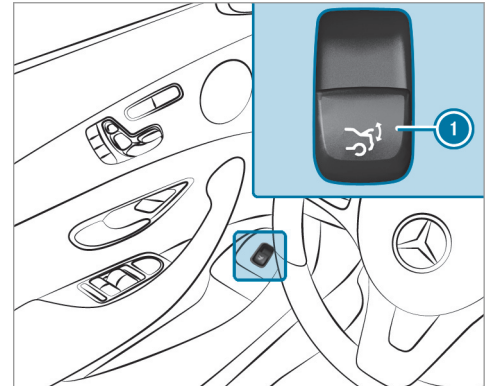

▶ **Vehicles with trunk lid convenience closing:** Press trunk lid remote operating switch .

▶ **Vehicles with HANDS-FREE ACCESS:** Move your foot below the bumper (→ page 66).

#### Automatic reversing function of the trunk lid

If an object restricts the trunk lid during the automatic closing process, the trunk lid opens again automatically. The automatic reversing function is only an aid and is not a substitute for your attentiveness.

▶ When closing, make sure that no body parts are in the closing area.

**⚠ WARNING** Risk of becoming trapped despite reversing function

The reversing function does not react:

- to soft, light and thin objects, e.g. fingers.
- over the last  $\frac{1}{3}$  in (8 mm) of the closing path.

In these situations in particular, the reversing function cannot prevent someone being trapped.

▶ When closing, make sure that no body parts are in the closing area.

If someone is trapped:

- press the  button on the SmartKey, or
- press the remote operating switch on the driver's door, or
- press the closing or locking button on the trunk lid, or
- pull the trunk lid handle.

#### HANDS-FREE ACCESS function

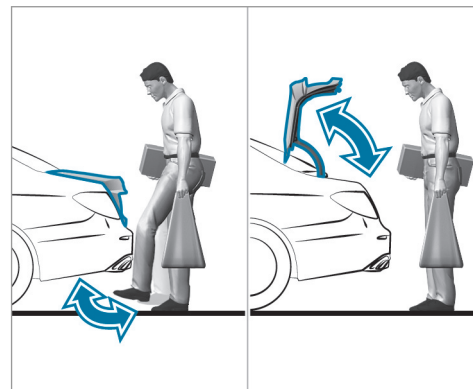

With HANDS-FREE ACCESS you can open, close or stop the closing process of the trunk lid by performing a kicking movement under the bumper.

The kicking movement triggers the opening or closing process alternately.

Observe the notes when opening (→ page 63) and closing (→ page 64) the trunk lid.

**i** A warning tone sounds while the trunk lid is opening or closing.

**⚠ WARNING** Risk of burns caused by a hot exhaust system

The vehicle exhaust system can become very hot. If you use HANDS-FREE ACCESS, you could burn yourself by touching the exhaust system.

- ▶ Always ensure that you only make a kicking movement within the detection range of the sensors.

**! NOTE** Damage to the vehicle caused by unintentionally opening the trunk lid

- When using an automatic car wash
- When using a high pressure cleaner
- ▶ Deactivate KEYLESS-GO or make sure that the SmartKey located is at least

10 ft (3 m) away from the vehicle in such situations.

When making the kicking movement, make sure that you are standing firmly on the ground you could otherwise lose your balance, e.g. on ice.

**Requirements:**

- The SmartKey is behind the vehicle.
- Stand at least 12 in (30 cm) away from the vehicle while performing the kicking movement.
- Do not come into contact with the bumper while making the kicking movement.
- Do not carry out the kicking movement too slowly.
- The kicking movement must be towards the vehicle and back.

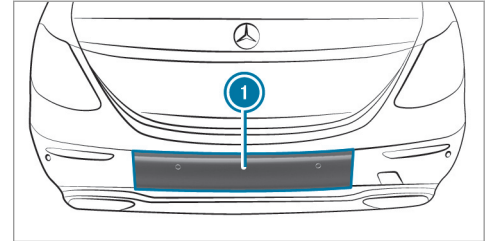

**1** Sensor detection range

If several consecutive kicking movements are not successful, wait ten seconds.

**System limitations**

The system may be impaired or may not function if:

- The area around the sensor is dirty, e.g. road salt.
- The kicking movement is made using a prosthetic leg.

The trunk lid could thus be opened or closed unintentionally, in the following situations:

- If persons' arms or legs move in the sensor detection range, e.g. when polishing the vehicle, sitting on the edge of the trunk, or picking up objects.
- If objects are guided behind or placed behind the vehicle, e.g. charging cables, tensioning straps or luggage.
- When working on the trailer coupling, trailers or rear bicycle racks.

Deactivate KEYLESS-GO (→ page 56) or do not carry the SmartKey about your person in such situations.

### Switching separate trunk locking on/off

If you centrally unlock the vehicle while separate locking is activated, the trunk remains locked.

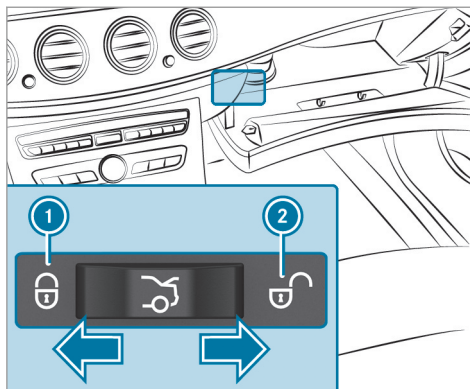

- ▶ **To switch on:** slide the switch to position ①.
  - ▶ **To switch off:** slide the switch to position ②.
- ① If an accident has been detected, the trunk unlocks even if separate locking is switched on.

### Unlocking the trunk from inside with the emergency release

#### Prerequisites

The 12 V vehicle battery is connected and charged.

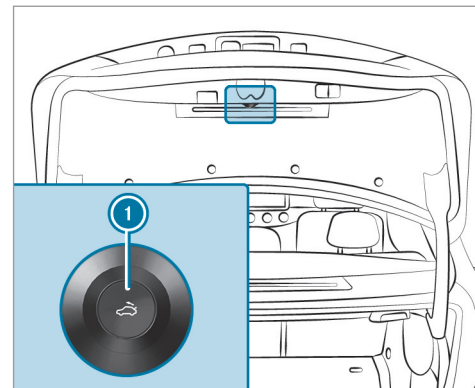

- ▶ Press emergency release button ① briefly. The trunk lid is unlocked and opens.

### Activating/deactivating the trunk lid opening height restriction

Multimedia system:

→ Vehicle →  Vehicle Settings → Trunk Lid Restriction

Activating the function allows you to avoid bumping the trunk lid on a low garage ceiling, for example.

▶ Activate  or deactivate  the function.

### Roller sun blinds

#### Extending the rear side window roller sunblinds

**!** **NOTE** Damage to the inertia reel due to it snapping back

If suddenly snapped back, the inertia reel may be damaged.

▶ Always move the roller sun blind by hand.

▶ Do not drive with the roller sun blind hooked in and side windows opened at the same time.

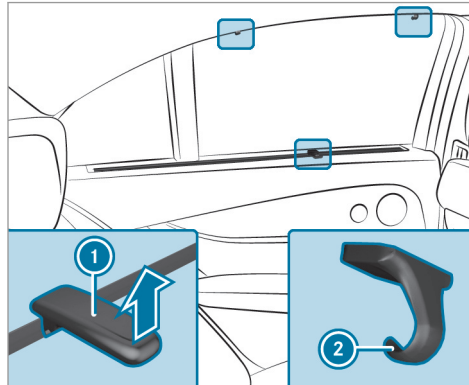

▶ Pull the roller sunblind out by tab ① and hook it onto brackets ② at the top of the window.

### Extending/retracting the rear window roller sunblind

**!** **WARNING** Risk of entrapment when extending or retracting the roller sun blind

Body parts could become entrapped in the sweep of the roller sun blind when it is being extended or retracted.

▶ Make sure that no body parts are in the sweep of the roller sun blind when it is being extended or retracted.

▶ If someone becomes trapped, briefly press the button again. The opening or closing process is briefly stopped. The roller sun blind then returns to its starting position.

**!** **NOTE** Damage caused by objects

▶ Make sure that the roller sun blind can move freely.

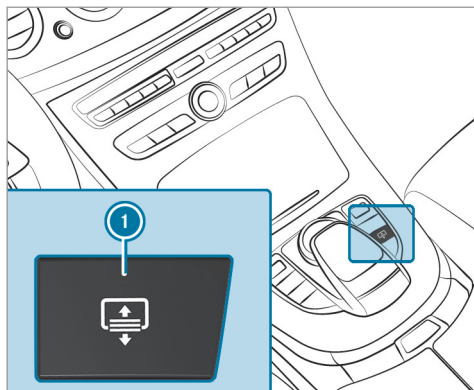

▶ **To extend or retract:** press button ①.

## Side windows

### Opening/closing the side windows

**⚠ WARNING** Risk of entrapment when opening a side window

When opening a side window, parts of the body could be drawn in or become trapped between the side window and window frame.

- ▶ When opening, make sure that nobody is touching the side window.
- ▶ If someone is trapped, release the button immediately or pull it in order to close the side window again.

**⚠ WARNING** Risk of becoming trapped when closing a side window

When closing a side window, body parts could be trapped in the closing area in the process.

- ▶ When closing, make sure that no body parts are in the closing area.

- ▶ If someone is trapped, release the button immediately or press the button in order to reopen the side window.

**⚠ WARNING** Risk of becoming trapped when children operate the side windows

Children could become trapped if they operate the side windows, particularly when unattended.



- ▶ Activate the child safety lock for the rear side windows.
- ▶ When leaving the vehicle, always take the SmartKey with you and lock the vehicle.
- ▶ Never leave children unattended in the vehicle.

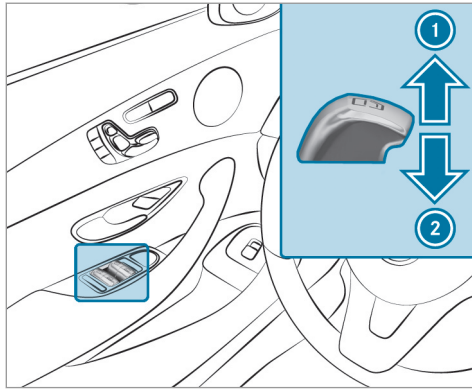



- ① To close
- ② To open

The buttons in the driver's door take precedence.

- ▶ **To start automatic operation:** press/pull the  button beyond the pressure point.
- ▶ **To interrupt automatic operation:** press or pull the  button again.

### Automatic reversing function for the side windows

If an object blocks a side window during the closing process, the side window opens again automatically. The automatic reversing function is only an aid and is not a substitute for your attentiveness.

- ▶ When closing, make sure that no body parts are in the closing area.

**⚠ WARNING** Risk of becoming trapped despite reversing protection on the side window

The reversing function does not react:

- to soft, light and thin objects, e.g. small fingers.
- over the last 1/6 in (4 mm) of the closing path.
- during resetting.
- when closing the side window again manually immediately after automatic reversing.

This means that the reversing function cannot prevent someone from becoming trapped in these situations.

- ▶ When closing, make sure that no body parts are in the closing area.
- ▶ If someone becomes trapped, press the  button to open the side window again.

### Ventilating the vehicle before starting a journey (convenience opening)

**⚠ WARNING** Risk of entrapment when opening a side window

When opening a side window, parts of the body could be drawn in or become trapped between the side window and window frame.

- ▶ When opening, make sure that nobody is touching the side window.
- ▶ Release the button immediately if somebody becomes trapped.

- ▶ Press and hold the  button on the SmartKey.

The following functions are performed:

- The vehicle is unlocked.
- The side windows are opened.
- The sliding sunroof is opened.
- The panoramic sliding sunroof is opened.
- The seat ventilation of the driver's seat is switched on.

If the roller sunblinds of the panoramic sliding sunroof are closed, the roller sunblinds are opened first.

- ▶ **To continue the opening procedure:** press the  button again.

- ▶ **To interrupt convenience opening:** release the  button.

### Closing side windows from the outside (convenience closing)

**⚠ WARNING** Risk of entrapment caused by inadvertent convenience closing

When the convenience closing feature is operating, parts of the body could become trapped in the closing area of the side window and the sliding sunroof.



- ▶ Observe the complete closing procedure when using convenience closing.

- ▶ When closing, make sure that no body parts are in the closing area.

- ▶ Press and hold the  button on the SmartKey.

The following functions are performed:

- The vehicle is locked.
- The side windows are closed.
- The sliding sunroof is closed.
- The panoramic sliding sunroof is closed.

- ▶ **To close the roller sunblinds:** press the  button again.
- ▶ **To interrupt convenience closing:** release the  button.

- ⓘ Convenience closing can also be operated with KEYLESS-GO (→ page 60).

### Problems with the side windows

Problem	Possible causes/consequences and ▶ Solutions
A side window cannot be closed and you cannot see the cause.	▶ Check to see if any objects are in the window guide.

Problem	Possible causes/consequences and ► Solutions
	<p><b>▲ WARNING</b> Risk of entrapment if reversing protection is not activated</p> <p>If you close a side window again immediately after it has been blocked or reset, the side window closes with increased or maximum force. The reversing function is then not active.</p> <p>Parts of the body could be trapped in the closing area in the process.</p> <ul style="list-style-type: none"><li>▶ Make sure that no parts of the body are in the closing area.</li><li>▶ To stop the closing process, release the button or press the button again to reopen the side window.</li></ul> <p>If a side window is obstructed during closing and reopens again slightly:</p> <ul style="list-style-type: none"><li>▶ Immediately after the window blocks, pull the corresponding button again until the side window has closed, and hold the button for an additional second. The side window is closed with increased force.</li></ul> <p>If a side window is obstructed again during closing and reopens again slightly:</p> <ul style="list-style-type: none"><li>▶ Repeat the previous step. The side window is closed without the automatic reversing function.</li></ul>

## Sliding sunroof

### Opening/closing the sliding sunroof

- ① The term "sliding sunroof" also refers to the panoramic sliding sunroof.

**⚠ WARNING** Risk of becoming trapped while opening and closing the sliding sunroof

During opening and closing, parts of the body could get caught in the sweep of the sliding sunroof.

- ▶ When opening or closing, make sure that no body parts are in the sweep.
  - ▶ Release the button immediately if somebody becomes trapped.
- or
- ▶ Press the button in any direction during the automatic opening/closing process. The opening/closing process is stopped.

**⚠ WARNING** Risk of becoming trapped if the sliding sunroof is operated by children

Children operating the sliding sunroof could get caught in the moving parts, particularly if unattended.

- ▶ Never leave children unattended in the vehicle.
- ▶ When leaving the vehicle, always take the key with you and lock the vehicle.

**⚠ WARNING** Risk of becoming trapped while opening and closing the roller sun blind

When opening or closing, make sure that no body parts become trapped between the roller sun blind and frame or the sliding sunroof.

- ▶ When opening or closing, make sure that no body parts are in the sweep of the roller sun blind.

- ▶ Release the button immediately if somebody becomes trapped.

or

- ▶ Press the button in any direction during the automatic opening/closing process. The opening/closing process is stopped.

**! NOTE** Malfunction caused by snow and ice

Snow and ice may lead to a malfunction of the sliding sunroof.

- ▶ Only open the sliding sunroof if it is free of snow and ice.

**! NOTE** Damage caused by protruding objects

Objects that protrude from the sliding sunroof may damage the sealing strips.

- ▶ Do not allow anything to protrude from the sliding sunroof.

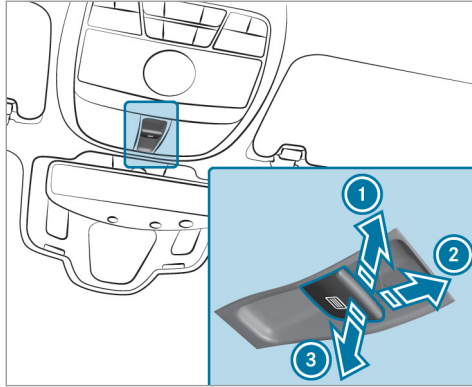



- ① To raise
- ② To open
- ③ To close/lower

Use the  button to operate the sliding sunroof and the roller sunblind.

- The panoramic sliding sunroof can only be opened when the roller sunblind is open.

- The roller sunblind can only be operated when the sliding sunroof is closed.

- ▶ **To start automatic operation:** press/pull the  button beyond the pressure point.
- ▶ **To interrupt automatic operation:** press or pull the  button again.

Restrictions:

- **Vehicles without a panoramic sliding sunroof:** The automatic opening and raising feature is available only when the sliding sunroof is closed.
- **Vehicles without a panoramic sliding sunroof:** The automatic raising feature is only available when the sliding sunroof is closed or raised.
- The panoramic sliding sunroof cannot be opened if a roof rack is mounted. The panoramic sliding sunroof closes again automatically when it encounters resistance.

#### Automatic reversing function of the sliding sunroof

If there is an object obstructing the sliding sunroof during the closing process, the sliding sun-

roof opens again automatically. The automatic reversing function is only an aid and is not a substitute for your attentiveness.

- ▶ When closing, make sure that no body parts are in the closing area.

**⚠ WARNING** Risk of becoming trapped despite the reversing function being active

The reversing function does not react:

- to soft, light and thin objects, e.g. small fingers
- during the last 1/6 in (4 mm) of the closing path
- during resetting
- when closing the sliding sunroof again manually immediately after automatic reversing

This means that the reversing function cannot prevent someone being trapped in these situations.

- ▶ When closing, make sure that no body parts are in the closing area.
- ▶ Release the button immediately if somebody becomes trapped.

or

- ▶ Press the button in any direction during the automatic closing process. The closing process is stopped.

#### Automatic reversing function of the roller sunblind

If there is an object obstructing the roller sunblind during the closing process, the roller sunblind opens again automatically. The automatic reversing function is only an aid and is not a substitute for your attentiveness.

- ▶ When opening or closing the roller sunblind, make sure that no body parts are in the sweep.

**⚠ WARNING** Risk of becoming trapped despite the reversing function being active

In particular, the reversing function does not react to soft, light and thin objects, for example small fingers.

This means that the reversing function cannot prevent entrapment in these situations.

- ▶ When opening or closing the roller sunblind, make sure that no body parts are in the sweep.
- ▶ Release the button immediately if somebody becomes trapped.

or

- ▶ Press the button in any direction during the automatic closing process. The closing process is stopped.

#### Automatic features of the sliding sunroof

- ⓘ The term "sliding sunroof" also refers to the panoramic sliding sunroof.

By pushing or pulling the  button you can interrupt the automatic functions: "Rain closing function when driving" and "Automatic lowering feature".

**Rain closing function when driving**  
**Vehicles with a panoramic sliding sunroof:** if it starts to rain, the raised sliding sunroof is automatically lowered while the vehicle is in motion.

**Automatic lowering feature**  
**Vehicles with a panoramic sliding sunroof:** if the sliding sunroof is raised at the rear, the sliding sunroof is automatically lowered slightly at higher speeds. At low speeds it is raised again automatically.

**⚠ WARNING** Risk of entrapment by automatic lowering of the sliding sunroof

At high speeds the raised sliding sunroof automatically lowers slightly at the rear.

This could trap you or other persons.

- ▶ Make sure that nobody reaches into the sweep of the sliding sunroof whilst the vehicle is in motion.
- ▶ If somebody becomes trapped, immediately pull back the sliding sunroof button.  
The sliding sunroof lifts during opening.

### Problems with the sliding sunroof

- ❗ The term "sliding sunroof" also refers to the panoramic sliding sunroof.

#### Problem

The sliding sunroof cannot be closed and you cannot see the cause.

#### Possible causes/consequences and ▶ Solutions

**⚠ WARNING** Risk of becoming trapped by closing the sliding sunroof again

If you close the sliding sunroof again immediately after it has been blocked or reset, the sliding sunroof closes with increased or maximum force.







The reversing function is then not active. Parts of the body could be trapped in the closing area in the process. This poses an increased risk of injury or even fatal injury.

- ▶ Make sure that no parts of the body are in the closing area.
- ▶ Release the button immediately if somebody becomes trapped.

or

- ▶ Press the button in any direction during the automatic closing process.  
The closing process is stopped.

If the sliding sunroof is obstructed during closing and reopens again slightly:

Problem	Possible causes/consequences and ► Solutions
	<ul style="list-style-type: none"> <li>► Immediately after automatic reversing, pull and hold the  button down again to the point of resistance until the sliding sunroof is closed. The sliding sunroof is closed with increased force.</li> </ul> <p>If the sliding sunroof is obstructed again and reopens again slightly:</p> <ul style="list-style-type: none"> <li>► Repeat the previous step. The sliding sunroof is closed again with increased force.</li> </ul>
<p><b>Vehicles without a panoramic sliding sunroof:</b> the sliding sunroof does not operate smoothly.</p>	<ul style="list-style-type: none"> <li>► Raise the sliding sunroof fully at the rear.</li> <li>► Press the  button for another second.</li> <li>► Use automatic operation to fully raise and then close the sliding sunroof.</li> </ul>
<p><b>Vehicles with a panoramic sliding sunroof:</b> the sliding sunroof or the roller sunblind does not operate smoothly.</p>	<ul style="list-style-type: none"> <li>► Pull the  button down repeatedly to the point of resistance until the sliding sunroof is fully closed.</li> <li>► Pull the  button for another second.</li> <li>► Pull and hold the  button down until the roller sunblind is completely closed.</li> <li>► Pull the  button for another second.</li> <li>► Use automatic operation to fully open and then close the sliding sunroof.</li> </ul>



## Anti-theft protection

### Immobilizer

The immobilizer prevents your vehicle from being started without the correct key.

The immobilizer is automatically activated when the ignition is switched off and deactivated when the ignition is switched on.

When leaving the vehicle, always take the key with you and lock the vehicle. Anyone can start the engine if a valid key has been left inside the vehicle.

- i In the event that the engine cannot be started (yet the starter battery is charged), the system is not operational. Contact an authorized Mercedes-Benz Center or call 1-800-FOR-MERCEdes (in the USA) or 1-800-387-0100 (in Canada).

### ATA (anti-theft alarm system)

#### Function of the ATA system (anti-theft alarm system)

If the ATA system is armed, a visual and audible alarm is triggered in the following situations:

- A door is opened.
- The trunk lid is opened.
- The hood is opened.

The ATA system is armed automatically after approximately 10 seconds:

- After locking the vehicle with the SmartKey.
- After locking the vehicle using KEYLESS-GO.

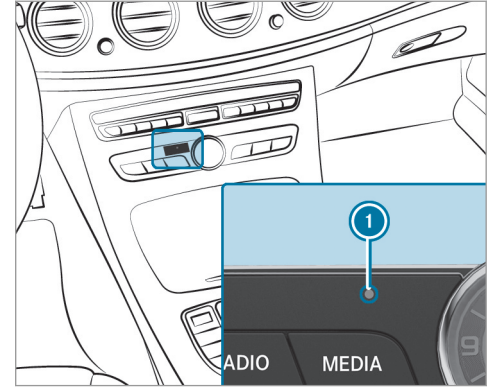

When the ATA system is armed, indicator lamp 1 flashes.

The ATA system is automatically deactivated:

- After unlocking the vehicle with the SmartKey.
- After pressing the start/stop button with the SmartKey inside the vehicle.

- After unlocking the vehicle using KEYLESS-GO.
- ① When the mbrace service (→ page 267) is active and the alarm stays on for more than 30 seconds, a message is automatically sent to the Customer Assistance Center.

#### **Deactivating the ATA (anti-theft alarm system) alarm**

▶ Press the ,  or  button on the SmartKey.

or

▶ Press the start/stop button (the SmartKey is inside the vehicle).

#### **Stopping the alarm using KEYLESS-GO**

▶ Grasp the outside door handle (with the SmartKey outside the vehicle).

### Correct driver's seat position

**⚠ WARNING** Risk of injury from adjusting the vehicle settings while the vehicle is in motion

You could lose control of the vehicle in the following situations:

- if you adjust the driver's seat, the head restraint, the steering wheel or the mirror while the vehicle is in motion
- if you fasten your seat belt while the vehicle is in motion

▶ Before starting the engine: adjust the driver's seat, the head restraint, the steering wheel or the mirror and fasten your seat belt.

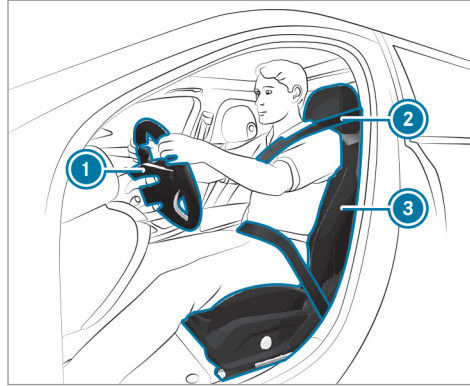

Observe the following when adjusting steering wheel ①, seat belt ② and driver's seat ③:

- you are as far away from the driver's airbag as possible
- you are sitting in a normal upright position
- your thighs are slightly supported by the seat cushion

- your legs are not entirely stretched and you can depress the pedals properly
- the back of your head is supported at eye level by the center of the head restraint
- you can hold the steering wheel with your arms slightly bent
- you can move your legs freely
- you can see all the displays in the instrument cluster clearly
- you should have a good overview of traffic conditions
- the seat belt is pulled snugly against the body and is routed across the center of your shoulder and across your hips in the pelvic area

## Seats

### Adjusting the front seat manually and electrically (without Seat Comfort Package)

**⚠ WARNING** Risk of becoming trapped if the seats are adjusted by children

Children could become trapped if they adjust the seats, particularly when unattended.

- ▶ When leaving the vehicle, always take the SmartKey with you and lock the vehicle.
- ▶ Never leave children unattended in the vehicle.

The seats can be adjusted when the ignition is switched off.

**⚠ WARNING** Risk of becoming trapped when adjusting the seats

When you adjust a seat, you or other vehicle occupants could become trapped, e.g. on the seat guide rail.

- ▶ Make sure when adjusting a seat that no one has any body parts in the sweep of the seat.

Observe the safety notes on "Airbags" and "Children in the vehicle".

**⚠ WARNING** Risk of accident due to the driver's seat not being engaged

If the driver's seat is not engaged, it could move unexpectedly while the vehicle is in motion.

This could cause you to lose control of the vehicle.

- ▶ Always make sure that the driver's seat is engaged before starting the vehicle.

**⚠ WARNING** Risk of injury from adjusting the vehicle settings while the vehicle is in motion

You could lose control of the vehicle in the following situations:

- if you adjust the driver's seat, the head restraint, the steering wheel or the mirror while the vehicle is in motion
- if you fasten your seat belt while the vehicle is in motion

- ▶ Before starting the engine: adjust the driver's seat, the head restraint, the steering wheel or the mirror and fasten your seat belt.

**⚠ WARNING** Risk of becoming trapped if the seat height is adjusted carelessly

If you adjust the seat height carelessly, you or other vehicle occupants could be trapped and thereby injured.

Children in particular could accidentally press the electrical seat adjustment buttons and become trapped.

- ▶ While moving the seats, make sure that hands or other body parts do not get under the lever assembly of the seat adjustment system.

**⚠ WARNING** Risk of injury due to head restraints which are not installed or are adjusted incorrectly

If head restraints are not installed or are adjusted incorrectly, the head restraints cannot provide protection as intended.

There is an increased risk of injury in the head and neck area, e.g. in the event of an accident or when braking.

- ▶ Always drive with the head restraints installed.
- ▶ Before driving off, make sure for every vehicle occupant that the center of the head restraint supports the back of the head at about eye level.

Do not rotate the head restraints of the front and rear seats. Otherwise, you cannot adjust the height and angle of the head restraints correctly.

Adjust the head restraint fore-and-aft position so that it is as close as possible to the back of your head.

**⚠ WARNING** Risk of injury due to an incorrect seat position

The seat belt does not offer the intended level of protection if you have not moved the seat backrest to an almost vertical position.

When braking or in the event of an accident, you could slide underneath the seat belt and sustain abdomen or neck injuries, for example. This poses an increased risk of injury or even fatal injury.

- ▶ Adjust the seat correctly before starting the journey.
- ▶ Always ensure that the seat backrest is in an almost vertical position and that the shoulder section of your seat belt is routed across the center of your shoulder.

**! NOTE** Damage to the seats when moving the seats back

The seats may be damaged by objects when moving the seats back.

- ▶ When moving the seats back, make sure that there are no objects in the footwell or under or behind the seats.

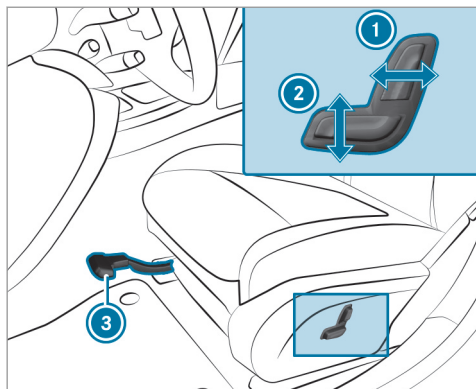

- ① Seat backrest inclination
- ② Seat height
- ③ Seat fore-and-aft position

- ▶ **To adjust the seat fore-and-aft position:** lift lever ③ and slide the seat into the desired position.
- ▶ Make sure that the seat is engaged.

### Adjusting the front seat manually and electrically (with Seat Comfort Package)

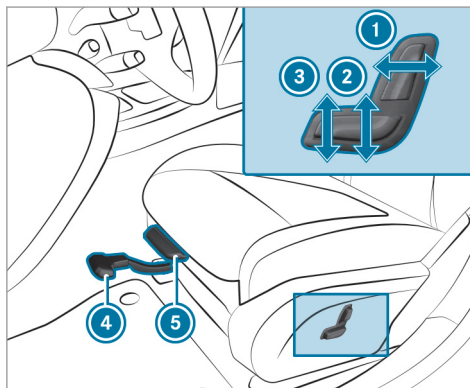

- ① Seat backrest inclination
- ② Seat height
- ③ Seat cushion inclination
- ④ Seat fore-and-aft position
- ⑤ Seat cushion length

- ▶ **To adjust the seat fore-and-aft position:** lift lever ④ and slide the seat forwards or backwards.
- ▶ Make sure that the seat is engaged.
- ▶ **To adjust the seat cushion length:** lift lever ⑤ and slide the front section of the seat cushion forwards or backwards.

### Adjusting the seats electrically

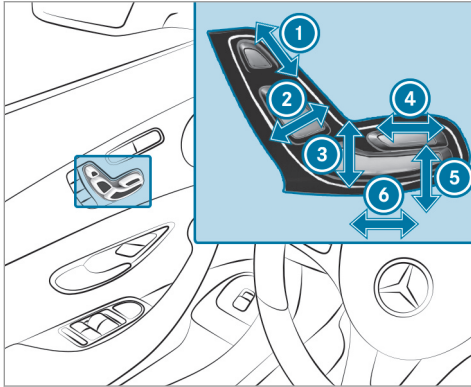

- ① Head restraint height
- ② Seat backrest inclination
- ③ Seat height
- ④ Seat cushion length
- ⑤ Seat cushion inclination
- ⑥ Seat fore-and-aft position

▶ Save the settings with the memory function (→ page 93).

### Adjusting the 4-way lumbar support

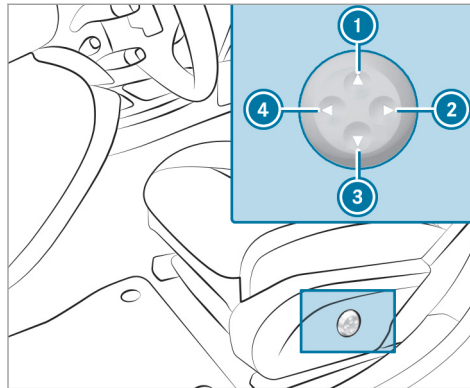

- ① To raise
- ② To soften
- ③ To lower
- ④ To harden

▶ Using buttons ① to ④, adjust the contour of the backrest individually to suit your back.

### Head restraints

#### Adjusting the front seat head restraints manually

**⚠ WARNING** Risk of injury from adjusting the vehicle settings while the vehicle is in motion

You could lose control of the vehicle in the following situations:

- if you adjust the driver's seat, the head restraint, the steering wheel or the mirror while the vehicle is in motion
- if you fasten your seat belt while the vehicle is in motion

▶ Before starting the engine: adjust the driver's seat, the head restraint, the steering wheel or the mirror and fasten your seat belt.

**⚠ WARNING** Risk of injury due to head restraints which are not installed or are adjusted incorrectly

If head restraints are not installed or are adjusted incorrectly, the head restraints cannot provide protection as intended.

There is an increased risk of injury in the head and neck area, e.g. in the event of an accident or when braking.

- ▶ Always drive with the head restraints installed.
- ▶ Before driving off, make sure for every vehicle occupant that the center of the head restraint supports the back of the head at about eye level.

Do not interchange the head restraints of the front and rear seats. Otherwise, you cannot adjust the height and angle of the head restraints correctly.

Adjust the head restraint fore-and-aft position so that it is as close as possible to the back of your head.

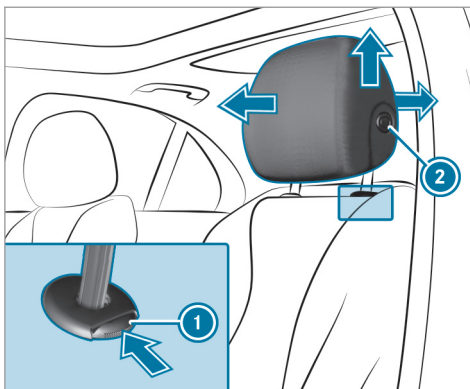

▶ **To raise:** pull the head restraint up.

▶ **To lower:** press release knob ① in the direction of the arrow and push the head restraint down.

**Adjusting the gap between the head restraint and the back of your head:**

▶ **To move forwards:** pull the head restraint forwards.

▶ **To move backwards:** press release knob ② and push the head restraint backwards.

**Adjusting the front seat luxury head restraints**

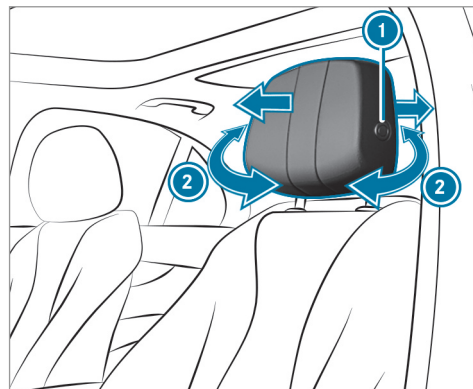

▶ **To adjust the side bolsters of the head restraint:** pull or push right or left-hand side bolster ②.



### Adjusting the gap between the head restraint and the back of your head:

- ▶ **To move forwards:** pull the head restraint forwards.
- ▶ **To move backwards:** press release knob ❶ and push the head restraint backwards.

### Adjusting the rear seat head restraints

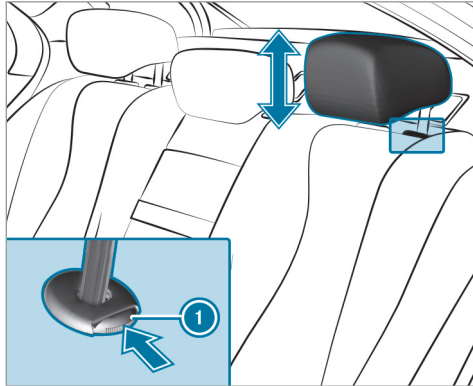

- ▶ **To raise:** pull the head restraint up.
- ▶ **To lower:** press release knob ❶ in the direction of the arrow and push the head restraint down.

The head restraints can only be removed on vehicles with folding rear seat backrests.

- ▶ Release the rear seat backrest and fold it slightly forwards.
- ▶ **To remove:** pull the head restraint up to the stop.
- ▶ Push release knob ❶ in the direction of the arrow and pull out the head restraint.
- ▶ **To install:** insert the head restraint so that the notches on the bar are on the left when viewed in the direction of travel.
- ▶ Push the head restraint down until it engages.
- ▶ Fold the rear seat backrest back until it engages.

### Configuring the seat adjustment

Multimedia system:

↳ Vehicle ▶ Seats

- ▶ Select [Driver's Seat](#) or [Front Passenger](#).

### Adjusting the backrest side bolsters

- ▶ Select [Side Bolsters](#).
- ▶ Select the setting.

### Adjusting the seat contour in the lumbar region of the seat backrest

- ▶ Select [Lumbar](#).
- ▶ Adjust the air cushion.
- ▶ Save the settings with the memory function (→ page 93).

### Adjusting the dynamic multicontour seat

Multimedia system:

↳ Vehicle ▶ Seats

The dynamic lateral cornering support can be adjusted using this function.

- ▶ Select [Driver's Seat](#) or [Front Passenger](#).

▶ Select **Dynamic Seat**.

▶ **Select setting:** **Off**, **Level 1** or **Level 2**.

▶ Save the settings using the memory function  
(→ page 93).

### Overview of massage and workout programs

The following massage programs can be selected:

Massage program for the front seats	Function
Hot Relaxing Massage for back	Relaxing massage program starting in the pelvic area. Warm pressure points can be felt, full back massage, stretching the pelvic area. Ending with gentle stroking motions.
Hot Relaxing Massage for shoulders	Relaxing massage program starting in the shoulder area. Warm pressure points can be felt, full twin-wave back massage, stretching the shoulder area. Ending with gentle stroking motions.
Activating Massage	Activating back massage with increasing twin-waves and then soothing movements.
Classic Massage	Massage with increasing twin-waves and soothing movements.
Wave Massage	Relaxing and activating massage program, starting on your back and continuing in the cushion. Subsequent stroking motions across the entire spinal column.
Mobilizing Massage	Mobilization of the spinal column and upper body using pressure points in the lumbar and back. You can increase the mobilization effect by relaxing into the pressure points. This process helps to improve your posture.

**Active Workout programs**

The Active Workout programs require your active cooperation and are a convenient way of exercis-

ing your abdomen and back muscles during a traffic jam, for example, by tensing and releasing the specific muscle groups. Tensing and releas-

ing also helps to improve blood flow in your muscles. Press against a pressure point as soon as you feel it.

The following Active Workout programs can be selected:

Workout program	Function
Active Workout backrest	To stimulate the muscles in your abdomen and back: press against the pressure points in the backrest. Keep the pressure under your feet even. Continue to breathe normally; do not hold your breath. When the pressure in the seat backrest stops, stop pressing against it and relax briefly.
Active Workout cushion	To stimulate the muscles in your lower back: press against the pressure points in the seat cushion. Keep the pressure under your feet even. Continue to breathe normally; do not hold your breath. When the pressure in the seat cushion stops, stop pressing against it and relax briefly.

### Selecting the massage program for the front seats

Multimedia system:

↪ Vehicle ▶ Seats

- ▶ Select **Driver's Seat** or **Front Passenger**.
- ▶ Select **Massage**.

- ▶ Select a massage program. The massage program runs for approximately 9 to 15 minutes, depending on the setting.
- ▶ To set the massage intensity: switch **High Intensity** on  or off .

### Resetting seat and massage settings

Multimedia system:

↪ Vehicle ▶ Seats ▶ Reset

- ▶ Select **Yes** or **No**.

Depending on whether the settings for the driver or front passenger seat are selected, only the selected seat can be reset.

### Switching the seat heating on/off

**⚠ WARNING** Risk of burns due to repeatedly switching on the seat heater

Repeatedly switching on the seat heater can cause the seat cushion and seat backrest padding to become very hot.

The health of persons with limited temperature sensitivity or a limited ability to react to excessively high temperatures may be affected or they may even suffer burn-like injuries.

- ▶ Do not repeatedly switch on the seat heater.

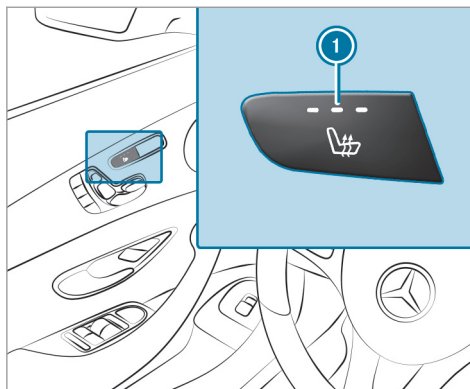

- ▶ **To switch on/increase the level:** press button ① repeatedly until the desired heating level is set. Depending on the heating level, up to three indicator lamps light up.
- ▶ **To switch off/reduce the level:** press button ① repeatedly until all the indicator lamps go out.

- ① The seat heater automatically switches down from the three heating levels after certain periods of time: 8, 10 and 20 minutes until the seat heater is switched off.

### Switching the seat ventilation on/off

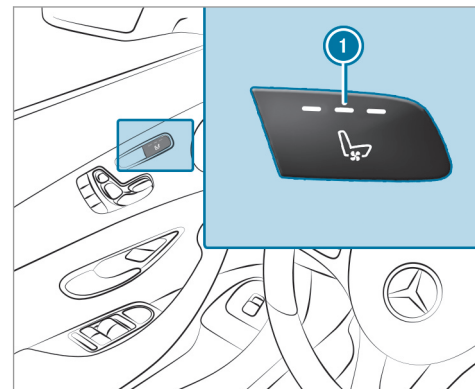

- ▶ **To switch on/increase the level:** press button ❶ repeatedly until the desired ventilation level is set. Depending on the ventilation level, up to three indicator lamps light up.
- ▶ **To switch off/reduce the level:** press button ❶ repeatedly until all the indicator lamps go out.

## Steering wheel

### Adjusting the steering wheel manually

**⚠ WARNING** Risk of injury from adjusting the vehicle settings while the vehicle is in motion

You could lose control of the vehicle in the following situations:

- if you adjust the driver's seat, the head restraint, the steering wheel or the mirror while the vehicle is in motion
- if you fasten your seat belt while the vehicle is in motion

- ▶ Before starting the engine: adjust the driver's seat, the head restraint, the steering wheel or the mirror and fasten your seat belt.

**⚠ WARNING** Risk of entrapment for children when adjusting the steering wheel

Children could injure themselves if they adjust the steering wheel.

- ▶ Never leave children unattended in the vehicle.
- ▶ When leaving the vehicle, always take the key with you and lock the vehicle.

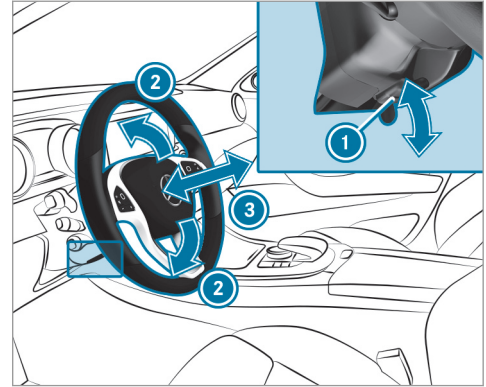

- ▶ To unlock the steering column: push release lever ❶ down completely.
- ▶ Adjust height ❷ and distance to steering wheel ❸.
- ▶ To lock the steering column: push release lever ❶ up as far as it will go.
- ▶ Check and make sure that the steering column is locked by moving the steering wheel.

### Adjusting the steering wheel electrically

The steering wheel can be adjusted when the ignition is switched off.

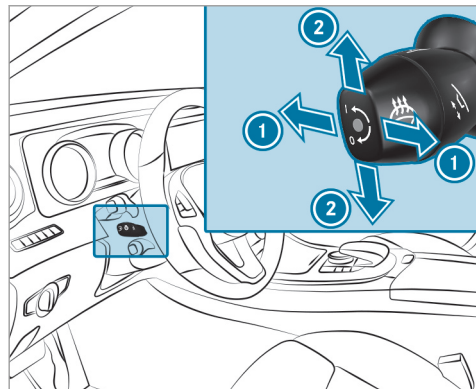

- ① Adjusts the distance to the steering wheel
- ② Adjusts the height
- ▶ Save the settings with the memory function (→ page 93).

### Switching the steering wheel heater on/off

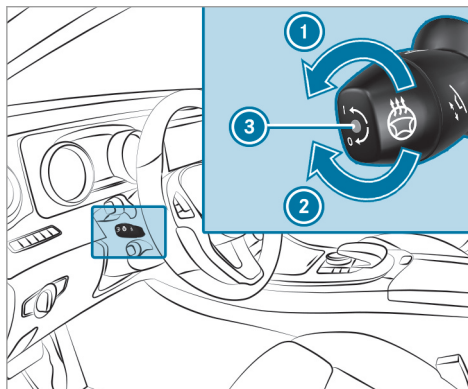

- ① To switch on
- ② To switch off
- ③ Indicator lamp

### Easy entry and exit feature

#### How the easy entry and exit feature operates

**⚠ WARNING** Risk of accident when driving off while adjusting the easy exit feature

- If you drive off while the easy entry and exit feature is making adjustments, you could lose control of the vehicle.

▶ Always wait until the adjustment process is complete before driving off.

**⚠ WARNING** Risk of entrapment when adjusting the easy entry and exit feature

- When the easy entry and exit feature adjusts the steering wheel, you and other vehicle occupants – particularly children – could become trapped.

▶ - While the easy entry and exit feature is making adjustments, make sure that no one has any body parts in the sweep of the steering wheel.

- ▶ Move the adjustment lever of the steering wheel if there is a risk of becoming trapped by the steering wheel. The adjustment process is stopped.
- ▶ Never leave children unattended in the vehicle.
- ▶ When leaving the vehicle, always take the key with you and lock the vehicle.

The easy entry and exit feature makes getting in and out of your vehicle easier.

If the easy entry and exit feature is active, the steering wheel will move upwards in the following situations:

- you switch the ignition off
- you open the driver's door when the ignition is switched on

The steering wheel moves back to the last drive position in the following cases:

- you switch the ignition on when the driver's door is closed
- you close the driver's door when the ignition is switched on

The last drive position of the steering wheel is stored:

- when you switch off the ignition
- using the last setting stored using the memory function

If you press one of the memory function position buttons, the adjustment process is stopped.

The crash-responsive exit aid only functions when the easy entry and exit feature is active.

#### Setting the easy entry and exit feature

Multimedia system:

→ Vehicle ▶▶  Vehicle Settings ▶▶ Easy Entry/Exit

- ▶ Activate  or deactivate  the function.

#### Using the memory function

**⚠ WARNING** Risk of an accident if memory function is used while driving

If you use the memory function on the driver's side while driving, you could lose control

of the vehicle as a result of the adjustments being made.

- ▶ Only use the memory function on the driver's side when the vehicle is stationary.

**⚠ WARNING** Risk of entrapment when setting the seat with the memory function

When the memory function adjusts the seat or steering wheel, you and other vehicle occupants – particularly children – could become trapped.

- ▶ During the setting procedure of the memory function, ensure that no body parts are in the sweep of the seat or the steering wheel.
- ▶ If somebody becomes trapped, immediately release the memory function position button. The adjustment process is stopped.

**⚠ WARNING** Risk of entrapment if the memory function is activated by children

Children could become trapped if they activate the memory function, particularly when unattended.

- ▶ Never leave children unattended in the vehicle.
- ▶ When leaving the vehicle, always take the SmartKey with you and lock the vehicle. This also applies to mobile phones if the "Digital Car Key in the smartphone" function is activated via the Mercedes connect me web app.

The memory function can be used when the ignition is switched off.

Driver-seat comfort positions for up to three people can be stored and called up using the memory function.

The following systems can be set using the memory function:

- Seat, backrest and head restraint
- Steering wheel

- Outside mirrors
- Head-up display

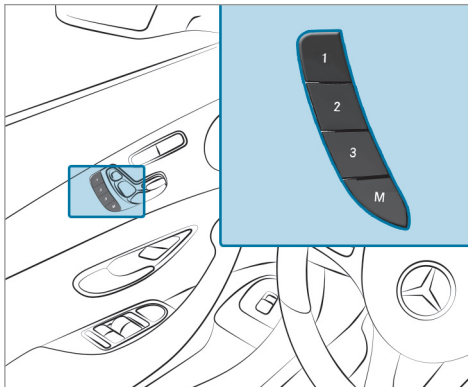

- ▶ **To save:** set the seat, the steering wheel, the Head-up Display and the outside mirror to the desired position.

- ▶ Press the memory button M together with one of the storage position buttons 1, 2 or 3. An acknowledgement tone sounds. The settings are stored.
- ▶ **To call up:** press and hold button 1, 2 or 3 until all the driver-seat comfort systems are in the stored position.

### Stowage areas

#### Notes on loading the vehicle

**⚠ WARNING** Risk of exhaust gas poisoning

Combustion engines emit poisonous exhaust gases such as carbon monoxide. Exhaust gases can enter the vehicle interior if the trunk lid is open when the engine is running, especially if the vehicle is in motion.

- ▶ Always switch off the engine before opening the trunk lid.
- ▶ Never drive with the trunk lid open.



**⚠ WARNING** Risk of injury from unsecured items in the vehicle

If objects are not secured or not secured sufficiently, they could slip, tip over or be thrown around; this could result in vehicle occupants being hit.

This also applies to:

- Luggage or loads
- Seats that have been removed and are transported in the vehicle as an exception.

There is a risk of injury, particularly in the event of sudden braking or a sudden change in direction.

- ▶ Always stow objects in such a way that they cannot be thrown around.
- ▶ Before the journey, secure objects, luggage or loads against slipping or tipping over.
- ▶ If a seat has been removed, preferably stow the seat outside of the vehicle.

**⚠ WARNING** Risk of injury from incorrectly stowed objects

If objects in the vehicle interior are stowed incorrectly, they can slide or be thrown around and hit vehicle occupants. In addition, cup holders, open stowage spaces and mobile phone brackets cannot always retain all objects they contain.

There is a risk of injury, particularly in the event of sudden braking or a sudden change in direction.

- ▶ Always stow objects so that they cannot be thrown around in such situations.
- ▶ Always make sure that objects do not protrude from stowage spaces, luggage nets or stowage nets.
- ▶ Close the lockable stowage spaces before starting a journey.
- ▶ Always stow and secure heavy, hard, pointed, sharp-edged, fragile or bulky objects in the trunk.

**⚠ WARNING** Risk of burns from tailpipes and tailpipe trim

The tailpipe and tailpipe trim can become very hot. If you come into contact with these parts of the vehicle, you could burn yourself.

- ▶ Always be particularly careful around the tailpipe and the tailpipe trim.
- ▶ Allow the vehicle parts to cool down before you touch them.

The handling characteristics of your vehicle are dependent on the distribution of the load within the vehicle. You should bear the following in mind when loading the vehicle:

- Never exceed the maximum permissible gross mass or the permissible axle loads for the vehicle (including occupants). The values are specified on the vehicle identification plate on the vehicle's B-pillar.
- The load must not protrude above the upper edge of the seat backrests.
- Always place the load behind unoccupied seats if possible.

- Secure the load using the tie-down eyes and distribute the load evenly.

### Interior stowage compartments

#### Overview of the front stowage compartments

Observe the notes on loading the vehicle (→ page 94).

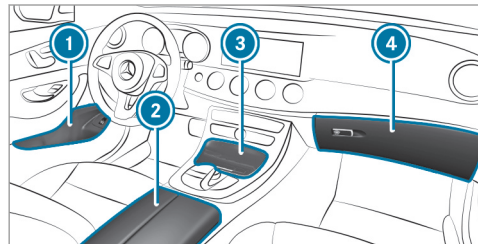

- ① Stowage compartment in the doors
- ② Stowage/telephone compartment in the armrest with multimedia connections and stowage compartment, e.g. for an MP3 player

- ③ Stowage compartment in the front center console with a USB port (depending on the vehicle's equipment)

- ④ Glove box

#### Locking/unlocking the glove box

Observe the notes on loading the vehicle (→ page 94).

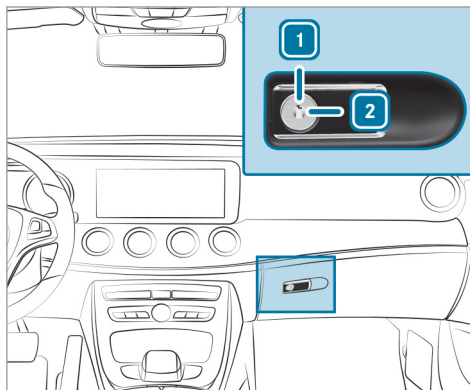

- ▶ Turn the emergency key a quarter turn clockwise **2** (to lock) or counter-clockwise **1** (to unlock).

#### Opening the eyeglasses box

Observe the notes on loading the vehicle (→ page 94).

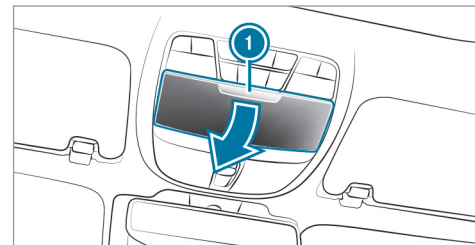

- ▶ **To open:** press button **1**.

#### Opening the stowage compartment in the rear armrest

Observe the notes on loading the vehicle (→ page 94).

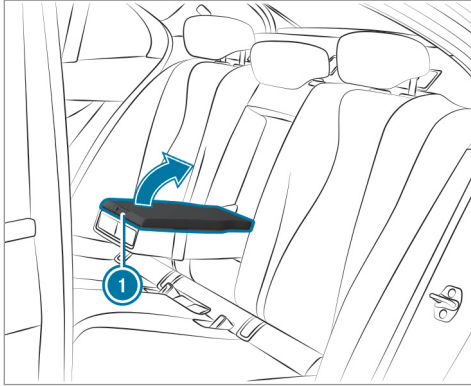

- ▶ **To open:** press release catch ① and swing the cover of the armrest upwards.

### Through-loading feature in the rear bench seat

#### Folding the rear seat backrests forward

**⚠ WARNING** Risk of injury if the rear bench seat/rear seat and seat backrest are not engaged

If the rear bench seat/rear seat and seat backrest are not engaged they could fold forwards, e.g. when braking suddenly or in the event of an accident.

- If this is the case, the vehicle occupant would be forced into the seat belt by the rear bench seat/rear seat or by the seat backrest. The seat belt cannot protect as intended and could result in additional injury.
- Objects or loads in the trunk cannot be restrained by the seat backrest.
- ▶ Make sure that the seat backrest and the rear bench seat/rear seat are engaged before every trip.

If the seat backrest is not engaged and locked, this will be shown in the multifunction display in the instrument cluster.

The center and outer seat backrests can be folded forwards separately.

- ▶ Fully insert the rear seat backrest head restraints.

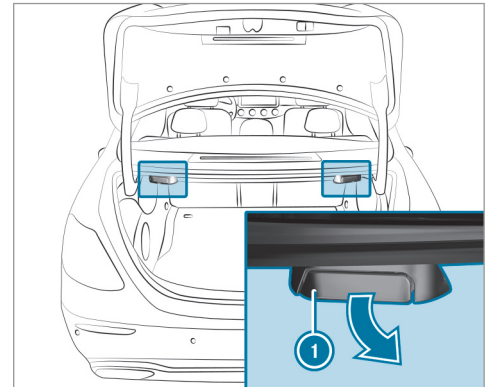

- ▶ **Left and right seat backrest:** pull release lever ❶.

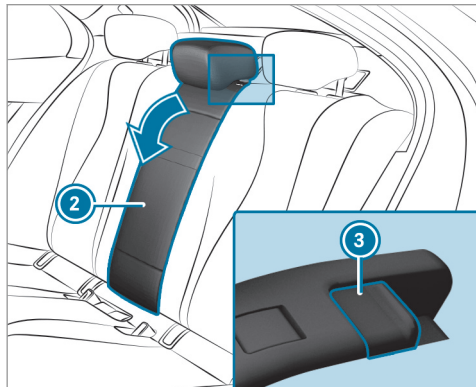

- ▶ **Center seat backrest:** pull release ❸ of seat backrest ❷ forwards.
- ▶ Fold the corresponding seat backrest forwards.

### Folding the rear seat backrest back

**!** **NOTE** Damage to the seat belt

The seat belt could become trapped and thus damaged when folding back the seat backrest.

- ▶ Make sure that the seat belt is not trapped when folding back the seat backrest.

If the seat backrest is not engaged and locked, this will be shown in the multifunction display in the instrument cluster.

- ▶ Move the driver's or front passenger seat forwards, if necessary.

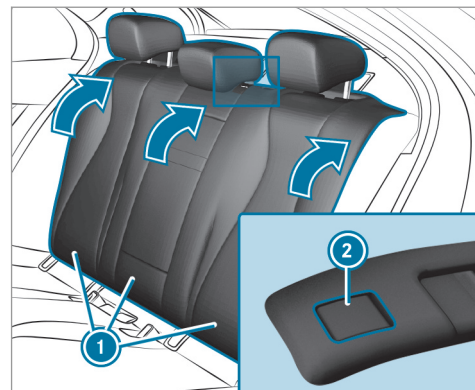

- ▶ Fold corresponding seat backrest ❶ back until it engages.

**Left and right seat backrests:** if the seat backrest is not correctly locked, this will be shown in the multifunction display in the instrument cluster.

**Center seat backrest:** if the seat backrest is not correctly locked, red lock verification indicator ❷ will be visible.

**Locking the center rear seat backrest**

Lock the center seat backrest if you want to secure the cargo compartment against unauthorized access. It can then only be folded forwards together with the left seat backrest.

Both seat backrests must be engaged and joined together.

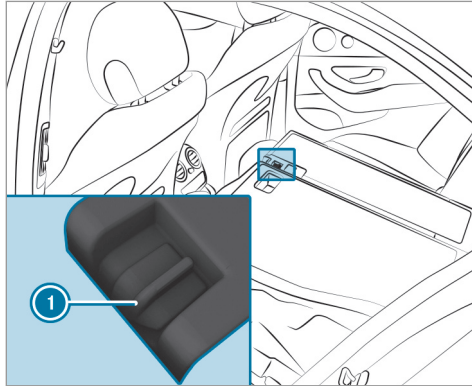

- ▶ Fold the center and left seat backrest forwards.
- ▶ **To lock:** slide catch ① upwards. The release mechanism of the center seat backrest is locked.
- ▶ **To unlock:** slide catch ① downwards.

**Overview of the tie-down eyes**

Observe the notes on loading the vehicle (→ page 94).

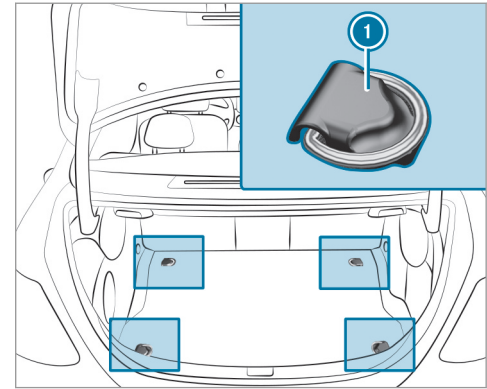

- ① Tie-down eyes (vehicles with through-loading feature in the rear bench seat)

## EASY-PACK trunk box

### Adjusting the height of the EASY-PACK trunk box to any position

**⚠ WARNING** Risk of becoming trapped and injured when moving the floor up

When the floor moves up, your hands may become trapped on the frame of the EASY-PACK trunk box and objects may be thrown up.

- ▶ When the floor moves up, make sure that your hands are not within the sweep of the floor.
- ▶ If someone becomes trapped, carefully push the center of the floor downward.
- ▶ Remove all objects from the floor before moving it up.

**⚠ WARNING** Risk of becoming trapped when pressing the EASY-PACK trunk box in

When the EASY-PACK trunk box is pressed into the retracted position, your hands may become trapped. Children, in particular, may injure themselves when doing so.

- ▶ When pressing the EASY-PACK trunk box in, make sure that your hands are not within the sweep of the EASY-PACK trunk box.
- ▶ When leaving the vehicle, always take the SmartKey with you and lock the vehicle.
- ▶ Never leave children unattended in the vehicle.

**! NOTE** Damage to the extended EASY-PACK trunk box

The EASY-PACK trunk box may be damaged when the EASY-PACK trunk box is extended.

- ▶ Do not place any objects on or press down on the EASY-PACK trunk box frame.
- ▶ Do not close the trunk lid when the EASY-PACK trunk box is extended.

**! NOTE** Damage to the EASY-PACK trunk box caused by objects which are sharp-edged, pointed, fragile, rounded or heavy and objects that roll

Objects which are sharp-edged, pointed, fragile, rounded or heavy and objects that roll can damage the EASY-PACK trunk box and be thrown out.

- ▶ Do not transport objects which are sharp-edged, pointed, rounded or fragile and objects that roll in the EASY-PACK trunk box.
- ▶ Always stow and secure such objects outside of the box in the trunk.
- ▶ Always observe the maximum permitted load of the EASY-PACK trunk box.

- ▶ Do not use the EASY-PACK trunk box when the rear seats are folded forwards.

The maximum permitted load of the EASY-PACK trunk box is 22 lbs (10 kg). To prevent the box from being overloaded, the box floor lowers onto the trunk floor when the load reaches approximately 11 lbs (5 kg).

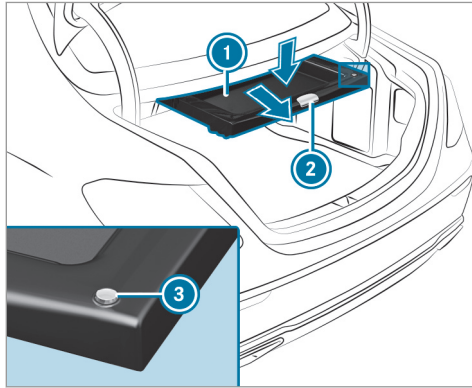

- ▶ Pull the box out using handle ②.
  - ▶ **To increase the load capacity:** press the center of floor ① downwards to the desired position and box size.
  - ▶ **To reduce the load capacity:** press button ③.
  - ▶ **To stow:** press the box in completely using handle ②, until it locks in place.
- ⓘ Observe the notes on cleaning the EASY-PACK trunk box (→ page 311).

### Installing/removing the EASY-PACK trunk box

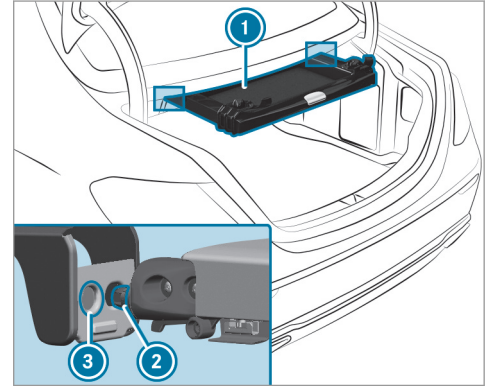

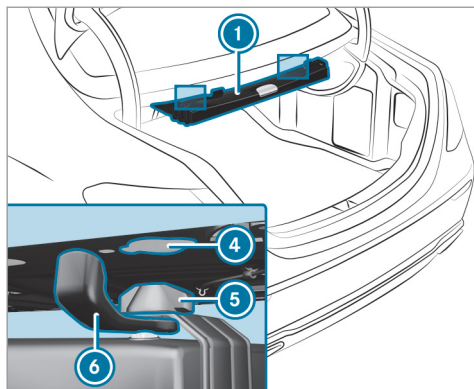

- ▶ **To install:** open rotating catch ⑥ and turn it outwards.
- ▶ Insert brackets ② of box ① into outer holes ③.
- ▶ Raise box ① and press hooks ⑤ into rear shelf ④.
- ▶ Turn rotating catch ⑥ inwards to the stop.

- ▶ **To remove:** turn left-hand rotating catch ⑥ clockwise and right-hand rotating catch ⑥ counter-clockwise by 90°.
- ▶ Lower box ① and pull it out of anchorages ④, then pull box ① backwards and out of holes ③.

### Opening the stowage space under the trunk floor

**!** **NOTE** Damage to the handle in the trunk floor

If the handle in the trunk is left protruding, the handle may be damaged.

- ▶ Unhinge the handle before you close the trunk lid and clip it in place.

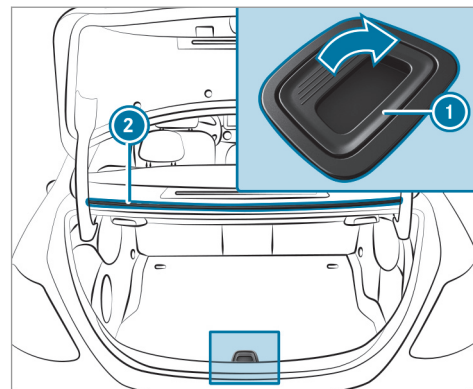

- ▶ Pull handle ① up and hook it into rain trough ②.



## Attaching the roof rack

**⚠ WARNING** Risk of injury by exceeding the maximum roof load

When you load the roof, the vehicle center of gravity rises and the driving characteristics change.

If you exceed the maximum roof load, the driving characteristics, as well as the steering and braking, will be greatly impaired.

- ▶ Never exceed the maximum roof load and adjust your driving style.

You will find information on the maximum roof load in the "Technical data" section.

### Requirements

- Only use roof racks tested and approved by Mercedes-Benz.
- Make sure that you can raise the sliding sunroof fully and open the trunk lid fully with the roof rack is installed.
- The panoramic sliding sunroof cannot be opened if the roof rack is installed. The pan-

oramic sliding sunroof closes again automatically when it encounters resistance.

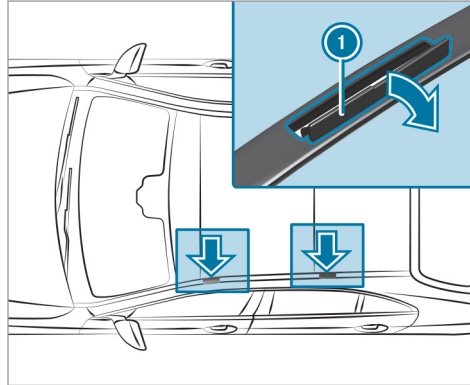

**!** **NOTE** Damage to the covers

The covers may be damaged and scratched when being opened.

- ▶ Do not use metallic or hard objects.

- ▶ Fold covers ① carefully upwards in the direction of the arrow.
- ▶ Only secure the roof rack to the anchorage points under covers ①.
- ▶ Always comply with the roof rack manufacturer's installation instructions.
- ▶ Secure the load on the roof rack.

## Cup holder

### Installing or removing the cup holder in the center console

**⚠ WARNING** - Risk of accident or injury when using the cup holder while the vehicle is moving

The cup holder cannot secure containers while the vehicle is moving.

If you use a cup holder while the vehicle is moving, the container may be flung around and liquids may be spilled. The vehicle occupants may come into contact with the liquid and if it is hot, they could be scalded. You

could be distracted from traffic conditions and you may lose control of the vehicle.

- ▶ Only use the cup holder when the vehicle is stationary.
- ▶ Only use the cup holder for containers of the right size.
- ▶ Close the container, particularly if the liquid is hot.

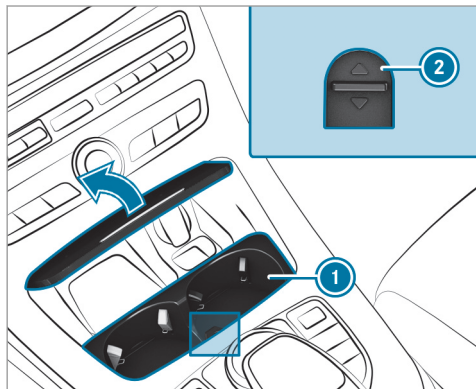

- ▶ **To remove:** slide catch ② forwards and pull out cup holder ①.
  - ▶ **To install:** insert cup holder ① and slide back catch ②.
- ⓘ The rubber mat of the cup holder can be removed for cleaning, e.g. using clean, lukewarm water.

#### Opening the cup holder in the rear armrest

**!** NOTE Damage to the cup holder

When the rear armrest is folded back the cup holder could become damaged.

- ▶ Only fold the rear armrest back when the cup holder is closed.

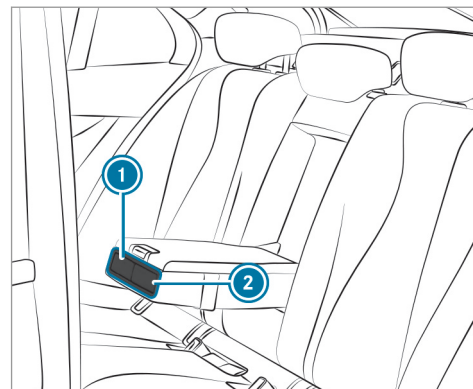

- ▶ **To open:** press on cup holder ① or ②.
- ▶ **To fold in or out:** place or remove a container from cup holder ① or ②.

## Ashtray and cigarette lighter

### Using the ashtray in the front center console

**!** **NOTE** Damage to the stowage compartment under the ashtray

The stowage compartment under the ashtray is not heat resistant and could be damaged if you rest a lit cigarette on it.

▶ Make sure that the ashtray is fully engaged.

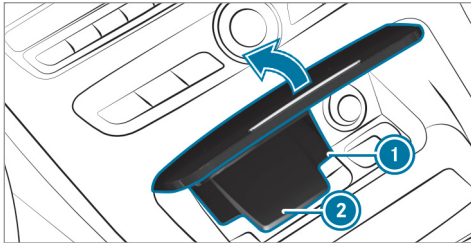

▶ **To open:** push the cover of the ashtray upwards on its right **2** or left side.

- ▶ **To remove the insert:** press insert **1** upwards slightly and pull it out upwards.
- ▶ **To install the insert:** press insert **1** into the holder until the insert engages.

### Using the rear passenger compartment ashtray

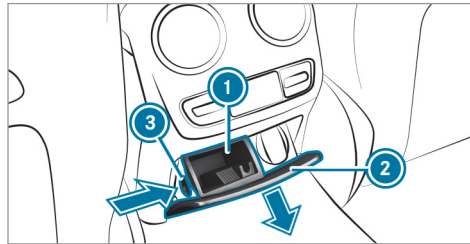

- ▶ **To open:** pull cover **2** out by its top handle edge.
- ▶ **To remove the insert:** push ribbing **3** from the left side and pull insert **1** upwards and out.

- ▶ **To install the insert:** install insert **1** from above and press down into the holder until it engages.

### Using the cigarette lighter

**!** **WARNING** - Risk of fire and injury from hot cigarette lighter

You can burn yourself if you touch the hot heating element or the socket of the cigarette lighter.

In addition, flammable materials may ignite if:

- you drop the hot cigarette lighter
- a child holds the hot cigarette lighter to objects, for example

- ▶ Always hold the cigarette lighter by the knob.
- ▶ Always make sure that the cigarette lighter is out of reach of children.
- ▶ Never leave children unattended in the vehicle.

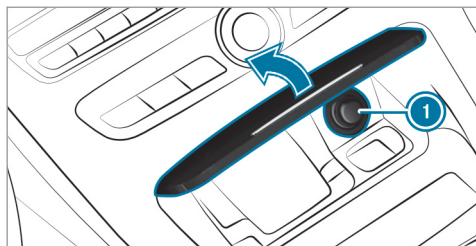

- ▶ Press in cigarette lighter ①. The cigarette lighter will pop out automatically when the heating element is red-hot.

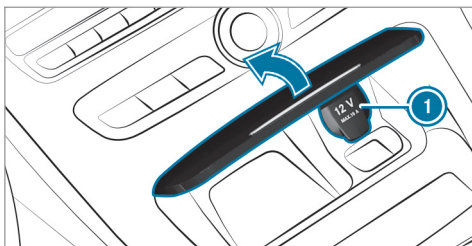

- ▶ Lift out cover ① of the socket and insert the plug of the device.

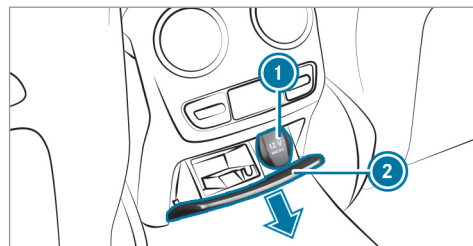

- ▶ Briefly press the trim of cover ②.
- ▶ Lift out cover ① of the socket and insert the plug of the device.

## Sockets

### Using the 12 V socket in the front center console

#### Requirements:

- Only connect devices up to a maximum of 180 Watt (15 A)
- If you have connected a device to the 12 V socket, leave the cover of the stowage compartment open

### Using the 12 V socket in the rear passenger compartment

#### Requirement

Only connect devices up to a maximum of 180 watt (15 A)

### Using the 115 V socket in the rear passenger compartment

**⚠ DANGER** Risk of fatal injury due to damaged connecting cables or sockets

If a suitable device is connected, the 115 V socket will be carrying a high voltage. If the connecting cable or the 115 V socket is pulled out of the trim or is damaged or wet, you could receive an electric shock.

- ▶ Only use dry and damage-free connecting cables.
- ▶ When the ignition is switched off, ensure that the 115 V socket is dry.
- ▶ If the 115 V socket is damaged or gets pulled out of the paneling, immediately have the socket checked or replaced at a qualified specialized workshop.
- ▶ Never plug the connecting cable into a 115 V socket that is damaged or has been pulled out of the trim.

**⚠ DANGER** Risk of fatal injury due to incorrect handling of the socket

You could receive an electric shock:

- if you reach into the socket.
  - if you insert unsuitable devices or objects into the socket.
- ▶ Only connect suitable devices to the socket.

### Requirements

- Only connect devices with a suitable plug which conforms to the standards specific to the country you are in.
- Only connect devices up to a maximum of 150 watts.
- Do not use multiple socket outlets.

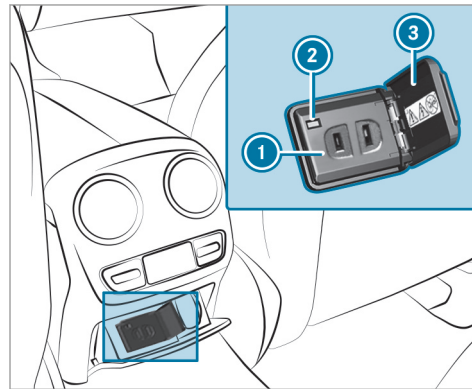

- ▶ Open flap ③.

- ▶ Insert the plug of the device into 115 V socket ①.  
When the on-board electrical system voltage is sufficient, indicator lamp ② lights up.

### Using the 12 V socket in the trunk

#### Prerequisite

Only connect devices up to a maximum of 180 Watt (15 A)

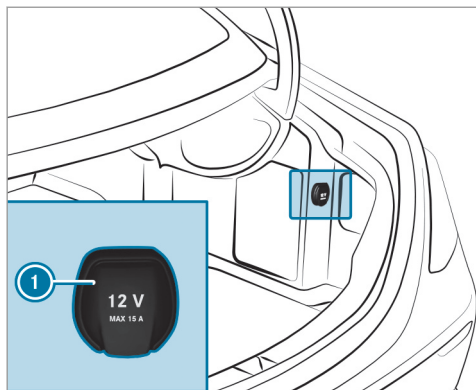

- ▶ Lift up cover ① of the socket and insert the plug of the device.

### Wireless charging of the mobile phone and connection with the exterior antenna

**⚠ WARNING** Risk of injury due to objects being stowed incorrectly

If objects in the vehicle interior are stowed incorrectly, they can slide or be thrown around and hit vehicle occupants. In addition, cup holders, open stowage spaces and mobile phone receptacles cannot always retain all objects they contain.

There is a risk of injury, particularly in the event of sudden braking or a sudden change in direction.

- ▶ Always stow objects so that they cannot be thrown around in such situations.
- ▶ Always make sure that objects do not protrude from stowage spaces, luggage nets or stowage nets.
- ▶ Close the lockable stowage spaces before starting a journey.

- ▶ Always stow and secure heavy, hard, pointed, sharp-edged, fragile or bulky objects in the trunk/load compartment.

Observe the notes on loading the vehicle.

**⚠ WARNING** Risk of fire from placing objects in the mobile phone stowage compartment

If you place objects in the mobile phone stowage compartment, they may heat up excessively and even catch fire.

- ▶ Do not place additional objects, especially those made of metal, in the mobile phone stowage compartment.

**! NOTE** Damage to objects caused by placing them in the mobile phone stowage compartment

If you place objects in the stowage compartment, these may be damaged by electromagnetic fields.

- ▶ Do not place credit cards, storage media or other objects sensitive to electromagnetic fields in the mobile phone stowage compartment.
- ▶ Do not spill liquids into the mobile phone stowage compartment.

#### Requirements:

- Your mobile phone must be suitable for wireless charging (Qi-compatible mobile phone). You can find a list of Qi-compatible mobile phones online at:  
<http://www.mercedes-benz.com/connect>
  - Depending on the vehicle equipment, the mobile phone is connected to the vehicle's exterior antenna via the charging module.
  - The charging function and wireless connection of the mobile phone to the vehicle's exterior antenna are only available if the ignition is switched on.
  - To ensure more efficient charging and connection with the exterior antenna, remove the protective cover from the mobile phone.
- Small mobile phones may not be able to be charged in every position of the stowage compartment.
  - Large mobile phones which do not fit into the stowage compartment may not be able to be charged or connected with the exterior antenna.

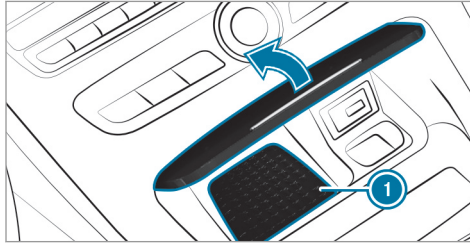

- ▶ Place the mobile phone as close to the center of mat ① as possible with the display facing upwards. The mobile phone is charged automatically, as is apparent from the way in which the mobile phone reacts and from the charging symbol in the multimedia system display.

Malfunctions during the charging process are shown in the multimedia system display.

- ① The mobile phone may heat up during the charging process, especially if data services are being used at the same time. For this reason, it is possible to cool the mobile phone depending on the operating status of the air conditioning system. Cooling output depends on the position of the controller for the glove box cooling system (cooling output is higher when the controller is closed).
- ① To clean, mat ① can be removed. If possible, use the mat when charging.

#### Installing/removing floor mats

**▲ WARNING** Risk of accident due to objects in the driver's footwell

Objects in the driver's footwell may impede pedal travel or block a depressed pedal. This jeopardizes the operating and road safety of the vehicle.

## 110 Seats and stowing

- ▶ Stow all objects in the vehicle securely so that they cannot get into the driver's footwell.
- ▶ Always install the floor mats securely and as prescribed in order to ensure that there is always sufficient room for the pedals.
- ▶ Do not use loose floor mats and do not place floor mats on top of one another.

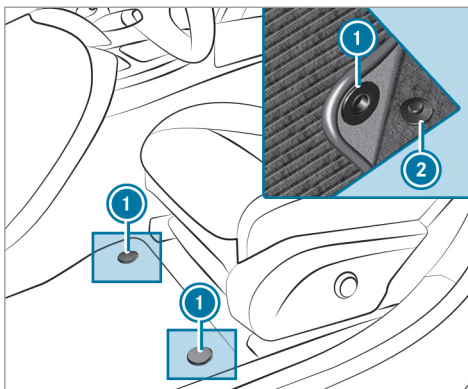

- ▶ **To install:** press studs ① onto holders ②.
- ▶ **To remove:** pull the floor mat off the holders ②.



## Exterior lighting

### Lighting systems and your responsibility

The various lighting systems of the vehicle are only aids. The driver of the vehicle is responsible for correct vehicle illumination in accordance with the prevailing light and visibility conditions, legal requirements and traffic situation.

## Light switch

### Operating the light switch

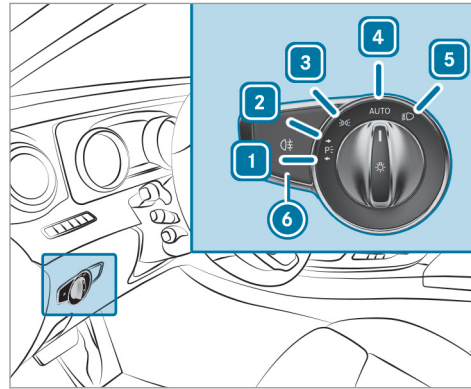

- ▶ 1 Left-hand standing lights
- ▶ 2 Right-hand standing lights
- ▶ 3 Parking lights and license plate lighting

- ▶ 4 **AUTO** Automatic driving lights (preferred light switch position)
- ▶ 5 Low beam/high beam
- ▶ 6 Activates/deactivates the rear fog light

When low beam is activated, the indicator lamp for the parking lights is deactivated and replaced by the low beam indicator lamp.

Always park your vehicle safely and in a well-lit area, in accordance with the relevant legal stipulations.

**!** **NOTE** Battery discharging by operating the standing lights

Operating the standing lights over a period of hours puts a strain on the battery.

- ▶ Where possible, switch on the right or left parking light.

In the case of severe battery discharging, the parking lights or standing lights are automatically switched off to facilitate a future engine start.

The exterior lighting (except parking lights and standing lights) switches off automatically when the driver's door is opened.

### Automatic headlamp mode

The parking lights, low beam and daytime running lamps are switched on or off automatically depending on the ignition status, whether the engine is running and on the ambient light.

**⚠ WARNING** Risk of accident when the low beam is switched off in poor visibility

When the light switch is set to **AUTO**, the low beam may not be switched on automatically if there is fog, snow or other causes of poor visibility such as spray.

▶ In such cases, turn the light switch to .

The automatic driving lights are only an aid. You are responsible for vehicle lighting.

### Activating/deactivating the rear fog light

#### Requirement

The light switch is in the  or **AUTO** position.

▶ Press the  button.

Please observe the country-specific laws on the use of rear fog lamps.

### Operating the light combination switch

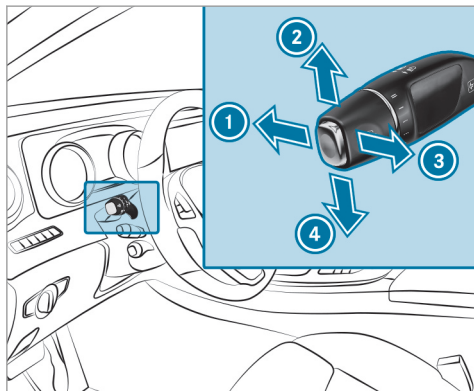

- ① High beam
- ② Turn signal light, right

- ③ Headlamp flashing
- ④ Turn signal light, left

▶ Pull or push the combination switch in the relevant direction following the arrow.

### Switching on the high beam manually

#### ▶ Vehicles with Adaptive Highbeam Assist:

- Turn the light switch to the  position.
- Press the combination switch beyond the pressure point in the direction of arrow ①.

When the high beam is activated, the indicator lamp for low beam is deactivated and replaced by the indicator lamp for the high beam.

▶ **To switch off the high beam:** move the combination switch back to its starting position.

▶ **To indicate briefly:** press the combination switch briefly up to the pressure point in the direction of arrow ② or ④. The corresponding turn signal light flashes three times.

- ▶ **To indicate for a duration:** press the combination switch beyond the pressure point in the direction of arrow ② or ④.

### Activating/deactivating the hazard warning light

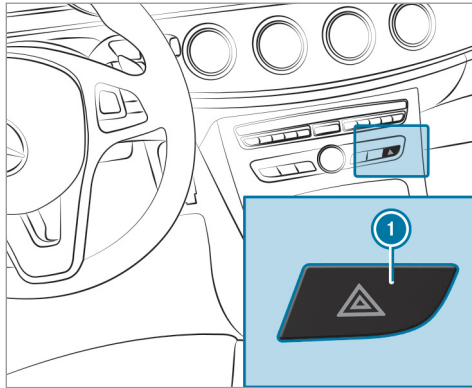

- ▶ Press button ①.

### Cornering light

#### Cornering light function

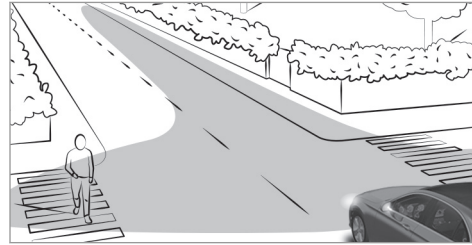

Cornering light improves the illumination of the road over a wide angle in the direction you are turning, enabling better visibility in tight bends, for example. It can only be activated when the low beam is switched on.

The function is active:

- At speeds below 25 mph (40 km/h) when the turn signal light is switched on or the steering wheel is turned.

- At speeds between 25 mph (40 km/h) and 45 mph (70 km/h) when the steering wheel is turned.

**Traffic circle and intersection function:** the cornering light is activated on both sides through an evaluation of the current GPS position of the vehicle. It remains active until after the vehicle has left the traffic circle or the intersection.

### Adaptive Highbeam Assist

#### Function of Adaptive Highbeam Assist

**⚠ WARNING** Risk of accident despite Adaptive Highbeam Assist

Adaptive Highbeam Assist does not recognize the following road users:

- Road users without lights, e.g. pedestrians
- Road users with poor lighting, e.g. cyclists
- Road users whose lighting is obstructed, e.g. by a barrier

On very rare occasions, Adaptive Highbeam Assist may fail to recognize other road users with their own lighting, or may recognize them too late.

In these or similar situations, the automatic high beam is not deactivated or is activated despite the presence of other road users.

- ▶ Always observe the traffic carefully and switch off the high beam in good time.

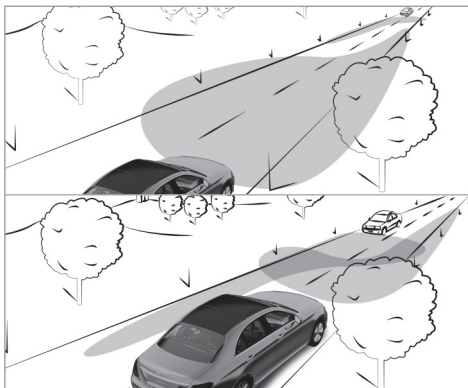

Adaptive Highbeam Assist switches automatically between:

- Low beam
- High beam

At speeds above 19 mph (30 km/h):

- If no other road users are detected, the high beam is automatically switched on.

The high beam switches off automatically:

- At speeds below 16 mph (25 km/h).
- If other road users are detected.
- If street lighting is sufficient.

At speeds above approx. 31 mph (50 km/h):

- The headlamp range of the low beam is regulated automatically based on the distance to other road users.

The system's optical sensor is located behind the windshield near the overhead control panel.

#### System limitations

Adaptive Highbeam Assist cannot take into account road, weather or traffic conditions.

Detection may be restricted if:

- Visibility is impaired, for example in fog, heavy rain or snow.
- There is dirt on the sensors or if the sensors are covered over.

#### Switching Adaptive Highbeam Assist on/off

- ▶ **To switch on:** turn the light switch to the **AUTO** position.

- ▶ Switch on the high beam using the combination switch.  
When the high beam is switched on automatically in the dark, the  indicator lamp in the multifunction display comes on.
- ▶ **To switch off:** switch off the high beam using the combination switch.

### Switching the daytime running lights on/off

Multimedia system:

➔ Vehicle ➔  Light Settings ➔ Day-time Run. Lights

- ▶ Switch the function on  or off .

### Setting the surround lighting

#### Prerequisite

The light switch is in the  position.

Multimedia system:

➔ Vehicle ➔  Light Settings ➔ Locator Lighting

**Exterior switch-off delay time:** the exterior lighting is switched on for a short time after the vehicle is switched off.

- ▶ Set the switch-off delay time.





**Locator lighting:** if a switch-off delay time is set, the exterior lighting remains lit for 30 seconds after the vehicle is unlocked. When you start the vehicle, the locator lighting is switched off and automatic driving lights are activated.

## Interior lighting

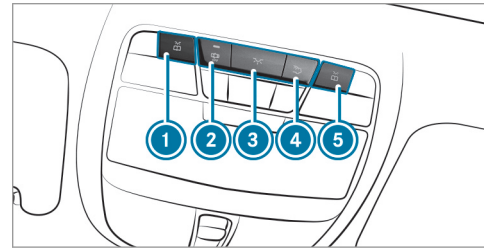
### Adjusting the interior lighting

#### Front overhead control panel



- ▶ ①  Switches the front left-hand reading lamp on/off
- ▶ ②  Switches the automatic interior lighting control on/off
- ▶ ③  Switches the front interior lighting on/off
- ▶ ④  Switches the rear interior lighting on/off

- ▶ ⑤  Switches the front right-hand reading lamp on/off

### Control panel in the grab handle (rear passenger compartment)

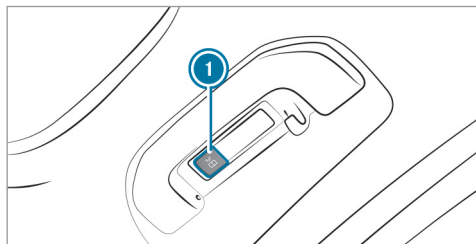

- ▶ ①  Switches the reading lamp on/off

### Adjusting the ambient lighting

Multimedia system:

- ▶  Vehicle ▶  Light Settings ▶ Ambient Light

#### Setting the color



- ▶ Select **Color**.
- ▶ Setting the color.

#### Setting the brightness for zones

- ▶ Select **Entire Vehicle**, **Front**, **Rear** or **Display**.
- ▶ Set the brightness value.

### Setting the interior lighting switch-off delay time



Multimedia system:

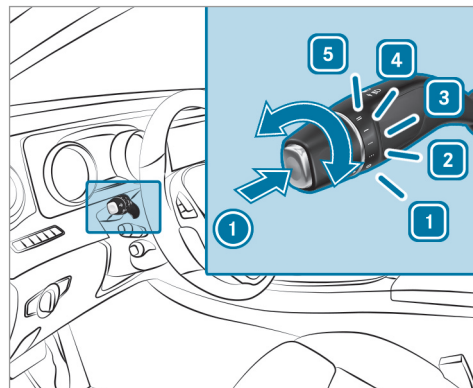

- ▶  Vehicle ▶  Light Settings ▶ Int. Light Delay Sw. off
- ▶ Set the switch-off delay time.

### Windshield wiper and windshield washer system

#### Switching the windshield wipers on or off



- ▶ ①  Single wipe/  wipes the windshield using washer fluid
- ▶ ① 0 Windshield wipers off
- ▶ ② ... Intermittent wiping, normal

- ▶ 3  Intermittent wiping, frequent
- ▶ 4  Continuous wiping, slow
- ▶ 5  Continuous wiping, fast

### Changing the windshield wiper blades

**⚠ WARNING** Risk of becoming trapped if the windshield wipers are switched on while wiper blades are being replaced

If the windshield wipers begin to move while you are changing the wiper blades, you can be trapped by the wiper arm.

- ▶ Always switch off the windshield wipers and the ignition before changing the wiper blades.

### Moving the wiper arms to a vertical position

- ▶ Set the windshield wiper to the  slow continuous wiping position on the combination switch.
- ▶ As soon as the wiper arms are vertical to the hood, switch off the ignition.
- ▶ Fold the wiper arm away from the windshield.

### Removing the wiper blades

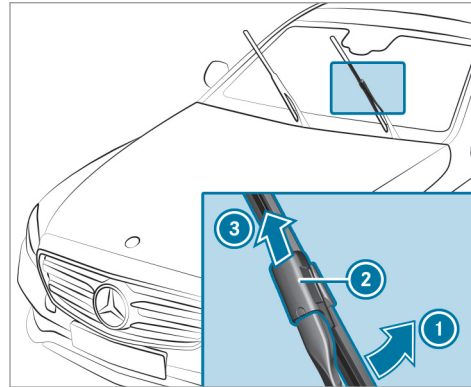

- ▶ Hold the wiper arm with one hand. With the other hand, turn the wiper blade in the direction of arrow ① away from the wiper arm to the stop.
- ▶ Slide catch ② in the direction of arrow ③ until it engages in the removal position.

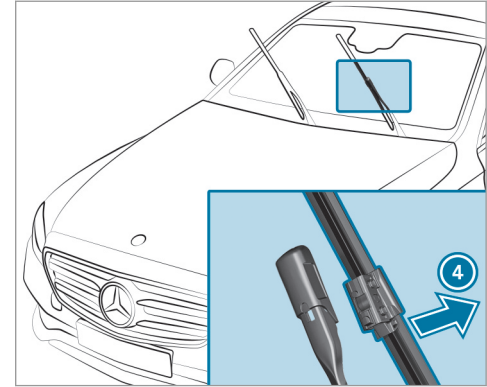

- ▶ Remove the wiper blade in the direction of arrow ④ from the wiper arm.

### Installing the wiper blades

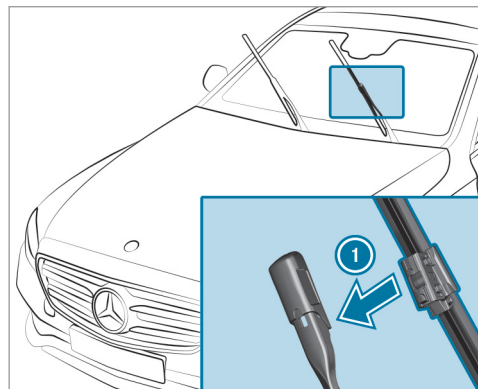

- ▶ Insert the new wiper blade into the wiper arm in the direction of arrow ①.

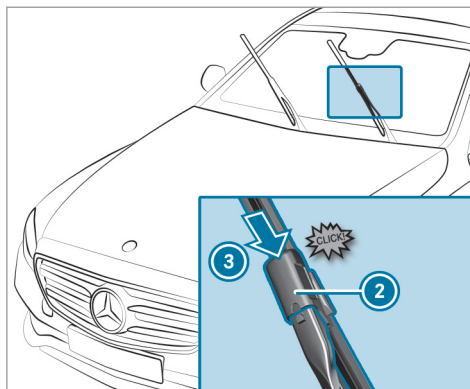

- ▶ Slide catch ② in the direction of arrow ③ until it engages in the locking position.
- ▶ Make sure that the wiper blade sits correctly.
- ▶ Fold the wiper arm back onto the windshield.

### Maintenance display

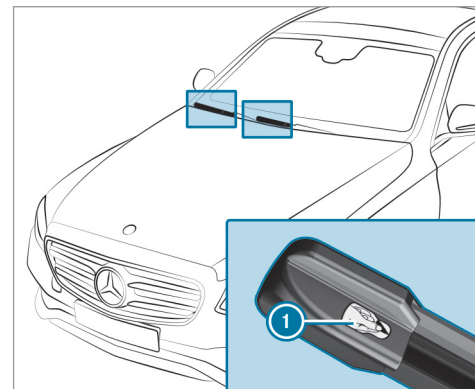

- ▶ Remove protective film ① of the maintenance display on the tip of the newly installed wiper blade.

If the color of the maintenance display changes from black to yellow, the wiper blades should be replaced.



- ⓘ The duration of the color change varies depending on the usage conditions.

## Mirrors

### Operating the outside mirrors

- ⚠ WARNING** Risk of injury from adjusting the vehicle settings while the vehicle is in motion

You could lose control of the vehicle in the following situations:

- if you adjust the driver's seat, the head restraint, the steering wheel or the mirror while the vehicle is in motion
  - if you fasten your seat belt while the vehicle is in motion
- ▶ Before starting the engine: adjust the driver's seat, the head restraint, the steering wheel or the mirror and fasten your seat belt.

- ⚠ WARNING** Risk of accident due to misjudgment of distances when using the outside mirror

The outside mirrors reflect objects on a smaller scale. The objects in view are in fact closer than they appear.

As a result, you may misjudge the distance between you and the road user driving behind you, e.g. when changing lanes.

- ▶ Therefore, always look over your shoulder in order to ensure that you are aware of the actual distance between you and the road users driving behind you.

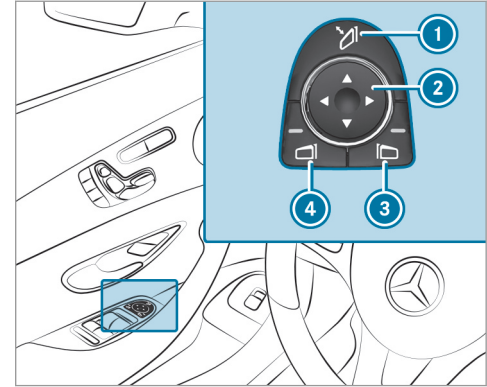

- ▶ **To fold in or out:** briefly press button ①.

- ⓘ If the battery has been disconnected or completely discharged, the outside mirrors must be reset. Only then will the automatic mirror folding function work properly.

- ▶ **To set:** select the required mirror using button ③ or ④.

- ▶ Use button ② to set the position of the mirror you have selected.

An outside mirror which has been pushed out of position can be engaged in position again in the following manner:

- ▶ **Vehicles with electrically folding outside mirrors:** Press and hold button ①. You will hear a click and the mirror audibly engage in position. The mirror is set into the correct position.

### Automatic anti-glare mirrors

**⚠ WARNING** Risk of burns and poisoning due to electrolyte of the anti-glare mirror

Electrolyte may escape if the glass in an automatic anti-glare mirror breaks.

The electrolyte is harmful and causes irritation. It must not come into contact with your skin, eyes, respiratory organs or clothing or be swallowed.

If you come into contact with electrolyte, observe the following:

- Rinse the electrolyte from your skin and seek medical attention immediately.
- If electrolyte comes into contact with your eyes, rinse them thoroughly with clean water and seek medical attention immediately.
- If the electrolyte is swallowed, immediately rinse your mouth out thoroughly. Do not induce vomiting. Seek medical attention immediately.
- Immediately change out of clothing which has come into contact with electrolyte.
- If an allergic reaction occurs, seek medical attention immediately.

The outside and inside rearview mirrors on the driver's side automatically go into anti-glare mode if light from a headlamp hits the inside rearview mirror.

### System limitations

The mirrors do not go into anti-glare mode in the following situations:

- The engine is switched off.
- The reverse gear is engaged.
- The interior lighting is switched on.

### Parking position of the passenger outside mirror

The parking position makes parking easier.

The passenger outside mirror tilts downwards and shows the rear wheel on the front passenger side if:

- The parking position is stored
- The passenger mirror is selected
- And the reverse gear is engaged.

The passenger outside mirror moves back to its original position in the following situations:

- If you shift the transmission to another transmission position
- If you drive faster than 15 km/h

- If you press the button for the outside mirror on the driver's side.

### Saving the parking position of the passenger outside mirror

#### Prerequisite

Reverse gear must not be engaged when storing using the memory button.

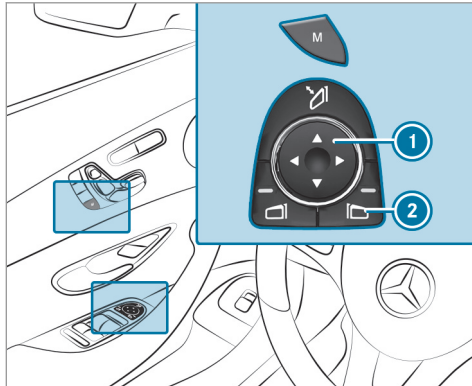

- ▶ **To store using the memory button:** select the passenger outside mirror using button ②.
  - ▶ Move the passenger outside mirror into the desired parking position using button ①.
  - ▶ Press memory button M.
  - ▶ Confirm immediately using button ① to store the setting.
- ⓘ No more than three seconds may pass between pressing memory button M and button ①. The mirror setting process is canceled after three seconds.

### Activating/deactivating the automatic mirror folding function

Multimedia system:

➔ Vehicle ➔ Vehicle Settings ➔ Autom. Mirror Folding

- ▶ Activate  or deactivate  the function.

### Operating the sun visors

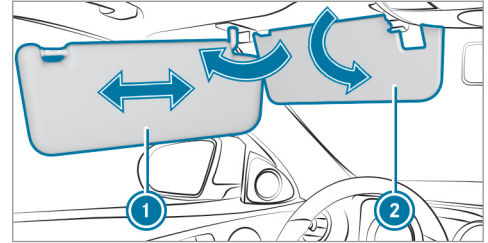

- ▶ **Glare from the front:** fold sun visor ① down.
- ▶ **Glare from the side:** swing sun visor ① to the side.
- ▶ Slide sun visor ① horizontally as required.
- ▶ **Vehicles with an additional sun visor:** fold additional sun visor ② down.

### Infrared reflective windshield

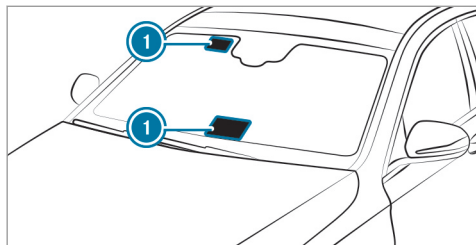

The infrared reflective windshield is coated and prevents an excessive build-up of heat in the vehicle interior.

The coating shields the vehicle interior against radio waves up into the gigahertz range.

Radio-controlled equipment such as toll systems can only be mounted on areas of the windshield which are permeable to radio waves ①.

Areas permeable to radio waves ① are best visible from outside the vehicle when the windshield is illuminated using an external light source.

## Overview of climate control systems

### Dual-zone automatic climate control panel overview

The indicator lamps in the buttons indicate that the current function is activated.

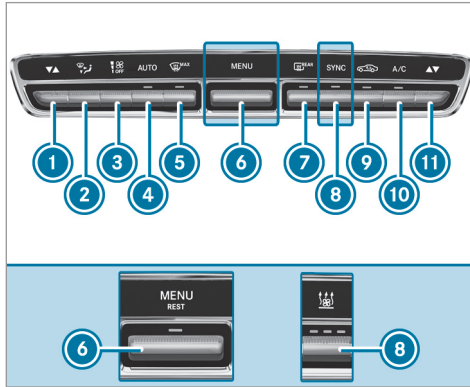



- ① To set the driver's side temperature
- ② To set the air distribution

- ③ To set the airflow or switch off climate control
- ④ To set climate control to automatic mode (→ page 123)
- ⑤ To defrost the windshield
- ⑥ To call up the climate control menu of the multimedia system
- ⑦ To switch the rear window heater on/off
- ⑧ **SYNC** To activate or deactivate synchronization (→ page 124)
- ⑨ To switch air-recirculation mode on/off (→ page 124)
- ⑩ To switch the A/C function on/off (→ page 123)
- ⑪ To set the front passenger side temperature

## Operating the climate control system

### Activating/deactivating climate control

- ▶ **To activate:** set the airflow to level 1 or higher using the  button.
- ▶ **To deactivate:** set the airflow to level 0 using the  button.

- ① If climate control is deactivated, the windows can fog up more quickly. Deactivate climate control only briefly.

### Activating/deactivating the A/C function via the control panel

The A/C function cools, heats and dehumidifies the interior air in the vehicle.



- ▶ Press the  button.

Deactivate the A/C function only briefly otherwise the windows can fog up more quickly.

Condensation may drip from the underside of the vehicle when cooling mode is active. This is not a sign that there is a malfunction.









### Setting climate control to automatic mode

In automatic mode, the set temperature is controlled and maintained at a constant level by the air supply.

- ▶ Press the  button.
- ▶ **To switch to manual mode:** press the  or  button.

### Air distribution settings

The symbols in the display indicate which vents the airflow is being directed through:

-  Defroster vent
-  Center and side air vents
-  Footwell vents
-  Center, side and footwell vents
-  Defroster and footwell vents
-  All vents
-  Defroster, middle and side air vents
-  Automatic air distribution

### Activating/deactivating the climate control synchronization function via the control panel

Climate control can be set centrally using the synchronization function. The temperature and air distribution setting for the driver's side is adopted automatically for the front passenger side.

- ▶ Press the **SYNC** button.

The synchronization function is deactivated if the settings for one of the other climate zones are changed.

### Defrosting the windows

#### Windows fogged up on the inside

- ▶ Press the **AUTO** button.
- ▶ If the windows continue to fog up: press the  button.

#### Windows fogged up on the outside

- ▶ Switch on the windshield wipers.
- ▶ Press the **AUTO** button.

### Switching air-recirculation mode on/off

- ▶ Press the  button.
- ▶ The interior air will be recirculated.

Air-recirculation mode is switched off automatically.

- ① If air-recirculation mode is switched on, the windows may fog up more quickly. Switch on air-recirculation mode only briefly.

### Activating and deactivating ionization

Multimedia system:

 Vehicle ▶  Climate Control ▶ Ionization

Ionization cleans and refreshes the interior air of the vehicle. The ionization of the interior air is odorless.

- ▶ Switch the function on  or off .

### Perfume atomizer

#### Setting the fragrance system

##### Requirements

- Automatic climate control is activated.
- The glove box is closed.

Multimedia system:

 Vehicle ▶  Climate Control ▶ Air Freshener

The fragrance system distributes a pleasant fragrance throughout the vehicle interior from a flask located in the glove box.

- ▶ **To set the intensity:** select **High**, **Medium**, **Low** or **Off**.

### Inserting or removing a fragrance system flacon

#### **⚠ WARNING** Risk of injury from liquid perfume

If children open the flacon, they could drink the liquid perfume or it could come into contact with their eyes.

- ▶ Consult a doctor immediately if liquid perfume has been drunk.
- ▶ If liquid perfume comes into contact with your eyes or skin, rinse your eyes with clean water.
- ▶ If symptoms continue, consult a doctor.

#### **!** ENVIRONMENTAL NOTE Environmental damage due to improper disposal of full flacons



Full flacons must not be disposed of with household waste.



Full flacons must be taken to a harmful substance collection point.

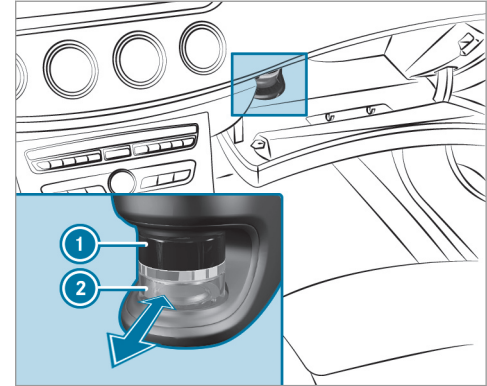

- 1 Cover
- 2 Flacon

▶ **To insert:** slide the flacon into the holder as far as it will go.

▶ **To remove:** pull out the flacon.

If you do not use genuine Mercedes-Benz interior perfumes, observe the manufacturers' safety notices on the perfume packaging.

Dispose of the genuine Mercedes-Benz interior perfume flacon when it is empty and do not refill it.

### Refillable flacon

- ▶ Unscrew the cover of the empty flacon.
- ▶ Fill the flacon with a maximum of 0.5 fl. oz. (15 ml).
- ▶ Screw the cover back on to the flacon.

Always refill the empty refillable flacon with the same perfume. Observe the separate information sheet attached to the flacon.

### Information on the windshield heater

The windshield heater is switched on automatically:

- If the  button is activated.

After the vehicle is started the windshield heater is switched on automatically as needed.

### Air vents

#### Adjusting the front air vents

**⚠ WARNING** - Danger of burns or frostbite due to being too close to the air vents

Very hot or very cold air can flow from the air vents.

This could result in burns or frostbite in the immediate vicinity of the air vents.

- ▶ Make sure that all vehicle occupants always maintain a sufficient distance to the air vents.
- ▶ If necessary, direct the airflow to another area of the vehicle interior.

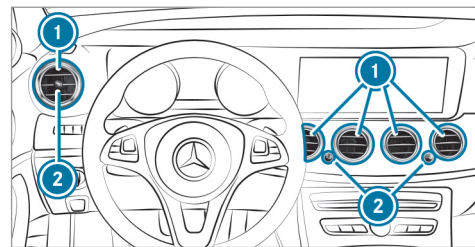

- ▶ **To open or close:** turn controller ② to the left or right as far as it will go.
- ▶ **To adjust the airflow direction:** hold air vent ① in the center and move it up or down or to the left or right.



### Adjusting the rear air vents

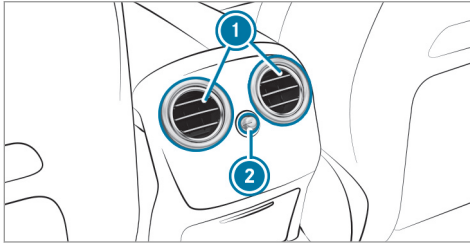

- ▶ **To open or close:** turn controller ② to the left or right as far as it will go.
- ▶ **To adjust the airflow direction:** hold rear air vent ① in the center and move it up or down or to the left or right.

### Opening/closing the air vent in the glove box

**!** **NOTE** Damage to temperature-sensitive objects in the glove box

Temperature-sensitive objects stored in the glove box may be damaged by the air vent located inside it.

- ▶ Close the air vent when you heat the vehicle.
- ▶ At high outside temperatures, open the air vent and switch on the A/C function.

#### Requirement:

Automatic climate control is activated.

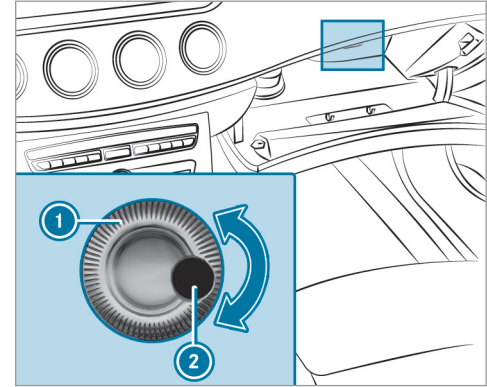

- ① Air vent controller
- ② Air vent

- ▶ **To open or close:** turn controller ① to the left or right.

## Driving

### Switching on the power supply or ignition using the start/stop button

**⚠ WARNING** Risk of accident and injury due to children left unattended in the vehicle

If children are left unattended in the vehicle, they could:

- Open doors, thereby endangering other persons or road users
- Get out of the vehicle and be hit by oncoming traffic
- Operate vehicle equipment

In addition, the children could also set the vehicle in motion, for example, by:

- Releasing the parking brake
- Shifting the transmission out of park position **P**
- Starting the engine.

- ▶ Never leave children and animals unattended in the vehicle.
- ▶ When leaving the vehicle, always take the SmartKey with you and lock the vehicle.
- ▶ Keep the SmartKey out of the reach of children.

**⚠ WARNING** Risk of exhaust gas poisoning

Combustion engines emit poisonous exhaust gases such as carbon monoxide. Inhaling these exhaust gases causes poisoning.

- ▶ Never leave the engine running in an enclosed space without sufficient ventilation.

**⚠ WARNING** Risk of fire caused by flammable material on the exhaust system

Flammable materials brought in by either animals or environmental influences may ignite if they come into contact with hot parts of the engine or exhaust system.

- ▶ Therefore, check regularly that there are no flammable materials in the engine compartment or on the exhaust system.

### Requirements

- The SmartKey is located in the vehicle and the SmartKey battery is not discharged.

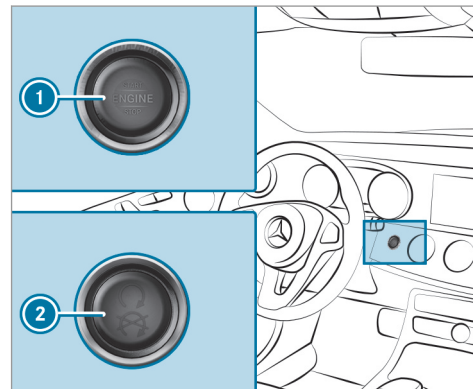

- ▶ **To switch on the power supply:** Press button ① (USA) or ② (Canada) once. You can now activate the windshield wiper, for example.

The power supply is switched off again if the following conditions are met:

- The driver's door is open.
- You press button ① (USA) or ② (Canada) twice.

- ▶ **To switch on the ignition:** Press button ① (USA) or ② (Canada) twice. The indicator lamps in the instrument cluster light up.

The ignition is switched off again if one of the following conditions is met:

- You do not start the vehicle within 15 minutes.
- You press button ① (USA) or ② (Canada) once.

## Starting the vehicle

### Starting the vehicle with the start/stop button

#### Requirements

- The SmartKey is located in the vehicle and the SmartKey battery is not discharged.

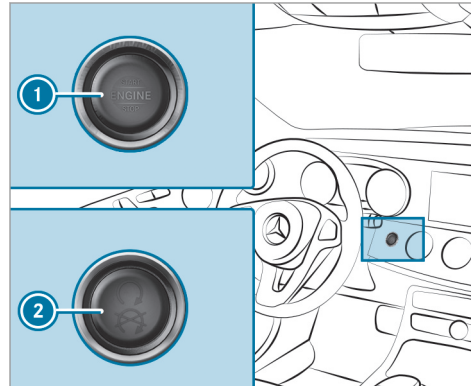

- ▶ Shift the transmission to position **P** or **N**.

- ▶ Depress the brake pedal and push button ① (USA) or ② (Canada) once.
- ▶ If the vehicle does not start: switch off non-essential consumers and press button ① (USA) or ② (Canada) once.
- ▶ If the vehicle still does not start: start the vehicle in emergency operation mode.

### Cooling or heating the vehicle interior before starting the journey

If you start the vehicle via your smartphone, the previously selected climate control setting is active.

Before starting, make sure:

- The legal stipulations in the area where your vehicle is parked permit engine starting via smartphone.
- It is safe to start and run the engine where your vehicle is parked.
- The fuel tank is sufficiently filled.
- The starter battery has been sufficiently charged.

### Starting the vehicle using a smartphone

**⚠ WARNING** Risk of crushing or entrapment due to unintentional starting of the engine

Limbs could be crushed or trapped if the engine is started unintentionally during service or maintenance work.

- ▶ Always secure the engine against unintentional starting before carrying out maintenance or repair work.

#### Requirements

- Park position **P** is selected.
- The anti-theft alarm system is not armed.
- The panic alarm is not armed.
- The hazard warning lights are switched off.
- The engine hood is closed.
- The doors are closed and locked.
- The windows and sliding sunroof are closed.
- ▶ Start the vehicle using the smartphone:

- ① • You can carry out a maximum of two consecutive starting attempts.
- You can stop the again vehicle any time.

#### Securing the engine against starting before carrying out maintenance or repair work:

- ▶ Switch on the hazard warning lights.

or

- ▶ Unlock the doors.

or

- ▶ Open the hood.

#### Starting the vehicle in emergency operation mode

If the vehicle cannot be started, the [Place the Key in the Marked Space](#) See Operator's Manual display message appears in the multifunction display.

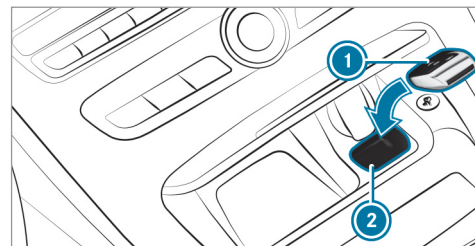

- ▶ Make sure that stowage space ② is empty.
  - ▶ Remove SmartKey ① from the key ring.
  - ▶ Place SmartKey ① in the stowage space ②. The vehicle will start after a short while.
- If you remove SmartKey ① from stowage space ② the engine continues running. For further vehicle starts however, SmartKey ① must be located in stowage space ② during the entire journey.
- ▶ Have SmartKey ① checked at a qualified specialist workshop.

#### If the vehicle does not start:

- ▶ Leave SmartKey ① in stowage space ②.

▶ Depress the brake pedal and start the vehicle using the start/stop button.

ⓘ You can also switch on the power supply or the ignition with the start/stop button.

### Information on Hill Start Assist

Hill Start Assist holds the vehicle when pulling away on a hill under the following conditions:

- **Vehicles with automatic transmission:** The transmission is in position **D** or **R**.
- The electric parking brake is released.

**⚠ WARNING** Risk of accident and injury caused by the vehicle rolling away

After a short time, Hill Start Assist no longer holds the vehicle and it can roll away.

▶ Therefore, swiftly move your foot from the brake pedal to the accelerator pedal. Never attempt to leave the vehicle if it is being held by Hill Start Assist.

### Notes on breaking-in a new vehicle

To preserve the engine during the first 1,000 miles (1,500 km):

- Drive at varying road speeds and engine speeds.
- Drive the vehicle in drive program **C** or **E**.
- Change gear before the tachometer needle is  $\frac{2}{3}$  of the way to the red area of the tachometer.
- Do not shift down a gear manually in order to brake.
- Avoid overstraining, e.g. driving at full throttle.
- **Vehicles with automatic transmission:** Do not depress the accelerator pedal past the pressure point (kickdown).
- Only increase the engine speed gradually and accelerate the vehicle to full speed after 1,000 miles (1,500 km).

This also applies when the engine or parts of the drivetrain have been replaced.

Please also observe the following breaking-in notes:

- In certain driving and driving safety systems, the sensors adjust automatically while a certain distance is being driven after the vehicle has been delivered or after repairs. Full system effectiveness is not achieved until the end of this teach-in process.
- Brake linings, brake discs and tires that are either new or have been replaced only achieve optimum braking effect and grip after several hundred kilometers of driving. Compensate for this by applying greater force to the brake pedal.

### Driving tips

**⚠ WARNING** Risk of accident due to objects in the driver's footwell

Objects in the driver's footwell may impede pedal travel or block a depressed pedal.

This jeopardizes the operating and road safety of the vehicle.

- ▶ Stow all objects in the vehicle securely so that they cannot get into the driver's footwell.
- ▶ Always install the floor mats securely and as prescribed in order to ensure that there is always sufficient room for the pedals.
- ▶ Do not use loose floor mats and do not place floor mats on top of one another.

**⚠ WARNING** Risk of accident due to unsuitable footwear

Operation of the pedals may be restricted due to unsuitable footwear such as:

- Shoes with platform soles
  - Shoes with high heels
  - Slippers
- ▶ When driving always wear suitable shoes in order to be able to operate the pedals safely.

**⚠ WARNING** Risk of accident due to the ignition being switched off whilst the vehicle is in motion

If you switch off the ignition whilst the vehicle is in motion safety-relevant functions will be restricted or no longer available. This may affect the power steering system and brake force boosting, for example.

You will need to use considerably more force to steer and brake.

- ▶ Do not switch off the ignition whilst the vehicle is in motion.

**⚠ WARNING** Risk of exhaust gas poisoning

Combustion engines emit poisonous exhaust gases such as carbon monoxide. Inhaling these exhaust gases causes poisoning.

- ▶ Never leave the engine running in an enclosed space without sufficient ventilation.

**⚠ DANGER** Risk of fatal injury due to poisonous exhaust gases

If the tailpipe is blocked or sufficient ventilation is not possible, poisonous exhaust gases such as carbon monoxide may enter the vehicle. This is the case if the vehicle gets stuck in snow, for example.

- ▶ Keep the tailpipe and the area around the vehicle free from snow when the engine or the stationary heater are running.
- ▶ Open a window on the windward side of the vehicle to ensure an adequate supply of fresh air.

**⚠ WARNING** Risk of accident or injury due to driving under the influence of alcohol and drugs

Driving and the consumption of alcohol and/or drugs are an extremely dangerous combination. Even small quantities of alcohol or drugs can compromise your reflexes, perception and judgment.

The possibility of a serious or even fatal accident is greatly increased when you drink or take drugs and drive.

- ▶ Do not drink or take drugs and drive or allow anyone to drive who has been drinking alcohol or taking drugs.

**⚠ WARNING** Risk of accident due to an overheated brake system

If you rest your foot on the brake pedal whilst driving, the brake system may overheat. This increases the braking distance and the brake system may fail.

- ▶ Never use the brake pedal as a footrest.

**! NOTE** Wearing out the brake linings by continuously depressing the brake pedal

- ▶ Do not depress the brake pedal continuously whilst driving.
- ▶ To use the braking effect of the engine, shift to a lower gear in good time.

**! NOTE** Damage to the drivetrain and the engine when pulling away

- ▶ Do not warm up the engine when the vehicle is stationary. Pull away immediately.
- ▶ Avoid high engine speeds and driving at full throttle until the engine has reached operating temperature.
- ▶ Do not allow the wheels to spin.

**! NOTE** Damage to the catalytic converter due to non-combusted fuel

The engine is not running smoothly and is misfiring.

Non-combusted fuel may get into the catalytic converter.

- ▶ Only depress the accelerator pedal slightly.
- ▶ Have the cause rectified immediately at a qualified specialist workshop.

Limited braking effect on salt-treated roads:

- the braking distance can increase considerably due to salt build-up on the brake disks and brake lining.
- maintain a much greater distance to the vehicle in front.

To prevent salt build-up:

- brake occasionally while paying attention to the traffic conditions.
- carefully depress the brake pedal at the end of the journey and when starting the next journey.

### ECO start/stop function

#### **Operation of the ECO start/stop function**

The engine is switched off automatically:

- If you brake the vehicle to a standstill in transmission position **D** or **N**.
- If all vehicle conditions for an automatic engine stop are met.

The **A** symbol appears in the multifunction display when the vehicle is stationary.

If the engine was switched off by the ECO start/stop function and you leave the vehicle, a warning tone sounds. The **Vehicle Operational Switch the Ignition Off Before Exiting** display message also appears in the multifunction display.

If you do not switch off the ignition, the ignition is automatically switched off after one minute.

The engine is restarted automatically if:

- You release the brake pedal with the transmission in position **D** when the HOLD function is not active.
- You shift from transmission position **P**.
- You engage transmission position **D** or **R**.
- you depress the accelerator pedal.
- You switch to drive program **S+**.
- An automatic engine start is necessary.

### Deactivating or activating the ECO start/stop function

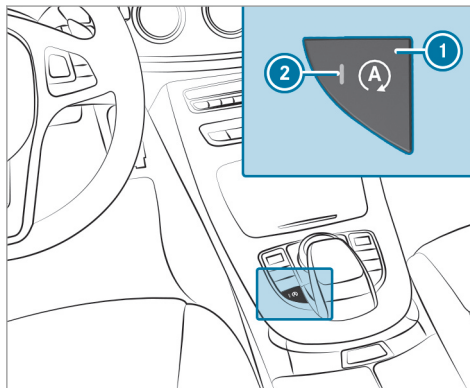

- ▶ Press button **1**.  
If indicator lamp **2** lights up, the ECO start/stop function is switched on.

**i** Depending on the model, the button may also be located at a different position in the center console.

### ECO display

The ECO display summarizes the driving style from the start of the journey to its completion and assists you in achieving the most economical driving style.

You can influence consumption if you:

- Drive with particular care.
- Drive the vehicle in drive program **E**.
- Observe the gearshift recommendations.

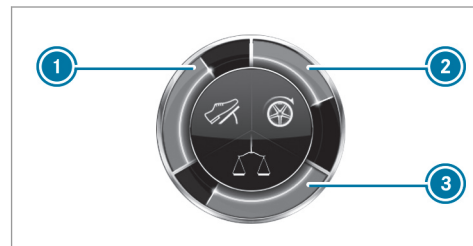

The inner segment lights up green and the outer segment fills up:

- **1** Moderate acceleration



- ② Gentle deceleration and rolling
- ③ Consistent speed

The inner segment is gray and the outer segment becomes empty:

- ① Sporty acceleration
- ② Heavy braking
- ③ Fluctuations in speed

You have driven economically when:

- The three outer segments are completely filled simultaneously.
- The ECO display border lights up.

The additional range achieved as a result of your driving style in comparison to a driver with a very sporty driving style is shown under **Bonus fr. Start**. The range displayed does not indicate a fixed reduction in consumption.

### DYNAMIC SELECT switch

#### Function of the DYNAMIC SELECT switch

Use the DYNAMIC SELECT switch to change the following drive programs:

- **I (Individual)**: individual settings
- **S+ (Sport Plus)**: particularly sporty driving style
- **S (Sport)**: sporty driving style
- **C (Comfort)**: comfortable and economical driving style
- **E (Economy)**: particularly economical driving style

Depending on the drive program selected the following vehicle characteristics will change:

- Drive system
  - Engine and transmission management
  - ESP®
  - Distance Pilot DISTRONIC
- Suspension
- Steering

- The availability of the ECO start/stop function

#### Operating the DYNAMIC SELECT switch

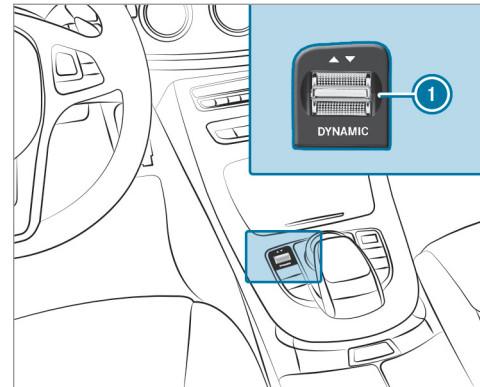

- ▶ Press DYNAMIC SELECT switch ① forwards or backwards. The drive program selected appears in the multifunction display.

### Configuring drive program I (COMAND)

Multimedia system:

→ Vehicle ►  DYNAMIC

SELECT ► Individual

- Select Drive, Suspension, Steering or ECO Start/Stop.
- Select the individual setting.

### Displaying vehicle data

Multimedia system:

→ Vehicle ►  DYNAMIC SELECT

- Select Vehicle Data.

### Displaying engine data

Multimedia system:

→ Vehicle ►  DYNAMIC SELECT

- Select Engine Data.
- ⓘ The values for engine output and engine torque may deviate from the nominal values.

Items that can influence this are, for example:

- Engine speed
- Sea level
- Fuel grade
- Outside temperature

### Automatic transmission

#### DIRECT SELECT selector lever

##### Function of the DIRECT SELECT lever

**⚠ WARNING** Risk of accident and injury due to children left unattended in the vehicle

If children are left unattended in the vehicle, they could:

- Open doors, thereby endangering other persons or road users
- Get out of the vehicle and be hit by oncoming traffic

- Operate vehicle equipment

In addition, the children could also set the vehicle in motion, for example, by:

- Releasing the parking brake
  - Shifting the transmission out of park position **P**
  - Starting the engine.
- Never leave children and animals unattended in the vehicle.
  - When leaving the vehicle, always take the SmartKey with you and lock the vehicle.
  - Keep the SmartKey out of the reach of children.

**⚠ WARNING** Risk of accident due to incorrect gearshifting

If the engine speed is higher than the idle speed and you engage the transmission position **D** or **R**, the vehicle may accelerate sharply.

- ▶ If you engage the transmission position **D** or **R** always depress the brake pedal firmly and do not accelerate at the same time.

**!** **NOTE** Damage to the automatic transmission caused by changing the transmission position during the journey

- ▶ Only change the transmission position when the vehicle is stationary.

Use the DIRECT SELECT lever to shift the transmission position. The current transmission position is displayed in the multifunction display.

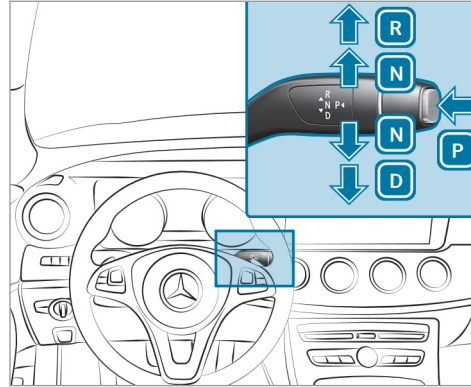

- P** Park position
- R** Reverse gear
- N** Neutral
- D** Drive position

### Engaging reverse gear R

- ▶ Depress the brake pedal and push the DIRECT SELECT selector lever up past the first point of resistance. Transmission position display **R** is shown in the multifunction display.

### Shifting to neutral N

- ▶ Depress the brake pedal and push the DIRECT SELECT lever up or down to the first point of resistance. Transmission position display **N** is shown in the multifunction display.

Releasing the brake pedal will allow you to move the vehicle freely, e.g. to push it or tow it away.

### If you want the automatic transmission to remain in neutral N even if the ignition is switched off:

- ▶ Start the vehicle.
- ▶ Depress the brake pedal and shift to neutral **N**.
- ▶ Release the brake pedal.
- ▶ Switch the ignition off.

- Automatic transmission remains in neutral **N**, when you leave the vehicle and the SmartKey remains in the vehicle.

### Engaging park position P

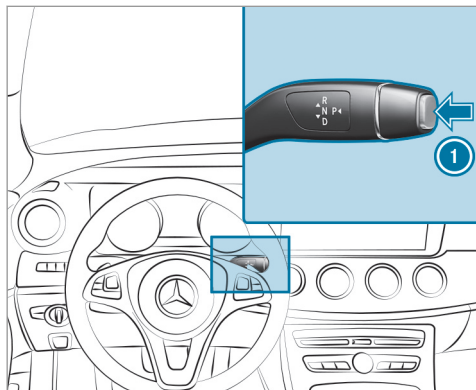

- Press button ①. Transmission position display **P** is shown in the multifunction display.

Park position **P** is engaged automatically if one of the following conditions is met:

- If you switch the engine off with the transmission in position **D** or **R**.
- If you open the driver's door when the vehicle is stationary or when driving at a very low speed and the transmission is in position **D** or **R**.

### Engaging drive position D

- Depress the brake pedal and push the DIRECT SELECT lever down past the first point of resistance. Transmission position display **D** is shown in the multifunction display.

When the automatic transmission is in transmission position **D**, it shifts the gears automatically. This is determined by:

- The selected drive program
- The position of the accelerator pedal
- The road speed

### Manual gearshifting

**⚠ WARNING** Risk of skidding and of an accident due to shifting down on slippery road surfaces

If you shift down on slippery road surfaces to increase the engine braking effect, the drive wheels may lose traction.

- Do not shift down on slippery road surfaces to increase the engine braking effect.

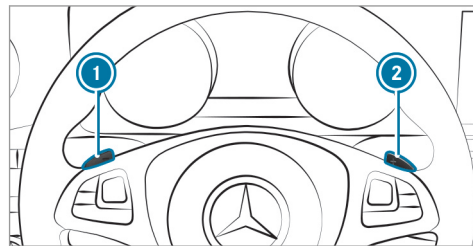

- ▶ **To activate:** pull steering wheel gearshift paddle ① or ②. Manual gearshifting is activated for a short time. The current gear is displayed in the multifunction display.
  - ▶ **To shift up:** pull steering wheel gearshift paddle ②.
  - ▶ **To shift down:** pull steering wheel gearshift paddle ①.
  - ▶ **To deactivate:** pull steering wheel gearshift paddle ② and hold it in place. The transmission position **D** appears in the multifunction display.
- ① If you select the **manual** drive setting in drive program **I**, manual gearshifting is permanently activated.

### Gearshift recommendation

The gearshift recommendations assist you in adopting a fuel-efficient driving style.

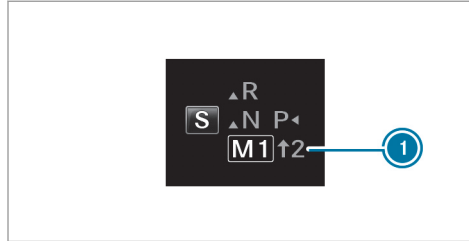

- ▶ If gearshift recommendation message ① is shown in the multifunction display, shift to the recommended gear.

### Using kickdown

- ▶ **Maximum acceleration:** depress the accelerator pedal beyond the pressure point.

During kickdown, you cannot shift gears using the steering wheel gearshift paddles. The automatic transmission shifts up to the next gear when the maximum engine speed is reached to protect the engine from overrevving.

- ▶ Ease off the accelerator pedal once the desired speed is reached.

### Refueling

#### Refueling the vehicle

- ⚠ **WARNING** Risk of fire and explosion caused by fuel

Fuels are highly inflammable.

- ▶ You must avoid fire, open flames, creating sparks and smoking.
- ▶ Before refueling, switch off the engine and, if installed in your vehicle, the stationary heater.

- ⚠ **WARNING** Risk of injury from fuel

Fuels are poisonous and harmful to your health

- ▶ Do not swallow fuel or let it come into contact with skin, eyes or clothing.
- ▶ Do not inhale fuel vapors.

- ▶ Keep children away from fuel.

If you or other people come into contact with fuel, observe the following:

- ▶ Immediately rinse fuel off your skin with soap and water.
- ▶ If fuel comes into contact with your eyes, immediately rinse them thoroughly with clean water. Seek medical attention immediately.
- ▶ If you swallow fuel, seek medical attention immediately. Do not induce vomiting.
- ▶ Change immediately out of clothing that has come into contact with fuel.

**⚠ WARNING** Risk of explosion or fire due to electrostatic charge

Electrostatic charge can cause sparks and thereby ignite fuel vapors.

- ▶ Always touch the metal vehicle body before opening the fuel filler cap or touching the pump nozzle.

This discharges any electrostatic charge that may have built up.

**!** **NOTE** Damage caused by the wrong fuel

Fuel that does not conform to the required quality can lead to increased wear as well as damage to the engine and exhaust system.

- ▶ Only use the fuel recommended.

**!** **NOTE** Damage caused by the wrong fuel

Vehicles with a gasoline engine:

Even small amounts of the wrong fuel could result in damage to the fuel system, the engine and the emission control system.

- ▶ Only refuel with low-sulfur premium grade fuel.

This fuel may contain up to 10 % ethanol. Your vehicle is suitable for use with E10 fuel.

Do not refuel using:

- Diesel
- E15, E85, E100
- Gasoline containing methanol (M15, M30, M85, M100)
- Gasoline with additives containing metal

If you accidentally refuel with the wrong fuel:

- ▶ Do not switch the ignition on.
- ▶ Consult a qualified specialist workshop.

**!** **NOTE** Do not use diesel to refuel vehicles with a gasoline engine.

- ▶ Do not switch on the ignition if you accidentally refuel with the wrong fuel. Otherwise, fuel can enter the fuel system. Even small amounts of the wrong fuel could result in damage to the fuel system and the engine. Notify a qualified specialist workshop and have the fuel tank and fuel lines drained completely.

**!** **NOTE** Do not overfill the fuel tank as this may damage the fuel system.

▶ Only fill the fuel tank until the pump nozzle switches off.

**!** **NOTE** Do not overfill the fuel tank as otherwise fuel could spray out when the pump nozzle is removed.

▶ Only fill the fuel tank until the pump nozzle switches off.

### Requirement

The vehicle must be unlocked.

**i** Do not get into the vehicle again during the refueling process. Otherwise, electrostatic charge could build up again.

Observe the notes on operating fluids (→ page 366).

### Refueling

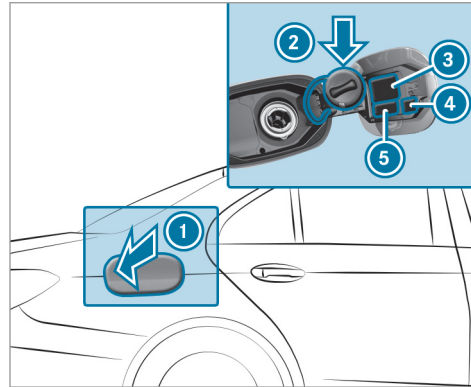

- ① Fuel filler flap
- ② Bracket for the fuel filler cap
- ③ Tire pressure table
- ④ QR code for rescue card
- ⑤ Fuel type

▶ Press fuel filler flap ①.

- ▶ Turn the fuel filler cap counter-clockwise and remove it.
- ▶ Insert the fuel filler cap into holder ②.
- ▶ Completely insert the filler neck of the fuel pump nozzle into the tank, hook in place and refuel.
- ▶ Only fill the tank until the pump nozzle switches off.

### Parking

#### Switching off the vehicle with the start/stop button

**!** **WARNING** Risk of fire caused by hot exhaust system parts

Flammable material such as leaves, grass or twigs may ignite if they come into contact with hot parts of the exhaust system or exhaust gas flow.

▶ Park the vehicle so that no flammable material can come into contact with hot vehicle components.

- ▶ In particular, do not park on dry grass-land or harvested grain fields.

**⚠ WARNING** Risk of accident and injury due to children left unattended in the vehicle

If you leave children unaccompanied in the vehicle, they may be able to set the vehicle in motion, for example by:

- Releasing the parking brake.
- Shifting the transmission out of park position **P**.
- Starting the engine.

In addition, they may operate vehicle equipment.

- ▶ Never leave children and animals unattended in the vehicle.
- ▶ When leaving the vehicle, always take the SmartKey with you and lock the vehicle.

**! NOTE** Damage to the vehicle or the drivetrain caused by the vehicle rolling away

- ▶ Always properly secure the vehicle against rolling away.

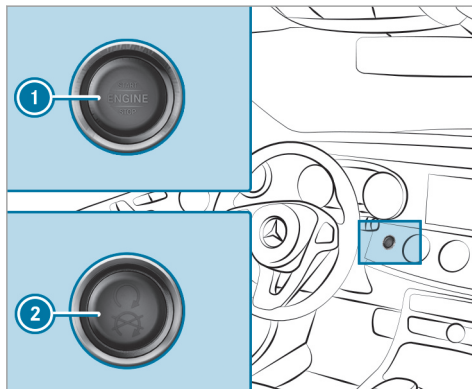

- ▶ On uphill or downhill inclines, turn the front wheels towards the curb.
- ▶ Apply the electric parking brake.

- ▶ Press button **1** (USA) or **2** (Canada) once.

**i** When you switch off the vehicle, you can still operate the side windows and the panoramic sliding sunroof for five minutes.

### Garage door opener

#### Programming buttons for the garage door opener

**⚠ WARNING** Risk of exhaust gas poisoning

Combustion engines emit poisonous exhaust gases such as carbon monoxide. Inhaling these exhaust gases causes poisoning.

- ▶ Never leave the engine running in an enclosed space without sufficient ventilation.

**⚠ WARNING** Risk of injury and entrapment when opening the garage door using the garage door opener

When you operate or program the garage door with the integrated garage door opener,



persons in the range of movement of the garage door can become trapped or struck by the garage door.

- ▶ When using the integrated garage door opener, always make sure that nobody is within the sweep of the garage door.

Only operate the garage door opener on the following garage doors:

- Garage doors with a safety stop and reversing feature.
- Garage doors which conform to the current U.S. safety standards.

When programming a garage door opener, park the vehicle outside the garage.

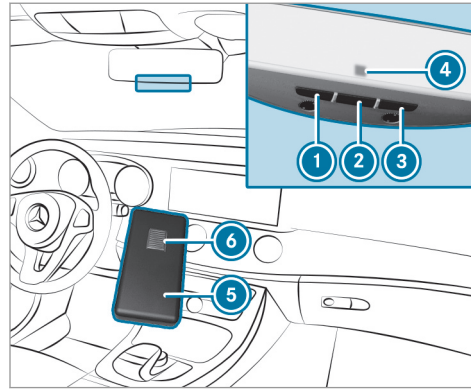

- ▶ Check if the transmitter frequency of the remote control has the frequency range of 280 to 868 MHz.

Radio equipment approval number:

- NZLMUAHL5 (USA)
- 4112A-MUAHL5 (Canada)

- ▶ Press and hold button ①, ② or ③ that you wish to program. Indicator lamp ④ flashes yellow.

ⓘ It can take up to 20 seconds before the indicator lamp flashes yellow.

- ▶ Release the previously pressed button. Indicator lamp ④ continues to flash yellow.

- ▶ Point remote control ⑤ at a distance of 1 in (1 cm) to 3 in (8 cm) towards buttons ①, ② or ③.

- ▶ Press and hold button ⑥ of remote control ⑤.

- Indicator lamp ④ lights up green: programming is completed.
- Indicator lamp ④ flashes green: programming has been successful. Additionally, synchronization of the rolling code must also take place.
- Indicator lamp ④ goes out, without lighting up green or flashing: repeat the procedure.

- ▶ Release button ⑥ on remote control ⑤.

- ❗ The remote control for the garage door drive is not included in the scope of delivery of the garage door opener.

### Synchronizing the rolling code

#### Requirements

- The garage door system uses a rolling code.
- The vehicle must be within range of the garage door or exterior gate drive.
- The vehicle as well as persons and objects, are located outside the sweep of the garage door.

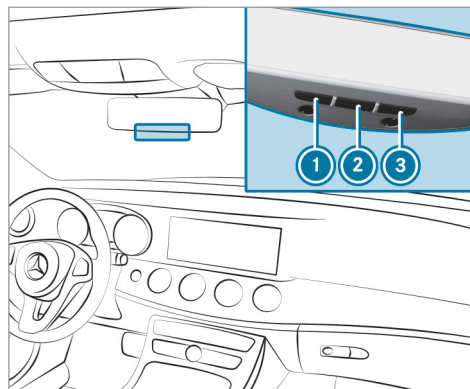

- ▶ Press the programming button on the door drive unit. Initiate the next step within approximately 30 seconds.
- ▶ Press programmed button ①, ② or ③ repeatedly, until the door closes.

- ❗ Please also read the operating instructions for the garage door drive.

### Resolving problems when programming the remote control

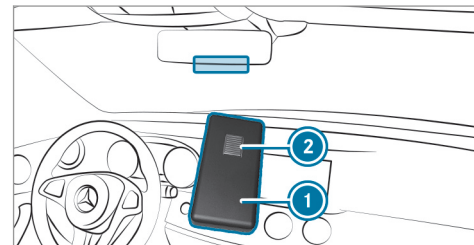

- ▶ Check if the transmitter frequency of remote control ① is supported.
- ▶ Replace the batteries in remote control ①.
- ▶ Hold remote control ① at various angles at a distance between 1 in (1 cm) to 3 in (8 cm) in front of the inside rearview mirror. You should test every position for at least 25 seconds before trying another position.
- ▶ Hold remote control ① at the same angles at various distances in front of the inside rearview mirror. You should test every posi-

tion for at least 25 seconds before trying another position.

- ▶ Note that some remote controls transmit only for a limited period, press button ② on remote control ① again before transmission ends.
- ▶ Align the antenna line of the garage door opener unit with the remote control.
- ① Support and additional information on programming:
  - On the toll free HomeLink® Hotline on 1-800-355-3515.
  - On the Internet at <http://www.homelink.com>.

### Opening/closing the garage door

#### Prerequisite

The corresponding button is programmed to operate the garage door.

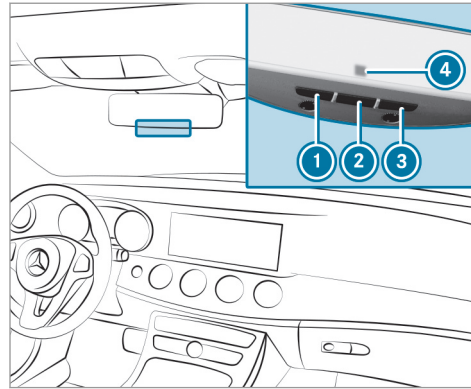

- ▶ Press and hold buttons ①, ② or ③ until the garage door opens or closes.
- ▶ When indicator lamp ④ flashes yellow: press the previously pressed button again until the garage door opens or closes.

### Clearing the garage door opener memory

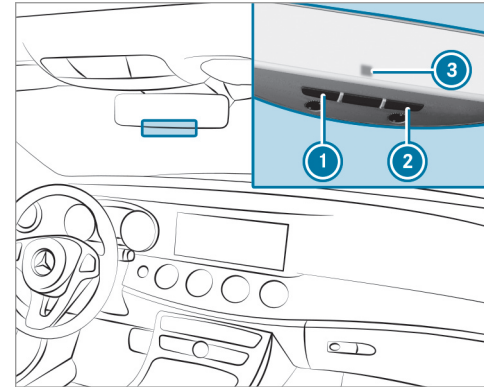

- ▶ Press and hold buttons ① and ②. Indicator lamp ③ lights up yellow.
- ▶ If indicator lamp ③ flashes green: release buttons ① and ②.

### Radio equipment approval numbers for the garage door opener

- Egypt: TAC.2511151293.WIR

- **Andorra:** CE (!) 1588
- **Australia:** R-NZ
- **Barbados:** MED1578
- **Chile:** 742488/DFRS20576/F-
- **European Union:** CE (!) 1588
- **Gibraltar:** CE (!) 1588
- **Iceland:** CE (!) 1588
- **Jordan:** TRC/LPD/2015/299
- **Canada:** 4112A-MUAHL5
- **Kuwait:** CE (!) 1588
- **Liechtenstein:** CE (!) 1588
- **Mexico:** RCPGEMU15-0448
- **Monaco:** CE (!) 1588
- **New Zealand:** R-NZ
- **Norway:** CE (!) 1588
- **Russian Federation:** not required
- **Saudi Arabia:** TA 10525
- **Switzerland:** CE (!) 1588
- **South Africa:** TA-2015/1386

- **Turkey:** not required
- **United Arab Emirates:** ER41849/15
- **United States:** NZLMUAHL5

### Electric parking brake

#### Automatically applying the electric parking brake.

**⚠ WARNING** Risk of accident and injury due to children left unattended in the vehicle

If you leave children unaccompanied in the vehicle, they may be able to set the vehicle in motion, for example by:

- Releasing the parking brake.
- Shifting the transmission out of park position **P**.
- Starting the engine.

In addition, they may operate vehicle equipment.

- ▶ Never leave children and animals unattended in the vehicle.
- ▶ When leaving the vehicle, always take the SmartKey with you and lock the vehicle.

The electric parking brake is applied if the transmission is in position **P** and one of the following conditions is fulfilled:

- The engine is switched off.
- The seat belt tongue is not inserted in the seat belt buckle and the driver's door is opened.

**i** To prevent application: pull the handle of the electric parking brake.

The electric parking brake is also applied if one of the following conditions is fulfilled:

- The Distance Pilot DISTRONIC brings the vehicle to a standstill.
- The HOLD function is keeping the vehicle stationary.
- Parking Pilot is keeping the vehicle stationary.

In addition, one of the following conditions must be fulfilled:

- The engine is switched off.
- The seat belt tongue is not inserted in the seat belt buckle and the driver's door is opened.
- There is a system malfunction.
- The power supply is insufficient.
- The vehicle is stationary for a lengthy period.

When the electric parking brake is applied, the **PARK** (USA) or **(P)** (Canada) indicator lamp lights up in the instrument cluster.

The electric parking brake is not automatically applied if the engine is switched off by the ECO start/stop function.

### Releasing the electric parking brake automatically

The electric parking brake is released when all of the following conditions are fulfilled:

- The engine is running.
- The seat belt tongue is inserted into the seat belt buckle.

- The transmission is in position **D** or **R** and you depress the accelerator pedal or you shift from transmission position **P** to **D** or **R**.
- If the transmission is in position **R**, the trunk lid must be closed.

If the seat belt tongue is not inserted into the seat belt buckle, the following conditions must be fulfilled:



- The driver's door is closed.
- You move the transmission out of transmission position **P** or you have previously driven faster than 2 mph (3 km/h).
- If the transmission is in position **R**, the trunk lid must be closed.

If the electric parking brake is released, the **PARK** (USA) or **(P)** (CANADA) indicator lamp in the instrument cluster goes out.

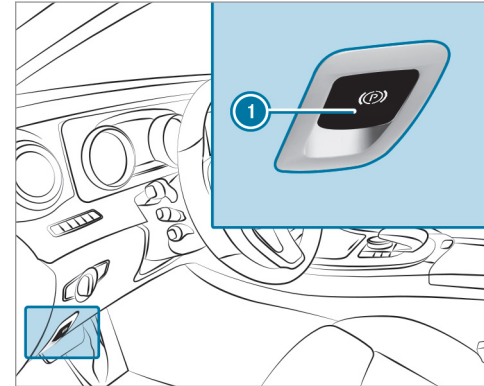

### Applying or releasing the electric parking brake manually



- ▶ **To apply:** push handle ①. The **PARK** (USA) or **(P)** (Canada) indicator lamp appears in the instrument cluster.
- ▶ **To release:** switch on the ignition.

- ▶ Pull handle .
- The  (USA) or  (Canada) indicator lamp in the instrument cluster goes out.

### Emergency braking

- ▶ Press and hold handle .
- When the vehicle has been braked to a standstill:
  - The electric parking brake is applied.
  - The  (USA) or  (Canada) symbol appears in the instrument cluster.

### Parking the vehicle

- If you leave the vehicle parked for longer than four weeks, damage may occur to the battery.
- If you leave the vehicle parked for longer than six weeks, it may suffer damage as a result of lack of use.
- Information on parking your vehicle can be obtained at a qualified specialist workshop.

### Standby mode

#### Function of the standby mode

Standby mode is characterized by the following:

- The vehicle can be parked over a long period of time without losing power.
- The vehicle battery is preserved.
- The maximum period out of use is shown in the multimedia system display.
- Functions such as interior protection or tow-away protection are not available.
- The connection to online services is interrupted.

If the following conditions are fulfilled, standby mode can be activated or deactivated using the multimedia system:

- The engine is switched off.
- The ignition is switched on.

Exceeding the vehicle's displayed period out of use may cause inconvenience, i.e. it cannot be guaranteed that the starter battery will reliably start the engine.

The starter battery must be charged in the following situations:

- The vehicle's period out of use must be extended.
- A message appears in the multimedia system display explaining that the battery charge is insufficient for standby mode.

 Standby mode is automatically deactivated when the ignition is switched on.

#### Activating or deactivating standby mode

Multimedia system:

 **Vehicle** ▶  **Vehicle Settings** ▶ **Standby Mode**

- ▶ Activate  or deactivate  the function. When you activate the function, a prompt appears.
- ▶ Select **Yes**.
- ▶ Standby mode is activated.

## Driving and driving safety systems

### Driving systems and your responsibility

Your vehicle is equipped with driving systems which assist you in driving, parking and maneuvering the vehicle. The driving systems are aids and do not relieve you of your responsibility. Pay attention to the traffic conditions at all times and intervene when necessary. Be aware of the limitations regarding the safe use of these systems.

### Function of the radar sensors

Some driving and driving safety systems use radar sensors to monitor the area in front of, behind or next to the vehicle (depending on the vehicle's equipment).

Depending on the vehicle's equipment, the radar sensors are integrated behind the bumpers and/or behind the radiator grille. Keep these parts free of dirt, ice and slush. The sensors must not be covered, for example by bicycle racks, overhanging loads or radar-reflecting stickers. Following an impact and in the event of

associated damage, which may not be visible, to the bumpers or radiator grille, have the function of the radar sensors checked at a qualified specialist workshop. The driver assistance system may no longer work properly.

### Overview of driving and driving safety systems

In this section, you will find information about the following driving systems and driving safety systems:

- 360° Camera (→ page 178)
- ABS (**A**nti-**l**ock **B**raking **S**ystem) (→ page 149)
- Distance Pilot DISTRONIC (→ page 160)
- AIR BODY CONTROL (→ page 170)
- Active Brake Assist (→ page 153)
- Active Lane Keeping Assist (→ page 191)
- ATTENTION ASSIST (→ page 185)
- BAS (**B**rake **A**ssist **S**ystem) (→ page 150)
- EBD (**E**lectronic **B**rake force **D**istribution) (→ page 153)

- ESP® (**E**lectronic **S**tability **P**rogram) (→ page 150)
- DRIVE PILOT (→ page 166)
- HOLD function (→ page 168)
- Steering Pilot (→ page 166)
- Parking Pilot (→ page 180)
- Parking Assist PARKTRONIC (→ page 173)
- Rear view camera (→ page 175)
- Cruise control (→ page 158)
- Blind Spot Assist and Active Blind Spot Assist (→ page 189)
- Traffic Sign Assist (→ page 187)

### Functions of ABS (anti-lock braking system)

ABS regulates the brake pressure in critical driving situations:

- During braking, the wheels are prevented from blocking, e.g. due to maximum full-stop braking or insufficient traction of the tires.
- Vehicle steerability while braking is ensured.

- ABS is active from speeds of approx. 5 mph (8 km/h).

If ABS intervenes when braking, you will feel a pulsing in the brake pedal. The pulsating brake pedal can be an indication of hazardous road conditions and can serve as a reminder to take extra care while driving.

#### System borders

ABS may be impaired or may not function if a malfunction has occurred and the yellow  ABS warning lamp lights up continuously in the instrument cluster after the engine is started.

#### Function of BAS (Brake Assist System)

**▲ WARNING** Risk of an accident caused by a malfunction in BAS (Brake Assist System)

If BAS is malfunctioning, the braking distance may increase in an emergency braking situation.

▶ Depress the brake pedal with full force in emergency braking situations. ABS prevents the wheels from locking.

BAS supports your emergency braking situation with additional brake force.

If you depress the brake pedal quickly, BAS is activated:

- BAS automatically boosts the brake pressure.
- BAS can shorten the braking distance.
- ABS prevents the wheels from locking.

The brakes will function as usual once you release the brake pedal. BAS is deactivated.

#### Functions of ESP® (Electronic Stability Program)

**▲ WARNING** Risk of skidding if ESP is malfunctioning®

If ESP® is malfunctioning, ESP® cannot carry out vehicle stabilization. In addition, other driving safety systems are switched off.

- ▶ Drive on carefully.
- ▶ Have ESP® checked at a qualified specialist workshop.

**▲ WARNING** Risk of skidding if ESP® is deactivated

If you deactivate ESP®, ESP® cannot carry out vehicle stabilization.

- ▶ ESP® should only be deactivated in the following situations.

ESP® monitors and improves driving stability and traction, particularly in the following situations:

- When pulling away on wet or slippery roads.



- When braking.
- In strong sidewinds when you are driving faster than 50 mph (80 km/h).

ESP® can stabilize the vehicle by intervening in the following ways:

- One or more wheels are braked.
- The engine output is adapted according to the situation.

ESP® is deactivated if the ESP® OFF  warning lamp lights up continuously in the instrument cluster:

- Driving stability will no longer be improved.
- Crosswind Assist is no longer active.
- The drive wheels could spin.
- ETS/4ETS traction control is still active.

**i** Even when ESP® is deactivated, you are still assisted by ESP® when braking.

ESP® is intervening if the ESP®  warning lamp flashes in the instrument cluster:

- Do not deactivate ESP®.

- Only depress the accelerator pedal as far as is necessary.
- Adapt your driving style to suit the current road and weather conditions.

Deactivate ESP® in the following situations to improve traction:

- When using snow chains
- In deep snow
- On sand or gravel

**i** Spinning the wheels results in a cutting action which provides better grip.

ESP® is deactivated if the  ESP® OFF warning lamp lights up continuously in the instrument cluster.

If the ESP®  warning lamp lights up continuously, ESP® is not available due to a malfunction.

Observe any information which may be displayed in the instrument cluster:

- Warning and indicator lamps (→ page 417)
- Display messages (→ page 374)

### ETS/4ETS (Electronic Traction System)

ETS/4ETS traction control is part of ESP®.

ETS/4ETS can improve the vehicle's traction by intervening in the following ways:

- The drive wheels are braked individually if they spin.
- More drive torque is transferred to the wheel or wheels with traction.

### Influence of drive programs on ESP®

The drive programs enable ESP® to adapt to different weather and road conditions as well as the driver's preferred driving style. You can select the drive programs using the DYNAMIC SELECT switch.

**ESP® characteristics per drive program**

Drive program	ESP® mode	Characteristics
<b>C</b> (Comfort) <b>E</b> (Economy)	ESP® Comfort	These drive programs provide the ideal balance between traction and stability. Select drive program <b>E</b> or <b>C</b> in difficult road conditions, such as in snow or ice, or when the road is wet from rain.
<b>S</b> (Sport)	ESP® Sport	This drive program provides the ideal balance between traction and stability.
<b>S+</b> (Sport Plus)	ESP® Sport Plus	The vehicle's own understeering and oversteering characteristics are accentuated. This allows a more active driving style to be adopted. This drive program requires more active involvement on the part of the driver. Only select this drive program in good road conditions, for example on dry, clear stretches of road.

### Activating/deactivating ESP® (Electronic Stability Program)

Multimedia system:

→ Vehicle →  Assistance → ESP

▶ Activate  or deactivate  the function.

ESP® is deactivated if the ESP® OFF  warning lamp lights up continuously in the instrument cluster.

Observe the information on warning lamps and display messages which may be shown in the instrument cluster.

### Functions of ESP® Crosswind Assist

ESP® Crosswind Assist detects sudden gusts of side wind and helps the driver to keep the vehicle in the lane:

- ESP® Crosswind Assist is active at vehicle speeds between 50 mph (80 km/h) and 125 mph (200 km/h) when driving straight ahead or cornering slightly.

- The vehicle is stabilized by means of individual brake application on one side.

### Function of EBD (Electronic Brake force Distribution)

EBD is characterized by the following:

- Monitoring and regulating the brake pressure on the rear wheels.
- Improved driving stability when braking, especially on bends.

### Function of Active Brake Assist

Active Brake Assist consists of:

- Distance warning function
- Autonomous braking function
- Situation-dependent braking assistance
- **Vehicles with the Driving Assistance package:** Evasive Steering Assist

Active Brake Assist can help you to minimize the risk of a collision with vehicles or pedestrians or to reduce the effects of such a collision.

If Active Brake Assist has detected a risk of collision, you will be warned visually and acoustically.

If you do not react to the visual and audible collision warning, autonomous braking can be initiated in critical situations.

In especially critical situations, Active Brake Assist can initiate autonomous braking directly. In this case, the visual and acoustic warning occurs simultaneously with the braking application.

If you apply the brake yourself in a critical situation or apply the brake during autonomous braking, situation-dependent braking assistance occurs. This increases the brake pressure up to maximum full-stop braking if necessary.

If the autonomous braking function or the situation-dependent braking assistance is triggered, additional preventive measures for occupant protection (PRE-SAFE®) may also be initiated, if the vehicle is equipped with these.

**▲ WARNING** Risk of an accident caused by limited detection performance of Active Brake Assist

Active Brake Assist cannot always clearly identify objects and complex traffic situations.

In such cases, Active Brake Assist might:

- give an unnecessary warning or brake the vehicle
- not give a warning or not brake the vehicle.

- ▶ Always pay careful attention to the traffic situation; do not rely on Active Brake Assist alone.
- ▶ Be ready to brake and take evasive action if necessary.

Also observe the system limits of Active Brake Assist.

**The individual subfunctions are available in the following speed ranges:  
Distance warning function**

The distance warning function issues a warning at speeds:

- From approximately 4 mph (7 km/h), if your vehicle is critically close to a vehicle or pedestrian. An intermittent warning tone sounds and the distance warning lamp lights up in the instrument cluster .

Brake immediately or take evasive action, provided it is safe to do so.

**The distance warning function can aid you in the following situations with an intermittent warning tone and a warning lamp:**

	Vehicles traveling in front	Stationary vehicles	Crossing vehicles	Crossing pedestrians	Stationary pedestrians
Vehicles without Driving Assistance package	up to approx. 155 mph (250 km/h)	up to approx. 50 mph (80 km/h)	no reaction	up to approx. 37 mph (60 km/h)	no reaction
Vehicles with Driving Assistance package	up to approx. 155 mph (250 km/h)	up to approx. 62 mph (100 km/h)	up to approx. 43 mph (70 km/h)	up to approx. 43 mph (70 km/h)	up to approx. 43 mph (70 km/h)

**Autonomous braking function**

The autonomous braking function may intervene at speeds starting from approximately 4 mph (7 km/h) in the following situations:

	Vehicles traveling in front	Stationary vehicles	Crossing vehicles	Crossing pedestrians	Stationary pedestrians
Vehicles without Driving Assistance package	up to approx. 124 mph (200 km/h)	up to approx. 31 mph (50 km/h)	no reaction	up to approx. 37 mph (60 km/h)	no reaction
Vehicles with Driving Assistance package	up to approx. 155 mph (250 km/h)	up to approx. 62 mph (100 km/h)	up to approx. 43 mph (70 km/h)	up to approx. 43 mph (70 km/h)	up to approx. 43 mph (70 km/h)

**Situation-dependent braking assistance**

Situation-dependent braking assistance may intervene at speeds starting from approximately 4 mph (7 km/h) in the following situations:

	Vehicles traveling in front	Stationary vehicles	Crossing vehicles	Crossing pedestrians	Stationary pedestrians
Vehicles without Driving Assistance package	up to approx. 155 mph (250 km/h)	up to approx. 50 mph (80 km/h)	no reaction	up to approx. 37 mph (60 km/h)	no reaction
Vehicles with Driving Assistance package	up to approx. 155 mph (250 km/h)	up to approx. 62 mph (100 km/h)	up to approx. 43 mph (70 km/h)	up to approx. 43 mph (70 km/h)	up to approx. 43 mph (70 km/h)

### Canceling a brake application of Active Brake Assist

You can cancel a brake application of Active Brake Assist at any time by:

- Depressing the accelerator pedal fully.
- Releasing the brake pedal.

Active Brake Assist cancels the intervention when at least one of the following conditions is fulfilled:

- You maneuver to avoid an obstacle.
- There is no longer a risk of collision.
- An obstacle is no longer detected in front of your vehicle.

### Evasive Steering Assist

Evasive Steering Assist has the following characteristics:

- Can detect stationary or crossing pedestrians.
- Can assist the driver with additional steering assistance if it detects a swerving maneuver.

- Can be activated by an abrupt steering movement during a swerving maneuver.
- Can assist during swerving and straightening of the vehicle.
- Can react from a speed of approximately 12 mph (20 km/h) up to a speed of approximately 43 mph (70 km/h).
- You can prevent the assistance at any time by active steering.

#### **⚠ WARNING** Risk of an accident despite Evasive Steering Assist

Evasive Steering Assist cannot always clearly identify objects and complex traffic situations.

In addition, the steering support of Evasive Steering Assist is generally not sufficient to avoid a collision.

In such cases Evasive Steering Assist can:

- give an unnecessary warning or provide assistance
- not give a warning or not provide assistance

- ▶ Always pay careful attention to the traffic situation; do not rely on Evasive Steering Assist alone.
- ▶ Be ready to brake and take evasive action if necessary.
- ▶ Prevent the assistance by actively steering in non-critical driving situations.
- ▶ Drive at an appropriate speed if pedestrians are close to the path of your vehicle.

Also observe the system limits of Evasive Steering Assist.

### System limits

Active Brake Assist may be impaired or may not function in the following situations:

- In snow, rain, fog, heavy spray, if there is glare, in direct sunlight or in greatly varying ambient light.
- If the sensors are dirty, fogged up, damaged or covered.

- If the sensors malfunction due to other radar source interference, for example strong radar reflections in a parking garage.
- If a loss of tire pressure or a defective tire has been detected and displayed.

The system may not react correctly:

- In complex traffic stations where objects cannot always be clearly identified.
- To pedestrians or vehicles if they move quickly into the sensor detection range.
- To pedestrians who are hidden by other objects.
- If the typical outline of a pedestrian cannot be distinguished from the background.
- If a pedestrian is not recognized as such, e.g. due to special clothing or other objects.
- On bends with a tight radius.

### Setting Active Brake Assist

Multimedia system:

→ Vehicle →  Assistance → Active Brake Assist

#### Vehicles without Driving Assistance Package:

The settings can be made after starting the vehicle.

#### Vehicles with Driving Assistance Package:

The settings can be made when the ignition is switched on.

- ① It is recommended that you always leave Active Brake Assist switched on.

The moment of warning or intervention can be adjusted as follows:

- ▶ **Select Active Brake Assist Warning/Brake Application: Early:** your selection is retained when the vehicle is next started.
- ▶ **Select Active Brake Assist Warning/Brake Application: Medium:** your selection is retained when the vehicle is next started.

- ▶ **Select Active Brake Assist Warning/Brake Application: Late:** your selection is retained when the vehicle is next started.
- ▶ **Select Active Brake Assist Warning/Brake Application: Off:**  
**Vehicles without Driving Assistance Package:** The distance warning function and the autonomous braking function are deactivated. When the vehicle is next started, the middle setting is automatically selected.  
**Vehicles with Driving Assistance Package:** The distance warning function and the autonomous braking function are deactivated. Evasive Steering Assist is unavailable. When the ignition is next started, the middle setting is selected automatically and Evasive Steering Assist is available.
- ① When Active Brake Assist is deactivated, the  symbol appears in the assistance graphic in the multifunction display.

## Speed control cruise control

### Function of cruise control

Cruise control accelerates and brakes the vehicle automatically in order to maintain a previously stored speed.

If you accelerate to overtake, for example, the stored speed is not deleted. If you remove your foot from the accelerator pedal after overtaking, cruise control will resume speed regulation back to the stored speed.

You can operate cruise control with the cruise control lever.

If you fail to adapt your driving style, cruise control can neither reduce the risk of an accident nor override the laws of physics. It cannot take into account road, weather or traffic conditions. Cruise control is only an aid. You are responsible for the distance to the vehicle in front, for vehicle speed, for braking in good time and for staying in your lane.

### System limitations

Cruise control may be unable to maintain the stored speed on uphill gradients. The stored speed is resumed when the gradient evens out.

Do not use cruise control in the following situations:

- In traffic situations which require frequent changes of speed, e.g. in heavy traffic, on winding roads.
- On slippery roads. Accelerating can cause the drive wheels to lose traction and the vehicle could then skid.
- When visibility is poor.

### Operating cruise control

**▲ WARNING** Risk of accident due to unknown stored speed

If you call up the stored speed and this is lower than your current speed, the vehicle decelerates.

If you do not know the stored speed, the vehicle could decelerate unexpectedly.

- ▶ Take into account the traffic situation before calling up the stored speed.
- ▶ If the stored speed is not known, store the desired speed again.

Change into a lower gear in good time on long and steep downhill gradients. This is especially important if the vehicle is laden. By doing so, you will make use of the braking effect of the engine. This relieves the load on the brake system and prevents the brakes from overheating and wearing too quickly.

### Prerequisites

- Cruise control is selected.
- ESP® must be switched on, but not intervening.
- The driving speed must be at least 15 mph (20 km/h).



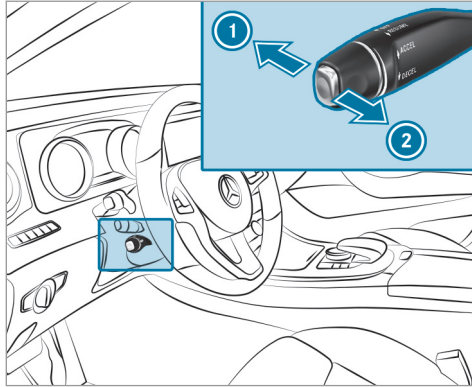

▶ To store current speed ② (once after starting the vehicle).

or

- ▶ To call up stored speed ②.
- ▶ To deactivate cruise control ①.

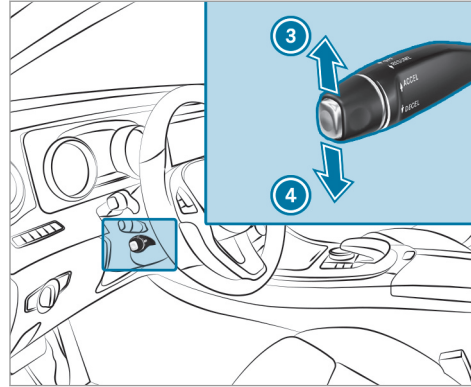

▶ Press the lever briefly: stored speed is increased ③ or reduced ④ by 1 mph (1 km/h).

or

▶ Press and hold the lever: stored speed is increased ③ or reduced ④ in 1 mph (1 km/h) increments.

or

▶ Press the lever beyond the pressure point: stored speed is increased ③ or reduced ④ by 10 mph (10 km/h).

or

▶ Press and hold lever beyond the pressure point: stored speed is increased ③ or reduced ④ in 10 mph (10 km/h) increments.

If cruise control has been deactivated, the current driven speed is adopted with ③ or ④.

- ⓘ If you brake, deactivate ESP or if ESP intervenes, cruise control is deactivated. When you switch off the vehicle, the last speed stored is cleared.

### Setting the speed limit for winter tires

Multimedia system:

▶ [Vehicle](#) ▶ [Vehicle Settings](#) ▶ [Winter Tires Limit](#)

▶ Select the speed or deactivate the function.

## Distance Pilot DISTRONIC

### Function of Distance Pilot DISTRONIC

Distance Pilot DISTRONIC:

- Maintains the set speed and accelerates or decelerates the vehicle if the distance from the vehicle in front permits.
- Assists you in maintaining the distance from the vehicle in front and can bring your vehicle to a standstill if necessary.
- Brakes your vehicle with up to 50 % of the maximum possible braking power. If greater deceleration performance is required, a visual and acoustic warning is given and you must then intervene yourself.
- **Vehicles with the Driving Assistance Package, Parking Pilot and COMAND:**  
When driving in stop-start traffic, the driver is supported by an extended, automatic restart in traffic jams.
- **Vehicles with the Driving Assistance Package:** Responds in urban speed ranges to stationary vehicles (except bicycles, motorcy-

cles and pedestrians) if conditions are sufficient to enable detection.

If you fail to adapt your driving style, Distance Pilot DISTRONIC can neither reduce the risk of an accident nor override the laws of physics. Distance Pilot DISTRONIC cannot take into account road, weather or traffic conditions. Distance Pilot DISTRONIC is only an aid. You are responsible for the distance to the vehicle in front, for vehicle speed, for braking in good time and for staying in your lane.

If all activation conditions are met, you can activate Distance Pilot DISTRONIC during a journey or while stationary. When Distance Pilot DISTRONIC is activated, a speed is stored which the driver can increase or reduce at any time. The speed can be adjusted between 15 mph (20 km/h) and 120 mph (200 km/h).

**Vehicles with the Driving Assistance Package:** The speed can be adjusted between 15 mph (20 km/h) and 130 mph (210 km/h).

**Vehicles with the Driving Assistance Package, Parking Pilot and COMAND:** If the vehicle is stopped on a highway or a high-speed major

road, the vehicle follows up to 30 seconds behind the vehicle ahead, without the driver needing to intervene. If an obstacle is detected in front of the vehicle during the driving-off procedure, a takeover warning is given. Acceleration is reduced, the driver is given a visual and acoustic warning and must stop the vehicle before reaching the obstacle or take evasive action.

**Vehicles with the Driving Assistance Package:** In conjunction with navigation systems, Distance Pilot DISTRONIC prevents prohibited overtaking on the right at speeds over 50 mph (80 km/h) in right-hand traffic or overtaking on the left in left-side traffic on highways or high-speed major roads.

If you activate the turn signal indicator to change lanes, the vehicle will accelerate more briskly to the set speed under the following conditions:

- Distance Pilot DISTRONIC is activated.
- If the driving speed is higher than 45 mph (70 km/h).
- If the driven speed drops below the stored speed.

- If the traffic situation in the overtaking lane permits a safe lane change.

### **Vehicles with Driving Assistance Package and Traffic Sign Assist:**

Distance Pilot DISTRONIC also has the Speed Limit Pilot function. This function can be configured in the multimedia system. If a change in the speed limit is detected and Distance Pilot DISTRONIC is activated, Distance Pilot DISTRONIC assumes this new speed.

The driven speed is adapted when the vehicle is level with the traffic signs. The speed limit display in the Instrument Display is always updated when the vehicle is level with the traffic sign.

If the Distance Pilot DISTRONIC has been put into passive mode by pressing the accelerator pedal, only speed limits which are higher than the set speed are adopted.

Pulling the cruise control lever will set the displayed speed limit as the speed, provided that:

- The Speed Limit Pilot has been activated in the multimedia system and
  - Distance Pilot DISTRONIC has been activated.
- If no speed limit is displayed when the lever is operated, the speed set by the driver is adopted.

### **Drive program**

The DYNAMIC SELECT switch allows you to change the driving style of Distance Pilot DISTRONIC. Depending on which drive program is selected, the driving characteristics can be geared towards fuel economy, comfort or dynamic performance (→ page 135).

### **System limits**

**Vehicles with the Driving Assistance Package:** Distance Pilot DISTRONIC is active in the 0 mph (0 km/h) to 130 mph (210 km/h) speed range.

The system may be impaired or may not function in the following situations:

- In snow, rain, fog, heavy spray, if there is glare, in direct sunlight or in greatly varying light conditions.
- If the windshield in the area of the camera is dirty, fogged up, damaged or covered.

- If the radar sensors are dirty or covered.

Do not use Distance Pilot DISTRONIC in the following situations:

- In road and traffic conditions which do not allow you to maintain a constant speed, e.g. in heavy traffic or on winding roads.
- On slippery roads. Braking or accelerating can cause the drive wheels to lose traction and the vehicle could then skid.
- When there is poor visibility, e.g. due to fog, heavy rain or snow.
- In parking garages or at toll stations.
- On roads with steep uphill or downhill gradients.

### **Tips**

Pay particular attention in the following traffic situations. In such situations, brake if necessary. Distance Pilot DISTRONIC is then deactivated:

- When cornering, entering and exiting a bend.
- When not driving in the center of the lane.
- When other vehicles are changing lane.

- If there are narrow vehicles.
- If there are obstacles and stationary vehicles.
- If there are crossing vehicles, pedestrians, motorcyclists or cyclists.

### Display of Distance Pilot DISTRONIC in the Assistance Graphic and in the speedometer

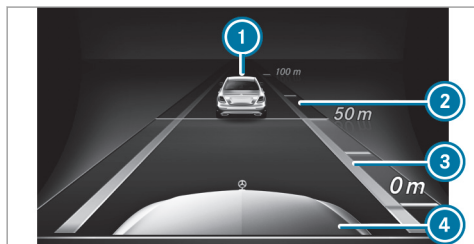

- ① Vehicle ahead
- ② Distance indicator
- ③ Set specified distance
- ④ Own vehicle

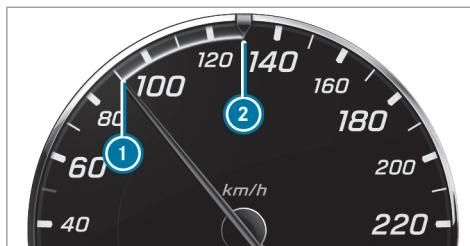

- ① Speed of vehicle ahead
- ② Stored speed

### Displays in the multifunction display

When activating Distance Pilot DISTRONIC or when changing the stored speed, the new stored speed is shown for around five seconds in the multifunction display 50 mph (70 km/h).

When Distance Pilot DISTRONIC is active, the set stored speed is displayed next to the symbol. When distance control is active, the symbol is shown in green.

### Vehicles with the Driving Assistance Package:

On highways or high-speed major roads the

symbol is displayed cyclically when the vehicle is ready to pull away.

**Vehicles with Speed Limit Pilot:** If a speed limit is automatically adopted, this is shown as the stored speed with the symbol.

### Operating Distance Pilot DISTRONIC

**⚠ WARNING** Risk of accident if detection function of Distance Pilot DISTRONIC is impaired

The Distance Pilot DISTRONIC does not react:

- To people or animals.
- To stationary obstacles on the road, e.g. stopped or parked vehicles (vehicles without the Driving Assistance Package).
- To stationary obstacles on the road, e.g. stopped or parked vehicles, if conditions are not sufficient to enable detection (vehicles with the Driving Assistance Package).
- To oncoming vehicles and crossing traffic.

As a result, Distance Pilot DISTRONIC may neither give warnings nor intervene in such situations.

- ▶ Always carefully observe the traffic conditions and be ready to brake at all times.

**⚠ WARNING** Risk of accident due to limited detectability of road users and traffic situations

Distance Pilot DISTRONIC cannot always clearly identify other road users and complex traffic situations.

In these conditions, Distance Pilot DISTRONIC may:

- Give an unnecessary warning and then brake the vehicle.
  - Neither give a warning nor intervene.
  - Accelerate or brake unexpectedly.
- ▶ Continue driving with care and be ready to brake, particularly if Distance Pilot DISTRONIC warns you.

**⚠ WARNING** Risk of accident due to insufficient deceleration by Distance Pilot DISTRONIC

Distance Pilot DISTRONIC brakes your vehicle with up to 50 % of the maximum possible braking power. If this deceleration is not sufficient, Distance Pilot DISTRONIC alerts you with a visual and acoustic warning.

- ▶ Apply the brakes yourself in these situations and try to take evasive action.

**⚠ WARNING** Risk of accident due to Distance Pilot DISTRONIC still being activated when you leave the vehicle

If you leave the driver's seat while the vehicle is being braked by Distance Pilot DISTRONIC only, it can roll away in the following situations:

- If there is a malfunction in the system or in the power supply.

- If Distance Pilot DISTRONIC is deactivated with the cruise control lever, e.g. by a vehicle occupant or from outside the vehicle.
- If the electrics in the engine compartment, the battery or the fuses are tampered with.
- If the battery is disconnected.
- If the vehicle is accelerated, e.g. by a vehicle occupant.

- ▶ Always deactivate Distance Pilot DISTRONIC and secure the vehicle to prevent it from rolling away before you leave the driver's seat.

**⚠ WARNING** Risk of accident due to unknown stored speed

If you call up the stored speed and this is lower than your current speed, the vehicle decelerates.

If you do not know the stored speed, the vehicle could decelerate unexpectedly.

- ▶ Take into account the traffic situation before calling up the stored speed.
- ▶ If the stored speed is not known, store the desired speed again.

**⚠ WARNING** Risk of accident due to unexpected acceleration by Distance Pilot DISTRONIC

If Distance Pilot DISTRONIC no longer detects a vehicle in front, it may unexpectedly accelerate to the speed stored.

- This speed may be too high for a filter lane or a slip road.
- If driving in the right lane, this speed may be so high that you pass vehicles driving on the left (in countries where traffic drives on the right).
- If driving in the left lane, this speed may be so high that you pass vehicles driving on the right (in countries where traffic drives on the left).

Always carefully observe the traffic conditions and be ready to brake at all times.

**⚠ WARNING** Risk of accident due to Distance Pilot DISTRONIC pulling away automatically

If Distance Pilot DISTRONIC performs an automatic driving-off procedure, the vehicle may accelerate unexpectedly.

Where necessary, brake the vehicle yourself and take evasive action.

**Requirements**

- The vehicle's engine or must be switched on.
- The electric parking brake must be released.
- Parking Pilot is not being used to park the vehicle or to exit from a parking space.
- ESP® must be switched on, but not intervening.
- The transmission must be in position **D**.
- The driver's door, front passenger door and the rear doors must be closed.

- The engine hood must be closed.

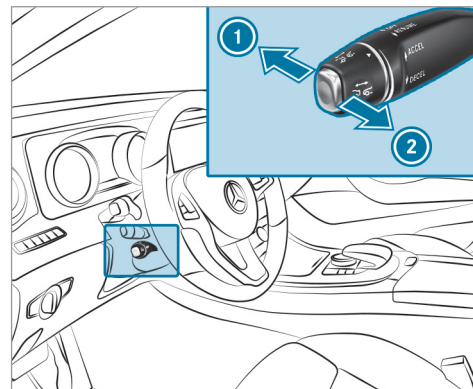

- ▶ Remove your foot from the accelerator pedal.
  - ▶ To store current speed ②. Your vehicle adapts its speed to that of the vehicle in front, but only up to the stored speed.
- or
- ▶ To call up stored speed ②.

- ▶ Or **On vehicles with Driving Assistance Package and Traffic Sign Assist:** The displayed speed limit is adopted, if available ②.
- ▶ To deactivate Distance Pilot DISTRONIC ①.

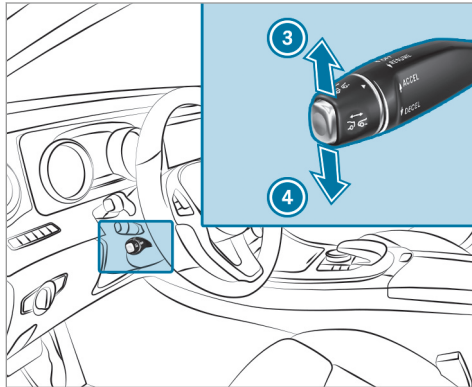

- ▶ To increase ③ or reduce ④ the speed.

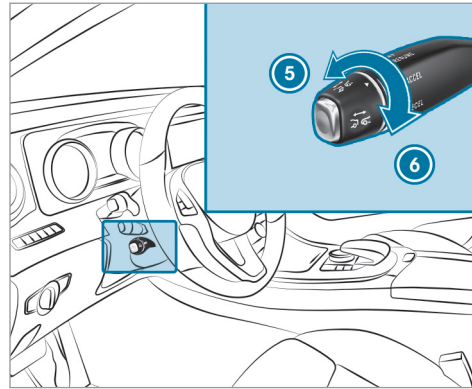

- ▶ To reduce ⑤ or increase ⑥ the specified distance from the vehicle in front.

**Pulling away with Distance Pilot DISTRONIC Requirement:** a speed must have been previously stored.

- ▶ Remove your foot from the brake pedal.
- ▶ Briefly pull the cruise control lever towards you ②.

or

- ▶ Accelerate briefly. Your vehicle pulls away and adapts its speed to that of the vehicle in front. If no vehicle is detected in front, your vehicle accelerates to the set speed.

#### Adopting the speed limit as the stored speed Requirements:

- Speed Limit Pilot is activated in the multimedia system (→ page 188).
  - Distance Pilot DISTRONIC is activated.
  - The system detects a traffic sign indicating a speed limit.
- ▶ Briefly pull the cruise control lever towards you ③. The displayed speed limit is adopted as the stored speed. Your vehicle adapts its speed to that of the vehicle in front, but only up to the stored speed. If Speed Limit Pilot is activated, any detected changes in the speed limit are adopted by the system.

### Collision warning

If Distance Pilot DISTRONIC is unable to sufficiently decelerate the vehicle in order to prevent it from approaching the vehicle in front, you will be warned visually and acoustically. An intermittent warning tone will then sound and the distance warning lamp will light up in the instrument cluster.

- ▶ Brake immediately in order to increase the distance from the vehicle in front.
- or
- ▶ Take evasive action provided it is safe to do so.

### Function of DRIVE PILOT

**The DRIVE PILOT function is available only on vehicles with the Driving Assistance Package.**

DRIVE PILOT includes the following driving and driving safety systems:

- Steering Pilot (→ page 166)
- Distance Pilot DISTRONIC (→ page 160)
- Speed Limit Pilot (→ page 160)

### Steering Pilot

**Function of Steering Pilot**  
**Steering Pilot is only available for vehicles with the Driving Assistance Package.**

- Steering Pilot is operational at speeds up to 130 mph (210 km/h) and helps you to stay in the center of the lane by means of moderate steering interventions.
- It uses as a reference the vehicle in front or the lane markings, depending on the driven speed.
- Steering Pilot requires you as the driver, to keep your hands on the steering wheel at all times so that you are able to intervene at any time to correct the course of the vehicle and keep it in lane.
- Steering Pilot can be overridden at any time by steering the vehicle yourself.
- If the system detects that there are no lane markings, it uses the vehicle ahead as a reference up to a speed of 80 mph (130 km/h).

- When the system is actively steering, the  symbol is shown in green in the multi-function display.

### Steering Pilot system limits

Steering Pilot has a limited steering torque for lateral guidance. In some cases, the steering intervention is not sufficient to keep the vehicle in the lane.

If detection of lane markings and vehicles ahead is impaired, Steering Pilot switches to passive mode. The  symbol in the multifunction display is shown in gray. The system provides no support in this case.

The system may be impaired or may not function in the following situations:

- If there is poor visibility, e.g. due to insufficient illumination of the road, or due to snow, rain, fog or spray.
- If there is glare, e.g. from oncoming traffic, direct sunlight or reflection from other vehicles (e.g. if the road surface is wet).
- If the windshield in the vicinity of the camera is dirty, fogged up, damaged or covered, for instance by a sticker.



- If no, or several, unclear lane markings are present for one lane, e.g. in a construction area.
- If the lane markings are worn away, dark or covered up, e.g. by dirt or snow.
- If the distance to the vehicle in front is too small and the lane markings thus cannot be detected.
- If the lane markings change quickly, e.g. lanes branch off, cross one another or merge.
- If the road is narrow and winding.
- If there are highly variable shade conditions on the road.
- Obstacles such as traffic warning signs located on the lane or projecting out into the lane are not detected.

The system does not provide assistance in the following conditions:

- On very sharp bends.
- When towing a trailer.

- If you actively change lane without switching on the turn signal indicator.
- If you switch on the turn signal indicator and the conditions for activating Active Lane Change Assist are not fulfilled.

#### Information on the Steering Pilot

Steering Pilot is only an aid. You are responsible for the distance to the vehicle in front, for vehicle speed, for braking in good time and for staying in your lane. Before changing lanes, make sure that the neighboring lane is free (shoulder view).

#### Active Lane Change Assist

- ① The availability of the following function is country-dependent.

Steering Pilot remains active even if the turn signal indicator is switched on. Steering Pilot then assists the driver when changing lanes by applying steering torques to initiate the lane change.

Assistance when changing lanes is provided if all the following conditions are met:

- You are driving in the direction of travel on a highway or high-speed, multi-lane major road with multiple lanes.
- The neighboring lane is free and separated by a broken lane marking.
- The driven speed is between 45 mph (75 km/h) and 110 mph (180 km/h).
- The turn signal indicator is switched on for longer than two seconds.

#### Steering and contact detection

Steering Pilot requires you as the driver, to keep your hands on the steering wheel at all times so that you are able to intervene at any time to correct the course of the vehicle and keep it in lane. The driver must expect a change from active to passive mode or vice versa at any time.



If you are not steering yourself or if you take your hands off the steering wheel for a prolonged period of time, the system will, depending on the situation, first alert you with a visual warning. ❶ appears in the multifunction display. If you are still not steering the vehicle yourself or if you have not taken hold of the steering wheel, a warning tone sounds in addition to the warning message to remind you to take control of the vehicle.

The warning message does not appear or disappears if one of the following conditions are met:

- The driver steers the vehicle.

- The driver presses a steering wheel button or operates Touch Control.

#### Active Emergency Stop Assist

If the driver continues to ignore the acoustic warning, Distance Pilot DISTRONIC reduces the speed. If the driver still does not respond, the vehicle is decelerated in stages to a standstill.

The driver can cancel the deceleration at any time by performing one of the following actions:

- Steering
- Braking or accelerating
- Pressing a steering wheel button or operating Touch Control
- Activating or deactivating Steering Pilot or Distance Pilot DISTRONIC

The driver must be ready to take control of the vehicle at any time.

#### Activating Steering Pilot

##### Requirements

- ESP® must be switched on, but not intervening.

- Distance Pilot DISTRONIC must be activated.

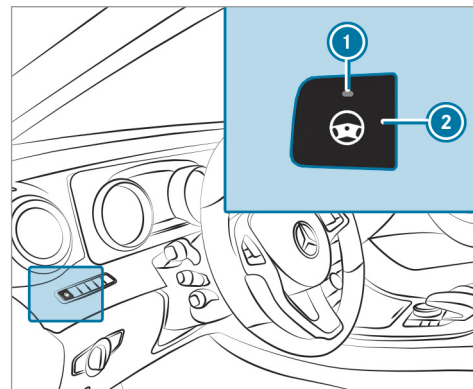

▶ If indicator lamp ❶ is off: press button ❷.

#### HOLD function

##### HOLD function

The HOLD function holds the vehicle at a standstill without requiring you to depress the brake

pedal, such as when pulling away on steep slopes.

### System borders

The incline must not be greater than 30%.

### Activating/deactivating the HOLD function

**⚠ WARNING** Risk of an accident due to the HOLD function being active when you leave the vehicle

If you leave the vehicle while only the HOLD function is braking the vehicle, the vehicle can roll away in the following situations:

- If there is a malfunction in the system or in the power supply.
- If the HOLD function is deactivated by depressing the accelerator pedal or the brake pedal, e.g. by a vehicle occupant.
- If the electrics in the engine compartment, the battery or the fuses are tampered with.
- If the battery is disconnected.

- ▶ Always deactivate the HOLD function and secure the vehicle against rolling away before leaving the vehicle.

### **!** NOTE Damage from automatic braking

If Active Brake Assist, Distance Pilot DISTRONIC or the HOLD function is activated, the vehicle brakes automatically in certain situations.

To avoid damage to the vehicle, deactivate these systems in the following or similar situations:

- ▶ During towing
- ▶ In a car wash

### Requirements

- The vehicle is stationary.
- The engine is running or has been automatically switched off by the ECO start/stop function.
- The electric parking brake is released.
- Distance Pilot DISTRONIC is not activated.

### • Vehicles with automatic transmission:

The transmission is in position **D**, **R** or **N**.

### Activating the HOLD function

- ▶ Depress the brake pedal and after a short time depress further until the **HOLD** display appears in the multifunction display.
- ▶ Release the brake pedal.

### Deactivating the HOLD function

- ▶ Depress the accelerator pedal to pull away.
- or
- ▶ Depress the brake pedal until the **HOLD** display disappears from the multifunction display.

In the following situations, the vehicle is held by the transmission position **P** or by the electric parking brake:

- When the seat belt is unfastened and the driver's door is opened.
- When the engine is switched off.
- When there is a malfunction in the system or if the power supply is insufficient.

## AIR BODY CONTROL

### AIR BODY CONTROL function

AIR BODY CONTROL is an air suspension system with variable damping for improved driving comfort. The all-round level control system ensures the best possible suspension and constant ground clearance, even with a laden vehicle.

When driving at speed, the vehicle is lowered automatically to improve driving safety and to reduce fuel consumption. The option of manually adjusting the vehicle level is also available.

AIR BODY CONTROL comprises:

- Air suspension with variable spring rate
- Automatic level control system
- Speed-dependent lowering to reduce fuel consumption
- Manual level adjustment
- ADS PLUS (Adaptive Damping System with constant damping force adjustment)
- DYNAMIC SELECT switch and level button

### Available suspension settings

Drive program	Characteristics
C (Comfort)	<ul style="list-style-type: none"><li>• Comfortable suspension tuning.</li><li>• Normal level.</li><li>• When driving at speeds above 77 mph (125 km/h) the vehicle is lowered by 0.6 in (15 mm).</li><li>• When driving at speeds below 50 mph (80 km/h), the vehicle is raised again.</li></ul>
E (Economy)	<ul style="list-style-type: none"><li>• Comfortable suspension tuning.</li><li>• The vehicle is lowered by 0.6 in (15 mm) compared to the normal level.</li></ul>

Drive program	Characteristics
S (Sport)	<ul style="list-style-type: none"> <li>• Firmer suspension tuning.</li> <li>• The vehicle is lowered by 0.6 in (15 mm) compared to the normal level.</li> <li>• The vehicle is not lowered any further if you are traveling at higher speeds.</li> </ul>
S+ (Sport Plus)	<ul style="list-style-type: none"> <li>• Even firmer suspension tuning.</li> <li>• The vehicle is lowered by 0.6 in (15 mm) compared to the normal level.</li> <li>• The vehicle is not lowered any further if you are traveling at higher speeds.</li> </ul>

### Setting the vehicle level

#### **⚠ WARNING** Risk of accident because vehicle level is too high

If you drive at a higher vehicle level, the driving characteristics may be impaired due to the higher vehicle center of gravity.

The vehicle may tip over more quickly on a bend, for example.

- ▶ Always select as low a vehicle level as possible and adapt your driving style accordingly.

#### **⚠ WARNING** Risk of entrapment from vehicle lowering

When lowering the vehicle, people could become trapped if their limbs are between the vehicle body and the tires or underneath the vehicle.

- ▶ Make sure no one is underneath the vehicle or in the immediate vicinity of the wheel arches when you lower the vehicle.

#### **⚠ WARNING** Risk of entrapment from vehicle lowering

**Vehicles with AIR BODY CONTROL or level control system:** When you unload luggage or leave the vehicle, the vehicle first rises slightly and then returns to the set level shortly afterwards.

You or anyone else in the vicinity of the wheel arches or the underbody could thus become trapped.

The vehicle can also be lowered after being locked.

- ▶ When leaving the vehicle, make sure that nobody is in the vicinity of the wheel arches or the underbody.

### Requirements

- The vehicle's engine or must be switched on.
- The vehicle must not be moving faster than 37 mph (60 km/h).

### Raising the vehicle

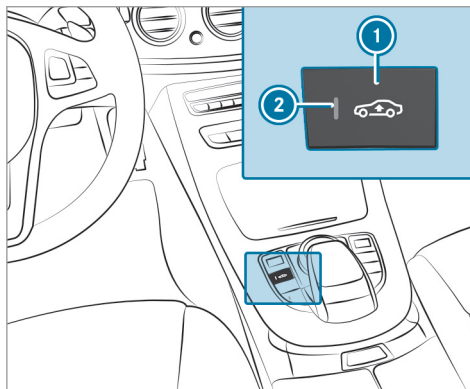

- ▶ Press button ①. Indicator lamp ② lights up. The vehicle is raised by 0.9 in (25 mm) compared with the normal level.

Your selection is saved.

The vehicle is lowered again in the following situations:

- When driving faster than 62 mph (100 km/h).
- When driving between 50 mph (80 km/h) and 62 mph (100 km/h) for approximately three minutes.
- After selecting a drive program using the DYNAMIC SELECT switch.

The vehicle is adjusted to the height of the last active drive program.

### Lowering the vehicle

- ▶ Press button ①. Indicator lamp ② goes out. The vehicle is adjusted to the height of the last active drive program.

## Parking Assist PARKTRONIC

### Functions of Parking Assist PARKTRONIC

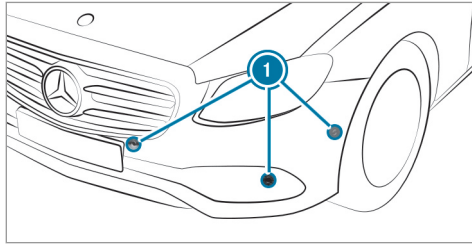

Parking Assist PARKTRONIC is an electronic parking assistance system with ultrasound. It monitors the area around your vehicle using six sensors ① in the front bumper and six sensors in the rear bumper. Parking Assist PARKTRONIC indicates visually and audibly the distance between your vehicle and an object.

Parking Assist PARKTRONIC is only an aid. It is not a substitute for your attention to the immediate surroundings. The responsibility for safe maneuvering and parking remains with you. Make sure that there are no persons, animals or

objects in the maneuvering area while maneuvering and parking in or leaving parking spaces. In the standard setting, an intermittent warning tone sounds beginning at a distance of 1.0 ft (0.3 m) to an obstacle. A continuous tone sounds beginning at a distance of 0.7 ft (0.2 m). You can set the warning tone in the multimedia system so that it will sound earlier at greater distances (3.3 ft (1.0 m)) (→ page 175).

If Parking Assist PARKTRONIC is deactivated, Parking Pilot is unavailable.

### Parking Assist PARKTRONIC display in the multimedia system

If Parking Pilot is deactivated and an obstacle is detected in the path of the vehicle, a pop-up window for Parking Assist PARKTRONIC ① appears in the multimedia system at speeds up to 6 mph (10 km/h).

### Vehicles with Parking Pilot and reversing camera:

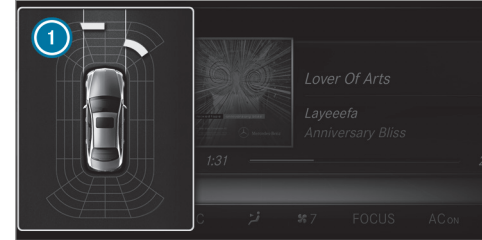

### Vehicles with Parking Pilot and 360° Camera:



### System limits

Parking Assist PARKTRONIC does not take into account the following obstacles:

- Obstacles below the detection range, e.g. persons, animals or objects.
- Obstacles above the detection range, e.g. overhanging loads, overhangs or loading ramps of trucks.

The sensors must be free of dirt, ice and slush. Otherwise, they may not function correctly. Clean the sensors regularly, taking care not to scratch or damage them.

**Vehicles with trailer hitch:** Parking Assist PARKTRONIC is deactivated for the rear zone when you establish an electrical connection between your vehicle and a trailer.

### Deactivating/activating PARKTRONIC

**1** **NOTE** Risk of an accident from objects at close range

Parking Assist PARKTRONIC may not detect certain objects at close range.

▶ When parking the vehicle, pay particular attention to any objects which are above or below the sensors, e.g. flowerpots or drawbars. The vehicle or other objects could otherwise be damaged.

Make sure that there are no persons, animals or objects in the maneuvering area while maneuvering and parking in/leaving parking spaces.

If indicator lamp **1** is not lit, Parking Assist PARKTRONIC is active. If the indicator lamp is lit and the  symbol appears in the multifunction display, Parking Assist PARKTRONIC is not active.

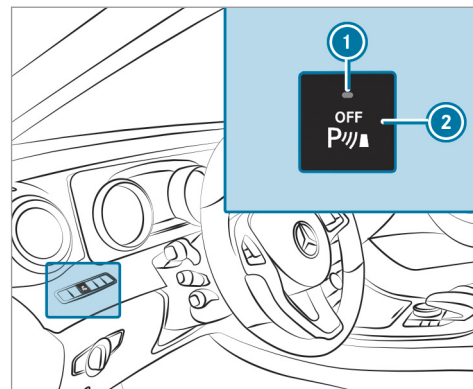

▶ Press button **2**.

- i** Depending on the vehicle's equipment, the button may also be located in the center console.
- i** Parking Assist PARKTRONIC is automatically activated when the vehicle is started.



### Adjusting the warning tones of Parking Assist PARKTRONIC

Multimedia system:

→ Vehicle → Assistance → Cam. & Parking Pilot → Set Warning Tones

### Adjusting the volume of the warning tones

- ▶ Select **Warning Tone Volume**.
- ▶ Adjust the value.

### Specifying the starting point for the warning tones

You can specify whether the Parking Assist PARKTRONIC warning tones should commence when the vehicle is further away from an obstacle.

- ▶ Select **Warn Early**.
- ▶ Activate  or deactivate  the function.

### Activating/deactivating audio fadeout

You can specify whether the volume of a media source in the multimedia system is to be reduced when Parking Assist PARKTRONIC gives an audible warning.

- ▶ Select **Audio Fadeout During Warning Tones**.

- ▶ Activate  or deactivate  the function.

### Reversing camera

#### Function of the rear view camera

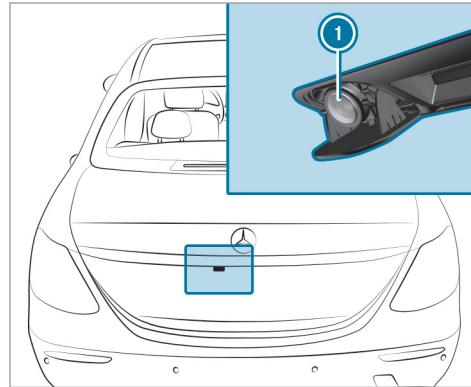

When you engage reverse gear, the image from rear view camera ① is shown in the multimedia system. Dynamic guide lines show the path the vehicle will take with the steering wheel in its

current position. This helps you to orientate yourself and to avoid obstacles when backing up.

The rear view camera is only an aid. It is not a substitute for your attention to the immediate surroundings. You are always responsible for safe maneuvering and parking. Make sure that there are no persons, animals or objects in the maneuvering area while maneuvering and parking in parking spaces.

You can select from the following views:

- Normal view
- Wide-angle view
- Trailer view

The area behind the vehicle is displayed as a mirror image, as in the inside rearview mirror.

### System limits

The rear view camera will not function or will only partially function in the following situations:

- If the trunk lid or tailgate is open.
- If there is heavy rain, snow or fog.
- If ambient light is poor, e.g. at night.

- If the camera lens is obstructed, dirty or fogged up. Observe the notes on cleaning the rear view camera (→ page 309).
- If the back of your vehicle is damaged. In this case, have the camera position and setting checked at a qualified specialist workshop.

The field of vision and other functions of the rear view camera may be restricted due to additional accessories on the rear of the vehicle (e.g. license plate bracket or bicycle rack).

#### Vehicles without Parking Pilot

The following camera views are available in the multimedia system:

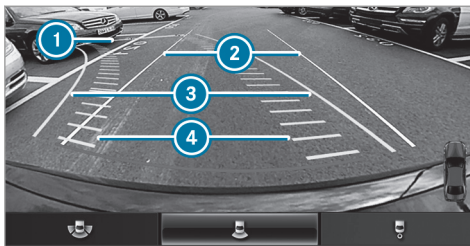

Normal view

- ① Yellow guide line at a distance of approximately 13 ft (4.0 m) to the rear area
- ② White guide line without turning the steering wheel, vehicle width including the exterior mirrors (static)
- ③ Yellow guide line for the vehicle width including the outside mirrors, for current steering wheel angle (dynamic)
- ④ Yellow lane marking the course the tires will take at the current steering wheel angle (dynamic)

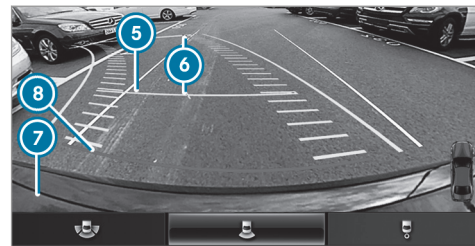

- ⑤ Yellow guide line at a distance of approximately 3.3 ft (1.0 m) from the rear area
- ⑥ Vehicle center axle (marker assistance)
- ⑦ Bumper
- ⑧ Red guide line at a distance of approximately 12 in (0.3 m) from the rear area



Wide-angle view

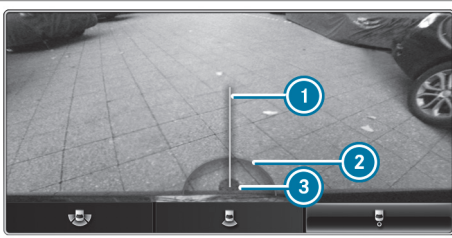

Trailer view

- ① Yellow guide line, locating aid

- ② Red guide line at a distance of approximately 12 in (0.3 m) to the ball head of the trailer hitch
- ③ Ball head of the trailer hitch

### Vehicles with Parking Pilot

The following camera views are available in the multimedia system:

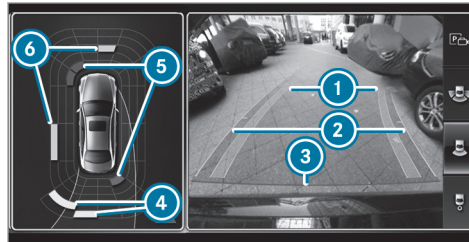

Normal view

- ① Yellow lane marking the course the tires will take at the current steering wheel angle (dynamic)
- ② Yellow guide line, vehicle width including outside mirrors (dynamic)

- ③ Red guide line at a distance of approximately 12 in (0.3 m) from the rear area
  - ④ Parking Assist PARKTRONIC yellow warning display: obstacles are a sufficient distance away (3.3 ft (1.0 m) or less)
  - ⑤ Parking Assist PARKTRONIC red warning display: obstacles are very close (1.0 ft (0.3 m) or less)
  - ⑥ Parking Assist PARKTRONIC orange warning display: obstacles are a medium distance away (between 1.0 ft (0.3 m) and 2.0 ft (0.6 m))
- i When Parking Pilot is activated, the lanes are displayed in green.  
If Parking Assist PARKTRONIC is deactivated, the warning display fades out.



Wide-angle view

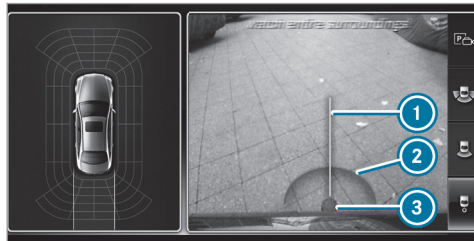

Trailer view

- ① Yellow guide line, locating aid

- ② Red guide line at a distance of approximately 12 in (0.3 m) to the ball head of the trailer hitch
- ③ Ball head of the trailer hitch

### 360° camera

#### Function of the 360° Camera

The 360° Camera is a camera system that consists of four cameras. The cameras cover the immediate vehicle surroundings. The system assists you, e.g. when parking or at exits with reduced visibility.

The 360° Camera is only an aid. It is not a substitute for your attention to the immediate surroundings. You are always responsible for safe maneuvering and parking. Make sure that there are no persons, animals or objects in the maneuvering area while maneuvering or parking in parking spaces.

The system evaluates images from the following cameras:

- Rear view camera
- Front camera

- Two side cameras in the outside mirrors

#### Views of the 360° Camera

You can select from different views:



- ① Wide-angle view, front
- ② Top view with image from the front camera
- ③ Top view with images from the side cameras in the outside mirrors
- ④ Wide-angle view, rear
- ⑤ Top view with image from the rear view camera
- ⑥ Top view with trailer view

**Top view**

- ① Lane indicating the route the vehicle will take with the steering wheel in its current position
- ② Parking Assist PARKTRONIC yellow warning display: obstacles are a sufficient distance away (3.3 ft (1.0 m) or less)
- ③ Your vehicle from above

If the distance to the object lessens, the color of the warning display changes ②. From a distance of 1.0 ft (0.3 m) the warning display is shown in red.

- ① If Parking Assist PARKTRONIC is deactivated, the warning display fades out.

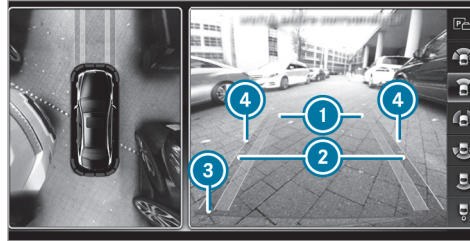
**Guide lines**

- ① Yellow lane marking the course the tires will take at the current steering wheel angle (dynamic)
  - ② Yellow guide line, vehicle width including outside mirrors (dynamic)
  - ③ Red guide line at a distance of approximately 12 in (0.3 m) to the rear area
  - ④ Mark at a distance of approx. 3.3 ft (1.0 m)
- ① When Parking Pilot is activated, the lanes are displayed in green.

The guide lines in the multimedia system display show the distances to your vehicle. The distances only apply to road level. In trailer mode, the guide lines are shown at the level of the trailer hitch.

**System limits**

The 360° Camera will not function or will only partially function in the following situations:

- If the doors are open.
- If the trunk lid or tailgate is open.
- If there is heavy rain, snow or fog.
- If the ambient light is poor, e.g. at night.
- If the camera lens is obstructed, dirty or fogged up.
- If the vehicle components in which the cameras are installed are damaged. In this event, have the camera position and setting checked at a qualified specialist workshop.

Do not use the 360° Camera under such circumstances. You could otherwise injure others or collide with objects when parking the vehicle.

On vehicles with height-adjustable suspension or if the vehicle is carrying a heavy load, leaving the standard height can result in inaccuracies in the guide lines and in the display of the generated images, depending on technical conditions.

The field of vision and other functions of the camera system may be restricted due to additional accessories (e.g. license plate bracket, bicycle rack).

See the notes on cleaning the 360° Camera (→ page 309).

### Selecting a view for the 360° Camera

The **Auto. Rear View Cam.** function is selected in the multimedia system.

- ▶ Engage reverse gear.
- ▶ In the multimedia system, select the desired view.

### Opening the camera cover of the rear view camera

Multimedia system:

➔ Vehicle ▶  Assistance ▶ Parking Pilot

- ▶ Select **Open Camera Cover**.

 The camera cover closes automatically after some time or after an ignition cycle.

### Assigning the camera as a favorite

You can call up the camera view directly in the multimedia system by assigning it as a favorite.

- ▶ Press the  button on the touchpad or controller.  
The main functions are displayed.
- ▶ On the touchpad, swipe down twice or slide the controller down twice.  
The Favorites menu appears.
- ▶ Select **New Favorite**.
- ▶ Select **Vehicle**.
- ▶ Select **Camera**.

## Parking Pilot

### Function of Parking Pilot

Parking Pilot is an electronic parking assistance system which uses ultrasound and is automatically activated during forward travel. The system is operational at speeds of up to approximately 22 mph (35 km/h). While in operation, the system independently locates and measures parallel and perpendicular parking spaces on both sides of the vehicle in the direction of travel. If Parking Pilot is activated, suitable parking spaces are displayed in the multimedia system. The  symbol appears in the multifunction display. The arrows show which side of the road free parking spaces are located.

The parking space and parking direction can be selected as desired. Parking Pilot calculates a suitable vehicle path and assists you in the parking and exiting procedure.

**Vehicles with automatic transmission:** Parking Pilot changes gear, accelerates, brakes and steers the vehicle.

Parking Pilot is only an aid. It is not a substitute for your attention to the immediate surround-

ings. The responsibility for safe maneuvering and parking remains with you. Make sure that no persons, animals or objects are in the maneuvering range.

Parking Pilot is canceled if one of the following actions is carried out:

- You switch off Parking Assist PARKTRONIC.
- You switch off Parking Pilot.
- You begin steering.
- You apply the parking brake.
- **Vehicles with automatic transmission:** You engage **P**.
- ESP® intervenes.

#### Parking Pilot system limits

Objects located above or below the detection range of Parking Pilot are not detected when the parking space is being measured. These are also not taken into account when the parking maneuver is calculated, e.g. overhanging loads, overhangs or loading ramps of trucks or the boundaries of the parking space. In some circumstances, Parking Pilot may therefore guide you into the parking space prematurely.

**⚠ WARNING** Risk of accident due to objects located above or below the detection range of Parking Pilot

If there are objects above or below the detection range, the following situations may arise:

- Parking Pilot may steer too early.
- **Vehicles with automatic transmission:** The vehicle may not stop in front of these objects.

This could cause a collision.

▶ In these situations, do not use Parking Pilot.

Snowfall or heavy rain may lead to a parking space being measured inaccurately. Parking spaces that are partially occupied by trailer drawbars might not be identified as such or be measured incorrectly. Only use Parking Pilot on level, high-grip ground.

Do not use Parking Pilot, for example, in the following situations:

- In extreme weather conditions such as ice or packed snow or in heavy rain.
- If you are transporting a load that protrudes beyond the vehicle.
- If the parking space is on a steep downhill or uphill gradient.
- If you have installed snow chains.

Parking Pilot may also display parking spaces that are not suitable for parking, e.g.:

- Parking spaces where parking is prohibited.
- Parking spaces on unsuitable surfaces.

Parking Pilot will not assist you with parking spaces at right angles to the direction of travel in the following situations:

- If two parking spaces are located immediately next to each other.
- If the parking space is directly next to a low obstacle such as a low curb.

Parking Pilot will not assist you with parking spaces parallel or at right angles to the direction of travel in the following situations:

- If the parking space is on a curb.
- If the parking space is bordered by an obstacle, e.g. a tree, a post or a trailer.

### Parking with Parking Pilot

- i** Depending on the vehicle's equipment, the button may also be located at a different position in the center console.

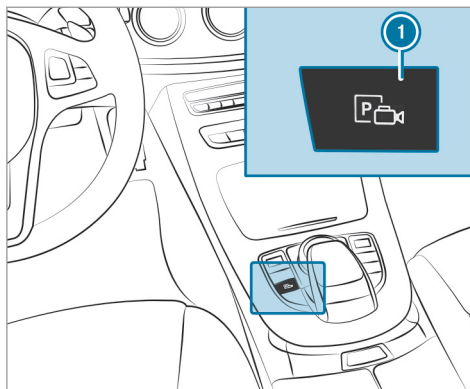

- ▶ Press button **1**. The Parking Pilot view appears on the display of the multimedia system. Area **2** displays detected parking spaces **4** and vehicle path **3**.

- i** Vehicle path **3** shown on the multimedia system display may differ from the actual vehicle path.



- ▶ If you have driven past a suitable parking space: bring the vehicle to a standstill.
- ▶ Select desired parking space **4**.
- ▶ Where necessary, select the parking direction: forwards or reverse. Vehicle path **3** is shown, depending on the selected parking space and parking direction.
- ▶ Confirm the selected parking space.



**⚠ WARNING** Risk of accident due to vehicle swinging out while parking or pulling out of a parking space

While parking or pulling out of a parking space, the vehicle swings out and can drive onto areas of the oncoming lane.

This could cause you to collide with objects or other road users.

- ▶ Pay attention to objects and other road users.
- ▶ Where necessary, stop the vehicle or cancel the parking procedure with Parking Pilot.

▶ If, for example, the message **Engage Reverse Gear** appears in the display of the multimedia system: select the corresponding transmission position.

**Vehicles with automatic transmission:**

The vehicle drives automatically into the selected parking space.

On completion of the parking procedure, the **Parking Pilot Finished, Take Control of the Vehi-**

**cle** display message appears. Further maneuvering may still be necessary.

▶ After completion of the parking maneuver, safeguard the vehicle against rolling away. Turn the wheels towards the curb if you are legally required to do so.

**i Vehicles with automatic transmission:**

You can stop the vehicle and change the transmission position during the parking procedure. The system then calculates a new vehicle path. The parking procedure can then be continued. If no new vehicle path is available, the transmission position will be changed again. If the vehicle has not yet reached the parking space, the parking procedure will be canceled should a gear be changed.

**Exiting a parking space with Parking Pilot**

**Requirement:**

You can only exit a parking space with Parking Pilot if you have previously parked the vehicle with Parking Pilot.

Please note that you are responsible for the vehicle during the entire parking procedure.

▶ Start the vehicle.

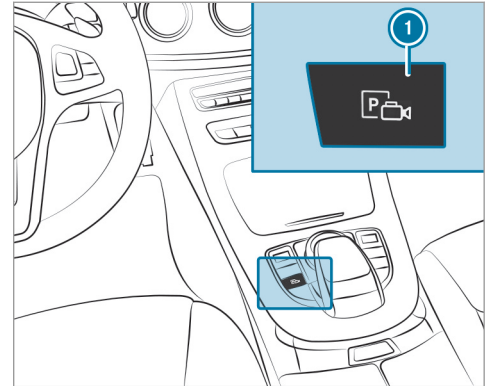

▶ Press button **1**. The Parking Pilot view appears on the display of the multimedia system.

▶ If the vehicle has been parked at right angles to the direction of travel: in area **2**, select direction of travel **3**.



**i** The vehicle path shown on the multimedia system display may differ from the actual vehicle path.

► Confirm to start the exiting process.

**⚠ WARNING** Risk of accident due to vehicle swinging out while parking or pulling out of a parking space

While parking or pulling out of a parking space, the vehicle swings out and can drive onto areas of the oncoming lane.

This could cause you to collide with objects or other road users.

► Pay attention to objects and other road users.

► Where necessary, stop the vehicle or cancel the parking procedure with Parking Pilot.

► If, for example, the message **Engage Forward Gear** appears in the display of the multimedia system: select the corresponding transmission position.

**Vehicles with automatic transmission:**

The vehicle automatically moves out of the parking space.

As soon as the **Parking Pilot Finished, Take Control of the Vehicle** message appears in the display of the multimedia system, you must accelerate, brake, steer and change gears yourself again.

**Drive Away Assist**

Drive Away Assist can prevent collisions when pulling away. If an obstacle is detected in the direction of travel, the vehicle's speed is briefly reduced to 1 mph (2 km/h). If a critical situation

is detected, a symbol appears on the camera image of the multimedia system.

A risk of a collision may arise in the following situations, for example:

- If the driver mixes up the accelerator and brake pedals.
- If the wrong gear is selected.

The Drive Away Assist function is active under the following conditions:

- If Parking Assist PARKTRONIC is activated.
- Every time the gear is changed to **R** or **D** when the vehicle is at a standstill.
- If the obstacle is less than 3.3 ft (1.0 m) away.
- If the maneuvering assistance function is activated in the multimedia system.

Drive Away Assist is unavailable on inclines and when driving with a trailer.

**Cross Traffic Alert**

**Vehicles with Blind Spot Assist:** Drivers can also be warned of any crossing traffic when backing up out of a parking space. If a critical

situation is detected, a warning symbol appears on the camera image of the multimedia system. If the driver does not respond to the warning, the vehicle's brakes can be applied automatically. To do this, the function uses the radar sensors in the bumper. The area adjacent to the vehicle is continually monitored.

If the radar sensors are obstructed by vehicles or other objects, detection is not possible.

The Cross Traffic Alert function is active under the following conditions:

- If Blind Spot Assist is activated.
- If the vehicle is backing up at walking pace.
- If the maneuvering assistance function is activated in the multimedia system.

### Activating/deactivating maneuvering assistance

Multimedia system:

Vehicle ▶ Assistance ▶ Parking Pilot ▶ Maneuvering Assist.

Switch the function on  or off .

## ATTENTION ASSIST

### Function of ATTENTION ASSIST

ATTENTION ASSIST assists you on long, monotonous journeys, e.g. on highways and trunk roads. If ATTENTION ASSIST detects indicators of fatigue or increasing lapses in concentration on the part of the driver, it suggests taking a break.

ATTENTION ASSIST is only an aid. It cannot always detect fatigue or lapses in concentration until too late. The system is not a substitute for a well-rested and attentive driver. On long journeys, take regular breaks in good time that allow for adequate recuperation.

You can choose between two settings.

- **Standard:** normal system sensitivity
- **Sensitive:** higher system sensitivity. The driver is warned earlier and the attention level detected by ATTENTION ASSIST is adapted accordingly.

If drowsiness or increasing lapses in concentration are detected, the **ATTENTION ASSIST: Take a Break!** warning appears in the Instrument Display. You can acknowledge the message and

take a break where necessary. If you do not take a break and ATTENTION ASSIST continues to detect increasing lapses in concentration, you will be warned again after a minimum of 15 minutes.



You can have the following status information for ATTENTION ASSIST displayed in the assistance menu of the on-board computer:

- The length of the journey since the last break.
- The attention level determined by ATTENTION ASSIST.

if ATTENTION ASSIST is unable to calculate the attention level and cannot issue a warning, the **System Suspended** message appears.

If a warning is given in the Instrument Display, the multimedia system offers to search for a rest area. You can select a rest area and start navigation to this rest area. This function can be activated and deactivated in the multimedia system.

If ATTENTION ASSIST is deactivated, the  symbol appears in the assistance graphic in the Instrument Display when the engine is running. ATTENTION ASSIST is activated automatically when the engine is re-started. The last selected sensitivity level remains stored.

### System limitations

ATTENTION ASSIST is active in the 37 mph (60 km/h) to 124 mph (200 km/h) speed range.

The functionality of ATTENTION ASSIST is restricted, and warnings may be delayed or not occur at all in the following situations:

- If you have been driving for less than 30 minutes.

- If the road condition is poor (uneven road surface or potholes).
- If there is a strong side wind.
- If you adopt a sporty driving style (high cornering speeds or high rates of acceleration).
- If the Steering Pilot function of DISTRONIC is active.
- If the time has been set incorrectly.
- In active driving situations, if you change lanes and vary your speed frequently.

The ATTENTION ASSIST tiredness or alertness assessment is deleted and restarted when continuing the journey in the following situations:

- If you switch off the engine.
- If you unfasten your seat belt and open the driver's door (e.g. change drivers or take a break).

### Activating/deactivating ATTENTION ASSIST

Multimedia system:

 Vehicle  Assistance  ATTENTION ASSIST

### Selection options

 Select **Standard**, **Sensitive** or **Off**.

## Traffic Sign Assist

### Function of Traffic Sign Assist

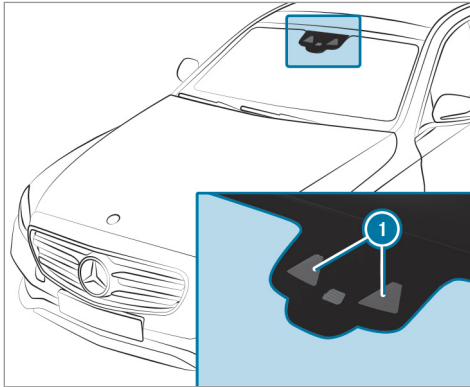

Traffic Sign Assist detects traffic signs with multifunction camera ① and assists you by displaying detected speed limits and overtaking restrictions in the instrument cluster. If the system detects that you are driving onto a section of road in the wrong direction, it triggers a warning.

The camera also detects traffic signs with a restriction indicated by an additional sign (e.g. in wet conditions).

### Warning when the maximum permissible speed is exceeded

The system can warn you if you unintentionally exceed the maximum permissible speed. To do this, you can specify in the multimedia system by how much the maximum permissible speed can be exceeded before a warning is issued. You can specify whether the warning is to be just a visual warning or an acoustic one as well.

### Display in the Instrument Display

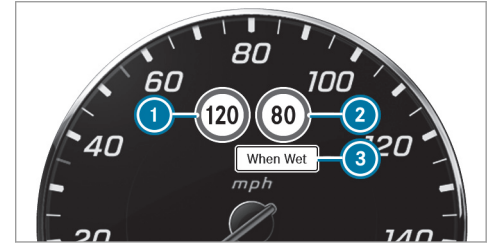

- ① Permissible speed
- ② Permissible speed when there is a restriction
- ③ Additional sign with restriction
- ④ The illustration shows the Instrument Display in the Widescreen Cockpit

Since Traffic Sign Assist also uses the data stored in the navigation system, it can update the display in the following situations without detecting traffic signs:

- When the vehicle changes roads, e.g. free-way exit or slip road

- When a village or city boundary is passed which is stored in the digital map



Traffic Sign Assist is not available in all countries. If it is unavailable, display ① is shown in the speedometer.

### System borders

The system may be impaired or may not function in the following situations:

- If there is poor visibility, e.g. due to insufficient illumination of the road, if there are highly variable shade conditions or in rain, snow, fog or spray

- If there is glare, e.g. from oncoming traffic, direct sunlight or reflections from other vehicles
- If the windshield in the area of the multifunction camera is dirty, or if the camera is fogged up, damaged or covered
- If the traffic signs are hard to detect, e.g. due to dirt or snow, or because they are covered or because of insufficient lighting
- If the information in the navigation system's digital map is incorrect or out-of-date
- If the signs are ambiguous, e.g. traffic signs on construction sites or in adjacent lanes

### Setting Traffic Sign Assist

Multimedia system:

➔ Vehicle ➔  Assistance ➔ Traffic Sign Assist

### Speed Limit Pilot for Distance Pilot DISTRONIC

Speed limitation is set automatically if DISTRONIC is activated.

- ▶ Select **Speed Limit Pilot**.

- ▶ Activate or deactivate the function.

### Displays in the instrument cluster

Detected traffic signs are displayed in the instrument cluster.

- ▶ Select **Instr. Cluster Display**.
- ▶ Activate or deactivate the function.

### Activating or deactivating the warning when a speed limit is exceeded

The point at which a warning is given once a speed is exceeded (warning threshold) can be set according to individual preferences.

- ▶ Select **Speed Limit Warning**.
- ▶ Select **Visual & Audible**, **Visual** or **None**.

### Setting a speed

- ▶ Select **Warning Threshold**.
- ▶ Set the desired speed.
- ① If the Speed Limit Pilot has been activated, the detected traffic signs are automatically displayed in the instrument cluster.

## Blind Spot Assist and Active Blind Spot Assist

### Function of Blind Spot Assist and Active Blind Spot Assist

Blind Spot Assist uses two lateral, rear-facing radar sensors to monitor the area up to 130 ft (40 m) behind your vehicle and 10 ft (3 m) directly next to your vehicle.

If a vehicle is detected at speeds above approximately 8 mph (12 km/h) and this vehicle subsequently enters the monitoring range directly next to your vehicle, the warning lamp in the outside mirror lights up red.

If a vehicle is detected close to your vehicle in the lateral monitoring range and you switch on the turn signal indicator in the corresponding direction, a warning tone sounds once. The red warning lamp in the outside mirror flashes. If the turn signal indicator remains on, all other detected vehicles are indicated only by the flashing of the red warning lamp.

If you overtake a vehicle quickly, no warning is given.

### **▲ WARNING** Risk of accident despite Blind Spot Assist

Blind Spot Assist does not react to vehicles approaching and overtaking you at a greatly different speed.

As a result, Blind Spot Assist cannot warn drivers in this situation.

- ▶ Always pay careful attention to the traffic situation and maintain a safe distance at the side of the vehicle.

Blind Spot Assist and Active Blind Spot Assist are only aids. They may fail to detect some vehicles and are no substitute for attentive driving. Always ensure that there is sufficient distance to the side for other road users and obstacles.

### System limitations

The detection capability of Blind Spot Assist can be restricted in the following situations:

- If the sensors are dirty or obscured.
- When there is poor visibility, e.g. due to fog, heavy rain, snow or spray.

- If narrow vehicles are within the monitoring range, e.g. bicycles.

Warnings may be issued in error when driving close to crash barriers or similar solid lane borders. Warnings may be interrupted when driving alongside long vehicles, for example, trucks, for a prolonged period.

Blind Spot Assist is not operational when reverse gear is engaged.

### Brake application of Active Blind Spot Assist

If Active Blind Spot Assist detects a risk of a side impact in the monitoring range, a course-correcting brake application is carried out. This is designed to help you avoid a collision.

The course-correcting brake application is available in the speed range between approximately 20 mph (30 km/h) and 125 mph (200 km/h).

### **▲ WARNING** Risk of accident despite brake application of Active Blind Spot Assist

A course-correcting brake application cannot always prevent a collision.

- ▶ Always steer, brake or accelerate yourself, especially if Active Blind Spot Assist warns you or makes a course-correcting brake application.
- ▶ Always maintain a safe distance at the sides.

**⚠ WARNING** Risk of accident despite Active Blind Spot Assist

Blind Spot Assist does not react to the following:

- Overtaking vehicles closely on the side, placing them in the blind spot area
- Vehicles approaching and overtaking you at a very different speed

As a result, Active Blind Spot Assist may neither give warnings nor intervene in such situations.

- ▶ Always pay careful attention to the traffic situation and maintain a safe distance at the side of the vehicle.



If a course-correcting brake application occurs, the red warning lamp flashes in the outside mirror and warning tone sounds. In addition, a display ① indicating the danger of a side collision appears in the multifunction display.

In rare cases, the system may make an inappropriate brake application. This brake application may be interrupted at any time if you steer slightly in the opposite direction or accelerate.

### System limitations

Either a course-correcting brake application appropriate to the driving situation, or none at all, may occur in the following situations:

- There are vehicles or obstacles, e.g. crash barriers, on both sides of your vehicle.
- A vehicle approaches too closely on the side.
- You have adopted a sporty driving style with high cornering speeds.
- You clearly brake or accelerate.
- A driving safety system intervenes, such as ESP® or Active Brake Assist.
- ESP® is deactivated.
- Tire pressure loss or a defective tire has been detected.
- When driving with a trailer, the electrical connection to the trailer hitch has been correctly established.



### Activating/deactivating Blind Spot Assist or Active Blind Spot Assist

Multimedia system:

Vehicle ► Assistance ► Blind Spot Assist

► Activate  or deactivate  the function.

### Active Lane Keeping Assist

#### Function of Active Lane Keeping Assist

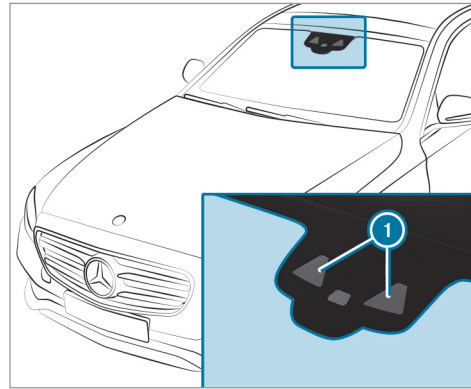

Active Lane Keeping Assist monitors the area in front of your vehicle by means of multifunction camera ①. It serves to protect you against unintentionally leaving your lane. You will be warned by means of a vibration in the steering wheel

and a course-correcting brake application guides you back into your lane.

You are warned by vibration pulses in the steering wheel in the following circumstances:

- Active Lane Keeping Assist detects lane markings.
- A front wheel passes over the lane markings.

You will also be guided back into your lane by means of a course-correcting brake application if the following conditions are met:

- Active Lane Keeping Assist detects lane markings on both sides.
- A front wheel drives over a solid lane marking.

Whether a warning is issued and when this occurs also depends on the selected sensitivity setting (standard or adaptive).

If you fail to adapt your driving style, Active Lane Keeping Assist can neither reduce the risk of an accident nor override the laws of physics. It cannot take into account road, weather or traffic conditions. Active Lane Keeping Assist is only an aid. You are responsible for the distance to the

vehicle in front, for vehicle speed, for braking in good time and for staying in lane.

**Vehicles with Lane Tracking Package:** If the lane markings are solid lines and you do not react to the warning, a lane-correcting brake application can bring the vehicle back into the original lane.

**Vehicles with Driving Assistance Package or Driving Assistance Plus Package:** If you do not react to the warning, a lane-correcting brake application can bring the vehicle back into the original lane. In the case of a broken lane marking being detected, a brake application will only be made if a vehicle has been detected in the adjacent lane. Oncoming vehicles, overtaking vehicles and vehicles in adjacent lanes can be detected.

The brake application is available in the speed range between 40 mph (60 km/h) and 120 mph (200 km/h).



If a lane-correcting brake application occurs, display ❶ appears in the multifunction display.

#### System borders

No lane-correcting brake application occurs in the following situations:

- You clearly and actively steer, brake or accelerate.
- You have switched on the turn signal indicator.
- A driving safety system intervenes, such as ESP®, Active Brake Assist or Active Blind Spot Assist.

- You have adopted a sporty driving style with high cornering speeds or high rates of acceleration.
- ESP® is deactivated.
- When driving with a trailer, the electrical connection to the trailer has been correctly established.
- If a loss of tire pressure or a defective tire has been detected and displayed.

The system may be impaired or may not function in the following situations:

- There is poor visibility, e.g. due to insufficient illumination of the road, highly variable shade conditions, or due to rain, snow, fog or heavy spray.
- There is glare, e.g. from the sun, reflections or oncoming traffic.
- There is dirt on the windshield in the vicinity of the multifunction camera or the camera is fogged up, damaged or obscured.
- No or several, unclear lane markings are present for one lane, e.g. in a construction area.

- The lane markings are worn, dark or covered.
- The distance to the vehicle in front is too small and the lane markings thus cannot be detected.
- The lane markings change quickly, e.g. lanes branch off, cross one another or merge.
- The road is very narrow and winding.

**Vehicles with Driving Assistance Package or Driving Assistance Plus Package:** Active Lane Keeping Assist uses radar sensors to monitor several areas around the vehicle. If the radar sensors in the rear bumper are dirty or covered with snow, the system may be impaired or may not function. If an obstacle in the lane in which you are driving has been detected, no lane-correcting brake application occurs.

#### Activating Active Lane Keeping Assist

**⚠ WARNING** Risk of accident despite warning from Active Lane Keeping Assist

A lane-correcting brake application cannot always bring the vehicle back into the original lane.

- ▶ Always steer, brake or accelerate yourself, especially if Active Lane Keeping Assist warns you or makes a lane-correcting brake application.

**⚠ WARNING** Risk of accident despite intervention of Active Lane Keeping Assist

Active Lane Keeping Assist does not detect traffic conditions or road users. In very rare cases, the system may make an inappropriate brake application, e.g. after intentionally driving over a solid lane marking.

The brake application can be interrupted at any time if you steer slightly in the opposite direction.

- ▶ Always make sure that there is sufficient distance to the side for other traffic or obstacles.

**⚠ WARNING** Risk of accident despite Lane Keeping Assist

Lane Keeping Assist cannot always clearly detect lane markings.

In such cases, Lane Keeping Assist can:

- give an unnecessary warning
- not give a warning

- ▶ Always pay particular attention to the traffic situation and keep within the lane, especially if Active Lane Keeping Assist alerts you.

#### Prerequisite

The driving speed is at least 40 mph (60 km/h).

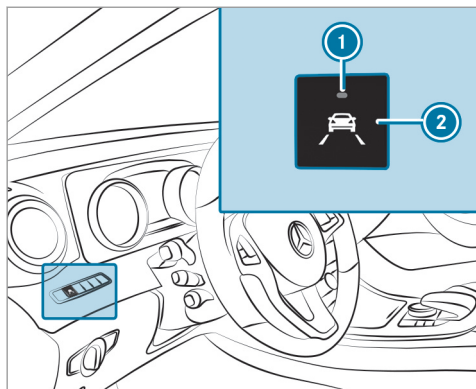

- ▶ Press button ②.  
If indicator lamp ① lights up, Lane Keeping Assist is activated. When lane markings are detected, the lines in the assistance graphic are shown in white.

### Sensitivity of Active Lane Keeping Assist

With the standard or adaptive setting, you can influence when the warning vibration of Lane Keeping Assist takes place.

In both the standard and adaptive settings, no warning vibration occurs in the following situations:

- You have switched on the turn signal indicator.
- A driving safety system intervenes, such as ABS, BAS or ESP®.

In the adaptive setting, there will also be no warning vibration in the following situations:

- The vehicle is accelerated or braked considerably.
- You steer actively, e.g. swerve to avoid an obstacle or change lane quickly.
- You cut the corner on a sharp bend.

### Setting the sensitivity of Active Lane Keeping Assist

Multimedia system:

↳ Vehicle ▶  Assistance ▶ Act.  
Lane Keep. Assist

### Selection options

- ▶ Select **Adaptive** or **Standard**.

## Instrument display overview

**⚠ WARNING** Risk of accident due to an instrument display malfunction

If the instrument display has failed or malfunctioned, you cannot recognize function restrictions applying to safety relevant systems.

The operating safety of your vehicle may be impaired.

- ▶ Drive on carefully.
- ▶ Have the vehicle checked immediately at a qualified specialist workshop.

If the operating safety of your vehicle is impaired, park the vehicle safely as soon as possible. Contact a qualified specialist workshop.

## Instrument display (standard)

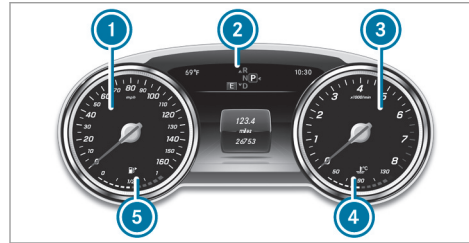

## Instrument display in the Widescreen Cockpit

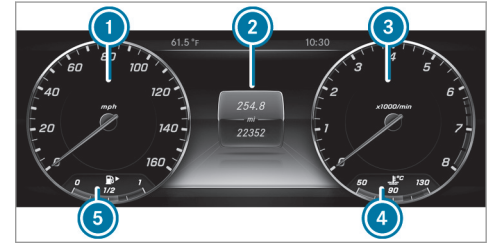

- ① Speedometer
- ② Multifunction display
- ③ Tachometer
- ④ Coolant temperature display
- ⑤ Fuel level and fuel filler flap location indicator

The segments in speedometer ① indicate the system status for the following:

- Cruise control (→ page 158)
- Distance Pilot DISTRONIC (→ page 160)

**Vehicles with Traffic Sign Assist and Wide-screen Cockpit:** Detected instructions and traffic signs appear in the speedometer (→ page 187).

**NOTE** Engine damage due to excessively high engine speeds

The engine will be damaged if you drive with the engine in the overrevving range.

- ▶ Do not drive with the engine in the overrevving range.

The fuel supply is interrupted to protect the engine when the red band in tachometer ③ (overrevving range) is reached.

During normal operating conditions, coolant temperature display ④ may rise to 248 °F (120 °C).

**WARNING** Danger of burns when opening the engine hood





If you open the engine hood when the engine has overheated or during a fire in the engine

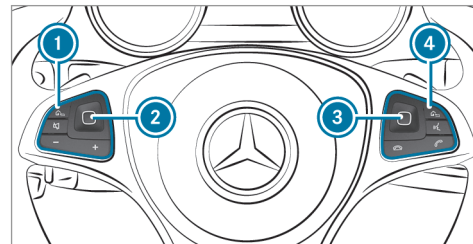

compartment, you could come into contact with hot gases or other escaping operating fluids.

- ▶ Before opening the engine hood, allow the engine to cool down.
- ▶ In the event of a fire in the engine compartment, keep the engine hood closed and call the fire service.

### Overview of the buttons on the steering wheel



- ① Button group:
  -  Main menu and back button (on-board computer)
  -  Switches sound off/on
  -  Increases the volume
  -  Decreases the volume
- ② Touch Control (on-board computer)
- ③ Touch Control (multimedia system)
- ④ Button group:
  -  Main menu and back button (multimedia system)

-  Voice Control System
-  Makes/accepts a call
-  Rejects/ends a call

### Operating the on-board computer

**⚠ WARNING** Risk of distraction from information systems and communications equipment

If you operate information and communications equipment integrated in the vehicle when driving, you will be distracted from the traffic situation. This could also cause you to lose control of the vehicle.

- ▶ Only operate this equipment when the traffic situation permits.
- ▶ If you cannot be sure of this, stop the vehicle whilst paying attention to road and traffic conditions and operate the equipment with the vehicle stationary.

You must observe the legal requirements for the country in which you are currently driving when operating the on-board computer.

- ⓘ The on-board computer displays appear in the multifunction display (→ page 198).

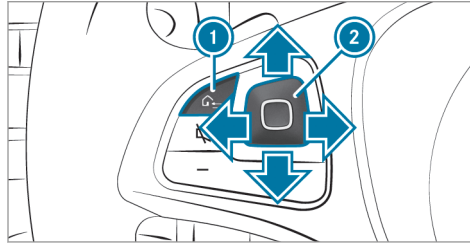

The on-board computer is operated using Touch Control **2** and back button **1** on the left-hand side of the steering wheel.

The following menus are available in the Instrument Display (standard):

- [Service](#)
- [DriveAssist](#)
- [Trip](#)

- [Navigation](#)
- [Radio](#)
- [Media](#)
- [Phone](#)
- [Head-up Disp.](#)

The following menus are available in the Instrument Display in the Widescreen Cockpit:

- [Service](#)
- [DriveAssist](#)
- [Trip](#)
- [Navigation](#)
- [Radio](#)
- [Media](#)
- [Phone](#)
- [Disp. Content](#)
- [Head-up Disp.](#)

The menus can be called up from the menu bar in the multifunction display.



- ▶ **To call up the menu bar:** Press the back button.
- ▶ **To scroll through the menu bar:** Swipe to the left or right-hand side of Touch Control.
- ▶ **To call up the menu or confirm the selection:** Press the left-hand side of Touch Control.
- ▶ **To scroll through displays or lists in the menu:** Swipe up or down on the left-hand side of Touch Control.
- ▶ **To call up the submenu or confirm the selection:** Press the left-hand side of Touch Control.

▶ **To exit the submenu:** Press the back button.

If you are browsing a submenu and you press and hold the back button, the menu bar appears.

### Displays in the multifunction display

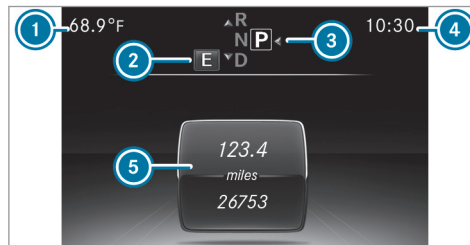

- ① Outside temperature
- ② Drive program
- ③ Transmission position (→ page 136)
- ④ Time
- ⑤ Display section

Further displays in the multifunction display:

- ↑ Gearshift recommendation (→ page 139)
- Parking Pilot activated
- Parking Assist PARKTRONIC deactivated
- Cruise control (→ page 158)
- Distance Pilot DISTRONIC (→ page 160) (→ page 166)
- Steering Pilot (→ page 166)
- ECO start/stop function
- HOLD function (→ page 168)
- Adaptive Highbeam Assist (→ page 113)



### Adjusting the instrument lighting

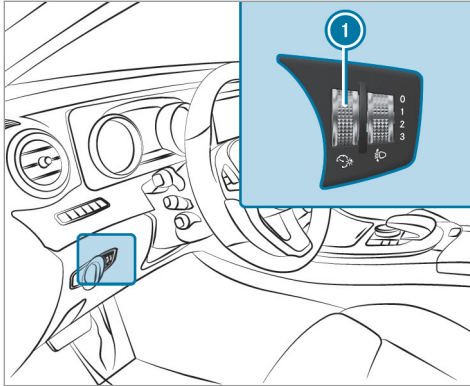

- ▶ Turn brightness control ① up or down. The lighting of the instrument display and in the controls in the vehicle interior is adjusted.

### Menus and submenus

#### Functions in the Service menu of the on-board computer

On-board computer:

##### → Service

- ① The spelling may differ in the main menu displayed. Therefore, observe the menu overview for the Instrument Display (→ page 197).

- ▶ **To select the function:** Swipe up or down on the left-hand side of Touch Control.
- ▶ Press the left-hand side of Touch Control.

Functions in the **Service** menu:

- Message memory (→ page 374)
- **Tire Pressure:**
  - Checking the tire pressure with the tire pressure monitoring system (→ page 338)
  - Restarting the tire pressure monitoring system (→ page 339)

- **ASSYST PLUS:** calling up the service due date (→ page 299)

#### Calling up the Assistance graphic display

On-board computer:

##### → DriveAssist

- ① The spelling may differ in the main menu displayed. Therefore, observe the menu overview for the Instrument Display (→ page 197).

**Vehicles with the Instrument Display in the Widescreen Cockpit:** When you have set the progressive display setting, you can view the assistance graphic in the **Disp. Content** menu.

The following displays are available from the Assistance graphic menu:

- Assistance graphic
- Attention level (→ page 185)

- ▶ **To switch between the displays:** Swipe up or down on the left-hand side of Touch Control.

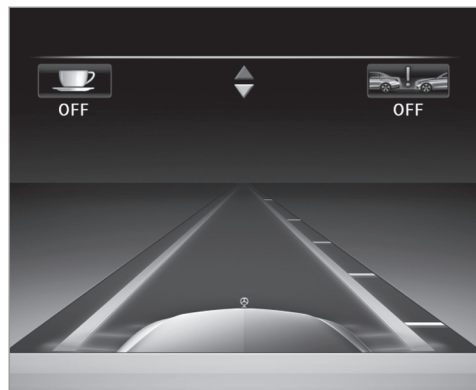

Status displays in the Assistance graphic:

- : ATTENTION ASSIST deactivated
- : Active Brake Assist deactivated
- Light lane markings: Active Lane Keeping Assist activated
- Green lane markings: Active Lane Keeping Assist active

- Gray radar waves next to vehicle: Blind Spot Assist active
- Green radar waves next to vehicle: Blind Spot Assist active
- Display of Distance Pilot DISTRONIC (→ page 160)

### Calling up displays in the Trip menu

On-board computer:

Trip

- The spelling may differ in the main menu displayed. Therefore, observe the menu overview for the corresponding Instrument Display (→ page 197).

**Vehicles with the Instrument Display in the Widescreen Cockpit:** When you have set the progressive display setting, you can view information on the journey in the [Disp. Content](#) menu.

**To select a display:** Swipe up or down on the left-hand side of Touch Control.

Displays in the [Trip](#) menu:

- Standard display
- Range and current fuel consumption

A recuperation display is also available for certain engines. If there is only a small amount of fuel left in the fuel tank, the display shows a vehicle being refueled instead of the range.

- ECO display (→ page 134)
- Trip computer [From Start](#) and [From Reset](#)
- Digital speedometer

### **Instrument Display in the Widescreen**

**Cockpit:** The digital speedometer only appears in the CLASSIC or Sport display setting.

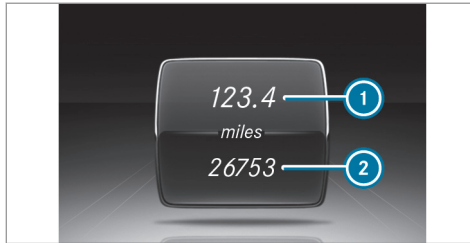

Example: standard display

- ① Trip distance
- ② Total distance



Example: trip computer

- ① Total distance
- ② Driving time
- ③ Average speed
- ④ Average fuel consumption

### Resetting values in the Trip menu of the on-board computer

On-board computer:

→ Trip

- ① The spelling may differ in the main menu displayed. Therefore, observe the menu over-

view for the Instrument Display  
(→ page 197).

You can reset the values of the following functions:

- Trip distance
- Trip computer "From start" and "From reset"
- ECO display

- ▶ **To select the function to be reset:** Swipe up or down on the left-hand side of Touch Control.
- ▶ Press the left-hand side of Touch Control.
- ▶ Select **Yes**.
- ▶ Press the left-hand side of Touch Control.

If you press and hold the left-hand side of Touch Control, the function will be reset immediately.

## Calling up navigation instructions in the on-board computer

On-board computer:

### Navigation

- The spelling may differ in the main menu displayed. Therefore, observe the menu overview for the Instrument Display (→ page 197).

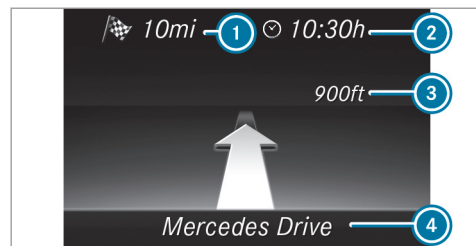

Example: No change of direction announced

- Distance to the next destination
- Estimated arrival time
- Distance to the next change of direction
- Current road

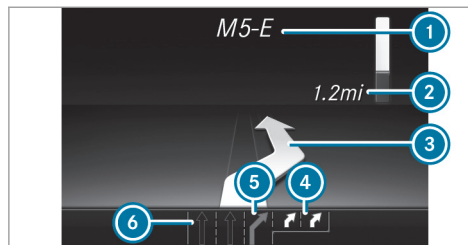

Example: Change of direction announced

- Road into which the change of direction leads
- Distance to the change of direction
- Change-of-direction symbol
- Recommended lane and new lane during a change of direction (white)
- Possible lane
- Lane not recommended (dark gray)

Further possible displays in the **Navigation** menu:

- Direction of Travel:** Display of direction of travel and road currently being traveled on.

- New Route... or Calculating Route...:** A new route is calculated.
- Road Not Mapped:** The road is unknown, e.g. newly built roads.
- No Route:** No route could be calculated to the selected destination.
- Off Map:** The map for the current location is not available.
- : You have reached the destination or an intermediate destination.

**To exit the menu:** Swipe up or down on the left-hand side of Touch Control.

**Vehicles with the COMAND multimedia system:** You can also start the navigation to one of the recent destinations in the **Navigation** menu:

Press the left-hand side of Touch Control.

**To select the destination:** Swipe up or down on the left-hand side of Touch Control.

Press the left-hand side of Touch Control. Route guidance starts.

If route guidance has already been activated, a request will appear asking whether you wish to end the current route guidance.

- ▶ Select **Yes**.
- ▶ Press the left-hand side of Touch Control. Route guidance starts.

### Selecting radio stations using the on-board computer

On-board computer:

↳ **Radio**

- ⓘ The spelling may differ in the main menu displayed. Therefore, observe the menu overview for the Instrument Display (→ page 197).



- ① Frequency range
- ② Station
- ③ Name of track
- ④ Name of artist
- ⑤ Genre

When you select a station in the presets, the preset appears next to the station name. When you select a saved station in the frequency range, an asterisk appears next to the station name.

- ▶ **To select a radio station:** Swipe up or down on the left-hand side of Touch Control.

### Selecting the frequency range or station preset

- ▶ Press the left-hand side of Touch Control.
- ▶ **To select the frequency range/station preset:** Swipe up or down on the left-hand side of Touch Control.
- ▶ Press the left-hand side of Touch Control.

### Playing back media using the on-board computer

On-board computer:

↳ **Media**

- ⓘ The spelling may differ in the main menu displayed. Therefore, observe the menu overview for the Instrument Display (→ page 197).

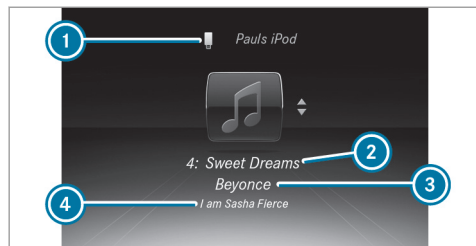

- ① Media source
- ② Current track and track number
- ③ Name of artist
- ④ Name of album

▶ **To change tracks in the active media source:** Swipe up or down on the left-hand side of Touch Control.

#### Changing the media source

- ▶ Press the left-hand side of Touch Control.
- ▶ **To select a media source:** Swipe up or down on the left-hand side of Touch Control.
- ▶ Press the left-hand side of Touch Control.

### Dialing telephone numbers using the on-board computer

#### Requirements

- Mobile phone connected to the multimedia system

On-board computer:

➔ Phone

- ① The spelling may differ in the main menu displayed. Therefore, observe the menu overview for the Instrument Display (→ page 197).

**⚠ WARNING** Risk of distraction from information systems and communications equipment

If you operate information and communications equipment integrated in the vehicle when driving, you will be distracted from the traffic situation. This could also cause you to lose control of the vehicle.

- ▶ Only operate this equipment when the traffic situation permits.

- ▶ If you cannot be sure of this, stop the vehicle whilst paying attention to road and traffic conditions and operate the equipment with the vehicle stationary.

When telephoning, you must observe the legal requirements for the country in which you are currently driving.

**Vehicles with the COMAND multimedia system:** The most recent telephone connections (dialed, received and missed calls) are displayed in the **Phone** menu.

- ▶ **To select a telephone number:** Swipe upwards or downwards on the left-hand side of Touch Control.
- ▶ Press the left-hand side of Touch Control. The telephone number is dialed.

The following displays may appear instead of the telephone numbers dialed:

- **Please Wait...:** The application is starting. When a Bluetooth® connection to the mobile phone is not established, the menu for authorizing and connecting a mobile phone is

displayed in the multimedia system  
(→ page 257).

- **Updating data....**: The call list is being updated.
- **Importing Contacts....**: The contacts from the mobile phone or from a storage medium are imported.

### Setting display content

On-board computer:

↳ **Disp. Content**

- ⓘ This function is only available for vehicles with a Widescreen Cockpit.

You can select the following display content:

- Tachometer (display settings Classic and Sport)
- Power meter (display settings CLASSIC and Sport)
- Date (display setting Progressive only)
- Navigation displays
- ECO display

- Consumption

▶ For progressive display setting only: select **Right Display** and press the left-hand side of Touch Control.

▶ **To select display content:** Swipe up or down on the left-hand side of Touch Control.

▶ Press the left-hand side of Touch Control. The selected display content appears on the right-hand side of the Instrument Display.

### Adjusting the Head-up Display settings in the on-board computer

On-board computer:

↳ **Head-up Disp.**

- ⓘ The spelling may differ in the main menu displayed. Therefore, observe the menu overview for the Instrument Display (→ page 197).

The following Head-up Display settings can be adjusted:

- **Position**
- **Brightness**

- **Display Content**

▶ **To select the setting:** Swipe up or down on the left-hand side of Touch Control.

▶ Press the left-hand side of Touch Control.

▶ **To set the value:** Swipe up or down on the left-hand side of Touch Control.

▶ Press the left-hand side of Touch Control.

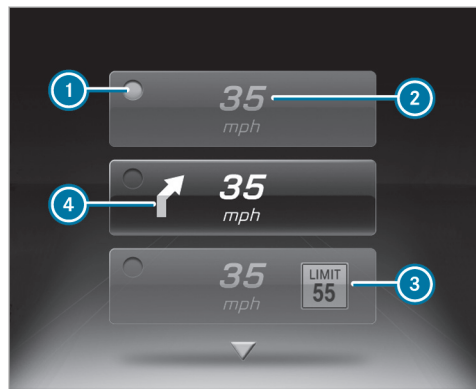

- ① Currently selected setting
- ② Digital speedometer
- ③ Traffic Sign Assist
- ④ Navigation displays

## Head-up Display

### Function of the Head-up Display

The Head-up Display projects information from the navigation system and the driver assistance system above the cockpit into the driver's field of vision.

### Display elements

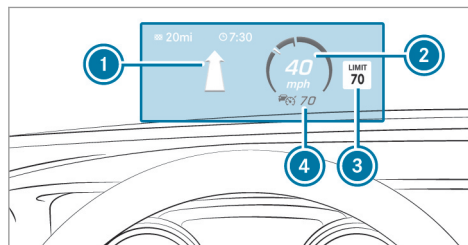

- ① Navigation messages
- ② Current speed
- ③ Detected instructions and traffic signs
- ④ Set speed in the driver assistance system (e.g. cruise control)

## System limitations

The visibility is influenced by the following conditions:

- Seat position
- The positioning of the display image
- Light conditions
- Wet roads
- Objects on the display cover
- Polarization in sunglasses



### Switching the Head-up Display on/off

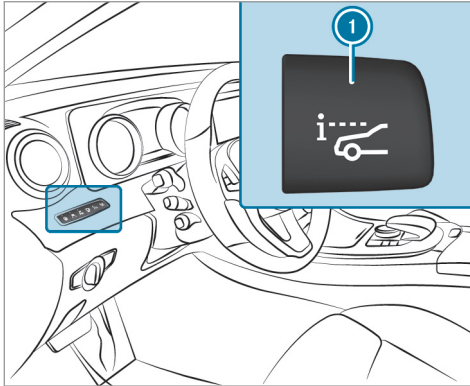

▶ Press button ①.

### Operating safety

**⚠ WARNING** Risk of distraction from information systems and communications equipment

If you operate information and communications equipment integrated in the vehicle when driving, you will be distracted from the traffic situation. This could also cause you to lose control of the vehicle.

- ▶ Only operate this equipment when the traffic situation permits.
- ▶ If you cannot be sure of this, stop the vehicle whilst paying attention to road and traffic conditions and operate the equipment with the vehicle stationary.

**⚠ WARNING** Risk of distraction from operating mobile communication equipment while the vehicle is in motion

If you operate mobile communication equipment when driving, you will be distracted

from the traffic situation. This could also cause you to lose control of the vehicle.

Only operate this equipment when the vehicle is stationary.

For your own safety, always observe the following points when operating mobile communications equipment and especially your voice control system:





- Observe the legal requirements for the country in which you are driving.
- While driving, only operate mobile communications equipment when the traffic conditions permit it. You may otherwise be distracted from the traffic conditions and cause an accident, injuring yourself and others.
- Do not use the voice control system in an emergency as your voice can change and your telephone call can be unnecessarily delayed.
- Familiarize yourself with the voice control system functions before starting the journey.

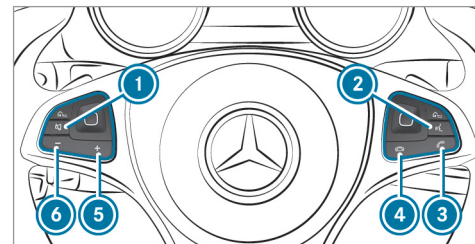

### Operation

#### Operating the multifunction steering wheel

The Voice Control System is operational approximately thirty seconds after the ignition is switched on.



- ①  Switches the sound off/on (ends the Voice Control System)
- ②  Starts the Voice Control System
- ③  Makes/accepts a call
- ④  Rejects/ends a call (ends the Voice Control System)

- ⑤  Increases the volume
- ⑥  Decreases the volume

### Voice prompting

- ▶ **To start or continue a dialog:** press the  button on the multifunction steering wheel. You can say a command after an acoustic signal.
- ▶ **To correct an entry:** say the Correction command.
- ▶ **To select an entry from the selection list:** say the line number or the contents.
- ▶ **To browse the selection list:** say the Continue or Back command.
- ▶ **To interrupt the dialog:** say the Pause command.
- ▶ **To cancel the dialog:** say the Cancel command.

### Operable functions

You can use the Voice Control System to operate the following equipment, depending on the vehicle's equipment:

- Telephone
- Text messages
- Navigation
- Address book
- Radio
- Audio (memory card, Media Interface, USB and Bluetooth® audio)
- Vehicle

### Command types

A distinction is made between the following command types:

- **Global commands** can be said at any time and regardless of the current application, e.g. the Navigate to, Call or Text message to commands.

- **Application-specific commands** are only available for the active application.

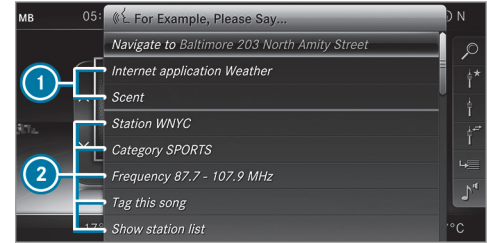

- ① Global commands
- ② Application-specific commands

On the display next to the active application, varying global commands and the corresponding application-specific commands are displayed on an autocue. This makes entry easier and supports interactive operation. The list can be scrolled or it can be operated by speech or the controller/touchpad.

### Entering numbers

Entering numbers:

- The numbers allowed are zero to nine.
- Telephone numbers can be entered as single digits.

### Changing the language setting

You can change the language of the Voice Control System via the system language settings. If the set system language is not supported by the Voice Control System, English will be selected.

The Voice Control System is available in English, French and Spanish.

### Using Voice Control System effectively

#### Audible help functions

You receive information and help for:

- **Optimal operation:** say the Help Voice Control System command.

- **Current application:** press the  button on the multifunction steering wheel and say the Help command.
- **Continued dialog:** say the Help command during a voice dialog.
- **Specific system:** call up the help command for the desired system, e.g. Help telephone.

### Speech quality improvement

**If the Voice Control System does not understand you:**

- Only operate the Voice Control System from the driver's seat.
- Say the commands coherently and clearly, but do not exaggerate the words.
- Prevent loud noises, e.g. the blower, from interfering while you make an entry.
- Say the voice tag with the same intonation when creating voice tags.

**If an address book entry voice tag is not recognized:**

- Only create sensible address book entries in the system/mobile phone, e.g. surname and first name in the correct field.
- Do not use any abbreviations, unnecessary spaces or special characters.
- Create a speaker-dependent voice tag, if necessary.
- Press the  button on the multifunction steering wheel when the desired name is read out.

**If a station list entry is not recognized:**

- Save a speaker-dependent voice tag for the station.
- Say the Read out station list command.
- Press the  button on the multifunction steering wheel when the desired station is read out.

### Essential commands

#### Switch commands

Switch commands can be used to open certain applications. The command selection can be

used regardless of the application that is currently active.

Command	Function
Navigation	To switch to navigation mode
Map	To switch to map display
Address book	To switch to address book
Telephone	To switch to telephone mode
Text message	To switch to text messages
Radio	To switch to radio mode
Media	To switch to media mode
USB	To switch to USB
Memory card	To switch to memory card
Internet application <Name>	To start a Mercedes-Benz online application. The application must be called up by touch once prior to use.
Mercedes-Benz Apps	To switch to Mercedes-Benz Apps

Command	Function
Connect	To switch to Internet mode
Vehicle	To switch to vehicle settings
System settings	To switch to system settings

### Navigation commands

---

With the navigation commands, you can enter POIs or conventional addresses as well as make important navigation settings.

Command	Function
Navigate to <Address/POI/Contact>	Universal search for destinations of all types. A search is also performed in the address book contacts, in the navigation database and on the Internet (POIs). The order of the details, e.g. city, street or house number, can be changed.
Address <Address>	Destination entries consisting of city, street and house number
Address in <Country>	Destination entry in a desired country, e.g. address in France
POI <POI>	Destination entry for a POI, e.g. POI Brandenburg Gate. A search is also performed in the navigation database and on the Internet.
POI online search <POI>	To conduct a POI search on the Internet only

Command	Function
Navigate to contact <Name>	Destination entry to a contact in the address book
Enter country Enter city Enter district Enter street Enter intersection Enter house number Enter ZIP code	To enter a country/city/district/street/intersection/house number/ZIP code
Nearest restaurant Nearest parking lot Nearest rest area with restrooms Nearest gas station	To search for nearby restaurants, parking spaces and gas stations
Last destinations	To select a destination from the list of last entered destinations
Alternative routes	To switch route guidance to another route
Start route guidance	To start route guidance after entering a valid destination
Cancel route guidance	To cancel route guidance

Command	Function
Guidance instructions on Guidance instructions off	To switch the route guidance voice output on/off
Show traffic map Hide traffic map	To switch the traffic map on/off
Switch on POI symbols Switch off POI symbols	To switch the POI symbols display on the map on/off

### Telephone commands

You can use the telephone commands to make phone calls or search through the address book.

Command	Function
Call <Name>	To make a phone call. All address book names are available.
Call <Number>	To make a phone call.
Find contact <Name>	To search for and display a contact. All address book names are available.
Last phone number	To display the last call
Redial number	To select the last phone number dialed



### Radio commands

Radio commands can also be used when the radio application is running in the background.

Command	Function
Station <Name>	To call up receivable or saved stations
<Frequency>	Direct frequency entry
Next station Previous station	To switch to the next available station
Save station	Station is saved in the station list
Show station list	To display the names of all receivable stations
Read out station list	To listen to the names of all receivable stations
Traffic information on Traffic information off	To switch the traffic information service on/off
Radio info on Radio info off	To switch the current station information on/off

### Media player commands

Media player commands can also be used when the media player is running in the background.

Command	Function
Play <Track>	The names of all available tracks are accepted during the search
Media search <Track>	The names of all available tracks are accepted during the search
Show all albums Show all artists Show all composers Show all genres Show all tracks Show all playlists	Available albums, artists, composers, genres, tracks or playlists are searched for.
Next track	To select the next track
Previous track	To select the previous track
Random track list on Random track list off	To switch the random track list on/off

### Message commands

Text messages can be created, edited and listened to using the message commands.

Command	Function
Text message to <Name>	To create a message. All address book names are available.
Reply	To reply to a message
Forward text message	To forward a message

### Vehicle commands

You can use the vehicle commands to directly call up the corresponding menus for the vehicle settings.

Command	Function
Ambient light	To display ambient light settings
Display and styles	To show display settings
Assistance settings	To display assistance settings
Scent	To display fragrancing settings
Energy flow	To display energy flow settings
Ionization	To display ionization settings
Climate control	To display climate control settings

## 218 Voice Control System

---

Command	Function
Light	To display light settings
Massage	To display massage settings
Engine data	To display engine data
Seat	To display seat adjustment settings
Consumption	To display consumption
Visualization	To display visualization

## Overview and operation

### Overview of the multimedia system

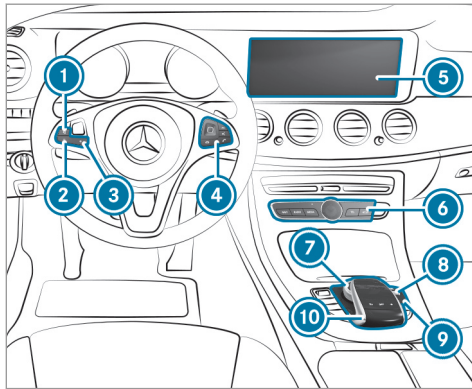

- ① Switches the sound on or off
- ② Decreases the volume
- ③ Increases the volume
- ④ Touch Control
- ⑤ Media display

- ⑥ NAVI, RADIO, MEDIA, TEL, buttons, calls up main functions
- ⑦ Controller
- ⑧ Control knob, adjusts volume and switches the sound on or off
- ⑨ button, switches the multimedia system on or off
- ⑩ Touchpad

Touch Control ④, controller ⑦ and touchpad ⑩ are central controls.

### Notes on the media display

#### **NOTE** Scratching of the display

The display has a highly sensitive, high-gloss surface. There is a risk of it becoming scratched.

Avoid touching the display.

Observe the notes on cleaning.

Observe the notes on caring for the interior (→ page 311).

**Automatic temperature-controlled switch-off feature:** if the temperature is too high, the brightness is initially reduced automatically. The media display may then switch off completely for a while.

- ⓘ If you are wearing polarized sunglasses, it may be difficult to read the media display.

### Central controls overview

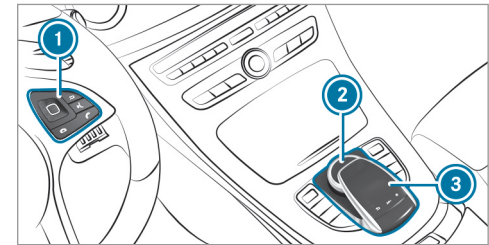

- ① Touch Control
- ② Controller
- ③ Touchpad

## Touch Control

### Operating Touch Control

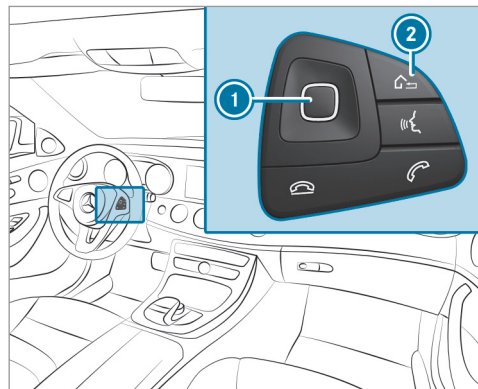

- ▶ **To select a menu item:** swipe up, down, left or right on Touch Control ①.
- ▶ Press Touch Control ①.
- ▶ **To open a list:** press Touch Control ①.
- ▶ **To close a list:** press the ② button.

- ▶ **To call up the menu list/favorites:** hold button ②.
- ▶ **To move the digital map:** swipe in any direction.

### Setting the sensitivity



Multimedia system:

➔ System ➔  Input ➔ Touch Control Sensitivity



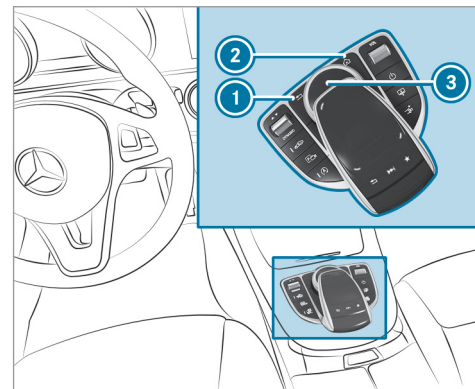

- ▶ Select **Fast**, **Medium** or **Slow**.

## Operating the controller



- ①  button, to return to the previous display (press briefly), to call up the basic menu (press and hold)
- ②  button, to call up main functions and favorites
- ③ Controller

Controller operating options:

- ▶ Turn  left or right.
- ▶ Slide  left or right.
- ▶ Slide  up or down.
- ▶ Slide  diagonally.
- ▶ Press  briefly or press and hold.

## Touchpad

### Switching the touchpad on/off

#### Requirement:

The vehicle is equipped with a controller.

Multimedia system:

 System  Entry



- ▶ Switch **Touchpad** on  or off .

### Operating the touchpad

#### Requirement:

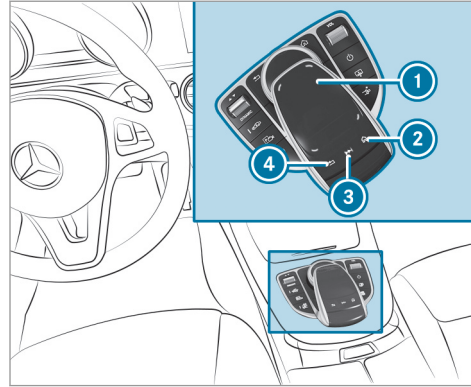
For vehicles with a controller: the touchpad is switched on (→ page 221).



- ① Touchpad
- ②  button, calls up main functions and favorites
- ③  button, calls up the audio menu
- ④  button, returns to the previous display

You can navigate in menus and lists via touch-sensitive surface ① by using a **single-finger swipe**.

- ▶ **To select the menu item:** Swipe up, down, left or right.
- ▶ Press touchpad ①.
- ▶ **To open or close lists:** Swipe left or right.
- ▶ **To move the digital map:** Swipe in any direction.

### Use the following functions with a two-finger swipe:

- ▶ **To call up the menu bar:** Swipe down with two fingers.
- ▶ **To zoom in and out of the map:** Move two fingers together or apart.

### Setting the sensitivity

Multimedia system:

 System  Input

- ▶ Select **Touchpad Sensitivity**.
- ▶ Select **Fast**, **Medium** or **Slow**.

### Handwriting recognition: switching the read-aloud function on/off

Multimedia system:

→ System →  Audio

- ▶ Switch **Read Out Handwriting Recognition** on  or off .

### Handwriting recognition: selecting an input language

- ▶ Press the touchpad when entering characters.
- ▶ Select .
- ▶ Select an input language.

## Main functions

### Calling up main functions

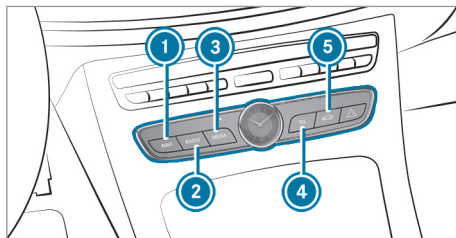

- ▶ ① **NAVI** button, switches navigation on
- ▶ ② **RADIO** button, switches the radio on
- ▶ ③ **MEDIA** button, switches the audio source on
- ▶ ④ **TEL** button, switches telephone mode on
- ▶ ⑤  button, calls up vehicle functions

### Alternatively:

- ▶ When the basic menu of a main function is shown, press the  button.

- ▶ **To select a main function:** swipe left or right on the touchpad.
- ▶ Press the touchpad.

### Calling up lists and menus on the multimedia system

#### Calling up a list

- ▶ Call up a main function (→ page 222).
- ▶ **To open a list:** swipe left on the touchpad. The list is opened.
- ▶ **To select a menu item:** swipe up or down on the touchpad.
- ▶ Press the touchpad.

## Favorites

### Overview of favorites

Favorites offer you quick access to frequently used applications. It is possible to create 20 favorites in total.

The following functions are available:

- Add **pre-defined favorites** from the following categories:



- Navigation
- Phone
- Media
- Radio
- Connect
- Vehicle
- System Settings

- Add **your own favorites**
- Rename a favorite
- Move a favorite
- Delete a favorite
- Restore all favorites settings

#### Calling up favorites

- ▶ Press the  button.  
The main functions are displayed.
- ▶ Navigate downwards once.

#### Leaving the Favorites menu

- ▶ Press the  button.

#### Adding a favorite

##### Adding a pre-defined favorite



- ▶ Press the  button.  
The main functions are displayed.
- ▶ Navigate downwards twice.  
The Favorites menu appears.

- ▶ Select **New Favorite**.  
The categories are displayed.
- ▶ Select a category.  
The favorites are displayed.
- ▶ Select a favorite.
- ▶ Add a favorite at the desired position.  
If a favorite has already been added at this position, it will be overwritten.

#### Adding your own favorite (example)

- ▶ Select **Vehicle**.
- ▶ Select **Full Screen: Consumption**.
- ▶ Press and hold the  button until the favorites are displayed.
- ▶ Add a favorite at the desired position.

#### Renaming a favorite

- ▶ Press the  button.  
The main functions are displayed.
- ▶ Navigate downwards once.
- ▶ Select a favorite.
- ▶ Navigate downwards once.  
The Favorites menu appears.

- ▶ Select **Rename**.
- ▶ Enter characters.
- ▶ **To confirm the entry:** select **OK**.

#### Moving a favorite

- ▶ Press the  button.  
The main functions are displayed.
- ▶ Navigate downwards once.
- ▶ Select a favorite.
- ▶ Navigate downwards once.  
The Favorites menu appears.
- ▶ Select **Move**.
- ▶ Move the favorite to the desired position.



#### Deleting a favorite

- ▶ Press the  button.  
The main functions are displayed.
- ▶ Navigate down once.
- ▶ Select a favorite.
- ▶ Navigate down once.  
The Favorites menu appears.
- ▶ **To delete:** Select **Delete**.

- ▶ Select **Yes**.
- ▶ **To restore all favorites:** Select **Reset All**.  
A prompt appears.
- ▶ Select **Yes**.  
The favorites will restore to factory settings.

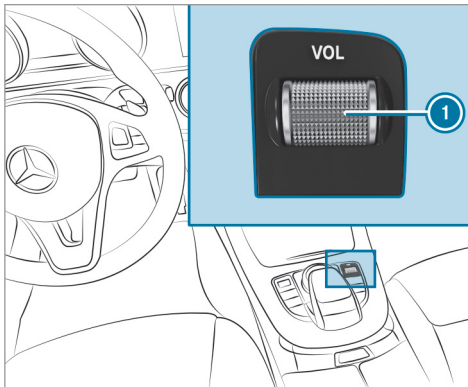
#### Switching the sound on/off



- ▶ **To switch off:** press control knob . The  symbol appears in the status line. You will also hear traffic announcements and navigation announcements even when the sound is muted.
- ▶ **To switch on:** change the media source or adjust the volume.

## Adjusting the volume

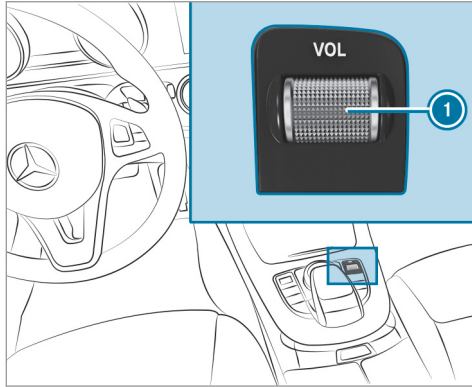

- ▶ Turn control knob ①.  
The volume of the current radio or media source is set. You can set the volume of other sound sources separately.  
Adjust this in the following situations:
  - during a traffic announcement
  - during a navigation announcement

The volume of the navigation announcement changes in accordance with the volume of the current media source.

- during a telephone call
- ▶ **Alternatively:** select **System**.
- ▶ Select **Sound**.
- ▶ Select volume settings.
- ▶ Set the volume.

## Entering characters

### Using the character input function

The following functions are available:

- selecting a character in the character bar.
- writing a character on the touchpad.

Character input can be started with a control and resumed with another.

- ▶ **On the Touch Control and controller:** select a character in the character bar.  
Depending on the destination entered, the following is available:
  - the full set of characters

- characters which are useful for the current input string  
Other characters are grayed out.
- ▶ **On the touchpad:** select a character in the character bar.

or

- ▶ Write the characters on the touch-sensitive surface of the touchpad.  
Handwriting recognition supports you by means of character suggestions and a read-aloud function.

Characters can be entered using the following methods:









- using a keyword search for a track or artist
- connecting the mobile phone to the multimedia system by entering the passkey
- entering a phone number
- entering a web address

### Entering characters using the controller

#### Entering characters

- ▶ Turn **[⊙]**, slide **←⊙→** or **↑⊙↓** and press the controller.

Use the following editing functions:

-  or   
Changes to upper-case or lower-case letters
-   
Changes to digits and symbols
-   
Changes the language
-   
Selects the input line
-   
Moves the cursor within the input line
-   
Deletes a character or an entry
-   
Cancels character entry

#### Deleting a character or an entry

- ▶ **To delete a character:** when  is highlighted, press the controller.

- ▶ **To delete an entry:** when  is highlighted, press and hold the controller until the entry has been deleted.

#### Confirming an entry

- ▶ Select .

#### Entering characters on the touchpad

##### Entering characters





- ▶ Use one finger to write characters on the surface.  
The character is entered in the input line. If different interpretations are possible, character suggestions are displayed.

##### Selecting a character suggestion

- ▶ **Vehicles without a controller:** swipe up or down on the touchpad.
- ▶ **Vehicles with a controller:** turn the controller.
- ▶ Press the touchpad.
- ▶ Resume character input.

The following editing functions can be used:

-  or 

- Changes to upper-case or lower-case letters
-   
Changes to digits and symbols
-   
Changes the language
-   
Selects the input line
-   
Moves the cursor within the input line
-   
Cancels character entry

#### Selecting the input line

- ▶ Select .
- ▶ Swipe up or down.

#### Moves the cursor within the input line

- ▶ Select .
- ▶ Swipe to the left or right.

#### Deleting characters

- ▶ When an input line is selected, swipe left.

### Confirming an entry

- ▶ Press the touchpad.

## System settings

### Display

#### Configuring display settings

Multimedia system:

- ↳ System ▶  Display and Designs

#### Designs

- ▶ Select **Designs**.
- ▶ Select **Sport**, **Classic** or **Progressive**.

#### Additional display area

Depending on the vehicle, various items of additional information can be shown. The additional display area comprises the left-hand or right-hand third of the display.

- ▶ Select **Additional Disp. Area**.

The following display content can be selected:

- **Dynamic**
- **Navigation Map**

- **Consumption**
- **Time and Date**

#### Display brightness

- ▶ Select **Display Brightness**.
- ▶ Select a brightness value.

#### Switching the display off/on

- ▶ **Off:** select **Display off**.
- ▶ Switch on setting.
- ▶ **On:** press a button, e.g. .

#### Display design

- ▶ Select **Day/Night Design**.
- ▶ Select **Automatic**, **Day Design** or **Night Design**.

## Time and date

### Setting the time and date automatically

Multimedia system:

- ↳ System ▶ Time and Date ▶ Automatic Time Settings

The correct time is required for the following functions:

- Route guidance with time-dependent traffic guidance
  - Calculation of expected time of arrival
- ▶ Activate  or deactivate  the function.

### Setting the time zone

Multimedia system:

- ↳ System ▶ Time and Date ▶ Time Zone:

A list of countries is displayed.

- ▶ Select a country •.  
Depending on the country, time zones are displayed.
- ▶ Select a time zone.  
The time zone set is displayed after **Time Zone:**.

**Setting summer time**

The **Automatic Daylight Saving Time** and **Daylight Saving Time** options cannot be selected in all countries.

Multimedia system:

→ System ▶▶ Time and Date

**Automatic**

▶ Activate  or deactivate  **Automatic Daylight Saving Time**.

**Manual**

- ▶ Select **Daylight Saving Time**.
- ▶ Select **On** or **Off**.

**Setting the time and date format**

Multimedia system:

→ System ▶▶ Time and Date ▶▶ Set Format

- ▶ Set the date and time format •.

**Setting the time manually****Requirement:**

The **Automatic Time Settings** function is deactivated or is not supported in a time zone.

Multimedia system:

→ System ▶▶ Time and Date ▶▶ Set Time

- ▶ Set the hours.
- ▶ Navigate to the right to set the minutes.
- ▶ Set the minutes.
- ▶ Confirm changes when exiting the menu.

The date is set automatically via GPS.

**Bluetooth®****Bluetooth® settings**

Bluetooth® technology is a standard for short-range wireless data transfer up to approximately 32.8 ft (10 m). You can use Bluetooth® to connect your mobile phone to the multimedia system and use the following functions, for example:

- hands-free system with access to the following options:
  - contacts (→ page 260)
  - call lists (→ page 262)
  - text messages (→ page 262)

- Internet connection (→ page 269)
- listening to music via Bluetooth® audio (→ page 286)
- transferring business cards (vCards) into the vehicle

Bluetooth® is a registered trademark of Bluetooth Special Interest Group (SIG) Inc.

**i** Internet connection via Bluetooth® is not available in all countries.

**Activating/deactivating Bluetooth®**

Multimedia system:

→ System ▶▶  Connectivity

- ▶ Activate  or deactivate  Bluetooth®.

**Wi-Fi****Wi-Fi connection overview**

You can use Wi-Fi to establish a connection with a Wi-Fi network and to access the Internet or any other network device.

The following connection options are available:

- Wi-Fi connection

The Wi-Fi connection is established with a Wi-Fi-enabled device, e.g. to the customer's mobile phone or tablet PC.

- Multimedia system as a Wi-Fi hotspot

Using this function, a tablet PC or notebook for example can be connected.

To establish a connection, you can use the following methods:

- WPS PIN

The connection to a secure Wi-Fi network is made via a PIN.

- WPS PBC

The connection to a secure Wi-Fi network is made by pressing a button (push button).

- Security key

The connection to a secure Wi-Fi network is made via a security key.

### Setting up Wi-Fi

#### Requirement:

The device to be connected supports one of the three means of connection described.

Multimedia system:

→ System →  Connectivity

#### Activating/deactivating Wi-Fi

- ▶ Switch **Wi-Fi** on  or off .



If **Wi-Fi** is deactivated , communication via Wi-Fi to all devices is interrupted. This also means that a connection to the HERMES communication module cannot be established. Functions such as dynamic route guidance with Live Traffic Information are then unavailable.

#### Connecting the multimedia system with a device via Wi-Fi

This function is available if a HERMES communication module is not installed.



The type of connection established must be selected on the multimedia system and on the device to be connected.

- ⓘ The connection procedure may differ depending on the device. Follow the instructions that are shown in the display. Further information (see the manufacturer's operating instructions).

- ▶ Select **Internet Settings**.
- ▶ Select **Search for Wi-Fi Networks**.
- ▶ **Via WPS PIN:** Highlight a Wi-Fi network in the list.
- ▶ Select  **Connect via WPS PIN**. The multimedia system generates an eight-digit PIN.
- ▶ Enter this PIN on the device to be connected.
- ▶ Confirm the entry.
- ▶ **By pressing a button:** Highlight a Wi-Fi network in the list.
- ▶ Select  **Connect via WPS PBC**.
- ▶ Select "Connect via WPS PBC" in the options on the device to be connected.
- ▶ Press the WPS button on the device to be connected.
- ▶ Select **Continue** in the multimedia system.
- ▶ **Using a security key:** Highlight a Wi-Fi network in the list.
- ▶ Select  **Connect Using Security Key**.

- ▶ Open the "Tethering" menu on the device to be connected in order to display the security key (see the manufacturer's operating instructions).
- ▶ Enter this security key on the multimedia system.
- ▶ Confirm the entry.
- ▶  All devices support a security key as a means of connection.

#### Device has already been connected

- ▶ **To automatically connect:** Highlight a Wi-Fi network in the list.
- ▶ Activate   **Connect Automatically.**
- ▶ **To connect:** Highlight a Wi-Fi network in the list.
- ▶ Select  **Connect.**  
The connection is established again. These functions are possible when the device has already been connected to the Wi-Fi network.

#### Setting up a Wi-Fi hotspot

Multimedia system:

 **System** ▶  **Connectivity**

#### Configuring the multimedia system as a Wi-Fi hotspot

The type of connection established depends on the device to be connected. The function must be supported by the multimedia system and by the device to be connected. The type of connection established must be selected on the multimedia system and on the device to be connected.

- ▶ Select **Set Up Hotspot.**
- ▶ **To generate a WPS PIN:** Select **Generate WPS PIN.**
- ▶ Enter the PIN shown in the multimedia system display on the device to be connected.
- ▶ Confirm the PIN.
- ▶ **To enter the WPS PIN:** Select **Enter WPS PIN.**
- ▶ Enter the PIN which is shown on the external device's display on the multimedia system.

- ▶ Select **OK.**
- ▶ **To connect by pressing a button:** Select **Connect via WPS PBC.**
- ▶ Press the push button on the device to be connected.
- ▶ Select **Continue.**
- ▶ **To connect via a security key:** Select **Connect Using Security Key.**
- ▶ Select the vehicle from the device to be connected. The vehicle is displayed with the SSID **MB Hotspot XXXXX.**
- ▶ Enter the security key which is shown in the multimedia system display on the device to be connected.
- ▶ Confirm the entry.

#### Further configuration menus

In these menus you can modify the Wi-Fi hotspot settings.

- ▶ **To generate a new security key:** Select **Generate Security Key.**  
A connection will be established with the newly created security key.



When a new security key is saved, all existing Wi-Fi connections are then disconnected.

- ▶ **To save a security key:** Select **Save**.

## COMAND Touch

### Authorizing a COMAND Touch device

#### Requirements

- The COMAND Touch app is installed on the external device (e.g. tablet) which is to be used as a Rear Seat Entertainment unit.
- Wi-Fi is activated (→ page 229) and the multimedia system is configured as a Wi-Fi Hot-spot (→ page 230).

Multimedia system:

↳ System ▶ COMAND Touch

### Connecting a new device

- ▶ Select **Authorize a New Device**.
- ▶ Select **Connect New Device**.  
A security key is displayed.

- ▶ Enter the security key in the external device. The **Please start COMAND Touch on your device and follow the instructions. The App is available in the App Store.** message appears.

### Selecting an already connected device

- ▶ Select **Authorize a New Device**.  
The devices already connected are displayed.
- ▶ Select **Continue Using Connected Devices**. The **Please start COMAND Touch on your device and follow the instructions. The App is available in the App Store.** message appears.

### Activating/deactivating the COMAND Touch child safety lock

Multimedia system:

↳ System ▶ COMAND Touch

#### Child safety lock

- ▶ Activate  or deactivate  **Parental Control**.  
The content displayed on the external device can only be set on the multimedia system.

## System language

### Notes on the system language

This function allows you to determine the language for the menu displays and the navigation announcements. The selected language affects the characters available for entry. The navigation announcements are not available in all languages. If a language is not available, the navigation announcements will be in English.

### Setting the system language

Multimedia system:

↳ System ▶ Language

- ▶ Set the language.

- ⓘ If you are using Arabic map data, the text information can also be shown in Arabic on the navigation map. To do so, select العربية as the language from the language list. Navigation announcements are then also made in Arabic.

## Setting the distance unit

Multimedia system:

↳ System ▶▶ Units

- ▶ Select **km** or **mi**.
- ▶ Switch **Additional Speedometer** on  for a display in the multifunction display.

## Data import and export

### Data import/export function

The following functions are possible:

- transferring data from one system or vehicle to another system or vehicle.
- creating a backup copy of your personal data and loading it again.
- protecting your personal data against unwanted export with PIN protection.

You can either use an SD card or a USB storage device as temporary storage.

## Importing/exporting data

### NOTE Data loss

- ▶ Do not remove the data storage medium when data is being exported.

Mercedes-Benz is not liable for any loss of data.

### Requirements

- The vehicle is stationary.
- The ignition is switched on or the vehicle has been started.
- The SD card is inserted (→ page 277) or the USB device is connected (→ page 280).

Multimedia system:

↳ System ▶▶ System Backup

- ▶ Select **Import Data** or **Export Data**.

### Importing

- ▶ Select a data storage medium.  
A prompt appears asking whether you really wish to overwrite the current data. If data

originates from another vehicle, this is recognized during data reading.

The multimedia system is restarted once the data has been imported.

- ⓘ Current vehicle settings can be edited after the import.

### Exporting

If PIN protection is activated, your PIN is requested.

- ▶ Enter your four-digit PIN.
- ▶ Select a data storage medium.  
The data is exported. The data export may take several minutes.

### Activating/deactivating PIN protection for data export

Multimedia system:

↳ System ▶▶ System Backup

- ▶ **To activate:** activate **PIN Protection** .
- ▶ Enter your four-digit PIN.
- ▶ Enter your four-digit PIN again.  
PIN protection is activated when both PINs match.

- ▶ **To deactivate:** deactivate [PIN Protection](#) .
- ▶ Enter your four-digit PIN.
- ❗ If you have forgotten your PIN, an authorized Mercedes-Benz Center can deactivate your PIN protection for you.  
Alternatively: you can deactivate PIN protection by resetting your personal data.

## User profile

### Selecting a user profile

Multimedia system:

↳ System ▶  Personalization

- ▶ Select [Guest Profile](#) or individual profile ●.

- ❗ Some settings from the user profile are only loaded when the vehicle is stationary or when the ignition is switched on.

### Creating a user profile

Multimedia system:

↳ System ▶  Personalization ▶ Create Profile

- ▶ Enter a name.

- ▶ Select .

The user profile saves individual settings, e.g.:

- System settings
- Settings in the TV tuner's channel list
- Navigation and traffic information

The settings differ depending on the vehicle equipment.

### Importing/exporting user profiles

#### Requirements:

- There is an Internet connection (→ page 269).
- A Mercedes me account exists at <http://www.mercedes.me>.
- The [Personalization](#) service is activated.

Multimedia system:

↳ System ▶  Personalization ▶ Manual Export/Import

The function is not available in all countries.  
Only individual profiles can be imported or exported.

The individual profiles are always collectively imported or exported.

- ▶ **To import:** select [Import Profiles from Server](#).  
The [The profile data import overwrites all existing profile data. Do you want to continue?](#) message appears.

- ▶ Select [Yes](#).  
User profiles are imported.

- ▶ **To export:** select [Export Profiles to the Server](#).  
User profiles are exported.

- ❗ Certain settings such as address book entries or previous destinations from the navigation system are not exported.

### User profile options

Multimedia system:

↳ System ▶  Personalization ▶  Options

The following options are available:

- [Rename](#)
- [Delete](#)

- [Reset](#)

▶ Select an option.

- ❗ The guest profile cannot be deleted or renamed.

## Software update

### Information on software updates

The multimedia system provides a message when an update is available.

Depending on the source, you can perform various updates:

### Software update

Source of the update	Update type
Internet	Navigation maps, system updates
External storage medium, e.g. USB stick	Navigation maps

## Performing a software update

### Requirement:

An Internet connection is required for updates which are obtained online (→ page 269).

Multimedia system:

↳ [System](#) ▶ [Software Update](#)

### Automatically

▶ Activate  the automatic software update. Updates are performed.

The current status of the updates is displayed.

The automatic software update is not available in all countries.

### Manual

▶ Deactivate  the automatic software update.

▶ Select an update from the list and start the update.

### Activating the software update

▶ Restart the system.

## Reset function

Multimedia system:

↳ [System](#) ▶ [Reset](#)

The multimedia system is reset to the factory settings.

Personal data is deleted, for example:

- Station presets
- Connected mobile phones

▶ Select **Yes**.

A prompt appears asking whether you wish to reset.

**No** selected: the process is canceled.

▶ Select **Yes**.

The multimedia system is reset to factory settings and restarted.

## Navigation

### Switching navigation on

Multimedia system:

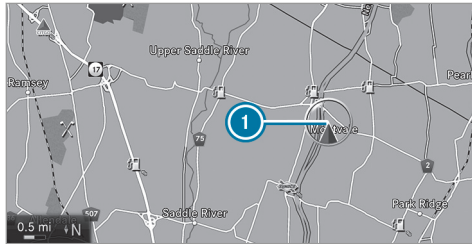

▶ Alternatively: press the **NAVI** button.  
The map appears and shows current vehicle position ①.

❗ If a climate control setting is changed, a climate bar appears briefly.

### Showing/hiding the navigation menu

**Requirement:**

The map displays the current vehicle position.



▶ **To show:** Swipe left on the touchpad or Touch Control.

or

▶ Slide the controller to the left.

▶ **To hide:** Swipe right on the touchpad or Touch Control.

or

▶ Slide the controller to the right.

### Destination entry

**Entering a POI or address**

Multimedia system:

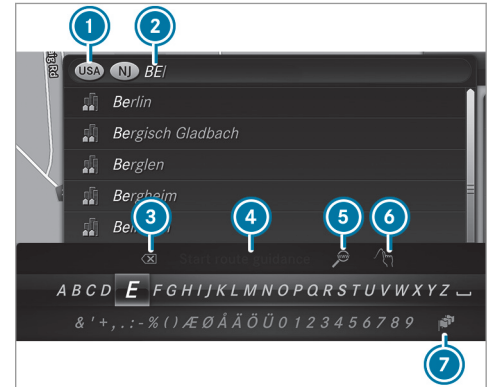

▶ Select **Enter Destination**.

The country in which the vehicle is located is set ①.



- ▶ **To select a state/province:** select [Enter State](#) or [Enter Province](#).
- ▶ Enter a state or province. You only need to enter the first character.
- ▶ Select a state or province in the list.
- ▶ **To select a country:** select [Change Country](#).
- ▶ Enter a country. You only need to enter the first character.
- ▶ Select a country in the list.
- ▶ Enter a POI or address in [2](#). The entries can be made in any order.  
As you make an entry, the system offers suggestions which can be adopted.  
Possible entries include, for example:
  - City, street, house number
  - Street, city
  - ZIP code
  - POI name
  - POI category, e.g. gas station
  - city, POI name

- ▶ The list is updated on the basis of the characters that are entered.
- ▶ **To switch to handwriting recognition:** select [6](#).
- ▶ Write characters on the touchpad.
- ▶ **To switch to character selection:** press the  button.
- ▶ **To delete an entry:** select [3](#).
  - Press briefly: deletes the last character entered or the last suggestion adopted.
  - Press and hold: deletes the entire entry.
- ▶ **To set the language:** select [7](#).
- ▶ Select a language.
  - [i](#) This function is useful for countries in which more than one character set is supported. Russia is one such example with Cyrillic and Latin characters.
- ▶ **To call up the online search function:** select [5](#) (if available).  
Once an Internet connection is established, a list appears. It shows online destinations related to the previous entry.

- ▶ Online destinations are provided by the Internet service provider.
- ▶ Select the destination.
- ▶ **To call up the list:** press the  button.
- ▶ Select a destination in the list.  
If there are several listings for a destination, another list appears.
- ▶ **To adopt a destination:** select [4](#) [Adopt Destination](#).
- [i](#) Depending on the entry made, [Show More Destination Suggestions](#) may appear.

### Selecting a POI

Multimedia system:

- ▶  [Navigation](#) ▶  [Destination](#) ▶ [POIs](#)
- ▶ Select a category.
- or
- ▶ Select [All Categories](#).
- ▶ Select a category.  
The list is sorted by distance in ascending order.

The POIs show the following information:

- Name of POI
- Linear distance to the POI
- The direction of the linear distance to the POI (arrow) is displayed when searching for the vehicle's current position

▶ Select a POI.

or

▶ Enter a search term in the upper line.  
The results list shows relevant POIs.

Example: if you enter **Italy**, POIs are shown:

- Whose name includes the word **Italy**
- Which belong to the category **Italian cuisine**

▶ Select **ok**.

This reduces the number of search results.

▶ Select a POI.

### Setting the search position for the parking category, for example, during active route guidance

- ▶ Select **Near Destination** or **Along the Route**.  
The list shows the located POIs or opens an overview of the route.
- ▶ Select a POI.

### Selecting the last destination

Multimedia system:

↳ **Navigation** ▶  **Destination** ▶ **Previous Destinations**

- ▶ Select the destination.  
The destination address is shown.
- ▶ Alternatively: If a favorite has been saved, select **From Global Favorites**.
- ▶ Select a favorite.  
The destination address is shown.

### Selecting a contact

#### Requirement:

A mobile phone is connected to the multimedia system (→ page 257).

Multimedia system:

↳ **Navigation** ▶  **Destination**

- ▶ Select **Contacts**.
- ▶ Select the contact.  
The relevant contact details are displayed.
- ▶ Select an address.
- ▶ Alternatively: enter names or initials into the search field, for example.  
This filters the contacts.
- ▶ Select **ok**.  
The first contact in the list is highlighted.
- ▶ Select the contact.

### Enter geo-coordinates

Multimedia system:

↳ **Navigation** ▶  **Destination** ▶ **Geo-coordinates**

- ▶ Enter geo-coordinates as latitude and longitude coordinates in degrees, minutes and seconds.  
The map shows the relevant position.
- ▶ Confirm the entry.

- ▶ **To view or move a destination on the map:** select [Map](#).
- ▶ **To calculate a route:** select [Start Route Guidance](#).
- ▶ If a route has already been created, select [Start New Route Guidance](#) or [Set as Intermediate Destination](#).

### Selecting from the map

Multimedia system:

#### Navigation

- ▶ Press the Touch Control, the controller or the touchpad.  
The map menu appears.
- ▶ Select "move map" in map menu  
③ (→ page 249).
- ▶ Swipe in any direction on the Touch Control or touchpad.

or

- ▶ Slide the controller in any direction.  
The map moves in the corresponding direction under the crosshair. The more you move

- ▶ your finger away from the center on the touchpad, the faster the map moves.
- ▶ Press the Touch Control, the controller or the touchpad.  
If several destinations are located around the crosshair, a list shows the available POIs and roads.  
If a destination is located exactly on the crosshair, the destination address is displayed.
- ▶ Select a destination in the list.  
The destination address is shown.

### Showing traffic messages for the vicinity of the map

- ▶ Select [Traffic Messages for the Vicinity](#).  
The map appears.
  - ▶ Swipe left or right on the touchpad.
- or
- ▶ Slide the controller to the left or right.  
The previous or next traffic incident is highlighted on the map. Information on the traffic incident is displayed.

### Showing POIs in the vicinity of the map

- ▶ Select [Search in the Vicinity](#).
  - ▶ Swipe left or right on the touchpad.
- or
- ▶ Slide the controller to the left or right.  
The previous or next POI is highlighted on the map. Information (name, address, category) is displayed.
  - ▶ Alternatively, to filter the display by POI category: swipe down on the touchpad.
- or
- ▶ Slide the controller down.
  - ▶ Select a POI category.  
[User Defined](#) takes the "Select POI symbols" settings into consideration.



### Entering an intermediate destination

Multimedia system:

Navigation  >> Route  >> Destination Information  >> Search for an Intermediate Destination

- ▶ Enter an intermediate destination. Use the input options for entering a destination. The search results are displayed.
- ▶ Select an intermediate destination. The address of the intermediate destination appears.
- ▶ Select **Set as Destination**. The intermediate destination is entered in the destination information.
- ▶ Alternatively: select an intermediate destination via  **Destination** during route guidance.
- ▶ Select **Set as Next Intermediate Destination** after entering the destination.

### Calculating a route with intermediate destinations

#### Requirement:

Enter the destination and at least one intermediate destination.

Multimedia system:

Navigation  >> Route  >> Destination Information

- ▶ Select **Start New Route Guidance**. The route is calculated with the set intermediate destinations.

### Editing intermediate destinations

#### Requirement:

For "Changing the order of intermediate destinations": the destination and at least one intermediate destination have been entered.

Multimedia system:

Navigation  >> Route  >> Destination Information

### Changing the order of intermediate destinations

- ▶ Highlight the intermediate destination.
- ▶ Slide the controller to the left and select  **Move**.
- ▶ Move the intermediate destination to the desired position.
- ▶ Press the Touch Control, the controller or the touchpad.

### Deleting an intermediate destination

- ▶ Highlight the intermediate destination.
- ▶ Slide the controller to the left and select  **Delete**.

### Starting an automatic gas station search

#### Requirements

The automatic gas station search is activated  (→ page 242).

Route guidance is active. The fuel level in the fuel tank reaches the reserve fuel level.

The [Reserve Fuel Would you like to start a search for surrounding gas stations?](#) message is shown.

- ▶ Select **Yes**.  
The automatic gas station search begins. The available gas stations along the route or in the vicinity of the vehicle's current position are displayed.
- ▶ Select the gas station.  
The address of the gas station is displayed.
- ▶ Variant 1: If a route has not been calculated, select [Start Route Guidance](#).  
The selected gas station is set as the destination. Route guidance begins.
- ▶ Variant 2: If a route has been calculated, select [Start New Route Guidance](#) or [Set as Next Intermediate Destination](#).  
[Start New Route Guidance](#): The selected gas station is set as a new destination. The previous destinations and intermediate destinations are deleted. Route guidance to the gas station begins.

[Set as Next Intermediate Destination](#): The selected gas station is set as the next intermediate destination. Route guidance begins.

**If there are already four intermediate destinations:**

- ▶ Select **Yes** in the prompt.  
The selected gas station is entered into position 1 of the intermediate destinations menu. Intermediate destination 4 is deleted. Route guidance begins.

## Route

### Calculating a route

**Requirement:**

The destination is entered. The destination address is shown.



- ▶ Variant 1: if a route has not been calculated, select [Start Route Guidance](#).  
The route to the destination is calculated. The map shows the route. Route guidance then begins.

- ▶ Variant 2: if a route has been calculated, select [Start New Route Guidance](#) or [Set as Next Intermediate Destination](#).  
[Start New Route Guidance](#): the selected destination address is set as a new destination. The previous destinations and intermediate destinations are deleted. Route guidance to the new destination begins.  
[Set as Next Intermediate Destination](#): the selected destination address is set as the next intermediate destination. Route guidance begins.

### Taking alternative routes into consideration

- ▶ Select an alternative route (→ page 242).

### Other menu functions

- ▶ **To display on the map:** select  **Map**.
- ▶ **To call a telephone number:** select  **Call**.
- ▶ **To call up an Internet address:** select  **www** (if available).

## Selecting a route type

Multimedia system:

Navigation ► Route

- Select **Route Settings**.
- Select a route type.
 

A route has already been created: the route is calculated on the basis of the new route type.

A route has not been created: the next route is calculated on the basis of the new route type.

  - **Eco Route**  
An economical route is calculated. The journey time may be somewhat longer than for quicker routes.
  - **Fast Route**  
A route with a quick journey time is calculated.
  - **Short Route**  
A route with a short driving distance is calculated.

The dynamic route can be switched on  or off  for these route types. When the dynamic route is switched on, **Query Before Changing Dynamic Route** can be selected.

- **Dynamic Traffic Route**  
The route is calculated with the currently set route type.  
Traffic reports via Live Traffic Information are taken into account.
- **Query Before Changing Dynamic Route**  
A prompt appears when a new route is detected with a shorter journey time based on traffic reports. You can continue to use the current route or use the dynamic route instead.

## Selecting route options

Multimedia system:

Navigation ► Route ► Avoid Options

## Avoiding areas

- Select **Areas** (→ page 252).

## Avoiding highways, ferries, motorail trains, tunnels, unpaved roads

- Select  or deselect  avoid option.

## Using toll roads

- Select **Use Toll Roads**.
- Select **Cash** or **Electronic Billing** or **Off**.  
The route takes into account roads that require the payment of a usage fee (toll).  
If **Off** is selected, toll roads are not taken into account.

These route options are not available in every country.

The selected route options cannot always be implemented. Therefore, a route may include a ferry, for instance, even though the **Ferries** avoid option is enabled. A message appears and you will hear a corresponding message.

## Using carpool lanes

- Select **Number of Occupants in the Vehicle**.

- ▶ Select number.  
When using carpool lanes, observe the applicable legal requirements as well as any conditions pertaining to when and where such lanes may be used. Carpool lanes may only be used if certain conditions are met.

### Selecting notifications

Multimedia system:

Navigation ▶  Options ▶ Announcements

- ▶ Switch announcements on  or off .
  - **Announce Traffic Warnings**  
The function is not available in all countries.
  - **Announce Street Names**  
The multimedia system announces the names of the roads that will follow the upcoming change of direction.  
This function is not available in all countries and languages.

### Displaying destination information

#### Requirement:

A destination is entered. The route can also include up to four intermediate destinations.

Multimedia system:

Navigation ▶  Route

- ▶ Select **Destination Information**.

The following information is displayed:

- Intermediate destinations and destination
- Name, address
- Remaining driving distance
- Time of arrival

### Selecting an alternative route

Multimedia system:

Navigation ▶  Route

- ▶ Select **Alternative Route**.

The routes are displayed in accordance with the setting made in the route settings.

The currently selected route is shown with a dark blue line.

When the Eco route (economical route) is selected, the symbol for the current vehicle position is shown in green.

- ▶ Select an alternative route.

### Switching the automatic gas station search on/off

Multimedia system:

Navigation ▶  Options

- ▶ Activate  or deactivate  **Reserve Fuel**.  
Switched on : when the fuel reserve level is reached, a prompt appears asking whether you want to start searching for gas stations.

### Route guidance

#### Notes on route guidance

Route guidance begins once a route has been calculated.

The road and traffic rules and regulations always have priority over multimedia system driving recommendations.

Driving recommendations are:

- Navigation announcements

- Route guidance displays
- Lane recommendations

If you do not follow the navigation announcements or if you leave the calculated route, a new route is calculated automatically.

Driving recommendations may differ from the actual road and traffic conditions:

- If the route is diverted.
- If the direction of a one-way street has changed.

For this reason, you must always observe road and traffic rules and regulations during your journey.

The route may differ from the ideal route due to the following:

- Roadworks
- Incomplete digital map data

### Changing direction

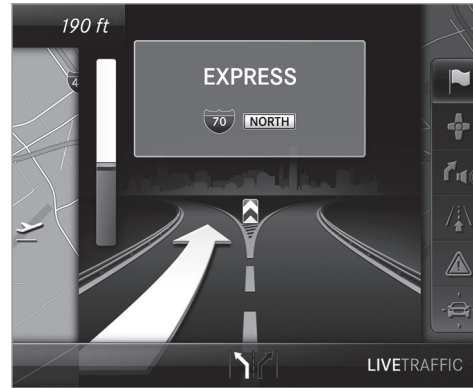

There are three phases when changing direction:

- Preparation phase  
The multimedia system prepares you for the upcoming change of direction, e.g. by announcing "Prepare to turn right". The map appears in full-screen mode.
- Announcement phase

The multimedia system announces the upcoming change of direction, e.g. by announcing "Turn right in 200 meters".

The display is split into two parts. The map is displayed on the left; on the right, there is a detailed image of the intersection or a 3D image of the upcoming change of direction.

- Change-of-direction phase

The multimedia system announces the imminent change of direction with the announcement "Now turn right".

The display is split into two parts.

The vehicle has successfully changed direction when the light-colored bar on the right drops down to 0 feet (0 meters) and the current vehicle position symbol has reached the white change-of-direction point.

When the change of direction is complete, the map appears in full-screen mode.

- ① Changes of direction are also shown in the Instrument Display.

### Lane recommendations

This display appears for multi-lane roads.

If the digital map contains the relevant data, the multimedia system can display lane recommendations for the next two changes of direction.



- ① Lanes not recommended
- ② Recommended lane
- ③ Possible lane
- Lane not recommended ①

In this lane, you will not be able to complete the next change of direction without changing lanes.

- Recommended lane ②  
In this lane, you will be able to complete both the next change of direction and the one after that.
  - Possible lane ③  
In this lane, you will only be able to complete the next change of direction. The lane appears as a gray arrow.
  - Approaching new lane  
During the change of direction, new lanes may be added.
- ① Lane recommendations can also be displayed in the Instrument Display and in the Head-up Display.

#### Destination reached

Once the destination is reached, you will see the chequered flag. Route guidance is finished.

When an intermediate destination has been reached, you will see the intermediate destina-

tion flag with the number of your intermediate destination. After this, route guidance is continued.

#### Switching navigation announcements on/off

##### Requirements :

- A route has already been created
- Route guidance is active

▶ **To switch off:** during a navigation announcement, press the  button on the multi-function steering wheel.

The **Spoken driving recommendations have been deactivated.** message appears.

▶ **To switch on:** display the Navigation menu.

▶ Select **Driving Recommendation**.

In the following situations, navigation announcements are switched on automatically:

- The route is recalculated.
- The multimedia system is switched off and then on again.
- The vehicle is restarted.



-  You can access and add this function as a favorite under [Spoken Driving Recommendations On/Off](#).

### Switching navigation announcements on/off during a phone call

- ▶ Select [System](#).
- ▶ Select  [Audio](#).
- ▶ Switch [Driving Recommendations During Phone Call](#) on  or off .

### Adjusting the volume of navigation announcements

#### Requirements:

- A route has already been created
  - Route guidance is active
- ▶ Press the  or  button on the multi-function steering wheel during a navigation announcement.
- or
- ▶ Turn the controller on the right beside the touchpad.

-  When you start the vehicle, the volume is set to the lowest setting.

- ▶ **Alternatively:** select [System](#).
- ▶ Select  [Audio](#).
- ▶ Select [Driving Recommendation Volume](#).
- ▶ Set the volume.

### Switching audio fadeout on/off during navigation announcements

- ▶ Select [System](#).
- ▶ Select  [Audio](#).
- ▶ Switch [Audio Fadeout During Driving Recommendation](#) on  or off .

### Repeating navigation announcements

#### Requirements:

- A route has already been created
- Route guidance is active

Multimedia system:

↳ [Navigation](#)

- ▶ Select [Driving Recommendation](#).  
The current navigation announcement is repeated.

-  You can access and add this function as a favorite under [Repeat Spoken Driving Recommendation](#).

### Canceling route guidance

#### Requirements:

- A route has already been created.
- Route guidance is active.

Multimedia system:

↳ [Navigation](#) ▶  [Destination](#)

- ▶ Select [Cancel Route Guidance](#).

### Resuming route guidance

#### Requirements:

- A route has already been created
- Route guidance is interrupted

- ❶ If the journey was interrupted for less than 2 hours, route guidance continues automatically.

Multimedia system:

Navigation ►► Destination

- Select **Continue Route Guidance**.  
The route is recalculated.

### Route guidance to an off-road destination

Off-road destination: the destination is within the digital map. However, the map contains no roads that lead to the destination.

You can enter off-road destinations on the map. Route guidance guides you for as long as possible with navigation announcements and displays on roads that are known to the multimedia system.

Shortly before you reach the last known position on the map, you will hear the "Please follow the direction arrow" announcement. The display shows a direction arrow and the linear distance to the destination.

### Route guidance from an off-road location to a destination

Off-road position: the current vehicle position is located within the digital map on roads that are not available.

The following displays appear when route guidance begins:

- The **Road Not Mapped** message
- A direction arrow showing the linear direction to the POI

When the vehicle is back on a road known to the multimedia system, route guidance continues as normal.

### Off-road status during route guidance

Due to roadworks, for example, there may be differences between the data on the digital map and the actual course of the road. In such cases, the multimedia system will temporarily be unable to locate the vehicle's current position on the digital map. The vehicle is off-road.

The following displays appear when the vehicle is off-road:

- The **Road Not Mapped** message

- A direction arrow showing the linear direction to the POI

When the vehicle is back on a road known to the multimedia system, route guidance continues as normal.

## Destination

### Saving the current vehicle position

Multimedia system:

Navigation ►► Position

- Select **Save Position**.  
The current vehicle position is saved to the "Last destinations" memory.

### Storing a map position

Multimedia system:

Navigation

The map is in full-screen mode.

- Press the Touch Control, the controller or the touchpad.
- Select "move map" in the map menu (→ page 249).







- ▶ Select a position on the map.
- ▶ Select  **Save Position**.  
The map position is saved to the "Last destinations" memory.

### Editing the last destinations

Multimedia system:

 **Navigation** ▶ **Destination** ▶ **Previous**

#### Destinations

- ▶ Highlight one of the last destinations.
- ▶ **To save as a favorite:** Select  **Save as Global Favorite**.
- ▶ **To save as "Home" address:** Select  **Save as "Home"**.
- ▶ **To save as "Work" address:** Select  **Save as "Work"**.
- ▶ **To display destination information:** Select  **Details**.
- ▶ **To delete a single or all destinations:**  
Select  **Delete** or **Delete All**.  
A prompt appears.
- ▶ Select **Yes**.

### Route guidance with current traffic reports

#### Traffic information overview

Traffic reports are received using Live Traffic Information and are used for the route guidance.

- ⓘ There may be differences between the traffic reports received and the actual road and traffic conditions.

Important information on Live Traffic Information

- Current traffic reports are received via the Internet connection.
- The traffic situation is updated at short, regular intervals.
- The subscription service is free of charge for three years from the manufacturing date.  
The status of the subscription can be displayed (→ page 247).

The vehicle's positional information is regularly sent to Daimler AG. The data is immediately rendered anonymous by Daimler AG and forwarded to the traffic data provider. Using this data, traffic reports relevant to the vehicle's position are sent to the vehicle. The vehicle acts as a sensor

for the flow of traffic and helps to improve the quality of the traffic reports.

If you do not wish to transmit your vehicle position, you can have this service deactivated at an authorized Mercedes-Benz Center.

#### Displaying subscription information

##### Requirement:

- The vehicle is equipped with Live Traffic Information.

Multimedia system:

 **Navigation** ▶  **Options**

The subscription expiry date is automatically displayed:

- One month before the expiry date.
- One week before the expiry date.
- On the expiry date.

▶ **To display manually:** Select [Live Traffic Subscription Info](#).

Depending on the status, one of the following messages appears:

- The period of validity for the subscription is displayed.
  - The subscription has expired.
- ⓘ The subscription can be extended:
- At any authorized Mercedes-Benz Center
  - Via an MB Info call to the Mercedes-Benz Customer Assistance Center

### Displaying the traffic map

#### Requirements:

- For Live Traffic Information: the vehicle is equipped with a communication module featuring an activated, integrated SIM card.
- When the vehicle is started, the communication module automatically establishes an Internet connection. Traffic information is made available shortly afterwards.

Multimedia system:

↳ [Navigation](#)

- ▶ Press the Touch Control, the controller or the touchpad.

or

- ▶ Select [Map Menu](#).  
The map menu appears.

- ▶ Select .

The traffic map can show the following information:

- Traffic incidents, e.g.:
  - Roadworks
  - Road blocks
  - Warning messages

The symbols for traffic incidents are displayed in color (on the route) or gray (off the route).

- Traffic flow information:
  - Traffic jam (red line)
  - Slow-moving traffic (yellow line)
  - Free-flowing traffic (green line)

- Display for traffic delays on the route lasting at least one minute

- Warning message symbols:

-  symbol
- Additional road safety note when approaching a traffic incident, e.g. approaching tailback

If the vehicle approaches a hazard spot on the route, a warning message is displayed on the map. A warning message may also be issued (→ page 249).

### Displaying traffic incidents

Multimedia system:

↳ [Navigation](#) ▶  [Options](#) ▶ [Map Content](#)

- ▶ Activate  [Traffic Incidents](#).  
Roadworks, road blocks, local area reports (e.g. fog) and warning messages are displayed.

### Activating free flow and traffic delay

- ▶ Activate  [Free Flow](#) and [Traffic Delays](#).

- ❶ The traffic delay is displayed for the current route. Traffic delays lasting one minute or longer are taken into consideration.

### Displaying details

- ▶ Display the traffic map (→ page 248).
- ▶ Move the map (→ page 250).
- ▶ **Variante 1:** When a traffic report symbol is under the crosshair, press the touchpad or the controller. The traffic report details are displayed.
- ▶ **Variante 2:** Press the touchpad or the controller.
- ▶ Select [Traffic Messages for the Vicinity](#). The map shows the traffic report symbols in the vicinity. Traffic report information is displayed in the status line:
  - Traffic report symbol
  - Reason for the traffic report, e.g. traffic jam
  - Warning message (highlighted in red)

- ▶ **To select a traffic report symbol:** Select [Next](#) or [Previous](#).
- ▶ Press on the touchpad or controller. The traffic report details are displayed.

### Issuing hazard alerts

Multimedia system:

→ [Navigation](#) ▶  [Options](#) ▶ [Announcements](#)

- ▶ Activate  [Announce Traffic Warnings](#). Warning messages are issued and approaching tailbacks which pose a risk are announced.

## Map and compass

### Map and compass overview

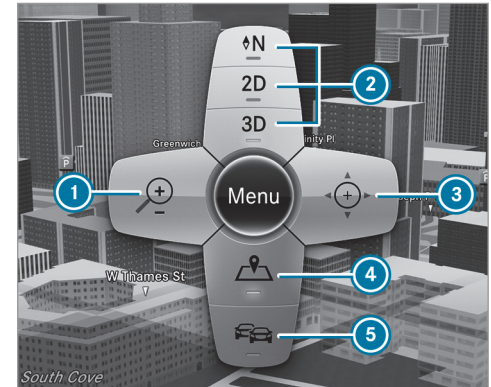

- ① To set the map scale
- ② To select the map orientation and map view
- ③ To move the map
- ④ To call up the navigation map
- ⑤ To call up the traffic map

The map and satellite images are shown in globe projection. This allows for a realistic map display in all map scales. The map uses elevation modeling.

In small map scales (1/32 mi (20 m), 1/16 mi (50 m), important buildings are depicted realistically on the map in many cities; other buildings are shown as models.

If available, fuel prices and the availability of parking spaces in parking garage are displayed, for example.

 Company logos displayed on the map are trademarks of the respective companies and used solely for the purpose of indicating the locations of these companies. The use of such logos on the map does not indicate approval of, support of or advertising by these companies for the navigation system itself.

### Setting the map scale

Multimedia system:

 [Navigation](#)

The map is in full-screen mode.

 Press the Touch Control, the controller or the touchpad.

or

 Select [Map Menu](#).

The map menu appears.

 Select "Set map scale" in map menu

 (→ page 249).

The map scale appears with the currently selected scale.

Vehicles for right-side traffic: the map always shows the currently selected map scale at the bottom left.

Vehicles for left-side traffic: the map always shows the currently selected map scale at the bottom right.

 Swipe up or down on the Touch Control or the touchpad.

or

 Move two fingers apart or together on the touchpad.

or

 Slide the controller up or down.

### Moving the map

Multimedia system:

 [Navigation](#)

The map is in full-screen mode.

 Press the Touch Control, the controller or the touchpad.

or

 Select [Map Menu](#).

The map menu appears.

 Select "move map" in map menu

 (→ page 249).

 Swipe in any direction on the Touch Control or touchpad.

or

 Slide the controller in any direction. The map moves in the corresponding direction under the crosshair. The more you move your finger away from the center on the touchpad, the faster the map moves.

### Selecting the map orientation

Multimedia system:

↳ Navigation

The map is in full-screen mode.

▶ Press the Touch Control, the controller or the touchpad.

or

▶ Select **Map Menu**.

The map menu appears.

▶ In map menu ②, select **N**, **2D** or **3D** (→ page 249).

- **N** The map is aligned in 2D and displayed so that north is up.
- **2D** The map is aligned in 2D and displayed in the direction of travel.
- **3D**: The map is aligned in 3D and displayed in the direction of travel.

### Selecting POI symbols

Multimedia system:

↳ Navigation ▶  Options ▶ Map

Content

POIs include gas stations and hotels, for example. These can be displayed as symbols on the map. Not all POIs are available everywhere.

▶ Select **POI Symbols**.

The ● dot indicates the current setting.

**Standard** displays symbols of predefined categories in the map.

**User Defined** allows you to personally select the symbols for the available categories.

**None** switches the display off.

▶ Select the setting.

▶ Select categories.

The POI symbols of the selected categories are displayed  or not displayed .

### Selecting text information

Multimedia system:

↳ Navigation ▶  Options ▶ Text

Information

▶ Select the setting.

**Current Street** shows the street you are currently driving on at the bottom of the display.

When the map is moved, the street name, the POI name or the area name appears under the crosshair.

**Geo-coordinates** displays the following information:

- Longitude and latitude
- Elevation  
The elevation shown may deviate from the actual elevation.
- Number of satellites from which a signal can be received  
When the map is moved, this information does not appear.

**None** switches the display off.

### Displaying the next intersecting street

Multimedia system:

Navigation  Options

- ▶ Activate  or deactivate  **Next Intersecting Street**.

The function is activated : if route guidance is not active, the name of the next intersecting street is displayed on the top edge of the screen.

### Displaying traffic signs on the map

#### Requirement:

The vehicle is equipped with Traffic Sign Assist.

Multimedia system:

Navigation  Options

- ▶ Activate  or deactivate  **Traffic Sign**. If the function is switched on  you will see the traffic signs recognized by Traffic Sign Assist.

The following traffic signs are displayed:

- Speed limitations
- Overtaking restrictions

- Traffic signs with a restriction indicated by an additional sign (e.g. in wet conditions)

### Displaying the map version

Multimedia system:

Navigation  Options

- ▶ Select **Map Version**.
- ▶ Select **Details**.

 Information about new versions of the digital map can be obtained from an authorized Mercedes-Benz Center.

### Avoiding an area

You can define areas along a route that you would like to avoid.

### Avoiding a new area

Multimedia system:

Navigation  Route  **Avoid**  
Options  **Areas**

- ▶ Select **Avoid New Area**.
- ▶ Select **Using Map** or **Address Entry**.  
**Using Map**: the map appears with the crosshair.

**Address Entry**: the address can be entered.

When an address is entered and confirmed via **Adopt destination** the map also appears with a crosshair.

- ▶ Press the Touch Control, the touchpad or the controller.  
A red rectangle appears. This designates the area that should be avoided.
- ▶ **To change the size of the area**: Swipe up or down on the Touch Control or the touchpad.

or

- ▶ Slide the controller up or down.  
The map scale is enlarged or reduced and changes the size of the area.
- ▶ Press the Touch Control, the controller or the touchpad.  
The area is set.

### Changing an area

Multimedia system:

Navigation  Route  **Avoid**  
Options  **Areas**

- ▶ Highlight an area in the list.

- ▶ Select  **Edit**.

#### Moving the area on the map

- ▶ Swipe in any direction on the Touch Control or touchpad.
- or
- ▶ Slide the controller in any direction.

#### Changing the size of the area

- ▶ Press the Touch Control, the touchpad or the controller.
- ▶ Swipe up or down on the Touch Control or the touchpad.
- or
- ▶ Slide the controller up or down.
- ▶ Press the Touch Control, the touchpad or the controller.

#### Taking the area for the route into account

- ▶ Avoid  or do not avoid  an area in the list.  
Route guidance active: a new route is calculated.

No route has been created: the setting is carried over to the next route guidance.



The route can include an area that is to be avoided in the following cases:

- The destination is located in an area that is to be avoided
- There is no sensible alternative route

#### Deleting one or all areas

Multimedia system:

 **Navigation** ▶  **Route** ▶ **Avoid Options** ▶ **Areas**

- ▶ Highlight an area in the list.
- ▶ Select  **Delete** or  **Delete All**.
- ▶ Confirm the prompt with **Yes**.  
One or all areas are deleted.

#### Updating the map data free of charge

##### Availability of the free update

In some countries, it is possible to update the multimedia system's map data free of charge for a period of three years. Information on the availability of this service for your vehicle can also be

obtained from an authorized Mercedes-Benz Center.

##### Entitlement to the free update

For the first three years after initial registration of your vehicle, you are entitled to all available updates to the map data for the multimedia system. After this period, you can purchase further updates from an authorized Mercedes-Benz Center. This does not apply in all countries.

The free updates relate to the vehicle and not to an individual. If there is a change of ownership within the three years after initial registration, the new owner is entitled to the map data updates.

##### Updating at an authorized Mercedes-Benz Center

If an update for your map data is available, it will be installed in your vehicle free of charge at an authorized Mercedes-Benz Center as part of your vehicle's annual service.

The update is performed only at an authorized Mercedes-Benz Center. The map data is not provided on a data storage medium.

**Map data**

Your vehicle is supplied with map data at the factory. Depending on the country, map data for your region is either pre-installed or the map data is supplied on a data storage medium. You do not require an activation code for the map data which is provided with your vehicle.

If the map data on your vehicle has been installed at the factory and you wish to reinstall it, you do not need to enter the activation code.

An activation code is required for purchased map data.

The activation code:

- Can be used in one vehicle
- Is non-transferable
- Has six digits

Please contact an authorized Mercedes-Benz Center if you are experiencing the following problems:

- The multimedia system does not accept the activation code.
- You have lost the activation code.

**Displaying the compass**

Multimedia system:

Navigation ► Position

► Select **Compass**.

The compass display shows the following information:

- The current direction of travel with bearing (360 degree format) and compass direction
- Longitude and latitude coordinates in degrees, minutes and seconds
- Height (rounded) above sea level
- Number of GPS satellites from which a signal can be received

**Displaying the satellite map**

Multimedia system:

Navigation ► Options ► Map Content

Satellite maps can be displayed in map scales from 2 mi (2 km).

- Activate  or deactivate  **Satellite Map**. By doing so, satellite maps in map scales from 2 mi (2 km) to 10 mi (10 km) can be switched off.

ⓘ Satellite maps for these map scales are not available in all countries.

**Displaying weather information**

Multimedia system:

Navigation ► Options ► Map Content

- Activate  or deactivate  **Weather Information**.

When the function is activated , current weather information is displayed on the navigation map, e.g. temperature or cloud coverage.

This function is not available in all countries.



## Calling up the Digital Operator's Manual (navigation)

### Information on navigation

Multimedia system:

→ Navigation → Navigation Info

▶ Select a topic.



## Telephone

### Telephony

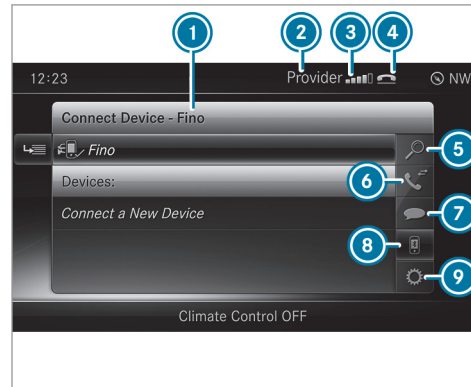
#### Telephone menu overview



- ❶ Bluetooth® device name of the currently connected mobile phone
- ❷ Mobile phone network provider
- ❸ Signal strength of the mobile phone network

- ❹  (telephone ready) or  (call active)
- ❺ Contacts (→ page 260)
- ❻ Call list (→ page 262)
- ❼ Text messages (→ page 262)
- ❽ To connect the device (→ page 257)
- ❾ Options

The Bluetooth® interface is available to you for telephony. The mobile phone is connected directly via the multimedia system.

Symbols ❶ to ❹ are not shown until after a mobile phone has been connected to the multimedia system. The symbols depend on your mobile phone and your mobile phone network provider.

If the mobile phone connected supports the MAP Bluetooth® profile (Message Access Profile), the  menu item is available.

### Notes on telephony

**⚠ WARNING** Risk of distraction from operating integrated communication equipment while the vehicle is in motion

If you operate communication equipment integrated in the vehicle when driving, you will be distracted from the traffic situation. This could also cause you to lose control of the vehicle.

- ▶ Only operate this equipment when the traffic situation permits.
- ▶ If you cannot be sure of this, stop the vehicle whilst paying attention to road and traffic conditions and operate the equipment with the vehicle stationary.

**⚠ WARNING** Risk of distraction from operating mobile communication equipment while the vehicle is in motion

If you operate mobile communication equipment when driving, you will be distracted from the traffic situation. This could also cause you to lose control of the vehicle.

Only operate this equipment when the vehicle is stationary.

You must observe the legal requirements for the country in which you are currently driving when operating mobile communication equipment in the vehicle.

Telephony is possible via:

- The Bluetooth® interface

#### Bluetooth® profile overview

Bluetooth® profile of the mobile phone	Function
PBAP (Phone Book Access Profile)	Contacts are automatically displayed in the multimedia system
MAP (Message Access Profile)	Message functions can be used

Further information can be obtained from an authorized Mercedes-Benz Center or at: <http://www.mercedes-benz.com/connect>.

#### HD Voice®

- To improve voice quality, the multimedia system supports telephone calls in HD Voice®.
- In order to use this function, the mobile phones and the mobile phone network provider of the person you are calling must support HD Voice®.

Depending on the quality of the connection, the voice quality may fluctuate.

The following situations can lead to the call being disconnected while the vehicle is in motion:

- There is insufficient network coverage in the area
- You move from one GSM or UMTS transmitter/receiver area (cell) into another and no communication channels are free
- The SIM card used is not compatible with the network available
- A mobile phone with "Twincard" is logged into the network with the second SIM card at the same time

## Connecting a mobile phone (authorizing)

### Requirements

Bluetooth® is activated on the mobile phone (see the manufacturer's operating instructions).

Bluetooth® is activated on the multimedia system (→ page 228).

Multimedia system:

→ Phone ►  Connect Device - No Device Connected

### Searching for a mobile phone

- ▶ Select **Connect New Device**.
- ▶ Select **Start Search**.  
The available mobile phones are displayed. If a new mobile phone is found, it is indicated by the  symbol.

### Connecting a mobile phone (authorization using Secure Simple Pairing)

- ▶ Select the mobile phone.  
A code is displayed in the multimedia system and on the mobile phone.

- ▶ **If the codes match:** confirm the code on the mobile phone.

### Connecting a mobile phone (authorization by entering a passkey)

- ▶ Select the Bluetooth® name of the mobile phone.
- ▶ Choose a one to sixteen-digit number combination as a passkey.
- ▶ **Multimedia system:** enter the passkey and select .
- ▶ **Mobile phone:** enter the passkey again and confirm.

- ⓘ Up to 15 mobile phones can be authorized on the multimedia system.  
All telephones are automatically reconnected.

### Disconnecting a mobile phone (de-authorizing)

Multimedia system:

→ Phone ►  Connect Device - Mobile phone

- ▶ Select the mobile phone from the device list.

- ▶ Select .
- ▶ Select **Deauthorize**.
- ▶ Select **Yes**.

### Switching mobile phones

#### Requirement

The mobile phones are connected (authorized) (→ page 257).

Multimedia system:

→ Phone ►  Connect Device - Mobile phone

- ▶ Select the mobile phone from the device list.
- ⓘ Only one mobile phone can be connected at any one time. The connected mobile phone is displayed at the top of the list.

### Using the mobile phone with Near Field Communication (NFC)

#### Requirements:

- NFC is activated on the mobile phone (see the manufacturer's operating instructions).

- The mobile phone's screen is switched on and unlocked (see the manufacturer's operating instructions).

NFC enables short-range wireless data transfer.

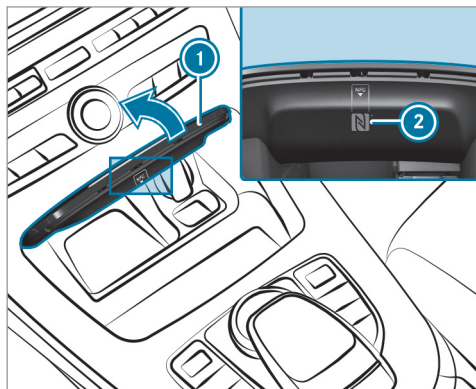

- ▶ **To connect a mobile phone:** open stowage compartment cover ①.

- ▶ Lightly press NFC area ② on the inside of the cover.  
The mobile phone is connected to the multimedia system.

- ▶ **To switch mobile phones:** lightly press the NFC area of the mobile phone (see the manufacturer's operating instructions).  
If the mobile phone has already been authorized on the multimedia system, it is now connected.

If the mobile phone is authorized on the multimedia system for the first time, it is connected after confirming the mobile phone instructions (see the manufacturer's operating instructions).

Further functions without having a mobile phone authorized on the multimedia system:

- Transferring a contact or a business card, e.g. for direct navigation to an entered address.
- Transferring a URL to the enlarged view in the multimedia system.

### Setting the reception and transmission volume

#### Requirement:

A mobile phone is authorized (→ page 257).

Multimedia system:

☛ Phone ▶ ☑ Connect Device - Mobile phone

This function ensures optimal language quality.

- ▶ Highlight the mobile phone in the device list.
- ▶ Select ☑.
- ▶ Select **Reception Volume** or **Transmission Volume**.
- ▶ Set the volume.

Further information on the recommended reception and transmission volume: <http://www.mercedes-benz.com/connect>

### Adjusting the call and ringtone volume

Multimedia system:

☛ System ▶ ☑ Audio

- ▶ Select **Call Volume** or **Ringer Volume**.
- ▶ Set the volume.

### Starting/stopping mobile phone voice recognition

#### Requirement:

the mobile phone is connected to the multimedia system (→ page 257).

#### Starting mobile phone voice recognition

- ▶ Press and hold the  button on the multi-function steering wheel for more than one second.  
You can use mobile phone voice recognition.

#### Stopping mobile phone voice recognition

- ▶ Press the  or  button on the multi-function steering wheel.

## Calls

### Using the telephone

Multimedia system:

→ Phone →  Contacts

### Making a call

- ▶ Enter a number.

- ▶ Select **Dial Number**.  
The call is made.

### Accepting a call

- ▶ Select **Accept**.

### Rejecting a call

- ▶ Select **Reject**.

### Ending a call

- ▶ Select .

### Activating functions during a call

- ▶ To show all functions, navigate down.

The following functions are available during a call:

- End a call
- Make another call
- Show keyboard (to send DTMF tones)
- Switch the microphone on/off
- Switch on private mode (an active call in hands-free mode is transferred over to the telephone)

### Conducting calls with several participants

#### Requirements:

- There is an active call (→ page 259).
- Another call is being made.

#### Switching between calls

- ▶ Select call ●.  
The selected call is active. The other call is on hold.

#### Activating or ending a call on hold

- ▶ Select **Continue Call** or **End Call**.

#### Conducting a conference call

- ▶ Select **Create Conference Call** in the telephone menu.  
The new participant is included in the conference call.

#### Ends an active call

- ▶ Select .
- ⓘ On some mobile phones, the call on hold is activated as soon as the active call is ended.

### Incoming call during an existing call (call waiting)

#### Requirement:

There is an active call (→ page 259).

If you receive a call while already in a call, a message is displayed. An acoustic signal also sounds.

- ▶ Select **Accept**.  
The incoming call is active. The previous call is on hold.
- ▶ Select **Reject**.
- ⓘ This function and behavior depends on your mobile phone network provider and the mobile phone (see the manufacturer's operating instructions).

### Contacts

#### Information about the contacts menu

The contacts menu contains all contacts from existing data sources, e.g. mobile phone or memory card.

It is possible to store up to 6,000 contacts:

- 3,000 entries are for permanently saved contacts.
- 3,000 for contacts loaded from the mobile phone.

From the contacts menu, you can perform the following actions:

- Telephone operation (→ page 261)
- Navigation
- Writing messages (→ page 261)

If a mobile phone is connected to the multimedia system (→ page 257) and automatic retrieval (→ page 260) is activated, the mobile phone's contacts are displayed in the address book.

#### Downloading mobile phone contacts

Multimedia system:

☛ Phone ▶ ⚙ Options ▶ Open Contacts Automatically

#### Automatically

- ▶ Allow automatic download .

#### Manual

- ▶ Deactivate automatic download .
- ▶ Select **Open Contacts Automatically**.

#### Calling up contacts

Multimedia system:

☛ Phone ▶ 🔍 Contacts

The following options can be used to search for contacts:

- search by initials
  - search by name
  - search by phone number
  - ▶ Enter characters into the search field.  
A selection of possible contacts appears. Entering more characters into the search field narrows down the number of possible selections.
  - ▶ Select the contact.
- A contact can contain the following details:
- phone numbers
  - navigation addresses
  - geo-coordinates

### Editing the format of a contact's name

Multimedia system:

Phone ▶ Options ▶ Name Format

The following options are available:



- Last Name, First Name
- Last Name First Name
- First Name Last Name

▶ Select an option.

### Importing contacts into the contacts menu

Via Options, you can import contacts into the telephone book as electronic business cards from different sources.



### Overview of importing contacts as electronic business cards

Source	Requirements
 Memory card	The SD memory card is inserted.
 USB device	The USB device is inserted into the USB port.
 Bluetooth® connection	If the sending of vCards is supported via Bluetooth®, vCards can be received on mobile phones or netbooks, for example.  Bluetooth® is activated in the multimedia system and on the respective device (see the manufacturer's operating instructions).

### Saving a mobile phone contact

Multimedia system:

Phone ▶ Contacts

- ▶ Call up a mobile phone contact  (→ page 260).
- ▶ Select .
- ▶ Select **Save to Vehicle**.  
The contact saved in the multimedia system is identified by the  symbol.

### Calling a contact

Multimedia system:

Phone ▶ Contacts

- ▶ Enter characters into the search field.
- ▶ Select the contact.
- ▶ Select a telephone number.  
The number is dialed.

### Further options in the contacts menu

Multimedia system:

Phone ▶ Contacts

- ▶ Select .

The following options are available:

- [Contact Details](#)
- [Save to Vehicle](#)
- [Delete Contact](#)

### Within contact details

▶ Select .

The following options are available:

- Calling a contact.
- Sending a text message.
- Saving a contact as a global favorite.
- Displaying a website (when a web address is stored).
- Navigating to an address (when an address is stored).
- Sending DTMF tones (for a number with DTMF tones).

### Deleting a name

Multimedia system:

➔ [Phone](#) ➔  [Contacts](#)

You can delete contacts that are not automatically downloaded.

- ▶ Search for a contact.
- ▶ Select the contact.
- ▶ Select .
- ▶ Select [Delete Contact](#).
- ▶ Select [Yes](#).

### Call list

#### Call list overview

If your mobile phone supports the PBAP Bluetooth® profile, the call lists from the mobile phone are displayed in the multimedia system. When connecting the mobile phone, you may have to confirm the connection for the PBAP Bluetooth® profile.

If your mobile phone does not support the PBAP Bluetooth® profile, the multimedia system generates its own call lists. These are not the same as the call lists in your mobile phone.

If the contact for an incoming call has yet to be saved in the multimedia system, you can use the call list to save the telephone number.

### Making a call from the call list

Multimedia system:

➔ [Phone](#) ➔  [Call List - Mobile phone](#)

- ▶ Select an entry.
- ▶ Make the call.

### Options in the call list

Multimedia system:

➔ [Phone](#) ➔  [Call List - Mobile phone](#)

- ▶ Highlight the entry.
- ▶ Select .

The following functions are available:

- [Send Text Message](#)
- [Open Contact](#)

### Text messages

#### Notes on the text message functions

If the connected mobile phone supports the MAP Bluetooth® profile, the text message functions can be used on the multimedia system.

You can obtain further information about settings and supported functions of Bluetooth®-



capable mobile phones from an authorized Mercedes-Benz Center or at: <http://www.mercedes-benz.com/connect>

Some mobile phones require further settings after being connected to the multimedia system (see the manufacturer's operating instructions).

New messages are identified by the  symbol in the multimedia system's display and an audible signal.

- The multimedia system displays the 100 newest text messages.
- The  symbol is displayed when the mobile phone's message memory is full.

### Configuring the text messages displayed

Multimedia system:

➤ Phone ➤  Options ➤ Open Messages

➤ Select .

A menu with the following options is shown:

- All Messages
- New and Unread Messages
- New Messages

- Off (The text messages are not displayed automatically.)

➤ Select an option.

### Reading text messages



Multimedia system:

➤ Phone ➤  Text Message

### Reading a text message

- Select a text message.
- The message text is displayed.

### Using the read-aloud function

- Select a text message.
- Select .
- Select .
- The text message is read aloud.

### Composing and sending a text message

Multimedia system:

➤ Phone ➤  Text Message

- Navigate to the left twice.
- Select **Write New Text Message**.

### Dictating text

- Select **Press to Dictate**.  
The App for the dictation function is loaded.  
If there was no prior Internet connection, a connection is now established.
- To start the dictation function: press the controller or touchpad.
- Say your message.  
The dictation ends automatically after you have finished speaking.  
After the voice message has been processed, it is shown as text.

### Editing text

- Select the word.
- To call up the correction menu: press the controller or touchpad.  
The following options are available:
  - Adjusting the capitalization of words (if supported by the character set)
  - Expanding the choice of words
  - Deleting the selection

- Recording a new dictation
- ▶ To leave the menu: select **Done**.

### **Sending text messages**

- ▶ Select **Send Text Message**.

### **Replying to a text message**

Multimedia system:

➤ Phone ➤  Text Message

- ▶ Select a text message.
- ▶ Select .
- ▶ Select **Reply**.

### **Calling a text message sender**

Multimedia system:

➤ Phone ➤  Text Message

- ▶ Select a text message.
- ▶ Select .
- ▶ Select **Call Sender**.

### **Deleting text messages**

Multimedia system:

➤ Phone ➤  Text Message

- ▶ Select .
- ▶ Select **Delete**.

### **Apple CarPlay™**

#### **Overview of Apple CarPlay™**

iPhone® functions can be used via the multimedia system using Apple CarPlay™. It is operated using the controller or the Siri® voice-operated control system.

Only one mobile phone at a time can be connected via Apple CarPlay™ to the multimedia system.

While using Apple CarPlay™, various functions of the multimedia system, e.g. the navigation, are not available.

The availability of Apple CarPlay™ may vary according to the country.

The service provider is responsible for this application and the services and content connected to it.

### **Connecting an iPhone® via Apple CarPlay™**

#### **Requirements**

- Apple CarPlay™ can be used with Apple operating system version iOS 8.3 or above.
- The full range of functions for Apple CarPlay™ is only possible with an Internet connection.

Multimedia system:

➤ Connect ➤ **Apple CarPlay**

#### **Activating automatic start**

- ▶ Select **Start Automatically** .

#### **Starting automatically**

- ▶ Connect your iPhone® to the USB port  on the multimedia system using a suitable cable (→ page 280).

#### **Starting manually**

- ▶ Select the iPhone® in the device list.

**Exiting Apple CarPlay™**

- ▶ Select  in Apple CarPlay™.

**Calling up Apple CarPlay™ tone settings**

Multimedia system:

↳ **Connect** ▶▶ **Apple CarPlay** ▶▶ **Sound**

- ▶ Select the tone menu (→ page 296).

**Ending Apple CarPlay™**

Multimedia system:

↳ **Connect** ▶▶ **Apple CarPlay**

- ▶ Select **Disconnect**.  
The connection is ended.  
The mobile phone continues to be supplied with electricity.

or

- ▶ Disconnect the connecting cable between the mobile phone and multimedia system.

**Android Auto™****Android Auto™ overview**

Mobile phone functions can be used with Android Auto™ using the Android™ operating

system on the multimedia system. It is operated using the controller or the voice-operated control system.

Only one mobile phone at a time can be connected via Android Auto™ to the multimedia system.

While using Android Auto™, various functions of the multimedia system, e.g. the navigation, are not available.

The availability of Android Auto™ and Android Auto™ Apps may vary according to the country.

The service provider is responsible for this application and the services and content connected to it.

**Connecting a mobile phone via Android Auto™****Requirements**

- The first activation of Android Auto™ on the multimedia system must be carried out when the vehicle is stationary for safety reasons.
- The mobile phone supports Android Auto™ from Android™ 5.0.
- The Android Auto™ App is installed on the mobile phone.

- In order to use the telephone functions, a mobile phone must be connected to the multimedia system via Bluetooth® (→ page 257).

If there was no prior Internet connection, this is established with the use of the mobile phone with Android Auto™.

- The full range of functions for Android Auto™ is only possible with an Internet connection.

Multimedia system:

↳ **Connect** ▶▶ **Android Auto**

**Activating automatic start**

- ▶ Select **Start Automatically** .

**Starting automatically**

- ▶ Connect your mobile phone to the  USB port on the multimedia system using a suitable cable (→ page 280).

**Starting manually**

- ▶ Select the mobile phone from the device list.

**Exiting Android Auto™**

- ▶ Press the  button.

### Calling up the Android Auto™ tone settings

Multimedia system:

→ Connect ▶ Android Auto ▶ Sound

- ▶ Select the tone menu (→ page 296).

### Ending Android Auto™

Multimedia system:

→ Connect ▶ Android Auto

- ▶ Select **Disconnect**.  
The connection is ended.  
The mobile phone continues to be supplied with electricity.

or

- ▶ Disconnect the connecting cable between the mobile phone and multimedia system.

### Transferred vehicle data when using Apple CarPlay™ and Android Auto™

#### Notes on transferred vehicle data

When using Android Auto™ or Apple CarPlay™, certain vehicle data is transferred to the mobile phone. This enables you to get the best out of

selected mobile phone services. Vehicle data is not directly accessible.

System information:

- Vehicle model
- Year of vehicle manufacture
- Software release of the multimedia system

The transfer of this data serves to optimize the communication between the vehicle and mobile phone.

To do this, and to assign several vehicles to the mobile phone, a vehicle ID is randomly generated.

This has no connection to the vehicle identification number (VIN) and is deleted when the multimedia system is reset (→ page 234).

Driving status data:

- Transmission position engaged
- Distinction between parked, standstill, rolling and driving
- Day/night mode of the instrument cluster

The transfer of this data is used to alter how content is displayed to correspond to the driving situation.

Position data:

- GPS coordinates
- Speed
- Compass direction
- Acceleration direction
- Gyroscopic forces

This data is only transferred while the navigation system is active as it serves to improve the navigation system (e.g. so that it can continue functioning when in a tunnel).

If you do not consent to vehicle data being transferred, you can deactivate the automatic start of Android Auto™ (→ page 265) or Apple CarPlay™ (→ page 264) and temporarily separate the USB connection between the mobile phone and the vehicle.

## Mercedes-Benz mbrace® (USA only)

### Making a call via the overhead control panel

Mercedes-Benz mbrace® is only available in the USA.

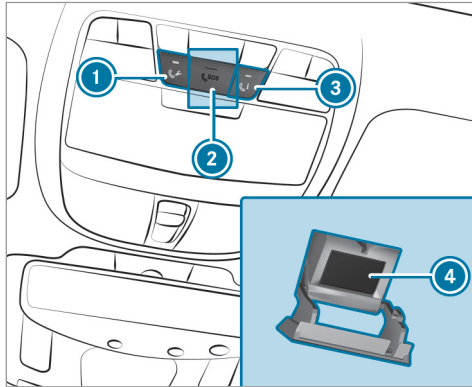

- ① Roadside Assistance call
- ② SOS button cover
- ③ MB Info call
- ④ SOS button

- ▶ **To make a Roadside Assistance call:** Press button ①. This initiates a call to the Mercedes-Benz Customer Assistance Center.
- ▶ **To make an emergency call:** Press SOS button cover ② briefly to open.
- ▶ Press and hold SOS button ④ for at least one second. This initiates a call to the Mercedes-Benz Customer Assistance Center.
- ▶ **To make an MB Info call:** Press button ③. This initiates a call to the Mercedes-Benz Customer Assistance Center.

An emergency call can be initiated even if a Roadside Assistance or MB Info call is active. This has priority over all other active calls.

Calls via the overhead control panel are only possible with an available mobile phone network.

Further information on Mercedes-Benz mbrace® and other services can be found at: <http://www.mbusa.com>

### Information on the emergency call system

**⚠ WARNING** Risk of accident and injury despite pressing the SOS button

Even if you press the SOS button in an emergency, remaining in the vehicle may be dangerous for the following reasons:

- you see smoke inside or outside of the vehicle, e.g. if there is a fire after an accident
- the vehicle is on a dangerous section of road
- the vehicle is not visible or cannot easily be seen by other road users, particularly when dark or in poor visibility conditions

- ▶ Leave the vehicle immediately in this or similar situations as soon as it is safe to do so.
- ▶ Move to a safe location along with other vehicle occupants.
- ▶ In such situations, secure the vehicle in accordance with national regulations, e.g. with a warning triangle.

### Automatic emergency call

The emergency call is initiated:

- When an airbag is deployed.
- When the Emergency Tensioning Devices are triggered.

You can end an automatically initiated emergency call yourself after 60 seconds.

### Manual emergency call

An emergency call can be initiated manually via the SOS button in the overhead control panel (→ page 267).

If you leave the vehicle immediately after pressing the SOS button, you do not know if Mercedes-Benz mbrace® has successfully made the emergency call.

### Initiated emergency call

A voice connection between the Customer Assistance Center and the vehicle occupants is established:

- If the vehicle occupants are responsive, the Mercedes-Benz Customer Assistance Center

asks for more detailed information on the emergency.

- If no vehicle occupant answers, an ambulance is sent to the vehicle immediately.

### Transmitted data

During the voice connection to the Customer Assistance Center, the following data is transferred:

- Current location of the vehicle
- Vehicle identification number

### Emergency call not possible

- If the mobile phone network is unavailable, Mercedes-Benz mbrace® is not able to make an emergency call.

A message to this effect is shown in the multifunction steering wheel.

The indicator lamp flashes continuously.

In this case, seek assistance by other means.

### Information on the MB Info call

An Info call to the Mercedes-Benz Customer Assistance Center has been initiated via the overhead control panel (→ page 267).

You can find information on the following topics:

- Activating Mercedes-Benz mbrace®
- Operating the vehicle
- Nearest authorized Mercedes-Benz Center
- Other products and services from Mercedes-Benz

Data is transmitted during the connection to the Mercedes-Benz Customer Assistance Center (→ page 269).

### Information on the Roadside Assistance call

A Roadside Assistance call to the Mercedes-Benz Customer Assistance Center has been initiated via the overhead control panel:

- The problem with the vehicle is analyzed using remote diagnosis.  
Further information about this can be obtained at: <http://www.mbusa.com>
- A qualified Mercedes-Benz technician carries out repairs on site and/or the vehicle will be towed to the nearest authorized Mercedes-Benz Center.  
You may be charged for these services.

Data is transmitted during the connection to the Mercedes-Benz Customer Assistance Center (→ page 269).

### Transferred data during a service call

In certain countries you must confirm the data transfer.

Data transferred includes the following:

### Overview of transferred data

Service call	Transmitted data
MB Info call Roadside Assistance call	<ul style="list-style-type: none"> <li>• Current location of the vehicle</li> <li>• Vehicle identification number</li> <li>• Service code</li> <li>• Selected data about the status of the vehicle</li> </ul>

## Online and Internet functions

### Internet connection

#### Internet connection restrictions

**⚠ WARNING** Risk of distraction from information systems and communications equipment

If you operate information and communications equipment integrated in the vehicle when driving, you will be distracted from the traffic situation. This could also cause you to lose control of the vehicle.

- ▶ Only operate this equipment when the traffic situation permits.
- ▶ If you cannot be sure of this, stop the vehicle whilst paying attention to road and traffic conditions and operate the equipment with the vehicle stationary.

You must observe the legal requirements for the country in which you are currently driving when operating the multimedia system.

**USA:** to use Mercedes-Benz Apps and access the Internet, mbrace must be activated and operational. Furthermore, mbrace must be activated for Mercedes-Benz Apps and Internet access.

**Canada:** the multimedia system must be connected to a mobile phone via Bluetooth® or to an external device acting as a Wi-Fi hotspot. Furthermore, you need a valid mobile service contract with a data option, which is used to calculate the associated connection costs.

The Internet functions can only be used to a limited degree whilst driving.

### Setting up an Internet connection via Wi-Fi

#### Requirements

- Activate the Wi-Fi function on the multimedia system (→ page 229).
- Activate the Wi-Fi function on the external device (see the manufacturer's operating instructions).
- Activate Internet access via Wi-Fi (see the manufacturer's operating instructions).

The Internet connection via Wi-Fi may be restricted or not function if:

- The mobile phone is switched off
- Mobile data use is deactivated on the mobile phone
- The Wi-Fi function is deactivated on the multimedia system
- The Wi-Fi function is deactivated on the external device
- Internet access via Wi-Fi is deactivated on the external device

Multimedia system:

↳ System ▶▶  Connectivity ▶▶ Internet Settings ▶▶ Search for Wi-Fi Networks

- ▶ Select network.  
A prompt appears.
- ▶ Select **Yes**.

### Setting up an Internet connection via Bluetooth®

#### Requirements

- Connect a mobile phone to the multimedia system via Bluetooth® (→ page 257).
- If you use the telephone module for Internet functions, you require a SIM card in the telephone module or a Bluetooth®-capable SAP mobile phone.

To connect via Bluetooth®, the mobile phone must support one of the following Bluetooth® profiles:

- DUN (Dial-Up Networking)
- PAN (Personal Area Network)

The Internet connection via Bluetooth® may be restricted or not function if:

- the mobile phone is switched off
- the mobile phone network coverage is insufficient
- mobile data use is deactivated on the mobile phone

- the Bluetooth® function is switched off on the multimedia system and the desired phone is to be connected via Bluetooth®
- the Bluetooth® function is switched off on the mobile phone and the phone is to be connected via Bluetooth®
- neither the mobile phone network nor the mobile phone allow simultaneous use of a phone and an Internet connection
- the mobile phone has not been enabled for Internet access via Bluetooth®

If a mobile phone is connected to the multimedia system for the first time via Bluetooth®, you will be assisted through the process of setting up an Internet connection.

Further information can be obtained at <http://www.mercedes-benz.com/connect> or from an authorized Mercedes-Benz Center.



Multimedia system:

↳ System ▶  Connectivity ▶ Internet Settings

### Bluetooth® connection via PAN

- ▶ Select the mobile phone.
- ▶ The Internet connection is established.

### Bluetooth® connection via DUN

- ▶ Highlight a mobile phone.
- ▶ Select .
- ▶ Select [Change Configuration](#).
- ▶ Select [Configure Settings Using COMAND](#).  
If the mobile phone only supports the DUN Bluetooth® profile, the Internet connection is configured with predefined or manual access data.
- ▶ **To select the predefined access data of the mobile phone network provider:** select [Predefined Settings](#).  
A list of countries appears.

- ▶ Select the country of your mobile phone network provider.  
The list of available providers appears.
- ▶ Select your mobile phone network provider.  
When an overview of the provider settings appears, make the necessary settings.
- ▶ Select [Confirm Settings](#).
- ▶ **To manually set the access data of the mobile phone network provider:** select [Manual Settings](#).  
An overview of the provider settings appears.
- ▶ Set access data.
- ▶ Select [Confirm Settings](#).
- ▶  Set the access data in accordance with your data package. Otherwise, additional costs may occur. You can contact your mobile phone network provider to obtain the precise access data.

### Switching the Bluetooth® profile

#### Requirement:

The mobile phone supports the DUN and PAN Bluetooth® profiles.

Multimedia system:

↳ System ▶  Connectivity ▶ Internet Settings

- ▶ Highlight a mobile phone.
- ▶ Select .
- ▶ Select [Change Configuration](#).
- ▶ Activate  [Automatic Configuration](#).  
The Internet connection is automatically configured using the PAN Bluetooth® profile.

or

- ▶ Deactivate  [Automatic Configuration](#).  
The Internet connection is configured with predefined or manual access data using the DUN Bluetooth® profile.

### Editing the access data

Multimedia system:

↳ System ▶  Connectivity ▶ Internet Settings

- ▶ Highlight a mobile phone.
- ▶ Select .
- ▶ Select [Change Configuration](#).

- ▶ Select **Configure Settings Using COMAND**.
- ▶ Select **Predefined Settings** or **Manual Settings**.  
The provider settings are displayed.
- ▶ Set access data.

### Canceling Internet access permission for a mobile phone

Multimedia system:

↳ **System** ▶  **Connectivity** ▶ **Internet Settings**

- ▶ Highlight a mobile phone.
- ▶ Select .
- ▶ Select **Delete Configuration**.
- ▶ Select **Yes**.

### Displaying mobile phone details

Multimedia system:

↳ **System** ▶  **Connectivity** ▶ **Internet Settings**

- ▶ Highlight a mobile phone.
- ▶ Select .
- ▶ Select **Details**.

### Establishing an Internet connection

Multimedia system:

↳ **Connect**

- ▶ For example, select  **Browser**.

**i** The multimedia system usually establishes the Internet connection automatically. If the multimedia system is not connected to the Internet, the Internet connection is established when an Internet application is used.

### Connection status

#### Overview of connection status



- 1** Display of existing connection and reception field strength of the connected device

#### Displaying the connection status

Multimedia system:

↳ **System** ▶  **Connectivity**

- ▶ Select **Internet Status**.

**i** Depending on the means of connection, the approximate data volume transmitted is displayed. The exact values can be requested from your mobile phone network provider.

## Mercedes-Benz Apps

### Calling up Mercedes-Benz Apps

#### Requirements:

- Register to use Mercedes-Benz Apps.
- Confirm the general terms and conditions.

Multimedia system:

→ Connect →  MB Apps

▶ Select the App.

Further Mercedes-Benz Apps and information can be obtained at: <http://apps.mercedes-benz.com/apps/>

- ⓘ The available features are country-dependent.  
License fees may be applicable.

### Using Mercedes-Benz Apps voice control

#### Requirements:

- Register to use Mercedes-Benz Apps.
- Confirm the general terms and conditions.

You can use the following Apps via the voice control system:

- Weather
- Online search
- Tuneln radio

- ▶ Call up the Mercedes-Benz App (→ page 273).  
The basic menu of the App is displayed.
- ▶ To use voice control: select  Language.
- ▶ Voice a question or a command.
- ⓘ Voice control is not available in all countries.

## Web browser

### Calling up a website

Multimedia system:

→ Connect →  Browser →  Enter URL

- ▶ Entering a web address.
- ▶ **To finish entry and call up a website:**  
Select  .

- ⓘ Websites cannot be shown while the vehicle is in motion.

### Overview of the web browser

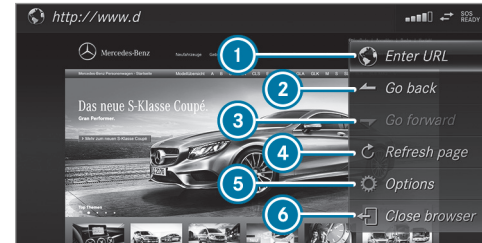

- ① URL entry
- ② Web page, back
- ③ Web page, forwards
- ④ Refreshes/stops
- ⑤ Options
- ⑥ Closes the browser

**Calling up the web browser options**

Multimedia system:

↳ Con-  
nect ►  Browser ►  Options

The following functions are available:

- [Bookmarks](#)
- [Zoom](#)
- [Font Size](#)
- [Browser Settings](#)
- [Delete Browser Data](#)

- Select an option.
- Change the settings.

**Calling up the web browser settings**

Multimedia system:

↳ Con-  
nect ►  Browser ►  Options ► Bro  
wser Settings

The following functions are available:

- [Block Pop-Ups](#)
- [Activate Javascript](#)

- [Allow Cookies](#)
- [Smartsroll](#)

- Switch the function on  or off .

**Deleting Internet history**

Multimedia system:

↳ Con-  
nect ►  Browser ►  Options ► Del  
ete Browser Data

The following options are available:

- [All](#)
  - [Cache](#)
  - [Cookies](#)
  - [Entered URLs](#)
  - [Form Data](#)
- Select an option.
  - Select Yes.

**Setting Internet favorites**

Multimedia system:

↳ Con-  
nect ►  Browser ►  Options ► Bo  
okmarks

**Selecting favorites**

- Select bookmarks.

**Creating favorites**

- Select [Add New Bookmark](#).
- Enter URL and name.
- Select  .

**Editing favorites**

- Select bookmarks.
- Select [Edit](#).
- Enter URL and name.
- Select  .

**Deleting favorites**

- Select [Delete](#).
- Select Yes.

### Closing the browser

Multimedia system:

→ Connect → Browser

▶ Select  Close Browser.

▶ Select Yes.

### Internet radio

#### Calling up the Internet radio

##### Requirements:

- An account exists at <http://www.mercedes.me>.  
The services are country-dependent.
- The Internet radio service is activated.
- The data volume is available.  
Depending on the country, data volume may need to be purchased. For more information, consult an authorized Mercedes-Benz Center.
- A fast Internet connection for data transmission free of interference (→ page 269).

Multimedia system:

→ Radio →  Internet Radio

▶ Select Tuneln Radio.

The Internet radio display appears. The last station set starts playing.

ⓘ The connection quality depends on the local mobile phone reception.

### Internet radio overview

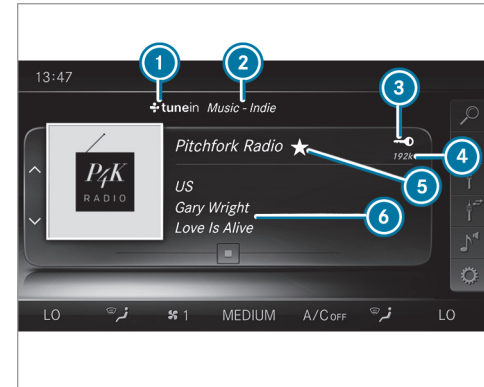

- 1 Internet radio provider
- 2 Selected category
- 3 Display (if connected to private user account)
- 4 Data rate
- 5 Current station is stored as a favorite
- 6 Additional information on the current station

### Selecting and connecting to Internet radio stations

Multimedia system:

➤ Radio ➤  Internet Radio ➤ Tuneln Radio ➤  Search

➤ Enter the station name using the entry field.  
or

➤ Select **Browse**.

➤ Select a category.

➤ Select a station.

The connection is established automatically.

 A relatively large volume of data can be transmitted when using Internet radio.

### Saving/deleting Internet radio stations as favorites

Multimedia system:

➤ Radio ➤  Internet Radio ➤ Tuneln Radio ➤  Options

➤ Press and hold the touchpad or controller until an audible signal sounds.

The  symbol appears by the station name.

➤ Select **Favorites**.

The list of saved favorite stations appears.

or

➤ Create an account for the online provider (Tuneln) and then log in on the multimedia system.

Your favorites are imported to the multimedia system.

### Deleting favorites

➤ Select a favorite.

➤ Press and hold the touchpad or controller until an audible signal sounds.  
The  symbol by the station name disappears.

### Setting the Internet radio options

Multimedia system:

➤ Radio ➤  Internet Radio ➤ Tuneln Radio ➤  Options

The following options are available:

- **Select Stream**: select the stream quality.
- **Login to Tuneln Account**: login to your Tuneln user account.

- **Log Out of Account**: log out of your Tuneln user account.

- **Terms and Conditions**: display the general terms and conditions.

➤ Select an option.

## Media

### Audio mode

#### Information on audio mode

 **WARNING** Risk of distraction when handling data storage medium

If you handle a data storage medium while driving, your attention is diverted from the traffic conditions. This could also cause you to lose control of the vehicle.

➤ Only handle a data storage medium when the vehicle is stationary.

Permissible file systems:

- FAT32
- exFAT

- NTFS

Permissible data storage medium:

- SD memory card
- USB storage device

**i** The multimedia system supports a total of up to 50,000 files.

Supported formats:

- MP3
- WMA
- AAC formats

**i** Due to the large variety of available music files regarding encoders, sampling rates and bit rates, playback cannot always be guaranteed.

**i** Due to the wide range of USB devices available on the market, playback cannot be guaranteed for all brands of USB devices.

**i** Copy-protected music files or DRM encrypted files cannot be played back.

**i** MP3 players must support Media Transfer Protocol (MTP).



Manufactured under license from Dolby Laboratories. Dolby and the double-D symbol are trademarks of Dolby Laboratories.



Gracenote, the Gracenote logo and logotype are either a registered trademark or a trademark of Gracenote, Inc. in the USA and/or other countries.

#### Notes on copyright

Audio files that you create or reproduce yourself for playback are generally subject to copyright protection. In many countries, reproductions, even for private use, are not permitted without the prior consent of the copyright holder. Make sure that you know about the applicable copyright regulations and that you comply with these.

#### Activating media mode

Multimedia system:

Media Devices

- Select the media source.
- Playable music files are played back.

#### Inserting/removing an SD memory card

**⚠ DANGER** Risk of fatal injury caused by swallowing SD memory cards

SD memory cards are small parts.

They can be swallowed and cause choking.

- ▶ Keep SD memory cards out of the reach of children.
- ▶ Seek medical attention immediately if a SD memory card has been swallowed.

**!** **NOTE** Damage caused by high temperatures

High temperatures can damage the SD memory card.

- ▶ Remove the SD memory card after use and take it out of the vehicle.

Multimedia system:

[Media](#) ▶▶  [Devices](#) ▶▶ [Memory Card](#)

### Inserting

The multimedia connection unit is located in the stowage compartment under the armrest.

- ▶ Insert the SD memory card into the SD card slot until it engages. The side with the contacts must face downwards. Playable music files are played back.

### Removing

- ▶ Press the SD memory card.
- ▶ Eject the SD memory card.



## Overview of the audio mode

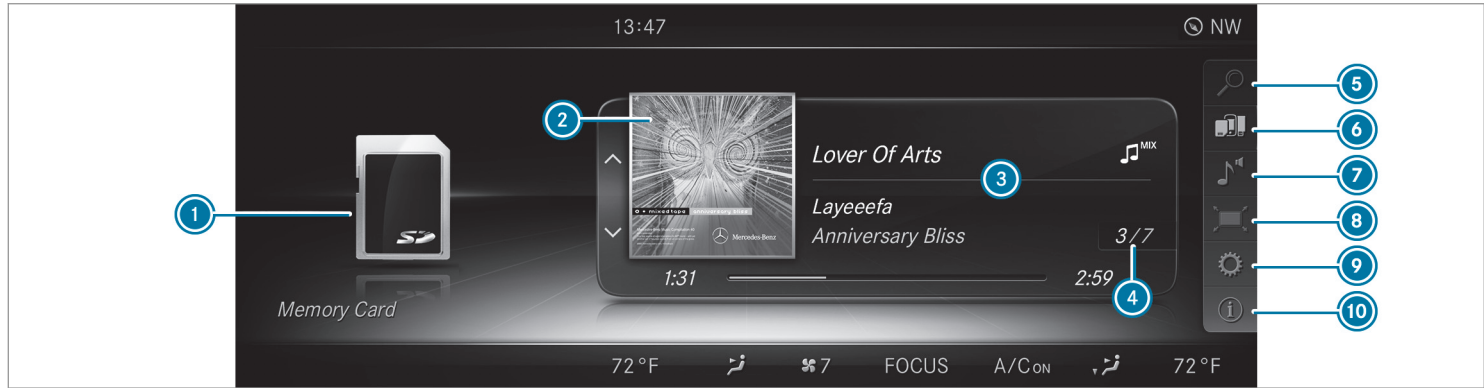

① Active data storage medium

② Cover

③ Artist, title and album

④ Track number and number of tracks in the track list

⑤ Search

⑥ Devices

⑦ Sound settings

⑧ Full screen

⑨ Options

⑩ Operator's Manual

## Connecting USB devices

**NOTE** Damage caused by high temperatures

High temperatures can damage USB devices.

- ▶ Remove the USB device after use and take it out of the vehicle.

The multimedia connection unit is found in the stowage compartment under the armrest and has two USB ports. Depending on the vehicle equipment, a further USB port is located in the stowage compartment in the center console at the front.

- ▶ Connect the USB device to the USB port. Playable music files are played only if the corresponding media display is activated.
- ① Use the USB port shown as  to use Apple CarPlay™ and Android Auto™.

### Selecting a track

Multimedia system:

- ▶  Media

### Via skip function

- ▶ **To skip backwards or forwards to a track:** navigate up or down.

### Via current track lists

- ▶ Select .
- ▶ Select **Current Track List**.
- ▶ Select a track.

### Selecting playback options

Multimedia system:

- ▶  Media ▶▶  Options

### Playing back similar tracks

- ▶ Select **Play Similar Tracks**.  
A track list with similar tracks is created and played back.



### Play mode

- ▶ Select **Playback Mode**.

- ▶ Select **Normal Track Sequence**.  
The current track list is played in the order it appears on the data storage medium.
- ▶ Select **Random Mode - Current Playlist**.  
The current track list is played in random order.
- ▶ Select **Random Mode - Current Medium**.  
All tracks on the data storage medium are played in random order.

### Pause and playback function

Multimedia system:

- ▶  Media
- ▶ Press the touchpad or the controller.
- ▶ **To pause playback:** select .
- ▶ **To continue playback:** select .

### Fast forward/rewind

- ▶ Slide the controller to the left or right .

## Video mode

### Activating video mode

Multimedia system:

↳ Media ▶  Devices

- ▶ Select a data storage medium.  
▶ Playable video files are played back.

 The multimedia system supports MPEG, AVI and MP4 formats. Due to the large variety of available video files regarding encoders, refresh rates and bit rates, playback cannot always be guaranteed.

### Overview of video mode

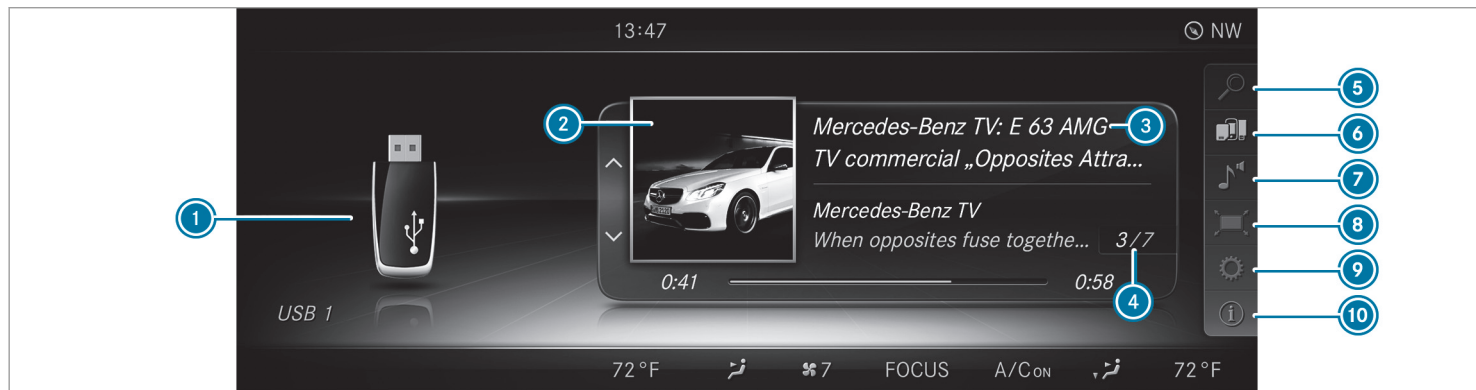

- ① Active data storage medium
- ② Cover
- ③ Title and scene
- ④ Track number and number of tracks in the track list

- ⑤ Search
- ⑥ Devices
- ⑦ Sound settings
- ⑧ Full screen

- ⑨ Options
- ⑩ Operator's Manual

### Activating/deactivating full-screen mode

Multimedia system:

↳ Media ▶  Devices

- ▶ Select a data storage medium.  
Playable video files are played back.
- ▶ **To activate full-screen mode:** select  Full Screen.
- ▶ **To deactivate full-screen mode:** press the touchpad or controller.

### Changing video settings

Multimedia system:

↳ Media ▶  Options ▶ Video Settings

The following picture formats are available:

- Automatic
  - 16:9
  - 4:3
  - Zoom
- ▶ Select the picture format.

### Adjusting the brightness manually

- ▶ Select **Brightness**.
- ▶ Adjust the brightness.

### Media search

#### Starting the media search

Multimedia system:

↳ Media ▶  Search

Depending on the connected media sources and files, the following categories are listed:

- Albums
- Artists
- Tracks
- Keyword Search
- Playlists
- Videos
- Folder
- Year
- Current Track List
- Music Genres

- Composers
- Genius Mixes (Apple® devices)
- Podcasts (Apple® devices)
- iTunes U (Apple® devices)
- Audiobooks (Apple® devices)

- ▶ Select a category.

### Media Interface

#### Information about the Media Interface

Media Interface is a universal interface for the connection of mobile audio equipment. The multimedia system has two USB ports. The USB ports are located in the stowage compartment under the armrest.

#### Supported devices

The Media Interface allows you to connect the following data storage media:

- iPod®
- iPhone®
- iPad®

## 284 Multimedia system

---

- MP3 player
- USB devices

For details and a list of supported devices, visit our website at <http://www.mercedes-benz.com/connect>. Follow the instructions in the "Media Interface" section.

### Switching on Media Interface

Multimedia system:

 [Media](#)   [Devices](#)

- ▶ Connect the data storage medium with the USB port (→ page 280).

- ▶ Select the media device.  
▶ Playable music files are played back.

## Overview of Media Interface

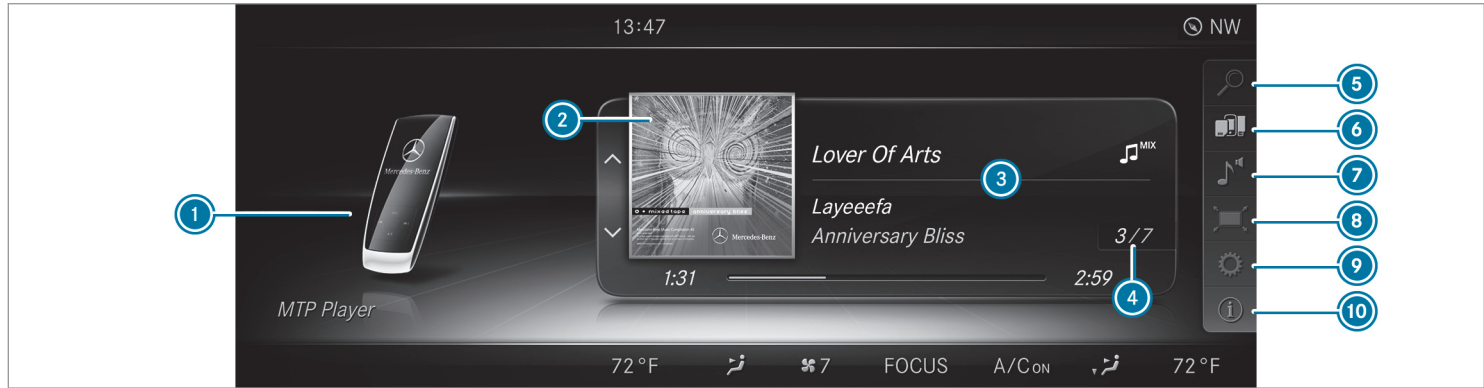

① Active data storage medium

② Cover

③ Artist, title and album

④ Track number and number of tracks in the track list

⑤ Search

⑥ Devices

⑦ Sound settings

⑧ Full screen

⑨ Options

⑩ Operator's Manual

## Bluetooth® audio

### Information about Bluetooth® audio

Before using your Bluetooth® audio equipment with the multimedia system for the first time, you will need to authorize it.

### Searching for and authorizing the Bluetooth® audio equipment

#### Requirements

Bluetooth® is activated on the multimedia system (→ page 228).

Check your Bluetooth® audio equipment for the following (see the manufacturer's operating instructions):

- The Bluetooth® audio equipment must support the A2DP and AVRCP Bluetooth® audio profiles.
- The Bluetooth® function must be activated.
- The Bluetooth® audio equipment must be "visible" for other devices.

Multimedia system:

→  Media →  Devices → Bluetooth Audio →  Options → Add New Bluetooth Audio Device

- ▶ Select **Start Search**.  
The multimedia system searches for Bluetooth® audio equipment within range and adds them to the Bluetooth® device list.
- ▶ Select Bluetooth® audio equipment.  
A prompt appears asking if you want to connect the device as audio equipment.
- ▶ Select **Yes**.  
Authorization starts.

#### Option 1: Secure Simple Pairing

A code is displayed on the multimedia system and on the mobile phone.

- ▶ Confirm on the Bluetooth® audio equipment if the codes are identical.

#### Option 2: entering the passkey

The input menu for the passkey is displayed.

- ▶ **Multimedia system:** choose a one to sixteen-digit number combination as a passkey.

- ▶ Select OK once all the numbers have been entered.
- ▶ **Mobile phone:** enter the same passkey and confirm your entry.  
After successful authorization, the Bluetooth® audio equipment is connected and playback starts.

#### Establishing a connection from the Bluetooth® audio equipment

The Bluetooth® device name of the multimedia system is **MB BLUETOOTH XXXX**.

- ▶ Select **Search from Device**.
- ▶ Start the authorization on your Bluetooth® audio equipment (see the manufacturer's operating instructions).  
After successful authorization, the Bluetooth® audio equipment is connected and playback starts.

With some Bluetooth® audio equipment, playback must be initially started on the device itself so that the multimedia system can play the audio files.



-  Device-specific information on authorizing and connecting Bluetooth®-capable mobile phones can be obtained at <http://www.mercedes-benz.com/connect> or from an authorized Mercedes-Benz Center.

### Activating Bluetooth® audio

Multimedia system:

 Media   Devices

-  Select **Bluetooth Audio**.  
The multimedia system activates the connected Bluetooth® audio equipment.

### Switching to Bluetooth® audio equipment via NFC

#### Requirements:

Observe the notes on using NFC (→ page 257).

The Bluetooth® audio overview is displayed (→ page 287).

-  Lightly press the NFC area of the mobile phone (see the manufacturer's operating instructions).  
If the mobile phone has already been authorized on the multimedia system as Bluetooth® audio equipment, it is now connected.  
If the mobile phone is authorized on the multimedia system as Bluetooth® audio equip-

ment for the first time, it is connected after confirming the instructions of the mobile phone (see the manufacturer's operating instructions).

### Bluetooth® Audio overview

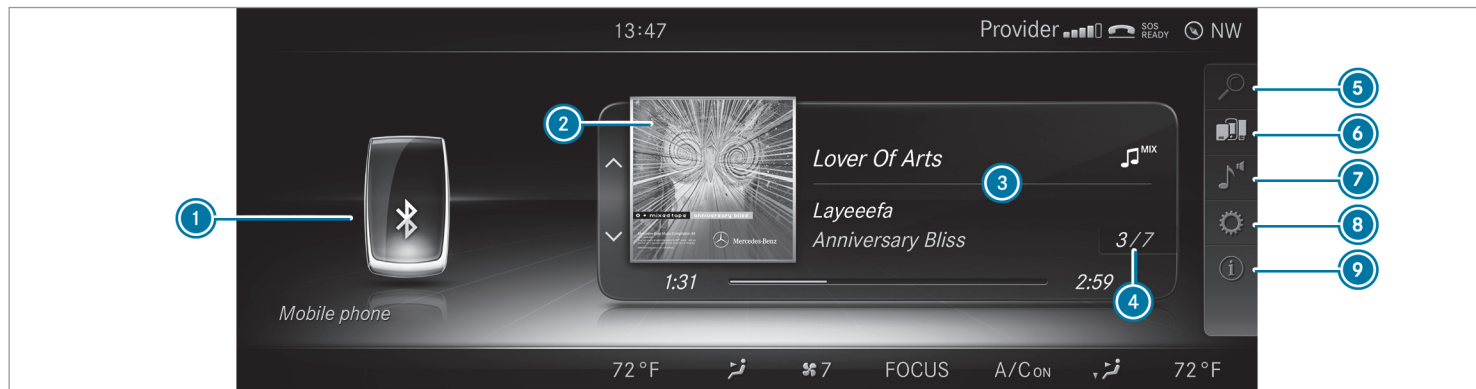

- ① Active data storage medium
- ② Cover
- ③ Artist, title and album
- ④ Track number and number of tracks in the track list

- ⑤ Search
- ⑥ Devices
- ⑦ Sound settings
- ⑧ Options

- ⑨ Operator's Manual

### De-authorizing (de-registering) Bluetooth® audio equipment

Multimedia system:

↳ Media ▶  Devices

- ▶ Select Bluetooth® audio equipment.
- ▶ Select  Options .
- ▶ Select **Deauthorize**.

- ▶ Select **Yes**.  
The device will be deleted from the Bluetooth® device list.

### Radio

#### Switching on the radio

Multimedia system:

↳ Radio

- ▶ Alternatively: press the  button.  
The radio display appears. You will hear the last station played on the last frequency band selected.

## Radio overview



- ① Active frequency band
- ② Station name
- ③ Artist, title, album and radio text

- ④ Search/station list
- ⑤ Favorite stations/radio station presets
- ⑥ Frequency band

- ⑦ Internet radio
- ⑧ Sound settings
- ⑨ Options

### Switching HD Radio on/off

Multimedia system:

↳ Radio ▶ ⚙️ Options ▶ HD Radio



- ▶ Activate  or deactivate  the function.
- ⓘ HD Radio™ and the HD, HD Radio, and "Arc" logos are proprietary trademarks of iBiquity Digital Corp.

### Setting the frequency band

Multimedia system:

↳ Radio ▶ 📻 Waveband

HD Radio FM HD Radio AM and SiriusXM Radio can be selected.

- ▶ Select a frequency band.

### Selecting a radio station

Multimedia system:

↳ Radio

- ▶ Navigate up or down.

### Calling up the radio station list

Multimedia system:

↳ Radio ▶ 🔍

- ▶ Select a station.

### Searching for radio stations using station names or direct frequency entry

Multimedia system:

↳ Radio ▶ 🔍 ▶ 🔍

- ▶ Enter a station name or frequency.
- ▶ Select  . Results are displayed.
- ▶ Select a station.

### Storing radio stations

Multimedia system:

↳ Radio ▶ ⭐ Presets

- ▶ Select Save Current Station.

### Editing radio station presets

Multimedia system:

↳ Radio ▶ ⭐ Presets

### Deleting stations:

- ▶ Highlight the preset entry and navigate to the left.

- ▶ Select **Delete Highlighted Station**.
- ▶ Select **Yes**.

#### Moving stations:

- ▶ Select **Move Highlighted Station**.
- ▶ Select a preset.

#### Tagging music tracks

Multimedia system:

↳ **Radio** ▶  **Options**

If radio stations provide the relevant information, this function allows you to transfer information on the music track currently playing to an Apple® device. You can then purchase the audio file from the iTunes Store®.

- ▶ Select **Tag This Song**.  
The track information is saved.

#### Activating/deactivating radio text

Multimedia system:

↳ **Radio** ▶  **Options** ▶ **Display Radio Text Information**

- ▶ Activate  or deactivate  the function.

#### Satellite radio

##### Information on the satellite radio

SIRIUS XM® Satellite Radio offers more than 175 digital-quality radio channels providing 100% commercial-free music, sports, news and entertainment, for example. SIRIUS XM satellite radio employs a fleet of high-performance satellites to broadcast around the clock throughout the USA and Canada. The satellite radio program is available for a monthly fee. Information about this can be obtained from a Sirius XM® service center and at <http://www.siriusxm.com> (USA) or <http://www.siriusxm.ca> (Canada). Your new Mercedes-Benz vehicle comes with SIRIUS XM® Satellite Radio pre-installed at the factory. This service is free for a six-month trial period. About a month before the trial period ends, information

will be provided on how to extend this subscription. A message is shown, describing how the subscription can be extended.

- ⓘ Sirius, XM and all related marks and logos are trademarks of Sirius XM Radio Inc. and its subsidiaries. All other marks, channel names and logos are the property of their respective owners. All rights reserved.

##### Restrictions on the satellite radio

Satellite radio mode may be temporarily unavailable or interrupted for a variety of reasons. These include environmental or topographical conditions beyond the control of Mercedes-Benz USA, LLC. Thus operation at certain locations may not be possible.

##### Registering satellite radio

###### Requirements:

The satellite radio mode requires satellite radio equipment and registration with a satellite radio provider. If registration is not included when purchasing the system, your credit card details will be required to activate your account.

Multimedia system:

↳ Radio ▶  Waveband ▶ Satellite  
Radio ▶  Options

▶ Select **Service Information**.

The service information screen appears showing the radio ID and the current subscription status.

▶ Establish a telephone connection.

▶ Follow the service staff's instructions.

The activation process may take up to ten minutes.

ⓘ You can also have the satellite service activated online. To do so, please visit <http://www.siriusxm.com>

(USA) or <http://www.siriusxm.ca> (Canada).

### Switching on satellite radio

Multimedia system:

↳ Radio ▶  Waveband

▶ Select **Satellite Radio**.

### Overview of the satellite radio



- ① Active frequency band
- ② Logo or album art (if available)
- ③ Category
- ④ Channel name

- ⑤ Channel information
- ⑥ Search, channel and category list
- ⑦ Favorites
- ⑧ Frequency band

- ⑨ Internet radio
- ⑩ Sound settings
- ⑪ Options



**Selecting a satellite radio category**

Multimedia system:

Radio >> Waveband >> Satellite  
 Radio >> SiriusXM Radio Chan-  
 nels >> Category

- Select a category.

**Selecting a satellite radio channel**

Multimedia system:

Radio >> Waveband >> Satellite  
 Radio

- Navigate up or down.

**Saving or deleting a satellite radio channel**

Multimedia system:

Radio >> Waveband >> Satellite  
 Radio >> Presets

- Select **Save Current Station**.

**Moving a channel**

- Select **Options**.
- Select **Move Highlighted Station**.
- Select a preset.

**Deleting a channel**

- Select **Delete Highlighted Station**.
- Select a preset.

**Displaying EPG information for the current channel**

Multimedia system:

Radio >> Waveband >> Satellite  
 Radio >> Options

- Select **EPG Information about Current Chan-  
nel**.

**Setting the parental control**

Multimedia system:

Radio >> Waveband >> Satellite  
 Radio >> Options >> Parental Control

- Switch the function on .
- Determine a four-digit character sequence and select **ok**.
- All channels with adult content are locked.

**Unlocking a channel**

- Enter the four-digit character sequence and select **ok**.
- All channels with adult content are unlocked.

**Music and sport alerts function**

This function makes it possible to store a program alert for your favorite artists, tracks or sporting events. Music alerts can be saved whilst a track is being played and sport alerts can be saved during a live game. You can also specify sport alerts via the menu option. The system then continuously searches through all the channels. If a match is found with a stored alert, you will be informed.

**Setting music and sport alerts****Requirements**

Switch on the following function:

- Activate Artist & Song Alerts**
- Activate Sports Alerts**

Multimedia system:

↳ Radio ▶  Waveband ▶ Satellite Radio ▶  Options ▶ Alert for Artist, Song & Sporting Event

### Setting a music alert

▶ Select **Manage Artist & Song Alerts**.

▶ Select  **Options**.

The following options are available:

- **Mark This Entry**
- **Mark All Entries**
- **Unmark All Entries**
- **Delete This Entry**
- **Delete All Entries**

▶ Select an option.

The alert is set for the current artist or track. If a match is found, a prompt appears asking whether you wish to change to the station.

### Setting a sport alert

▶ Select **Manage Sports Alerts**.

▶ Select **Add New Alert** or **Edit Alerts**.

▶ Select a team from a league.

### Displaying satellite radio service information

Multimedia system:

↳ Radio ▶  Waveband ▶ Satellite Radio ▶  Options

▶ Select **Service Information**.

## Sound

### Tone settings

#### Information about the sound system

The sound system has a total output of 100 watts and is equipped with seven speakers. It is available for all functions in the radio and media modes.

#### Calling up the sound menu

Multimedia system:

↳ Media ▶  Sound

The following functions are available:

- **Equalizer**
- **Balance and Fader**

▶ Select the sound menu.

### Adjusting treble, mid and bass

Multimedia system:

↳ Media ▶  Sound ▶ Equalizer

▶ Select **Treble**, **Mid Range** or **Bass**.

▶ Change the settings.

### Adjusting the balance/fader

Multimedia system:

↳ Media ▶  Sound ▶ Balance and Fader

▶ Adjust the balance and fader.

▶ **To exit the menu:** press the  button.

### Burmester® surround sound system

#### Information about the Burmester® surround sound system

The Burmester® surround sound system has a total output of 590 watts and is equipped with 13 speakers. It is available for all functions in the radio and media modes.

### Calling up the sound menu in the Burmester® surround sound system

Multimedia system:

➤ Media ➤  Sound

The following functions are available:

- Equalizer
- Balance and Fader
- Surround Sound
- Sound Focus

▶ Select the sound menu.

### Adjusting the treble, mid and bass in the Burmester® surround sound system

Multimedia system:

➤ Media ➤  Sound ➤ Equalizer

- ▶ Select Treble, Mid Range or Bass.
- ▶ Change the settings.

### Adjusting the balance/fader in the Burmester® surround sound system

Multimedia system:

➤ Media ➤  Sound ➤ Balance and Fader

- ▶ Adjust the balance and fader.
- ▶ **To exit the menu:** press the  button.

### Switching surround sound on/off in the Burmester® surround sound system

Multimedia system:

➤ Media ➤  Sound ➤ Surround Sound

- ▶ Switch the function on  or off .

### Adjusting the sound focus in the Burmester® surround sound system

Multimedia system:

➤ Media ➤  Sound ➤ Sound Focus

- ▶ Adjust the focus.

### Burmester® high-end 3D surround sound system

#### Information about the Burmester® high-end 3D surround sound system

The

Burmester® high-end 3D surround sound system has a total output of 1,450 watts and is equipped with 23 speakers. It is available for all functions in the radio and media modes.

#### Calling up the sound menu in the Burmester® high-end 3D surround sound system

Multimedia system:

➤ Media ➤  Sound

The following functions are available:

- Equalizer
- Balance and Fader
- VIP Seat (seat-based sound optimization)
- Sound Profiles
- ▶ Select the sound menu.

### Adjusting the treble, mid and bass in the Burmester® high-end 3D surround sound system

Multimedia system:

Media ▶ Sound ▶ Equalizer

- ▶ Select **Treble**, **Mid Range** or **Bass**.
- ▶ Change the settings.

### Adjusting the balance/fader in the Burmester® high-end 3D surround sound system

Multimedia system:

Media ▶ Sound ▶ Balance and Fader

- ▶ Adjust the balance and fader.
- ▶ **To exit the menu:** press the  button.

### Adjusting the seat-based sound optimization in the Burmester® high-end 3D surround sound system

Multimedia system:

Media ▶ Sound ▶ VIP Seat

This setting optimizes the sound playback for the selected seat position.

- ▶ Switch the function on .
- ▶ Select the seat position.

### Selecting the sound profile in the Burmester® high-end 3D surround sound system

Multimedia system:

Media ▶ Sound ▶ Sound Profiles

The following profiles are available:

- Pure
  - Easy Listening
  - Live
  - Surround
  - 3D-Sound
- ▶ Select the sound profile.

### ASSYST PLUS service interval display

#### Function of the ASSYST PLUS service interval display

The ASSYST PLUS service interval display in the instrument display provides information on the remaining time or distance before the next service due date.

You can hide this service message using the back button on the left-hand side of the steering wheel.

You can obtain further information concerning the servicing of your vehicle from a qualified specialist workshop, e.g. an authorized Mercedes-Benz service center.

#### Displaying the service due date

On-board computer:

↳ Service ►► ASSYST PLUS

The next service due date is displayed.

► **To exit the display:** Press the back button on the left-hand side of the steering wheel.

Make sure to observe the following further related subject:

- Operating the on-board computer (→ page 197).

#### Carrying out service work at regular intervals

**NOTE** Premature wear through failure to observe service due dates

Service work which is not carried out at the right time or incompletely can lead to increased wear and damage to the vehicle.

- ▶ Always observe the prescribed service intervals.
- ▶ Always have the prescribed service work carried out at a qualified specialist workshop.

#### Special service requirements

The prescribed service interval is based on normal operation of the vehicle. Service work will need to be performed more often if the vehicle is operated under arduous conditions or increased loads, for example:

- regular city driving with frequent intermediate stops.
- if the vehicle is primarily used to travel short distances.
- for frequent operation in mountainous terrain or on poor road surfaces.
- if the engine is often left idling for long periods.
- in particularly dusty conditions and/or if air-recirculation mode is frequently used.

In these or similar operating conditions, have, for example, the interior air filter, engine air filter, engine oil and oil filter changed more frequently. The tires must be checked more frequently if the vehicle is operated under increased loads. Further information can be obtained at a qualified specialist workshop.

### Battery disconnection periods

**The ASSYST PLUS service interval display can only calculate the service due date when the battery is connected.**

- ▶ Note down the service due date displayed in the instrument display before disconnecting the battery (→ page 299).

### Engine compartment

#### Active hood (pedestrian protection)

#### Operation of the active hood (pedestrian protection)

In certain accident situations, the risk of injury to pedestrians can be reduced by the actuation of the active hood. The rear area of the engine hood is raised by approximately 85 mm.

For the drive to the workshop, reset the triggered active hood yourself. If the active hood has been triggered, pedestrian protection may be limited.

A qualified specialist workshop must re-instate the full functionality of the active hood.

The active hood is not available in all countries.

#### Resetting the active hood

**⚠ WARNING** Risk of burns from hot component parts in the engine compartment

Certain component parts in the engine compartment can be very hot, e.g. the engine, the cooler and parts of the exhaust system.

- ▶ Let the engine cool down and only touch the component parts described as follows.

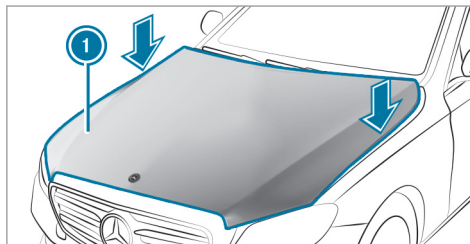

- ▶ With your hand flat, push down active hood ① in the area around the hinges on both sides (arrows). The engine hood must engage in position.
- ▶ If the active hood can be raised slightly at the rear in the area of the hinges, repeat the step until it engages correctly in position.

#### Opening/closing the engine hood

**⚠ WARNING** Risk of accident if the engine hood is unlatched while driving

An unlatched engine hood may open up when the vehicle is in motion and block your view.

- ▶ Never unlatch the engine hood while driving.
- ▶ Before every trip, ensure that the engine hood is latched.

- ⚠ WARNING** Risk of accident and injury when opening and closing the engine hood

When opening or closing the engine hood, it may suddenly drop into the end position.

There is a risk of injury for anyone in the engine hood's range of movement.

- ▶ Only open or close the engine hood when there are no persons in the engine hood's range of movement.

- ⚠ WARNING** Danger of burns when opening the engine hood

If you open the engine hood when the engine has overheated or during a fire in the engine compartment, you could come into contact with hot gases or other escaping operating fluids.

- ▶ Before opening the engine hood, allow the engine to cool down.

- ▶ In the event of a fire in the engine compartment, keep the engine hood closed and call the fire service.

- ⚠ WARNING** Risk of injury due to moving parts

Certain components in the engine compartment may continue to move or suddenly move again even after the ignition has been switched off, e.g. the cooler fan.

Make sure of the following before performing tasks in the engine compartment:

- ▶ Switch the ignition off.
- ▶ Never touch the danger zone surrounding moving component parts, e.g. the rotation area of the fan.
- ▶ Remove jewelry and watches.
- ▶ Keep items of clothing and hair away from moving parts.

- ⚠ WARNING** Risk of injury from touching component parts under voltage

The ignition system and the fuel injection system work under high voltage. If you touch component parts which are under voltage, you could receive an electric shock.

- ▶ Never touch component parts of the ignition system or the fuel injection system when the ignition is switched on.

- ⚠ WARNING** Risk of burns from hot component parts in the engine compartment

Certain component parts in the engine compartment can be very hot, e.g. the engine, the cooler and parts of the exhaust system.

- ▶ Let the engine cool down and only touch the component parts described as follows.

**⚠ WARNING** Risk of injury from using the windshield wipers while the engine hood is open

When the engine hood is open and the windshield wipers are set in motion, you can be trapped by the wiper linkage.

- ▶ Always switch off the windshield wipers and ignition before opening the engine hood.

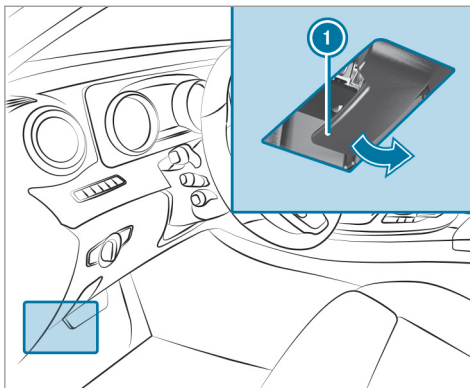

- ▶ **To open:** pull lever ① to release the engine hood.

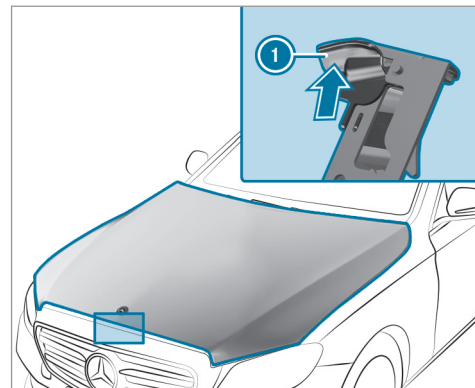

- ▶ Push hood catch ① upwards and lift the engine hood approximately 15 in (40 cm).
- ▶ **To close:** lower the engine hood and let it fall with a little momentum from a height of approximately 8 in (20 cm).
- ▶ If the engine hood can still be lifted slightly, open the engine hood again and close it with a little more force until it engages correctly.



## Engine oil

### Checking the engine oil level using the oil dipstick

**⚠ WARNING** Risk of burns from hot component parts in the engine compartment

Certain component parts in the engine compartment can be very hot, e.g. the engine, the cooler and parts of the exhaust system.

- ▶ Let the engine cool down and only touch the component parts described as follows.

Depending on the engine, the oil dipstick may be installed in the engine compartment in different locations.

Waiting time before checking the oil level:

- Engine at normal operating temperature: five minutes.
- Engine not at normal operating temperature (e.g. the engine was only started briefly): 30 minutes.

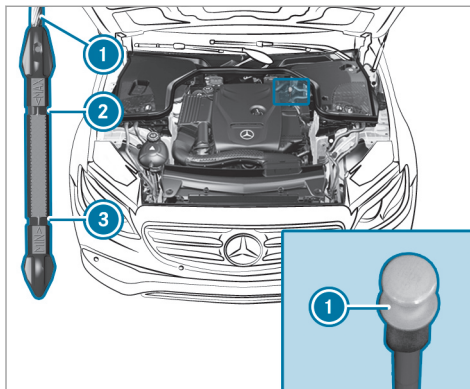

- ▶ Park the vehicle on a flat surface.
- ▶ Remove oil dipstick ① and wipe off.
- ▶ Slowly slide oil dipstick ① into the guide tube to the stop, and take it out again after approximately three seconds.
  - Oil level is correct: oil level is between ② and ③.

- Oil level too low: oil level is at ③ or below.

- ▶ If the oil level is too low, add 1.1 US qt (1 l) of engine oil.

### Topping up engine oil

**⚠ WARNING** Risk of burns from hot component parts in the engine compartment

Certain component parts in the engine compartment can be very hot, e.g. the engine, the cooler and parts of the exhaust system.

- ▶ Let the engine cool down and only touch the component parts described as follows.

**⚠ WARNING** Risk of fire and injury from engine oil

If engine oil comes into contact with hot component parts in the engine compartment, it may ignite.

- ▶ Make sure that no engine oil is spilled next to the filler opening.

- ▶ Allow the engine to cool off and thoroughly clean the engine oil from component parts before starting the vehicle.

**!** **NOTE** Engine damage caused by an incorrect oil filter, incorrect oil or additives

- ▶ Do not use engine oils or oil filters which do not correspond to the specifications explicitly prescribed for the service intervals.
- ▶ Do not alter the engine oil or oil filter in order to achieve longer change intervals than prescribed.
- ▶ Do not use additives.
- ▶ Follow the instructions in the service interval display regarding the oil change.

**!** **NOTE** Damage caused by topping up too much engine oil

Topping up too much engine oil can cause damage to the engine or the catalytic converter.

- ▶ Have excess engine oil siphoned off at a qualified specialist workshop.

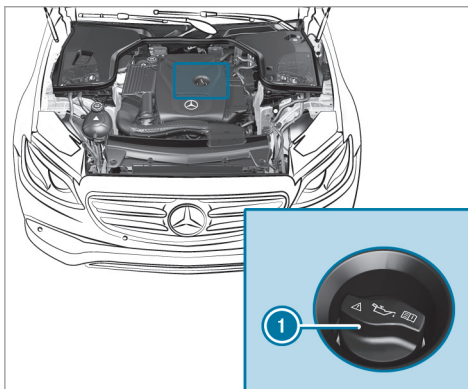

- ▶ Turn cap ① counter-clockwise and remove it.
- ▶ Add engine oil.
- ▶ Replace cap ① and turn it clockwise as far as it will go.
- ▶ Check the oil level again (→ page 303).

### Checking coolant level

**!** **WARNING** Risk of burns from hot component parts in the engine compartment

Certain component parts in the engine compartment can be very hot, e.g. the engine, the cooler and parts of the exhaust system.

- ▶ Let the engine cool down and only touch the component parts described as follows.

**!** **WARNING** Danger of burns from hot coolant

The engine cooling system is pressurized, particularly when the engine is warm. If you

open the cap, you could be scalded by hot coolant spraying out.

- ▶ Let the motor cool down before opening the cap.
- ▶ When opening the cap, wear gloves and protective eyewear.
- ▶ Slowly turn the cap half a turn to allow pressure to escape.

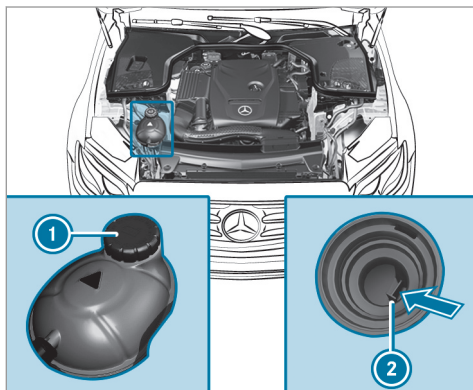

- ▶ Park the vehicle on a flat surface.
- ▶ Check the coolant temperature display in the instrument cluster. The coolant temperature must be below 158 °F (70 °C).
- ▶ Slowly turn cap ① counter-clockwise to relieve overpressure.
- ▶ Continue turning cap ① counter-clockwise and remove it.

The coolant level is correct:

- If the engine is cold, up to marker bar ②
- If the engine is warm, up to 0.6 in (1.5 cm) over marker bar ②
- ▶ If necessary, add coolant that has been tested and approved by Mercedes-Benz.
- Further information on coolant (→ page 370)

### Refilling the windshield washer system

**⚠ WARNING** Risk of burns from hot component parts in the engine compartment

Certain component parts in the engine compartment can be very hot, e.g. the engine, the cooler and parts of the exhaust system.

- ▶ Let the engine cool down and only touch the component parts described as follows.

**⚠ WARNING** Danger of burns when opening the engine hood

If you open the engine hood when the engine has overheated or during a fire in the engine compartment, you could come into contact with hot gases or other escaping operating fluids.

- ▶ Before opening the engine hood, allow the engine to cool down.
- ▶ In the event of a fire in the engine compartment, keep the engine hood closed and call the fire service.

**⚠ WARNING** - Risk of fire and injury from windshield washer concentrate

Windshield washer concentrate is highly flammable. It could ignite if it comes into contact with hot engine component parts or the exhaust system.

- ▶ Make sure that no windshield washer concentrate spills out next to the filler opening.

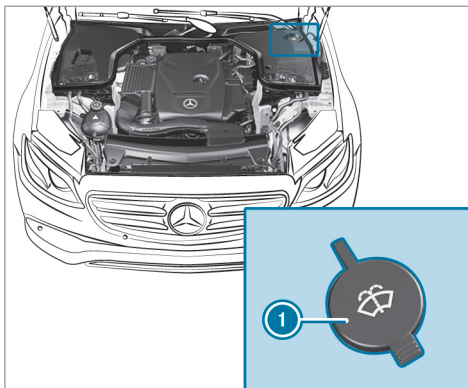

- ▶ Remove cap ① by the tab.
- ▶ Add washer fluid.

**Cleaning and care**

**Information on washing the vehicle in a car wash**

**⚠ WARNING** Risk of accident due to reduced braking effect after washing the vehicle

The braking effect is reduced after washing the vehicle.

- ▶ After the vehicle has been washed, brake carefully while paying attention to the traffic conditions until the braking effect has been fully restored.

To avoid damage to your vehicle when using a car wash, ensure the following beforehand:

- Distance Pilot DISTRONIC and the HOLD function are switched off.
- The 360° Camera or the rear view camera is switched off.
- The side windows and sliding sunroof are completely closed.

- The blower for the ventilation/heating is switched off.
  - The windshield wiper switch is in position **0**.
  - In car washes with a towing mechanism: neutral **N** is engaged.
  - The SmartKey is at a distance of at least 10 ft (3 m) away from the vehicle, otherwise the trunk lid could open unintentionally.
- i** If you remove the wax from the windshield and the wiper rubber after the car wash you will avoid smearing and reduce the noise made by the windshield wipers.

### Information on using a high-pressure cleaner

**⚠ WARNING** Risk of accident when using high-pressure cleaning equipment with round-spray nozzles

The water jet from a round-spray nozzle (dirt grinder) may cause damage to tires and suspension components that is not visible.

Components damaged in this way may fail unexpectedly.

- ▶ Do not use high-pressure cleaning equipment with round-spray nozzles to clean your vehicle.
- ▶ Damaged tires or suspension components must be replaced immediately.

To avoid damage to your vehicle, observe the following when using a high-pressure cleaner:

- Keep the SmartKey at least 10 ft (3 m) away from the vehicle. Otherwise the trunk lid could open unintentionally.
- Maintain a distance of at least 11.8 in (30 cm) to the vehicle and observe the information in the manufacturer's operating instructions.
- Do not point the nozzle of the high-pressure cleaner directly at sensitive parts such as tires, slits, electrical component parts, batteries, light sources and ventilation slots.

### Washing the vehicle by hand

Observe legal requirements, for example in some countries washing by hand is only allowed at specially equipped washing bays.

- ▶ Use a mild cleaning agent such as car shampoo.
- ▶ Wash the vehicle with lukewarm water and a soft car sponge. While doing so, do not expose the vehicle to direct sunlight.
- ▶ Hose down the vehicle carefully with water and dry it with a leather cloth. Make sure that the water jet is not pointed directly into the air inlet grille.

### Notes on caring for the paintwork/matt finish paintwork

Observe the following information:

	Information on cleaning and care	Avoiding damage to the paintwork
<b>Paint</b>	<ul style="list-style-type: none"> <li>• Insect remains: soak with insect remover and rinse off the treated areas afterwards.</li> <li>• Bird droppings: soak with water and rinse off afterwards.</li> <li>• Coolant, brake fluid, tree resins, oils, fuel and greases: gently rub with a cloth soaked in petroleum ether or lighter fluid.</li> <li>• Tar stains: use tar remover.</li> <li>• Wax: use silicone remover.</li> </ul>	<ul style="list-style-type: none"> <li>• Do not apply stickers, films etc.</li> <li>• Remove dirt immediately, where possible.</li> </ul>
<b>Matt finish</b>	<ul style="list-style-type: none"> <li>• The vehicle should preferably be washed by hand using a soft sponge, car shampoo and plenty of water.</li> <li>• Only use care products recommended by Mercedes-Benz.</li> </ul>	<ul style="list-style-type: none"> <li>• Do not polish the vehicle and light-alloy wheels.</li> <li>• Do not have your vehicle cleaned at an automatic car wash too frequently and do not use wash programs which finish with a hot wax vehicle treatment.</li> <li>• Do not use paint cleaner, buffing or polishing products such as a gloss preserver, e.g. wax.</li> <li>• Always have paintwork repairs carried out at a qualified specialist workshop.</li> </ul>

### Notes on care of vehicle parts

**⚠ WARNING** Risk of entrapment if the windshield wipers are switched on while the windshield is being cleaned

If the windshield wipers are set in motion while you are cleaning the windshield or wiper blades, you can be trapped by the wiper arm.

▶ Always switch off the windshield wipers and the ignition before cleaning the windshield or wiper blades.

**⚠ WARNING** Risk of burns from tailpipes and tailpipe trim

The tailpipe and tailpipe trim can become very hot. If you come into contact with these parts of the vehicle, you could burn yourself.

▶ Always be particularly careful around the tailpipe and the tailpipe trim.

▶ Allow the vehicle parts to cool down before you touch them.

### Observe the following information:

Information on cleaning and care		Avoiding vehicle damage
<b>Wheels/rims</b>	Use water and acid-free wheel cleaners.	<ul style="list-style-type: none"> <li>• Do not use acidic wheel cleaners to remove brake dust. This could damage wheel bolts and brake components.</li> <li>• To avoid corrosion of the brake disks and brake linings, drive the vehicle for a few minutes after cleaning before parking it. The brake disks and brake linings warm up and dried out.</li> </ul>
<b>Windows</b>	Clean the windows on the inside and outside using a damp cloth and cleaning products recommended by Mercedes-Benz.	Do not use dry cloths, abrasive products or cleaning agents containing solvents to clean the inside of the windows.

	Information on cleaning and care	Avoiding vehicle damage
<b>Wiper blades</b>	Fold out the wiper blades and clean them using a damp cloth.	Do not clean the wiper blades too often.
<b>Exterior lighting</b>	Clean the lens with a wet sponge and mild detergent, e.g. car shampoo.	Only use cleaning agents or cleaning cloths that are suitable for plastic lenses.
<b>AIRPANEL</b>	<p>If the vehicle is very dusty or there are salt deposits in the AIRPANEL mechanics, the adjustment range of the shutters in the radiator trim may be restricted.</p> <ul style="list-style-type: none"> <li>• Switch on the ignition, and the shutters open automatically after approximately 120 seconds.</li> <li>• Clean the bearing points of the shutters with a high-pressure water jet.</li> </ul>	When using a high-pressure water jet, maintain a minimum distance of 11.8 in (30 cm).
<b>Sensors</b>	Clean the sensors in the front and rear bumpers and in the radiator grill with a soft cloth and car shampoo.	When using a high-pressure water jet, maintain a minimum distance of 11.8 in (30 cm).
<b>Rear view camera and 360° Camera</b>	<ul style="list-style-type: none"> <li>• Open the camera cover with the multimedia system(→ page 180) .</li> <li>• Use clear water and a soft cloth to clean the camera lens.</li> </ul>	Do not use a high-pressure water jet.



	Information on cleaning and care	Avoiding vehicle damage
<b>Tailpipes</b>	Clean with cleaning agents recommended by Mercedes-Benz, particularly in the winter and after washing the vehicle.	Use acid-free cleaning agents.
<b>Trailer hitch</b>	<ul style="list-style-type: none"> <li>• Remove rust on the ball, e.g. with a wire brush.</li> <li>• Remove dirt with a lint-free cloth.</li> <li>• After cleaning, oil or grease the ball head lightly.</li> <li>• Observe the cleaning instructions in the operating instructions of the trailer hitch manufacturer.</li> </ul>	Do not clean the ball neck with solvents or a power washer.

### Notes on care of the interior

**⚠ WARNING** Risk of injury from plastic parts breaking off after the use of solvent-based care products

Care and cleaning products containing solvents can cause surfaces in the cockpit to become porous.

When the airbags are deployed, plastic parts may break away.

- ▶ Do not use any care or cleaning products containing solvents to clean the cockpit.

**⚠ WARNING** Risk of injury or death from bleached seat belts

Bleaching or dyeing seat belts can severely weaken them.

This can, for example, cause seat belts to tear or fail in an accident.

- ▶ Never bleach or dye seat belts.

**Observe the following information:**

	<b>Information on cleaning and care</b>	<b>Avoiding vehicle damage</b>
<b>Seat belts</b>	Clean with warm water and soap solution.	<ul style="list-style-type: none"> <li>Do not use chemical cleaning agents.</li> <li>Do not dry seat belts by heating them to over 176 °F (80 °C) or exposing them to direct sunlight.</li> </ul>
<b>Display</b>	Clean the surface carefully with a microfiber cloth and TFT/LCD display cleaner.	<ul style="list-style-type: none"> <li>Switch off the display and allow to cool.</li> <li>Do not use any other cleaning products.</li> </ul>
<b>Plastic trim</b>	<ul style="list-style-type: none"> <li>Clean with a damp microfiber cloth.</li> <li>If the trim is very dirty: use a cleaning agent recommended by Mercedes-Benz.</li> </ul>	<ul style="list-style-type: none"> <li>Do not apply stickers, films etc.</li> <li>Do not allow cosmetics, insect repellent or sun cream to come in contact with the plastic trim.</li> </ul>
<b>Genuine wood/trim elements</b>	<ul style="list-style-type: none"> <li>Clean with a microfiber cloth.</li> <li>Black piano-lacquer look: clean with a damp cloth and soap solution.</li> <li>If the trim is very dirty: use a cleaning agent recommended by Mercedes-Benz.</li> </ul>	Do not use solvent-based cleaning agents, polishes or waxes.
<b>Roof lining</b>	Clean with a brush or dry shampoo.	
<b>Carpet</b>	Use carpet and textile cleaning agents recommended by Mercedes-Benz.	

	Information on cleaning and care	Avoiding vehicle damage
<b>Genuine leather seat covers</b>	<ul style="list-style-type: none"> <li>• Clean with a damp cloth and then wipe with a dry cloth.</li> <li>• Leather care: use leather care agents that have been recommended by Mercedes-Benz.</li> </ul>	<p>Do not allow the leather to become too damp.</p> <p>Do not use a microfiber cloth.</p>
<b>DINAMICA seat covers</b>	Clean with a damp cloth.	Do not use a microfiber cloth.
<b>Artificial leather seat covers</b>	Clean with a damp cloth and 1% soap solution.	Do not use a microfiber cloth.
<b>Cloth seat covers</b>	Clean with a damp cloth and 1% soap solution and allow to dry.	
<b>EASY-PACK trunk box</b>	Clean with a damp cloth.	Do not use any alcohol-based thinners, gasoline or abrasive cleaning agents.

## Emergency

### Removing the safety vest

The safety vests are located in the safety vest compartments in the front door stowage compartments.

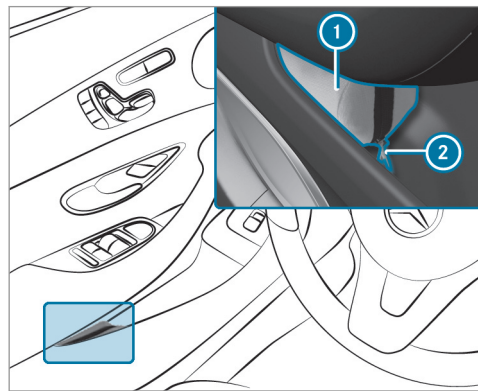

▶ **To remove:** pull out safety vest bag ① by loop ②.

▶ Open safety vest bag ① and pull out the safety vest.

① There are also safety vest compartments in the rear door stowage compartments, in which safety vests can be stowed.

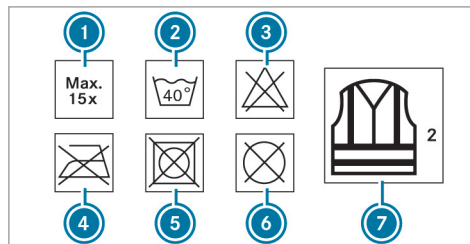

- ① Maximum number of washes
- ② Maximum wash temperature
- ③ Do not bleach
- ④ Do not iron
- ⑤ Do not use a laundry dryer
- ⑥ Do not dry-clean
- ⑦ This is a class 2 vest

The requirements defined by the legal standard are only fulfilled if the safety vest is the correct size and is fully closed.

Replace the safety vest, if:

- It is damaged or dirt on the reflective strips can no longer be removed.
- The maximum number of washes is exceeded.
- The fluorescence of the safety vest has faded.

## Flat tire

### Notes on flat tires

**⚠ WARNING** Risk of accident due to a flat tire

A flat tire severely affects the driving characteristics as well as the steering and braking behavior of the vehicle.

Tires without run-flat characteristics:

- ▶ Do not drive on with a flat tire.

- ▶ Replace the flat tire immediately with the emergency spare wheel/ spare wheel or consult a qualified specialist workshop.
- ▶ **Run-flat tires:** Observe the information and warning notices for MOExtended tires (run-flat tires).

In the event of a flat tire, the following options are available depending on your vehicle's equipment:

- **Vehicles with MOExtended tires:** it is possible to continue the journey for a short period of time. Make sure you observe the notes on MOExtended tires (run-flat tires) (→ page 315).
  - **Vehicles with a TIREFIT kit:** you can repair the tire and continue the journey for a short period of time only. To do this, use the TIREFIT Kit (→ page 316).
  - **Vehicles with a Mercedes-Benz emergency call system:** in the event of a flat tire, consult the Customer Center of the Mercedes-Benz emergency call system.
- Change the wheel (→ page 356).

### MOExtended tires (run-flat tires)

With MOExtended tires (run-flat tires), you can continue to drive your vehicle even if there is a total loss of pressure in one or more tires. However, the tire affected must not show any clearly visible damage.

You can recognize MOExtended tires by the MOExtended marking which appears on the side wall of the tire.

**Vehicles with a tire pressure monitoring system:** MOExtended tires may only be used in conjunction with an activated tire pressure monitoring system.

If a pressure loss warning message appears in the multifunction display:

- Check the tire for damage
- If driving on, observe the following notes

### ⚠ WARNING Risk of accident when driving in limp-home mode

When driving in limp-home mode, the handling characteristics are impaired. e.g. when cornering, when accelerating strongly and when braking.

- ▶ Do not exceed the maximum permissible speed.
- ▶ Avoid any abrupt steering and driving maneuvers as well as driving over obstacles (curbs, pot holes, cross-country). This applies, in particular, to a loaded vehicle.
- ▶ Stop driving in limp-home mode if you notice:
  - banging noise
  - vehicle vibration
  - smoke which smells like rubber
  - continuous ESP® intervention
  - cracks in tire side walls
- ▶ After driving in limp-home mode, have the rims checked by a qualified special-

ist workshop with regard to their further use.

- ▶ The defective tire must be replaced in every case.

### Driving distance possible in limp-home mode after the pressure loss warning

Load condition	Driving distance possible in limp-home mode
Partially laden	50 miles (80 km)
Fully laden	19 miles (30 km)

- The driving distance possible in limp-home mode may vary depending on the driving style.
- Maximum permissible speed 50 mph (80 km/h).

If a tire has gone flat and cannot be replaced with an MOExtended tire, a standard tire may be used as a temporary measure.

### TIREFIT kit storage location

The TIREFIT kit is located under the trunk floor.

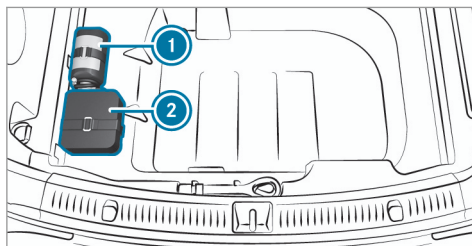

- ① Tire sealant bottle
- ② Tire inflation compressor

### Using the TIREFIT kit

Have the following readily available:

- Tire sealant filler bottle
- Enclosed TIREFIT sticker
- Tire inflation compressor

You can use TIREFIT tire sealant to seal punctures of up to 0.16 in (4 mm), particularly those in the tire contact surface. You can use TIREFIT in outside temperatures down to -4 °F (-20 °C).

#### ⚠ WARNING Risk of accident when using tire sealant

In the following situations, the tire sealant is unable to provide sufficient breakdown assistance, as it is unable to seal the tire properly:

- There are cuts or punctures in the tire larger than those previously mentioned.
- The wheel rim is damaged.
- You have driven at very low tire pressures or on a flat tire.

- ▶ Do not drive any further.
- ▶ Consult a qualified specialist workshop.

#### ⚠ WARNING Risk of injury and poisoning from tire sealant

The tire sealant is harmful and causes irritation. Do not allow it to come into contact

with the skin, eyes or clothing, and do not swallow it. Do not inhale tire sealant fumes. Keep the tire sealant away from children.

If you come into contact with the tire sealant, observe the following:

- ▶ Rinse off the tire sealant from your skin immediately using water.
- ▶ If tire sealant gets into your eyes, thoroughly rinse out the eyes using clean water.
- ▶ If tire sealant has been swallowed, immediately rinse out the mouth thoroughly and drink plenty of water. Do not induce vomiting and seek medical attention immediately.
- ▶ Change out of any clothes contaminated with tire sealant immediately.
- ▶ If allergic reactions occur, seek medical attention immediately.

**!** **NOTE** Overheating due to the tire inflation compressor running too long

- ▶ Do not run the tire inflation compressor for longer than ten minutes without interruption.

Comply with the manufacturer's safety notes on the sticker on the tire inflation compressor.

Have the tire sealant bottle replaced every four years at a qualified specialist workshop.

- ▶ Do not remove any foreign objects which have penetrated the tire.

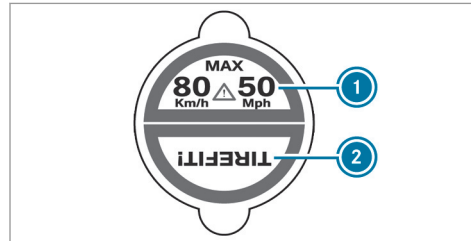

- ▶ Affix part ① of the TIREFIT sticker to the instrument cluster within the driver's field of vision.
- ▶ Affix part ② of the TIREFIT sticker near the valve on the wheel with the defective tire.

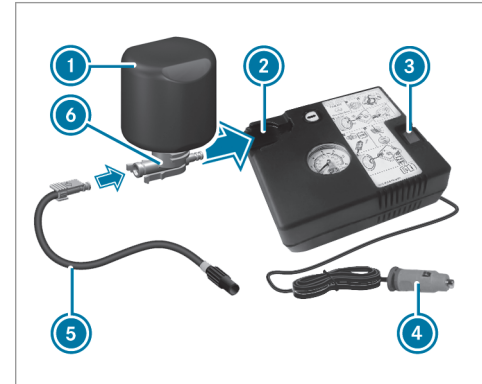

- ▶ Pull plug ④ with the cable and hose ⑤ out of the tire inflation compressor housing.

- ▶ Push the plug of hose ⑤ into flange ⑥ of tire sealant bottle ①, until the plug engages.
- ▶ Place tire sealant bottle ① head downwards into recess ② of the tire inflation compressor.



- ▶ Remove the cap from valve ⑦ on the faulty tire.
- ▶ Screw filling hose ⑧ onto valve ⑦.
- ▶ Insert plug ④ into a 12 V socket in your vehicle.
- ▶ Switch on the ignition.

- ▶ Press on and off switch ③ on the tire inflation compressor. The tire inflation compressor is switched on. The tire is inflated. First, tire sealant is pumped into the tire. The pressure may briefly rise to approximately 500 kPa (5 bar/73 psi).

**Do not switch off the tire inflation compressor during this phase.**

- ▶ Let the tire inflation compressor run for a maximum of ten minutes. The tire should then have attained a tire pressure of at least 200 kPa (2.0 bar/29 psi).

If tire sealant leaks out, make sure you clean the affected area as quickly as possible. It is preferable to use clean water.

If you get tire sealant on your clothing, have it cleaned as soon as possible with perchloroethylene.

**If, after ten minutes, a tire pressure of 200 kPa (2.0 bar/29 psi) has not been achieved:**

- ▶ Switch off the tire inflation compressor.
- ▶ Unscrew the filler hose from the valve of the faulty tire.

Please note that tire sealant may leak out when unscrewing the filling hose.

- ▶ Very slowly drive forwards or reverse approximately 33 ft (10 m).
- ▶ Pump up the tire again. After a maximum of ten minutes the tire pressure must be at least 200 kPa (2.0 bar/29 psi).

**⚠ WARNING** Risk of accident in the event of the specified tire pressure not being reached

If the minimum tire pressure is not reached after the specified time, the tire is too badly damaged. The tire sealant cannot repair the tire in this instance.



Damaged tires and tire pressure that is too low can significantly impair the braking properties and the handling characteristics.

- ▶ Do not continue driving.
- ▶ Consult a qualified specialist workshop.

**If, after ten minutes, a tire pressure of 200 kPa (2.0 bar/29 psi) has been achieved:**

**⚠ WARNING** Risk of accident from driving with sealed tires

A tire temporarily sealed with tire sealant impairs the handling characteristics and is not suitable for higher speeds.

- ▶ Adapt your driving style accordingly and drive carefully.
- ▶ Do not exceed the specified maximum speed with a tire that has been repaired using tire sealant.

- ▶ For a tire sealed with tire sealant, observe the maximum permissible speed of 50 mph (80 km/h).

- ▶ Affix the upper section of the TIREFIT sticker to the instrument cluster where it will be easily seen by the driver.

**! NOTE** Staining caused by leaking tire sealant

After use, excess tire sealant may leak out from the filling hose.

- ▶ Therefore, place the filling hose in the plastic bag that contained the TIREFIT kit.

**! ENVIRONMENTAL NOTE** Environmental pollution caused by environmentally irresponsible disposal

Tire sealant contains pollutants.

- ▶ Have the tire sealant bottle disposed of professionally, e.g. at a Mercedes-Benz service center.

- ▶ Switch off the tire inflation compressor.
- ▶ Unscrew the filler hose from the valve of the faulty tire.

- ▶ Stow the tire sealant bottle, the tire inflation compressor and the warning triangle.

▶ **Pull away immediately.**

- ▶ Stop after driving for approximately ten minutes and check the tire pressure using the tire inflation compressor. The tire pressure must now be at least 130 kPa (1.3 bar/ 19 psi).

**⚠ WARNING** Risk of accident due to the specified tire pressure not being reached

If the specified tire pressure after a brief drive is not reached, the tire is too badly damaged. The tire sealant cannot repair the tire in this instance.

Damaged tires and tire pressure that is too low can significantly impair braking properties and handling characteristics.

- ▶ Do not continue driving.
- ▶ Consult a qualified specialist workshop.

In cases such as the one mentioned above, contact an authorized Mercedes-Benz Center. Or

## 320 Breakdown assistance

call 1-800-FOR-MERCEDES (in the USA) or 1-800-387-0100 (in Canada).

▶ Correct the tire pressure if it is still at least 130 kPa (1.3 bar/ 19 psi). See the Tire and Loading Information placard on the driver's side B-pillar or the tire pressure table in the fuel filler flap for values.

▶ **To increase the tire pressure:** switch on the tire inflation compressor.

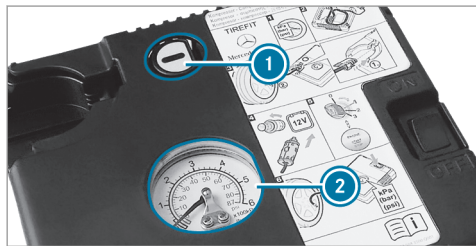

▶ **To reduce the tire pressure:** press pressure release button ① next to manometer ②.

- ▶ When the tire pressure is correct, unscrew the filling hose from the valve of the sealed tire.
- ▶ Screw the valve cap onto the tire valve of the sealed tire.
- ▶ Pull the tire sealant bottle out of the tire inflation compressor. The filling hose stays on the tire sealant bottle.
- ▶ Drive to the nearest qualified specialist workshop and have the tire, tire sealant bottle and filling hose replaced there.

### Battery (vehicle)

#### Notes on the 12 V battery

**⚠ WARNING** Risk of an accident due to work carried out incorrectly on the battery

Work carried out incorrectly on the battery can lead to a short circuit, for example. This can lead to function restrictions applying to

safety-relevant systems, e.g. the lighting system, ABS (anti-lock braking system) or ESP® (Electronic Stability Program).® The operating safety of your vehicle may be restricted.

You could lose control of the vehicle in the following situations:

- when braking
- in the event of abrupt steering maneuvers and/or when the vehicle's speed is not adapted to the road conditions

▶ In the event of a short circuit or a similar incident, contact a qualified specialist workshop immediately.

▶ Do not drive any further.

▶ Always have work on the battery carried out at a qualified specialist workshop.

- Further information on ABS (→ page 149)
- Further information on ESP®(→ page 150)

For safety reasons, Mercedes-Benz recommends that you only use batteries which have been tested and approved for your vehicle by Mercedes-

Benz. These batteries provide increased impact protection to prevent vehicle occupants from suffering acid burns should the battery be damaged in the event of an accident.

**All vehicles except vehicles with a lithium-ion battery**

**⚠ WARNING** Risk of explosion due to electrostatic charge

Electrostatic charge can cause sparks which may ignite the highly flammable gas mixture in the battery.

- ▶ To discharge any electrostatic charge that may have built up, touch the metal vehicle body before handling the battery.

The highly flammable gas mixture forms when charging the battery as well as when jump-starting.

**⚠ WARNING** Danger of chemical burns from the battery acid

Battery acid is caustic.

- ▶ Avoid contact with the skin, eyes or clothing.
- ▶ Do not lean over the battery.
- ▶ Do not inhale battery gases.
- ▶ Keep children away from the battery.
- ▶ Immediately rinse battery acid off thoroughly with plenty of clean water and seek medical attention immediately.

**All vehicles**

**🗑 ENVIRONMENTAL NOTE** Environmental damage caused by improper disposal of batteries



Batteries contain pollutants. It is illegal to dispose of them with the household rubbish.



Dispose of batteries in an environmentally responsible manner. Take discharged batteries to a qualified specialist workshop or to a collection point for used batteries.

If you have to connect the 12 volt battery, contact a qualified specialist workshop.

Comply with safety notes and take protective measures when handling batteries.



Risk of explosion



Fire, open flames and smoking are prohibited when handling the battery. Avoid creating sparks.



Electrolyte or battery acid is corrosive. Avoid contact with skin, eyes or clothing. Wear suitable protective clothing, especially gloves, apron and

faceguard. Immediately rinse electrolyte or acid splashes off with clean water. Consult a doctor if necessary.



Wear eye protection.



Keep children away.



Observe this Operator's Manual.

If you do not intend to use the vehicle over an extended period of time:

- Activate standby mode, or
- Connect the battery to a battery charger approved by Mercedes-Benz, or
- Consult a qualified specialist workshop to disconnect the battery.

### Starting assistance and charging the 12 V battery

#### Vehicles with a lithium-ion battery

- ▶ When charging the battery and during starting assistance, always use the jump-start connection point in the engine compartment.

**!** **NOTE** Damage to the battery from overvoltage

When charging using a battery charger without a maximum charging voltage, the battery or the on-board electronics may be damaged.

- ▶ Only use battery chargers with a maximum charging voltage of 14.4 V.

#### All other vehicles

- ▶ When charging the battery and during starting assistance, always use the jump-start connection point in the engine compartment.

**!** **NOTE** Damaging the battery through overvoltage

When charging using a battery charger without a maximum charging voltage, the battery or the vehicle electronics may be damaged.

- ▶ Only use battery chargers with a maximum charging voltage of 14.8 V.

**!** **WARNING** Risk of explosion from hydrogen gas igniting

A battery generates hydrogen gas during the charging process. If there is a short circuit or sparks start to form, there is a danger of the hydrogen gas igniting.

- ▶ Make sure that the positive terminal of the connected battery does not come into contact with vehicle parts.
- ▶ Never place metal objects or tools on a battery.
- ▶ When connecting and disconnecting the battery, you must observe the described order for the battery clamps.

- ▶ When giving starting assistance, always make sure that you only connect battery terminals with identical polarity.
- ▶ During starting assistance, you must observe the described order for connecting and disconnecting the jumper cables.
- ▶ Do not connect or disconnect the battery clamps while the engine is running.

**⚠ WARNING** Risk of explosion during charging process and starting assistance

During the charging process and starting assistance, the battery may release an explosive gas mixture.

- ▶ Avoid fire, open flames, creating sparks and smoking.
- ▶ Make sure that there is sufficient ventilation during the charging process and during starting assistance.
- ▶ Do not lean over a battery.

If the indicator/warning lamps in the instrument cluster do not light up at low temperatures, it is very likely that the discharged battery has frozen.

**⚠ WARNING** Risk of explosion from a frozen battery

A discharged battery may freeze at temperatures slightly above or below freezing point.

During starting assistance or battery charging, battery gas may be released.

- ▶ Always thaw a frozen battery out first before charging it or performing starting assistance.

**⚠ NOTE** Shortening the service life of the battery by charging the battery at low temperatures

Charging the battery at very low temperatures may shorten the service life of the battery and have a negative effect on starting.

- ▶ Do not charge the battery at very low temperatures.

It is recommended that you have the thawed battery checked at a qualified specialist workshop.

**All vehicles**

**⚠ NOTE** Damage caused by numerous or extended attempts to start the engine

Numerous or extended attempts to start the engine may damage the catalytic converter due to non-combusted fuel.

- ▶ Avoid numerous and extended attempts to start the engine.

Observe the following points during starting assistance and when charging the battery:

- Only use undamaged jumper cables/charging cables with a sufficient cross-section and insulated terminal clamps.
- Non-insulated parts of the terminal clamps must not come into contact with other metal parts while the jumper cable/charging cable is connected to the battery/jump-start connection point.

- The jumper cable/charging cable must not come into contact with any parts which may move when the engine is running.
- Always make sure that neither you nor the battery is electrostatically charged.
- Keep away from fire and open flames.
- Do not lean over the battery.
- **When charging:** only use battery chargers tested and approved by Mercedes-Benz and read the battery charger's operating instructions before charging the battery.

Observe the additional following points during starting assistance:

- Starting assistance may only be provided using batteries with a nominal voltage of 12 V.
  - The vehicles must not touch.
  - **Gasoline engine:** Only accept starting assistance if the engine and exhaust system are cold.
- ▶ Secure the vehicle by applying the electric parking brake.

- ▶ **Automatic transmission:** Shift the transmission to position **P**.
- ▶ Make sure that the ignition and all electrical consumers are switched off.
- ▶ Open the hood.

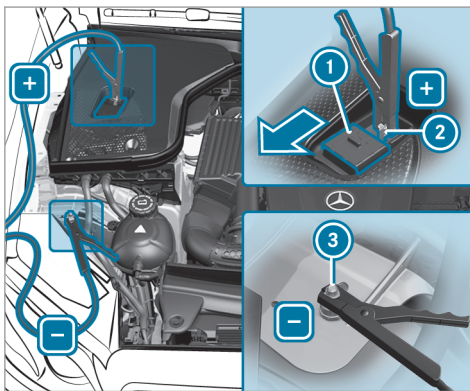

- ▶ Slide cover **1** of positive clamp **2** on the jump-starting connection point in the direction of the arrow.

- ▶ Connect positive clamp **2** on your vehicle to the positive pole of the donor battery using the jumper cable/charging cable. Always begin with positive clamp **2** on your own vehicle first.
- ▶ **During the starting assistance procedure:** start the engine of the donor vehicle and run at idle speed.
- ▶ Connect the negative pole of the donor battery and ground point **3** of your own vehicle by using the jumper cable/charging cable. Begin with the donor battery first.
- ▶ **During starting assistance:** start the engine of your own vehicle.
- ▶ **During the charging process:** start the charging process.
- ▶ **During starting assistance:** let the engines run for several minutes.
- ▶ **During starting assistance:** before disconnecting the jumper cable, switch on an electrical consumer on your own vehicle, e.g. the rear window heater or lighting.

When the starting assistance/charging process is complete:

- ▶ First, remove the jumper cable/charging cable from ground point ③ and the negative pole of the donor battery, then from positive clamp ② and the positive pole of the donor battery. Begin each time at the contacts on your own vehicle first.
- ▶ After removing the jumper cable/charging cable, close cover ① of positive clamp ②.

You can obtain further information on starting assistance at any qualified specialist workshop.

### Tow starting or towing away

#### Towing away the vehicle

Mercedes-Benz recommends transporting your vehicle in the case of a breakdown, rather than towing it away.

**!** **NOTE** Damage to the vehicle due to towing away incorrectly

- ▶ Observe the instructions and notes on towing away.

Permitted towing methods:

- Vehicles with transmission damage must be transported (→ page 327).
- **Vehicles with automatic transmission:** only with both axles on the ground.
- **4MATIC vehicles:** only with both axles on the ground.

**!** **WARNING** Risk of accident due to limited safety-related functions during the towing process

Safety-related functions are limited or no longer available in the following situations:

- the ignition is switched off.
- the brake system or power steering system is malfunctioning.

- the energy supply or the on-board electrical system is malfunctioning.

When your vehicle is then towed away, significantly more effort may be required to steer and brake than is normally required.

- ▶ Use a tow bar.
- ▶ Make sure that the steering wheel can move freely, before towing the vehicle away.

**!** **NOTE** Damage due to towing away at excessively high speeds or over long distances

The drivetrain could be damaged when towing at excessively high speeds or over long distances.

- ▶ A towing speed of 31 mph (50 km/h) must not be exceeded.
- ▶ A towing distance of 31 miles (50 km) must not be exceeded.

If a vehicle must be tow started or towed away, its weight must not exceed the permissible gross mass of the towing vehicle.

**⚠ WARNING** Risk of accident when towing a vehicle which is too heavy

If the vehicle being tow-started or towed away is heavier than the permissible gross mass of your vehicle, the following situations can occur:

- The towing eye may become detached.
- The vehicle/trailer combination may swerve or even overturn.

▶ If another vehicle is tow-started or towed away, its weight must not exceed the permissible gross mass of your own vehicle.

▶ Information on the permissible gross mass of the vehicle can be found on the vehicle identification plate .

During the towing procedure, observe the following:

- Deactivate the DISTRONIC distance pilot.
  - Do not activate the HOLD function.
  - **Vehicles with automatic transmission:** Do not open the driver's door or front passenger door, otherwise the automatic transmission automatically shifts to position **P**.
- ▶ Make sure that the battery is connected and charged.

When the battery is discharged:

- The engine cannot be started.
  - The electric parking brake cannot be released or applied.
  - **Vehicles with automatic transmission:** The automatic transmission cannot be shifted to position **N** or **P**.
- ▶ Install the towing eye (→ page 328).
- ▶ Attach the tow bar.

**!** **NOTE** Damage due to incorrect connection

▶ Only connect the tow rope or tow bar to the towing eyes.

▶ Deactivate the automatic locking mechanism (→ page 62).

▶ Deactivate Active Brake Assist (→ page 157).

▶ **Vehicles with automatic transmission:** Shift the automatic transmission to position **N**.

**i** **Vehicles with automatic transmission:** If the automatic transmission cannot be shifted to position **N**, transport the vehicle (→ page 327).

▶ **When towing away with the rear axle raised:** move the front wheels into the straight-ahead position.

▶ **When towing away with one axle raised:** switch on the power supply.

▶ **When towing away with both axles on the ground:** switch on the ignition.



- ▶ Release the electric parking brake.

**!** **NOTE** Damage due to excessive tractive power

If you pull away sharply, the tractive power may be too high and the vehicles could be damaged.

- ▶ Pull away slowly and smoothly.

### Loading the vehicle for transport

Transportation of vehicles should only be carried out by professional recovery companies.

- ▶ Observe the notes on towing away (→ page 325).
- ▶ Connect the tow bar to the towing eye to load the vehicle.
- ▶ **Vehicles with automatic transmission:** Shift the automatic transmission to position **N**.
- i** **Vehicles with automatic transmission:** The automatic transmission may be locked in position **P** in the event of damage to the

electrics. To shift to **N**, provide the on-board electrical system with power (→ page 322).

- ▶ Load the vehicle onto the transporter.
- ▶ **Vehicles with automatic transmission:** Shift the automatic transmission to position **P**.
- ▶ Use the electric parking brake to secure the vehicle and prevent it from rolling away.
- ▶ Only secure the vehicle by the wheels.

### 4MATIC vehicles/vehicles with automatic transmission

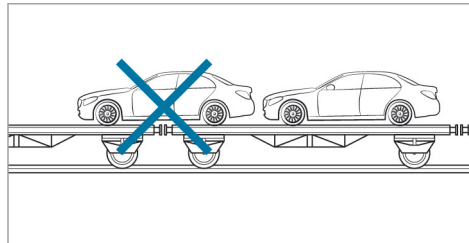

- ▶ Make sure that the front and rear axles come to rest on the same transport vehicle.

**!** **NOTE** Damage to the drivetrain due to incorrect positioning

- ▶ Do not position the vehicle above the connection point of the transport vehicle.

### Towing eye

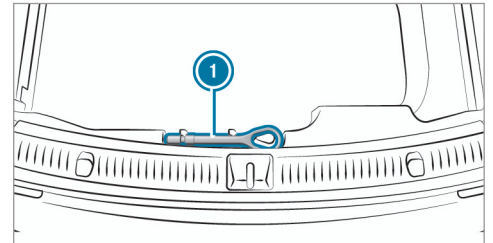

Towing eye **1** is attached to the edge of the cargo compartment under the cargo compartment floor.

### Installing the towing eye

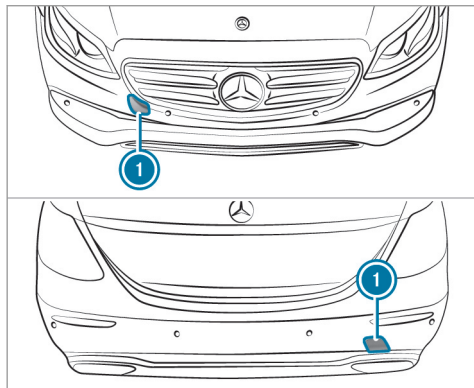

- ▶ Press the mark on cover ① inwards and remove.
- ▶ Screw in the towing eye clockwise to the stop.
- ⓘ Make sure that cover ① engages in the bumper when you remove the towing eye.

**!** **NOTE** Damage due to incorrect use of the towing eye

When a towing eye is used to recover a vehicle, the vehicle may be damaged in the process.

- ▶ Only use the towing eye to tow away or tow start the vehicle.

### Tow starting the vehicle (emergency engine start)

**!** **NOTE** Damage to the automatic transmission due to tow starting

The automatic transmission may be damaged in the process of tow starting vehicles with automatic transmission.

- ▶ Vehicles with automatic transmission must not be tow started.

### Electrical fuses

#### Notes on electrical fuses

**!** **WARNING** Risk of accident and injury due to overloaded lines

If you manipulate or bridge a faulty fuse or if you replace it with a fuse with a higher amperage, the electric line could be overloaded.

This could result in a fire.

- ▶ Always replace faulty fuses with specified new fuses containing the correct amperage.

**!** **NOTE** Damage caused by incorrect fuses

Incorrect fuses may cause damage to electrical components or systems.

- ▶ Only use Mercedes-Benz approved fuses with the correct fuse rating.

Blown fuses must be replaced with fuses of the same rating, which you can recognize by the

color and fuse rating. The fuse ratings are listed in the fuse assignment diagram.

**Fuse assignment diagram:** on the fuse box in the trunk (→ page 331).

**!** **NOTE** Damage or malfunctions caused by moisture

Moisture may cause damage to the electrical system or cause it to malfunction.

- ▶ When the fuse box is open, make sure that no moisture can enter the fuse box.
- ▶ When closing the fuse box, make sure that the seal of the lid is positioned correctly on the fuse box.

If a newly inserted fuse also blows, have the cause traced and rectified at a qualified specialist workshop.

Ensure the following before replacing a fuse:

- The vehicle is secured against rolling away.
- All electrical consumers are switched off.
- The ignition is switched off.

The electrical fuses are located in various fuse boxes:

- Fuse box in the engine compartment on the driver's side (→ page 329)
- Fuse box on the driver's side of the cockpit (→ page 330)
- Fuse box in the front-passenger footwell (→ page 330)
- Fuse box in the trunk on the right-hand side of the vehicle, when viewed in the direction of travel (→ page 331)

### Fuse box in the engine compartment

#### Prerequisites

Observe the notes on electrical fuses (→ page 328).

Have the following readily available:

- A dry cloth
- A screwdriver

### Opening

**!** **WARNING** Risk of injury from using the windshield wipers while the engine hood is open

When the engine hood is open and the windshield wipers are set in motion, you can be trapped by the wiper linkage.

- ▶ Always switch off the windshield wipers and ignition before opening the engine hood.

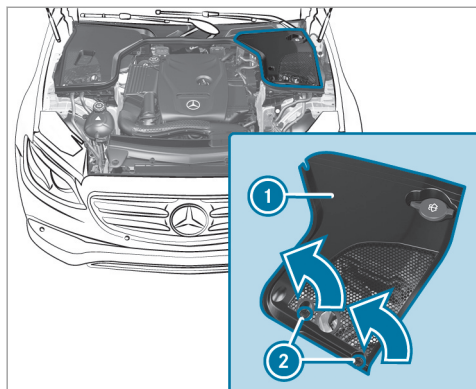

- ▶ Turn clip ② on cover ① a quarter-turn to the left.
- ▶ Pull cover ① upwards in the direction of the arrow.

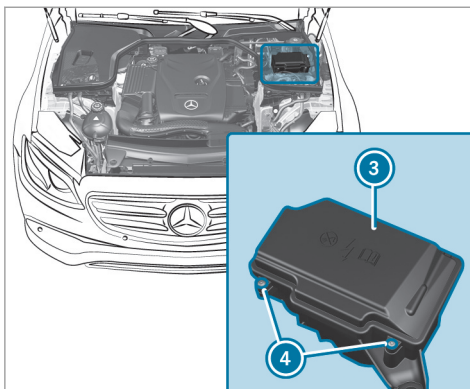

- ▶ Remove any existing moisture from the fuse box using a dry cloth.
- ▶ Loosen screws ④, remove fuse box lid ③ from the top.

#### Closing

- ▶ Check whether the seal is positioned correctly in the lid.

- ▶ Insert lid into the bracket at the rear of the fuse box.
- ▶ Fold down lid of the fuse box and tighten screws ④.
- ▶ Insert cover ① on both sides and engage safety clips.
- ▶ Close the hood.

#### Cockpit fuse box

The fuse box is on the side of the dashboard under a cover.

- ▶ Contact an authorized Mercedes-Benz Center for further information.

#### Fuse box in the front-passenger footwell

##### Prerequisites

Observe the notes on electrical fuses (→ page 328).

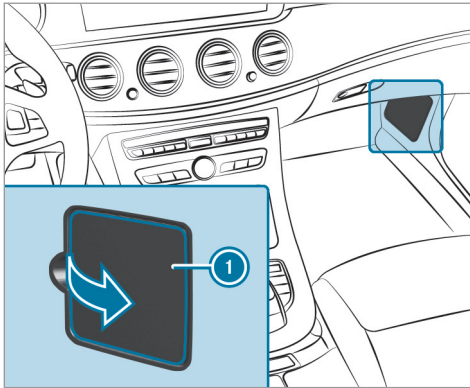

- ▶ Open cover ❶ in the direction of the arrow and remove it.

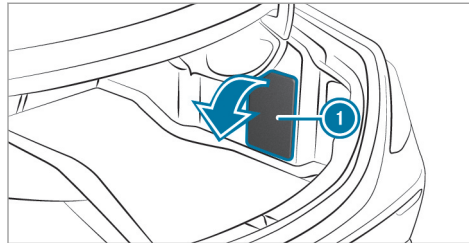

- ▶ Fold cover ❶ down in the direction of the arrow.

The fuse assignment diagram is in a recess on the side of the fuse box.

### Fuse box in the trunk

#### Prerequisites

Observe the notes on electrical fuses  
(→ page 328).

### Noise or unusual handling characteristics

While driving, pay attention to vibrations, noises and unusual handling characteristics, e.g. pulling to one side. This may indicate that the wheels or tires are damaged. If you suspect that a tire is defective, reduce your speed immediately. Stop the vehicle as soon as possible to check the wheels and tires for damage. Hidden tire damage could also be causing the unusual handling characteristics. If you find no signs of damage, have the tires and wheels checked at a qualified specialist workshop.

### Regular checking of wheels and tires

**⚠ WARNING** Risk of accident from damaged tires

Damaged tires can cause tire pressure loss. As a result, you could lose control of your vehicle.

- ▶ Check the tires regularly for signs of damage and replace any damaged tires immediately.

**⚠ WARNING** Risk of aquaplaning due to insufficient tire tread

Insufficient tire tread will result in reduced tire grip. The tire tread is no longer able to dissipate water.

This means that in heavy rain or slush the risk of hydroplaning is increased, in particular if vehicle speed is not adapted to suit the conditions.

If the tire pressure is too high or too low, tires may exhibit different levels of wear at different locations on the tire contact surface.

- ▶ Thus, you should regularly check the tread depth and the condition of the tire contact surface across the entire width of all tires.

Minimum tread depth for:

- Summer tires:  $\frac{1}{8}$  in (3 mm)
- M+S tires:  $\frac{1}{6}$  in (4 mm)

- ▶ For safety reasons, replace the tires before the legally prescribed limit for the minimum tread depth is reached.

Carry out the following checks on all wheels regularly, at least once a month or as required, e.g. prior to a long journey or driving off-road:

- Check the tire pressure (→ page 333).
- Visual check of wheels and tires for damage.
- Check the valve caps.

The valves must be protected against moisture and dirt by the valve caps approved especially for your vehicle by Mercedes-Benz.

- Visual check of the tread depth and the tire contact surface across the entire width.

The minimum tread depth for summer tires is  $\frac{1}{8}$  in (3 mm) and for winter tires  $\frac{1}{6}$  in (4 mm).

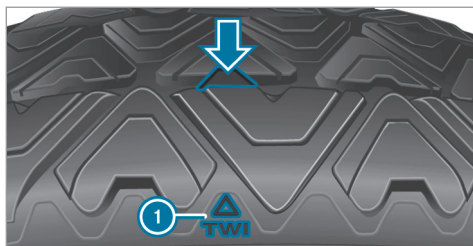

Six marks ① show where the bar indicators (arrow) are integrated into the tire tread. They are visible once a tread depth of approximately  $\frac{1}{16}$  in (1.6 mm) has been reached.

### Notes on snow chains

**⚠ WARNING** Risk of accident due to incorrect mounting of snow chains

If you have mounted snow chains to the front wheels, the snow chains may drag against the vehicle body or chassis components.

This could cause damage to the vehicle or the tires.

- ▶ Never mount snow chains on the front wheels.
- ▶ Only mount snow chains on the rear wheels in pairs.

**⚠ NOTE** Damage to the wheel trim from mounted snow chains

If snow chains are mounted to steel wheels, the wheel trims can be damaged.

- ▶ Remove the wheel trims of steel wheels before mounting snow chains.

- Snow chains are only permissible for certain wheel/tire combinations. You can obtain information about this from an authorized Mercedes-Benz Center.
- For safety reasons, only use snow chains that have been specifically approved for your vehicle by Mercedes-Benz, or snow chains with the same quality standard.

- If snow chains are mounted, the maximum permissible speed is 30 mph (50 km/h).
- **Vehicles with Parking Pilot:** Do not use Parking Assist PARKTRONIC if snow chains are mounted.
- **Vehicles with AIR BODY CONTROL:** If snow chains have been mounted you must drive at a raised vehicle level.
- ① You can deactivate ESP® to pull away (→ page 153). This allows the wheels to spin, achieving an increased driving force.

### Tire pressure

#### Notes on tire pressure

**⚠ WARNING** Risk of accident due to insufficient or excessive tire pressure

Underinflated or overinflated tires pose the following risks:

- The tires may burst, especially as the load and vehicle speed increase.

- The tires may wear excessively and/or unevenly, which may greatly impair tire traction.
- The driving characteristics, as well as steering and braking, may be greatly impaired.
- ▶ Comply with the recommended tire pressure and check the tire pressure of all tires including the spare wheel regularly:
  - at least once a month
  - when the load changes
  - before embarking on a longer journey
  - if operating conditions change, e.g. off-road driving
- ▶ Adjust the tire pressure as necessary.

Driving with tire pressure that is too high or too low can:

- Shorten the service life of the tires.
- Cause increased tire damage.

- Adversely affect handling characteristics and thus driving safety, e.g. due to hydroplaning.

**⚠ WARNING** Risk of an accident due to insufficient tire pressure

Tires with pressure that is too low can overheat and burst as a result.

In addition, they also suffer from excessive and/or irregular wear, which can significantly impair the braking properties and the handling characteristics.

- ▶ Avoid excessively low tire pressures in all the tires, including the spare wheel.

Tire pressure which is too low can cause:

- Tire defects as a result of overheating.
- Impaired handling characteristics
- Irregular wear
- Increased fuel consumption

**⚠ WARNING** Risk of accident from excessive tire pressure

Tires with excessively high pressure can burst because they are damaged more easily by highway fill, pot holes etc.

In addition, they also suffer from irregular wear, which can significantly impair the braking properties and the handling characteristics.

- ▶ Avoid excessively high tire pressures in all the tires, including the spare wheel.

Excessively high tire pressure can result in:

- Increased braking distance
- Impaired handling characteristics
- Irregular wear
- Impaired driving comfort
- Susceptibility to damage



**⚠ WARNING** Risk of accident caused by repeated drop in tire pressure

If the tire pressure drops repeatedly, the wheel, valve or tire may be damaged.

Insufficient tire pressure can cause the tires to burst.

- ▶ Inspect the tire for signs of foreign objects.
- ▶ Check whether the wheel or valve has a leak.
- ▶ If you are unable to rectify the damage, contact a qualified specialist workshop.

You can find information on tire pressure for the vehicle's factory-installed tires on the following labels:

- Tire and Loading Information placard on the B-pillar of your vehicle (→ page 340).
- Tire pressure table on the inside of the fuel filler flap (→ page 335).

Observe the maximum tire pressure (→ page 346).

Use a suitable pressure gauge to check the tire pressure. The outer appearance of a tire does not permit any reliable conclusion about the tire pressure.

**Vehicles with a tire pressure monitoring system:** You can also check the tire pressure using the on-board computer.

Only correct tire pressure when the tires are cold. Conditions for cold tires:

- The vehicle has been parked with the tires out of direct sunlight for at least three hours.
- The vehicle has traveled less than 1 mile (1.6 km).

A rise in the tire temperature of 18 °F (10 °C) increases the tire pressure by approx. 10 kPa (0.1 bar/ 1.5 psi). Take this into account when checking the tire pressure of warm tires.

The tire pressure recommended for increased load/speed in the tire pressure table can affect the ride comfort.

**⚠ WARNING** Risk of accident from unsuitable accessories on the tire valves

If you mount unsuitable accessories onto tire valves, the tire valves may be overloaded and malfunction, which can cause tire pressure loss. Tire pressure monitoring systems for retrofitting will cause the tire valve to remain open. This can also result in tire pressure loss.

- ▶ Only screw standard valve caps or valve caps specifically approved by Mercedes-Benz for your vehicle onto the tire valve.

### Tire pressure table

The tire pressure table is on the inside of the fuel filler flap.

- ⓘ The data shown in the images is example data.

COLD TIRE PRESSURE			
normal load			
maximum load			
Warm tires up to: + 4 psi			

A 2.12.584.00.15

The tire pressure table shows the recommended tire pressure for all tires approved for this vehicle. The recommended tire pressure apply for cold tires under various operating conditions, i.e. loading and/or speed of the vehicle.

LUFTDRUCK PRESSURE PRESSION PRESIÓN							
für kalte Reifen		for cold tires		des pneus froids		de inflado	
100 kPa = 1 bar							
195/55 R16							
215/45 R17							
215/40 R18							
Warme Reifen: Warm tires up to:		+ 30 kPa + 4 psi		Pneus échauffés jusqu'à: Neumáticos calientes hasta:			

A 169 594 50 17

If one or more tire sizes precede a tire pressure, the tire pressure information following is only valid for those tire sizes.

The load conditions "partially laden" and "fully laden" are defined in the table for different numbers of passengers and amounts of luggage. The actual number of seats may differ from this.

Luftdruck für kalte Reifen				Tire pressure cold tires				Pression des pneus froids				Presión de inflado			
für kalte Reifen		for cold tires		des pneus froids		de inflado		für kalte Reifen		for cold tires		des pneus froids		de inflado	
100 kPa = 1 bar															
R18															
R19															
bis up to jusqu'à hasta		240 km/h 150 mph		Winterreifen: Winter tires: Pneus hiver: Neumáticos de invierno:				+ 30 kPa + 4 psi		Warme Reifen bis: Warm tires up to:				+ 30 kPa + 4 psi	

A 2.12.584.02.17

Some tire pressure tables only show the rim diameter instead of the complete tire size, e.g. **R18**. The rim diameter is part of the tire size and can be found on the tire side wall (→ page 347).

Be sure to also observe the following further related subjects:

- Notes on tire pressure (→ page 333)
- Tire and Loading Information placard (→ page 340)

- Maximum tire pressure (→ page 346)

### Checking the tire pressure manually

- ▶ Read the tire pressure for the current operating conditions from the tire and loading information table or the tire pressure table. Observe the notes on tire pressure.
- ▶ Remove the valve cap of the tire to be checked.
- ▶ Press the tire pressure gauge securely onto the valve.
- ▶ Read the tire pressure.
- ▶ If the tire pressure is lower than the recommended value, increase the tire pressure to the recommended value.
- ▶ If the tire pressure is higher than the recommended value, release air. To do so, press down the metal pin in the valve, e.g. using the tip of a pen for example. Then check the tire pressure again using the tire pressure gauge.
- ▶ Screw the valve cap onto the valve.

Further related subjects:

- Notes on tire pressure (→ page 333)
- Tire pressure table (→ page 335)
- Tire and Loading Information placard (→ page 340)

### Tire pressure monitoring system

#### Function of the tire pressure monitoring system

**⚠ DANGER** Risk of accident due to incorrect tire pressure

Every tire, including the spare (if provided), should be checked when cold at least once a month and inflated to the pressure recommended by the vehicle manufacturer (see Tire and Loading Information placard on the B-pillar on the driver's side or the tire pressure label on the inside of the fuel filler flap of your vehicle). If your vehicle has tires of a different size than the size indicated on the Tire and Loading Information placard or the

tire pressure table, you need to determine the proper tire pressure for those tires.

As an added safety feature, your vehicle has been equipped with a tire pressure monitoring system (TPMS) that illuminates a low tire pressure indicator lamp when one or more of your tires are significantly underinflated.

Accordingly, if the low tire pressure indicator lamp lights up, you should stop and check your tires as soon as possible, and inflate them to the proper pressure. Driving on a significantly underinflated tire causes the tire to overheat and can lead to tire failure.

Underinflation also increases fuel consumption and reduces tire tread life, and may affect the vehicle's handling and braking ability. Please note that the TPMS is not a substitute for proper tire maintenance, and it is the driver's responsibility to maintain correct tire pressure, even if underinflation has not reached the level to trigger illumination of the TPMS low tire pressure indicator lamp.

Your vehicle has also been equipped with a TPMS malfunction indicator to indicate when

the system is not operating properly. The TPMS malfunction indicator is combined with the low tire pressure indicator lamp. When the system detects a malfunction, the indicator lamp will flash for approximately a minute and then remain continuously illuminated. This sequence will continue upon subsequent vehicle start-ups as long as the malfunction exists.

When the malfunction indicator is illuminated, the system may not be able to detect or signal low tire pressure as intended. TPMS malfunctions may occur for a variety of reasons, including the installation of incompatible replacement or alternate tires or wheels on the vehicle that prevent the TPMS from functioning properly.

Always check the TPMS malfunction warning lamp after replacing one or more tires or wheels on your vehicle to ensure that the replacement or alternate tires and wheels allow the TPMS to continue to function properly.

The system checks the tire pressure of the tires installed on the vehicle by means of a tire pressure sensor.

New tire pressure sensor, e.g. in winter tires, are automatically taught-in the first time they are driven.

The tire pressure appears in the multifunction display (→ page 198).

If there is a substantial pressure loss or if the tire temperature is excessive, a warning will be given:

- Via display messages (→ page 404).
- Via the  warning lamp in the instrument cluster (→ page 433).

It is the driver's responsibility to set the tire pressure to the recommended cold tire pressure suitable for the operating situation. Set the tire pressure for cold tires using a tire pressure gauge. Note that the correct tire pressure for the current operating situation must first be taught-in to the tire pressure monitor.

In most cases, the tire pressure monitoring system will automatically update the new reference

values after you have changed the tire pressure. You can, however, also update the reference values by restarting the tire pressure monitoring system manually (→ page 339).

### System limitations

The tire pressure monitoring system does not issue a warning:

- If the tire pressure is set incorrectly.
- If there is a sudden pressure loss caused, for example, by a foreign object penetrating the tire.
- If there is a malfunction caused by another radio signal source.

Be sure to also observe the following further related subjects:

- Notes on tire pressure (→ page 333)

### Checking the tire pressure with the tire pressure monitoring system

#### Requirements

- The ignition is switched on.

On-board computer:

➔ Service ➔ Tire Pressure

- ① The spelling may differ in the main menu displayed. Therefore, observe the menu overview for the Instrument Display in the Wide-screen Cockpit (→ page 197).

One of the following displays appears:

- Current tire pressure of each wheel:

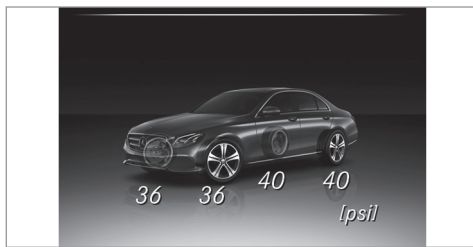

- **Tire pressure will be displayed after driving a few minutes**
- **Tire Pressure Monitor Active:** the teach-in process of the system is not yet complete.

The tire pressures are already being monitored.

- ▶ Compare the tire pressure with the recommended tire pressure for the current operating condition (→ page 335). Observe the notes on tire temperature (→ page 333).
- ① The values displayed in the multifunction display may deviate from those of the tire pressure gauge as they refer to sea level. At high altitudes, the tire pressure value indicated by the pressure gauge are higher than those shown by the on-board computer. In this case, do not reduce the tire pressures.

Be sure to also observe the following further related subjects:

- Notes on tire pressure (→ page 333)

### Restarting the tire pressure monitoring system

#### Requirements:

- The recommended tire pressure is correctly set for the respective operating condition on each of the four wheels (→ page 333).

Restart the tire pressure monitoring system in the following situations:

- The tire pressure has changed.
- The wheels or tires have been changed or newly installed.

On-board computer:

➔ Service ➔ Tire Pressure

- ① The spelling may differ in the main menu displayed. Therefore, observe the menu overview for the Instrument Display in the Wide-screen Cockpit (→ page 197).

- ▶ Swipe downwards on the Touch Control on the left-hand side of the steering wheel. The **Use Current Pressures as New Reference Values** message is shown in the multifunction display.
- ▶ Press **OK** to confirm the restart. The **Tire Press. Monitor Restarted** message is shown in the multifunction display. Current warning messages are deleted and the **(U)** yellow warning lamp goes out.

After driving for a few minutes, the system checks whether the current tire pressures are within the specified range. The current tire pressure values are then accepted as reference values and monitored.

Be sure to also observe the following further related subjects:

- Notes on tire pressure (→ page 333)

### Radio-type approval of the tire pressure monitoring system

#### Radio equipment approval numbers

Country	Radio equipment approval number
Canada	FCC ID: MRXAG5SP4
USA	FCC ID: MRXMFR IC: 2546A-AG5SP4

Further information on the declaration of conformity for wireless vehicle components (→ page 23).

### Loading the vehicle

#### Tire and Loading Information placard

**⚠ WARNING** Risk of accident from overloaded tires

Overloaded tires may overheat and burst as a consequence. Overloaded tires can also impair the steering and handling characteristics and lead to brake failure.

- ▶ Observe the load rating of the tires.
- ▶ The load rating must be at least half the permissible axle load of the vehicle.
- ▶ Never overload the tires by exceeding the maximum load.

The Tire and Loading Information placard is on the B-pillar on the driver's side of the vehicle.

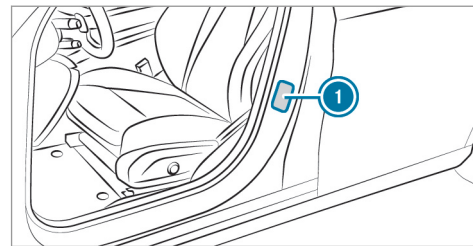

① Tire and Loading Information placard

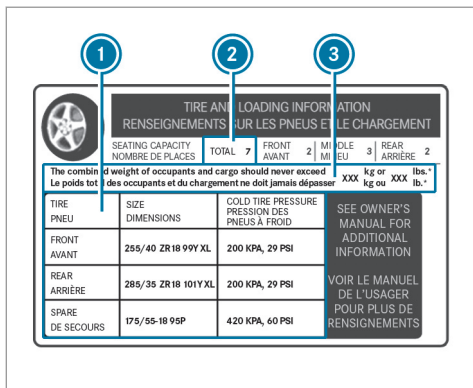

**i** The data shown in the image is example data.

The Tire and Loading Information placard shows:

- Maximum number of seats **2** according to the maximum number of people permitted to travel in the vehicle
- Maximum permissible load **3** comprises the gross weight of all vehicle occupants, load and luggage.

- Recommended tire pressure **1** for cold tires. The recommended tire pressures are valid for the maximum permissible load and up to the maximum permissible vehicle speed.

Please also note:

- Information on permissible weights and loads on the vehicle identification plate .
- Information on tire pressure in the tire pressure table (→ page 335).

Further related subjects:

- Determining the maximum permissible load (→ page 341)
- Notes on tire pressure (→ page 333)

### Determining the maximum permissible load

The following steps have been developed as required of all manufacturers under Title 49, Code of U.S. Federal Regulations, Part 575, pursuant to the "National Traffic and Motor Vehicle Safety Act of 1966".

**▶ Step 1:** Locate the statement "The combined weight of occupants and cargo should never exceed XXX kg or XXX lbs." ("The combined weight of occupants and cargo should never exceed XXX kg or XXX lbs.") on your vehicle's tire and loading information table.

**▶ Step 2:** Determine the combined weight of the driver and passengers that will be riding in your vehicle.

**▶ Step 3:** Subtract the combined weight of the driver and passengers from XXX kg or XXX lbs.

**▶ Step 4:** The resulting figure equals the permissible load for cargo and luggage. For example: If "XXX" equals 1400 lbs and there are five occupants in your vehicle with a weight of 150 lbs each, the maximum cargo and luggage load capacity is 650 lbs (1400 - 750 (5 x 150) = 650 lbs).

**▶ Step 5:** Determine the combined weight of luggage and cargo being carried in the vehicle. For safety reasons, this weight may not safely exceed the available cargo and luggage load capacity calculated in step 4.

## 342 Wheels and tires

Even if you have calculated the total load carefully, you should still make sure that the maximum permissible gross mass and the maximum permissible axle load of your vehicle are not exceeded. Details can be found on the vehicle identification plate.

▶ Have your loaded vehicle – including driver, occupants and load – weighed on a vehicle weighbridge.

The measured values may not exceed the maximum permissible values stated on the vehicle identification plate.

Further related subjects:

- Calculation example for determining the maximum load (→ page 342)
- Tire and Loading Information placard (→ page 340)
- Tire pressure table (→ page 335)
- Vehicle identification plate

### Calculation example for determining the maximum load

The following table shows examples of how to calculate total and load capacities with varying

seating configurations and different numbers and sizes of occupants. The following examples use a maximum load of 1500 lbs (680 kg). **This is for illustration purposes only.** Make sure you are using the actual load limit for your vehicle stated on your vehicle's Tire and Loading Information placard (→ page 340).

The higher the weight of all the occupants, the smaller the maximum load for luggage.

### Step 1

	Example 1	Example 2
Combined maximum weight of occupants and cargo (data from the Tire and Loading Information placard)	1500 lbs (680 kg)	1500 lbs (680 kg)



**Step 2**

	Example 1	Example 2
Number of people in the vehicle (driver and occupants)	5	1
Distribution of the occupants	Front: 2 Rear: 3	Front: 1
Weight of occupants	Occupant 1: 150 lbs (68 kg) Occupant 2: 180 lbs (82 kg) Occupant 3: 160 lbs (73 kg) Occupant 4: 140 lbs (63 kg) Occupant 5: 120 lbs (54 kg)	Occupant 1: 200 lbs (91 kg)
Total weight of all occupants	750 lbs (340 kg)	200 lbs (91 kg)

**Step 3**

	Example 1	Example 2
Permissible load (maximum gross vehicle weight rating from the Tire and Loading Information placard minus the gross weight of all occupants)	1500 lbs (680 kg) - 750 lbs (340 kg) = 750 lbs (340 kg)	1500 lbs (680 kg) - 200 lbs (91 kg) = 1300 lbs (589 kg)

## Tire labeling

### Overview of tire labeling

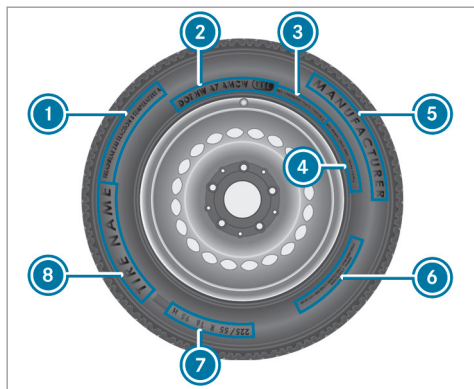

- ① Uniform Tire Quality Grading Standard (→ page 344)
- ② DOT (Department of Transportation), (TIN) Tire Identification Number (→ page 345)
- ③ Maximum tire load (→ page 346)
- ④ Maximum tire pressure (→ page 346)

- ⑤ Manufacturer
- ⑥ Tire characteristics (→ page 347)
- ⑦ Tire size designation, load rating, speed rating and load index (→ page 347)
- ⑧ Tire name
- ① The data shown in the image is example data.

### Tire Quality Grading

In accordance with the US Department of Transportation's "Uniform Tire Quality Grading Standards", tire manufacturers are required to grade their tires on the basis of the following three performance factors:

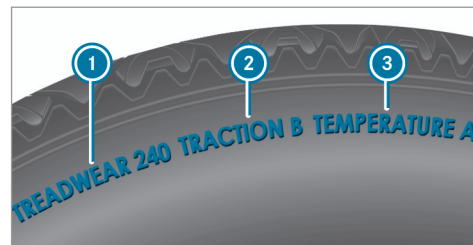

- ① Tread wear grade
- ② Traction grade
- ③ Temperature grade
- ① The data shown in the image is example data.
- ① The classification is not legally stipulated for Canada, but it is generally stated.

### Tread wear grade

The tread wear grade is a comparative rating based on the wear rate of the tire when tested under controlled conditions on a specified test track of the US Department of Transportation. For example, a tire graded 150 would wear one

and one-half times as well on the government course as a tire graded 100.

The relative performance of tires depends upon the actual conditions of their use, however, and may depart significantly from the norm due to variations in driving habits, service practices and differences in road characteristics and climate conditions.

### Traction grade

**⚠ DANGER** Risk of accident due to inadequate traction

The traction grade assigned to this tire is based on straight-ahead braking traction tests, and does not include either acceleration, cornering, hydroplaning or peak traction characteristics.

- ▶ Always adapt your driving style and drive at a speed to suit the prevailing traffic and weather conditions.

**! NOTE** Damage to the drivetrain from wheelspin

- ▶ Avoid wheelspin.

The traction grades – from highest to lowest – are AA, A, B and C. Those grades represent the tire's ability to stop on wet pavement as measured under controlled conditions on specified government test surfaces made of asphalt and concrete.

### Temperature grade

**⚠ WARNING** Risk of accident from tire overheating and tire failure

The temperature grade for this tire is established for a tire that is properly inflated and not overloaded. Excessive speed, underinflation, or excessive loading, either separately or in combination, can cause excessive heat build-up and possible tire failure.

- ▶ Observe the recommended tire pressures and regularly check the tire pres-

sure of all tires including the spare wheel.

- ▶ Adjust the tire pressure as necessary.

The temperature grades are A (the highest), B and C. They represent the tire's resistance to the generation of heat and its ability to dissipate heat when tested under controlled conditions on a specified indoor laboratory test wheel. Sustained high temperatures can cause the material of the tire to degenerate and reduce tire life. Furthermore, excessive temperatures can lead to sudden tire failure. Grade C corresponds to a level of performance which all passenger car tires must meet under the requirements of the US Department of Transportation.

### DOT, Tire Identification Number (TIN)

US tire regulations stipulate that every tire manufacturer or retreader must imprint a TIN in or on the side wall of each tire produced.

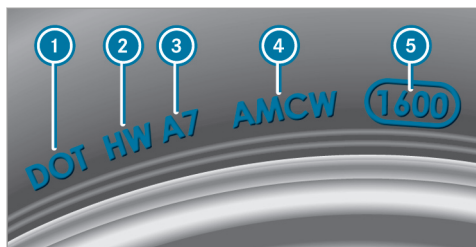

**i** The data shown in the image is example data.

The TIN is a unique identification number to identify tires and comprises the following:

- **DOT (Department of Transportation):** tire symbol marks **1** indicating that the tire complies with the requirements of the US Department of Transportation.
- **Manufacturer identification code:** manufacturer identification code **2** contains details of the tire manufacturer. New tires have a code with two symbols. Retreaded tire have a code with four symbols. Further information on retreaded tires (→ page 352).

- **Tire size:** identifier **3** describes the tire size.
- **Tire type code:** tire type code **4** can be used by the manufacturer as a code to describe specific characteristics of the tire.
- **Manufacturing date:** manufacturing date **5** provides information about the age of a tire. The 1st and 2nd positions represent the calendar week and the 3rd and 4th positions state the year of manufacture (e.g. "3208" represents the 32nd week of 2008).

#### Information on the maximum tire load



**i** The data shown in the image is example data.

Maximum tire load **1** is the maximum permissible weight for which the tire is approved.

Do not overload the tires by exceeding the specified load limit. The maximum permissible load can be found on the vehicle's Tire and Loading Information placard on the B-pillar on the driver's side (→ page 340).

#### Specifications for maximum tire pressure



**i** The data shown in the image is example data.

Never exceed maximum tire pressure ❶ specified for the tire.

### Information on tire characteristics



❶ The data shown in the image is example data.

This information describes the type of tire cord and the number of layers in side wall ❶ and under tire tread ❷.

### Tire size designation, load-bearing capacity, speed rating and load index

**⚠ WARNING** Risk of accident due to exceeding the stated tire load rating or the approved speed rating

Exceeding the specified tire load rating or the permissible speed rating may lead to tire damage and to the tires bursting.

- ▶ Therefore, only use tire types and sizes approved for your vehicle model.
- ▶ Observe the tire load rating and speed rating required for your vehicle.

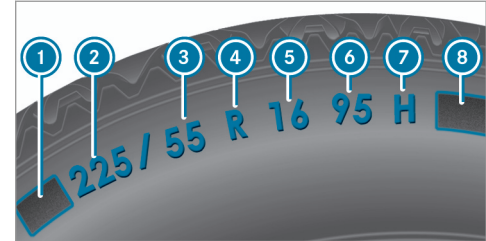

- ❶ Preceding letter
- ❷ Nominal tire width in millimeters
- ❸ Aspect ratio in %
- ❹ Tire code
- ❺ Rim diameter
- ❻ Load-bearing index
- ❼ Speed rating
- ❽ Load index

❶ The data shown in the image is example data.

Information about reading the tire data can be obtained from any qualified specialist workshop.

**Preceding letter 1:**

- Without: passenger vehicle tires according to European manufacturing standards.
- "P": passenger vehicle tires according to US manufacturing standards.
- "LT": light truck tires according to US manufacturing standards.
- "T": compact emergency spare wheels with high tire pressure that are only designed for temporary use in an emergency.

**Aspect ratio 3:**

Ratio between tire height and tire width in percent (tire height divided by tire width).

**Tire code 4 (tire type):**

- "R": radial tire
- "D": bias ply tire
- "B": bias belted tires
- "ZR": radial tire with a maximum speed above 149 mph (240 km/h) (optional)

**Rim diameter 5:**

The diameter of the bead seat (not the diameter of the rim flange). The rim diameter is specified in inches (in).

**Load-bearing index 6:**

Numerical code that specifies the maximum load-bearing capacity of a tire (e.g. "91" corresponds to 1356 lbs (615 kg)).

The load-bearing capacity of the tire must be at least half the permissible axle load of your vehicle. Do not overload the tires by exceeding the specified load limit.

See also:

- Maximum permissible load on the Tire and Loading Information placard (→ page 340)
- Maximum tire load (→ page 346)
- Load index

**Speed rating 7:**

Specifies the approved maximum speed of the tire.

**i** An electronic speed limiter prevents your vehicle from exceeding a speed of 130 mph (210 km/h).

Make sure that your tires have the required speed rating. You can obtain information on the required speed rating from a Mercedes-Benz service center.

**Summer tires**

Index	Speed rating
Q	up to 100 mph (160 km/h)
R	up to 106 mph (170 km/h)
S	up to 112 mph (180 km/h)
T	up to 118 mph (190 km/h)
H	up to 130 mph (210 km/h)
V	up to 149 mph (240 km/h)
W	up to 168 mph (270 km/h)
Y	up to 186 mph (300 km/h)

Index	Speed rating
ZR...Y <sup>1</sup>	up to 186 mph (300 km/h)
ZR...(..Y) <sup>1</sup>	over 186 mph (300 km/h)
ZR <sup>1</sup>	over 149 mph (240 km/h)

- Specifying the speed rating as the "ZR" index in tire code ④ is optional for tires up to 186 mph (300 km/h).
- If your tire code ④ includes "ZR" and there is no speed rating ⑦, find out what the maximum speed is from the tire manufacturer.
- If load-bearing index ⑥ and speed rating ⑦ are in brackets, the maximum speed rating of your tire is above 186 mph (300 km/h). To find out the maximum speed, ask the tire manufacturer.

<sup>1</sup> "ZR" stated in the tire code.

<sup>2</sup> Or "M+S"  " for winter tires

### All-weather tires and winter tires

Index	Speed rating
Q M+S <sup>2</sup>	up to 100 mph (160 km/h)
T M+S <sup>2</sup>	up to 118 mph (190 km/h)
H M+S <sup>2</sup>	up to 130 mph (210 km/h)
V M+S <sup>2</sup>	up to 149 mph (240 km/h)

Winter tires bear the  snowflake symbol and fulfill the requirements of the Rubber Manufacturers Association (RMA) and the Rubber Association of Canada (RAC) regarding traction on snow.

### Load index ⑧:

- No specification given: standard load (SL) tire
- "XL" or "Extra Load": extra load tire or reinforced tire
- "Light Load": light load tire

- "C", "D", "E": a load range that depends on the maximum load that the tire can carry at a certain pressure

### Definitions for tires and loading

**Tire structure and characteristics:** describes the number of layers or the number of rubber-coated belts in the tire contact surface and the tire wall. These are made of steel, nylon, polyester and other materials.

**Bar:** metric unit for tire pressure. 14.5038 pounds per square inch (psi) and 100 kilopascal (kPa) is the equivalent of one bar.

**DOT (Department of Transportation):** DOT marked tires fulfill the requirements of the US Department of Transportation.

**Average weight of the vehicle occupants:** the number of vehicle occupants for which the vehicle is designed, multiplied by 150 lb (68 kg).

**Uniform Tire Quality Grading Standards:** a uniform standard to grade the quality of tires with regard to tread quality, tire traction and temperature characteristics. The quality grading assessment is made by the manufacturer following specifications from the U.S. government. The quality grade of a tire is imprinted on the side wall of the tire.

**Recommended tire pressure:** the recommended tire pressure is the tire pressure specified for the tires mounted to the vehicle at the factory.

The tire and information table contains the recommended tire pressure for cold tires, the maximum permissible load and the maximum permissible vehicle speed.

The tire pressure table contains the recommended tire pressure for cold tires under various operating conditions, i.e. loading and/or speed of the vehicle.

**Increased vehicle weight due to optional equipment:** the combined weight of all standard and optional equipment available for the vehicle,

regardless of whether it is actually installed on the vehicle or not.

**Rim:** the part of the wheel on which the tire is mounted.

**GAWR (Gross Axle Weight Rating):** the GAWR is the maximum gross axle load. The actual load on an axle must never exceed the gross axle weight rating. The gross axle weight rating can be found on the vehicle identification plate on the B-pillar on the driver's side.

**Speed rating:** the speed rating is part of the tire identification. It specifies the speed range for which a tire is approved.

**GVW (Gross Vehicle Weight):** the gross vehicle weight comprises the weight of the vehicle including fuel, tools, the spare wheel, accessories installed, occupants, luggage and the trailer drawbar noseweight, if applicable. The gross vehicle weight must not exceed the gross vehicle weight rating GVWR as specified on the vehicle identification plate on the B-pillar on the driver's side.

**GVWR (Gross Vehicle Weight Rating):** the GVWR is the maximum permitted gross weight

of the fully laden vehicle (weight of the vehicle including all accessories, occupants, fuel, luggage and the trailer drawbar noseweight if applicable). The gross vehicle weight rating is specified on the vehicle identification plate on the B-pillar on the driver's side.

**Maximum weight of the laden vehicle:** the maximum weight is the sum of the unladen weight of the vehicle, the weight of the accessories, the maximum load and the weight of optional equipment installed at the factory.

**Kilopascal (kPa):** metric unit for tire pressure. 6.9 kPa corresponds to 1 psi. Another unit for tire pressure is bar. 100 kilopascal (kPa) equals 1 bar.

**Load index:** in addition to the load-bearing index, the load index may also be imprinted on the side wall of the tire. This specifies the load-bearing capacity of the tire more precisely.

**Curb weight:** the weight of a vehicle with standard equipment including the maximum capacity of fuel, oil and coolant. It also includes the air conditioning system and optional equipment if



these are installed on the vehicle, but does not include passengers or luggage.

**Maximum tire load:** the maximum tire load is the maximum permissible weight in kilograms or lbs for which a tire is approved.

**Maximum permissible tire pressure:** maximum permissible tire pressure for one tire.

**Maximum load on one tire:** maximum load on one tire. This is calculated by dividing the maximum axle load of one axle by two.

**PSI (pounds per square inch):** standard unit of measurement for tire pressure.

**Aspect ratio:** ratio between tire height and tire width in percent.

**Tire pressure:** pressure inside the tire applying an outward force to every square inch of the tire. The tire pressure is specified in pounds per square inch (psi), in kilopascals (kPa) or in bar. The tire pressure should only be corrected when the tires are cold.

**Cold tire pressure:** the tires are cold when the vehicle has been parked for at least 3 hours

without direct sunlight on the tires or the vehicle has been driven for less than 1 mile (1.6 km).

**Tire contact surface:** the part of the tire that comes into contact with the road.

**Tire bead:** the purpose of the tire bead is to ensure that the tire sits securely on the wheel rim. There are several steel wires in the bead to prevent the tire from coming loose from the wheel rim.

**Side wall:** the part of the tire between the tread and the tire bead.

**Weight of optional equipment:** the combined weight of the optional equipment weighing more than the replaced standard parts and more than 5 lbs (2.3 kg). This optional equipment, such as high-performance brakes, level control system, a roof luggage rack or high-performance batteries, is not included in the curb weight and the weight of the accessories.

**TIN (Tire Identification Number):** a unique identification number which can be used by a tire manufacturer to identify tires, for example, in a product recall, and thus identify the purchasers. The TIN is made up of the manufactur-

er's identity code, tire size, tire type code and the manufacturing date.

**Load-bearing index:** the load-bearing index (also load index) is a code that contains the maximum load-bearing capacity of a tire.

**Traction:** traction is the grip resulting from friction between the tires and the road surface.

**Wear indicator:** narrow bars (tread wear bars) that are distributed over the tire contact surface. If the tire tread is level with the bars, the wear limit of 1/16 in (1.6 mm) has been reached.

**Distribution of vehicle occupants:** distribution of vehicle occupants over designated seat positions in a vehicle.

**Maximum permissible payload weight:** nominal load and luggage load plus 150 lb (68 kg) multiplied by the number of seats in the vehicle.

## Changing a wheel

### Notes on selecting, mounting and replacing tires

You can ask for information regarding permitted wheel/tire combinations at an authorized Mercedes-Benz Center.

**⚠ WARNING** Risk of accident due to incorrect dimensions of wheels and tires

If wheels and tires of the wrong size are installed, the wheel brakes or wheel suspension components may be damaged.

- ▶ Always replace wheels and tires with those that fulfill the specifications of the original part.

When replacing wheels, make sure to fit the correct:

- Designation
- Model

When replacing tires, make sure to install the correct:

- Designation
- Manufacturer
- Model

**⚠ WARNING** Risk of accident due to exceeding the stated tire load rating or the approved speed rating

Exceeding the specified tire load rating or the permissible speed rating may lead to tire damage and to the tires bursting.

- ▶ Therefore, only use tire types and sizes approved for your vehicle model.
- ▶ Observe the tire load rating and speed rating required for your vehicle.

**!** **NOTE** Damage to vehicle and tires due to non-approved tire types and sizes

For safety reasons, only use wheels, tires and accessories which have been approved for your vehicle by Mercedes-Benz.

These tires have been specially adapted for use with the control systems, e.g. ABS or ESP®, and are marked as follows:

- MO = Mercedes-Benz Original
- MOE = Mercedes-Benz Original Extended (run-flat tires only for certain wheels)
- MO1 = Mercedes-Benz Original (only certain AMG tires)

Certain characteristics, e.g. handling, vehicle noise emissions or fuel consumption, may otherwise be adversely affected. In addition, when driving with a load, tire dimension variations could cause the tires to come into contact with the body and axle components. This could result in damage to the tires or the vehicle.

Only use tires, wheels or accessories tested and approved by Mercedes-Benz.

**!** **NOTE** Risk to driving safety from retreaded tires

Retreaded tires are neither tested nor recommended by Mercedes-Benz, since previous damage cannot always be detected on retreaded tires.

For this reason driving safety cannot be guaranteed.

- ▶ Do not use used tires if you have no information about their previous usage.

**!** **NOTE** Possible damage to wheels or tires when driving over obstacles

Large wheels have a lower tire section width. The lower the tire section width, the greater is the risk of damage to wheels or tires when driving over obstacles.

- ▶ Avoid obstacles or drive particularly carefully.

**!** **NOTE** Damage to electronic component parts from the use of tire-mounting tools

**Vehicles with a tire pressure monitoring system:** Electronic component parts are located in the wheel. Tire-mounting tools should not be used in the area of the valve.

This could otherwise damage the electronic component parts.

- ▶ Have the tires changed at a qualified specialist workshop only.

**!** **NOTE** Damage to summer tires at low ambient temperatures

Using summer tires at very low ambient temperatures can cause cracks to form, thereby damaging the tires permanently.

- ▶ At temperatures below 45 °F (7 °C) use M+S tires.

Accessory parts that are not approved for your vehicle by Mercedes-Benz or that are not being used correctly can impair operating safety.

Before purchasing and using non-approved accessories, visit a qualified specialist workshop and inquire about:

- Suitability
- Legal stipulations
- Factory recommendations

**!** **WARNING** Risk of accident with high performance tires

The special tire tread in combination with the optimized tire compound means that the risk of skidding or hydroplaning on wet roads is increased.

In addition, the tire grip is greatly reduced at a low outside temperature and tire running temperature.

- ▶ Switch on the ESP® and adapt your driving style accordingly.
- ▶ Use M+S tire at outside temperatures of less than 10 °C (50 °F).

Observe the following when selecting, installing and replacing tires:

- Only use tires and wheels of the same type (summer tires, winter tires, MOExtended tires) and the same make.
- Only mount wheels of the same size on one axle (left and right).  
It is only permissible to mount a different wheel size in the event of a flat tire in order to drive to a specialist workshop.
- Only mount tires of the correct size onto the wheels.
- **Vehicles with a tire pressure monitoring system:** All mounted wheels must be equipped with functioning sensors for the tire pressure monitoring system.
- At temperatures below 45 °F (7 °C), use winter tires or all-season tires marked M+S for all wheels.

Winter tires bearing the  snowflake symbol in addition to the M+S marking provide the best possible grip in wintry road conditions.

- For M+S tires, only use tires with the same tread.
- Observe the maximum permissible speed for the M+S tires mounted.

If this is below the vehicle's maximum speed, this must be indicated in an appropriate label in the driver's field of vision.

- Break in new tires at moderate speeds for the first 60 miles (100 km).
- Replace the tires after six years at the latest, regardless of wear.
- **When replacing with tires that do not feature run-flat characteristics:** Vehicles with MOExtended tires are not equipped with a TIREFIT kit at the factory. Equip the vehicle with a TIREFIT kit after replacing with tires that do not feature run-flat characteristics, e.g. winter tires.

For more information on wheels and tires, contact a qualified specialist workshop.

Be sure to also observe the following further related subjects:

- Notes on tire pressure (→ page 333)

- Tire and Loading Information placard (→ page 340)
- Tire pressure table (→ page 335)

### Notes on interchanging wheels

 **WARNING** Risk of injury through different wheel sizes

Interchanging the front and rear wheels if the wheels or tires have different dimensions may severely impair the driving characteristics.

The wheel brakes or wheel suspension components may also be damaged.

- ▶ Rotate front and rear wheels only if the wheels and tires are of the same dimensions.

The wear patterns on the front and rear wheels differ:

- Front wheels wear more on the shoulder of the tire

- Rear wheels wear more in the center of the tire

On vehicles that have the same size front and rear wheels, interchange the wheels according to the intervals in the tire manufacturer's warranty book in your vehicle documents. If this is not available, interchange the tires every 3,000 to 6,000 miles (5,000 to 10,000 km), depending on the wear. Ensure that the direction of rotation is maintained.

It is imperative to observe the instructions and safety notes on "Wheel change" when doing so.

### Notes on storing wheels

- After removing wheels, store them in a cool, dry and preferably dark place.
- Protect the tires from contact with oil, grease or fuel.

### Overview of the tire-change tool kit

Apart from certain country-specific variations, the vehicles are not equipped with a tire-change

tool kit. For more information on which tire-changing tools are required and approved for performing a wheel change on your vehicle, consult a qualified specialist workshop.

Necessary tire-changing tools may include, for example:

- Jack
- Chock
- Lug wrench
- Alignment bolt

The tire-change tool kit is located under the trunk floor.

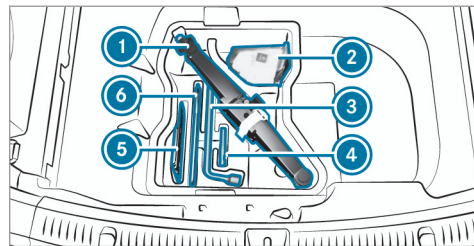

- ① Jack
- ② Gloves
- ③ Lug wrench
- ④ Alignment bolt
- ⑤ Folding wheel chock
- ⑥ Ratchet for jack

### Setting up the folding wheel chock

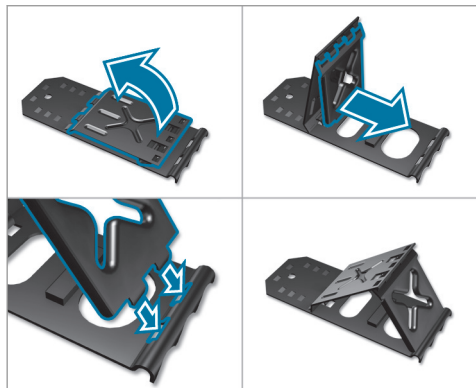

### Preparing the vehicle for a wheel change

#### Requirements

- The required tire-change tool kit is available. If your vehicle is not equipped with the tire-change tool kit, consult a qualified specialist workshop to find out about suitable tools.

- The vehicle is not on a slope.
- The vehicle is on solid, non-slippery and level ground.

- ▶ Apply the electric parking brake manually.
- ▶ Bring the front wheels into the straight-ahead position.
- ▶ **Vehicles with automatic transmission:** Shift into position **P**.
- ▶ **Vehicles with AIR BODY CONTROL:** Set the normal vehicle level (→ page 171).
- ▶ Switch off the engine.
- ▶ Make sure that the engine cannot be started.
- ▶ Place chocks or other suitable items under the front and rear of the wheel that is diagonally opposite the wheel you wish to change.
- ▶ Remove the hub caps if necessary (→ page 356).
- ▶ Raise the vehicle (→ page 357).

### Removing and mounting hub caps

#### Requirements

- ▶ The vehicle is prepared for a wheel change (→ page 356).

#### Plastic hub cap

- ▶ **To remove:** turn the center cover of the hub cap counter-clockwise and remove the hub cap.
- ▶ **To mount:** make sure that the center cover of the hub cap is turned counter-clockwise.
- ▶ Position the hub cap and turn the center cover clockwise until the hub cap engages physically and audibly.

### Aluminum hub cap

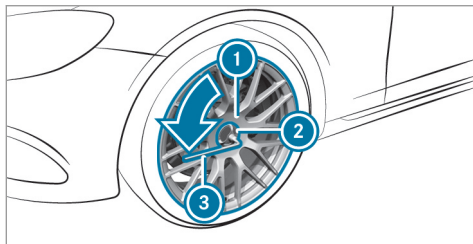

▶ **To remove:** position socket ② on hub cap ①.

ⓘ The socket can be found in the tire-change tool kit.

▶ Position wheel wrench ③ on socket ②.

▶ Using wheel wrench ③, turn hub cap ① counter-clockwise and remove it.

▶ **To install:** position hub cap ① and turn until it is completely flush with the wheel.

▶ Position socket ② on hub cap ①.

▶ Attach wheel wrench ③ to socket ② and tighten the hub cap clockwise.

**Specified tightening torque:** 18 lb-ft (25 Nm).

▶ Raise the vehicle (→ page 357).

### Raising the vehicle when changing a wheel

#### Requirements

- There are no persons in the vehicle.
- The vehicle is prepared for a wheel change (→ page 356).
- The hub caps have been removed (→ page 356).

#### Important notes on using the jack:

- Only use the vehicle-specific jack that has been tested and approved by Mercedes-Benz to raise the vehicle.
- The jack is only designed for raising and holding the vehicle for a short time while a wheel is being changed and not for maintenance work under the vehicle.

- The jack must be placed on a firm, flat and non-slip surface. If necessary, use a large, load-bearing, non-slip underlay.
- The base of the jack must be positioned vertically under the jack support point.

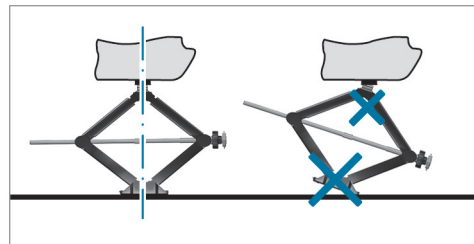

#### Rules of conduct when the vehicle is raised:

- Never place your hands or feet under the vehicle.
- Do not lie under the vehicle.
- Do not start the engine and do not release the parking brake.
- Do not open or close any doors or the trunk lid.

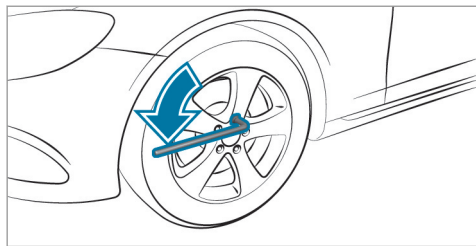

- ▶ Using the wheel wrench, loosen the wheel bolts on the wheel you wish to change by about one full turn. Do not unscrew the bolts completely.

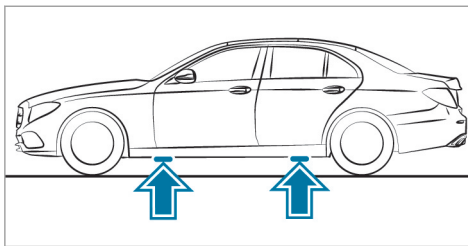

Position of jack support points

**⚠ WARNING** Risk of injury from incorrect positioning of the jack

If you do not position the jack correctly at the appropriate jacking point of the vehicle, the jack could tip with the vehicle raised.

- ▶ Only position the jack at the appropriate jacking point of the vehicle. The base of the jack must be positioned vertically under the jacking point of the vehicle.

**!** **NOTE** Vehicle damage from the jack

If you do not position the jack correctly at the appropriate jack support point of the vehicle, the jack could tip over with the vehicle raised.

- ▶ The jack is designed exclusively for jacking up the vehicle at the jack support points.

- ▶ Take the ratchet wrench out of the tire-change tool kit and place it on the hexagon nut of the jack so that the letters AUF are visible.



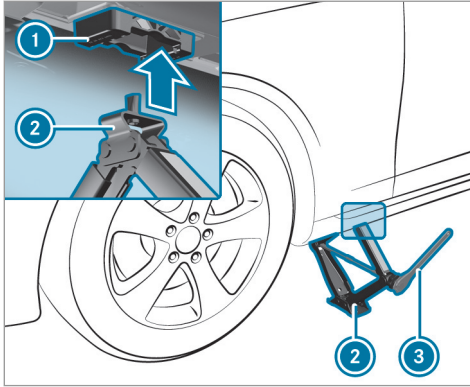

- ▶ Position jack ② at jack support point ①.
- ▶ Turn ratchet wrench ③ clockwise until jack ② sits completely on jack support point ① and the base of the jack lies evenly on the ground.
- ▶ Continue to turn ratchet wrench ③ until the tire is raised a maximum of 1.2 in (3 cm) off the ground.
- ▶ Loosen and remove the wheel (→ page 359).

## Removing a wheel

### Requirements

- The vehicle is raised (→ page 357).

When changing a wheel, avoid applying any force to the brake discs, since this could impair the level of comfort when braking.

**NOTE** Damage to threading from dirt on wheel bolts

▶ Do not place wheel bolts in sand or on a dirty surface.

▶ Unscrew the uppermost wheel bolt completely.

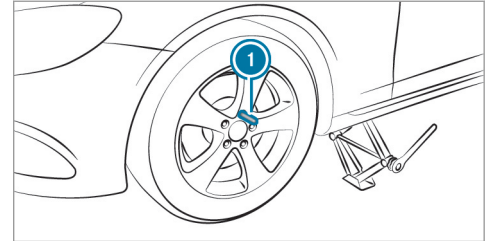

- ▶ Screw centering pin ① instead of the wheel bolt into the thread.
- ▶ Unscrew the remaining wheel bolts fully.
- ▶ Remove the wheel.
- ▶ Mount the new wheel (→ page 359).

## Mounting a new wheel

### Requirements

- The wheel is removed (→ page 359).

**⚠ WARNING** Risk of accident from losing a wheel

Oiled, greased or damaged wheel bolts or wheel hub threads can cause the wheel bolts to come loose.

As a result, you could lose a wheel while driving.

- ▶ Never oil or grease the wheel bolts.
- ▶ In the event of damage to the threads, contact a qualified specialist workshop immediately.
- ▶ Have the damaged wheel bolts or damaged hub threads replaced.
- ▶ Do not drive any further.

- ▶ Observe the information on the choice of tires (→ page 352).

For tires with a specified direction of rotation, an arrow on the side wall of the tire indicates the correct direction of rotation. Observe the direction of rotation when mounting.

- ▶ Slide the wheel to be mounted onto the centering pin and push it on.

**⚠ WARNING** Risk of injury from tightening wheel bolts and nuts

If you tighten the wheel bolts or wheel nuts when the vehicle is raised, the jack could tip.

- ▶ Only tighten wheel bolts or wheel nuts when the vehicle is on the ground.

- ▶ For safety reasons, Mercedes-Benz recommends that you only use wheel bolts which have been approved for Mercedes-Benz vehicles, as well as for the wheel in question.

**! NOTE** Damage to paintwork of the wheel rim when screwing on the first wheel bolt

If the wheel has too much play when screwing in the first wheel bolt, the wheel rim paint can be damaged.

- ▶ Press the wheel firmly against the wheel hub when screwing on the first wheel bolt.

- ▶ Tighten the wheel bolts until they are finger-tight.
- ▶ Unscrew the centering pin.
- ▶ Tighten the last wheel bolt until it is finger-tight.
- ▶ Lower the vehicle(→ page 360).

### Lowering the vehicle after a wheel change

#### Requirements

- The new wheel has been mounted (→ page 359).
- ▶ Place the ratchet wrench onto the hexagon nut of the jack so that the letters "AB" are visible.
- ▶ **To lower the vehicle:** turn the ratchet wrench of the jack counter-clockwise.

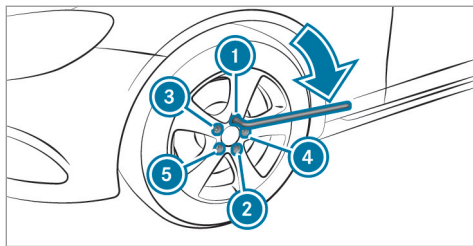

- ▶ Tighten the wheel bolts evenly in a crosswise pattern in the sequence indicated (1 to 5).  
**Specified tightening torque:** 111 lb-ft (150 Nm).

**⚠ WARNING** Risk of accident due to incorrect tightening torque

The wheels could come loose if the wheel bolts or wheel nuts are not tightened to the prescribed tightening torque.

- ▶ Have the tightening torque checked immediately at a qualified specialist workshop after changing a wheel.

- ▶ Check the tire pressure of the newly mounted wheel and adjust accordingly.
- ▶ **Vehicles with a tire pressure monitoring system:** Restart the tire pressure monitoring system (→ page 339).

Be sure to also observe the following further related subjects:

- Notes on tire pressure (→ page 333)

### Notes on technical data

The data stated only applies to vehicles with standard equipment. You can obtain further information from an authorized Mercedes-Benz Center.

### Vehicle electronics

#### Notes on installing two-way radios

**⚠ WARNING** Risk of accident from incorrectly carried out work on the RF transmitter

The electromagnetic radiation from RF transmitters can interfere with the vehicle electronics if RF transmitters are manipulated or retrofitted incorrectly.

This could jeopardize the operating safety of the vehicle.

- ▶ You should have all work on electrical and electronic components carried out at a qualified specialist workshop.

**⚠ WARNING** Risk of accident from incorrect operation of the RF transmitter

If you operate RF transmitters incorrectly in the vehicle, the electromagnetic radiation could interfere with the on-board electronics, e.g.:

- if the RF transmitter is not connected to an exterior antenna
- if the exterior antenna is not correctly mounted or is not a low-reflection type.

This could jeopardize the operating safety of the vehicle.

- ▶ Have the low-reflection exterior antenna installed at a qualified specialist workshop.
- ▶ When operating RF transmitters in the vehicle, always connect them to the low-reflection exterior antenna.

**! NOTE** Invalidation of the operating permit due to failure to comply with the instructions for installation and use

The operating permit may be invalidated if the instructions for installation and use of RF transmitters are not observed.

- ▶ Only use approved frequency bands.
- ▶ Observe the maximum permissible output power in these frequency bands.
- ▶ Only use approved antenna positions.

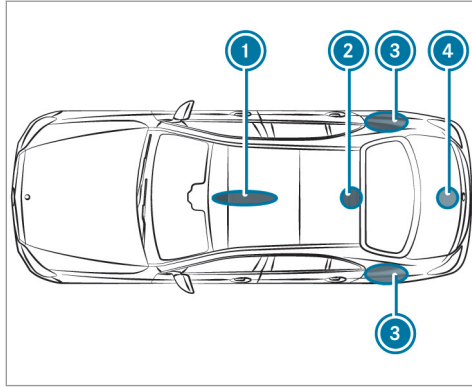

- ① Front roof area
- ② Rear roof area
- ③ Rear fender
- ④ Trunk lid

On vehicles with a panoramic sliding sunroof, installing an antenna on the front or rear roof area is not permitted.

On the rear fenders, it is recommended to position the antenna on the side of the vehicle closest to the center of the road.

Use Technical Specification ISO/TS 21609 (Road Vehicles – EMC guidelines for installation of aftermarket radio frequency transmitting equipment) when retrofitting RF (radio frequency) transmitters. Comply with the legal requirements for detachable parts.

If your vehicle has installations for two-way radio equipment, use the power supply or antenna connections intended for use with the basic wiring. Be sure to observe the manufacturer's additional instructions when installing.

The maximum transmission output (PEAK) at the base of the antenna must not exceed the values in the following table:

#### Frequency band and maximum transmission output

Frequency band	Maximum transmission output
Short wave 3 - 54 MHz	100 W
4 m band 74 - 88 MHz	30 W
2 m band 144 - 174 MHz	50 W
Trunked radio system/Tetra 380 - 460 MHz	10 W
70 cm band 400 - 460 MHz	35 W
Mobile communications (2G/3G/4G)	10 W

The following can be used in the vehicle without restrictions:

- RF transmitter with a maximum transmission output of up to 100 mW
- RF transmitters with transmitter frequencies in the 380 - 410 MHz frequency band and a maximum transmission output of up to 2 W (trunked radio system/Tetra)
- Mobile phones (2G/3G/4G)

There are no restrictions when positioning the antenna on the outside of the vehicle for the following frequency bands:

- Trunked radio system/Tetra
- 70 cm band
- 2G/3G/4G

## Vehicle identification plate, VIN and engine number

### Vehicle identification plate

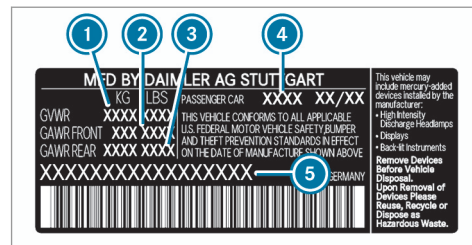
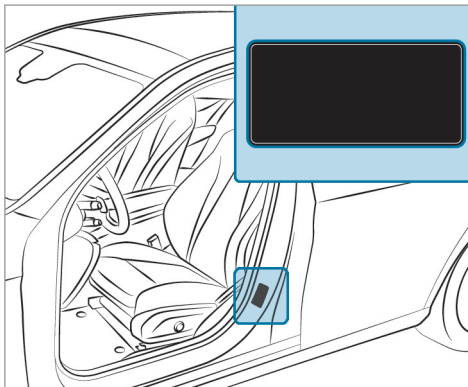

### Vehicle identification plate (USA only)

- 1 Permissible gross mass
- 2 Permissible front axle load
- 3 Permissible rear axle load
- 4 Paint code
- 5 VIN (vehicle identification number)

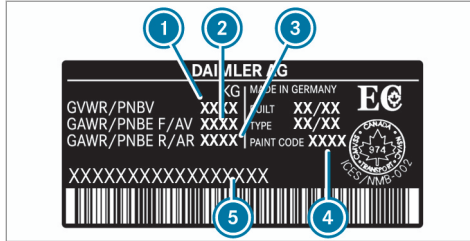

#### Vehicle identification plate (Canada only)

- ① Permissible gross mass
- ② Permissible front axle load
- ③ Permissible rear axle load
- ④ Paint code
- ⑤ VIN (vehicle identification number)

The maximum permissible gross vehicle weight rating is made up of the vehicle weight, all vehicle occupants, the fuel and the load. The maximum permissible axle load is the maximum weight that can be carried by one axle (front or rear axle).

Never exceed the maximum permissible gross vehicle weight rating or the maximum permissible axle load for the front or rear axle.

#### VIN in front of the right-hand front seat

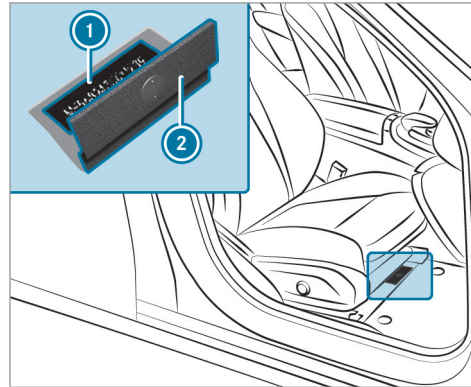

- ① VIN (vehicle identification number)
- ② Floor covering

#### Additional plates

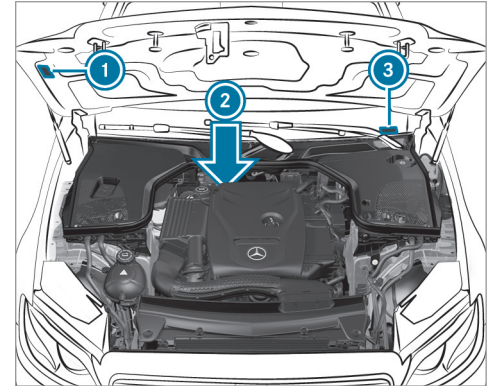

- ① Plate with information about emissions testing, including confirmation of emissions guidelines at the U.S. federal level as well as for California
- ② Engine number stamped into the crankcase
- ③ VIN (vehicle identification number)

## Operating fluids

### Notes on operating fluids

**⚠ WARNING** Risk of injury from operating fluids harmful to your health

Operating fluids may be poisonous and harmful to your health.

- ▶ Observe the text on the original containers when using, storing or disposing of operating fluids.
- ▶ Always store operating fluids sealed in their original containers.
- ▶ Always keep children away from operating fluids.

**ℹ ENVIRONMENTAL NOTE** Environmental pollution caused by environmentally irresponsible disposal

- ▶ Dispose of operating fluids in an environmentally responsible manner.

Operating fluids include the following:

- Fuels
- Lubricants
- Coolant
- Brake fluid
- Windshield washer fluid
- Climate control system refrigerant

Only use products recommended by Mercedes-Benz. Damage caused by using vehicle products which have not been recommended is not covered by the Mercedes-Benz guarantee, warranty or goodwill gestures.

You can identify operating fluids approved by Mercedes-Benz by the following inscription on the containers:

- MB-Freigabe (e.g. MB-Freigabe 229.51)
- MB-Approval (e.g. MB-Approval 229.51)

Further information on approved operating fluids:

- In the Mercedes-Benz Specifications for Operating Fluids at <http://bevo.mercedes-benz.com> (by entering the designation)
- At a qualified specialist workshop

**⚠ WARNING** Risk of fire and explosion caused by fuel

Fuels are highly inflammable.

- ▶ You must avoid fire, open flames, creating sparks and smoking.
- ▶ Before refueling, switch off the engine and, if installed in your vehicle, the stationary heater.

**⚠ WARNING** Risk of injury from fuel

Fuels are poisonous and harmful to your health

- ▶ Do not swallow fuel or let it come into contact with skin, eyes or clothing.
- ▶ Do not inhale fuel vapors.



- ▶ Keep children away from fuel.

If you or other people come into contact with fuel, observe the following:

- ▶ Immediately rinse fuel off your skin with soap and water.
- ▶ If fuel comes into contact with your eyes, immediately rinse them thoroughly with clean water. Seek medical attention immediately.
- ▶ If you swallow fuel, seek medical attention immediately. Do not induce vomiting.
- ▶ Change immediately out of clothing that has come into contact with fuel.

## Fuel

### Information on fuel grades for vehicles with a gasoline engine

Observe the notes on operating fluids (→ page 366).

#### **!** NOTE Damage caused by the wrong fuel

Even small amounts of the wrong fuel could result in damage to the fuel system, the engine and the emission control system.

- ▶ Only refuel with low-sulfur premium grade fuel.

This fuel may contain up to 10 % ethanol. Your vehicle is suitable for use with E10 fuel.

Do not refuel using:

- Diesel
- E15, E85, E100
- Gasoline containing methanol (M15, M30, M85, M100)
- Gasoline with additives containing metal

If you accidentally refuel with the wrong fuel:

- ▶ Do not switch the ignition on.
- ▶ Consult a qualified specialist workshop.

If the available fuel is not sufficiently low in sulfur, this can produce unpleasant odors.

Only refuel with fuel, that has at least the octane number specified in the information table in the fuel filler flap (→ page 139). This may reduce engine performance and increase fuel consumption.

**If you want maximum engine output:** Only refuel with unleaded premium grade gasoline with at least 95 RON.

Never refuel using gasoline with a lower RON.

#### **!** NOTE Premature wear caused by unleaded regular gasoline

Unleaded regular gasoline can cause the engine to wear more quickly and impair longevity and performance.

If unleaded premium grade gasoline is unavailable and you have to refuel using unleaded regular gasoline:

- ▶ Only fill the fuel tank to half full with unleaded regular gasoline and refill as soon as possible with unleaded premium grade gasoline.
- ▶ Do not drive at the maximum speed.

- ▶ Avoid sudden acceleration and engine speeds over 3,000 rpm.

Further information on fuel can be found:

- At a gas station
- At a qualified specialist workshop.
- **USA only:** Under <http://www.mbusa.com>

#### Information on additives in gasoline

Observe the notes on operating fluids (→ page 366).

- !** **NOTE** Damage caused by non-approved additives

Even small amounts of the wrong additive may lead to malfunctions occurring.

- ▶ Only add cleaning additives recommended by Mercedes-Benz to the fuel.

Mercedes-Benz recommends that you use fuel brands that have additives.

The fuel grade available in some countries may not be sufficient. Residue could build up in the fuel injection system as a result. In such cases,

and in consultation with an authorized Mercedes-Benz Center, the fuel may be mixed with the cleaning additive recommended by Mercedes-Benz. Always observe the notes and mixing ratios specified on the container.

#### Notes on fuel consumption

- !** **ENVIRONMENTAL NOTE** Increased CO<sub>2</sub> emissions caused by increased fuel consumption

The CO<sub>2</sub> emissions of your vehicle depend directly on the fuel consumption.

- ▶ You can minimize CO<sub>2</sub> emissions by driving carefully and having your vehicle serviced regularly.

#### Tank capacity and reserve fuel level

##### Tank capacity and reserve fuel level

Model	Total capacity
All models	17.4 US gal (66.0 l)
Model	Of which reserve
All models	1.8 US gal (7.0 l)

#### Notes on engine oil

Observe the notes on operating fluids (→ page 366).



**!** **NOTE** Engine damage caused by an incorrect oil filter, incorrect oil or additives

- ▶ Do not use engine oils or oil filters other than those which meet the specifications necessary for the prescribed service intervals.
- ▶ Do not alter the engine oil or oil filter in order to achieve longer change intervals than prescribed.
- ▶ Do not use additives.
- ▶ Have the engine oil changed after the prescribed intervals.

Further information on engine oils and oil filters:

- In the Mercedes-Benz Specifications for Operating Fluids at <http://bevo.mercedes-benz.com> (by entering the designation).
- At a qualified specialist workshop.

Mercedes-Benz recommends that you have the oil change carried out at a qualified specialist workshop.

### MB-Freigabe or MB-Approval

Gasoline engines	MB-Freigabe or MB-Approval
All models	229.5

If the engine oils listed in the table are not available, you may add a maximum of 1.1 US qt (1.0 l) of the following engine oils once:

The following values refer to an oil change, including the oil filter:

#### Capacity

Model	Capacity
E 300	7.4 US qt (7.0 l)
All other models	6.9 US qt (6.5 l)

#### Notes on brake fluid

Observe the notes on operating fluids (→ page 366).

**!** **WARNING** Risk of an accident due to vapor pockets forming in the brake system

The brake fluid constantly absorbs moisture from the air. This lowers the boiling point of the brake fluid. If the boiling point is too low, vapor pockets may form in the brake system when the brakes are applied hard.

This causes the braking effect to be impaired.

- ▶ Have the brake fluid renewed at the specified intervals.

Have the brake fluid regularly changed at a qualified specialist workshop.

Only use brake fluid approved by Mercedes-Benz according to MB-Freigabe or MB-Approval 331.0.

Further information on brake fluid:

- In the Mercedes-Benz Specifications for Operating Fluids at <http://bevo.mercedes-benz.com>
- At a qualified specialist workshop

### Notes on coolant

Observe the notes on operating fluids  
(→ page 366).

**⚠ WARNING** - Risk of fire and injury from antifreeze

If antifreeze comes into contact with hot component parts in the engine compartment, it may ignite.

- ▶ Allow the engine to cool down before adding antifreeze.
- ▶ Make sure that no antifreeze spills out next to the filler opening.
- ▶ Thoroughly clean off any antifreeze from component parts before starting the vehicle.

**! NOTE** Damage caused by incorrect coolant

- ▶ Only add coolant that has been pre-mixed with the required antifreeze protection.

Further information on coolant:

- In the Mercedes-Benz Specifications for Operating Fluids 310.1, e.g. online at <http://bevo.mercedes-benz.com>.
- At a qualified specialist workshop.

**! NOTE** Overheating at high outside temperatures

If an inappropriate coolant is used, the engine cooling system is not sufficiently protected against overheating and corrosion at high outside temperatures.

- ▶ Always use an appropriate coolant.

Have the coolant regularly changed at a qualified specialist workshop.

The proportion of corrosion inhibitor/ antifreeze concentrate in the engine cooling system should be:

- A minimum of 50% (antifreeze protection down to approximately -35 °F (-37 °C)).

- A maximum of 55% (antifreeze protection down to -49 °F (-45 °C)).

### Filling capacity

Model	Filling capacity
E 400 4MATIC	12.7 US qt (12.0 l)
All other models	9.5 US qt (9.0 l)

### Notes on windshield washer fluid

Observe the notes on operating fluids  
(→ page 366).

**⚠ WARNING** - Risk of fire and injury from windshield washer concentrate

Windshield washer concentrate is highly flammable. It could ignite if it comes into contact with hot engine component parts or the exhaust system.

- ▶ Make sure that no windshield washer concentrate spills out next to the filler opening.

**!** **NOTE** Damage to the exterior lighting due to unsuitable windshield washer fluid

Unsuitable windshield washer fluid may damage the plastic surface of the exterior lighting.

▶ Only use windshield washer fluid which is also suitable for use on plastic surfaces, e.g. MB SummerFit or MB WinterFit.

**!** **NOTE** Blocked spray nozzles caused by mixing windshield washer fluids

▶ Do not mix MB SummerFit and MB WinterFit with other windshield washer fluids.

Do not use distilled or de-ionized water as the fill level sensor may be triggered erroneously.

Recommended windshield washer fluid:

- Above freezing point: e.g. MB SummerFit
- Below freezing point: e.g. MB WinterFit

For the correct mixing ratio refer to the information on the antifreeze reservoir.

Add windshield washer fluid to the washer water all year round.

### Notes on refrigerants

Observe the notes on operating fluids (→ page 366).

**!** **NOTE** Damage due to incorrect refrigerant

If a non-approved refrigerant is used, the climate control system may be damaged.

▶ Only use the refrigerant R-134a

**!** **NOTE** Damage to the climate control system due to incorrect refrigerant compressor oil

▶ Only use refrigerant compressor oil that has been approved by Mercedes-Benz.

▶ Do not mix the approved refrigerant compressor oil with a different refrigerant compressor oil.

Work on the climate control system may only be carried out by a qualified specialist workshop. All applicable regulations, as well as SAE standard J639, must be adhered to.

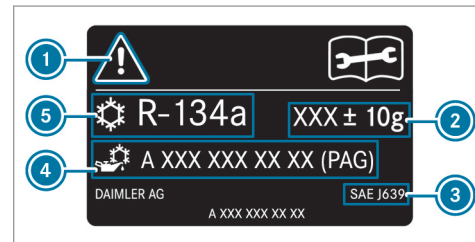

- 1 Warning symbol
- 2 Refrigerant filling capacity
- 3 Applicable standards
- 4 PAG oil part number
- 5 Type of refrigerant

## 372 Technical data

Warning symbols **1** advise you about:

- Possible dangers
- Having service work carried out at a qualified specialist workshop

### Filling capacity for refrigerant and PAG oil

Model	Refrigerant
All models	22.2 ± 0.4 oz (630 ± 10 g)

Model	PAG oil
All models	2.8 ± 0.4 oz (80 ± 10 g)

### Vehicle data

#### Vehicle dimensions

The heights specified may vary as a result of the:

- Tires
- Load
- Condition of the suspension

- Optional equipment

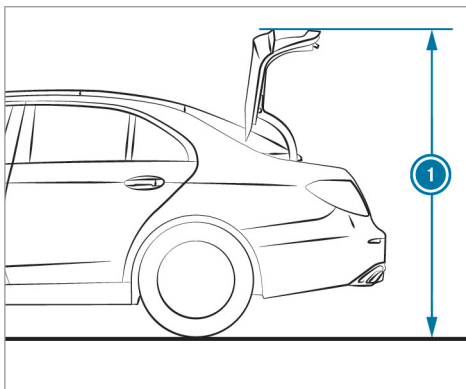

### Opening height

Model	<b>1</b> Opening height
E 300	72.4 in (1839 mm)
All other models	72.7 in (1846 mm)

### Vehicle dimensions

All models	
Vehicle length	193.8 in (4923 mm)
Vehicle width including outside mirrors	81.3 in (2065 mm)
Wheelbase	115.7 in (2939 mm)

Model	Vehicle height
E 300	57.8 in (1468 mm)
All other models	58.0 in (1474 mm)

Model	Turning radius
E 300	38.1 ft (11.60 m)
All other models	39.0 ft (11.90 m)

#### Roof load and trunk load

All models	
Maximum roof load	220 lb (100 kg)
Maximum trunk load	

#### Weights and loads

Please note that for the specified vehicle data:

- Optional equipment increases the curb weight and reduces the payload.

Missing values were not available at time of going to print.

## Display messages

### Introduction

#### Notes on display messages

Display messages appear in the multifunction display.

Display messages with graphic symbols are simplified in the Operator's Manual and may differ from the symbols in the multifunction display. The multifunction display shows high-priority display messages in red. Certain display messages are accompanied by a warning tone.

Please respond in accordance with the display messages and follow the additional notes in this Operator's Manual.

Low-priority display messages can be hidden by pressing the  button or the left-hand side of Touch Control. The display messages are then stored in the message memory. Rectify the cause of a display message as quickly as possible.

High-priority display messages cannot be hidden. The multifunction display shows these display messages continuously until the cause for the display message has been rectified.

#### Calling up stored display messages

On-board computer:

 **Service**  **1 Message**



If there are no display messages, the **No Messages** display appears in the multifunction display.

▶ Scroll through the display messages by swiping upwards or downwards on Touch Control on the left-hand side of the steering wheel.

▶ **To exit the message memory:** press the  button.





## Safety systems

Display messages	Possible causes/consequences and ► Solutions
<div data-bbox="205 294 362 373">  </div> <div data-bbox="205 379 362 458">  </div> <p data-bbox="195 469 458 519">Currently Unavailable See Operator's Manual</p>	<p data-bbox="526 291 1234 353">* ABS and ESP<sup>®</sup> are temporarily unavailable. Other driving and driving safety systems may also be malfunctioning.</p> <div data-bbox="547 370 1696 617" style="border: 1px solid gray; padding: 5px;"> <p data-bbox="565 379 1240 408"><b>▲ WARNING</b> Risk of skidding if ABS and ESP<sup>®</sup> are malfunctioning</p> <p data-bbox="565 422 1641 472">If ABS and ESP<sup>®</sup> are malfunctioning, the wheels could lock when braking and ESP<sup>®</sup> cannot carry out vehicle stabilization.</p> <p data-bbox="565 484 1677 534">The steering capability and braking characteristics are thus severely impaired. The braking distance in an emergency braking situation can increase. In addition, other driving safety systems are switched off.</p> <ul data-bbox="565 547 1360 607" style="list-style-type: none"> <li data-bbox="565 547 778 570">► Drive on carefully.</li> <li data-bbox="565 583 1360 607">► Have ABS and ESP<sup>®</sup> checked immediately at a qualified specialist workshop.</li> </ul> </div> <ul data-bbox="547 635 1685 715" style="list-style-type: none"> <li data-bbox="547 635 1628 684">► Carefully drive on a suitable stretch of road, making slight steering movements at a speed above 19 mph (30 km/h).</li> <li data-bbox="547 697 1685 715">► If the display message does not disappear, consult a qualified specialist workshop immediately. Drive carefully.</li> </ul>

Display messages	Possible causes/consequences and ► Solutions
 <p data-bbox="144 342 408 391">Currently Unavailable See Operator's Manual</p>	<p data-bbox="476 249 1182 311">* ESP® is temporarily unavailable. Other driving and driving safety systems may also be malfunctioning.</p> <div data-bbox="495 329 1646 515" style="border: 1px solid gray; padding: 5px;"><p data-bbox="513 339 1082 365"><b>▲ WARNING</b> Risk of skidding if ESP is malfunctioning®</p><p data-bbox="513 381 1613 433">If ESP® is malfunctioning, ESP® cannot carry out vehicle stabilization. In addition, other driving safety systems are switched off.</p><ul data-bbox="513 443 1092 505" style="list-style-type: none"><li data-bbox="513 443 728 469">▶ Drive on carefully.</li><li data-bbox="513 479 1092 505">▶ Have ESP® checked at a qualified specialist workshop.</li></ul></div> <ul data-bbox="495 531 1637 619" style="list-style-type: none"><li data-bbox="495 531 1576 583">▶ Carefully drive on a suitable stretch of road, making slight steering movements at a speed above 19 mph (30 km/h).</li><li data-bbox="495 593 1637 619">▶ If the display message does not disappear, consult a qualified specialist workshop immediately. Drive carefully.</li></ul>

Display messages	Possible causes/consequences and ► Solutions
 <p data-bbox="195 344 467 391">Inoperative See Operator's Manual</p>	<p data-bbox="528 251 781 277">* ESP® is malfunctioning.</p> <p data-bbox="545 288 1230 313">Other driving and driving safety systems may also be malfunctioning.</p> <p data-bbox="545 324 1698 370">The brake system continues to operate normally. The braking distance may increase in an emergency braking situation.</p> <div data-bbox="545 391 1698 578" style="border: 1px solid gray; padding: 5px;"><p data-bbox="569 401 1132 427"><b>▲ WARNING</b> Risk of skidding if ESP is malfunctioning®</p><p data-bbox="561 443 1663 490">If ESP® is malfunctioning, ESP® cannot carry out vehicle stabilization. In addition, other driving safety systems are switched off.</p><ul data-bbox="561 505 1142 567" style="list-style-type: none"><li data-bbox="561 505 781 531">► Drive on carefully.</li><li data-bbox="561 541 1142 567">► Have ESP® checked at a qualified specialist workshop.</li></ul></div> <ul data-bbox="545 593 1105 650" style="list-style-type: none"><li data-bbox="545 593 763 619">► Drive on carefully.</li><li data-bbox="545 629 1105 650">► Consult a qualified specialist workshop immediately.</li></ul>

Display messages	Possible causes/consequences and ► Solutions
<div data-bbox="155 252 310 325" style="border: 1px solid black; padding: 5px; text-align: center; font-size: 24px; font-weight: bold;">EBD</div> <div data-bbox="155 335 310 418" style="border: 1px solid black; padding: 5px; text-align: center;">  </div> <div data-bbox="155 428 310 501" style="border: 1px solid black; padding: 5px; text-align: center;">  </div> <p data-bbox="144 511 417 563">Inoperative See Operator's Manual</p>	<p data-bbox="473 249 894 275">* EBD, ABS and ESP® are malfunctioning.</p> <p data-bbox="491 285 1184 311">Other driving and driving safety systems may also be malfunctioning.</p> <div data-bbox="500 329 1646 370" style="background-color: #f0f0f0; padding: 5px;"> <p data-bbox="513 337 1245 363"><b>▲ WARNING</b> Risk of skidding if EBD, ABS and ESP® are malfunctioning</p> </div> <p data-bbox="510 381 1628 433">If EBD, ABS and ESP® are malfunctioning, the wheels can lock when braking and ESP® cannot carry out vehicle stabilization.</p> <p data-bbox="510 443 1628 495">The steering capability and braking characteristics are thus severely impaired. The braking distance in an emergency braking situation can increase. In addition, other driving safety systems are switched off.</p> <ul style="list-style-type: none"> <li data-bbox="510 505 728 531">▶ Drive on carefully.</li> <li data-bbox="510 541 1337 567">▶ Have the brake system checked immediately at a qualified specialist workshop.</li> </ul> <ul style="list-style-type: none"> <li data-bbox="491 588 709 614">▶ Drive on carefully.</li> <li data-bbox="491 624 1055 650">▶ Consult a qualified specialist workshop immediately.</li> </ul>

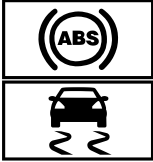
Display messages	Possible causes/consequences and ► Solutions
 <p data-bbox="195 427 467 477">Inoperative See Operator's Manual</p>	<p data-bbox="524 251 1234 313">* ABS and ESP® are malfunctioning. Other driving and driving safety systems may also be malfunctioning.</p> <div data-bbox="550 329 1698 578" style="border: 1px solid black; padding: 5px;"> <p data-bbox="565 339 1241 366"><b>▲ WARNING</b> Risk of skidding if ABS and ESP® are malfunctioning</p> <p data-bbox="565 381 1641 433">If ABS and ESP® are malfunctioning, the wheels could lock when braking and ESP® cannot carry out vehicle stabilization.</p> <p data-bbox="565 447 1677 499">The steering capability and braking characteristics are thus severely impaired. The braking distance in an emergency braking situation can increase. In addition, other driving safety systems are switched off.</p> <ul style="list-style-type: none"> <li data-bbox="565 509 779 530">► Drive on carefully.</li> <li data-bbox="565 540 1363 567">► Have ABS and ESP® checked immediately at a qualified specialist workshop.</li> </ul> </div> <ul style="list-style-type: none"> <li data-bbox="547 598 761 619">► Drive on carefully.</li> <li data-bbox="547 629 1105 656">► Consult a qualified specialist workshop immediately.</li> </ul>









Display messages	Possible causes/consequences and ► Solutions
<div data-bbox="155 252 310 332" data-label="Image"> </div> <p data-bbox="144 339 251 366">(USA only)</p> <div data-bbox="155 379 310 458" data-label="Image"> </div> <p data-bbox="144 466 284 493">(Canada only)</p> <p data-bbox="144 503 388 526">Check Brake Fluid Level</p>	<p data-bbox="473 246 1079 273">* There is not enough brake fluid in the brake fluid reservoir.</p> <div data-bbox="513 298 1646 495" data-label="Complex-Block" style="border: 1px solid gray; padding: 5px;"> <p data-bbox="513 298 1134 325">▲ <b>WARNING</b> Risk of an accident due to low brake fluid level</p> <p data-bbox="513 339 1511 366">If the brake fluid level is too low, the braking effect and the braking characteristics may be impaired.</p> <ul style="list-style-type: none"> <li data-bbox="513 375 1585 426">▶ Pull over and stop the vehicle safely as soon as possible, paying attention to road and traffic conditions. Do not continue driving under any circumstances.</li> <li data-bbox="513 435 946 486">▶ Consult a qualified specialist workshop. Do not add brake fluid.</li> </ul> </div> <ul style="list-style-type: none"> <li data-bbox="495 515 1641 567">▶ Pull over and stop the vehicle safely as soon as possible, paying attention to road and traffic conditions. Do not continue driving under any circumstances.</li> <li data-bbox="495 576 927 627">▶ Consult a qualified specialist workshop. Do not add brake fluid.</li> </ul>
<div data-bbox="155 643 310 723" data-label="Image"> </div> <p data-bbox="144 730 376 753">Check Brake Pad Wear</p>	<p data-bbox="473 637 968 664">* The brake linings have reached their wear limit.</p> <ul style="list-style-type: none"> <li data-bbox="495 672 927 699">▶ Consult a qualified specialist workshop.</li> </ul>

Display messages	Possible causes/consequences and ► Solutions
<p>Radar Sensors Dirty See Operator's Manual</p>	<p>* The radar sensor system is malfunctioning. Possible causes are:</p> <ul style="list-style-type: none"> <li>• soiling of the sensors</li> <li>• heavy rain</li> <li>• extended driving on inter-urban roads without moving traffic, e.g. in the desert</li> </ul> <p>Driving systems and driving safety systems may be malfunctioning or temporarily unavailable. When the causes no longer apply, driving systems and driving safety systems are available again.</p> <p>If the display message does not disappear:</p> <ul style="list-style-type: none"> <li>► Pull over and stop the vehicle safely as soon as possible, paying attention to road and traffic conditions.</li> <li>► Clean all sensors .</li> <li>► Restart the engine.</li> </ul>
<p>Active Brake Assist Functions Currently Limited See Operator's Manual</p>	<p>* Active Brake Assist with cross-traffic function, Evasive Steering Assist or PRE-SAFE® PLUS is temporarily unavailable or only partially available.</p> <p>The ambient conditions are outside the system limits (→ page 153).</p> <ul style="list-style-type: none"> <li>► Drive on. As soon as the ambient conditions are within the system limits, the systems will be available again.</li> <li>► If the display message does not disappear, stop the vehicle while paying attention to road and traffic conditions and restart the engine.</li> </ul>

## 382 Display messages and warning/indicator lamps

Display messages	Possible causes/consequences and ► Solutions
Active Brake Assist Functions Limited See Operator's Manual	* Active Brake Assist with cross-traffic function, Evasive Steering Assist or PRE-SAFE® PLUS is malfunctioning. ► Consult a qualified specialist workshop.
Active Brake Assist Functions Currently Limited See Operator's Manual	* Active Brake Assist is temporarily unavailable. The ambient conditions are outside the system limits . ► Drive on. As soon as the ambient conditions are within the system limits, the system will become available again. ► If the display message does not disappear, stop the vehicle while paying attention to road and traffic conditions and restart the engine.
Active Brake Assist Functions Limited See Operator's Manual	* Active Brake Assist is malfunctioning. ► Consult a qualified specialist workshop.
PRE-SAFE Impulse Side Inoperative See Operator's Manual	* Side PRE-SAFE® Impulse is malfunctioning or inoperative after having already been triggered. ► Consult a qualified specialist workshop.
PRE-SAFE Inoperative See Operator's Manual	* PRE-SAFE® functions are malfunctioning. ► Consult a qualified specialist workshop.



Display messages	Possible causes/consequences and ► Solutions
<div data-bbox="205 252 362 334"></div> <div data-bbox="205 342 306 366">(USA only)</div> <div data-bbox="205 381 362 463"></div> <div data-bbox="205 471 340 495">(Canada only)</div> <div data-bbox="195 505 463 557">Turn On the Ignition to Release the Parking Brake</div>	<p>* The red  (USA only) or  (Canada only) indicator lamp is lit. You have attempted to release the electric parking brake with the ignition switched off.</p> <ul style="list-style-type: none"> <li>► Switch the ignition on.</li> </ul>
<div data-bbox="205 573 362 655"></div> <div data-bbox="205 664 306 687">(USA only)</div> <div data-bbox="205 702 362 784"></div> <div data-bbox="205 792 340 816">(Canada only)</div> <div data-bbox="195 826 430 873">Please Release Parking Brake</div>	<p>* The red  (USA only) or  (Canada only) indicator lamp flashes. The electric parking brake is applied while driving:</p> <ul style="list-style-type: none"> <li>• A condition for automatic release of the electric parking brake is not fulfilled .</li> <li>• You are performing emergency braking using the electric parking brake .</li> </ul> <ul style="list-style-type: none"> <li>► Check that the conditions for automatic release of the electric parking brake are fulfilled.</li> <li>► Release the electric parking brake manually.</li> </ul>

Display messages



(USA only)



(Canada only)

[Parking Brake See Operator's Manual](#)

Possible causes/consequences and ► Solutions

\* The yellow indicator lamp is lit. The electric parking brake is malfunctioning.

**To apply:**

- Switch off the ignition and turn it back on.
- Apply the electric parking brake manually .

If it is not possible to engage the electric parking brake:

- Consult a qualified specialist workshop.
- Where necessary, also safeguard the parked vehicle against rolling away.

The yellow and the red (USA only) or (Canada only) indicator lamps are lit. The electric parking brake is malfunctioning.

**To release:**

- Switch off the ignition and turn it back on.
- Release the electric parking brake manually .

or





- Release the electric parking brake automatically .

If it is still not possible to release the electric parking brake:



- Do not continue driving under any circumstances. Consult a qualified specialist workshop.



The yellow indicator lamp is lit and the red (USA only) or (Canada only) indicator lamp is flashing. The electric parking brake is malfunctioning.

The electric parking brake could not be applied or released.

Display messages	Possible causes/consequences and ► Solutions
	<ul style="list-style-type: none"> <li>► Switch off the ignition and turn it back on.</li> </ul> <p><b>To apply:</b></p> <ul style="list-style-type: none"> <li>► Release and then apply the electric parking brake manually .</li> </ul> <p><b>To release:</b></p> <ul style="list-style-type: none"> <li>► Apply and then release the electric parking brake manually.</li> </ul> <p>If the electric parking brake cannot be applied or the red  (USA only) or  (Canada only) indicator lamp continues to flash:</p> <ul style="list-style-type: none"> <li>► Do not continue driving under any circumstances. Consult a qualified specialist workshop.</li> <li>► Where necessary, also safeguard the parked vehicle against rolling away.</li> </ul> <p>The yellow indicator lamp  is on and the red  indicator lamp (USA only) or  (Canada only) indicator lamp flashes for approximately ten seconds after the electric parking brake has been applied or released. It then remains lit or goes out. The electric parking brake is malfunctioning.</p> <p><b>If the battery charge level is too low:</b></p> <ul style="list-style-type: none"> <li>► Charge the battery.</li> </ul> <p><b>To apply:</b></p> <ul style="list-style-type: none"> <li>► Switch the ignition off. The electric parking brake is applied automatically.</li> </ul>

Display messages	Possible causes/consequences and ► Solutions
	<p>If you do not wish the electric parking brake to be applied, leave the ignition switched on, e.g. when washing the vehicle in an automatic car wash or when having the vehicle towed away. This is not necessary when towing the vehicle away with the rear axle raised.</p> <p>If the electric parking brake is not applied automatically:</p> <ul style="list-style-type: none"><li>► Switch off the ignition and turn it back on.</li><li>► Release and then apply the electric parking brake manually .</li></ul> <p>If it is still not possible to apply the electric parking brake:</p> <ul style="list-style-type: none"><li>► Consult a qualified specialist workshop.</li><li>► Where necessary, also safeguard the parked vehicle against rolling away.</li></ul> <p><b>To release:</b></p> <ul style="list-style-type: none"><li>► If the conditions for automatic release are fulfilled and the electric parking brake is not released automatically, release the electric parking brake manually .</li></ul> <p>If it is still not possible to release the electric parking brake:</p> <ul style="list-style-type: none"><li>► Do not continue driving under any circumstances. Consult a qualified specialist workshop.</li></ul>

Display messages	Possible causes/consequences and ► Solutions
 <p data-bbox="195 344 445 394">SRS Malfunction Service Required</p>	<p data-bbox="526 249 1060 275">* The restraint system is malfunctioning (→ page 31).</p> <div data-bbox="550 293 1702 464"><p data-bbox="565 301 1435 327"><b>▲ WARNING</b> Risk of injury or fatal injury due to a malfunction in the restraint system</p><p data-bbox="565 342 1646 420">If the restraint system is malfunctioning, restraint system components may be triggered unintentionally or might not be triggered at all in the event of an accident. This may affect the Emergency Tensioning Device or airbag, for example.</p><p data-bbox="565 430 1548 456">► Have the restraint system checked and repaired immediately at a qualified specialist workshop.</p></div> <p data-bbox="547 482 981 508">Detection of a restraint system malfunction</p> <ul data-bbox="547 519 1522 576" style="list-style-type: none"><li data-bbox="547 519 1493 544">• The  restraint system warning lamp does not light up when the ignition is switched on.</li><li data-bbox="547 550 1522 576">• The  restraint system warning lamp lights up continuously or repeatedly during a journey.</li></ul> <p data-bbox="547 591 1105 617">► Consult a qualified specialist workshop immediately.</p>





Display messages	Possible causes/consequences and ► Solutions
<div data-bbox="155 252 312 335" data-label="Image"> </div> <p data-bbox="144 342 408 394">Example: Front Left Malfunction Service Required</p>	<p data-bbox="476 249 1160 275">* The corresponding restraint system is malfunctioning (→ page 31).</p> <div data-bbox="513 291 1648 464" data-label="Complex-Block"> <p data-bbox="513 298 1387 324">▲ <b>WARNING</b> Risk of injury or fatal injury due to a malfunction in the restraint system</p> <p data-bbox="513 339 1596 417">If the restraint system is malfunctioning, restraint system components may be triggered unintentionally or might not be triggered at all in the event of an accident. This may affect the Emergency Tensioning Device or airbag, for example.</p> <p data-bbox="513 427 1498 453">► Have the restraint system checked and repaired immediately at a qualified specialist workshop.</p> </div> <p data-bbox="495 479 929 505">Detection of a restraint system malfunction</p> <ul data-bbox="500 515 1471 572" style="list-style-type: none"> <li data-bbox="500 515 1443 541">• The  restraint system warning lamp does not light up when the ignition is switched on.</li> <li data-bbox="500 552 1471 572">• The  restraint system warning lamp lights up continuously or repeatedly during a journey.</li> </ul> <p data-bbox="495 593 1055 619">► Consult a qualified specialist workshop immediately.</p>
<div data-bbox="155 632 312 715" data-label="Image"> </div> <p data-bbox="144 723 417 800">Example: Left Side Curtain Airbag Malfunction Service Required</p>	<p data-bbox="476 629 1147 655">* The corresponding window airbag is malfunctioning (→ page 37).</p> <div data-bbox="513 671 1648 816" data-label="Complex-Block"> <p data-bbox="513 678 1360 704">▲ <b>WARNING</b> Risk of injury or fatal injury due to malfunctions in the window airbag</p> <p data-bbox="513 720 1596 771">If the window airbag is malfunctioning, it might be triggered unintentionally or might not be triggered at all in the event of an accident with high deceleration.</p> <p data-bbox="513 782 1483 808">► Have the window airbag checked and repaired immediately at a qualified specialist workshop.</p> </div> <p data-bbox="495 833 1055 859">► Consult a qualified specialist workshop immediately.</p>



Display messages	Possible causes/consequences and ► Solutions
 <p data-bbox="195 344 310 370">Inoperative</p>	<ul style="list-style-type: none"> <li>* One or more main features of the mbrace system are malfunctioning.           <ul style="list-style-type: none"> <li>► Consult a qualified specialist workshop.</li> </ul> </li> </ul>
<p data-bbox="195 386 476 464">Front Passenger Airbag Disabled See Operator's Manual</p>	<ul style="list-style-type: none"> <li>* The front passenger airbag and the knee airbag are deactivated, even though an adult or a person with a build corresponding to that of an adult is seated on the front passenger seat. If additional forces are applied to the seat, the system may interpret the occupant's weight as lower than it actually is.</li> </ul> <div data-bbox="547 474 1698 679" style="border: 1px solid gray; padding: 5px;"> <p><b>⚠ WARNING</b> Risk of injury or fatal injury due to a disabled front passenger airbag</p> <p>If the front passenger airbag is disabled, the front passenger airbag will not be deployed in the event of an accident and cannot perform its intended protective function.</p> <p>A person in the front passenger seat could then, for example, come into contact with the vehicle's interior, especially if the person is sitting too close to the cockpit.</p> <ul style="list-style-type: none"> <li>► Make sure, both before and during the journey, that the status of the front passenger airbag is correct.</li> </ul> </div> <ul style="list-style-type: none"> <li>► Pull over and stop the vehicle safely as soon as possible, paying attention to road and traffic conditions.</li> <li>► Check the status of the automatic front passenger airbag shutoff .</li> <li>► If necessary, consult a qualified specialist workshop immediately.</li> </ul>



Display messages	Possible causes/consequences and ► Solutions
<p>Front Passenger Airbag Enabled See Operator's Manual</p>	<p>* The front passenger airbag and knee airbags are enabled during the journey:</p> <ul style="list-style-type: none"><li>• Even when a child, a small adult or an object weighing less than the system weight threshold is located on the front passenger seat.</li><li>• Even when the front passenger seat is not occupied.</li></ul> <p>The system may detect objects or forces applying additional weight on the seat.</p> <p><b>▲ WARNING</b> Risk of injury or fatal injury by using a child restraint system with the front passenger airbag enabled</p> <p>If you secure a child in a child restraint system on the front passenger seat and the front passenger airbag is enabled, the front passenger airbag can deploy in the event of an accident.</p> <p>The child could be struck by the airbag.</p> <p>► Make sure, both before and during the journey, that the status of the front passenger airbag is correct.</p> <ul style="list-style-type: none"><li>► Pull over and stop the vehicle safely as soon as possible, paying attention to road and traffic conditions.</li><li>► Check the status of the automatic front passenger airbag shutoff .</li><li>► If necessary, consult a qualified specialist workshop immediately.</li></ul>



## Driving systems

Display messages	Possible causes/consequences and ► Solutions
 <p data-bbox="195 384 473 430">ATTENTION ASSIST: Take a Break!</p>	<ul style="list-style-type: none"> <li>* ATTENTION ASSIST has detected fatigue or an increasing lack of concentration on the part of the driver (→ page 185).               <ul style="list-style-type: none"> <li>► If necessary, take a break.</li> </ul> </li> </ul>
 <p data-bbox="195 542 473 589">ATTENTION ASSIST Inoperative</p>	<ul style="list-style-type: none"> <li>* ATTENTION ASSIST is malfunctioning.               <ul style="list-style-type: none"> <li>► Consult a qualified specialist workshop.</li> </ul> </li> </ul>
 <p data-bbox="195 700 232 715">Off</p>	<ul style="list-style-type: none"> <li>* The HOLD function is deactivated because the vehicle is skidding or a condition for activation is not met.               <ul style="list-style-type: none"> <li>► Reactivate the HOLD function later or check the activation conditions for the HOLD function .</li> </ul> </li> </ul>
 <p data-bbox="195 827 463 843">Vehicle Rising Please Wait</p>	<ul style="list-style-type: none"> <li>* The vehicle level is too low and the vehicle rises to the selected vehicle level.               <ul style="list-style-type: none"> <li>► Wait until the display message disappears before pulling away.</li> </ul> </li> </ul>

Display messages	Possible causes/consequences and ► Solutions
 <p data-bbox="144 342 384 391">Malfunction See Operator's Manual</p>	<p data-bbox="476 249 1517 273">* The AIR BODY CONTROL function is restricted. The vehicle's handling characteristics may be affected.</p> <ul style="list-style-type: none"> <li data-bbox="495 283 1424 307">► Drive in a manner appropriate for the current level, but do not exceed 50 mph (80 km/h).</li> <li data-bbox="495 318 925 341">► Consult a qualified specialist workshop.</li> </ul>
 <p data-bbox="144 501 395 550">Stop Vehicle Too Low</p>	<p data-bbox="476 408 1097 432">* You have pulled away although the vehicle level was too low.</p> <ul style="list-style-type: none"> <li data-bbox="495 442 1567 491">► Pull over and stop the vehicle safely as soon as possible, paying attention to road and traffic conditions. The vehicle rises to the selected vehicle level.</li> <li data-bbox="495 501 1153 525">► Wait until the display message disappears before pulling away.</li> </ul> <p data-bbox="495 553 1637 577">If the display message does not disappear and a warning tone also sounds, AIR BODY CONTROL is malfunctioning:</p> <ul style="list-style-type: none"> <li data-bbox="495 587 1530 611">► Do not drive faster than 50 mph (80 km/h) and consult a qualified specialist workshop immediately.</li> </ul> <div data-bbox="500 636 1646 781" style="border: 1px solid black; padding: 5px;"> <p data-bbox="513 646 1559 670"><b>!</b> <b>NOTE</b> The tires of the front axle or the front fenders could be damaged by large steering movements</p> <ul style="list-style-type: none"> <li data-bbox="513 687 1313 711">► Avoid large steering movements while driving and listen for scraping sounds.</li> <li data-bbox="513 722 1604 770">► If you hear scraping sounds, pull over and stop the vehicle safely, paying attention to road and traffic conditions, and set a higher vehicle level if possible.</li> </ul> </div> <ul style="list-style-type: none"> <li data-bbox="495 801 1049 850">► Set a higher vehicle level . Depending on the malfunction, the vehicle is raised.</li> </ul>

Display messages	Possible causes/consequences and ► Solutions
 <p>Drive More Slowly</p>	<ul style="list-style-type: none"> <li>* You are driving too fast for the selected vehicle level.                             <ul style="list-style-type: none"> <li>► In order to adjust the vehicle level, you must not drive faster than 50 mph (80 km/h).</li> <li>► In order to adjust the vehicle level during trailer operation, you must not drive faster than 19 mph (30 km/h).</li> </ul> </li> </ul>
 <p>Vehicle Rising</p>	<ul style="list-style-type: none"> <li>* Your vehicle is adjusting to the level you have selected.</li> </ul>
 <p>Compressor Is Cooling</p>	<ul style="list-style-type: none"> <li>* Due to frequent level changes within a short space of time, the compressor first needs to cool down in order to set the selected vehicle level.                             <ul style="list-style-type: none"> <li>► Drive on in a manner appropriate for the current level. Make sure that there is sufficient ground clearance.</li> <li>► When the compressor has cooled down, the vehicle continues rising to the selected vehicle level.</li> </ul> </li> </ul>

### 394 Display messages and warning/indicator lamps

Display messages	Possible causes/consequences and ► Solutions
<a href="#">Traffic Sign Assist Camera View Restricted See Operator's Manual</a>	<p>* The camera view is reduced. Possible causes are:</p> <ul style="list-style-type: none"><li>• Dirt on the windshield in the camera's field of vision</li><li>• Heavy rain, snow or fog</li></ul> <p>Driving systems and driving safety systems may be malfunctioning or temporarily unavailable. When the causes no longer apply, driving systems and driving safety systems are available again. If the display message does not disappear:</p> <ul style="list-style-type: none"><li>► Pull over and stop the vehicle safely as soon as possible, paying attention to road and traffic conditions.</li><li>► Clean the windshield.</li></ul>
<a href="#">Traffic Sign Assist Currently Unavailable See Operator's Manual</a>	<p>* Traffic Sign Assist is temporarily unavailable.</p> <ul style="list-style-type: none"><li>► Drive on. When the causes no longer apply, the system will be available again.</li></ul>
<a href="#">Traffic Sign Assist Inoperative</a>	<p>* Traffic Sign Assist is malfunctioning.</p> <ul style="list-style-type: none"><li>► Consult a qualified specialist workshop.</li></ul>

Display messages	Possible causes/consequences and ► Solutions
<p>Active Lane Keeping Assist Currently Unavailable See Operator's Manual</p>	<p>* Active Lane keeping Assist is temporarily unavailable. The ambient conditions are outside the system limits (→ page 191). <b>Vehicles with Steering Pilot:</b> The camera view may be restricted by the windshield.</p> <ul style="list-style-type: none"> <li>► Drive on. As soon as the ambient conditions are within the system limits, the system will become available again.</li> </ul> <p>If the display message does not disappear on vehicles with Steering Pilot:</p> <ul style="list-style-type: none"> <li>► Pull over and stop the vehicle safely as soon as possible, paying attention to road and traffic conditions.</li> <li>► Clean the windshield.</li> </ul>
<p>Active Lane Keeping Assist Inoperative</p>	<p>* Active Lane Keeping Assist is malfunctioning.</p> <ul style="list-style-type: none"> <li>► Consult a qualified specialist workshop.</li> </ul>

Display messages	Possible causes/consequences and ► Solutions
<p>Active Lane Keeping Assist Camera View Restricted See Operator's Manual</p>	<p>* <b>Vehicles without Steering Pilot:</b> The camera view is reduced. Possible causes are:</p> <ul style="list-style-type: none"> <li>• Dirt on the windshield in the camera's field of vision</li> <li>• Heavy rain, snow or fog</li> </ul> <p>Driving systems and driving safety systems may be malfunctioning or temporarily unavailable. When the causes no longer apply, driving systems and driving safety systems are available again. If the display message does not disappear:</p> <ul style="list-style-type: none"> <li>► Pull over and stop the vehicle safely as soon as possible, paying attention to road and traffic conditions.</li> <li>► Clean the windshield.</li> </ul>
<p>Blind Spot Assist Currently Unavailable See Operator's Manual</p>	<p>* Blind Spot Assist is temporarily unavailable. The system limits have been reached (→ page 189).</p> <ul style="list-style-type: none"> <li>► Drive on. When the causes no longer apply, the system will be available again.</li> </ul> <p>or</p> <ul style="list-style-type: none"> <li>► If the display message does not disappear, stop the vehicle while paying attention to road and traffic conditions and restart the engine.</li> <li>► If necessary, clean the rear bumper. If the bumper is extremely dirty, the sensors in the bumper may be malfunctioning.</li> </ul>

Display messages	Possible causes/consequences and ► Solutions
Blind Spot Assist Not Available When Towing a Trailer See Operator's Manual	<ul style="list-style-type: none"> <li>* When you establish the electrical connection to the trailer, Blind Spot Assist is unavailable.               <ul style="list-style-type: none"> <li>► Press the left-hand side of Touch Control and confirm the display message.</li> </ul> </li> </ul>
Blind Spot Assist Inoperative	<ul style="list-style-type: none"> <li>* Blind Spot Assist is malfunctioning.               <ul style="list-style-type: none"> <li>► Consult a qualified specialist workshop.</li> </ul> </li> </ul>
Active Blind Spot Assist Currently Unavailable See Operator's Manual	<ul style="list-style-type: none"> <li>* Active Blind Spot Assist is temporarily unavailable. The system limits have been reached (→ page 189).               <ul style="list-style-type: none"> <li>► Drive on. When the causes no longer apply, the system will be available again.</li> <li>► If the display message does not disappear, stop the vehicle while paying attention to road and traffic conditions and restart the engine.</li> </ul> </li> </ul>
Active Blind Spot Asst. Not Available When Towing a Trailer See Operator's Manual	<ul style="list-style-type: none"> <li>* When you establish the electrical connection to the trailer, Active Blind Spot Assist is unavailable.               <ul style="list-style-type: none"> <li>► Press the left-hand side of Touch Control and confirm the display message.</li> </ul> </li> </ul>
Active Blind Spot Assist Inoperative	<ul style="list-style-type: none"> <li>* Active Blind Spot Assist is malfunctioning.               <ul style="list-style-type: none"> <li>► Consult a qualified specialist workshop.</li> </ul> </li> </ul>

Display messages	Possible causes/consequences and ► Solutions
Steering Pilot Currently Unavailable See Operator's Manual	<ul style="list-style-type: none"> <li>* Steering Pilot is temporarily unavailable. The ambient conditions are outside the system limits (→ page 166).                             <ul style="list-style-type: none"> <li>► Drive on. As soon as the ambient conditions are within the system limits, the system will become available again.</li> <li>► If necessary, clean the windshield in the camera's field of vision.</li> </ul> </li> </ul>
Steering Pilot Inoperative	<ul style="list-style-type: none"> <li>* Steering Pilot is malfunctioning. Distance Pilot DISTRONIC remains available.                             <ul style="list-style-type: none"> <li>► Consult a qualified specialist workshop.</li> </ul> </li> </ul>
Distance Pilot Inoperative	<ul style="list-style-type: none"> <li>* Distance Pilot DISTRONIC is malfunctioning. Other driving and driving safety systems may also be malfunctioning.                             <ul style="list-style-type: none"> <li>► Consult a qualified specialist workshop.</li> </ul> </li> </ul>
Distance Pilot Now Available	<ul style="list-style-type: none"> <li>* Distance Pilot DISTRONIC is operational again and can be activated (→ page 162).</li> </ul>
Distance Pilot Currently Unavailable See Operator's Manual	<ul style="list-style-type: none"> <li>* Distance Pilot DISTRONIC is temporarily unavailable. The ambient conditions are outside the system limits (→ page 160).                             <ul style="list-style-type: none"> <li>► Drive on. As soon as the ambient conditions are within the system limits, the system will become available again.</li> </ul> </li> </ul>
 --- mph	<ul style="list-style-type: none"> <li>* Cruise control cannot be activated as not all activation conditions are fulfilled.                             <ul style="list-style-type: none"> <li>► Observe the activation conditions for cruise control .</li> </ul> </li> </ul>





Display messages	Possible causes/consequences and ► Solutions
Cruise Control Off	<ul style="list-style-type: none"> <li>* Cruise control has been deactivated. If there is an additional warning tone, cruise control has been deactivated automatically (→ page 158).</li> </ul>
Cruise Control Inoperative	<ul style="list-style-type: none"> <li>* Cruise control is malfunctioning.               <ul style="list-style-type: none"> <li>► Consult a qualified specialist workshop.</li> </ul> </li> </ul>
Parking Pilot Maneuvering Assistance Restricted See Operator's Manual	<ul style="list-style-type: none"> <li>* Parking Pilot and Parking Assist PARKTRONIC are temporarily unavailable. The ambient conditions are outside the system limits (→ page 180). Beware of the entire vehicle surroundings.               <ul style="list-style-type: none"> <li>► As soon as the ambient conditions are within the system limits, the system will become available again.</li> </ul> </li> </ul>
Parking Pilot and PARKTRONIC Inoperative See Operator's Manual	<ul style="list-style-type: none"> <li>* Parking Pilot and Parking Assist PARKTRONIC are malfunctioning.               <ul style="list-style-type: none"> <li>► Stop the vehicle, paying attention to road and traffic conditions, and restart the engine.</li> <li>► If the display message continues to be displayed, consult a qualified specialist workshop.</li> </ul> </li> </ul>
Example: Parking Pilot Parking Canceled	<ul style="list-style-type: none"> <li>* The parking assistance systems of Parking Pilot were interrupted. You have opened the driver's door or touched the steering wheel, for example.               <ul style="list-style-type: none"> <li>► Steer and brake manually.</li> </ul> </li> </ul>

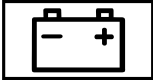
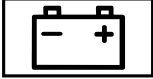

## Engine

Display messages	Possible causes/consequences and ► Solutions
<p>Check Coolant Level See Operator's Manual</p>	<p>* The coolant level is too low.</p> <div style="border: 1px solid black; padding: 5px; margin-bottom: 5px;"> <p><b>!</b> <b>NOTE</b> Engine damage due to insufficient coolant</p> <p>► Avoid long journeys with insufficient coolant.</p> </div> <p>► Add coolant .</p>
<div style="text-align: center; margin-bottom: 10px;">  </div> <p>Coolant Too Hot Stop Vehicle Turn Engine Off</p>	<p>* The coolant is too hot.</p> <p>► Pull over and stop the vehicle safely and switch off the engine, paying attention to road and traffic conditions.</p> <div style="background-color: #f0f0f0; padding: 5px; margin-bottom: 5px;"> <p><b>!</b> <b>WARNING</b> Danger of burns when opening the engine hood</p> <p>If you open the engine hood when the engine has overheated or during a fire in the engine compartment, you could come into contact with hot gases or other escaping operating fluids.</p> <p>► Before opening the engine hood, allow the engine to cool down.</p> <p>► In the event of a fire in the engine compartment, keep the engine hood closed and call the fire service.</p> </div> <p>► Wait until the engine has cooled down.</p> <p>► Make sure that the air supply to the radiator is not obstructed.</p> <p>► Avoiding high loads on the engine, drive on to the nearest qualified specialist workshop. In doing so, ensure that the coolant temperature display remains below 248 °F (120 °C).</p>

Display messages	Possible causes/consequences and ► Solutions
	<ul style="list-style-type: none"> <li>* The fan motor is malfunctioning.               <ul style="list-style-type: none"> <li>► Avoiding high loads on the engine, drive on to the nearest qualified specialist workshop. In doing so, ensure that the coolant temperature display remains below 248 °F (120 °C).</li> </ul> </li> </ul>
 <p data-bbox="195 472 426 495">See Operator's Manual</p>	<ul style="list-style-type: none"> <li>* The battery is not being charged.               <div style="border: 1px solid black; padding: 5px; margin: 10px 0;"> <p><b>!</b> <b>NOTE</b> Possible engine damage if you continue driving</p> <ul style="list-style-type: none"> <li>► Do not continue driving under any circumstances.</li> <li>► Consult a qualified specialist workshop.</li> </ul> </div> <ul style="list-style-type: none"> <li>► Pull over and stop the vehicle safely and switch off the engine, paying attention to road and traffic conditions.</li> <li>► Consult a qualified specialist workshop.</li> </ul> </li> </ul>
 <p data-bbox="195 726 439 768">Start Engine See Operator's Manual</p>	<ul style="list-style-type: none"> <li>* The engine is off and the battery charge level is too low.               <ul style="list-style-type: none"> <li>► Switch off electrical consumers that are not required.</li> <li>► Leave the engine running for a few minutes, or drive for a longer distance.</li> </ul> </li> <li>► The battery charges.</li> </ul>



## 402 Display messages and warning/indicator lamps

Display messages	Possible causes/consequences and ► Solutions
 <p data-bbox="144 342 393 391">Stop Vehicle See Operator's Manual</p>	<p data-bbox="476 249 1271 273">* The battery is no longer being charged and the battery charge level is too low.</p> <div data-bbox="500 291 1646 412" style="border: 1px solid black; padding: 5px;"><p data-bbox="513 301 1092 325"><b>!</b> <b>NOTE</b> Possible engine damage if you continue driving</p><ul data-bbox="513 342 1045 401" style="list-style-type: none"><li data-bbox="513 342 1045 366">► Do not continue driving under any circumstances.</li><li data-bbox="513 373 944 401">► Consult a qualified specialist workshop.</li></ul></div> <ul data-bbox="495 428 1641 547" style="list-style-type: none"><li data-bbox="495 428 1641 477">► Pull over and stop the vehicle safely as soon as possible, paying attention to road and traffic conditions. Do not continue driving under any circumstances.</li><li data-bbox="495 487 750 511">► Switch off the engine.</li><li data-bbox="495 522 925 547">► Consult a qualified specialist workshop.</li></ul>
 <p data-bbox="144 653 412 702">Stop Vehicle Leave Engine Running</p>	<p data-bbox="476 560 842 584">* The battery charge level is too low.</p> <ul data-bbox="495 594 1641 712" style="list-style-type: none"><li data-bbox="495 594 1641 643">► Pull over and stop the vehicle safely as soon as possible, paying attention to road and traffic conditions. Do not continue driving under any circumstances.</li><li data-bbox="495 653 698 677">► Start the engine.</li><li data-bbox="495 687 1153 712">► Wait until the display message disappears before pulling away.</li></ul>

Display messages	Possible causes/consequences and ► Solutions
 <p data-bbox="195 344 450 394">Check Engine Oil At Next Refueling</p>	<p data-bbox="524 249 1088 273">* The engine oil level has dropped to the minimum level.</p> <div data-bbox="565 298 1698 335" style="border: 1px solid black; padding: 5px;"> <p data-bbox="565 303 1273 327">! <b>NOTE</b> Engine damage caused by driving with insufficient engine oil</p> </div> <p data-bbox="565 344 1068 368">► Avoid long journeys with insufficient engine oil.</p> <p data-bbox="543 394 1045 418">► Check the engine oil level when next refueling.</p> <p data-bbox="543 438 837 462">Add engine oil (→ page 303).</p> <p data-bbox="543 471 888 495">Notes on engine oil (→ page 368).</p>
 <p data-bbox="195 606 349 629">Gas Cap Loose</p>	<p data-bbox="524 510 1646 560">* There has been pressure loss in the fuel system. The fuel filler cap is not closed correctly or the fuel system is leaking.</p> <p data-bbox="543 569 818 593">► Close the fuel filler cap.</p> <p data-bbox="543 602 1500 626">► <b>If the fuel filler cap was already properly closed:</b> consult a qualified specialist workshop.</p>
 <p data-bbox="195 738 347 762">Fuel Level Low</p>	<p data-bbox="524 643 1040 667">* The fuel level has dropped into the reserve range.</p> <p data-bbox="543 676 652 700">► Refuel.</p>

## Tires

Display messages	Possible causes/consequences and ► Solutions
<p>Tire Press. Monitor Currently Unavailable</p>	<p>* No signals can be received from the tire pressure sensor due to strong radio signal source interference. The tire pressure monitoring system is temporarily unavailable.</p> <p>► Drive on. The tire pressure monitoring system restarts automatically as soon as the cause has been rectified.</p>
<p></p> <p>Check Tires</p>	<p>* The tire pressure in one or more tires has dropped significantly. The wheel position is displayed.</p> <div style="background-color: #f0f0f0; padding: 5px; border: 1px solid #ccc;"> <p><b>▲ WARNING</b> Risk of an accident due to insufficient tire pressure</p> <p>Tire pressures that are too low pose the following hazards:</p> <ul style="list-style-type: none"> <li>• The tires may burst, especially as the load and vehicle speed increase.</li> <li>• The tires may wear excessively and/or unevenly, which may greatly impair tire traction.</li> <li>• The driving characteristics, as well as steering and braking, may be greatly impaired.</li> </ul> <p>You could then lose control of the vehicle.</p> <ul style="list-style-type: none"> <li>► Observe the recommended tire pressure.</li> <li>► Adjust the tire pressure if necessary.</li> </ul> </div> <p>► Stop the vehicle, paying attention to road and traffic conditions.</p> <p>► Check the tire pressure and the tires.</p>

Display messages	Possible causes/consequences and ► Solutions
 <p data-bbox="195 342 449 391">Please Correct Tire Pressure</p>	<p data-bbox="524 249 1670 301">* The tire pressure is too low in at least one of the tires, or the tire pressure differences between the wheels is too great.</p> <ul style="list-style-type: none"> <li data-bbox="543 311 1068 335">► Check the tire pressure and add air, if necessary.</li> <li data-bbox="543 346 1319 369">► If the tire pressure is correct, restart the tire pressure monitoring system .</li> </ul>
 <p data-bbox="195 500 449 524">Warning Tire Malfunction</p>	<p data-bbox="524 407 1471 430">* The tire pressure in one or more tires has dropped suddenly. The wheel position is displayed.</p> <div data-bbox="561 448 1696 712" style="border: 1px solid gray; padding: 10px;"> <p data-bbox="569 458 1184 482"><b>▲ WARNING</b> Risk of an accident from driving with a flat tire</p> <p data-bbox="561 498 1018 522">Flat tires are dangerous in the following ways:</p> <ul style="list-style-type: none"> <li data-bbox="574 532 994 556">• The tires can overheat and cause a fire.</li> <li data-bbox="574 566 1437 590">• The driving characteristics, as well as steering and braking, may be greatly impaired.</li> </ul> <p data-bbox="561 607 981 630">You could then lose control of the vehicle.</p> <ul style="list-style-type: none"> <li data-bbox="561 641 870 665">► Do not drive with a flat tire.</li> <li data-bbox="561 675 907 699">► Observe the notes on flat tires.</li> </ul> </div> <p data-bbox="543 729 870 753">Notes on flat tires (→ page 314).</p> <ul style="list-style-type: none"> <li data-bbox="543 763 1215 787">► Stop the vehicle, paying attention to road and traffic conditions.</li> <li data-bbox="543 797 735 821">► Check the tires.</li> </ul>

## 406 Display messages and warning/indicator lamps



Display messages	Possible causes/consequences and ► Solutions
Tires Overheated Decrease Speed	<p>* At least one tire is overheated.</p> <div data-bbox="495 291 1648 412"><p><b>▲ WARNING</b> Risk of an accident from driving with overheated tires</p><p>Overheated tires may burst, particularly at high speeds.</p><p>► Reduce speed so that the tires cool down.</p></div> <p>► Reduce speed so that the tires cool down.</p>
Tires Overheated	<p>* At least one tire is overheated. The affected tires are displayed in red. At temperatures close to the limit value, the tires are displayed in yellow.</p> <p>► Drive more slowly.</p>
Tire Press. Monitor Inoperative	<p>* The tire pressure monitoring system is malfunctioning.</p> <div data-bbox="495 605 1648 785"><p><b>▲ WARNING</b> There is a risk of an accident if the tire pressure monitoring system is malfunctioning</p><p>If the tire pressure monitoring system is malfunctioning, it is not able to issue a warning if there is pressure loss in one or more of the tires.</p><p>Underinflated tires may, for example, impair the driving, steering and braking characteristics.</p><p>► Have the tire pressure monitoring system checked at a qualified specialist workshop.</p></div> <p>► Consult a qualified specialist workshop.</p>





Display messages	Possible causes/consequences and ► Solutions
<p>Tire Pressure Monitor Inoperative No Wheel Sensors</p>	<p>* The wheels mounted do not have suitable tire pressure sensors. The tire pressure monitoring system is deactivated.</p> <p>► Mount wheels with suitable tire pressure sensors.</p>
<p> Wheel Sensor(s) Missing</p>	<p>* There is no signal from the tire pressure sensor of one or several tires. The pressure of the affected tire is not displayed.</p> <p>► Have the defective tire pressure sensor replaced at a qualified specialist workshop.</p>

### SmartKey

Display messages	Possible causes/consequences and ► Solutions
<p> Place the Key in the Marked Space See Operator's Manual</p>	<p>* The SmartKey detection function is malfunctioning.</p> <p>► Change the location of the SmartKey in the vehicle.</p> <p>► Start the vehicle with the SmartKey in the stowage compartment .</p>

Display messages	Possible causes/consequences and ► Solutions
 <p>Key Not Detected (red display message)</p>	<p>* The SmartKey cannot be detected and may no longer be in the vehicle. The SmartKey is no longer in the vehicle and you switch off the engine:</p> <ul style="list-style-type: none"> <li>• You can no longer start the engine.</li> <li>• You cannot centrally lock the vehicle.</li> </ul> <p>► Ensure that the SmartKey is in the vehicle.</p> <p>If the SmartKey detection function has a malfunction due to a strong radio signal source:</p> <ul style="list-style-type: none"> <li>► Pull over and stop the vehicle safely as soon as possible, paying attention to road and traffic conditions.</li> <li>► Place the SmartKey in the stowage compartment for starting the engine with the SmartKey .</li> </ul>
 <p>Key Not Detected (white display message)</p>	<p>* The SmartKey is currently undetected.</p> <ul style="list-style-type: none"> <li>► Change the location of the SmartKey in the vehicle.</li> <li>► If the SmartKey is still not detected, start the engine with the SmartKey in the stowage compartment .</li> </ul>
 <p>Don't Forget Your Key</p>	<p>* A warning tone also sounds. This message reminds you to take your SmartKey with you when you leave the vehicle.</p>

Display messages	Possible causes/consequences and ► Solutions
 Replace Key Battery	* The SmartKey battery is discharged. ► Change the battery .
 Obtain a New Key	* The SmartKey needs to be replaced. ► Consult a qualified specialist workshop.



## Vehicle



Display messages	Possible causes/consequences and ► Solutions
Apply Brake to Shift from 'P'	* You have attempted to shift the transmission out of position <b>P</b> and into another transmission position. ► Depress the brake pedal.
To Deselect P or N, Depress Brake and Start Engine	* You have attempted to shift the transmission out of position <b>P</b> or <b>N</b> into another transmission position. ► Depress the brake pedal. ► Start the engine.



## 410 Display messages and warning/indicator lamps

Display messages	Possible causes/consequences and ► Solutions
Driver's Door Open & Transmission Not in P Risk of Vehicle Rolling Away	<ul style="list-style-type: none"> <li>* The driver's door is not fully closed and the transmission is in position <b>R</b>, <b>N</b> or <b>D</b>.               <ul style="list-style-type: none"> <li>► Shift the transmission to position <b>P</b> when you park the vehicle.</li> </ul> </li> </ul>
N Permanently Active Risk of Rolling Away	<ul style="list-style-type: none"> <li>* While the vehicle is rolling or while you are driving, you have shifted the transmission to position <b>N</b>.               <ul style="list-style-type: none"> <li>► Depress the brake pedal to stop and, when the vehicle is stationary, shift the transmission to position <b>P</b>.</li> <li>► To continue your journey, shift the transmission to position <b>D</b>.</li> </ul> </li> </ul>
Only Shift to 'P' when Vehicle is Stationary	<ul style="list-style-type: none"> <li>* The transmission can only be shifted to position <b>P</b> when the vehicle is stationary.</li> </ul>
Service Required Do Not Shift Gears Visit Dealer	<ul style="list-style-type: none"> <li>* The transmission is malfunctioning. The transmission position can no longer be shifted.               <ul style="list-style-type: none"> <li>► When the transmission is in position <b>D</b>, consult a qualified specialist workshop and do not shift the transmission position.</li> <li>► For all other transmission positions, park the vehicle safely.</li> <li>► Consult a qualified specialist workshop or breakdown service.</li> </ul> </li> </ul>
Transmission Malfunction Stop	<ul style="list-style-type: none"> <li>* The transmission is malfunctioning. The transmission shifts to position <b>N</b> automatically.               <ul style="list-style-type: none"> <li>► Pull over and stop the vehicle safely as soon as possible, paying attention to road and traffic conditions.</li> <li>► Switch the transmission to position <b>P</b>.</li> <li>► Consult a qualified specialist workshop.</li> </ul> </li> </ul>
Reversing Not Possible Service Required	<ul style="list-style-type: none"> <li>* The transmission is malfunctioning. Reverse gear can no longer be engaged.               <ul style="list-style-type: none"> <li>► Consult a qualified specialist workshop.</li> </ul> </li> </ul>

Display messages	Possible causes/consequences and ► Solutions
<p>Stop Vehicle Leave Engine Running Wait Transmission Cooling</p>	<p>* The transmission has overheated. Pulling away can be temporarily impaired or not possible.</p> <ul style="list-style-type: none"> <li>► Pull over and stop the vehicle safely as soon as possible, paying attention to road and traffic conditions. Do not continue driving under any circumstances.</li> <li>► Start the engine.</li> <li>► Wait until the display message disappears before pulling away.</li> </ul>
<p>Auxiliary Battery Malfunction</p>	<p>* The auxiliary battery for the transmission is no longer being charged.</p> <ul style="list-style-type: none"> <li>► Consult a qualified specialist workshop.</li> <li>► Until then, manually set the transmission to position <b>P</b> before you switch off the engine.</li> <li>► Before leaving the vehicle, apply the electric parking brake.</li> </ul>
<p> Steering Malfunction Drive Carefully Service Required</p>	<p>* The power assistance of the steering is malfunctioning. You may need to use more force to steer.</p> <ul style="list-style-type: none"> <li>► Drive on carefully.</li> <li>► Consult a qualified specialist workshop.</li> </ul>



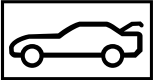

Display messages	Possible causes/consequences and ► Solutions
 <p data-bbox="144 342 410 417">Steering Malfunction Stop Immediately See Operator's Manual</p>	<p data-bbox="476 249 1249 273">* The steering is malfunctioning. Steering capability is considerably impaired.</p> <div data-bbox="500 291 1646 470" style="border: 1px solid black; padding: 5px;"><p data-bbox="513 301 1153 325">▲ <b>WARNING</b> Risk of accident if steering capability is impaired</p><p data-bbox="513 339 1411 363">If the steering does not function as intended, the vehicle's operating safety is jeopardized.</p><ul data-bbox="513 373 1585 459" style="list-style-type: none"><li data-bbox="513 373 1585 428">▶ Pull over and stop the vehicle safely as soon as possible, paying attention to road and traffic conditions. Do not continue driving under any circumstances.</li><li data-bbox="513 436 944 459">▶ Consult a qualified specialist workshop.</li></ul></div> <ul data-bbox="495 487 1641 570" style="list-style-type: none"><li data-bbox="495 487 1641 542">▶ Pull over and stop the vehicle safely as soon as possible, paying attention to road and traffic conditions. Do not continue driving under any circumstances.</li><li data-bbox="495 550 925 570">▶ Consult a qualified specialist workshop.</li></ul>
 <p data-bbox="144 681 395 756">Steering Malfunction Increased Physical Effort See Operator's Manual</p>	<p data-bbox="476 588 1045 612">* The power assistance of the steering is malfunctioning.</p> <div data-bbox="500 629 1646 781" style="border: 1px solid black; padding: 5px;"><p data-bbox="513 640 1245 664">▲ <b>WARNING</b> Risk of an accident due to altered steering characteristics</p><p data-bbox="513 678 1585 702">If the power assistance of the steering fails partially or completely, you will need to use more force to steer.</p><ul data-bbox="513 712 1147 770" style="list-style-type: none"><li data-bbox="513 712 999 736">▶ If safe steering is possible, drive on carefully.</li><li data-bbox="513 746 1147 770">▶ Visit or consult a qualified specialist workshop immediately.</li></ul></div> <ul data-bbox="495 798 1129 857" style="list-style-type: none"><li data-bbox="495 798 981 822">▶ If safe steering is possible, drive on carefully.</li><li data-bbox="495 832 1129 857">▶ Visit or consult a qualified specialist workshop immediately.</li></ul>

Display messages	Possible causes/consequences and ► Solutions
<p>Active Hood Malfunction See Operator's Manual</p>	<ul style="list-style-type: none"> <li>* The active hood (pedestrian protection) is malfunctioning or inoperative after having already been triggered.                             <ul style="list-style-type: none"> <li>► Consult a qualified specialist workshop.</li> </ul> </li> </ul>
	<ul style="list-style-type: none"> <li>* The engine hood is open.                             <div style="border: 1px solid gray; padding: 5px; margin-top: 10px;"> <p><b>⚠ WARNING</b> Risk of accident if the engine hood is unlatched while driving</p> <p>An unlocked engine hood may open up when the vehicle is in motion and block your view.</p> <ul style="list-style-type: none"> <li>► Never unlatch the engine hood while driving.</li> <li>► Before every trip, ensure that the engine hood is latched.</li> </ul> </div> <ul style="list-style-type: none"> <li>► Pull over and stop the vehicle safely as soon as possible.</li> <li>► Close the hood.</li> </ul> </li> </ul>
	<ul style="list-style-type: none"> <li>* At least one door is open.                             <ul style="list-style-type: none"> <li>► Close all doors.</li> </ul> </li> </ul>



Display messages	Possible causes/consequences and ► Solutions
	<p>* The trunk lid is open.</p> <div style="border: 1px solid gray; padding: 5px; margin: 5px 0;"> <p><b>▲ WARNING</b> Risk of exhaust gas poisoning</p> <p>Combustion engines emit poisonous exhaust gases such as carbon monoxide. Exhaust gases can enter the vehicle interior if the trunk lid is open when the engine is running, especially if the vehicle is in motion.</p> <ul style="list-style-type: none"> <li>▶ Always switch off the engine before opening the trunk lid.</li> <li>▶ Never drive with the trunk lid open.</li> </ul> </div> <p>► Close the trunk lid.</p>
 <p>Example: Rear Left Backrest Not Latched</p>	<p>* The corresponding seat backrest of the rear bench seat is not engaged.</p> <p>► Fold the corresponding seat backrest back until it engages.</p>
 <p>Check Washer Fluid</p>	<p>* The washer fluid level in the washer fluid reservoir has dropped below the minimum.</p> <p>► Add washer fluid .</p>



## Lights

Display messages	Possible causes/consequences and ► Solutions
 <p data-bbox="195 384 445 430">Example: Check Left Low Beam</p>	<ul style="list-style-type: none"> <li data-bbox="519 291 907 313">* The corresponding bulb is defective.               <ul style="list-style-type: none"> <li data-bbox="543 325 975 348">► Consult a qualified specialist workshop.</li> <li data-bbox="543 359 1702 407">ⓘ LED light bulbs: the display message for the corresponding lamp only appears when all the light-emitting diodes in the lamp have failed.</li> </ul> </li> </ul>
 <p data-bbox="195 542 417 565">Switch On Headlamps</p>	<ul style="list-style-type: none"> <li data-bbox="519 448 1082 506">* You are driving without low beam.               <ul style="list-style-type: none"> <li data-bbox="543 482 1082 506">► Turn the light switch to the  or <b>AUTO</b> position.</li> </ul> </li> </ul>
 <p data-bbox="195 672 371 695">Switch Off Lights</p>	<ul style="list-style-type: none"> <li data-bbox="519 578 1166 636">* You are leaving the vehicle and the lights are still switched on.               <ul style="list-style-type: none"> <li data-bbox="543 612 999 636">► Turn the light switch to the <b>AUTO</b> position.</li> </ul> </li> </ul>
 <p data-bbox="195 801 476 848">Auto Lamp Function Inoperative</p>	<ul style="list-style-type: none"> <li data-bbox="519 707 975 765">* The light sensor is malfunctioning.               <ul style="list-style-type: none"> <li data-bbox="543 741 975 765">► Consult a qualified specialist workshop.</li> </ul> </li> </ul>

Display messages	Possible causes/consequences and ► Solutions
<p>Adaptive Highbeam Assist Camera View Restricted See Operator's Manual</p>	<p>* The camera view is reduced. Possible causes are:</p> <ul style="list-style-type: none"> <li>• Dirt on the windshield in the camera's field of vision</li> <li>• Heavy rain, snow or fog</li> </ul> <p>Driving systems and driving safety systems may be malfunctioning or temporarily unavailable. When the causes no longer apply, driving systems and driving safety systems are available again. If the display message does not disappear:</p> <ul style="list-style-type: none"> <li>► Pull over and stop the vehicle safely as soon as possible, paying attention to road and traffic conditions.</li> <li>► Clean the windshield.</li> </ul>
<p>Adaptive Highbeam Assist Currently Unavailable See Operator's Manual</p>	<p>* Adaptive Highbeam Assist is temporarily unavailable. The system limits have been reached (→ page 113).</p> <ul style="list-style-type: none"> <li>► Drive on. When the causes no longer apply, the system will be available again. The <a href="#">Adaptive Highbeam Assist Now Available</a> display message appears.</li> </ul>
<p>Adaptive Highbeam Assist Inoperative</p>	<p>* Adaptive Highbeam Assist is malfunctioning.</p> <ul style="list-style-type: none"> <li>► Consult a qualified specialist workshop.</li> </ul>

Display messages	Possible causes/consequences and ► Solutions
 <p data-bbox="195 344 469 391">Active Headlamps Inoperative</p>	<ul style="list-style-type: none"> <li data-bbox="519 252 968 273">* The active light function is malfunctioning.</li> <li data-bbox="543 285 975 306">► Consult a qualified specialist workshop.</li> </ul>
 <p data-bbox="195 502 436 549">Malfunction See Operator's Manual</p>	<ul style="list-style-type: none"> <li data-bbox="519 410 925 430">* The exterior lighting is malfunctioning.</li> <li data-bbox="543 443 975 464">► Consult a qualified specialist workshop.</li> </ul>

## Warning and indicator lamps

### Overview of warning and indicator lamps

Some systems perform a self-test when the ignition is switched on. Some warning and indicator lamps may briefly light up or flash. This behavior is non-critical. These warning and indicator lamps only indicate a malfunction if they light up or flash after the engine is started or during a journey.

### Instrument display (standard)

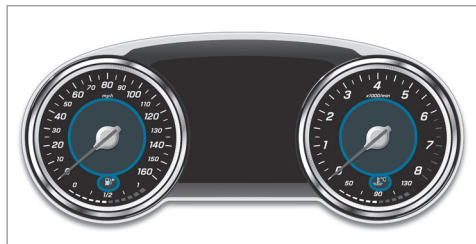

### Instrument display in the Widescreen Cockpit







### Progressive setting (Widescreen Cockpit)



If you select the progressive display setting in vehicles with a Widescreen Cockpit, the position of the indicator lamps in the instrument display changes.

#### Indicator and warning lamps:

-  Low beam (→ page 111)
-  Parking lights (→ page 111)
-  High beam (→ page 112)
-  Turn signal light (→ page 112)
-  Rear fog light (→ page 111)



Seat belt is not fastened  
(→ page 427)



USA: brakes (red) (→ page 420)



Canada: brakes (red) (→ page 420)



ABS malfunction (→ page 420)



ESP® (→ page 420)



ESP® OFF (→ page 420)



USA: electric parking brake applied  
(red) (→ page 420)



Canada: electric parking brake  
applied (red) (→ page 420)



Electric parking brake (yellow)  
(→ page 420)



Steering assistance malfunction  
(→ page 429)



Electrical malfunction (→ page 430)



Restraint system (→ page 420)



Engine diagnosis (→ page 430)



Fuel reserve with fuel filler cap loca-  
tion indicator (→ page 430)



Coolant too hot/cold (→ page 430)





Distance warning (→ page 428)



Tire pressure monitoring system  
(→ page 433)

## Safety systems

Warning/indicator lamp	Possible causes/consequences and ► Solutions
 <p>Brake warning lamp (USA)</p>	<p>The red brake system warning lamp is lit while the engine is running.</p> <p>Possible causes are:</p> <ul style="list-style-type: none"> <li>• The brake force boosting is malfunctioning and the braking characteristics may be affected.</li> <li>• There is not enough brake fluid in the brake fluid reservoir.</li> </ul>
 <p>Brakes warning lamp (Canada)</p>	<p><b>▲ WARNING</b> There is a risk of an accident if brake force boosting is malfunctioning</p> <p>If brake force boosting is malfunctioning, the wheels may lock when braking. Braking characteristics may be impaired. The braking distance in an emergency braking situation can increase.</p> <ul style="list-style-type: none"> <li>► Pull over and stop the vehicle safely as soon as possible, paying attention to road and traffic conditions. Do not continue driving under any circumstances.</li> <li>► Consult a qualified specialist workshop.</li> </ul>
	<p><b>▲ WARNING</b> Risk of an accident due to low brake fluid level</p> <p>If the brake fluid level is too low, the braking effect and the braking characteristics may be impaired.</p> <ul style="list-style-type: none"> <li>► Pull over and stop the vehicle safely as soon as possible, paying attention to road and traffic conditions. Do not continue driving under any circumstances.</li> <li>► Consult a qualified specialist workshop. Do not add brake fluid.</li> </ul>

Warning/indicator lamp	Possible causes/consequences and ► Solutions
	<ul style="list-style-type: none"><li data-bbox="508 241 1709 293">► Pull over and stop the vehicle safely as soon as possible, paying attention to road and traffic conditions. Do not continue driving under any circumstances.</li><li data-bbox="508 298 1709 329">► Observe the messages in the multifunction display.</li><li data-bbox="508 334 1709 365">► Consult a qualified specialist workshop.</li></ul> <p data-bbox="508 365 1709 417"><b>USA only:</b> if an additional display message appears with the  symbol in the multifunction display, the brake linings have reached their wear limit.</p> <ul style="list-style-type: none"><li data-bbox="508 422 1709 448">► Visit a qualified specialist workshop.</li></ul>

Warning/indicator lamp



ABS warning lamp

Possible causes/consequences and ► Solutions

The yellow ABS warning lamp is lit while the engine is running.  
ABS is malfunctioning.  
If there is an additional warning tone, EBD is malfunctioning.  
Other driving and driving safety systems may also be faulty.

**▲ WARNING** There is risk of skidding if EBD or ABS is malfunctioning



If EBD or ABS is malfunctioning, the wheels could lock when braking

The steering capability and braking characteristics are thus severely impaired. The braking distance in an emergency braking situation can increase. In addition, other driving safety systems are switched off.

- Drive on carefully.
- Have the brake system checked immediately at a qualified specialist workshop.

- Drive on carefully.
- Observe the messages in the multifunction display.
- Visit a qualified specialist workshop.





Warning/indicator lamp	Possible causes/consequences and ► Solutions
 <p data-bbox="195 344 454 396">ESP® warning lamp lights up</p>	<p data-bbox="504 251 1138 350">The yellow ESP® warning lamp is lit while the engine is running. ESP® is malfunctioning. Other driving and driving safety systems may also be malfunctioning.</p> <div data-bbox="504 365 1700 552" style="border: 1px solid gray; padding: 5px;"> <p data-bbox="513 376 1095 407">▲ <b>WARNING</b> Risk of skidding if ESP is malfunctioning®</p> <p data-bbox="513 417 1665 469">If ESP® is malfunctioning, ESP® cannot carry out vehicle stabilization. In addition, other driving safety systems are switched off.</p> <ul style="list-style-type: none"> <li data-bbox="522 479 741 505">▶ Drive on carefully.</li> <li data-bbox="522 515 1101 541">▶ Have ESP® checked at a qualified specialist workshop.</li> </ul> </div> <ul style="list-style-type: none"> <li data-bbox="504 572 722 598">▶ Drive on carefully.</li> <li data-bbox="504 609 1049 635">▶ Observe the messages in the multifunction display.</li> <li data-bbox="504 645 938 671">▶ Consult a qualified specialist workshop.</li> </ul>
 <p data-bbox="195 771 469 792">ESP® warning lamp flashes</p>	<p data-bbox="504 681 1190 743">The yellow ESP® warning lamp flashes while the vehicle is in motion. ESP® is intervening (→ page 150).</p> <ul style="list-style-type: none"> <li data-bbox="504 754 1180 780">▶ Adapt your driving style to suit the road and weather conditions.</li> </ul>



## 424 Display messages and warning/indicator lamps

Warning/indicator lamp	Possible causes/consequences and ► Solutions
 <p>ESP® OFF warning lamp</p>	<p>The yellow ESP® OFF warning lamp is lit while the engine is running. ESP® is deactivated.</p> <p><b>▲ WARNING</b> Risk of skidding when driving with ESP® deactivated</p> <p>If ESP® is deactivated, ESP® cannot carry out vehicle stabilization. The availability of further driving safety systems is also limited.</p> <ul style="list-style-type: none"><li>► Drive on carefully.</li><li>► Only deactivate ESP® for as long as the situation requires.</li></ul> <p>If ESP® cannot be activated, ESP® is malfunctioning.</p> <ul style="list-style-type: none"><li>► Have ESP® checked immediately at a qualified specialist workshop.</li></ul> <p>► Observe the notes on deactivating ESP® .</p>

Warning/indicator lamp	Possible causes/consequences and ► Solutions
 <p data-bbox="195 342 452 394">Restrained system warning lamp</p>	<p data-bbox="504 249 1215 308">The red restraint system warning lamp is lit while the engine is running. The restraint system is malfunctioning.</p> <div data-bbox="504 325 1703 498" style="border: 1px solid gray; padding: 5px;"><p data-bbox="513 335 1393 363"><b>▲ WARNING</b> Risk of injury or fatal injury due to a malfunction in the restraint system</p><p data-bbox="513 376 1683 453">If the restraint system is malfunctioning, restraint system components may be triggered unintentionally or might not be triggered at all in the event of an accident. This may affect the Emergency Tensioning Device or airbag, for example.</p><p data-bbox="513 464 1507 487">► Have the restraint system checked and repaired immediately at a qualified specialist workshop.</p></div> <ul data-bbox="504 515 1064 606" style="list-style-type: none"><li data-bbox="504 515 717 539">► Drive on carefully.</li><li data-bbox="504 550 1049 573">► Observe the messages in the multifunction display.</li><li data-bbox="504 584 1064 608">► Consult a qualified specialist workshop immediately.</li></ul>

Warning/indicator lamp	Possible causes/consequences and ► Solutions
<p data-bbox="155 252 310 332"></p> <p data-bbox="144 342 426 418">Red indicator lamp, electric parking brake applied (USA only)</p> <p data-bbox="155 425 310 505"></p> <p data-bbox="144 515 426 591">Red indicator lamp, electric parking brake applied (Canada only)</p> <p data-bbox="155 598 310 678"></p> <p data-bbox="144 688 426 764">Yellow electric parking brake indicator lamp is malfunctioning</p>	<p data-bbox="452 249 1637 298">The red electric parking brake indicator lamp flashes or is lit. The yellow indicator lamp is also lit if the electric parking brake malfunctions.</p> <ul data-bbox="452 308 999 335" style="list-style-type: none"><li data-bbox="452 308 999 335">► Observe the messages in the multifunction display.</li></ul>

## Seat belts

Warning/indicator lamp	Possible causes/consequences and ► Solutions
 <p data-bbox="194 383 434 429">Seat belt warning lamp lights up</p>	<p data-bbox="508 290 1302 315">After starting the engine, the red seat belt warning lamp lights up for 6 seconds.</p> <p data-bbox="508 326 988 352">In addition, an acoustic warning tone may sound.</p> <p data-bbox="508 357 1422 383">The seat belt warning lamp reminds the driver and front passenger to fasten their seat belts.</p> <ul style="list-style-type: none"> <li data-bbox="508 393 766 419">► Fasten your seat belt .</li> </ul> <p data-bbox="508 435 1386 461">If you have placed objects on the front passenger seat, the warning lamp may remain lit.</p>
 <p data-bbox="194 564 434 611">Seat belt warning lamp flashes</p>	<p data-bbox="508 471 1302 497">The red seat belt warning lamp flashes and an intermittent warning tone sounds.</p> <p data-bbox="508 502 1413 528">The driver or front passenger has not fastened their seat belt while the vehicle is in motion.</p> <ul style="list-style-type: none"> <li data-bbox="508 538 766 564">► Fasten your seat belt .</li> <li data-bbox="508 569 970 595">There are objects on the front passenger seat.</li> <li data-bbox="508 600 1044 626">► Remove the objects from the front passenger seat.</li> </ul>

### Driving systems

Warning/indicator lamp	Possible causes/consequences and ► Solutions
 <p data-bbox="144 381 376 408">Distance warning lamp</p>	<p data-bbox="452 288 1156 314">The red distance warning lamp lights up while the vehicle is in motion.</p> <p data-bbox="452 322 1156 349">The distance to the vehicle in front is too small for the speed selected.</p> <p data-bbox="452 356 1360 383">If there is an additional warning tone, you are approaching an obstacle at too high a speed.</p> <ul data-bbox="452 390 835 451" style="list-style-type: none"><li data-bbox="452 390 835 417">► Be prepared to brake immediately.</li><li data-bbox="452 420 835 451">► Increase the distance.</li></ul> <p data-bbox="452 458 796 490">Active Brake Assist (→ page 153).</p>

## Vehicle

Warning/indicator lamp	Possible causes/consequences and ▶ Solutions
 <p data-bbox="194 383 425 435">Power steering system warning lamp</p>	<p data-bbox="508 290 1284 352">The red power steering system warning lamp is lit while the engine is running. The power steering assistance or the steering itself is malfunctioning.</p> <div data-bbox="508 367 1690 543"><p data-bbox="517 372 1164 404"><b>▲ WARNING</b> Risk of accident if steering capability is impaired</p><p data-bbox="517 414 1422 445">If the steering does not function as intended, the vehicle's operating safety is jeopardized.</p><ul data-bbox="517 450 1635 538" style="list-style-type: none"><li data-bbox="517 450 1635 502">▶ Pull over and stop the vehicle safely as soon as possible, paying attention to road and traffic conditions. Do not continue driving under any circumstances.</li><li data-bbox="517 507 951 538">▶ Consult a qualified specialist workshop.</li></ul></div> <p data-bbox="508 559 1053 590">▶ Observe the messages in the multifunction display.</p>

## Engine

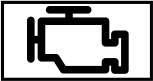
Warning/indicator lamp	Possible causes/consequences and ► Solutions
 <p data-bbox="144 384 402 433">Engine diagnosis warning lamp</p>	<p data-bbox="454 291 1203 314">The yellow engine diagnosis warning lamp is lit while the engine is running.</p> <p data-bbox="454 325 1264 349">A malfunction has occurred in the engine, the exhaust system or the fuel system.</p> <p data-bbox="454 359 1522 383">The emissions limit values may be exceeded and the engine may be running in emergency operation mode.</p> <p data-bbox="454 393 1641 442">In some states, legal requirements stipulate that you must immediately consult a qualified specialist workshop as soon as the yellow engine diagnosis warning lamp lights up.</p> <ul data-bbox="454 452 1289 476" style="list-style-type: none"><li>► Have the vehicle checked as soon as possible at a qualified specialist workshop.</li></ul>



**Warning/indicator lamp**

Coolant warning lamp

**Possible causes/consequences and ► Solutions**

The red coolant warning lamp is lit while the engine is running.

Possible causes are:

- The temperature sensor is malfunctioning
- The coolant level is too low
- The air supply to the radiator is obstructed
- The radiator fan is faulty

If there is an additional warning tone, the coolant temperature has exceeded 248 °F (120 °C).

**▲ WARNING** Danger of burns when opening the engine hood

If you open the engine hood when the engine has overheated or during a fire in the engine compartment, you could come into contact with hot gases or other escaping operating fluids.



- Before opening the engine hood, allow the engine to cool down.
- In the event of a fire in the engine compartment, keep the engine hood closed and call the fire service.

- Pull over and stop the vehicle safely and switch off the engine, paying attention to road and traffic conditions. Do not continue driving under any circumstances.
- Observe the messages in the multifunction display.

If the coolant temperature display is at the lower end of the temperature scale:

- Consult a qualified specialist workshop.

## 432 Display messages and warning/indicator lamps

Warning/indicator lamp	Possible causes/consequences and ► Solutions
	<p>Otherwise:</p> <ul style="list-style-type: none"><li>► Leave the vehicle and keep a safe distance from the vehicle until the engine has cooled down.</li><li>► Check the coolant level .</li><li>► Make sure that the air supply to the radiator is not obstructed.</li><li>► Avoiding high loads on the engine, drive on to the nearest qualified specialist workshop. In doing so, ensure that the coolant temperature display remains below 248 °F (120 °C).</li></ul>
 <p>Electrical malfunction warning lamp</p>	<p>The red electrical malfunction warning lamp is lit. There is a malfunction in the electrics.</p> <ul style="list-style-type: none"><li>► Observe the messages in the multifunction display.</li></ul>
 <p>Fuel reserve warning lamp</p>	<p>The yellow fuel reserve warning lamp lights up while driving. There has been pressure loss in the fuel system. The fuel filler cap is not closed correctly or the fuel system is leaking.</p> <ul style="list-style-type: none"><li>► Close the fuel filler cap.</li><li>► <b>If the fuel filler cap was already properly closed:</b> consult a qualified specialist workshop.</li></ul>
 <p>Fuel reserve warning lamp</p>	<p>The yellow fuel reserve warning lamp is lit while the engine is running. The fuel level has dropped into the reserve range.</p> <ul style="list-style-type: none"><li>► Refuel.</li></ul>

## Tires

Warning/indicator lamp	Possible causes/consequences and ► Solutions
 <p data-bbox="194 383 471 461">Tire pressure monitoring system warning lamp lights up</p>	<p data-bbox="508 290 1450 347">The yellow tire pressure monitoring system warning lamp (pressure loss/malfunction) is lit. The tire pressure monitoring system has detected tire pressure loss in at least one of the tires.</p> <div data-bbox="508 367 1690 409" style="background-color: #f0f0f0; padding: 5px;"> <p data-bbox="517 372 1191 398">▲ <b>WARNING</b> Risk of an accident due to insufficient tire pressure</p> </div> <p data-bbox="517 414 1108 440">Tire pressures that are too low pose the following hazards:</p> <ul data-bbox="526 450 1432 543" style="list-style-type: none"> <li>• The tires may burst, especially as the load and vehicle speed increase.</li> <li>• The tires may wear excessively and/or unevenly, which may greatly impair tire traction.</li> <li>• The driving characteristics, as well as steering and braking, may be greatly impaired.</li> </ul> <p data-bbox="517 559 942 585">You could then lose control of the vehicle.</p> <ul data-bbox="517 595 970 657" style="list-style-type: none"> <li>► Observe the recommended tire pressure.</li> <li>► Adjust the tire pressure if necessary.</li> </ul> <ul data-bbox="508 678 1182 740" style="list-style-type: none"> <li>► Stop the vehicle, paying attention to road and traffic conditions.</li> <li>► Check the tire pressure and the tires.</li> </ul>

#### 434 Display messages and warning/indicator lamps

##### Warning/indicator lamp



Tire pressure monitoring system warning lamp flashes

##### Possible causes/consequences and ► Solutions

The yellow tire pressure monitoring system warning lamp (pressure loss/malfunction) flashes for approximately one minute and then remains lit.

The tire pressure monitoring system is malfunctioning.

**▲ WARNING** There is a risk of an accident if the tire pressure monitoring system is malfunctioning

If the tire pressure monitoring system is malfunctioning, it is not able to issue a warning if there is pressure loss in one or more of the tires.

Underinflated tires may, for example, impair the driving, steering and braking characteristics.

► Have the tire pressure monitoring system checked at a qualified specialist workshop.

► Consult a qualified specialist workshop.

## 1, 2, 3 ...

**12 V battery**

Charging .....	322
Notes .....	320
Starting assistance .....	322

**360° camera** ..... 178

Care .....	309
Function .....	178
Selecting a view .....	180

**A****A/C function**

Activating/deactivating (control panel) .....	123
---	-----

**ABS (Anti-lock Braking System)** ..... 149**Acceleration**

see Kickdown

**Access data**

Editing .....	271
Setting .....	270

**Acoustic locking verification signal**

Switching on/off .....	56
------------------------	----

**Active Blind Spot Assist**

Brake application .....	189
Function/notes .....	189
System limitations .....	189

**Active Brake Assist**

Driving safety system .....	153
Setting .....	157

**Active Emergency Stop Assist** ..... 167**Active hood (pedestrian protection)** ..... 300

Method of operation .....	300
Resetting .....	300

**Active Lane Change Assist** ..... 167**Active Lane Keeping Assist**

Function .....	191
Sensitivity .....	194
Setting the sensitivity .....	194
Switching on/off .....	193
System borders .....	191

**Adaptive Highbeam Assist**

Function .....	113
Switching on/off .....	114

**Adaptive speed control**

see Driving system

**Added substances (fuel)**

see Fuel

**Additives** ..... 368

Engine oil .....	368
------------------	-----

**Additives (engine oil)**

see Additives

**Address book**

see Contacts

**Adjusting the balance/fader**

Burmester® high-end 3D surround sound system .....	298
Burmester® surround sound system ....	297

**Adjusting the sound focus**

Burmester® surround sound system ....	297
---------------------------------------	-----

**Adjusting the sound optimization**

Burmester® high-end 3D surround sound system .....	298
--	-----

**Adjusting treble, mid and bass**

Burmester® high-end 3D surround sound system .....	298
Burmester® surround sound system ....	297

**Air bag**

Activation .....	31
------------------	----

- Belt air bag ..... 35
- AIR BODY CONTROL** ..... 170
  - Setting ..... 171
  - Suspension ..... 170
- Air conditioning system**
  - see Climate control
- Air distribution** ..... 123
- Air freshener system**
  - see Fragrance system
- Air suspension**
  - see AIR BODY CONTROL
- Air vents** ..... 126
  - Adjusting (front) ..... 126
  - Adjusting (rear passenger compartment) ..... 127
  - Glove box ..... 127
- Air vents**
  - see Air vents
- Air-recirculation mode** ..... 124
- Airbag**
  - Front airbag ..... 37
  - Installation locations ..... 37
  - Knee airbag ..... 37
  - Overview ..... 37
  - Protection ..... 37
  - Reduced protection ..... 39
  - Side airbag ..... 37
  - Window airbag ..... 37
- Airflow** ..... 123
- AIRPANEL (Care)** ..... 309
- Alarm**
  - see Panic alarm
- Alarm system**
  - see Anti-theft protection
- Alternative route**
  - see Route
- Ambient lighting** ..... 116
- Android Auto™**
  - Connecting a mobile phone ..... 265
  - Ending ..... 266
  - Overview ..... 265
  - Sound settings ..... 266
  - Transferred vehicle data ..... 266
- Anti-theft protection** ..... 79
  - ATA (Anti-Theft Alarm system) ..... 79
  - Deactivating the alarm (ATA) ..... 80
- Immobilizer ..... 79
- Apple CarPlay™**
  - Connecting an iPhone® ..... 264
  - Ending ..... 265
  - Overview ..... 264
  - Sound settings ..... 265
  - Transferred vehicle data ..... 266
- Ashtray**
  - Front center console ..... 105
  - Rear passenger compartment ..... 105
- Assistance graphic**
  - Menu (on-board computer) ..... 199
- ASSYST PLUS** ..... 299
  - Battery disconnection periods ..... 300
  - Displaying the service due date ..... 299
  - Regular service work ..... 299
  - Special service requirements ..... 299
- ASSYST PLUS service interval display** ... 299
- ATA (Anti-Theft Alarm system)**
  - Deactivating the alarm ..... 80
  - Function ..... 79
- ATTENTION ASSIST**
  - Function ..... 185





- Switching on/off ..... 186
  - System limitations ..... 185
  - Attention assistant**
    - see Driving system
  - Audio mode**
    - Activating media mode ..... 277
    - Connecting USB devices ..... 280
    - Copyright ..... 277
    - Information ..... 276
    - Inserting/removing SD memory card  
..... 277
    - Media search ..... 283
    - Overview ..... 279
    - Pause and playback function ..... 280
    - Selecting a track ..... 280
    - Selecting playback options ..... 280
    - Track list ..... 280
  - Authorized Mercedes-Benz service center**
    - see Qualified specialist workshop
  - Automatic car wash (care)** ..... 306
  - Automatic distance control**
    - see Driving system
  - Automatic driving lights** ..... 112
  - Automatic engine start (ECO start/  
stop function)** ..... 133
  - Automatic engine stop (ECO start/  
stop function)** ..... 133
  - Automatic front passenger air bag  
shutoff**
    - see Front passenger air bag shutoff
  - Automatic mirror folding function**
    - Switching on/off ..... 121
  - Automatic transmission**
    - DIRECT SELECT selector lever ..... 136
    - Drive program display ..... 135
    - Drive programs ..... 135
    - DYNAMIC SELECT switch ..... 135
    - Kickdown ..... 139
    - Transmission position display ..... 136
    - Transmission positions ..... 136
- B**
- BAS (Brake Assist System)**
    - Driving safety system ..... 150
  - Battery**
    - Key ..... 57
  - Battery (12 V)**
    - Charging ..... 322
    - Notes ..... 320
    - Starting assistance ..... 322
  - Belt**
    - Adjusting the height ..... 35
    - Fastening ..... 35
    - Releasing ..... 36
  - Belt air bag**
    - Activation ..... 31
    - Function/notes ..... 35
  - Blind Spot Assist**
    - Activating/deactivating ..... 191
    - Function/notes ..... 189
    - System limitations ..... 189
  - Blower**
    - see Climate control
  - Bluetooth®**
    - Activating/deactivating ..... 228
    - Settings ..... 228
  - Bluetooth® Audio**
    - Activating ..... 287
    - De-authorizing (de-registering) the  
device ..... 289























- Information ..... 286
  - Overview ..... 288
  - Searching for and authorizing the device ..... 286
  - Switching device via NFC ..... 287
  - Bluetooth® profile**
    - Switching (DUN/PAN) ..... 271
  - Brake fluid**
    - Notes ..... 369
  - Brakes**
    - HOLD function ..... 168
  - Breakdown**
    - Changing a wheel ..... 356
    - Flat tire ..... 314
    - Overview of the help functions ..... 16
    - Roadside Assistance ..... 21
    - Tow starting ..... 328
    - Towing away ..... 325
    - Transporting the vehicle ..... 327
  - Burmester® high-end 3D surround sound system**
    - Adjusting the balance/fader ..... 298
    - Adjusting the sound optimization ..... 298
    - Adjusting treble, mid and bass ..... 298
    - Calls up the sound menu ..... 297
    - Information ..... 297
    - Setting the sound profile ..... 298
  - Burmester® surround sound system**
    - Adjusting the balance/fader ..... 297
    - Adjusting the sound focus ..... 297
    - Adjusting treble, mid and bass ..... 297
    - Calls up the sound menu ..... 297
    - Information ..... 296
    - Switching the surround sound on/off ..... 297
  - Buttons**
    - Steering wheel ..... 196
- C**
- California**
    - Important information for private customers and lessees ..... 22
  - Call list**
    - Making a call ..... 262
    - Options in the call list ..... 262
    - Overview ..... 262
  - Calls**
    - Accepting ..... 259
    - Calls with several participants ..... 259
    - Declining ..... 259
    - Ending a call ..... 259
    - Incoming call during an existing call .... 260
    - Making ..... 259
  - Calls up the sound menu**
    - Burmester® high-end 3D surround sound system ..... 297
    - Burmester® surround sound system .... 297
  - Camera**
    - Assigning as a favorite ..... 180
  - Car key**
    - see Key
  - Car wash**
    - see Care
  - Care** ..... 311
    - AIRPANEL ..... 309
    - Car wash ..... 306
    - Carpet ..... 311
    - Display ..... 311
    - EASY-PACK trunk box ..... 311
    - Exterior lighting ..... 309
    - Genuine wood/trim elements ..... 311
    - Matt finish ..... 308



























- Paint ..... 308  
 Plastic trim ..... 311  
 Power washer ..... 307  
 Reversing camera/360° Camera ..... 309  
 Roof lining ..... 311  
 Seat belts ..... 311  
 Seat cover ..... 311  
 Sensors ..... 309  
 Tailpipes ..... 309  
 Trailer hitch ..... 309  
 Washing by hand ..... 307  
 Wheels/rims ..... 309  
 Windows ..... 309  
 Wiper blades ..... 309
- Carpet (Care)** ..... 311  
**Change of address** ..... 21  
**Change of ownership** ..... 21  
**Changing a wheel** ..... 356  
**Changing hub caps** ..... 356  
**Charging**  
   12 V battery ..... 322  
**Child safety lock**  
   Rear door ..... 52
- Rear side windows ..... 54  
**Child seat**  
   Front passenger seat (notes) ..... 51  
   Front passenger seat (rearward-facing/forward-facing) ..... 52  
   LATCH-type (ISOFIX) (installing) ..... 49  
   LATCH-type (ISOFIX) (notes) ..... 48  
   Top Tether ..... 50  
**Child seat safety feature** ..... 47  
**Children**  
   Child seat safety feature ..... 47  
   Restraint systems ..... 45  
**Chock**  
   Storage location ..... 355  
**Cigarette lighter** ..... 105  
**Cleaning**  
   see Care  
**Climate control** ..... 123  
   Activating/deactivating ..... 123  
   Activating/deactivating the A/C function (control panel) ..... 123  
   Activating/deactivating the synchronization function (control panel) ..... 124
- Adjusting air vents ..... 126  
 Air distribution settings ..... 124  
 Air-recirculation mode ..... 124  
 Automatic control ..... 123  
 Defrosting the windows ..... 124  
 Defrosts the windshield ..... 123  
 Dual-zone automatic climate control panel ..... 123  
 Fragrance system ..... 124  
 Ionization ..... 124  
 PAG oil capacity ..... 371  
 Refrigerant ..... 371  
 Refrigerant filling capacity ..... 371  
 Sets the airflow ..... 123  
 Setting the air distribution ..... 123  
 Setting the temperature ..... 123  
 Switching the rear window heater on/off ..... 123  
 Windshield heater ..... 126
- Cockpit** ..... 6  
   Overview ..... 6  
**COMAND**  
   see Multimedia system  
**COMAND Touch**  
   Authorizing a device ..... 231

- Child safety lock ..... 231
  - Connection status**
    - Displays ..... 272
    - Overview ..... 272
  - Contacts** ..... 260
    - Calling up ..... 260
    - Deleting ..... 262
    - Downloading (from mobile phone) ..... 260
    - Importing ..... 261
    - Information ..... 260
    - Making a call ..... 261
    - Name format ..... 261
    - Options ..... 261
    - Saving ..... 261
  - Controller**
    - Operating ..... 220
  - Convenience closing** ..... 72
  - Convenience opening** ..... 71
  - Coolant (engine)**
    - Checking level ..... 304
    - Filling capacity ..... 370
    - Notes ..... 370
  - Cooling**
    - see Climate control
  - Copyright**
    - Licenses ..... 28
    - Trademarks ..... 28
  - Cornering light function** ..... 113
  - Crosswind Assist**
    - see ESP® (Electronic Stability Program)
  - Cruise control**
    - Activating ..... 158
    - Calling up a speed ..... 158
    - Deactivating ..... 158
    - Function ..... 158
    - Lever ..... 158
    - Prerequisites ..... 158
    - Selecting ..... 158
    - Setting a speed ..... 158
    - Storing a speed ..... 158
    - System limitations ..... 158
  - Cup holder** ..... 103
    - Installing/removing (center console) ... 103
    - Rear passenger compartment ..... 104
  - Cup holder**
    - see Cup holder
  - Customer Assistance Center (CAC)** ..... 25
  - Customer Relations Department** ..... 25
- D**
- Dashboard**
    - see Cockpit
  - Data**
    - Importing/exporting ..... 232
    - Notes on data import/export ..... 232
    - PIN protection for data export ..... 232
  - Data acquisition**
    - Vehicle ..... 26
  - Daytime running lights** ..... 115
    - Activating/deactivating ..... 115
  - Daytime running lights mode**
    - see Daytime running lights
  - Deactivating the alarm (ATA)** ..... 80
  - Declaration of Conformity**
    - Wireless vehicle components ..... 23
  - Definitions (tires and loading)** ..... 349
  - Destination**
    - Editing the previous destinations ..... 247

- Entering an intermediate destination .. 239
- Saving (current vehicle position) ..... 246
- Storing a map position ..... 246
- Destination entry** ..... 236
  - Entering a POI or address ..... 235
  - Entering geo-coordinates ..... 237
  - Selecting a contact ..... 237
  - Selecting a POI ..... 236
  - Selecting from the map ..... 238
- Diagnostics connection** ..... 24
- Digital Operator's Manual** ..... 18
- Digital speedometer** ..... 200
- DIRECT SELECT selector lever** ..... 136
  - Engaging drive position ..... 138
  - Engaging park position automatically .. 138
  - Engaging reverse gear ..... 137
  - Function ..... 136
  - Selecting park position ..... 138
  - Shifting to neutral ..... 137
- Display (multimedia system)**
  - Care ..... 311
  - Settings ..... 227
- Display (on-board computer)** ..... 198
- Display content**
  - Menu (on-board computer) ..... 205
- Display message** ..... 374
  - Calling up (on-board computer) ..... 374
  - Notes ..... 374
- Display messages**
  -  ..... 401
  -  ..... 413
  -  ..... 413
  -  ..... 414
  -  ..... 398
  - Active Blind Spot Assist Currently Unavailable See Operator's Manual .... 397
  - Active Blind Spot Assist Inoperative .... 397
  - Active Blind Spot Asst. Not Available When Towing a Trailer See Operator's Manual ..... 397
  - Active Brake Assist Functions Currently Limited See Operator's Manual ..... 381, 382
  - Active Brake Assist Functions Limited See Operator's Manual ..... 382
  - Active Hood Malfunction See Operator's Manual ..... 413
  - Active Lane Keeping Assist Camera View Restricted See Operator's Manual ..... 396
  - Active Lane Keeping Assist Currently Unavailable See Operator's Manual .... 395
  - Active Lane Keeping Assist Inoperative ..... 395
  - Adaptive Highbeam Assist Camera View Restricted See Operator's Manual ..... 416
  - Adaptive Highbeam Assist Currently Unavailable See Operator's Manual .... 416
  - Adaptive Highbeam Assist Inoperative ..... 416
  - Apply Brake to Shift from 'P' ..... 409

-  ATTENTION ASSIST Inoperative ... 391
-  ATTENTION ASSIST: Take a Break! ..... 391
-  Auto Lamp Function Inoperative .. 415
- Auxiliary Battery Malfunction ..... 411
- Blind Spot Assist Currently Unavailable See Operator's Manual ..... 396
- Blind Spot Assist Inoperative ..... 397
- Blind Spot Assist Not Available When Towing a Trailer See Operator's Manual ..... 397
-  BRAKE Check Brake Fluid Level ..... 380
- Check Coolant Level See Operator's Manual ..... 400
-  Check Engine Oil At Next Refueling ..... 403
-  Check Tires ..... 404
-  Check Washer Fluid ..... 414
-  Compressor Is Cooling ..... 393
-  Coolant Too Hot Stop Vehicle Turn Engine Off ..... 400
- Cruise Control Inoperative ..... 399
- Cruise Control Off ..... 399
-  Currently Unavailable See Operator's Manual ..... 375
-  Currently Unavailable See Operator's Manual ..... 376
- Distance Pilot Currently Unavailable See Operator's Manual ..... 398
- Distance Pilot Inoperative ..... 398
- Distance Pilot Now Available ..... 398
-  Don't Forget Your Key ..... 408
-  Drive More Slowly ..... 393
- Driver's Door Open & Transmission Not in P Risk of Vehicle Rolling Away ... 410
-  Example: Check Left Low Beam ..... 415
-  Example: Front Left Malfunction Service Required ..... 388
-  Example: Left Side Curtain Airbag Malfunction Service Required ..... 388
- Example: Parking Pilot Parking Canceled ..... 399
-  Example: Rear Left Backrest Not Latched ..... 414
- Front Passenger Airbag Disabled See Operator's Manual ..... 389
- Front Passenger Airbag Enabled See Operator's Manual ..... 390
-  Fuel Level Low ..... 403
-  Gas Cap Loose ..... 403
-  Inoperative See Operator's Manual ..... 379
-  Inoperative See Operator's Manual ..... 377
-  EBD Inoperative See Operator's Manual ..... 378
-  SOS Inoperative ..... 389

-  Key Not Detected (red display message) ..... 408
-  Key Not Detected (white display message) ..... 408
-  Malfunction See Operator's Manual ..... 392
-  Malfunction See Operator's Manual ..... 417
- N Permanently Active Risk of Rolling Away ..... 410
-  Obtain a New Key ..... 409
- HOLD** Off ..... 391
- Only Shift to 'P' when Vehicle is Stationary ..... 410
- PARK** Parking Brake See Operator's Manual ..... 384
- Parking Pilot and PARKTRONIC Inoperative See Operator's Manual ..... 399
- Parking Pilot Maneuvering Assistance Restricted See Operator's Manual ..... 399
-  Place the Key in the Marked Space See Operator's Manual ..... 407
-  Please Correct Tire Pressure ..... 405
- PARK** Please Release Parking Brake ..... 383
- PRE-SAFE Impulse Side Inoperative See Operator's Manual ..... 382
- PRE-SAFE Inoperative See Operator's Manual ..... 382
- Radar Sensors Dirty See Operator's Manual ..... 381
-  Replace Key Battery ..... 409
- Reversing Not Possible Service Required ..... 410
-  See Operator's Manual ..... 401
- Service Required Do Not Shift Gears Visit Dealer ..... 410
-  SRS Malfunction Service Required ..... 387
-  Start Engine See Operator's Manual ..... 401
-  Steering Malfunction Drive Carefully Service Required ..... 411
-  Steering Malfunction Increased Physical Effort See Operator's Manual ..... 412
-  Steering Malfunction Stop Immediately See Operator's Manual .... 412
- Steering Pilot Currently Unavailable See Operator's Manual ..... 398
- Steering Pilot Inoperative ..... 398
- Stop Vehicle Leave Engine Running Wait Transmission Cooling ..... 411
-  Stop Vehicle Leave Engine Running ..... 402
-  Stop Vehicle See Operator's Manual ..... 402

-  Stop Vehicle Vehicle Too Low ..... 392
-  Switch Off Lights ..... 415
-  Switch On Headlamps ..... 415
- Tire Press. Monitor Currently  
Unavailable ..... 404
- Tire Press. Monitor Inoperative ..... 406
- Tire Pressure Monitor Inoperative No  
Wheel Sensors ..... 407
- Tires Overheated ..... 406
- Tires Overheated Decrease Speed ..... 406
- To Deselect P or N, Depress Brake  
and Start Engine ..... 409
- Traffic Sign Assist Camera View  
Restricted See Operator's Manual ..... 394
- Traffic Sign Assist Currently Unavail-  
able See Operator's Manual ..... 394
- Traffic Sign Assist Inoperative ..... 394
- Transmission Malfunction Stop ..... 410
-  Turn On the Ignition to Release  
the Parking Brake ..... 383
-  Vehicle Rising Please Wait ..... 391
-  Vehicle Rising ..... 393
-  Warning Tire Malfunction ..... 405
-  Wheel Sensor(s) Missing ..... 407
- Distance control**  
see Driving system
- Distance Pilot DISTRONIC**  
Activating ..... 162  
Activation conditions ..... 162  
Calling up a speed ..... 162  
Deactivating ..... 162  
Function ..... 160  
Lever ..... 162  
Setting a speed ..... 162  
Storing a speed ..... 162  
System limits ..... 160
- Door**  
Locking (emergency key) ..... 63  
Opening (from inside) ..... 60  
Unlocking (emergency key) ..... 63  
Unlocking (from inside) ..... 60
- Door control panel** ..... 14
- DOT, Tire Identification Number (TIN)** ... 345
- Drinking and driving** ..... 131
- DRIVE PILOT**  
Function ..... 166
- Drive position**  
Selecting ..... 138
- Drive program display** ..... 135
- Drive programs** ..... 135
- Driver's seat**  
see Seat
- Driving light**  
see Automatic driving lights
- Driving safety system**  
ABS (Anti-lock Braking System) ..... 149  
Active Brake Assist ..... 153  
BAS (Brake Assist System) ..... 150  
EBD (Electronic Brake force Distribu-  
tion) ..... 153  
ESP® (Electronic Stability Program) .... 150  
ESP® (Electronic Stability Program)  
Crosswind Assist ..... 153
- Driving safety systems**  
Overview ..... 149

- Driving system** ..... 158, 160, 173, 180, 185  
 360° camera ..... 178  
 Active Blind Spot Assist ..... 189  
 Active Lane Keeping Assist ..... 191  
 AIR BODY CONTROL ..... 170  
 ATTENTION ASSIST ..... 185  
 Blind Spot Assist ..... 189  
 Cruise control ..... 158  
 Distance Pilot DISTRONIC ..... 160  
 HOLD function ..... 168  
 Parking Assist PARKTRONIC ..... 173  
 Parking Pilot ..... 180  
 Rear view camera ..... 175  
 Speed Limit Pilot ..... 160  
 Steering Pilot ..... 166  
 Traffic Sign Assist ..... 187
- Driving systems**  
 Overview ..... 149  
 Responsibility ..... 149
- Driving tips**  
 Drinking and driving ..... 131  
 General driving tips ..... 131  
 Notes on breaking-in a new vehicle .... 131
- Drowsiness detection**  
 see Driving system
- Dynamic multicontour seat**  
 Setting ..... 87
- DYNAMIC SELECT**  
 Configuring drive program I ..... 136  
 Displaying engine data ..... 136  
 Displaying vehicle data ..... 136  
 Drive program display ..... 135  
 Drive programs ..... 135  
 Function ..... 135  
 Operating (DYNAMIC SELECT switch)  
 ..... 135
- E**
- Easy entry feature**  
 Operation/notes ..... 92  
 Setting ..... 93
- Easy exit feature**  
 Operation/notes ..... 92  
 Setting ..... 93
- EASY-PACK trunk box** ..... 101  
 Adjusting the height to any position .... 100  
 Care ..... 311  
 Installing/removing ..... 101
- EBD (Electronic Brake force Distribution)**  
 Function/notes ..... 153
- ECO display**  
 Function ..... 134  
 Resetting ..... 201
- ECO start/stop function** ..... 133, 134  
 Automatic engine start ..... 133  
 Automatic engine stop ..... 133  
 Operation ..... 133  
 Switching off/on ..... 134
- Electric parking brake** ..... 146, 147, 148  
 Applying automatically ..... 146  
 Applying or releasing manually ..... 147  
 Emergency braking ..... 148  
 Releasing automatically ..... 147
- Electrical fuses**  
 see Fuses
- Emergency**  
 Overview of the help functions ..... 16  
 Safety vest ..... 314
- Emergency braking** ..... 148

- Emergency call system**  
Mercedes-Benz mbrace® (USA only) ... 267
- Emergency engine start** ..... 328
- Emergency key**  
Inserting/removing ..... 57  
Locking a door ..... 63  
Unlocking a door ..... 63
- Emergency operation mode**  
Starting vehicle ..... 130
- Emergency release**  
Trunk lid (from inside) ..... 68
- Emergency Tensioning Devices**  
Activation ..... 31
- Energy consumption**  
Key ..... 56
- Engine**  
ECO start/stop function ..... 133  
Engine number ..... 364  
Starting (emergency operation mode) ..... 130  
Starting (smartphone) ..... 130  
Starting (start/stop button) ..... 129  
Starting assistance ..... 322  
Switching off (start/stop button) ..... 141
- Engine data**  
Displaying ..... 136
- Engine hood**  
Opening/closing ..... 300
- Engine number** ..... 364
- Engine oil** ..... 303  
Additives ..... 368  
Capacity ..... 368  
Checking the oil level using the oil dipstick ..... 303  
MB-Freigabe or MB-Approval ..... 368  
Topping up ..... 303
- Entering characters**  
On the controller ..... 225  
On the touchpad ..... 226
- ESP® (Electronic Stability Program)** ..... 153  
Activating/deactivating ..... 153  
Crosswind Assist ..... 153  
Function/notes ..... 150
- ESP® (Electronic Stability Program) Crosswind Assist**  
Function/notes ..... 153
- Exterior lighting**  
see Lights
- Exterior lighting (Care)** ..... 309
- Eyeglasses box** ..... 96
- F**
- Favorites**  
Adding ..... 223  
Calling up ..... 223  
Deleting ..... 224  
Moving ..... 224  
Overview ..... 222  
Renaming ..... 223
- Flat tire**  
Changing a wheel ..... 356  
MOExtended tires ..... 315  
Notes ..... 314  
TIREFIT kit ..... 316
- Floor mats** ..... 109
- Fragrance**  
see Fragrance system
- Fragrance system** ..... 125  
Inserting/removing a flacon ..... 125



- Setting ..... 124
- Frequencies**
- Two-way radio ..... 362
- Frequency band**
- Dial (on-board computer) ..... 203
- Front airbag** ..... 37
- Front passenger air bag shutoff** ..... 39
- Points to remember when the front passenger seat is occupied ..... 39
- Front passenger airbag shutoff**
- PASSENGER AIRBAG indicator lamp ..... 41
- Status display ..... 41
- System self-test ..... 41
- Front passenger seat**
- see Seat
- Fuel** ..... 368
- Additives ..... 368
- Consumption ..... 368
- E10 ..... 367
- Gasoline ..... 367
- Quality (gasoline) ..... 367
- Refueling ..... 139
- Reserve fuel level ..... 368
- Sulfur content ..... 367
- Tank capacity ..... 368
- Fuel consumption**
- On-board computer ..... 200
- Fuse insert**
- see Fuses
- Fuses** ..... 328
- Assignment diagram ..... 328
- Before changing ..... 328
- Cockpit fuse box ..... 330
- Fuse box in the engine compartment .. 329
- Fuse box in the front-passenger footwell ..... 330
- Fuse box in the trunk ..... 331
- Notes ..... 328
- G**
- Garage door opener**
- Clearing the memory ..... 145
- Opening or closing the garage door .... 145
- Programming buttons ..... 142
- Radio equipment approval number ..... 145
- Resolving problems ..... 144
- Synchronizing the rolling code ..... 144
- Gearshift recommendation** ..... 139
- Genuine parts** ..... 19
- Genuine wood (Care)** ..... 311
- Glove box**
- Air vent ..... 127
- Glove compartment**
- Locking/unlocking ..... 96
- H**
- Handbrake**
- see Electric parking brake
- Handling characteristics (unusual)** ..... 332
- HANDS-FREE ACCESS** ..... 66
- Hazard warning lights** ..... 113
- Head restraint**
- Front (adjusting manually) ..... 85
- Front (luxury head restraint) ..... 86
- Rear passenger compartment (adjusting) ..... 87
- Rear passenger compartment (removing/installing) ..... 87

- Head-up display**  
 Activating/deactivating ..... 207  
 Function ..... 206  
 Menu (on-board computer) ..... 205  
 Setting display elements (on-board computer) ..... 205  
 Setting the brightness (on-board computer) ..... 205  
 Setting the position (on-board computer) ..... 205  
 Using the memory function ..... 93
- Headlamp flashing** ..... 112
- Heating**  
 see Climate control
- High beam**  
 Activating/deactivating ..... 112
- High-beam headlamps**  
 Adaptive Highbeam Assist ..... 113
- High-pressure cleaning equipment (care)** ..... 307
- Hill start assist** ..... 131
- HOLD function**  
 Activating/deactivating ..... 169
- Method of operation ..... 168
- I**
- Identification plate**  
 Engine ..... 364  
 Refrigerant ..... 371  
 Vehicle ..... 364
- Identification plate**  
 see Vehicle identification plate
- Ignition**  
 Switching on (start/stop button) ..... 128
- Immobilizer** ..... 79
- Indicator lamp**  
 see Warning/indicator lamps
- Individual drive program**  
 Configuring ..... 136  
 Selecting ..... 135
- Information**  
 Audio mode ..... 276  
 Bluetooth® Audio ..... 286  
 Burmester® high-end 3D surround sound system ..... 297  
 Burmester® surround sound system ... 296
- Media Interface ..... 283  
 Satellite radio ..... 292  
 Software update ..... 234  
 Sound settings ..... 296
- Instrument cluster**  
 see Instrument display
- Instrument display** ..... 195  
 Lights ..... 199  
 Overview ..... 195  
 Warning and indicator lamps (overview) .. 8  
 Warning/indicator lamps ..... 417
- Instrument lighting** ..... 199
- Interior lighting** ..... 115  
 Ambient lighting ..... 116  
 Setting ..... 115  
 Switch-off delay time ..... 116
- Interior lighting**  
 see Interior lighting
- Intermediate destination**  
 Editing ..... 239  
 Entering ..... 239  
 Starting an automatic gas station search ..... 239

- Internet connection**
  - Canceling permission ..... 272
  - Connection status ..... 272
  - Displaying the connection status ..... 272
  - Editing the access data ..... 271
  - Establishing ..... 272
  - Mobile phone details ..... 272
  - Restrictions ..... 269
  - Setting access data ..... 270
  - Setting up ..... 270
  - Switching Bluetooth® profile (DUN/  
PAN) ..... 271
  - Via Bluetooth® ..... 270
  - Via Wi-Fi ..... 269
- Internet favorites**
  - Deleting ..... 274
  - Setting ..... 274
- Internet history**
  - Deleting ..... 274
- Internet radio**
  - Calling up ..... 275
  - Deleting stations ..... 276
  - Logging in ..... 276
  - Logging out ..... 276
  - Overview ..... 275
- Saving stations ..... 276
  - Selecting and connecting to a station  
..... 276
  - Selecting stream ..... 276
  - Setting options ..... 276
  - Terms of use ..... 276
- Ionization** ..... 124
- J**
- Jack**
  - Storage location ..... 355
- K**
- Key** ..... 55
  - Battery ..... 57
  - Energy consumption ..... 56
  - Overview ..... 55
- KEYLESS-GO**
  - Locking the vehicle ..... 60
  - Problem ..... 61
  - Unlocking setting ..... 56
  - Unlocking the vehicle ..... 60
- Kickdown** ..... 139
  - Using ..... 139
- Knee airbag** ..... 37
- L**
- Labeling (tires)**
  - see Tire labeling
- Laden**
  - Definitions ..... 349
- Lamp**
  - see Interior lighting
- Lamp (instrument display)**
  - see Warning/indicator lamps
- Language**
  - Notes ..... 231
  - Setting ..... 231
- LATCH-type (ISOFIX) child seat attachment**
  - Installing ..... 49
  - Notes ..... 48
- Light and visibility**
  - Infrared reflective windshield ..... 122
- Lighting**
  - see Lights

- Lights** ..... 111
- Adaptive Highbeam Assist ..... 113
  - Automatic driving lights ..... 112
  - Combination switch ..... 112
  - Cornering light function ..... 113
  - Hazard warning lights ..... 113
  - Headlamp flashing ..... 112
  - High beam ..... 112
  - Instrument display ..... 199
  - Light switch ..... 111
  - Low beam ..... 111
  - Parking lights ..... 111
  - Rear fog light ..... 112
  - Responsibility for lighting systems ..... 111
  - Standing lights ..... 111
  - Turn signal light ..... 112
- Limited Warranty**
- Vehicle ..... 26
- Load index (tires)** ..... 347
- Load rating (tires)** ..... 347
- Loading guidelines** ..... 94
- Loading information table** ..... 340
- Loads**
- Securing ..... 94
- Low beam**
- Switching on/off ..... 111
- Lowering**
- Vehicle ..... 360
- Lubricant additives**
- see Additives
- Luggage**
- Securing ..... 94
- Lumbar support**
- see Lumbar support (4-way)
- Lumbar support (4-way)** ..... 85
- M**
- Main function**
- Calling up ..... 222
- Maintenance**
- Vehicle ..... 21
- Making a call via the overhead control panel**
- Mercedes-Benz mbrace® (USA only) ... 267
- Malfunction**
- Restraint system ..... 31
- Map** ..... 248, 250
- Avoiding (changing) an area ..... 252
  - Avoiding an area ..... 252
  - Avoiding an area (deleting) ..... 253
  - Avoiding an area (overview) ..... 252
  - Displaying the compass ..... 254
  - Displaying the map version ..... 252
  - Displaying the next intersecting street ..... 252
  - Displaying the satellite map ..... 254
  - Displaying the traffic map ..... 248
  - Displaying traffic signs ..... 252
  - Displaying weather information ..... 254
  - Free update ..... 253
  - Map data ..... 254
  - Moving ..... 250
  - Selecting POI symbols ..... 251
  - Selecting text information ..... 251
  - Selecting the map orientation ..... 251
  - Setting the map scale ..... 250
  - Update (free) ..... 253
- Map and compass**
- Overview ..... 249
- Message programs**
- Overview ..... 88

- Selecting the front seats ..... 89
- Massage settings**
  - Resetting ..... 89
- Matt finish (cleaning instructions)** ..... 308
- Maximum load rating** ..... 346
- Maximum permissible load**
  - Calculation example ..... 342
  - Determining ..... 341
- Maximum tire pressures** ..... 346
- Media**
  - Menu (on-board computer) ..... 203
  - Searching ..... 283
- Media display**
  - Notes ..... 219
- Media Interface**
  - Activating ..... 284
  - Information ..... 283
  - Overview ..... 285
- Media mode**
  - Activating ..... 277
- Media playback**
  - Operating (on-board computer) ..... 203
- Media search**
  - Starting ..... 283
- Media source**
  - Dial (on-board computer) ..... 203
- Memory function**
  - Head-up Display – Calling up saved settings ..... 93
  - Head-up Display – Saving settings ..... 93
  - Operating ..... 93
  - Outside mirror – Calling up saved settings ..... 93
  - Outside mirror – Saving settings ..... 93
  - Seat – Calling up saved settings ..... 93
  - Seat – Saving settings ..... 93
  - Steering wheel – Calling up saved settings ..... 93
  - Steering wheel – Saving settings ..... 93
- Menu (on-board computer)**
  - Assistance graphic ..... 199
  - Content ..... 205
  - Head-up Display ..... 205
  - Media ..... 203
  - Navigation ..... 202
  - Overview ..... 197
  - Radio ..... 203
- Service ..... 199
- Telephone ..... 204
- Trip ..... 200
- Mercedes-Benz Apps**
  - Calling up ..... 273
  - Using voice control ..... 273
- Mercedes-Benz mbrace® (USA only)**
  - Emergency call system ..... 267
  - Making a call via the overhead control panel ..... 267
  - MB Info call ..... 268
  - Roadside Assistance call ..... 268
  - Transferred data ..... 269
- Message (multifunction display)**
  - see Display message
- Message memory** ..... 374
- Messages**
  - see Text messages
- Mirrors**
  - see Outside mirror
  - see Outside mirrors
- Mobile (multimedia system)**
  - see Telephone

**Mobile phone**

Wireless charging ..... 108

**Mobile phone (multimedia system)**

see Telephone

**Mobile phone voice recognition**Starting ..... 259  
Stopping ..... 259**MOExtended tires** ..... 315**Multifunction display (on-board computer)** ..... 198**Multifunction steering wheel**

see Steering wheel

**Multimedia system** ..... 219Adjusting the volume ..... 225  
Calling up lists and menus ..... 222  
Overview ..... 219  
Restoring the factory settings ..... 234  
Switching the sound on/off ..... 224  
Using the character input function ..... 225**N****Navigation**

Activating ..... 235

## Calling up the Digital Operator's

Manual ..... 255  
Commands (Voice Control System) ..... 212  
Menu (on-board computer) ..... 202  
Showing/hiding the menu ..... 235**Navigation announcements**Activating/deactivating ..... 244  
Adjusts the volume ..... 245  
Repeating ..... 245  
Switching audio fadeout on/off ..... 245  
Switching on/off during a phone call .. 244**Navigation messages**

On-board computer ..... 202

**Near Field Communication** ..... 257Connecting the mobile phone to the  
multimedia system ..... 257  
Switching mobile phones ..... 257  
Switching to Bluetooth® audio equip-  
ment ..... 287**Neutral**

Selecting ..... 137

**NFC**

see Near Field Communication

**Noise**

Wheels and tires ..... 332

**Notes on breaking-in a new vehicle** ..... 131**O****Occupant safety**Airbags ..... 37  
Children in the vehicle ..... 45  
Front passenger air bag shutoff ..... 39  
PASSENGER AIRBAG indicator lamp ..... 41  
Pets in the vehicle ..... 54  
PRE-SAFE® (anticipatory occupant  
protection) ..... 44  
PRE-SAFE® Impulse Side ..... 45  
PRE-SAFE® PLUS (anticipatory occu-  
pant protection plus) ..... 44  
Seat belts ..... 32**Odometer**

see Total distance

**Oil**

see Engine oil

**On-board computer**Assistance graphic menu ..... 199  
Displaying the service due date ..... 299

- Head-up Display menu ..... 205
  - Media menu ..... 203
  - Menu content ..... 205
  - Menus ..... 197
  - Multifunction display ..... 198
  - Navigation system menu ..... 202
  - Operating ..... 197
  - Radio menu ..... 203
  - Service menu ..... 199
  - Telephone menu ..... 204
  - Trip menu ..... 200
  - Operating fluids**
    - Additive (fuel) ..... 368
    - Brake fluid ..... 369
    - Coolant (engine) ..... 370
    - Engine oil ..... 368
    - Fuel (gasoline) ..... 367
    - Notes ..... 366
    - Refrigerant (air conditioning system) ... 371
    - Windshield washer fluid ..... 370
  - Operating safety**
    - Declaration of conformity (wireless vehicle components) ..... 23
    - Information ..... 22
  - Operator's Manual**
    - Vehicle equipment ..... 20
  - Outside mirror** ..... 120
    - Parking position ..... 120
  - Outside mirrors** ..... 119, 120
    - Anti-glare mode (automatic) ..... 120
    - Folding in/out ..... 119
    - Setting ..... 119
    - Using the memory function ..... 93
  - Overhead control panel** ..... 12
  - Overview**
    - Audio mode ..... 279
    - Bluetooth® Audio ..... 288
    - Call list ..... 262
    - Central controls ..... 219
    - Connection status ..... 272
    - Favorites ..... 222
    - Internet radio ..... 275
    - Media Interface ..... 285
    - Multimedia system ..... 219
    - Radio ..... 290
    - Satellite radio ..... 294
    - Telephone menu ..... 255
    - Traffic information ..... 247
  - Video mode ..... 282
  - Web browser ..... 273
  - Wi-Fi ..... 228
- P**
- Paint (cleaning instructions)** ..... 308
  - Panic alarm** ..... 56
    - Activating/deactivating ..... 56
  - Panoramic sliding sunroof**
    - see Sliding sunroof
  - Park position**
    - Selecting ..... 138
    - Selecting automatically ..... 138
  - Parking** ..... 148
  - Parking aid**
    - see Driving system
  - Parking Assist PARKTRONIC**
    - Activating ..... 174
    - Adjusting warning tones ..... 175
    - Deactivating ..... 174
    - Function ..... 173
    - System borders ..... 173

- Parking assistance systems**  
see Driving system
- Parking brake**  
see Electric parking brake
- Parking lights** ..... 111
- Parking Pilot**  
Adjusting warning tones ..... 175  
Cross Traffic Alert ..... 184  
Drive Away Assist ..... 184  
Exiting a parking space ..... 183  
Function ..... 180  
Maneuvering assistance ..... 185  
Parking ..... 182  
System limitations ..... 180
- Parking position**  
Outside mirror ..... 120  
Passenger outside mirror – storing  
using the memory button ..... 121
- Payload**  
Calculation example ..... 342  
Determining the maximum ..... 341
- Pedestrian protection**  
see Active hood (pedestrian protection)
- Perfume**  
see Fragrance system
- Perfume vial**  
see Fragrance system
- Permission**  
Canceling ..... 272
- Pets in the vehicle** ..... 54
- Phone book**  
see Contacts
- Picture formats**  
see Video mode
- Picture settings**  
see Video mode
- PIN protection for data export** ..... 232
- Plastic trim (Care)** ..... 311
- Playback options**  
Selecting ..... 280
- Power supply**  
Switching on (start/stop button) ..... 128
- PRE-SAFE® (anticipatory occupant protection)**  
Function ..... 44
- PRE-SAFE® Sound ..... 44  
Reversing measures ..... 44
- PRE-SAFE® Impulse Side**  
Activation ..... 31  
Function ..... 45
- PRE-SAFE® PLUS (anticipatory occupant protection plus)**  
Function ..... 44  
Reversing measures ..... 44
- Previous destinations**  
Selecting ..... 237
- Protection of the environment**  
Notes ..... 19
- Q**
- QR code**  
Rescue card ..... 26
- Qualified specialist workshop** ..... 25
- R**
- Radar sensors** ..... 149
- Radiator shutters**  
see AIRPANEL (Care)



- Radio**
- Activating ..... 289
  - Activating/deactivating radio text ..... 292
  - Calling up the station list ..... 291
  - Commands (Voice Control System) ..... 215
  - Delete station ..... 291
  - Direct frequency entry ..... 291
  - Displaying information ..... 292
  - Editing station presets ..... 291
  - Menu (on-board computer) ..... 203
  - Moving stations ..... 291
  - Overview ..... 290
  - Searching for stations ..... 291
  - Setting a station ..... 291
  - Setting the frequency band ..... 291
  - Storing stations ..... 291
  - Switching HD radio on/off ..... 291
  - Tagging music tracks ..... 292
  - To display radio text ..... 292
- Radio station list**
- Calling up ..... 291
- Radio stations**
- Dial (on-board computer) ..... 203
- Rain closing function**
- Sliding sunroof ..... 76
- Range** ..... 200
- Reading lamp**
- see Interior lighting
- Rear door (child safety lock)** ..... 52
- Rear fog light** ..... 112
- Rear seat**
- see Seat
- Rear view camera**
- Function ..... 175
- Rear window**
- Roller sun blind ..... 69
- Rear window heater** ..... 123
- Rear-view mirror**
- see Outside mirrors
- Refrigerant (air conditioning system)**
- Notes ..... 371
- Refueling**
- Refueling the vehicle ..... 139
- Reporting malfunctions relevant to safety** ..... 25
- Rescue card** ..... 26
- Reset function (multimedia system)** ..... 234
- Restoring (factory settings)**
- see Reset function (multimedia system)
- Restraint system**
- Children ..... 45
  - Function in an accident ..... 31
  - Functionality ..... 31
  - Malfunction ..... 31
  - Protection ..... 30
  - Reduced protection ..... 30
  - System self-test ..... 31
  - Warning lamp ..... 31
- Restrictions**
- Internet connection ..... 269
- Reverse gear**
- Selecting ..... 137
- Reversing camera**
- Care ..... 309
  - Opening the camera cover ..... 180
- RF transmitters**
- see Two-way radios
- Rims (Care)** ..... 309
- Roadside Assistance** ..... 21

- Roller sun blind**  
 Rear window ..... 69  
 Side windows ..... 69
- Roof lining (Care)** ..... 311
- Roof load** ..... 373
- Roof rack** ..... 103
- Route** ..... 242  
 Calculating ..... 240  
 Displaying destination information ..... 242  
 Selecting a type ..... 241  
 Selecting an alternative route ..... 242  
 Selecting notifications ..... 242  
 Selecting options ..... 241  
 Switching the automatic gas station  
 search on/off ..... 242  
 With intermediate destinations ..... 239
- Route guidance**  
 Canceling ..... 245  
 Changing direction ..... 243  
 Continuing ..... 245  
 Destination reached ..... 244  
 From an off-road location ..... 246  
 Lane recommendations ..... 243  
 Notes ..... 242
- Off-road ..... 246  
 To an off-road destination ..... 246
- Run-flat characteristics**  
 MOExtended tires ..... 315
- S**
- Safety**  
 Children in the vehicle ..... 45
- Safety vest** ..... 314
- Satellite radio**  
 Activating ..... 293  
 Deleting a channel ..... 295  
 Displaying EPG information ..... 295  
 Displaying service information ..... 296  
 Information ..... 292  
 Moving a channel ..... 295  
 Music and sport alerts function ..... 295  
 Overview ..... 294  
 Registering ..... 292  
 Restrictions ..... 292  
 Saving a channel ..... 295  
 Selecting a category ..... 295  
 Selecting a channel ..... 295  
 Setting the music and sport alerts ..... 295
- Setting the parental control ..... 295
- SD memory card**  
 Inserting/removing ..... 277
- Seat** ..... 82, 97  
 4-way lumbar support ..... 85  
 Adjusting (electrically) ..... 85  
 Adjusting (manually and electrically) ..... 82  
 Adjusting (Seat Comfort) ..... 84  
 Backrest (rear passenger compart-  
 ment) folding forwards ..... 97  
 Correct driver's seat position ..... 81  
 Folding back the backrest (rear  
 passenger compartment) ..... 98  
 Locking the backrest (rear passenger  
 compartment) ..... 99  
 Resetting the settings ..... 89  
 Setting options ..... 14  
 Using the memory function ..... 93
- Seat adjustment**  
 Configuring ..... 87
- Seat belt**  
 Activating/deactivating seat belt  
 adjustment ..... 36  
 Adjusting the height ..... 35

- Belt air bag ..... 35
- Fastening ..... 35
- Releasing ..... 36
- Seat belt adjustment (function) ..... 35
- Seat belt adjustment**
- Activating/deactivating ..... 36
- Function ..... 35
- Seat belt warning**
- see Seat belts
- Seat belts** ..... 36
- Care ..... 311
- Protection ..... 32
- Reduced protection ..... 33
- Warning lamp ..... 36
- Seat cover (Care)** ..... 311
- Seat heater**
- Switching on/off ..... 90
- Seat ventilation**
- Switching on/off ..... 90
- Selecting a gear**
- see Shifting gears
- Selecting a POI**
- see Destination entry
- Selector lever**
- see DIRECT SELECT selector lever
- Sensors (Care)** ..... 309
- Service**
- Menu (on-board computer) ..... 199
- Setting Daylight Saving Time (Summer)** ..... 228
- Setting the date format** ..... 228
- Setting the distance unit** ..... 232
- Setting the map scale**
- see Map
- Setting the sound profile**
- Burmester® high-end 3D surround  
  sound system ..... 298
- Setting up a hotspot (Wi-Fi)** ..... 230
- Settings**
- Display (multimedia system) ..... 227
- Shifting gears** ..... 138
- Gearshift recommendation ..... 139
- Manual ..... 138
- Short text messages**
- see Text messages
- Side airbag** ..... 37
- Side windows**
- Child safety lock in the rear  
  passenger compartment ..... 54
- Closing ..... 70
- Closing with the SmartKey ..... 72
- Opening ..... 70
- Opening with the SmartKey ..... 71
- Problem ..... 72
- Roller sun blind ..... 69
- Size designation (tires)** ..... 347
- Sliding sunroof** ..... 74
- Automatic functions ..... 76
- Closing ..... 74
- Closing with the SmartKey ..... 72
- Opening ..... 74
- Opening with the SmartKey ..... 71
- Problem ..... 77
- Rain closing function ..... 76
- SmartKey**
- Emergency key ..... 57
- Key ring attachment ..... 57
- Panic alarm ..... 56
- Problem ..... 58

- Unlocking setting ..... 56
- Smartphone**
  - Starting vehicle ..... 130
- Smartphone (multimedia system)**
  - see Telephone
- Snow chains** ..... 333
- Socket (12 V)**
  - Front center console ..... 106
  - Rear passenger compartment ..... 106
  - Trunk ..... 107
- Socket (115 V)**
  - Rear passenger compartment ..... 106
- Software update**
  - Information ..... 234
  - Performing ..... 234
- Sound**
  - PRE-SAFE® Sound ..... 44
- Sound settings**
  - Adjusting treble, mid and bass ..... 296
  - Information ..... 296
- Speech dialog system**
  - see Voice Control System
- Speed control**
  - see Driving system
- Speed control system**
  - see Driving system
- Speed limit for winter tires**
  - Setting ..... 159
- Speed Limit Pilot** ..... 160
  - Setting ..... 188
- Speed rating (tires)** ..... 347
- Speedometer**
  - Digital ..... 200
- Standby mode**
  - Activating/deactivating ..... 148
  - Function ..... 148
- Standing lights** ..... 111
- Start/Stop button**
  - Starting vehicle ..... 129
  - Switching off the vehicle ..... 141
  - Switching on the power supply or ignition ..... 128
- Start/stop function**
  - see ECO start/stop function
- Starting assistance** ..... 322
- Starting the engine**
  - see Vehicle
- Starting-off aid**
  - see Hill start assist
- Station**
  - Deleting ..... 291
  - Direct frequency entry ..... 291
  - Moving ..... 291
  - Searching ..... 291
  - Setting ..... 291
  - Storing ..... 291
- Station presets**
  - Editing ..... 291
- Steering Pilot**
  - Activating/deactivating ..... 168
  - Function ..... 166
  - Notes ..... 167
  - System limitations ..... 166
- Steering wheel** ..... 196
  - Adjusting (electrically) ..... 92
  - Adjusting (manually) ..... 91
  - Buttons ..... 196
  - Steering wheel heater ..... 92

- Using the memory function ..... 93
- Steering wheel heater**  
 Activating/deactivating ..... 92
- Stowage compartment**  
 Armrest ..... 96  
 Center console ..... 96  
 Door ..... 96  
 Eyeglasses box ..... 96  
 Glove compartment ..... 96  
 Rear armrest ..... 96
- Stowage space under the trunk floor** .... 102
- Sun visor**  
 Operating ..... 121
- Surround lighting**  
 Setting ..... 115
- Surround View**  
 see 360° camera
- Suspension**  
 AIR BODY CONTROL ..... 170  
 Setting the suspension level ..... 171
- Suspension level**  
 Setting ..... 171
- Switch-off delay time**  
 Interior ..... 116
- Switching the surround sound on/off**  
 Burmester® surround sound system .... 297
- Synchronization function**  
 Activating/deactivating (control panel) ..... 124
- System settings**  
 Activating/deactivating Bluetooth® ..... 228  
 Bluetooth® settings ..... 228  
 Creating a user profile ..... 233  
 Data import/export function ..... 232  
 Importing/exporting data ..... 232  
 Importing/exporting user profiles ..... 233  
 Information on software updates ..... 234  
 Language ..... 231  
 Notes on language selection ..... 231  
 PIN protection for data export ..... 232  
 Reset function ..... 234  
 Selecting a user profile ..... 233  
 Setting the distance unit ..... 232  
 Software update ..... 234  
 User profile options ..... 233
- T**
- Tailgate**  
 see Trunk lid
- Tailpipes (Care)** ..... 309
- Tank capacity (fuel)** ..... 368
- Technical data**  
 Information ..... 362  
 Tire pressure monitoring system ..... 340
- Telephone** ..... 255  
 Activating functions during a call ..... 259  
 Call and ringtone volume ..... 258  
 Commands (Voice Control System) .... 214  
 Connecting a mobile phone (Near Field Communication) ..... 257  
 Connecting a mobile phone (Pass-key) ..... 257  
 Connecting a mobile phone (Secure Simple Pairing) ..... 257  
 Disconnecting the mobile phone ..... 257  
 Menu (on-board computer) ..... 204  
 Mobile phone voice recognition ..... 259  
 Notes ..... 256  
 Reception and transmission volume .... 258  
 Switching mobile phones ..... 257

- Switching mobile phones (Near Field Communication) ..... 257
- Telephone menu overview ..... 255
- Telephone operation ..... 259
- Using Near Field Communication (NFC) ..... 257
- Telephone number**
  - Dialing (on-board computer) ..... 204
- Temperature** ..... 123
- Temperature grade** ..... 344
- Text messages** ..... 262
  - Calling a sender ..... 264
  - Commands (Voice Control System) ..... 216
  - Composing ..... 263
  - Configuring the text messages displayed ..... 263
  - Deleting ..... 264
  - Notes ..... 262
  - Read-aloud function ..... 263
  - Reading ..... 263
  - Replying ..... 264
  - Sending ..... 263
- Tie-down eyes** ..... 99
- Time**
  - Manual time setting ..... 228
  - Setting Daylight Saving Time (Summer) ..... 228
  - Setting the time and date automatically ..... 227
  - Setting the time zone ..... 227
  - Setting the time/date format ..... 228
- TIN (Tire Identification Number)** ..... 345
- Tire and Loading Information placard** ... 340
- Tire characteristics** ..... 347
- Tire inflation compressor**
  - see TIREFIT kit
- Tire information table** ..... 340
- Tire labeling** ..... 344
  - Characteristics ..... 347
  - DOT, Tire Identification Number (TIN) ..... 345
  - Load index ..... 347
  - Load rating ..... 347
  - Maximum tire load ..... 346
  - Maximum tire pressure ..... 346
  - Overview ..... 344
  - Speed rating ..... 347
  - Temperature grade ..... 344
  - Tire Quality Grading ..... 344
  - Tire size designation ..... 347
  - Traction grade ..... 344
  - Tread wear grade ..... 344
- Tire load (maximum)** ..... 346
- Tire pressure**
  - Checking (manually) ..... 337
  - Checking (tire pressure monitoring system) ..... 338
  - Maximum ..... 346
  - Notes ..... 333
  - Restarting the tire pressure monitoring system ..... 339
  - Tire pressure monitoring system (function) ..... 337
  - Tire pressure table ..... 335
- Tire pressure monitoring system**
  - Checking the tire pressure ..... 338
  - Function ..... 337
  - Restarting ..... 339
  - Technical data ..... 340
- Tire pressure table** ..... 335
- Tire Quality Grading** ..... 344

- Tire tread** ..... 332
- Tire-change tool kit**
- Overview ..... 355
- TIREFIT kit** ..... 316
- Storage location ..... 316
  - Using ..... 316
- Tires**
- Changing ..... 356
  - Changing hub caps ..... 356
  - Characteristics ..... 347
  - Checking ..... 332
  - Checking the tire pressure (manually) ..... 337
  - Checking the tire pressure (tire pressure monitoring system) ..... 338
  - Definitions ..... 349
  - DOT, Tire Identification Number (TIN) ..... 345
  - Flat tire ..... 314
  - Load index ..... 347
  - Load rating ..... 347
  - Maximum tire load ..... 346
  - Maximum tire pressure ..... 346
  - MOExtended tires ..... 315
  - Mounting ..... 359
  - Noise ..... 332
  - Notes on Installing ..... 352
  - Overview of tire labeling ..... 344
  - Removing ..... 359
  - Replacing ..... 352
  - Restarting the tire pressure monitoring system ..... 339
  - Selection ..... 352
  - Snow chains ..... 333
  - Speed rating ..... 347
  - Storing ..... 355
  - Temperature grade ..... 344
  - Tire and Loading Information placard ..... 340
  - Tire pressure (Notes) ..... 333
  - Tire pressure monitoring system (function) ..... 337
  - Tire pressure table ..... 335
  - Tire Quality Grading ..... 344
  - Tire size designation ..... 347
  - TIREFIT kit ..... 316
  - Traction grade ..... 344
  - Tread wear grade ..... 344
  - Unusual handling characteristics ..... 332
- To raise**
- Vehicle ..... 357
- Tone settings**
- Adjusting the balance/fader ..... 296
  - Calling up the sound menu ..... 296
- Top Tether** ..... 50
- Total distance** ..... 200
- Touch Control**
- On-board computer ..... 197
  - Operating ..... 220
  - Setting the sensitivity ..... 220
- Touchpad**
- Activating/deactivating ..... 221
  - Operating ..... 221
  - Reading the handwriting recognition aloud ..... 222
  - Selecting an input language ..... 222
  - Setting the sensitivity ..... 221
- Tow starting** ..... 328
- Towing away** ..... 325
- Towing eye**
- Installing ..... 328
  - Storage location ..... 327

- Track**
    - Selecting ..... 280
  - Traction grade** ..... 344
  - Traffic information**
    - Displaying subscription information ..... 247
    - Displaying traffic incidents ..... 248
    - Issuing hazard alerts ..... 249
    - Overview ..... 247
  - Traffic map**
    - see Map
  - Traffic Sign Assist**
    - Function/notes ..... 187
    - Setting ..... 188
    - System limitations ..... 187
  - Trailer hitch**
    - Care ..... 309
  - Transferred vehicle data**
    - Android Auto™ ..... 266
    - Apple CarPlay™ ..... 266
  - Transmission position display** ..... 136
  - Transporting**
    - Pets ..... 54
    - Vehicle ..... 327
  - Tread wear grade** ..... 344
  - Trim element (Care)** ..... 311
  - Trip**
    - Menu (on-board computer) ..... 200
  - Trip computer**
    - Displaying ..... 200
    - Resetting ..... 201
  - Trip distance**
    - Displaying ..... 200
    - Resetting ..... 201
  - Trunk box**
    - see EASY-PACK trunk box
  - Trunk lid** ..... 63
    - Activating/deactivating the trunk lid
      - opening height restriction ..... 69
    - Closing ..... 64
    - Emergency release (from inside) ..... 68
    - HANDS-FREE ACCESS ..... 66
    - Locked separately ..... 68
    - Opening ..... 63
    - Opening dimensions ..... 372
  - Trunk lid**
    - see Trunk lid
  - Trunk load** ..... 373
  - Turn signal indicator**
    - see Turn signal light
  - Turn signal light** ..... 112
    - Activating/deactivating ..... 112
  - Two-way radios** ..... 362
    - Frequencies ..... 362
    - Notes on installation ..... 362
    - Transmission output (maximum) ..... 362
  - Types of commands (Voice Control System)** ..... 209
- U**
- Unlocking setting** ..... 56
  - USB devices**
    - Connecting ..... 280
  - User profile**
    - Creating ..... 233
    - Importing/exporting ..... 233
    - Options ..... 233
    - Selecting ..... 233
  - Using the telephone**
    - see Calls



## V

- Vehicle** ..... 129, 130
  - Commands (Voice Control System) ..... 217
  - Correct use ..... 25
  - Data acquisition ..... 26
  - Electronics ..... 362
  - Equipment ..... 20
  - Limited Warranty ..... 26
  - Locking (automatically) ..... 62
  - Locking (from inside) ..... 60
  - Locking (KEYLESS-GO) ..... 60
  - Lowering ..... 360
  - Maintenance ..... 21
  - Parking ..... 148
  - Problem notification ..... 25
  - Raising ..... 357
  - Starting (emergency operation mode) ..... 130
  - Starting (smartphone) ..... 130
  - Starting (start/stop button) ..... 129
  - Switching off (start/stop button) ..... 141
  - Unlocking (from inside) ..... 60
  - Unlocking (KEYLESS-GO) ..... 60
  - Vehicle data ..... 372
  - Ventilating (convenience opening) ..... 71
- Vehicle data**
  - Displaying ..... 136
  - Roof load ..... 373
  - Trunk load ..... 373
  - Turning radius ..... 372
  - Vehicle height ..... 372
  - Vehicle length ..... 372
  - Vehicle width ..... 372
  - Wheelbase ..... 372
- Vehicle dimensions** ..... 372
- Vehicle electronics**
  - Notes ..... 362
  - Two-way radios ..... 362
- Vehicle identification number**  
see VIN
- Vehicle identification plate** ..... 364
  - Paint code ..... 364
  - VIN ..... 364
- Vehicle interior**
  - Cooling or heating (smartphone) ..... 129
- Vehicle operation**
  - Outside the USA or Canada ..... 21
- Vehicle tool kit**
  - TIREFIT kit ..... 316
- Ventilating**
  - Convenience opening ..... 71
- Ventilation**  
see Climate control
- Vents**  
see Air vents
- Video mode** ..... 283
  - Activating ..... 281
  - Activating/deactivating full-screen mode ..... 283
  - Overview ..... 282
  - Settings ..... 283
- VIN** ..... 364
  - Identification plate ..... 364
  - Seat ..... 364
- Visibility**
  - Defrosting the windows ..... 124
  - Windshield heater ..... 126
- Voice Control System** ..... 208
  - Application-specific command ..... 209
  - Audible help functions ..... 210

Command types .....	209
Entering numbers .....	210
Global command .....	209
Improving speech quality .....	210
Language setting .....	210
Media player commands .....	215
Message commands .....	216
Multifunction steering wheel (operating) .....	208
Navigation commands .....	212
Operable functions .....	209
Operating safety .....	208
Radio commands .....	215
Switch commands .....	210
Telephone commands .....	214
Text message commands .....	216
Vehicle commands .....	217
Voice prompting .....	209

**Voice control system**

see Voice Control System













**W****Warning lamp**







see Warning/indicator lamps

**Warning system**

see Anti-theft protection

**Warning/indicator lamp**

 ABS warning lamp .....	422
 Brake warning lamp (USA) .....	420
 Brakes warning lamp (Canada) ....	420
 Coolant warning lamp .....	431
 Distance warning lamp .....	428
 Electrical malfunction warning lamp .....	432
 Engine diagnosis warning lamp ...	430
 ESP® OFF warning lamp .....	424
 ESP® warning lamp flashes .....	423
 ESP® warning lamp lights up .....	423
 Fuel reserve warning lamp .....	432
 Power steering system warning lamp .....	429
 Red indicator lamp, electric parking brake applied (Canada only) ...	426

 Red indicator lamp, electric parking brake applied (USA only) .....	426
 Restraint system warning lamp ...	425
 Seat belt warning lamp flashes ...	427
 Seat belt warning lamp lights up .....	427
 Tire pressure monitoring system warning lamp flashes .....	434
 Tire pressure monitoring system warning lamp lights up .....	433
 Yellow electric parking brake indicator lamp is malfunctioning .....	426

**Warning/indicator lamps** .....

Instrument Display (overview) .....	8
Overview .....	417
PASSENGER AIRBAG .....	41

**Warranty** .....**Washer fluid**

see Windshield washer fluid

**Washing by hand (care)** .....

307

- Web browser**
- Calling up a website ..... 273
  - Calling up options ..... 274
  - Calling up settings ..... 274
  - Closing ..... 275
  - Deleting Internet favorites ..... 274
  - Deleting the Internet history ..... 274
  - Overview ..... 273
  - Setting Internet favorites ..... 274
- Website**
- Calling up ..... 273
- Wheel rotation** ..... 354
- Wheels**
- Care ..... 309
  - Changing ..... 356
  - Changing hub caps ..... 356
  - Checking ..... 332
  - Checking the tire pressure (manually) ..... 337
  - Checking the tire pressure (tire pressure monitoring system) ..... 338
  - Definitions ..... 349
  - DOT, Tire Identification Number (TIN) ..... 345
  - Flat tire ..... 314
  - Load index ..... 347
  - Load rating ..... 347
  - Maximum tire load ..... 346
  - Maximum tire pressure ..... 346
  - MOExtended tires ..... 315
  - Mounting ..... 359
  - Noise ..... 332
  - Notes on installing ..... 352
  - Overview of tire labeling ..... 344
  - Removing ..... 359
  - Replacing ..... 352
  - Restarting the tire pressure monitoring system ..... 339
  - Rotating ..... 354
  - Selection ..... 352
  - Snow chains ..... 333
  - Speed rating ..... 347
  - Storing ..... 355
  - Temperature grade ..... 344
  - Tire and Loading Information placard ..... 340
  - Tire characteristics ..... 347
  - Tire pressure (Notes) ..... 333
  - Tire pressure monitoring system (function) ..... 337
  - Tire pressure table ..... 335
  - Tire Quality Grading ..... 344
  - Tire size designation ..... 347
  - TIREFIT kit ..... 316
  - Traction grade ..... 344
  - Tread wear grade ..... 344
  - Unusual handling characteristics ..... 332
- Wi-Fi**
- Overview ..... 228
  - Setting ..... 229
  - Setting up a hotspot ..... 230
- Window airbag** ..... 37
- Windows**
- Closing ..... 70
  - Opening ..... 70
- Windows (Care)** ..... 309
- Windshield** ..... 117, 123
- Defrosting ..... 123
  - Infrared reflective ..... 122
  - Replacing the wiper blades ..... 117
- Windshield**
- see Windshield
- Windshield heater** ..... 126

**Windshield heating**

see Windshield heater

**Windshield washer fluid** ..... 370

Notes ..... 370

**Windshield washer system**

Refilling ..... 305

**Windshield wipers**

Activating/deactivating ..... 116

Replacing the wiper blades ..... 117

**Winter**

Snow chains ..... 333

**Winter operation**

Snow chains ..... 333

**Wiper blades**

Care ..... 309

Changing ..... 117

**Wireless vehicle components**

Declaration of Conformity ..... 23

