

Order no. 6522 0156 13
Part no. 453 584 17 03
Edition A-2016



4535841703

www.smart.com

smart - A Daimler brand

smart fortwo Operator's Manual



>> Operator's Manual

smart fortwo

Symbols

In this Operator's Manual you will find the following symbols:

WARNING

Warning notes make you aware of dangers which could pose a threat to your health or life, or to the health and life of others.

Environmental note

Environmental notes provide you with information on environmentally aware actions or disposal.

 Notes on material damage alert you to dangers that could lead to damage to your vehicle.

 Practical tips or further information that could be helpful to you.

▶ This symbol indicates an instruction that must be followed.

▶ Several of these symbols in succession indicate an instruction with several steps.

(▷ This symbol tells you where you can find more information about a topic.)

▷▷ This symbol indicates a warning or an instruction that is continued on the next page.

**Dis-
play** This text indicates a message on the multifunction display.

Publication details

Internet

Further information about smart vehicles and about Daimler AG can be found on the following websites:

<http://www.smart.com>

<http://www.daimler.com>

Editorial office

©Daimler AG: not to be reprinted, translated or otherwise reproduced, in whole or in part, without written permission from Daimler AG.

Vehicle manufacturer

Daimler AG
Mercedesstraße 137
70327 Stuttgart
Germany

Let the fun begin!

We urge you to read it carefully and familiarize yourself with the vehicle before driving. For your own safety and a longer vehicle life, follow the instructions and warning notices in this manual. Ignoring them could result in damage to the vehicle or personal injury to you or others.

The equipment or product designation of your vehicle may vary depending on:

- Model
- Order
- Country specification
- Availability

The illustrations in this manual show a left-hand-drive vehicle. On right-hand-drive vehicles, the layout of components and controls differs accordingly.

smart is constantly updating its vehicles to the state of the art.

smart therefore reserves the right to introduce changes in the following areas:

- Design
- Equipment
- Technical features

The equipment in your vehicle may therefore differ from that shown in the descriptions and illustrations.

The following are integral components of the vehicle:

- Operator's Manual
- Maintenance Booklet
- Equipment-dependent supplements

Keep printed copies of the documents in the vehicle at all times. If you sell the vehicle, always pass the documents on to the new owner.

Symbols	0	Operating the roller sunblind for the panoramic roof	61
Publication details	0	Seats, steering wheel and mirrors	62
Internet	0	Correcting the driver's seat position	62
Editorial office	0	Seats	62
Vehicle manufacturer	0	Steering wheel	66
Let the fun begin!	1	Mirrors	66
Index	4	Lights and windshield wipers	68
Introduction	17	Exterior lighting	68
Protection of the environment	17	Interior lighting	70
Genuine smart parts	17	Replacing bulbs	71
Operator's Manual	18	Windshield wipers	75
Service and vehicle operation	18	Climate control	79
Operating safety	19	Overview of climate control systems ...	79
QR codes for rescue card	21	Operating the climate control systems	80
Data stored in the vehicle	21	Setting the air vents	83
Information on copyright	23	Driving and parking	85
At a glance	24	Breaking-in notes	85
Dashboard	24	Driving	85
Instrument cluster	25	Manual transmission	89
Multifunction steering wheel	27	Automatic transmission	90
Center console	28	Refueling	95
Overhead control panel	29	Parking	97
Door control panel	30	Driving tips	99
Safety	31	Driving systems	103
Panic alarm	31	On-board computer and displays	106
Occupant safety	31	Important safety notes	106
Children in the vehicle	44	Displays and operation	106
Pets in the vehicle	48	Menus and sub menus	108
Protection against theft	48	Display messages	114
Driving safety systems	49	Warning and indicator lamps in the instrument cluster	127
Opening and closing	53	Stowage and features	138
SmartKey	53	Stowage areas	138
Doors	56	Features	142
Cargo compartment	58		
Side windows	59		

Maintenance and care	145
Checking service products	145
Maintenance	149
Care	150

Breakdown assistance	156
Where will I find...?	156
Flat tire	156
Battery (vehicle)	159
Jump-starting	162
Towing and tow-starting	165
Fuses	168

Wheels and tires	171
Important safety notes	171
Operation	171
Winter operation	172
Tire pressure	174
Loading the vehicle	179
All about wheels and tires	182
Changing a wheel	189
Wheel and tire combinations	193

Technical data	197
Information regarding technical data	197
Vehicle electronics	197
Identification plates	198
Service products and filling capacities	199
Vehicle data	204

1, 2, 3 ...

12 V socket

see Sockets

A**ABS (Anti-lock Braking System)**

Display message	117
Function/notes	49
Important safety notes	49
Warning lamp	130

Activating/deactivating cooling**with air dehumidification** 80**Additives (engine oil)** 202**Air bags**

Deployment	42
Front air bag (driver, front passenger)	37
Important safety notes	36
Introduction	35
Knee bag	37
Occupant Classification System (OCS)	38
PASSENGER AIR BAG indicator lamps	32
Window curtain air bag	38

Air pressure

see Tire pressure

Air vents

Important safety notes	83
Setting	83
Setting the center air vents	83
Setting the side air vents	84

Air-conditioning system

see Climate control

Airbag

Thorax/pelvisbag	37
Warning lamp	128

Alarm

Anti-theft alarm system	48
Switching off	48
Switching the function on/off	48

Ambient lighting

Setting the brightness	113
Switching on/off	113

Animals

see Pets in the vehicle

Anti-lock Braking System

see ABS (Anti-lock Braking System)

Anti-skid chains

see Snow chains

Anti-theft alarm system

Function	48
Switching off the alarm	48
Switching on/off	48

Ashtray 143**Assistance system**

see Driving systems

Authorized workshop

see Qualified specialist workshop

Automatic car wash (care) 151**Automatic headlamp mode** 68**Automatic transmission**

Accelerator pedal position	91
Changing gear	91
Display message (color display) ..	124
Drive program	92
Drive program display	90
Driving tips	91
Emergency running mode	95
Gearshift paddles	94
Kickdown	92
Malfunction (on-board computer with color display)	124
Manual shifting	92
Manually releasing the selector lever lock	95
Overview	90
Problem (malfunction)	95
Program selector button	92
Pulling away	87
Selector lever	90
Starting the engine	87
Transmission position display	90
Transmission positions	91

Automatic transmission emergency**mode** 95**B****Backup lamp**

Changing bulbs	74
----------------------	----

Battery (SmartKey)

Important safety notes	54
Replacing	54

- Battery (vehicle)**
 - Charging 161
 - Display message 120
 - Important safety notes 159
 - Jump starting 162
 - Warning and indicator lamps 133
 - Belt**
 - see Seat belts
 - Blower**
 - see Climate control
 - Brake fluid**
 - Display message 116
 - Notes 203
 - Brake force distribution**
 - see EBD (electronic brake force distribution)
 - Brake lamps**
 - Changing bulbs 74
 - Display message 124
 - Brake lights**
 - Display message (color display) .. 124
 - Brakes**
 - ABS 49
 - Brake fluid (notes) 203
 - EBD 52
 - Important safety notes 100
 - Maintenance 101
 - Parking brake 98
 - Riding tips 100
 - Warning lamp 128
 - Breakdown**
 - see Flat tire
 - see Towing away/tow-starting
 - Bulbs**
 - see Replacing bulbs
- C**
- Calling up a malfunction**
 - see Display messages
 - Car**
 - see Vehicle
 - Car key**
 - see SmartKey
 - Car wash**
 - see Care
 - Care**
 - Car wash 151
 - Carpets 155
 - Display 154
 - Exhaust pipe 154
 - Exterior lights 153
 - Gear or selector lever 155
 - General notes 150
 - Interior 154
 - Matte finish 152
 - Paint 152
 - Panoramic roof 152
 - Plastic trim 154
 - Power washer 151
 - Roof lining 155
 - Seat belt 155
 - Seat cover 155
 - Sensors 154
 - Steering wheel 155
 - Washing by hand 151
 - Wheels 153
 - Windows 153
 - Wiper blades 153
 - Center console** 28
 - Central locking**
 - Locking/unlocking (SmartKey) 53
 - Changing bulbs**
 - Brake lamps 74
 - Front fog lamp 73
 - High-beam headlamps 73
 - Low-beam headlamps 73
 - Rear fog lamp 74
 - Reversing lamps 74
 - Tail lamps 74
 - Turn signals (front) 72
 - Turn signals (rear) 74
 - Child seat**
 - Forward-facing restraint system 47
 - On the front-passenger seat 47
 - Rearward-facing restraint system 47
 - Top Tether 46
 - Children**
 - Restraint systems 45
 - Special seat belt retractor 45
 - Cleaning**
 - see Care
 - Climate control**
 - Automatic climate control 79

- Controlling automatically 80
 - Cooling with air dehumidification 80
 - Defrosting the windows 82
 - Defrosting the windshield 81
 - General notes 79
 - Notes on using the automatic climate control 80
 - Overview of systems 79
 - Problem with the rear window defroster 82
 - Refrigerant 204
 - Setting the air distribution 81
 - Setting the air vents 83
 - Setting the airflow 81
 - Setting the temperature 81
 - Switching air-recirculation mode on/off 82
 - Switching on/off 80
 - Switching the rear window defroster on/off 82
 - Cockpit**
 - Overview 24
 - Constant headlamp mode**
 - see Daytime running lamps
 - Consumption statistics (on-board computer)** 109
 - Controlling speed**
 - see Cruise control
 - Coolant**
 - Battery cooling system 148
 - Checking the level 149
 - Drive system cooling system 148
 - General notes 203
 - Important safety notes 148
 - Setting the temperature unit 113
 - Temperature display 109
 - Topping up 149
 - Warning lamp 134
 - Coolant (engine)**
 - Display message 121
 - Cooling**
 - see Climate control
 - Copyright** 23
 - Cover (front)**
 - see Service cover
 - Crosswind Assist** 52
 - Cruise control**
 - Activating 103
 - Buttons 103
 - Calling up the speed last stored .. 104
 - Canceling cruise control 104
 - Deactivating 104
 - Display message (color display) .. 122
 - Driving systems 103
 - Function/notes 103
 - General notes 103
 - Important safety notes 103
 - Increasing/decreasing the speed 104
 - Storing and maintaining current speed 103
 - Cup holder**
 - Center console 142
 - Center console in the rear compartment 142
 - Important safety notes 142
 - Cup holder**
 - see Cup holder
 - Customer Assistance Center (CAC)** 21
 - Customer Relations Department** 21
- D**
- Dashboard**
 - Additional instruments 107
 - Dashboard**
 - see Cockpit
 - Dashboard clock** 107
 - Data**
 - see Technical data
 - Daytime running lamps**
 - Function/notes 68
 - Dealership**
 - see Qualified specialist workshop
 - Declarations of conformity** 20
 - Diagnostics connection** 20
 - Digital speedometer**
 - Display 106
 - Setting the display 112
 - Display**
 - Color 108
 - Menu (on-board computer with a color display) 111
 - Display (cleaning instructions)** 154

- Display message**
 - Calling up (message memory) 110
 - Color display 114
 - Language setting 113
 - Service display 149
 - Display messages**
 - Calling up (on-board computer) ... 110
 - Driving systems 122
 - Engine 120
 - General notes (on-board computer with a color display) 114
 - Hiding 114
 - Lights 124
 - Safety systems 115
 - SmartKey 126
 - Tires 122
 - Vehicle 124
 - Distance recorder** 109
 - Distance warning function**
 - Function/notes 50
 - Warning lamp (red) 132
 - Warning lamp (yellow) 131
 - Door**
 - Warning lamp 137
 - Doors**
 - Automatic locking (switch) 57
 - Central locking/unlocking (SmartKey) 53
 - Control panel 30
 - Display message 124
 - Emergency locking 57
 - Emergency unlocking 57
 - Important safety notes 56
 - Opening (from inside) 56
 - Drinking and driving** 100
 - Drive program**
 - Automatic transmission 92
 - Display 90
 - Driver's door**
 - see Doors
 - Driver's seat**
 - see Seats
 - Driving abroad**
 - smart service 150
 - Driving on flooded roads** 102
 - Driving safety systems**
 - ABS (Anti-lock Braking System) 49
 - Distance warning function 50
 - EBD (electronic brake force distribution) 52
 - ESP® (Electronic Stability Program) 51
 - ETS (Electronic Traction System) 51
 - Important safety information 49
 - Overview 49
 - Driving system**
 - Parking aid 104
 - Driving systems**
 - Cruise control 103
 - Display message 122
 - Driving tips**
 - Automatic transmission 91
 - Brakes 100
 - Break-in period 85
 - Downhill gradient 100
 - Drinking and driving 100
 - Driving in winter 102
 - Driving on flooded roads 102
 - Driving on wet roads 102
 - Exhaust check 100
 - Fuel 100
 - General 99
 - Hydroplaning 102
 - Icy road surfaces 102
 - Limited braking efficiency on salted roads 101
 - Snow chains 173
 - Subjecting brakes to a load 100
 - Wet road surface 101
- E**
- EBD (electronic brake force distribution)**
 - Display message 116
 - Function/notes 52
 - EBD (Electronic Brake-force Distribution)**
 - Indicator lamp 129
 - Electronic Brake-force Distribution**
 - see EBD (electronic brake force distribution)
 - Electronic Traction System**
 - see ETS (Electronic Traction System)

- Emergency release**
 - Driver's door 57
 - Vehicle 57
 - Emergency Tensioning Devices**
 - Activation 42
 - Emissions control**
 - Service and warranty information 18
 - Engine**
 - Check Engine warning lamp 132
 - Display message 120
 - Engine number 199
 - Irregular running 88
 - Jump-starting 162
 - Starting problems 88
 - Starting the engine with the SmartKey 87
 - Switching off 98
 - Tow-starting (vehicle) 167
 - Engine compartment cover** 145
 - Engine electronics**
 - Problem (malfunction) 88
 - Engine oil**
 - Adding 146
 - Additives 202
 - Checking the oil level 146
 - Display message 120
 - Filling capacity 202
 - Notes about oil grades 202
 - Notes on oil level/consumption .. 145
 - Viscosity 202
 - Warning lamp 134
 - Engine oil additives**
 - see Additives (engine oil)
 - ESP® (Electronic Stability Program)**
 - Characteristics 51
 - Crosswind Assist 52
 - Display message 117
 - ETS 51
 - Function/notes 51
 - General notes 51
 - Important safety information 51
 - Warning and indicator lamps 130
 - ETS (Electronic Traction System)** 51
 - Exhaust check** 100
 - Exhaust pipe (cleaning instructions)** 154
 - Exterior lighting**
 - Cleaning 153
 - Setting options 68
 - Exterior mirrors**
 - Adjusting (electrically) 67
 - Adjusting (manually) 67
 - Out of position (troubleshooting) 67
- F**
- Filler cap**
 - see Refueling
 - Filling capacities (Technical data)** .. 199
 - Flat tire**
 - Preparing the vehicle 156
 - TIREFIT kit 156
 - Floormats** 144
 - Fog lamps**
 - Switching on/off 69
 - Frequencies**
 - Mobile phone 197
 - Two-way radio 197
 - Front cover**
 - see Service cover
 - Front fog lamps**
 - Changing bulbs 73
 - Switching on/off 69
 - Front-passenger seat**
 - Folding down 64
 - Frontal area cover**
 - see Service cover
 - Fuel**
 - Additives 201
 - Consumption information 201
 - Displaying the current consumption 109
 - Driving tips 100
 - Fuel gauge 107
 - Grade (gasoline) 200
 - Important safety notes 200
 - Problem (malfunction) 97
 - Refueling 95
 - Tank content/reserve fuel 200
 - Fuel filler flap**
 - Opening 96
 - Fuel tank**
 - Capacity 200

- Problem (malfunction) 97
- Fuses**
- Allocation 169
 - Before changing 168
 - Dashboard fuse box 168
 - Important safety notes 168
- Fuses**
- see Fuses
- G**
- Gasoline** 200
- Gear or selector lever (cleaning guidelines)** 155
- Genuine parts** 17
- Glove box** 139
- H**
- Handbrake**
- see Parking brake
- Hands-free system**
- see Mobile phone
- Hazard warning lamps** 70
- Headlamps**
- Fogging up 70
 - see Automatic headlamp mode
- Heating**
- see Climate control
- High beam flasher** 70
- High-beam headlamps**
- Changing bulbs 73
 - Switching on/off 69
- Hill start assist** 87
- Hydroplaning** 102
- I**
- Ignition key**
- see SmartKey
- Ignition lock**
- see Key positions
- Immobilizer** 48
- Indicator lamps**
- see Warning and indicator lamps
- Instrument cluster**
- Overview 25
 - Warning and indicator lamps 26
- Instrument cluster lighting**
- Adjusting 111
 - Notes 106
- Instrument lighting**
- see Instrument cluster lighting
- Interior lighting** 70
- Automatic control 70
 - Overview 70
 - Reading lamp 70
 - Replacing bulbs 75
 - Setting the ambient lighting 113
 - Setting the brightness of the ambient lighting (on-board computer) 113
- Intermittent wiping** 76
- J**
- Jack**
- Using 190
- Jump start (engine)**
- see Jump starting (engine)
- Jump starting (engine)** 162
- K**
- Key**
- Display message 126
- Kickdown**
- Driving tips 92
 - Manual gearshifting 94
- Knee bag** 37
- L**
- Lamps**
- see Warning and indicator lamps
- Language (on-board computer)** 113
- License plate lighting**
- Replacing 74
- Light sensor (display message)** 126
- Lighting**
- Setting the ambient lighting 113
- Lights**
- Automatic headlamp mode 68
 - Display message 124
 - Fog lamps 69
 - Hazard warning lamps 70
 - High beam flasher 70

- High-beam headlamps 69
 - Light switch 68
 - Low-beam headlamps 68
 - Parking lamps 69
 - Rear fog lamp 69
 - Setting the brightness of the ambient lighting (on-board computer) 113
 - Turn signals 69
 - see Interior lighting
 - see Replacing bulbs
 - Loading guidelines** 138
 - Locking**
 - see Central locking
 - Locking (doors)**
 - Automatic 57
 - Emergency locking 57
 - From inside (central locking button) 56
 - Locking centrally**
 - see Central locking
 - Loudspeaker**
 - see Subwoofer
 - Low-beam headlamps**
 - Changing bulbs 73
 - Switching on/off 68
 - Lubricant additives**
 - see Additives (engine oil)
- M**
- M+S tires (winter tires)** 173
 - Malfunction message**
 - see Display messages
 - Manual transmission**
 - Engaging reverse gear 89
 - Gear lever 89
 - Malfunction (on-board computer with a color display) 126
 - Pulling away 87
 - Shift recommendation 89
 - Shifting to neutral 89
 - Starting the engine 87
 - Manually releasing the selector lever lock (automatic transmission)** .. 95
 - Matte finish (cleaning instructions)** 152
 - Message memory (color display)** 110
 - Message memory (on-board computer)** 110
 - Messages**
 - see Display messages
 - Mirrors**
 - see Exterior mirrors
 - see Rear-view mirror
 - Mobile phone**
 - Frequencies 197
 - Installation 197
 - Transmission output (maximum) ... 197
 - Model series**
 - see Vehicle identification plate
 - Mounting wheels**
 - Lowering the vehicle 193
 - Mounting a new wheel 192
 - Preparing the vehicle 190
 - Raising the vehicle 190
 - Removing a wheel 192
 - Securing the vehicle against rolling away 190
 - Multi-functional seat**
 - see Seats
 - Multifunction steering wheel**
 - Overview 27
- N**
- Notes on breaking-in a new vehicle** ... 85
- O**
- Occupant Classification System (OCS)**
 - Conditions 38
 - Faults 41
 - Operation 39
 - System self-test 40
 - Occupant safety**
 - Children in the vehicle 44
 - Important safety notes 31
 - Introduction to the restraint system 31
 - Occupant Classification System (OCS) 38
 - PASSENGER AIR BAG indicator lamps 32
 - Pets in the vehicle 48
 - Restraint system warning lamp 31

- Seat belt 32
 - OCS**
 - Conditions 38
 - Faults 41
 - Operation 39
 - System self-test 40
 - Odometer** 109
 - Oil**
 - see Engine oil
 - On-board computer**
 - Displaying a service message 150
 - Important safety notes 106
 - Menu overview 108
 - Message memory 110
 - Messages menu 110
 - Operating (color display) 107
 - Operation 107
 - Selecting the language 113
 - Service menu 110
 - Settings menu 110
 - Submenu display 111
 - On-board diagnostic interface**
 - see Diagnostics connection
 - Operating safety**
 - Declaration of conformity 20
 - Important safety notes 19
 - Operating system**
 - see On-board computer
 - Operator's Manual**
 - Vehicle equipment 18
 - Outside temperature display**
 - Notes 106
 - Setting the units 113
 - Overhead control panel** 29
 - Overrevving range** 107
- P**
- Paint code number** 198
 - Paintwork (cleaning instructions)** 152
 - Panic alarm** 31
 - Panoramic roof**
 - Cleaning 152
 - Operating the roller sunblind 61
 - Park brake**
 - see Parking brake
 - Parking** 97
 - Important safety notes 97
 - Parking brake 98
 - Switching off the engine 98
 - Parking brake**
 - Display message 115
 - Notes/function 98
 - Warning lamp 128
 - Parking lamps**
 - Switching on and off 69
 - PASSENGER AIR BAG**
 - Indicator lamps 32
 - Pets in the vehicle** 48
 - Plastic trim (cleaning instructions)** 154
 - Power washers** 151
 - Power windows**
 - see Side windows
 - Program selector button** 92
 - Protection against theft**
 - Anti-theft alarm system 48
 - Immobilizer 48
 - Protection of the environment**
 - General notes 17
 - Pulling away**
 - Automatic transmission 87
 - General notes 87
 - Manual transmission 87
- Q**
- QR code**
 - Rescue card 21
 - Qualified specialist workshop** 21
- R**
- Radio-wave reception/transmission in the vehicle**
 - Declaration of conformity 20
 - Rain and light sensor (display message)** 126
 - Reading lamp** 70
 - Rear fog lamp**
 - Changing bulbs 74
 - Switching on/off 69
 - Rear lamps**
 - Changing bulbs 74
 - Rear parking aid**
 - Activating/deactivating 105

- Function/notes 104
 - Rear window defroster**
 - Problem (malfunction) 82
 - Switching on/off 82
 - Rear window wiper**
 - Replacing the wiper blade 77
 - Switching on/off 76
 - Rear-view mirror**
 - Anti-glare (manual) 66
 - Recycling**
 - see Protection of the environment
 - Refrigerant (air-conditioning system)**
 - Important safety notes 204
 - Refueling**
 - Fuel gauge 107
 - Important safety notes 95
 - Refueling process 96
 - see Fuel
 - Replacing bulbs**
 - Important safety notes 71
 - Interior lighting 75
 - Overview of bulb types 71
 - Removing/replacing the cover (front wheel arch) 72
 - Side turn signal lamps 73
 - Rescue card** 21
 - Reserve (fuel tank)**
 - see Fuel
 - Reserve fuel**
 - Display message 121
 - see Fuel
 - Restraint system**
 - Display message 115
 - Introduction 31
 - Warning lamp 128
 - Warning lamp (function) 31
 - Reverse gear**
 - Engaging (manual transmission) ... 89
 - Reversing feature**
 - Side windows 59
 - Roadside Assistance (breakdown)** 18
 - Roller sunblind for the panorama roof**
 - Operating 61
 - Roof**
 - see Panoramic roof
 - Roof lining and carpets (cleaning guidelines)** 155
- S**
- Safety**
 - Child restraint systems 45
 - Children in the vehicle 44
 - see Operating safety
 - Safety system**
 - see Driving safety systems
 - Seat**
 - Folding the front-passenger seat down 64
 - Seat belts**
 - Cleaning 155
 - Correct usage 34
 - Fastening 34
 - Important safety guidelines 33
 - Introduction 32
 - Releasing 35
 - Warning lamp 127
 - Warning lamp (function) 35
 - Seats**
 - Adjusting (manually) 63
 - Cleaning the cover 155
 - Correct driver's seat position 62
 - Important safety notes 62
 - Seat heating problem 65
 - Switching seat heating on/off 65
 - Sensors (cleaning instructions)** 154
 - Service Center**
 - see Qualified specialist workshop
 - Service cover** 147
 - Service display**
 - Calling up (on-board computer with a color display) 110
 - Displaying a service message 150
 - Hiding a service message 150
 - Notes 149
 - Resetting 150
 - Service message 149
 - Special service requirements 150
 - Service products**
 - Brake fluid 203
 - Coolant (engine) 203
 - Engine oil 202
 - Fuel 200

- Important safety notes 199
 - Refrigerant (air-conditioning system) 204
 - Washer fluid 203
 - Setting a speed**
 - see Cruise control
 - Setting the air distribution** 81
 - Setting the airflow** 81
 - Shifting to neutral (manual transmission)** 89
 - Side turn signal lamps**
 - Replacing bulbs 73
 - Side windows**
 - Cleaning 153
 - Important safety information 59
 - Opening/closing 60
 - Problem (malfunction) 61
 - Resetting 60
 - smart center**
 - see Qualified specialist workshop
 - SmartKey**
 - Changing the battery 54
 - Door central locking/unlocking 53
 - Important safety notes 53
 - Loss 55
 - Positions (ignition lock) 86
 - Problem (malfunction) 55
 - Starting the engine 87
 - SmartKey positions (ignition lock)** 86
 - Snow chains** 173
 - Sockets**
 - Center console 143
 - General notes 143
 - Speakers**
 - see Subwoofer
 - Special seat belt retractor** 45
 - Specialist workshop** 21
 - Speedometer**
 - Digital 106
 - In the Instrument cluster 106
 - SRS (Supplemental Restraint System)**
 - see Restraint system
 - Starting (engine)** 86
 - Starting the engine**
 - see Starting (engine)
 - Steering**
 - Display message (color display) .. 124
 - Warning lamps 137
 - Steering wheel**
 - Adjusting (manually) 66
 - Button overview 27
 - Cleaning 155
 - Important safety notes 66
 - Paddle shifters 94
 - Stowage areas** 138
 - Stowage compartment**
 - Door stowage compartment 139
 - Stowage compartment in the tailgate** 139
 - Stowage compartments**
 - Center console 139
 - Cup holders 142
 - Glove box 139
 - Important safety information 138
 - Stowage space**
 - Stowage compartment in the tailgate 139
 - Submenu**
 - Ambient lighting 113
 - Subwoofer**
 - Fitting/removing 141
 - Summer tires**
 - In winter 173
 - Sun visor** 143
 - Switching air-recirculation mode on/off** 82
- T**
- Tachometer** 107
 - Tailgate**
 - Important safety notes 58
 - Opening dimensions 204
 - Opening/closing 58
 - Warning lamp 137
 - Tank**
 - see Fuel tank
 - Tank content**
 - Fuel gauge 107
 - Technical data**
 - Capacities 199
 - Information 197
 - Tires/wheels 193

- Vehicle data 204
- Temperature**
- Coolant 109
- Outside temperature 106
- Setting (climate control) 81
- Setting the display units 113
- Thorax/pelvisbag** 37
- Time**
- Setting 111
- Setting (dashboard clock) 107
- Setting the time format (on-board computer with a color display) 111
- Tire pressure**
- Checking manually 177
- Display message 122
- Important safety notes 177
- Maximum 176
- Not reached (TIREFIT) 158
- Notes 175
- Reached (TIREFIT) 158
- Recommended 174
- Tire pressure monitor**
- Function/notes 177
- General notes 177
- Important safety notes 177
- Restarting (on-board computer with color display) 179
- Warning lamp 135
- Warning message 178
- TIREFIT kit** 156
- Tires**
- Aspect ratio (definition) 188
- Average weight of the vehicle occupants (definition) 187
- Bar (definition) 187
- Changing a wheel 189
- Characteristics 187
- Checking 171
- Curb weight (definition) 188
- Definition of terms 187
- Direction of rotation 190
- Display message 122
- Distribution of the vehicle occupants (definition) 189
- DOT (Department of Transportation) (definition) 187
- DOT, Tire Identification Number (TIN) 186
- GAWR (Gross Axle Weight Rating) (definition) 188
- General notes 193
- GVW (Gross Vehicle Weight) (definition) 188
- GVWR (Gross Vehicle Weight Rating) (definition) 188
- Important safety notes 171
- Increased vehicle weight due to optional equipment (definition) 187
- Kilopascal (kPa) (definition) 188
- Labeling (overview) 184
- Load bearing index (definition) .. 189
- Load index 186
- Load index (definition) 188
- M+S tires (winter tires) 173
- Maximum load on a tire (definition) 188
- Maximum loaded vehicle weight (definition) 188
- Maximum permissible tire pressure (definition) 188
- Maximum tire load 186
- Maximum tire load (definition) ... 188
- Optional equipment weight (definition) 189
- PSI (pounds per square inch) (definition) 188
- Replacing 189
- Service life 172
- Sidewall (definition) 189
- Snow chains 173
- Speed rating (definition) 188
- Storing 190
- Structure and characteristics (definition) 187
- Summer tires in winter 173
- Temperature 183
- TIN (Tire Identification Number) (definition) 189
- Tire bead (definition) 189
- Tire pressure (definition) 188
- Tire pressures (recommended) 187
- Tire size (data) 193

- Tire size designation, load-bearing capacity, speed rating ... 184
 - Tire tread 172
 - Tire tread (definition) 189
 - Total load limit (definition) 189
 - Traction 183
 - Traction (definition) 189
 - Tread wear 183
 - Uniform Tire Quality Grading Standards 182
 - Uniform Tire Quality Grading Standards (definition) 187
 - Wear indicator (definition) 189
 - Wheel and tire combination 195
 - Wheel rim (definition) 188
 - see Flat tire
 - Tool**
 - see Vehicle tool kit
 - Top Tether** 46
 - Total distance recorder**
 - Setting the display unit 112
 - Tow-starting**
 - Emergency engine starting 167
 - Important safety notes 165
 - Towing away**
 - Important safety guidelines 165
 - Installing the towing eye 166
 - Removing the towing eye 166
 - With both axles on the ground 166
 - With the rear axle raised 166
 - Transmission**
 - see Automatic transmission
 - see Manual transmission
 - Transmission position display** 90
 - Transporting the vehicle** 167
 - Trip computer (on-board computer)** .. 109
 - Trip meter**
 - Setting the display unit 112
 - Setting the display units 112
 - Trip odometer**
 - Calling up 109
 - Trunk**
 - Fitting the cover 140
 - Installing/removing the cover 141
 - see Tailgate
 - Trunk (front)**
 - see Service cover
 - Turn signals**
 - Changing bulbs (front) 72
 - Changing bulbs (rear) 74
 - Switching on/off 69
 - Turn signals**
 - see Turn signals
 - Two-way radio**
 - Frequencies 197
 - Installation 197
 - Transmission output (maximum) ... 197
 - Type identification plate**
 - see Vehicle identification plate
- U**
- Unlocking**
 - Emergency unlocking 57
 - From inside the vehicle (central unlocking button) 56
- V**
- Vehicle**
 - Correct use 21
 - Data acquisition 21
 - Electronics malfunction (display message) 126
 - Electronics malfunction (warning lamp) 137
 - Equipment 18
 - Loading 179
 - Locking (in an emergency) 57
 - Locking (SmartKey) 53
 - Lowering 193
 - Maintenance 18
 - Parking for a long period 99
 - Pulling away 87
 - Raising 190
 - Reporting problems 21
 - Securing from rolling away 190
 - Tow-starting 165
 - Towing away 165
 - Transporting 167
 - Unlocking (in an emergency) 57
 - Unlocking (SmartKey) 53
 - Vehicle data 204
 - Vehicle battery**
 - see Battery (vehicle)
 - Vehicle data** 204

- Vehicle dimensions** 204
 - Vehicle emergency locking** 57
 - Vehicle identification number**
see VIN
 - Vehicle identification plate** 198
 - Vehicle key**
see SmartKey
 - Vehicle tool kit** 156
 - Ventilation**
see Climate control
 - VIN** 198
- W**
- Warning and indicator lamps**
 - ABS 130
 - Airbag 128
 - Battery 133
 - Brakes 128
 - Check Engine 132
 - Coolant 134
 - Distance warning function (red) .. 132
 - Distance warning function (yellow) 131
 - Door 137
 - EBD 129
 - Electronics 137
 - ESP® 130
 - Oil pressure 134
 - Overview 26
 - Parking brake 128
 - PASSENGER AIR BAG 32
 - Restraint system 128
 - Seat belt 127
 - Steering 137
 - Tire pressure monitor 135
 - Warranty** 18
 - Wheel and tire combination**
see Tires
 - Wheel bolt tightening torque** 193
 - Wheels**
 - Changing a wheel 189
 - Checking 171
 - Cleaning 153
 - General notes 193
 - Important safety notes 171
 - Interchanging/changing 189
 - Mounting a new wheel 192
 - Mounting a wheel 190
 - Removing a wheel 192
 - Snow chains 173
 - Storing 190
 - Tightening torque 193
 - Wheel size/tire size 193
 - Window curtain air bag**
 - Operation 38
 - Windows**
see Side windows
 - Windscreen**
see Windshield
 - Windshield**
 - Defrosting 81
 - Windshield washer fluid**
see Windshield washer system
 - Windshield washer system**
 - Adding washer fluid 149
 - Important safety notes 203
 - Windshield wipers**
 - Intermittent wiping 76
 - Problem (malfunction) 78
 - Rear window wiper 76
 - Replacing the wiper blades 76
 - Switching on/off 75
 - Winter driving**
 - Slippery road surfaces 102
 - Snow chains 173
 - Winter operation**
 - General notes 172
 - Winter tires**
 - M+S tires 173
 - Wiper blades**
 - Cleaning 153
 - Important safety notes 76
 - Replacing (rear window) 77
 - Replacing (windshield) 76
 - Workshop**
see Qualified specialist workshop

Protection of the environment

General notes

Environmental note

Daimler's declared policy is one of comprehensive environmental protection.

The objectives are for the natural resources that form the basis of our existence on this planet to be used sparingly and in a manner that takes the requirements of both nature and humanity into account.

You too can help to protect the environment by operating your vehicle in an environmentally responsible manner.

Fuel consumption and the rate of engine, transmission, brake and tire wear are affected by these factors:

- operating conditions of your vehicle
- your personal driving style

You can influence both factors. You should bear the following in mind:

Operating conditions:

- avoid short trips as these increase fuel consumption.
- always make sure that the tire pressures are correct.
- do not carry any unnecessary weight.
- a regularly serviced vehicle will contribute to environmental protection. You should therefore adhere to the service intervals.
- Always have service work carried out at a qualified specialist workshop.

Personal driving style:

- do not depress the accelerator pedal when starting the engine.
- do not warm up the engine when the vehicle is stationary.
- drive carefully and maintain a safe distance from the vehicle in front.
- avoid frequent, sudden acceleration and braking.

- change gear in good time and use each gear only up to $\frac{2}{3}$ of its maximum engine speed.
- switch off the engine in stationary traffic.
- keep an eye on the vehicle's fuel consumption.

Environmental concerns and recommendations

Wherever the operating instructions require you to dispose of materials, first try to regenerate or re-use them. Observe the relevant environmental rules and regulations when disposing of materials. In this way you will help to protect the environment.

Genuine smart parts

Environmental note

Daimler AG also supplies reconditioned major assemblies and parts which are of the same quality as new parts. They are covered by the same Limited Warranty entitlements as new parts.

 Air bags and Emergency Tensioning Devices, as well as control units and sensors for these restraint systems, may be installed in the following areas of your vehicle:

- doors
- door pillars
- door sills
- seats
- cockpit
- instrument cluster
- center console

Do not install accessories such as audio systems in these areas. Do not carry out repairs or welding. You could impair the operating efficiency of the restraint systems.

Have aftermarket accessories installed at a qualified specialist workshop.

You could jeopardize the operating safety of your vehicle if you use parts, tires and wheels

as well as accessories relevant to safety which have not been approved by smart. This could lead to malfunctions in safety-relevant systems, e.g. the brake system. Use only genuine smart parts or parts of equal quality. Only use tires, wheels and accessories that have been specifically approved for your vehicle.

Genuine smart parts are subject to strict quality control. Each part has been specially developed, manufactured or selected for smart vehicles and fine-tuned for them. Therefore, only genuine smart parts should be used.

More than 300,000 different genuine smart parts are available for smart models.

All smart centers maintain a supply of genuine smart parts for necessary service and repair work. In addition, strategically located parts delivery centers provide quick and reliable parts service.

Always specify the vehicle identification number (VIN) (> page 198) when ordering genuine smart parts.

Operator's Manual

Vehicle equipment

i This Operator's Manual describes all models and all standard and optional equipment of your vehicle available at the time of going to print. Country-specific differences are possible. Bear in mind that your vehicle may not feature all functions described here. This also applies to safety-relevant systems and functions. The equipment in your vehicle may therefore differ from that shown in the descriptions and illustrations.

The original purchase agreement lists all systems installed in your vehicle.

Should you have any questions concerning equipment and operation, please consult a smart center.

The Operator's Manual and Maintenance Booklet are important documents and should be kept in the vehicle.

Service and vehicle operation

Warranty

The smart USA Warranty booklet (USA only) or the Warranty booklet (Canada only) contains detailed information about the warranties covering your smart, including:

- smart USA Limited Warranty (USA only)
- New Vehicle Limited Warranty (Canada only)
- Emission System Warranty
- Emission Performance Warranty
- warranty against perforation through corrosion
- California, Connecticut, Maine, Massachusetts, New York, Pennsylvania, Rhode Island and Vermont Emission Control System Warranty
- smartmove Assistance (Canada only)
- State warranty enforcement laws (Lemon Laws)

Maintenance

The Service and Warranty Booklet describes all the necessary maintenance work which should be done at regular intervals.

Always bring the Service and Warranty Information Booklet with you when bringing the vehicle to an authorized smart center. The service advisor will record every service for you in the Service and Warranty Booklet.

Roadside Assistance

The smartmove Assistance (Canada) and smart 1 service (USA) Program provides factory trained technical help in the event of a breakdown. Calls to the toll-free Roadside Assistance number

1-800-762-7887 (in USA)

1-877-627-8004 (in Canada)

will be answered by smart Customer Assistance Representatives 24 hours a day, 365 days a year. In accordance with standard program guidelines, Roadside Assistance provides vehicle service up to a reasonable distance from the next paved road. We will make every effort to assist in a breakdown situation; however, the accessibility of your vehicle

will be determined by our authorized smart center technical help or the tow service provider on a case-by-case basis. Additional charges may be applicable for a breakdown location determined not to be a reasonably accessible roadside location as determined by our authorized technician and tow service provider.

For additional information refer to the smart Roadside Assistance Program brochure (USA) or the Warranty Booklet (Canada) in your vehicle literature portfolio.

Change of address or change of ownership

In the USA: If you change your address, be sure to send in the "Information Change Card" found in the Warranty Information Booklet.

In Canada: If you change your address, be sure to send in the "Change of Address Notice" found in the Warranty Booklet, or simply call the Customer Service at 1-800-387-0100.

Maintaining your current address information with smart will enable us to contact you should important new information about the vehicle, such as recalls, become available.

If you sell your smart, please leave all literature with the vehicle to make it available to the next operator.

In the USA: If you bought this vehicle used, be sure to send in the "Information Change Card" found in the Warranty Information Booklet.

In Canada: If you bought this vehicle used, be sure to send in the "Notice of Pre-Owned Vehicle Purchase" found in the Warranty Booklet, or call the Customer Service at 1-800-387-0100.

Operating your vehicle outside the USA or Canada

When you are abroad with your vehicle, observe the following points:

- Service facilities or replacement parts may not be readily available.
- Unleaded gasoline for vehicles with catalytic converters may not be available; the

use of leaded fuels will damage the catalysts.

- Gasoline may have a considerably lower octane rating, and improper fuel can cause engine damage.

Operating safety

Important safety notes

WARNING

If you do not have the prescribed service/maintenance work or any required repairs carried out, this can result in malfunctions or system failures. There is a risk of an accident.

Always have the prescribed service/maintenance work as well as any required repairs carried out at a qualified specialist workshop.

WARNING

Flammable material such as leaves, grass or twigs may ignite if they come into contact with hot parts of the exhaust system. There is a risk of fire.

When driving off road or on unpaved roads, check the vehicle's underside regularly. In particular, remove parts of plants or other flammable materials which have become trapped. In the case of damage, contact a qualified specialist workshop.

WARNING

Modifications to electronic components, their software as well as wiring can impair their function and/or the function of other networked components. In particular, systems relevant to safety could also be affected. As a result, these may no longer function as intended and/or jeopardize the operating safety of the vehicle. There is an increased risk of an accident and injury.

Never tamper with the wiring as well as electronic components or their software. You should have all work to electrical and

electronic equipment carried out at a qualified specialist workshop.

If you make any changes to the vehicle electronics, the general operating permit is rendered invalid.

! There is a risk of damage to the vehicle if:

- the vehicle becomes stuck, e.g. on a high curb or an unpaved road
- you drive too fast over an obstacle, e.g. a curb or a hole in the road
- a heavy object strikes the undercarriage or parts of the chassis

In situations like this, the body, the undercarriage, chassis parts, wheels or tires could be damaged without the damage being visible. Components damaged in this way can unexpectedly fail or, in the case of an accident, no longer withstand the strain they are designed to.

If the underbody paneling is damaged, combustible materials such as leaves, grass or twigs can gather between the underbody and the underbody paneling. If these materials come in contact with hot parts of the exhaust system, they can catch fire.

In such situations, have the vehicle checked and repaired immediately at a qualified specialist workshop. If on continuing your journey you notice that driving safety is impaired, pull over and stop the vehicle immediately, paying attention to road and traffic conditions. In such cases, consult a qualified specialist workshop.

Declarations of conformity

Vehicle components which receive and/or transmit radio waves

USA: "The wireless devices of this vehicle comply with Part 15 of the FCC Rules. Operation is subject to the following two conditions: 1) These devices may not cause harmful interference, and 2) These devices must accept any interference received, including interference that may cause undesired operation. Changes or modifications not expressly approved by the party responsible

for compliance could void the user's authority to operate the equipment."

Canada: "The wireless devices of this vehicle comply with Industry Canada license-exempt RSS standard(s). Operation is subject to the following two conditions: (1) These devices may not cause interference, and (2) These devices must accept any interference, including interference that may cause undesired operation of the device."

Diagnostics connection

The diagnostics connection is only intended for the connection of diagnostic equipment at a qualified specialist workshop.

WARNING

If you connect equipment to the diagnostics connection in the vehicle, it may affect the operation of the vehicle systems. As a result, the operating safety of the vehicle could be affected. There is a risk of an accident.

Do not connect any equipment to a diagnostics connection in the vehicle.

WARNING

Objects in the driver's footwell can restrict the pedal travel or obstruct a depressed pedal. The operating and road safety of the vehicle is jeopardized. There is a risk of an accident.

Make sure that all objects in the vehicle are stowed correctly, and that they cannot enter the driver's footwell. Install the floor mats securely and as specified in order to ensure sufficient clearance for the pedals. Do not use loose floor mats and do not place floor mats on top of one another.

! If the engine is switched off and equipment on the diagnostics connection is used, the starter battery may discharge.

Connecting equipment to the diagnostics connection can lead to emissions monitoring information being reset, for example. This may lead to the vehicle failing to meet the

requirements of the next emissions test during the main inspection.

Qualified specialist workshop

A smart center is a qualified specialist workshop. It has the necessary specialist knowledge, tools and qualifications to correctly carry out the work required on your vehicle. This is especially the case for work relevant to safety.

Observe the notes in the Maintenance Booklet.

Always have the following work carried out at a smart center:

- work relevant to safety
- service and maintenance work
- repair work
- alterations, installation work and modifications
- work on electronic components

Correct use

If you remove any warning stickers, you or others could fail to recognize certain dangers. Leave warning stickers in position.

Observe the following information when driving your vehicle:

- the safety notes in this manual
- the Technical Data section in this manual
- traffic rules and regulations
- laws and safety standards pertaining to motor vehicles

Problems with your vehicle

If you should experience a problem with your vehicle, particularly one that you believe may affect its safe operation, we urge you to immediately contact an authorized smart center to have the problem diagnosed and corrected if required. Do not drive the vehicle if you believe it may not be safely operated. If the matter is not handled to your satisfaction, please discuss the problem with the smart center management, or if necessary contact us at one of the following addresses:

In the USA

Mercedes-Benz USA, LLC
One Mercedes Drive
Montvale, NJ 07645

In Canada

Customer Relations Department
98 Vanderhoof Avenue
Mercedes-Benz Canada, Inc.
Toronto, Ontario M4G 4C9

QR codes for rescue card

The QR codes are secured in the fuel filler flap and on the opposite side on the B-pillar. In the event of an accident, rescue services can use the QR code to quickly find the appropriate rescue card for your vehicle. The current rescue card contains the most important information about your vehicle in a compact form, e.g. the routing of the electric cables. You can find more information under http://portal.aftersales.i.daimler.com/public/content/asportal/en/communication/informationen_fuer/QRCode.html.

Data stored in the vehicle

Data recording

A large number of your vehicle's electronic components can store data.

The data memory temporarily or permanently stores technical information about:

- Vehicle's operating status
- Incidents
- Malfunctions

The technical information generally documents the condition of a component, module, system or the environment.

These include, for example:

- Operating status of system components, e.g. fluid levels
- Status messages concerning the vehicle and its individual components, e.g. number of wheel revolutions/speed, deceleration in movement, lateral acceleration, accelerator pedal position
- Malfunctions and defects in key system components, including, for instance, lights, brakes

- Vehicle reactions and operating conditions in special driving situations, including, for instance, deployment of an air bag, use of stability control systems
- Environmental conditions, including, for instance, the outside temperature

This data is of an exclusively technical nature and can be used to:

- assist in the detection and elimination of malfunctions and defects
- analyze vehicle functions, e.g. after an accident
- optimize vehicle functions

The data cannot be used to trace the vehicle's movements.

If you have the vehicle serviced, this technical information can be read out from the event and malfunction data memory.

Services include, for example, information on:

- Repair work
- Service work
- Warranty claims
- Quality assurance

The readout is handled by service network staff (including the manufacturer) with the help of special diagnostic testers. You can obtain more detailed information, if required.

After the malfunction has been rectified, the information is cleared in the malfunction memory or is sequentially overwritten.

During vehicle operation, certain situations may arise in which this technical data - in conjunction with other information and, if applicable, after consultation with an approved assessor - may be linked to an individual person.

Examples of this include:

- Accident reports
- Vehicle damage
- Evidence

Event data recorders

This vehicle is equipped with an event data recorder (EDR). The main purpose of an EDR is to record data that will assist in understanding how a vehicle's systems performed in certain crash or near crash-like situations, such

as during air bag deployment or when hitting a road obstacle. The EDR is designed to record data related to vehicle dynamics and safety systems for a short period of time, typically 30 seconds or less.

The EDR in this vehicle is designed to record such data as:

- how various systems in your vehicle are operating
- whether or not the driver and passenger seat belts are fastened
- how far (if at all) the driver is depressing the accelerator and/or brake pedal and
- how fast the vehicle is traveling

This data can help provide a better understanding of the circumstances in which crashes and injuries occur. NOTE: EDR data is recorded by your vehicle only if a nontrivial crash situation occurs. No data is recorded by the EDR under normal driving conditions. No personal data (e.g., name, gender, age, and accident location) are recorded. However, other parties, such as law enforcement, can combine the EDR data with the type of personal identification data routinely acquired during a crash investigation. EDR data may be used in civil and criminal matters as a tool in accident reconstruction, accident claims, and vehicle safety.

To read data recorded by an EDR, special equipment is required, and access to the vehicle or the EDR is needed. In addition to the vehicle manufacturer, other parties that have the special equipment, such as law enforcement, can read the information by accessing the vehicle or the EDR.

EDR data may be used in civil and criminal matters as a tool in accident reconstruction, accident claims, and vehicle safety. Since the Crash Data Retrieval CDR tool that is used to extract data from the EDR is commercially available, Mercedes-Benz USA, LLC ("MBUSA") expressly disclaims any and all liability arising from the extraction of this information by unauthorized Mercedes-Benz personnel.

MBUSA will not share EDR data with others without the consent of the vehicle owners or, if the vehicle is leased, without the consent of the lessee. Exceptions to this representation include responses to subpoenas by law enforcement; by federal, state or local government; in connection with or arising out of

litigation involving MBUSA or its subsidiaries and affiliates; or, as required by law.

Warning: the EDR is a component of the Restraint System Module. Tampering with, altering, modifying or removing the EDR component may result in a malfunction of the Restraint System Module and other systems.

State laws or regulations regarding EDRs that conflict with federal regulation are pre-empted. This means that in the event of such conflict, the federal regulation governs. As of February 2013, 13 states have enacted laws related to EDRs.

Information on copyright

General information

You can find information on license for free and open-source software used in your vehicle and its electronic components on the following website:

<http://www.mercedes-benz.com/opensource>

Dashboard

>> At a glance.

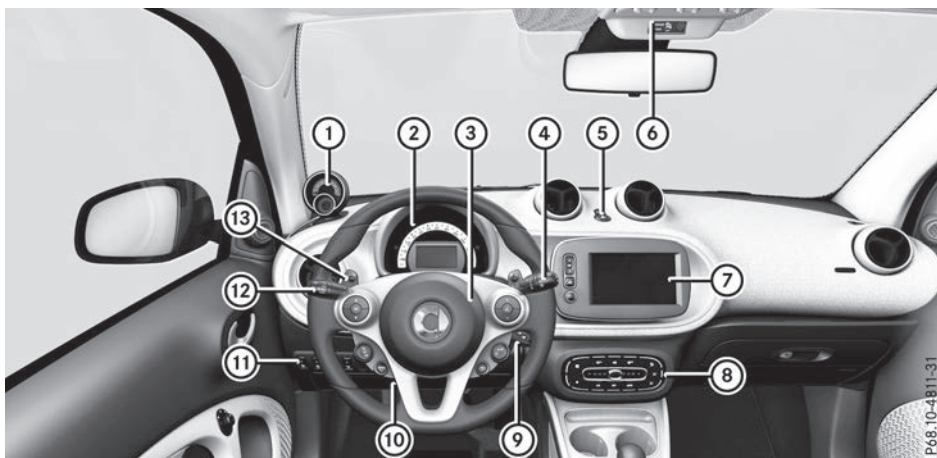

	Function	Page
①	Additional instruments on the dashboard	107
②	Instrument cluster	25
③	Horn	
④	Windshield wipers combination switch	75
⑤	Switches the automatic locking feature on/off	57
	Switches the hazard warning lamps on/off	70
⑥	Overhead control panel	29
⑦	smart Audio-System/smart Media-System (see the separate operating instructions)	

	Function	Page
⑧	Climate control system control panel	79
⑨	Ignition lock	86
⑩	Adjusts the steering wheel	66
⑪	Control panel for: Turning the forward collision warning on/off	50
	Turning the parking aid on/off	104
⑫	Lights combination switch	68
⑬	Shift paddles	94

Instrument cluster

Displays



P54.33-4371-31

	Function	Page		Function	Page
①	Speedometer	106	③	Warning and indicator lamps	26
②	Color display	108			

>> At a glance.

>> At a glance.

Warning and indicator lamps



P54.33-4372-31

	Function	Page
①	USA: ABS Canada: ABS	130 130
②	ESP®	130
③	Battery	133
④	Tire pressure monitor	135
⑤	Oil pressure	134
⑥	Power steering	137
⑦	Check Engine	132
⑧	Coolant temperature	134
⑨	Turn signal, right	69
⑩	Turn signal, left	69
⑪	USA: Brakes Canada: Brakes	128 128

	Function	Page
⑫	Rear fog lamp	69
⑬	Fog lamps	69
⑭	High-beam headlamps	69
⑮	Low-beam headlamps	68
⑯	Restraint system	31
⑰	Parking lamps	69
⑱	Distance warning	132
⑲	Seat belts	127
⑳	Doors or the tailgate Vehicle electronics	137 137

Multifunction steering wheel

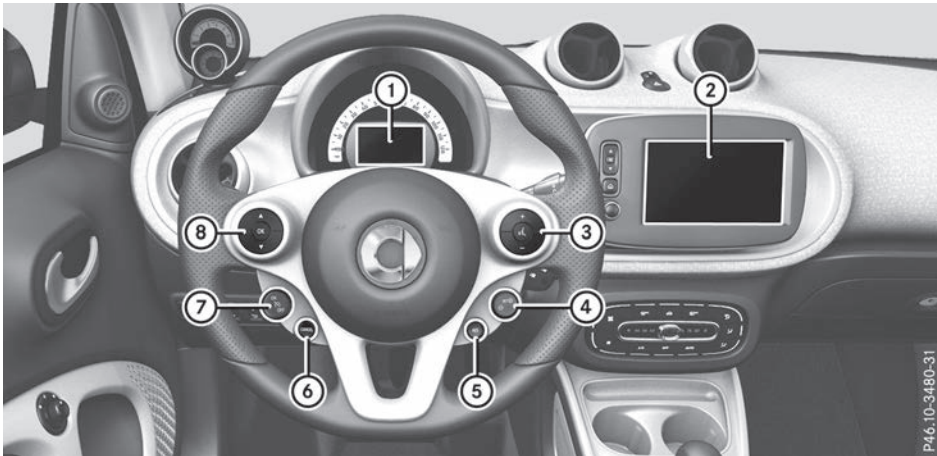

>> At a glance.

	Function	Page
①	Color display in instrument cluster	107
②	smart Audio-System or smart Media-System display (see the separate operating instructions)	
③	<p>+ - Changes the volume of the smart Audio-System or smart Media-System (see the separate operating instructions)</p> <p>☎ Switches voice-operated control of the smart Audio-System on/off and accepts/ends a call (see the separate operating instructions)</p>	
④	<p>Cruise control button SET + Increases or stores the current speed</p> <p>- Decreases current speed</p> <p>RES Selects a stored speed</p>	103

	Function	Page
⑤	<p>Cruise control button RES Calls up the last speed stored</p>	103
⑥	<p>Cruise control button CANCEL Interrupts cruise control</p>	103
⑦	<p>Cruise control button CC OFF</p> <p>ON OFF Activates or deactivates cruise control</p>	103
⑧	<p>▲ ▼ Scrolls through a menu or list</p> <p>OK</p> <p>Confirms your selection</p> <p>Changes to the "Reset values" function in certain menus</p> <p>Hides display messages</p>	107 107 107 114

i Voice-operated control as well as control of the telephone and volume using the steering wheel buttons in the control panel on the right ③ only function with the smart

Media-System. If you use a smart Audio-System or an audio device from another manufacturer, the functions may be restricted or not available at all.

Center console

>> At a glance.

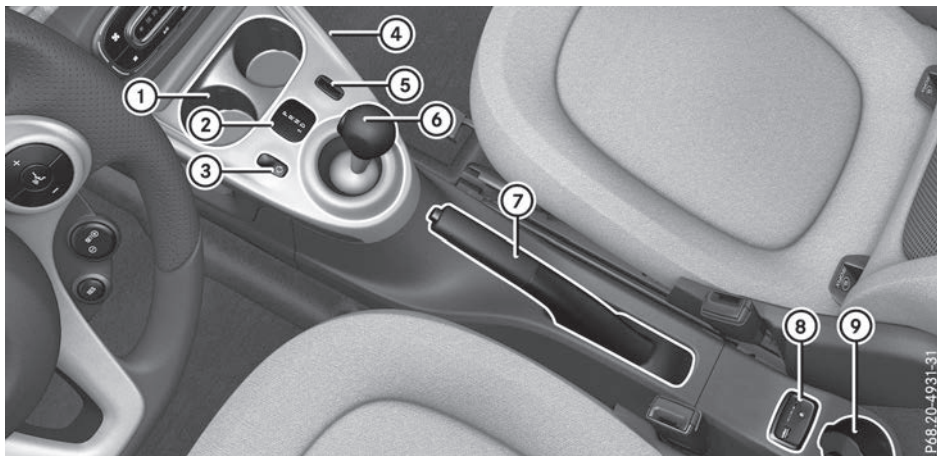

i Vehicles with automatic transmission

	Function	Page
①	Cup holder	142
②	Transmission position display	91
③	Sets the driving program (program selector button)	92
④	Drawer	139
⑤	Coin holder	

	Function	Page
⑥	Selector lever	90
⑦	Parking brake	98
⑧	AUX/USB port and SD memory card (only with smart Media-System) Socket	143
⑨	Cup holder	142

Overhead control panel

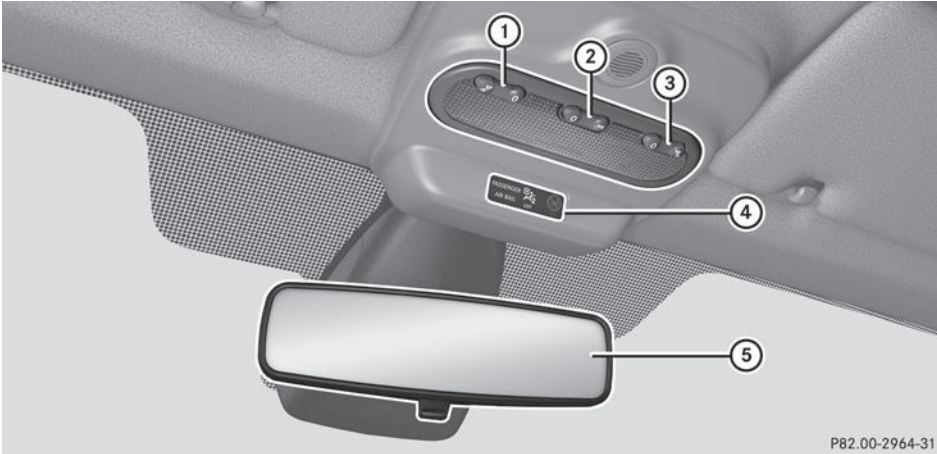

P82.00-2964-31

>> At a glance.

	Function	Page
①	Switches the left-hand reading lamp on/off	
②	Depending on the position of the switch: Interior lighting switched on	70
	Automatic interior lighting control on	70
	Interior lighting switched off	70

	Function	Page
③	Switches the right-hand reading lamp on/off	70
④	PASSENGER AIRBAG OFF/ON indicator lamps	32
⑤	Rear-view mirror	66

Door control panel

>> At a glance.

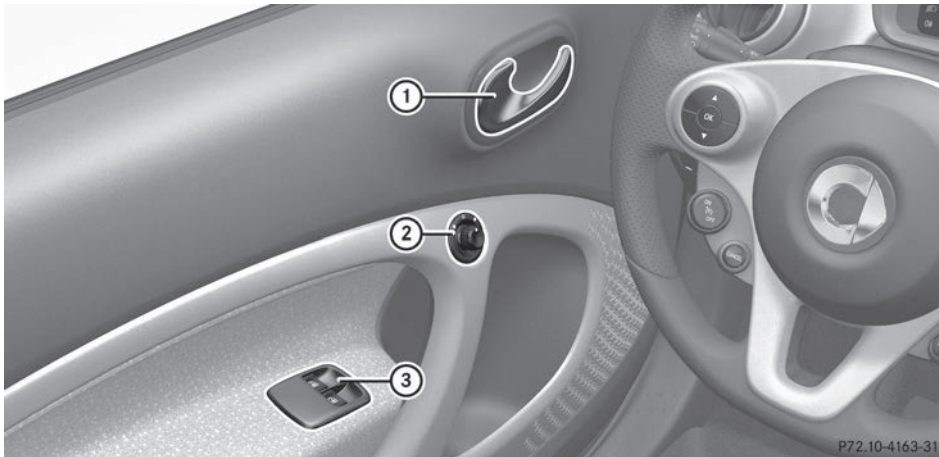

P72.10-4163-31

	Function	Page
①	Opens the door	56
②	Adjusts the exterior mirrors electrically	67

	Function	Page
③	 Opens/closes the side windows	59

Panic alarm

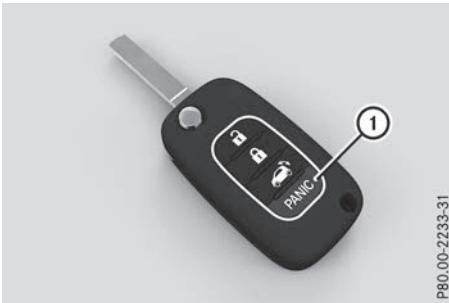

- ▶ **To activate:** press **PANIC** ① button for about two seconds.
An alarm sounds and the exterior lighting flashes.
- ▶ **To deactivate:** press button **PANIC** ① again.

Occupant safety

Introduction to the restraint system

The restraint system can reduce the risk of vehicle occupants coming into contact with parts of the vehicle's interior in the event of an accident. The restraint system can also reduce the forces to which vehicle occupants are subjected during an accident.

The restraint system comprises:

- seat belt system
- air bags

The components of the restraint system work in conjunction with each other. They can only deploy their protective function if, at all times, all vehicle occupants:

- have fastened their seat belts correctly (▷ page 34)
- have adjusted their seat properly (▷ page 62).

As the driver, you also have to make sure that the steering wheel is adjusted correctly. Observe the information relating to the correct driver's seat position (▷ page 62).

You also have to make sure that an air bag can inflate properly if deployed (▷ page 36).

An air bag supplements a correctly worn seat belt. As an additional safety device, the air bag increases the level of protection for

vehicle occupants in the event of an accident. For example, if, in the event of an accident, the protection offered by the seat belt is sufficient, the air bags are not deployed. When an accident occurs, only the air bags that increase protection in that particular accident situation are deployed. However, seat belts and air bags generally do not protect against objects penetrating the vehicle from the outside.

Information on restraint system operation can be found under "Triggering of the Emergency Tensioning Devices and air bags" (▷ page 42).

For information on children traveling with you in the vehicle and on child restraint systems, see "Children in the vehicle" (▷ page 44).

Important safety notes

WARNING

Modifications to the restraint system may cause it to no longer work as intended. The restraint system may then not perform its intended protective function and may fail in an accident or trigger unexpectedly, for example. This poses an increased risk of injury or even fatal injury.

Never modify parts of the restraint system. Never tamper with the wiring, the electronic components or their software.

If it is necessary to modify an air bag system to accommodate a person with disabilities, contact a smart center for specific details. USA only: contact our Customer Assistance Center on 1-800-762-7887 for details.

Restraint system warning lamp

The functions of the restraint system are checked after the ignition is switched on and at regular intervals while the engine is running. Therefore, malfunctions can be detected in good time.

The  restraint system warning lamp in the instrument cluster lights up when the ignition is switched on. It goes out no later

than a few seconds after the vehicle is started. The components of the restraint system are in operational readiness.

A malfunction has occurred if the  restraint system warning lamp:

- does not light up after the ignition is switched on
- does not go out after a few seconds with the engine running
- lights up again while the engine is running

WARNING

If restraint system is malfunctioning, restraint system components may be triggered unintentionally or might not be triggered at all in the event of an accident with a high rate of vehicle deceleration. This can affect the Emergency Tensioning Device or air bag, for example. This poses an increased risk of injury or even fatal injury.

Have the restraint system checked and repaired in a qualified specialist workshop as soon as possible.

PASSENGER AIR BAG indicator lamps

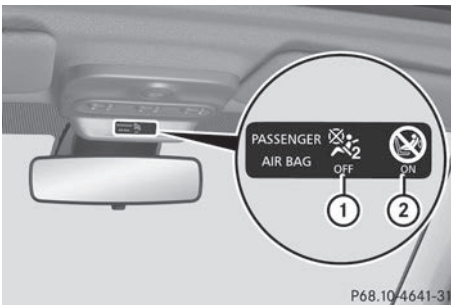

PASSENGER AIR BAG OFF indicator lamp ① and PASSENGER AIR BAG ON indicator lamp ② are part of the Occupant Classification System (OCS).

The indicator lamps display the status of the front-passenger front air bag.

- PASSENGER AIR BAG ON lights up: the front-passenger front air bag is enabled. If, in the event of an accident, all deployment

criteria are met, the front-passenger front air bag is deployed.

- PASSENGER AIR BAG OFF lights up: the front-passenger front air bag is deactivated. It will then not be deployed in the event of an accident.

Depending on the person in the front-passenger seat, the front-passenger front air bag must either be deactivated or enabled; see the following points. You must make sure of this both before and during a journey.

- **Children in a child restraint system:** whether the front-passenger front air bag is enabled or deactivated depends on the installed child restraint system, and the age and size of the child. Therefore, be sure to observe the notes on the "Occupant Classification System (OCS)" (> page 38) and on "Children in the vehicle" (> page 44). There you will also find instructions on rearward and forward-facing child restraint systems on the front-passenger seat.
- **All other persons:** depending on the classification of the person in the front-passenger seat, the front-passenger front air bag is enabled or deactivated (> page 38). Be sure to observe the notes on "Seat belts" (> page 32) and "Air bags" (> page 35). There you can also find information on the correct seat position.

Seat belts

Introduction

Seat belts are the most effective means of restricting the movement of vehicle occupants in the event of an accident or the vehicle rolling over. This reduces the risk of vehicle occupants coming into contact with parts of the vehicle interior or being ejected from the vehicle. Furthermore, the seat belt helps to keep the vehicle occupant in the best position in relation to the air bag.

The seat belt system comprises:

- Seat belts
- Emergency Tensioning Devices and seat belt force limiters

If the seat belt is pulled by the seat belt guide quickly or with a jerky movement, the

belt retractor locks. The belt strap cannot be extracted any further.

The Emergency Tensioning Device tightens the seat belt in an accident, pulling the belt close against the body. However it does not pull the vehicle occupant back in the direction of the backrest.

The Emergency Tensioning Device does not correct an incorrect seat position or the routing of an incorrectly fastened seat belt. When triggered, a seat belt force limiter helps to reduce the force exerted by the seat belt on the vehicle occupant.

The seat belt force limiters are synchronized with the front air bags which absorb part of the deceleration force. This can reduce the force exerted on the vehicle occupants during an accident.

! If the front-passenger seat is unoccupied, do not insert the belt tongue into the buckle of the front-passenger seat. This may otherwise lead to the triggering of the Emergency Tensioning Device in the event of an accident, which will then need to be replaced.

Important safety notes

The use of seat belts and child restraint systems is required by law in:

- all 50 states
- the U.S. territories
- the District of Columbia
- all Canadian provinces

Even where this is not required by law, all vehicle occupants should correctly fasten their seat belts before starting the journey.

WARNING

If the seat belt is incorrectly fastened, it cannot protect as intended. Furthermore, an incorrectly fastened seat belt can cause additional injury, for example, in an accident, during braking or when abruptly changing direction. This poses an increased risk of injury or even fatal injury.

Make sure that all vehicle occupants are seated properly with a correctly fastened seat belt.

WARNING

The seat belt does not offer the intended level of protection if you have not moved the backrest to an almost vertical position. When braking or in the event of an accident, you could slide underneath the seat belt and sustain abdomen or neck injuries, for example. This poses an increased risk of injury or even fatal injury.

Adjust the seat properly before beginning your journey. Always ensure that the backrest is in an almost vertical position and that the shoulder section of your seat belt is routed across the center of your shoulder.

WARNING

Persons under 5 ft (1.50 m) in height cannot fasten the seat belt correctly without an additional suitable restraint system. If the seat belt is incorrectly fastened, it cannot protect as intended. Furthermore, an incorrectly fastened seat belt can cause additional injury, for example, in an accident, during braking or an abrupt change of direction. This poses an increased risk of injury or even fatal injury.

For this reason, always secure persons under 5 ft (1.50 m) in height in suitable restraint systems.

If a child younger than twelve years old and under 5 ft (1.50 m) in height is traveling in the vehicle:

- always secure the child in a child restraint system suitable for this smart vehicle. The child restraint system must be appropriate to the age, weight and size of the child
- always observe the instructions and safety notes on "Children in the vehicle" (> page 44) in addition to the child restraint system manufacturer's installation and operating instructions
- be sure to observe the instructions and safety notes on the "Occupant classification system (OCS)" (> page 38)

 **WARNING**

The seat belts may not perform their intended protective function if:

- they are damaged, modified, extremely dirty, bleach or dyed
- the seat belt buckle is damaged or extremely dirty
- the Emergency Tensioning Devices, belt anchorages or inertia reels have been modified

Seat belts may sustain non-visible damage in an accident, e.g. due to glass splinters. Modified or damaged seat belts may tear or fail, e.g. in an accident. Modified Emergency Tensioning Devices could accidentally trigger or fail to deploy when necessary. This poses an increased risk of injury or even fatal injury.

Never modify the seat belts, Emergency Tensioning Devices, belt anchorages or inertia reels. Make sure that the seat belts are undamaged, not worn out and clean. Following an accident, have the seat belts checked immediately at a qualified specialist workshop.

Only use seat belts that have been approved for your vehicle by smart.

Proper use of the seat belts

Observe the safety notes on the seat belt (▷ page 33).

All vehicle occupants must be wearing the seat belt correctly before beginning the journey. Also make sure that all vehicle occupants are always wearing the seat belt correctly while the vehicle is in motion.

When fastening the seat belt, always make sure that:

- the seat belt tongue is only inserted to the belt buckle belonging to that seat.
- the seat belt is tight across your body.
Avoid wearing bulky clothing, e.g. a winter coat.
- the seat belt is not twisted.
Only then can the forces which occur be distributed over the area of the belt.

- the shoulder section of the belt is always routed across the center of your shoulder. The shoulder section of the belt must not come into contact with your neck or be routed under your arm.
- the lap belt passes tightly and as low down as possible across your lap.
The lap belt must always be routed across your hip joints and not across your abdomen. This applies particularly to pregnant women. If necessary, push the lap belt down to your hip joint and pull it tight using the shoulder section of the belt.
- the seat belt is not routed across sharp, pointed or fragile objects.
If you have such items located on or in your clothing, e.g. pens, keys or eyeglasses, store these in a suitable place.
- only one person is using a seat belt at a time.
Infants and children must never travel sitting on the lap of a vehicle occupant. In the event of an accident, they could be crushed between the vehicle occupant and seat belt.
- objects are never secured with a seat belt if the seat belt is also being used by one of the vehicle's occupants.
Also ensure that there are never objects between a person and the seat, e.g. cushions.

Seat belts are only intended to secure and restrain vehicle occupants. Always observe the "Loading guidelines" for securing objects, luggage or loads (▷ page 138).

Fastening seat belts

Observe the safety notes on the seat belt (▷ page 33) and the notes on correct use of seat belts (▷ page 34).

For easy fastening, the seat belt passes through a belt loop on the side of the seat.

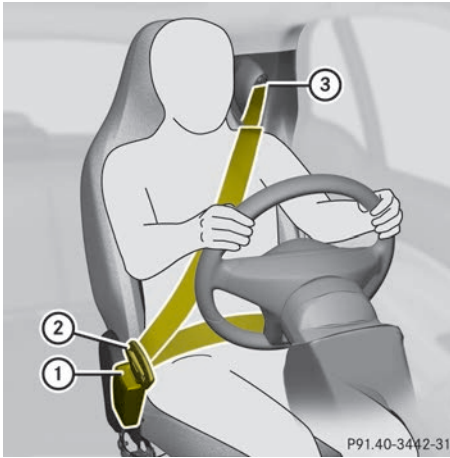

Basic illustration

- ▶ Adjust the seat (▷ page 62).
The seat backrest must be in an almost vertical position.
- ▶ Pull the seat belt smoothly from belt outlet ③ and engage belt tongue ② into belt buckle ①.
- ▶ If necessary, pull upwards on the shoulder section of the seat belt to tighten the belt across your body.



In order to attach the child restraint system securely in the vehicle, the seat belt on the front-passenger seat is equipped with a special seat belt retractor. Further information on the "Special seat belt retractor" (▷ page 45).

Releasing seat belts

- ❗ Make sure that the seat belt is fully rolled up. Otherwise, the seat belt or belt tongue will be trapped in the door or in the seat mechanism. This could damage the door, the door trim panel and the seat belt. Damaged seat belts can no longer fulfill their protective function and must be replaced. Visit a qualified specialist workshop.
- ▶ Press the release button in the belt buckle, hold the belt tongue firmly and guide the belt back.

Belt warning for the driver and front passenger

The  seat belt warning lamp in the instrument cluster is a reminder that all vehicle occupants must wear their seat belts. It may light up continuously or flash. In addition, there may be a warning tone.

Regardless of whether the driver's seat belt has already been fastened, the  seat belt warning lamp lights up for six seconds each time the engine is started. If the driver's or front-passenger seat belt has not been fastened, the  seat belt warning lamp starts to light up continuously after these six seconds. As soon as the driver and front passenger fasten their seat belts, the  seat belt warning lamp goes out.

If the driver's seat belt is not fastened after the engine is started, an additional warning tone will sound. The warning tone switches off after six seconds or once the driver's seat belt is fastened.

If the vehicle speed exceeds 12 mph (20 km/h) and the driver's or front-passenger seat belt is not fastened, a warning tone sounds again. The warning tone sounds with increasing intensity for a maximum of 120 seconds or until the driver or front passenger have fastened their seat belts.

If the driver or front passenger unfasten their seat belts during the journey, the seat belt warning is activated again.

Air bags

Introduction

The installation point of an air bag can be recognized by the AIR BAG symbol.

An air bag complements the correctly fastened seat belt. It is no substitute for the seat belt. The air bag provides additional protection in applicable accident situations.

Not all air bags are deployed in an accident. The different air bag systems function independently from one another (▷ page 42).

However, no system available today can completely eliminate injuries and fatalities.

It is also not possible to rule out a risk of injury caused by an air bag due to the high speed at which the air bag must be deployed.

Important safety notes

WARNING

If you do not sit in the correct seat position, the air bag cannot protect as intended and could even cause additional injury when deployed. This poses an increased risk of injury or even fatal injury.

To avoid hazardous situations, always make sure that all of the vehicle's occupants:

- have fastened their seat belts correctly, including pregnant women
- are sitting correctly and maintain the greatest possible distance to the air bags
- follow the following instructions

Always make sure that there are no objects between the air bag and the vehicle's occupants.

- Adjust the seats properly before beginning your journey. Always make sure that the seat is in an almost upright position.
- Move the driver's and front-passenger seats as far back as possible. The driver's seat position must allow the vehicle to be driven safely.
- Only hold the steering wheel on the outside. This allows the air bag to be fully deployed.
- Always lean against the backrest while driving. Do not lean forwards or lean against the door or side window. You may otherwise be in the deployment area of the air bags.
- Always keep your feet in the footwell in front of the seat. Do not put your feet on the dashboard, for example. Your feet may otherwise be in the deployment area of the air bag.
- For this reason, always secure persons less than 5 ft (1.50 m) tall in suitable restraint systems. Up to this height, the seat belt cannot be worn correctly.

If a child is traveling in your vehicle, also observe the following notes:

- Always secure children under twelve years of age and less than 5 ft (1.50 m) tall in suitable child restraint systems.
- Only secure a child in a rearward-facing child restraint system on the front-passenger seat when the front-passenger front air bag is deactivated. If the PASSENGER AIR BAG OFF indicator lamp is permanently lit, the front-passenger front air bag is deactivated (> page 32).
- Always observe the instructions and safety notes on the "Occupant Classification System (OCS)" (> page 38) and on "Children in the vehicle" (> page 44) in addition to the child restraint system manufacturer's installation and operating instructions.

Objects in the vehicle interior may prevent an air bag from functioning correctly.

Before starting your journey and to avoid risks resulting from the speed of the air bag as it deploys, make sure that:

- there are no people, animals or objects between the vehicle occupants and an air bag.
- there are no objects between the seat, door and B-pillar.
- no hard objects, e.g. coat hangers, hang on the grab handles or coat hooks.
- no accessories, such as cup holders, are attached to the vehicle within the deployment area of an air bag, e.g. to doors or side windows.
- no heavy, sharp-edged or fragile objects are in the pockets of your clothing. Store such objects in a suitable place.

WARNING

If you modify the air bag cover or affix objects such as stickers to it, the air bag can no longer function correctly. There is an increased risk of injury.

Never modify an air bag cover or affix objects to it.

WARNING

Sensors to control the air bags are located in the doors. Modifications or work not performed correctly to the doors or door

paneling, as well as damaged doors, can lead to the function of the sensors being impaired. The air bags might therefore not function properly anymore. Consequently, the air bags cannot protect vehicle occupants as they are designed to do. There is an increased risk of injury.

Never modify the doors or parts of the doors. Always have work on the doors or door paneling carried out at a qualified specialist workshop.

Front air bags



Driver's air bag ① deploys in front of the steering wheel. Front-passenger front air bag ② deploys in front of and above the glove box.

When deployed, the front air bags offer additional head and thorax protection for the occupants in the driver's and front-passenger seats.

The PASSENGER AIR BAG OFF and PASSENGER AIR BAG ON indicator lamps inform you about the status of the front-passenger air bag (> page 32).

The front-passenger front air bag will only deploy if:

- the system, based on the OCS weight sensor readings, detects that the front-passenger seat is occupied (> page 38). The PASSENGER AIR BAG ON indicator lamp is lit (> page 39)
- the restraint system control unit predicts a high accident severity

Knee bags

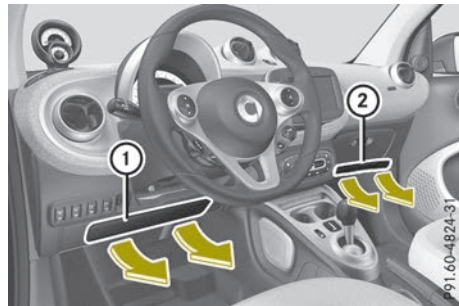

Driver's knee bag ① deploys under the steering column and front-passenger knee bag ② under the glove box. The driver's and front-passenger knee bags are triggered together with the front air bags.

The driver's and front-passenger knee bags offer additional thigh, knee and lower leg protection for the occupants in the front seats.

Thorax/pelvis air bags

WARNING

Unsuitable seat covers could restrict or even prevent the deployment of the air bags integrated into the seats. Consequently, the air bags cannot protect vehicle occupants as they are designed to do. In addition, the operation of the occupant classification system (OCS) could be adversely affected. This poses an increased risk of injury or even fatal injury.

You should only use seat covers that have been approved for the corresponding seats by smart.



Thorax/pelvis air bags ① deploy next to the outer bolster of the seat backrest.

When deployed, the thorax/pelvis air bags offer additional thorax and pelvis protection.

In the event of a side impact, the thorax/pelvis air bag is deployed on the side on which the impact occurs.

The thorax/pelvis air bag on the front-passenger side deploys under the following conditions:

- the OCS system detects that the front-passenger seat is occupied or
- the belt tongue is engaged in the belt buckle of the front-passenger seat

If the belt tongue is engaged in the belt buckle, the thorax/pelvis air bag on the front-passenger side deploys if an appropriate accident situation occurs. In this case, deployment is independent of whether the front-passenger seat is occupied or not.

Window curtain air bags

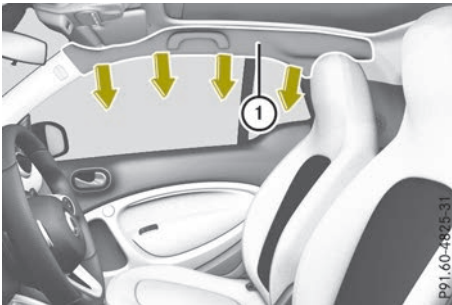

Window curtain air bags ① are integrated into the side of the roof frame above the doors.

When deployed, the window curtain air bag enhances the level of protection for the head. However, it does not protect the chest or arms.

In the event of a side impact, the window curtain air bag is deployed on the side on which the impact occurs.

If the system determines that they can offer additional protection to that provided by the seat belt, a window curtain air bag may be deployed in other accident situations (> page 42).

Occupant Classification System (OCS)

Introduction

The Occupant Classification System (OCS) categorizes the person in the front-passenger seat. Depending on that result, the front-passenger front air bag and front-passenger knee bag are either enabled or deactivated.

The system does not deactivate:

- the thorax/pelvis air bag
- the window curtain air bag
- the Emergency Tensioning Devices

Prerequisites

To be classified correctly, the front passenger must sit:

- with the seat belt fastened correctly
- in an almost upright position with their back against the seat backrest
- with their feet resting on the floor, if possible

If the front passenger does not observe these conditions, OCS may produce a false classification, e.g. because the front passenger:

- transfers their weight by supporting themselves on a vehicle armrest
- sits in such a way that their weight is raised from the seat cushion

If you install a child restraint system on the front-passenger seat, be sure to observe the correct positioning of the child restraint system. Never place objects under or behind the child restraint system, e.g. cushions. The entire base of the child restraint system must always rest on the seat cushion of the front-passenger seat. The backrest of the forward-facing child restraint system must lie as flat as possible against the backrest of the front-passenger seat.

The child restraint system must not touch the roof. Adjust the backrest angle accordingly.

Only then can OCS be guaranteed to function correctly. Always observe the child restraint system manufacturer's installation and operating instructions.

How the occupant classification system (OCS) operates

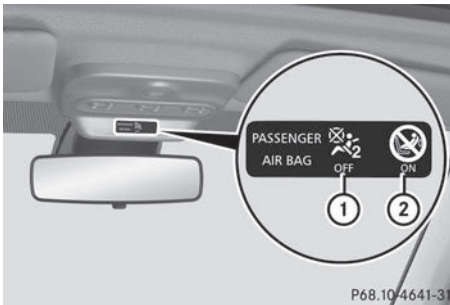

- ① PASSENGER AIR BAG OFF indicator lamp
- ② PASSENGER AIR BAG ON indicator lamp

The indicator lamps inform you whether the front-passenger front air bag is deactivated or enabled.

- ▶ Turn the SmartKey to position **1** or **2** in the ignition lock.
The system carries out self-diagnostics.

The PASSENGER AIR BAG OFF and PASSENGER AIR BAG ON indicator lamps must light up simultaneously for approximately six seconds.

The indicator lamps display the status of the front-passenger front air bag.

- PASSENGER AIR BAG ON lights up: the front-passenger front air bag is enabled. If, in the event of an accident, all deployment criteria are met, the front-passenger front air bag is deployed.
- PASSENGER AIR BAG OFF lights up: the front-passenger front air bag is deactivated. It will then not be deployed in the event of an accident.

When the front-passenger seat is occupied, always pay attention to the PASSENGER AIR BAG ON and PASSENGER AIR BAG OFF indicator lamps. Be aware of the status of the front-passenger front air bag both before and during the journey.

WARNING

If the PASSENGER AIR BAG OFF indicator lamp is lit, the front-passenger front air bag is disabled. It will not be deployed in the event of an accident and cannot perform its intended protective function. A person

in the front-passenger seat could then, for example, come into contact with the vehicle's interior, especially if the person is sitting too close to the dashboard. This poses an increased risk of injury or even fatal injury.

When the front-passenger seat is occupied, always ensure that:

- the classification of the person in the front-passenger seat is correct and the front-passenger front air bag is enabled or disabled in accordance with the person in the front-passenger seat
- the front-passenger seat has been moved back as far back as possible.
- the person is seated correctly.

Make sure, both before and during the journey, that the status of the front-passenger front air bag is correct.

WARNING

If you secure a child in a rearward-facing child restraint system on the front-passenger seat and the PASSENGER AIR BAG ON indicator lamp is lit up, the front-passenger front air bag may deploy in an accident. The child could be struck by the air bag. This poses an increased risk of injury or even fatal injury.

Make sure that the front-passenger front air bag has been disabled. The PASSENGER AIR BAG OFF indicator lamp must be lit.

If the PASSENGER AIR BAG OFF indicator lamp remains off and/or the PASSENGER AIR BAG ON indicator lamp lights up, do not install a rearward-facing child restraint system on the front-passenger seat. You can find more information on OCS under "Problems with the Occupant Classification System" (> page 41).

 **WARNING**

If you secure a child in a forward-facing child restraint system on the front-passenger seat and you position the front-passenger seat too close to the dashboard, in the event of an accident, the child could:

- come into contact with the vehicle's interior if the PASSENGER AIR BAG OFF indicator lamp is lit, for example
- be struck by the air bag if the PASSENGER AIR BAG ON is lit up

This poses an increased risk of injury or even fatal injury.

Move the front-passenger seat as far back as possible. Always make sure that the shoulder belt strap is correctly routed from the vehicle belt guide to the shoulder belt guide on the child restraint system. The shoulder belt strap must be routed forwards and downwards from the belt guide. Always observe the child restraint system manufacturer's installation instructions.

If OCS determines that:

- the front-passenger seat is unoccupied, the PASSENGER AIR BAG OFF indicator lamp lights up after the system self-test and remains lit. This indicates that the front-passenger front air bag is deactivated.
- the front-passenger seat is occupied by a child of up to twelve months old, in a standard child restraint system, the PASSENGER AIR BAG OFF indicator lamp lights up after the system self-test and remains lit. This indicates that the front-passenger front air bag is deactivated.

But even in the case of a twelve-month-old child, in a standard child restraint system, the PASSENGER AIR BAG ON can light up permanently after the system self-test. This indicates that the front-passenger front air bag is activated. The result of the classification is dependent on, among other factors, the child restraint system and the child's stature. Make sure that the conditions for a correct classification are met. If the PASSENGER AIR BAG OFF indicator lamp is still lit, do not install a child restraint system on the front-passenger seat.

- the front-passenger seat is occupied by a person of smaller stature (e.g. a teenager or small adult), either the PASSENGER AIR BAG ON or PASSENGER AIR BAG OFF indicator lamp lights up and remains lit after the system self-test depending on the result of the classification.
 - If the PASSENGER AIR BAG ON indicator lamp lights up, move the front-passenger seat as far back as possible.
 - If the PASSENGER AIR BAG OFF indicator lamp is lit, a person of smaller stature should not use the front-passenger seat.
- the front-passenger seat is occupied by an adult or a person of adult stature, the PASSENGER AIR BAG ON indicator lamp lights up after the system self-test and remains lit. This indicates that the front-passenger front air bag is activated.

If children are traveling in the vehicle, be sure to observe the notes on "Children in the vehicle" (▷ page 44).

When OCS is malfunctioning, the red  restraint system warning lamp in the instrument cluster and the PASSENGER AIR BAG OFF indicator lamp light up simultaneously. The front-passenger front air bag is deactivated in this case and does not deploy during an accident. Have the system checked by qualified technicians as soon as possible. Consult a smart center. The front-passenger seat should only be repaired at a smart center.

If the front-passenger seat, the seat cover or the seat cushion is damaged, have the necessary repair work carried out at a smart center.

smart recommends that you only use seat accessories which have been approved by smart.

If the driver's air bag deploys, this does not mean that the front-passenger front air bag will also deploy. The Occupant Classification System (OCS) categorizes the occupant in the front-passenger seat. Depending on that result, the front-passenger front air bag is either enabled or deactivated.

System self-test

 **DANGER**

If both the PASSENGER AIR BAG OFF and PASSENGER AIR BAG ON indicator lamps do

not light up during the system self-test, the system is malfunctioning. The front-passenger front air bag might be triggered unintentionally or might not be triggered at all in the event of an accident with high deceleration. This poses an increased risk of injury or even fatal injury.

In this case the front-passenger seat may not be used. Do not install a child restraint system on the front-passenger seat. Have the Occupant Classification System (OCS) checked and repaired immediately at a qualified specialist workshop.

 **WARNING**

If the PASSENGER AIR BAG OFF indicator lamp remains lit after the system self-test, the front-passenger front air bag is disabled. It will not be deployed in the event of an accident. In this case, the front-passenger front air bag cannot perform its intended protective function, e.g. when a person is seated in the front-passenger seat.

That person could, for example, come into contact with the vehicle's interior, especially if the person is sitting too close to the dashboard. This poses an increased risk of injury or even fatal injury.

When the front-passenger seat is occupied, always ensure that:

- the classification of the person in the front-passenger seat is correct and the front-passenger front air bag is enabled or disabled in accordance with the person in the front-passenger seat
- the person is seated properly with a correctly fastened seatbelt
- the front-passenger seat has been moved as far back as possible

If the PASSENGER AIR BAG OFF indicator lamp remains lit when it should not, the front-passenger seat may not be used. Do not install a child restraint system on the front-passenger seat. Have the Occupant Classification System (OCS) checked and repaired immediately at a qualified specialist workshop.

 **WARNING**

Objects between the seat surface and the child restraint system could affect OCS operation. This could result in the front-passenger air bag not functioning as intended during an accident. This poses an increased risk of injury or even fatal injury.

Do not place any objects between the seat surface and the child restraint system. The entire base of the child restraint system must always rest on the seat cushion of the front-passenger seat. The backrest of the forward-facing child restraint system must, as far as possible, be resting on the backrest of the front-passenger seat. Always comply with the child restraint system manufacturer's installation instructions.

After the system self-test, the PASSENGER AIR BAG OFF or PASSENGER AIR BAG ON indicator lamp displays the status of the front-passenger front air bag (▷ page 39).

For more information about the OCS, see "Problems with the Occupant Classification System" (▷ page 41).

Problems with the occupant classification system (OCS)

Be sure to observe the notes on "System self-test" (▷ page 40).

Problem	Possible causes/consequences and ► Solutions
The PASSENGER AIR BAG OFF indicator lamp lights up and remains lit, even though the front-passenger seat is occupied by an adult or a person of a stature corresponding to that of an adult.	The classification of the person on the front-passenger seat is incorrect. <ul style="list-style-type: none"> ► Make sure the conditions for a correct classification of the person on the front-passenger seat are met (▷ page 38). ► If the PASSENGER AIR BAG OFF indicator lamp remains lit, the front-passenger seat may not be used. ► Have the OCS checked at a smart center as soon as possible.
The PASSENGER AIR BAG OFF indicator lamp does not light up and/or does not stay on. The front-passenger seat is: <ul style="list-style-type: none"> • unoccupied • occupied with the weight of a child up to twelve months old in a child restraint system 	OCS is malfunctioning. <ul style="list-style-type: none"> ► Make sure there is nothing between the seat cushion and the child seat. ► Make sure that the entire base of the child restraint system rests on the seat cushion of the front-passenger seat. The backrest of the forward-facing child restraint system must lie as flat as possible against the backrest of the front-passenger seat. If necessary, adjust the position of the front-passenger seat. ► When installing the child restraint system, make sure that the seat belt is tight. Do not pull the seat belt tight using the front-passenger seat adjustment. This could result in the seat belt and the child restraint system being pulled too tightly. ► Check for correct installation of the child restraint system. ► Make sure that no objects are applying additional weight onto the seat. ► If the PASSENGER AIR BAG OFF indicator lamp remains off and/or the PASSENGER AIR BAG ON indicator lamp lights up, do not install a child restraint system on the front-passenger seat. ► Have the OCS checked at a smart center as soon as possible.

Deployment of Emergency Tensioning Device and air bags

Important safety notes

WARNING

The air bag parts are hot after an air bag has been deployed. There is a risk of injury.

Do not touch the air bag parts. Have a deployed air bag replaced at a qualified specialist workshop as soon as possible.

WARNING

A deployed air bag no longer offers any protection and cannot provide the intended

protection in an accident. There is an increased risk of injury.

Have the vehicle towed to a qualified specialist workshop in order to have a deployed air bag replaced.

For your own safety and that of your front passenger, it is important that you have deployed air bags replaced and faulty air bags repaired. This will help to make sure the air bags continue to perform their protective function for the vehicle occupants in the event of a crash.

WARNING

Pyrotechnic Emergency Tensioning Devices that have been deployed are no longer operational and are unable to perform

their intended protective function. This poses an increased risk of injury or even fatal injury.

Therefore, have pyrotechnic Emergency Tensioning Devices which have been triggered immediately replaced at a qualified specialist workshop.

If Emergency Tensioning Devices are triggered or air bags are deployed, you will hear a bang, and a small amount of powder may also be released. The  restraint system warning lamp lights up.

Only in rare cases will the bang affect your hearing. The powder that is released generally does not constitute a health hazard, but it may cause short-term breathing difficulties in people with asthma or other respiratory problems. Provided it is safe to do so, you should leave the vehicle immediately or open the window in order to prevent breathing difficulties.

Air bags and pyrotechnic Emergency Tensioning Devices (ETDs) contain perchlorate material, which may require special handling and regard for the environment. National guidelines must be observed during disposal. In California, see www.dtsc.ca.gov/HazardousWaste/Perchlorate/index.cfm.

Method of operation

During the first stage of a collision, the restraint system control unit evaluates important physical data relating to vehicle deceleration or acceleration, such as:

- duration
- direction
- intensity

Based on the evaluation of this data, the restraint system control unit triggers the Emergency Tensioning Devices during a frontal or rear collision.

An Emergency Tensioning Device can only be triggered, if:

- the ignition is switched on
- the components of the restraint system are operational. You can find further informa-

tion under: "Restraint system warning lamp" (> page 31)

- the belt tongue has engaged in the belt buckle of the respective seat

If the restraint system control unit detects a more severe accident, further components of the restraint system are activated independently of each other in certain frontal collision situations:

- Front air bags as well as driver's and front-passenger knee bags
- Window curtain air bag, if the system determines that deployment can offer additional protection to that provided by the seat belt

The front-passenger front air bag is activated or deactivated depending on the person on the front-passenger seat. The front-passenger front air bag can only deploy in an accident if the PASSENGER AIR BAG ON indicator lamp is lit. Observe the information on the PASSENGER AIR BAG indicator lamps (> page 32).

Your vehicle has two-stage front air bags. During the first deployment stage, the front air bag is filled with propellant gas to reduce the risk of injuries. The front air bag is fully deployed with the maximum amount of propellant gas if a second deployment threshold is reached within a few milliseconds.

The activation threshold of the Emergency Tensioning Devices and the air bag are determined by evaluating the rate of vehicle deceleration or acceleration which occurs at various points in the vehicle. This process is pre-emptive in nature. Deployment should take place in good time at the start of the collision.

The rate of vehicle deceleration or acceleration and the direction of the force are essentially determined by:

- the distribution of forces during the collision
- the collision angle
- the deformation characteristics of the vehicle
- the characteristics of the object with which the vehicle has collided

Factors which can only be seen and measured after a collision has occurred do not play a decisive role in the deployment of an air bag.

Nor do they provide an indication of air bag deployment.

The vehicle can be deformed considerably, without an air bag being deployed. This is the case if only parts which are relatively easily deformed are affected and the rate of deceleration is not high. Conversely, air bags may be deployed even though the vehicle suffers only minor deformation. This is the case if, for example, very rigid vehicle parts such as longitudinal body members are hit, and sufficient deceleration occurs as a result.

If the control unit of the restraint system detects a side impact or a vehicle rollover, the relevant components of the restraint system are activated separately depending on the anticipated type of accident.

- Thorax/pelvis air bag on the side of impact, independently of the Emergency Tensioning Device and the use of the seat belt

The thorax/pelvis air bag on the front-passenger side deploys under the following conditions:

- the OCS system detects that the front-passenger seat is occupied or
- the belt tongue is engaged in the belt buckle of the front-passenger seat
- Window curtain air bag on the side of impact, independently of the use of the seat belt and independently of whether the front-passenger seat is occupied
- Window curtain air bags on the driver's and front-passenger side in certain situations when the vehicle rolls over, if the system determines that deployment can offer additional protection to that provided by the seat belt
- Emergency Tensioning Devices, if the system determines that deployment can offer additional protection in this situation

- i** Not all air bags are deployed in an accident. The different air bag systems work independently of each other.

How the air bag system works is determined by the severity of the accident detected, especially the vehicle deceleration or acceleration and the apparent type of accident:

- Frontal collision
- Side impact
- Rollover

Children in the vehicle

Important safety notes

If a child younger than 12 years and under 5 ft (1.50 m) in height is traveling in the vehicle:

- always secure the child in a child restraint system suitable for Mercedes-Benz vehicles. The child restraint system must be appropriate to the age, weight and size of the child
- be sure to observe the instructions and safety notes in this section in addition to the child restraint system manufacturer's installation instructions
- be sure to observe the instructions and safety notes in "Occupant classification system (OCS)" (> page 38)

WARNING

If you leave children unsupervised in the vehicle, they could set it in motion by, for example:

- release the parking brake.
- shift the automatic transmission out of park position **P** or shift manual transmission into neutral.
- start the engine.

In addition, they may operate vehicle equipment and become trapped. There is a risk of an accident and injury.

When leaving the vehicle, always take the SmartKey with you and lock the vehicle. Never leave children unsupervised in the vehicle.

WARNING

If persons, particularly children are subjected to prolonged exposure to extreme heat or cold, there is a risk of injury, possibly even fatal. Never leave children unattended in the vehicle.

WARNING

If the child restraint system is subjected to direct sunlight, parts may get very hot. Children may burn themselves on these parts, particularly on the metal parts of the

child restraint system. There is a risk of injury.

If you leave the vehicle, taking the child with you, always ensure that the child restraint system is not exposed to direct sunlight. Protect it with a blanket, for example. If the child restraint system has been exposed to direct sunlight, let it cool down before securing the child in it. Never leave children unattended in the vehicle.

Always ensure that all vehicle occupants have their seat belts fastened correctly and are sitting properly. Particular attention must be paid to children.

Read and follow the safety notes on the seat belt (▷ page 33) and the notes on correct use of the seat belts (▷ page 34).

A booster seat may be necessary to achieve proper seat belt positioning for children over 41 lbs (18 kg) until they reach a height where a lap/shoulder belt fits properly without a booster seat.

Special seat belt retractor

WARNING

If the seat belt is released while driving, the child restraint system will no longer be secured properly. The special seat belt retractor is disabled and the inertia reel draws in a portion of the seat belt. The seat belt cannot be immediately refastened. There is an increased risk of injury, possibly even fatal.

Stop the vehicle immediately, paying attention to road and traffic conditions. Reactivate the special seat belt retractor and secure the child restraint system properly.

The seat belt on the front-passenger side is equipped with a special seat belt retractor. When activated, the special seat belt retractor ensures that the seat belt will not slacken once the child restraint system has been secured.

Installing a child restraint system:

- ▶ Always comply with the child restraint system manufacturer's installation instructions.
- ▶ Pull the seat belt smoothly from the belt loop.
- ▶ Engage the seat belt tongue in the belt buckle.

Activating the special seat belt retractor:

- ▶ Pull the seat belt out fully and let the seat belt retractor retract it again. While the seat belt is retracting, you should hear a ratcheting sound. The special seat belt retractor is activated.
- ▶ Press the child restraint system down so that the seat belt fits tightly and does not slacken.

Removing a child restraint system and deactivating the special seat belt retractor:

- ▶ Always comply with the child restraint system manufacturer's installation instructions.
- ▶ Press the seat belt buckle release button, hold the belt tongue firmly and guide it back towards the belt outlet. The special seat belt retractor is deactivated.

Child restraint system

The use of seat belts and child restraint systems is required by law in:

- all 50 states
- the U.S. territories
- the District of Columbia
- all Canadian provinces

You can obtain further information about the correct child restraint system from any authorized Mercedes-Benz Center.

WARNING

If the child restraint system is installed incorrectly on a suitable seat, it cannot protect as intended. The child cannot then be restrained in the event of an accident, heavy braking or sudden changes of direction. There is an increased risk of injury, possibly even fatal.

Make sure that you observe the child restraint system manufacturer's installation instructions and the notes on use. Please ensure, that the base of the child restraint system is always resting completely on the seat cushion. Never place objects, e.g. cushions, under or behind the child restraint system. Only use child restraint systems with the original cover designed for them. Only replace damaged covers with genuine covers.

WARNING

If the child restraint system is installed incorrectly or is not secured, it can come loose in the event of an accident, heavy braking or a sudden change in direction. The child restraint system could be thrown about, striking vehicle occupants. There is an increased risk of injury, possibly even fatal.

Always install child restraint systems properly, even if they are not being used. Make sure that you observe the child restraint system manufacturer's installation instructions.

You will find further information on stowing objects, luggage or loads under "Loading guidelines" (> page 138).

WARNING

Child restraint systems or their securing systems which have been damaged or subjected to a load in an accident can no longer protect as intended. The child cannot then be restrained in the event of an accident, heavy braking or sudden changes of direction. There is an increased risk of injury, possibly even fatal.

Replace child restraint systems which have been damaged or subjected to a load in an accident as soon as possible. Have the securing systems on the child restraint system checked at a qualified specialist workshop, before you install a child restraint system again.

Securing systems for child restraint systems include:

- the seat belt system
- the Top Tether anchorages

i If you install a child restraint system on the front-passenger seat, make sure that the backrest is securely engaged (> page 64).

i If a child is carried on the front-passenger seat, be sure to observe the information on "Child restraint systems on the front-passenger seat" (> page 47). There you will also find information on disabling the front-passenger front air-bag.

All child restraint systems must meet the following standards:

- U.S. Federal Motor Vehicle Safety Standards 213 and 225
- Canadian Motor Vehicle Safety Standards 213 and 210.2

Confirmation that the child restraint system corresponds to the standards can be found on an instruction label on the child restraint system. This confirmation can also be found in the installation instructions that are included with the child restraint system.

Observe the warning labels in the vehicle interior and on the child restraint system.

Top Tether

Introduction

Top Tether provides an additional connection between the child restraint system and the vehicle. This helps reduce the risk of injury even further. If the child restraint system is fitted with a Top Tether belt, this should always be used.

Top Tether anchorages

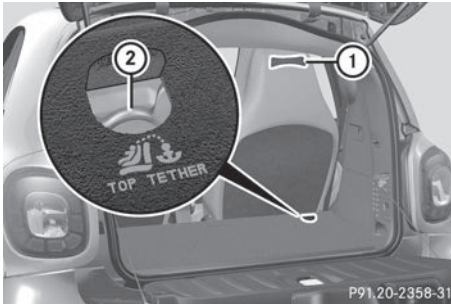

- ① Loop
- ② Top Tether anchorage

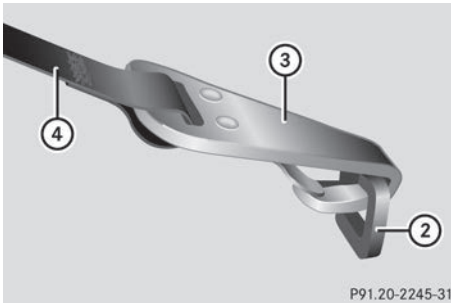

- ② Top Tether anchorage
- ③ Top Tether hook
- ④ Top Tether belt

Top Tether anchorage ② is fitted to the luggage compartment floor.

- ▶ Route Top Tether belt ④ back over the head restraint, keeping it as central as possible, into the luggage compartment through loop ①.
- ▶ Hook Top Tether hook ③ of Top Tether belt ③ into Top Tether anchorage ②.
Lift up the carpet a little if necessary.
Make sure that:
 - Top Tether hook ③ is hooked into Top Tether anchorage ② as shown.
 - Top Tether belt ④ is not twisted.
- ▶ Tension Top Tether belt ④. Always comply with the child restraint system manufacturer's installation instructions when doing so.

Child restraint system on the front-passenger seat

General notes

If you secure a child in a child restraint system on the front-passenger seat, be sure to observe the instructions and safety notes on the "Occupant Classification System (OCS)" (> page 38).

You can thus avoid the risks that could arise as a result of:

- an incorrectly categorized person in the front-passenger seat
- the unsuitable positioning of the child restraint system, e.g. too close to the dashboard

Rearward-facing child restraint system

If it is absolutely necessary to fit a rearward-facing child restraint system to the front-passenger seat, always make sure that the front-passenger front airbag is disabled. Only if the PASSENGER AIR BAG OFF indicator lamp is permanently lit is the front-passenger front airbag disabled.

Always observe the child restraint system manufacturer's installation and operating instructions.

Forward-facing child restraint system

If you secure a child in a forward-facing child restraint system on the front-passenger seat, always move the front-passenger seat as far back as possible. Always make sure that the shoulder belt strap is correctly routed from the front-passenger seat belt guide to the shoulder belt guide on the child restraint system. The shoulder belt strap must be routed forwards and downwards from the front-passenger seat belt guide. If necessary, adjust the front-passenger seat accordingly.

Always observe the child restraint system manufacturer's installation and operating instructions.

Pets in the vehicle

WARNING

If you leave animals unattended or unsecured in the vehicle, they could press buttons or switches, for example.

As a result, they could:

- activate vehicle equipment and become trapped, for example
- activate or deactivate systems, thereby endangering other road users

Unsecured animals could also be flung around the vehicle in the event of an accident or sudden steering or braking, thereby injuring vehicle occupants. There is a risk of an accident and injury.

Never leave animals unattended in the vehicle. Always secure animals properly during the journey, e.g. use a suitable animal transport box.

Protection against theft

Immobilizer

The immobilizer prevents your vehicle from being started without the correct Smart Key.

- ▶ **To activate:** remove the Smart Key from the ignition lock.
- ▶ **To deactivate:** switch on the ignition.

When leaving the vehicle, always take the Smart Key with you and lock the vehicle. The engine can be started by anyone with a valid Smart Key that is left inside the vehicle.

- i** The immobilizer is always deactivated when you start the engine.
- In the event that the engine cannot be started when the starter battery is fully charged, the immobilizer may be faulty. Contact an authorized Mercedes-Benz Center or call 1-800-367-6372 (in USA) or 1-800-387-0100 (in Canada).

Anti-theft alarm system

Triggering the alarm

A visual and audible alarm is triggered if the alarm system is armed and you open:

- the vehicle by using the key in the emergency lock
- a door
- the tailgate
- the service cover

Arming

- ▶ Make sure that:
 - the doors are closed.
 - the tailgate is closed.
 - the service cover is closed.
- ▶ Press the  button on the key. The alarm system is armed after approximately 30 seconds.
- i** If the service cover is open or is not properly closed, the vehicle will be locked. The anti-theft alarm system is armed. To remind you that the service cover is not secured, a warning tone sounds for 30 seconds. Ensure that the service cover is properly closed. Only then is the anti-theft alarm system correctly armed and the service cover properly secured.

Switching off

- ▶ Press the  button on the key.
- or
- ▶ Unlock the vehicle by using the key in the emergency lock.
- and
- Switch on the ignition.

Switching off the alarm

- ▶ **To switch off the alarm:** press the  button on the key. The alarm is switched off.
- or
- ▶ Switch on the ignition. The alarm is switched off.

The alarm is not switched off, even if you close the open door that triggered it, for example.

Driving safety systems

Overview of driving safety systems

In this section, you will find information about the following driving safety systems:

- ABS (Anti-lock Braking System) (▷ page 49)
- Distance warning function (▷ page 50)
- esp® (Electronic Stability Program) (▷ page 51)
- EBD (Electronic Brake force Distribution) (▷ page 52)

Important safety notes

If you fail to adapt your driving style or become distracted, the driving safety systems can neither reduce the risk of accident nor override the laws of physics. Driving safety systems are merely aids designed to assist driving. You are responsible for the distance to the vehicle in front, for vehicle speed and for braking in good time. Always adapt your driving style to suit the prevailing road, weather and traffic conditions and maintain a safe distance from the vehicle in front. Drive carefully.

The driving safety systems described only work as effectively as possible when there is adequate contact between the tires and the road surface. Please pay special attention to the notes on tires, recommended minimum tire tread depths, etc. (▷ page 171).



In wintry driving conditions, always use winter tires (M+S tires) and if necessary, snow chains. Only in this way will the driving safety systems described in this section work as effectively as possible.

For safety reasons, smart recommends that you only use snow chains that have been specially approved for your vehicle by smart, or fine-link snow chains that are of a corresponding standard of quality. For more information, please contact a qualified specialist workshop.

ABS (Anti-lock Braking System)

General information

ABS regulates brake pressure in such a way that the wheels do not lock when you brake. This allows you to continue steering the vehicle when braking.

The  (Canada only) or  (USA only) abs warning lamp in the instrument cluster lights up when the ignition is switched on. It goes out when the engine is running.

Important safety notes

-  Observe the "Important safety notes" section for driving safety systems (▷ page 49).

When ABS is malfunctioning, other systems, including driving safety systems, will also become inoperative. Observe the information on the ABS warning lamp (▷ page 128) and display messages which may be shown in the instrument cluster (▷ page 117).

WARNING

If ABS is faulty, the wheels could lock when braking. The steerability and braking characteristics may be severely impaired. Additionally, further driving safety systems are deactivated. There is an increased danger of skidding and accidents.

Drive on carefully. Have ABS checked immediately at a qualified specialist workshop.

abs works from a speed of about 4 mph (6 km/h), regardless of road-surface conditions. ABS works on slippery surfaces, even if you only brake gently.

Braking

- ▶ **If ABS intervenes:** continue to depress the brake pedal vigorously until the braking situation is over.
- ▶ **To make a full brake application:** depress the brake pedal with full force.

If abs intervenes when braking, you will feel a pulsing in the brake pedal.

The pulsating brake pedal can be an indication of hazardous road conditions, and functions as a reminder to take extra care while driving.

Forward collision warning

General information

The distance warning function can help you to minimize the risk of a collision with a vehicle ahead or reduce the effects of such an accident. If the distance warning function detects that there is a risk of a collision, you will be warned visually and acoustically.

Starting the engine also switches on the distance warning function.

Important safety notes

WARNING

The distance warning function does not react:

- to people or animals
- to oncoming vehicles
- to crossing traffic
- when cornering

Thus, the distance warning function cannot provide a warning in all critical situations. There is a risk of an accident.

Always pay careful attention to the traffic situation and be ready to brake.

WARNING

The distance warning function cannot always clearly identify objects and complex traffic situations.

In such cases, the distance warning function may:

- give an unnecessary warning
- not give a warning

There is a risk of an accident.

Always pay careful attention to the traffic situation and do not rely solely on the distance warning function.

Observe the "Important safety notes" section for driving safety systems (▷ page 49).

In particular, the detection of obstacles can be impaired if:

- there is dirt on the sensors or anything else covering the sensors.
- snow or heavy rain
- interference by other radar sources
- the possibility of strong radar reflections, for example in parking garages
- a narrow vehicle traveling in front, e.g. a motorbike
- a vehicle traveling in front on a different line
- new vehicles or after a service on the distance warning system

Please observe the information in the section on running-in the vehicle (▷ page 85).

Following damage to the front end of the vehicle, have the configuration and operation of the radar sensor checked at a qualified specialist workshop. This also applies to collisions at low speeds where there is no visible damage to the front of the vehicle.

Function

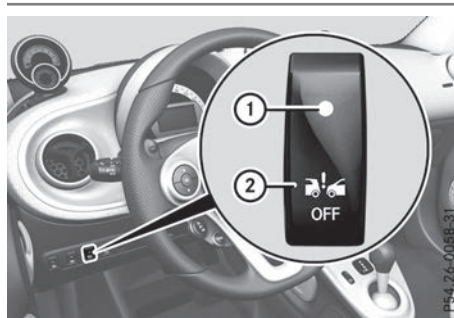

► **To switch off:** press button ②. Indicator lamp ① lights up.

► **To switch on:** press button ②. Indicator lamp ① goes out.

Starting at a speed of around 4 mph (7 km/h), the distance warning function warns you if you rapidly approach a vehicle in front. An intermittent warning tone will then sound and the  distance warning lamp will light up in the instrument cluster.

- ▶ Brake immediately in order to increase the distance from the vehicle in front.

or

- ▶ Take evasive action, provided it is safe to do so.

Due to the nature of the system, particularly complicated but non-critical driving conditions may also cause the system to display a warning.

With the help of the radar sensor system, the distance warning function can detect obstacles that are in the path of your vehicle for an extended period of time.

Up to a speed of around 45 mph (70 km/h), the distance warning function can also react to stationary obstacles, such as stopped or parked vehicles.

ESP® (Electronic Stability Program)

General notes

- i** Observe the "Important safety notes" section (> page 49).

esp® monitors driving stability and traction, i.e. power transmission between the tires and the road surface.

If esp® detects that the vehicle is deviating from the direction desired by the driver, one or more wheels are braked to stabilize the vehicle. The engine output is also modified to keep the vehicle on the desired course within physical limits. esp® assists the driver when pulling away on wet or slippery roads. esp® can also stabilize the vehicle during braking.

ETS (Electronic Traction System)

- i** Observe the "Important safety notes" section (> page 49).

ETS traction control is part of esp®.

ETS brakes the drive wheels individually if they spin. This enables you to pull away and accelerate on slippery surfaces, for example if the road surface is slippery on one side. In addition, more drive torque is transferred to the wheel with traction.

Important safety notes

WARNING

If ESP® is malfunctioning, ESP® is unable to stabilize the vehicle. Additionally, further driving safety systems are deactivated. This increases the risk of skidding and an accident.

Drive on carefully. Have ESP® checked at a qualified specialist workshop.

- !** If you test the parking brake using a brake dynamometer, switch the ignition off. Application of the brakes by ESP® may otherwise destroy the brake system.

When towing the vehicle with the rear axle raised, observe the notes on esp® (> page 166).

If the  esp® warning lamp lights up permanently, esp® or hill start assist are unavailable due to a malfunction.

Observe the information on warning lamps (> page 130) and display messages which may be shown in the instrument cluster (> page 117).

- i** Only use wheels with the recommended tire sizes. Only then will esp® function properly.

Characteristics of ESP®

General information

If the  esp® warning lamp goes out before the journey begins, esp® is automatically active.

If esp® intervenes, the  esp® warning lamp flashes in the instrument cluster.

If esp® intervenes:

- ▶ Only depress the accelerator pedal as far as necessary when pulling away.
- ▶ Adapt your driving style to suit the prevailing road and weather conditions.

Crosswind Assist

General information

Strong crosswinds can cause your vehicle to deviate from a straight course. The crosswind driving assistance function integrated into esp® significantly reduces these effects.

esp® intervenes automatically according to the direction and intensity of the crosswinds affecting your vehicle.

esp® intervenes with stabilizing braking to assist you in keeping the vehicle in the lane.

crosswind assist is active at vehicle speeds above 45 mph (70 km/h) when driving straight ahead or cornering gently.

Important safety notes

crosswind assist does not work if esp® is disabled because of a malfunction.

EBD (electronic brake force distribution)

General information

EBD monitors and controls the brake pressure on the rear wheels to improve driving stability while braking.

Important safety notes

- ⓘ Observe the "Important safety notes" section (▷ page 49).

WARNING

If EBD is malfunctioning, the rear wheels can lock, e.g. under full braking. This increases the risk of skidding and an accident.

You should therefore adapt your driving style to the different handling characteristics. Have the brake system checked at a qualified specialist workshop.

Observe information regarding indicator and warning lamps (▷ page 130) as well as display messages (▷ page 116).

SmartKey

Important safety notes

WARNING

If children are left unsupervised in the vehicle, they could:

- open the doors, thus endangering other people or road users.
- get out and disrupt traffic.
- operate the vehicle's equipment.

Additionally, children could set the vehicle in motion if, for example, they:

- release the parking brake.
- shift the automatic transmission out of park position P or shift manual transmission into neutral.
- start the engine.

There is a risk of an accident and injury.

When leaving the vehicle, always take the SmartKey with you and lock the vehicle.

Never leave children or animals unattended in the vehicle. Always keep the SmartKey out of reach of children.

WARNING

If you attach heavy or large objects to the SmartKey, the SmartKey could be unintentionally turned in the ignition lock. This could cause the engine to be switched off. There is a risk of an accident.

Do not attach any heavy or large objects to the SmartKey. Remove any bulky key rings before inserting the SmartKey into the ignition lock.

- !** Keep the SmartKey away from strong magnetic fields. Otherwise, the remote control function could be affected.



Strong magnetic fields can occur in the vicinity of powerful electrical installations.

Do not keep the SmartKey:

- with electronic devices, e.g. a mobile phone or another SmartKey
- with metallic objects, e.g. coins or metal foil
- inside metallic objects, e.g. a metal case

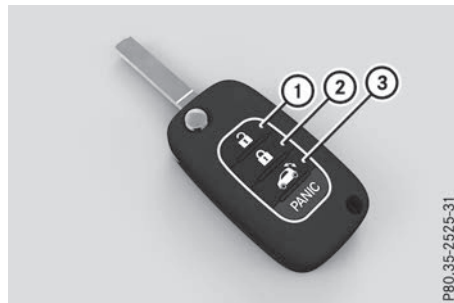
SmartKey functions



- ①  Unlocks the driver's door/vehicle
- ②  Locks the vehicle
- ③  Opens the tailgate

- **To unlock the driver's door:** press the  button.

The  button must be pressed a second time within 20 seconds to unlock the front-passenger's door. This function can be activated or deactivated in the smart Media-System (see the separate operating instructions).

If you do not open the vehicle within approximately 2 minutes of unlocking:

- the vehicle is locked again.
- protection against theft is reactivated

- **To unlock and open the tailgate:** press and hold the button  on the key.

- **To lock centrally:** press the  button.

The SmartKey centrally locks/unlocks:

- the doors
- the tailgate
- the fuel filler flap

When unlocking, the turn signals flash once. When locking, they flash twice.

Locking is confirmed by an audible signal.

SmartKey battery

Important safety notes

WARNING

Batteries contain toxic and corrosive substances. If batteries are swallowed, it can result in severe health problems. There is a risk of fatal injury.

Keep batteries out of the reach of children. If a battery is swallowed, seek medical attention immediately.

The SmartKey batteries contain perchlorate material, which may require special handling and regard for the environment. National guidelines must be observed during disposal. In California, see www.dtsc.ca.gov/HazardousWaste/Perchlorate/index.cfm.

smart recommends that you have the batteries changed at a qualified specialist workshop.

Replacing the battery

You require a CR 2032 3V cell battery.







- ▶ Insert a suitable tool, such as a coin, into the opening of the key. Turn the tool until cover ① of the battery tray opens. When doing so, do not hold cover ① shut.
- ▶ Remove battery tray cover ①.



- ▶ Remove battery ②.
- ▶ Insert the new battery with the positive terminal facing upwards. Use a lint-free cloth to do so.
- ▶ Make sure that the surface of the battery is free of lint, grease and other contaminants.
- ▶ Insert battery tray cover ① into the housing and press to close.
- ▶ Check the function of all SmartKey buttons on the vehicle.

Problems with the SmartKey

Problem	Possible causes/consequences and ► Solutions
<p>You cannot lock or unlock the vehicle using the SmartKey.</p>	<p>The SmartKey battery is discharged or nearly discharged.</p> <ul style="list-style-type: none"> ► Try again to lock/unlock the vehicle using the remote control function of the SmartKey. Do this by pressing the  or  button in the immediate vicinity of the vehicle. <p>If this does not work:</p> <ul style="list-style-type: none"> ► Change the key battery if necessary (▷ page 54). ► Unlock the vehicle with the key in the emergency lock (▷ page 57) or lock the vehicle with the emergency locking (▷ page 57). <p>There is interference from a powerful source of radio waves.</p> <ul style="list-style-type: none"> ► Try again to lock/unlock the vehicle using the remote control function of the SmartKey. Do this by pressing the  or  button in the immediate vicinity of the vehicle. <p>The SmartKey is faulty.</p> <ul style="list-style-type: none"> ► Unlock the vehicle with the key in the emergency lock (▷ page 57) or lock the vehicle with the emergency locking (▷ page 57). ► Have the SmartKey checked at a qualified specialist workshop.
<p>You have lost a Smart-Key.</p>	<ul style="list-style-type: none"> ► Have the SmartKey deactivated at a qualified specialist workshop. ► Report the loss immediately to the vehicle insurers. ► If necessary, have the locks changed as well.
<p>The engine cannot be started using the SmartKey.</p>	<p>the on-board voltage is too low.</p> <ul style="list-style-type: none"> ► Switch off non-essential consumers, e.g. seat heating or interior lighting, and try to start the engine again. <p>If this does not work:</p> <ul style="list-style-type: none"> ► Check the starter battery and charge it if necessary (▷ page 159). <p>or</p> <ul style="list-style-type: none"> ► Jump-start the vehicle (▷ page 162). <p>or</p> <ul style="list-style-type: none"> ► Consult a qualified specialist workshop. <p>The steering lock is mechanically blocked.</p> <ul style="list-style-type: none"> ► Remove the SmartKey and reinsert it into the ignition lock. When you turn the key, turn the steering wheel in both directions.

Doors

Important safety notes

WARNING

If children are left unsupervised in the vehicle, they could:

- open the doors, thus endangering other people or road users.
- get out and disrupt traffic.
- operate the vehicle's equipment.

Additionally, children could set the vehicle in motion if, for example, they:

- release the parking brake.
- shift the automatic transmission out of park position P or shift manual transmission into neutral.
- start the engine.

There is a risk of an accident and injury. When leaving the vehicle, always take the SmartKey with you and lock the vehicle. Never leave children or animals unattended in the vehicle. Always keep the SmartKey out of reach of children.

Preferably stow luggage or loads in the luggage compartment. Observe the loading guidelines (> page 138).

Unlocking and opening doors from the inside



- ▶ Pull door handle ①.
The door opens.

You can open a door from inside the vehicle even if it has been locked.

- ▶ Pull door handle ①.
The door unlocks and opens.

If the vehicle has previously been locked with the key, opening a door from the inside will trigger the anti-theft alarm system. Switch off the alarm (> page 48).

Centrally locking or unlocking the vehicle from the inside

You can centrally lock or unlock the vehicle from the inside. This can be useful if you wish to lock the vehicle before pulling away, for example.

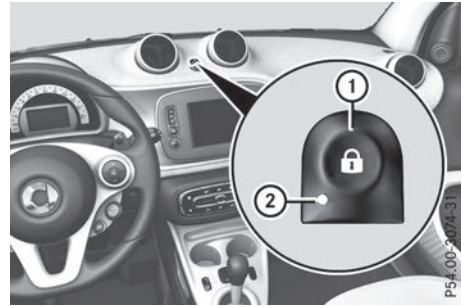

- ▶ **To lock:** when the vehicle is unlocked, press button ①.
The vehicle locks when all the doors and the tailgate are closed. Indicator lamp ② lights up.
- ▶ **To unlock:** when the vehicle is locked, press button ①.
The vehicle is unlocked. Indicator lamp ② goes out.

You can open a door from inside the vehicle even if it has been locked.

If the vehicle has previously been locked with the key element, opening a door from the inside will trigger the anti-theft alarm system. Switch off the alarm (> page 48).

If a locked door is opened from the inside, the previous unlocking is taken into account, if:

- it was locked using the locking button for the central locking, or
- it was locked automatically

The vehicle will be fully unlocked if it had previously been fully unlocked. If only the

driver's door had been previously unlocked, then only the door which has been opened from the inside is unlocked.

You cannot unlock the vehicle centrally from the inside if the vehicle has been locked with the SmartKey.

Automatic locking feature



- ▶ **To deactivate:** with the ignition switched on, press and hold button ① for about five seconds until a tone sounds.
- ▶ **To activate** with the ignition switched on, press and hold button ① for about five seconds until a tone sounds.

The vehicle is locked automatically when the ignition is switched on and the wheels are turning.

You could therefore lock yourself out if:

- the vehicle is being pushed.
- the vehicle is being towed.
- the vehicle is on a roller dynamometer.

You can also switch the automatic locking function on or off in the smart Media-System; see the separate operating instructions.

Unlocking the driver's door (emergency lock)

If you can no longer unlock the vehicle using the remote control key, use the emergency lock.

If you use the key element in the emergency lock to unlock and open the driver's door, the anti-theft alarm system will be triggered. Switch off the alarm (▷ page 48).

- ▶ Carefully remove the cover from the emergency lock.
- ▶ Insert the key element into the emergency lock of the driver's door as far as it will go.

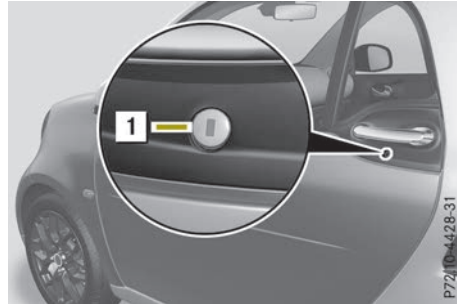

- ▶ Turn the key element anti-clockwise as far as it will go to position ①. The door is unlocked.
- ▶ Turn the key element back and remove it.
- ▶ Replace the cover on the emergency lock and press until it engages.

Locking the driver's door (emergency locking)

If you can no longer lock the vehicle using the remote control key, use the locking button on the instrument cluster (▷ page 56).

- ▶ Remove the SmartKey from the ignition lock.
- ▶ Open the driver's door.
- ▶ Close the front-passenger door and the tailgate.
- ▶ Press and hold the locking button for at least 5 seconds (▷ page 56). After 5 seconds the vehicle is audibly locked.
- ▶ Leave the vehicle and close the driver's door.

Do not leave the SmartKey in the vehicle. Otherwise, you could lock yourself out. The doors, tailgate and fuel filler flap are locked. The anti-theft alarm system is primed.

- ▶ Make sure that the doors and the tailgate are locked.

If this does not work, use the emergency key to lock the vehicle.

- ▶ Open the driver's door.

- ▶ Close the front-passenger door and the tailgate.
- ▶ Press the locking button (▷ page 56).
- ▶ Check whether the front-passenger door is locked. If necessary, carry out the following steps on both doors.

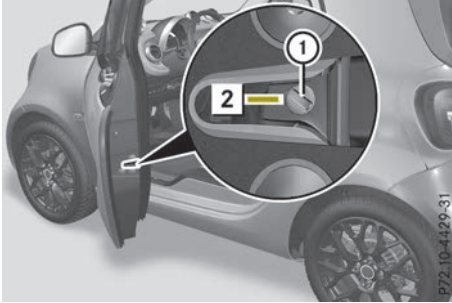

- ▶ Insert the tip of the key element into slit ①.
- ▶ Turn the key element anti-clockwise as far as it will go to position ②.
On the passenger door, the direction of rotation is reversed.
- ▶ Close the driver's door.
- ▶ Check that the doors are locked.

i If you lock the vehicle using the emergency locking, the tailgate and fuel filler flap are not locked. The anti-theft alarm system is not primed.

Cargo compartment

Important safety notes

⚠ WARNING

Combustion engines emit poisonous exhaust gases such as carbon monoxide. If the tailgate is open when the engine is running, particularly if the vehicle is moving, exhaust fumes could enter the passenger compartment. There is a risk of poisoning.

Turn off the engine before opening the tailgate. Never drive with the tailgate open.

⚠ WARNING

If objects, luggage or loads are not secured or not secured sufficiently, they could slip, tip over or be flung around and thereby hit vehicle occupants. There is a risk of injury, particularly in the event of sudden braking or a sudden change in direction.

Always store objects so that they cannot be flung around. Secure objects, luggage or loads against slipping or tipping before the journey.

! Do not exceed the lower tailgate maximum load of 220 lbs (100 kg). It may otherwise become damaged.

! The tailgate swings backwards, upwards and downwards when opened. Therefore, make sure that there is sufficient space above, behind and under the tailgate.

i The opening dimensions of the tailgate can be found in the "Vehicle data" section (▷ page 204).

Preferably stow luggage or loads in the luggage compartment. Observe the loading guidelines (▷ page 138).

Do not leave the SmartKey in the cargo compartment. You could otherwise lock yourself out.

Opening or closing

Opening the upper tailgate

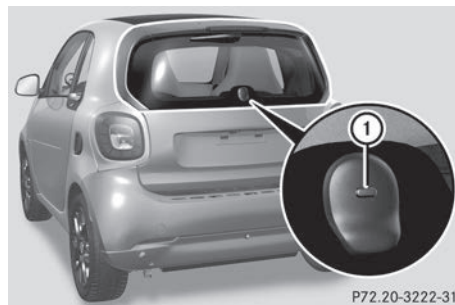

- ▶ If the vehicle is locked, first press the  button on the key.

Press button ①.

The upper tailgate opens slightly.

or

- ▶ Press and hold the  button on the key. The upper tailgate opens slightly.

or

- ▶ Press the  button on the left under the steering wheel. The upper tailgate opens slightly.
- ▶ Swing the upper tailgate up.

Opening the lower tailgate

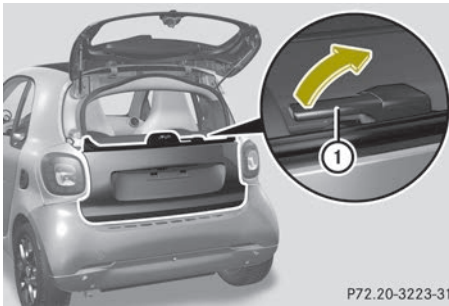

P72.20-3223-31

- ▶ Pull release catch ① upwards. Swing the lower tailgate down.

Closing the tailgate



P72.20-3224-31

- ▶ Swing the lower tailgate upwards until it engages audibly.
- ▶ Pull the upper tailgate down and push closed.
- ▶ If necessary, lock the vehicle with the  button on the key.

Side windows

Important safety notes

WARNING

While closing the side windows, body parts in the closing area could become trapped. There is a risk of injury.

When closing make sure that no parts of the body are in the closing area. If somebody becomes trapped, release the switch or press the switch to open the side window again.

WARNING

If children operate the side windows they could become trapped, particularly if they are left unsupervised. There is a risk of injury.

When leaving the vehicle, always take the SmartKey with you and lock the vehicle. Never leave children unsupervised in the vehicle.

Side window reversing feature

In vehicles with the convenience feature, the side windows are equipped with an automatic reversing feature. If a solid object blocks or restricts a side window from traveling upwards during the automatic closing process, the side window opens again automatically. During the manual closing process, the side window only opens again automatically after the corresponding switch is released. The automatic reversing feature is only an aid and is no substitute for your attention when closing a side window.

WARNING

The reversing feature does not react:

- to soft, light and thin objects, e.g. small fingers
- while resetting

This means that the reversing feature cannot prevent someone being trapped in these situations. There is a risk of injury.

Make sure that no body parts are in close proximity during the closing procedure. If someone becomes trapped, press the switch to open the side window again.

WARNING

If you close a side window again immediately after it has been blocked or reset, the side window closes with increased or maximum force. The reversing feature is then not active. Parts of the body could be trapped in the closing area in the process. This poses an increased risk of injury or even fatal injury.

Make sure that no parts of the body are in the closing area. To stop the closing process, release the switch or push the switch again to reopen the side window.

Opening or closing the side window

The switches for both side windows are located on the driver's door. There is also a switch for the front-passenger side window on the front-passenger door.

The switch on the driver's door takes precedence.

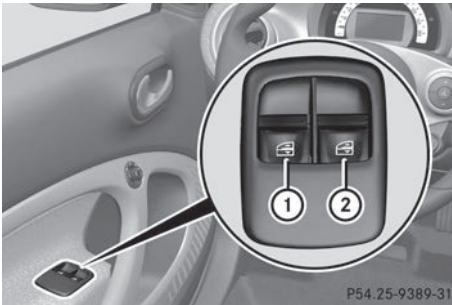

- ① Left
- ② Right

- ▶ Turn the key to position **1** or **2** in the ignition lock.
- ▶ **To open manually:** press and hold the corresponding button.
- ▶ **To open fully:** press the button beyond the point of resistance and release it. Automatic closing is started.

- ▶ **To close manually:** pull the corresponding button and hold it.

▶ Vehicles with convenience control:

To close fully: pull the button beyond the point of resistance and release it. Automatic closing is started.

- ▶ **To interrupt automatic opening/closing:** press/pull the corresponding switch again.

i If you press the switch beyond the point of resistance while opening, automatic operation is started. In vehicles with convenience control, you can also start automatic operation when closing. To do so, pull the switch beyond the point of resistance.

You can stop automatic operation by operating the switch again.

- i** You can continue to operate the side windows after turning the key to position **0** in the ignition lock or removing the key. This function remains active for 3 minutes or until you open a door.

Resetting the side window

You must reset each side window if:

- the side window opens again slightly after being closed fully.
- the side window can no longer be fully opened or closed.
- ▶ Close all the doors.
- ▶ Turn the SmartKey to position **2** in the ignition lock.
- ▶ Pull the corresponding switch on the door control panel until the side window is completely closed (▷ page 60).
- ▶ Hold the switch for an additional second.

If the side window opens again slightly:

- ▶ Immediately pull the corresponding switch on the door control panel until the side window is completely closed (▷ page 60).
- ▶ Hold the switch for an additional second.
- ▶ If the respective side window remains closed after the button is released, then it has been set correctly. If this is not the case, repeat the steps above again.

Problems with the side windows

⚠ WARNING

If you close a side window again immediately after it has been blocked or reset, the side window closes with increased or maximum force. The reversing feature is then not active. Parts of the body could be trapped in the closing area in the process. This poses an increased risk of injury or even fatal injury.

Make sure that no parts of the body are in the closing area. To stop the closing process, release the switch or push the switch again to reopen the side window.

Problem	Possible causes/consequences and ► Solutions
A side window cannot be closed because it is blocked by objects, e.g. leaves in the window guide.	<ul style="list-style-type: none"> ► Remove the objects. ► Close the side window.
A side window cannot be closed and you cannot see the cause.	<p>If a side window is obstructed during closing and reopens again slightly:</p> <ul style="list-style-type: none"> ► Immediately after the window blocks, pull the corresponding switch again until the side window has closed. The side window is closed with increased force. <p>If a side window is obstructed again during closing and reopens again slightly:</p> <ul style="list-style-type: none"> ► Immediately after the window blocks, pull the corresponding switch again until the side window has closed. The side window is closed without the anti-entrapment feature.

>> Opening and closing.

Operating the roller sunblind for the panoramic roof

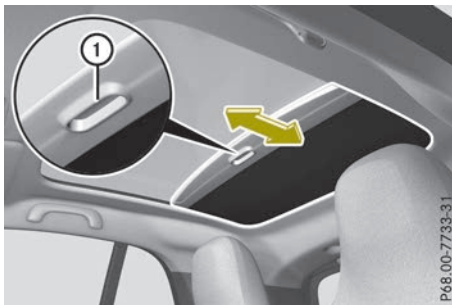

The roller sunblind shields the vehicle interior from sunlight.

- **To open:** press the roller sunblind up by the outer edge of recess ① and slide it backwards.
- **To close:** pull the roller sunblind forward by the outer edge of recess ① until it is fully closed.

P68.00-7733-31

Correcting the driver's seat position

WARNING

You could lose control of your vehicle if you do the following while driving:

- adjust the driver's seat, steering wheel or mirrors
- fasten the seat belt

There is a risk of an accident.

Adjust the driver's seat, steering wheel or mirrors and fasten your seat belt before starting the engine.



Example

Observe the safety guidelines on seat adjustment (▷ page 62).

- ▶ Make sure that seat ③ is adjusted properly.
Adjusting the seats (▷ page 63)
When adjusting the seat, make sure that:
 - you are as far away from the driver's air bag as possible.
 - you are sitting in a normal upright position.
 - you can fasten the seat belt properly.
 - you have moved the backrest to an almost vertical position.
 - you can depress the pedals properly.

Observe the safety guidelines on steering wheel adjustment (▷ page 66).

- ▶ Make sure that steering wheel ① is adjusted properly.

Adjusting the steering wheel (▷ page 66)
When adjusting the steering wheel, make sure that:

- you can hold the steering wheel with your arms slightly bent.
- you can move your legs freely.
- you can see all the displays in the instrument cluster clearly.

Observe the safety guidelines for seat belts (▷ page 33).

- ▶ Check whether you have fastened seat belt ② properly (▷ page 34).

The seat belt should:

- fit snugly across your body
 - be routed across the middle of your shoulder
 - be routed in your pelvic area across the hip joints
- ▶ Before starting off, adjust the rear-view mirror and the exterior mirrors (▷ page 67) in such a way that you have a good view of road and traffic conditions.

Seats

Important safety notes

WARNING

Children could become trapped if they adjust the seats, particularly when unattended. There is a risk of injury.

When leaving the vehicle, always take the SmartKey with you and lock the vehicle. Never leave children unsupervised in the vehicle.

WARNING

If the driver's seat is not engaged, it could move unexpectedly while the vehicle is in motion. This could cause you to lose control of the vehicle. There is a risk of an accident.

Always make sure that the driver's seat is engaged before starting the vehicle.

⚠ WARNING

You could lose control of your vehicle if you do the following while driving:

- adjust the driver's seat, steering wheel or mirrors
- fasten the seat belt

There is a risk of an accident.

Adjust the driver's seat, steering wheel or mirrors and fasten your seat belt before starting the engine.

⚠ WARNING

When you adjust a seat, you or other vehicle occupants could become trapped, e.g. on the seat guide rail. There is a risk of injury.

Make sure when adjusting a seat that no one has any body parts in the sweep of the seat.

⚠ WARNING

The seat belt does not offer the intended level of protection if you have not moved the backrest to an almost vertical position. When braking or in the event of an accident, you could slide underneath the seat belt and sustain abdomen or neck injuries, for example. This poses an increased risk of injury or even fatal injury.

Adjust the seat properly before beginning your journey. Always ensure that the backrest is in an almost vertical position and that the shoulder section of your seat belt is routed across the center of your shoulder.

Observe the safety notes on "Airbags" (▷ page 36) and "Children in the vehicle" (▷ page 44).

! To avoid damage to the seats and the seat heating, observe the following information:

- keep liquids from spilling on the seats. If liquid is spilled on the seats, dry them as soon as possible.
- if the seat covers are damp or wet, do not switch on the seat heating. The seat heating should also not be used to dry the seats.

- clean the seat covers as recommended; see the "Interior care" section.
- do not transport heavy loads on the seats. Do not place sharp objects on the seat cushions, e.g. knives, nails or tools. The seats should only be occupied by passengers, if possible.
- when the seat heating is in operation, do not cover the seats with insulating materials, e.g. blankets, coats, bags, seat covers, child seats or booster seats.

! Make sure that there are no objects in the footwell under or behind the seats when moving the seats back. There is a risk that the seats and/or the objects could be damaged.

Adjusting the seats

Illustration of variant 1



Illustration of variant 2

Seat fore-and-aft adjustment

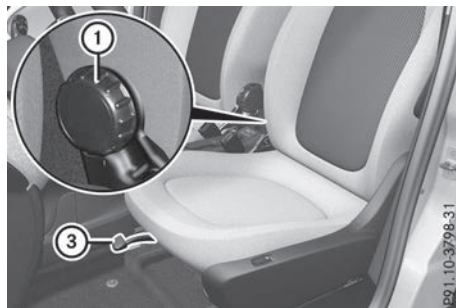
- Remove the seat belt from the belt loop by opening the press stud.

- ▶ Lift handle ③ and slide the seat forwards or rearwards.
- ▶ Release lever ③ again.
Make sure that you hear the seat engage in position.

Backrest angle

Variant 1

- ▶ Relieve the pressure on the backrest.
- ▶ Turn handwheel ① forwards or backwards.

Variant 2

- ▶ Relieve the pressure on the backrest.
- ▶ Pull release lever ①.
The backrest is released.
- ▶ Move the backrest forwards or backwards.
- ▶ Let go of release lever ① again.

Seat height¹

- ▶ **Only variant 2:** pull handle ② up or push it down repeatedly until the seat has reached the desired height.

Folding down the front-passenger seat

You can increase the size of the luggage compartment by folding the front-passenger seat backrest forwards.

Observe the loading guidelines (> page 138) and the notes in the "Child restraint system on the front-passenger seat" section (> page 47).

Folding down



Illustration of variant 1



Illustration of variant 2

Variant 1:

- ▶ Slide the right-hand front seat to its rear-most position.
- ▶ Turn handwheel ① forward until the desired seat backrest position is achieved

Variant 2:

- ▶ Slide the right-hand front seat to its rear-most position.
- ▶ Hold onto the backrest at the head restraint with one hand.
- ▶ Pull release lever ①.
The backrest is released.
- ▶ Fold the seat forwards.

¹ Only driver's seat, depending on equipment.

Folding back

⚠ WARNING

If the seat backrest is not engaged, it may fold forwards, e.g. during braking or in the event of an accident.

- As a result, a backrest which is not engaged would press you into the seat belt. The seat belt can no longer offer the intended level of protection and can even cause injuries.
- The backrest cannot restrain objects or loads in the trunk.

There is an increased risk of injury.

Before every journey, make sure that the backrest is engaged as described.

Variant 1:

- ▶ Turn handwheel ① back until the desired seat backrest position is achieved

Variant 2:

- ▶ Pull release lever ①. The backrest is released.
- ▶ Fold the backrest backwards.
- ▶ Ensure that the seat backrest is engaged again.

Switching the seat heating on/off

Activating/deactivating

⚠ WARNING

Repeatedly switching on the seat heating can cause the seat cushion and backrest

pads to become very hot. The health of persons with limited temperature sensitivity or a limited ability to react to excessively high temperatures may be affected or they may even suffer burn-like injuries. There is a risk of injury.

Therefore, do not switch the seat heating on repeatedly.

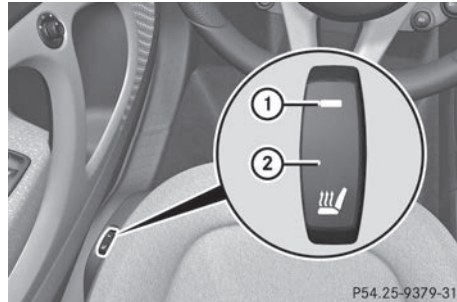

- ▶ Turn the SmartKey to position 2 in the ignition lock (> page 86).
- ▶ **To switch on:** press button ②. Indicator lamp ① in the button lights up.
- ▶ **To switch off:** press button ②. Indicator lamp ① in the button goes out.

i If the battery voltage is too low, the seat heating may switch off. The seat heating switches off automatically after about 10 minutes.

Problems with the seat heating

Problem	Possible causes/consequences and ▶ Solutions
The seat heating has switched off prematurely or cannot be switched on.	The on-board voltage is too low because too many electrical consumers are switched on. ▶ Switch off electrical consumers that you do not need, such as the rear window defroster or interior lighting. Once the battery is sufficiently charged, the seat heating will switch back on automatically.

Steering wheel

Important safety notes

WARNING

You could lose control of your vehicle if you do the following while driving:

- adjust the driver's seat, steering wheel or mirrors
- fasten the seat belt

There is a risk of an accident.

Adjust the driver's seat, steering wheel or mirrors and fasten your seat belt before starting the engine.

WARNING

Children could injure themselves if they adjust the steering wheel. There is a risk of injury.

When leaving the vehicle, always take the SmartKey with you and lock the vehicle. Never leave children unsupervised in the vehicle.

Adjusting the steering wheel

WARNING

If the steering wheel is unlocked while the vehicle is in motion, it could change position unexpectedly. This could cause you to lose control of the vehicle. There is a risk of an accident.

Before starting off, make sure the steering wheel is locked. Never unlock the steering wheel while the vehicle is in motion.

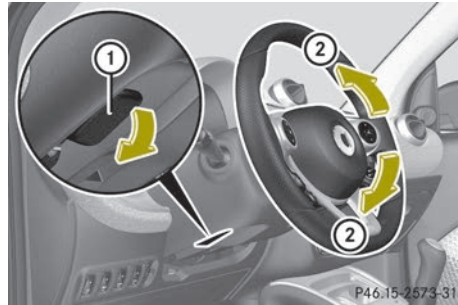

① Release lever

② To adjust the steering wheel height

- ▶ Push release lever ① down completely. The steering column is unlocked.
- ▶ Set desired steering wheel height ②.
- ▶ Push release lever ① up completely. The steering column is locked.
- ▶ Check if the steering column is locked. To do so, try and push the steering wheel up or down.

Mirrors

Rear-view mirror

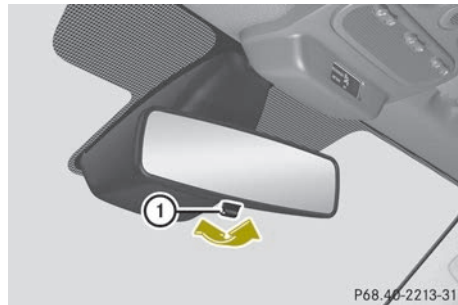

- ▶ **Anti-glare mode:** pivot anti-glare switch ① forwards or back.

Exterior mirrors

Important safety notes

WARNING

You could lose control of your vehicle if you do the following while driving:

- adjust the driver's seat, steering wheel or mirrors
- fasten the seat belt

There is a risk of an accident.

Adjust the driver's seat, steering wheel or mirrors and fasten your seat belt before starting the engine.

WARNING

The exterior mirrors reduce the size of the image. Visible objects are actually closer than they appear. This means that you could misjudge the distance from road users traveling behind, e.g. when changing lane. There is a risk of an accident.

For this reason, always make sure of the actual distance from the road users traveling behind by glancing over your shoulder.

Adjusting the exterior mirrors manually

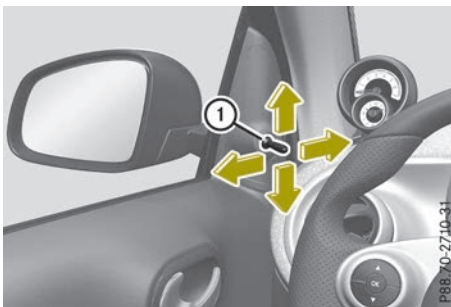

- ▶ **To adjust the mirror:** move lever ① to the right or left, up or down.

Adjusting the exterior mirrors electrically

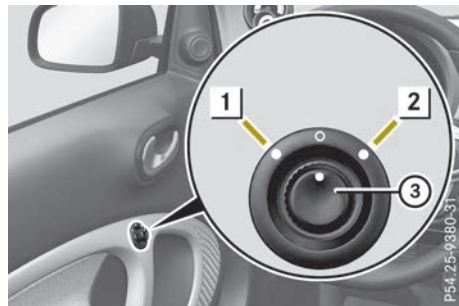

- ▶ Turn the SmartKey to position 1 or 2 in the ignition (> page 86).
- ▶ **To select an exterior mirror:** turn control ③ to position 1 for the left exterior mirror or to position 2 for the right exterior mirror.
- ▶ **To adjust the mirror:** move control ③ to the right or left, up or down.

The exterior mirrors can be heated by switching on the rear window heating (> page 82).

Exterior mirror pushed out of position

If an exterior mirror has been pushed forwards or backwards out of position, push the exterior mirror into the correct position manually.

Exterior lighting

General notes

For reasons of safety, smart recommends that you drive with the lights switched on even during the daytime. In some countries, operation of the headlamps varies due to legal requirements and self-imposed obligations.

Exterior lighting settings

Operation

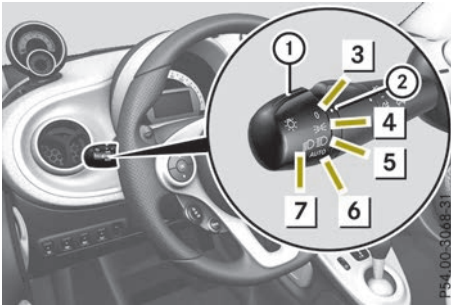

- ① Combination switch control
- ② Marking
- 3 0 Lights off
- 4 Standing lamp, parking lamp, license plate lighting
- 5 High-beam headlamps
- 6 **AUTO** Automatic headlamp mode, controlled by the light sensor
- 7 Low-beam headlamps

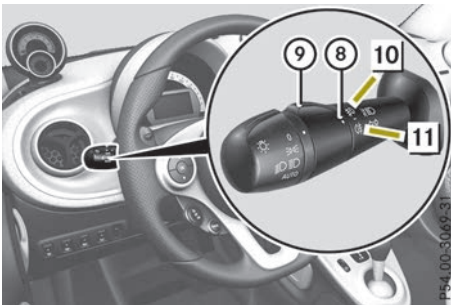

- 8 Marking
- 9 Combination switch middle ring
- 10 Front fog lamps
- 11 Rear fog lamp

>> Lights and windshield wipers.

If you hear a warning tone when you leave the vehicle, the lights may still be switched on.

- ▶ Turn combination switch control ① until **AUTO** or 0 is at marking ②.

When in the **AUTO** position the exterior lighting switches off automatically if you:

- switch off the engine
- open the driver's door
- lock the vehicle
- do not switch on the high beam headlamps

Automatic headlamp mode

AUTO is the favored light switch setting. The light setting is automatically selected according to the brightness of the ambient light (exception: poor visibility due to weather conditions such as fog, snow or spray):

- With the engine running: depending on the ambient light conditions, the daytime driving lights or the parking and low beam headlamps are switched on or off automatically

- ▶ **To switch on automatic headlamp mode:** turn combination switch control ① until **AUTO** is at marking ②.

WARNING

When the light switch is set to **AUTO**, the low-beam headlamps may not be switched on automatically if there is fog, snow or other causes of poor visibility due to the weather conditions such as spray. There is a risk of an accident.

In such situations, turn the light switch to .

The automatic headlamp feature is only an aid. The driver is responsible for the vehicle's lighting at all times.

Low-beam headlamps

- ▶ **To switch on:** turn combination switch control ① until is at marking ②. The indicator lamp in the instrument cluster lights up.





Parking lamps

- ▶ **To switch on:** turn combination switch control ① until  is at marking ②.

Canada only: the parking lamps are only switched on when the engine is switched off. When the engine is running, the low beam headlamps are switched on.





Front fog lamps

Only vehicles with front fog lamps have the fog lamps function.

- ▶ **To switch on:** make sure that the parking lamps or low beam headlamps are switched on.
- ▶ Turn combination switch middle ring ⑨ until marking ⑧ is at . The  indicator lamp in the instrument cluster lights up. After releasing, the middle ring returns automatically back to the neutral position.
- ▶ **To switch off:** turn combination switch middle ring ⑨ until marking ⑧ is at . The  indicator lamp in the instrument cluster goes out. After releasing, the middle ring returns automatically back to the neutral position.

- i** If you switch off the engine (only in the **AUTO** position) or turn off the lights, the foglamps are also switched off.

Rear fog lamp

- ▶ **To switch on:** make sure that the fog lamps or low beam headlamps are switched on.
- ▶ Turn combination switch middle ring ⑨ until marking ⑧ is at . The  indicator lamp in the instrument cluster lights up. After releasing, the middle ring returns automatically back to the neutral position.
- ▶ **To switch off:** turn combination switch middle ring ⑨ until marking ⑧ is at . The  indicator lamp in the instrument cluster goes out. After releasing, the middle ring returns automatically back to the neutral position.

- i** If you switch off the engine (only in the **AUTO** position) or turn off the lights, the rear foglamps are also switched off.

Switching on the turn signals

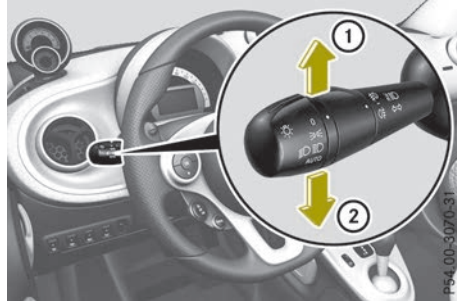



- ▶ Start the engine.
- ▶ **To indicate briefly:** press the combination switch briefly to the pressure point in the direction of arrow ① (right turn signal) or ② (left turn signal). The corresponding turn signal flashes three times.
- ▶ **To indicate:** press the combination switch beyond the pressure point in the direction of arrow ① (right turn signal) or ② (left turn signal).

Switching on the high beam headlamps and high beam flasher

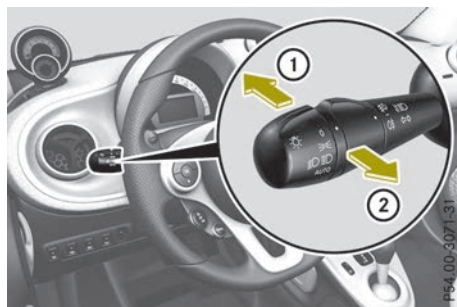
High-beam headlamps



- ▶ **To switch on:** start the engine.
- ▶ Turn the combination switch control until  or **AUTO** (if available) is at the marking.

- ▶ Press the combination switch beyond the pressure point in the direction of arrow ①.
The  indicator lamp in the instrument cluster lights up.
- ▶ **To deactivate:** move combination switch ① back to its normal position.
The  indicator lamp in the instrument cluster goes out.

High-beam flasher

- ▶ **To switch on:** pull the combination switch in the direction of arrow ②.

Hazard warning lamps



The hazard warning lamps automatically switch on if:

- an air bag is deployed
- the vehicle decelerates rapidly from a speed of above 45 mph (70 km/h) and comes to a standstill

- ▶ **To switch on the hazard warning lamps:** press button ①.
All turn signals flash.
- ▶ **To switch off the hazard warning lamps:** press button ①.

The hazard warning lamps switch off automatically if the vehicle reaches a speed of above 6 mph (10 km/h) again after a full brake application.

- ❗ The hazard warning lamps still operate if the ignition is switched off.

Headlamps fogged up on the inside

Certain climatic and physical conditions may cause moisture to form in the headlamp. This moisture does not affect the functionality of the headlamp.

Interior lighting

Overview

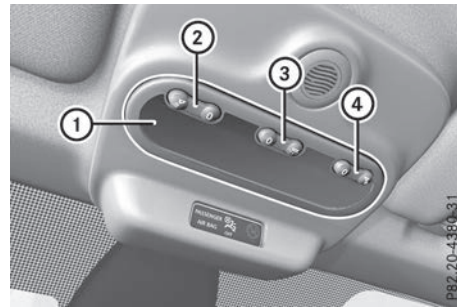

- ① Interior lighting
- ② Switches the left-hand reading lamp on/off
- ③ Depending on the position of the switch:
Interior lighting switched on
Automatic interior lighting control on
Interior lighting switched off
- ④ Switches the right-hand reading lamp on/off

The interior lighting is switched on when a door is open: if the corresponding door is closed correctly the interior lighting goes out.

Interior lighting control

If the doors are unlocked with the remote control, the interval timer for the interior lighting is triggered. The interval timer restarts when a door is opened.

The front interior lighting and the luggage compartment light go out gradually.

The interior lighting interval timer is switched off:

- if a door remains open, the interior lighting switches off after 15 minutes without dimming
- if all doors (with additional locking mechanism) are closed, the interior lighting switches off after 15 seconds
- if all doors (without locking mechanism) are closed, the interior lighting switches off after 3 to 4 minutes
- as soon as the engine is started and for as long as the engine is running

Replacing bulbs

Important safety notes

WARNING

Bulbs, lamps and connectors can get very hot when operating. If you change a bulb, you could burn yourself on these components. There is a risk of injury.

Allow these components to cool down before changing a bulb.

Do not use a bulb that has been dropped or if its glass tube has been scratched.

The bulb may explode if:

- you touch it
- it is hot
- you drop it
- you scratch it

Only operate bulbs in enclosed lamps designed for that purpose. Only fit spare bulbs of the same type and the specified voltage.

Marks on the glass tube reduce the service life of the bulbs. Do not touch the glass tube with your bare hands. If necessary, clean the glass tube when cold with alcohol or spirit and rub it off with a lint-free cloth.

Protect bulbs from moisture during operation. Do not allow bulbs to come into contact with liquids.

Replace only the bulbs listed (▷ page 71).

If you require assistance replacing bulbs, consult a qualified specialist workshop.

If the new bulb still does not light up, consult a qualified specialist workshop.

The daytime driving lights and part of the rear light clusters of your vehicle are equipped with LED light bulbs. Do not replace these bulbs yourself. Contact a qualified specialist workshop which has the necessary specialist knowledge and tools to carry out the work required.

Headlamps and lamps are an important aspect of vehicle safety. You must therefore make sure that these function correctly at all times. Have the headlamp setting checked regularly.

Overview: changing bulbs/bulb types

You can replace the following bulbs. The bulb type can be found in the legend.

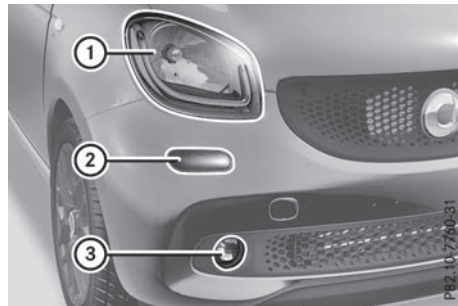

- ① Low-beam/high-beam headlamps: HB2
- ② Turn signal lamp: PY 21 W
- ③ Foglamps: H16

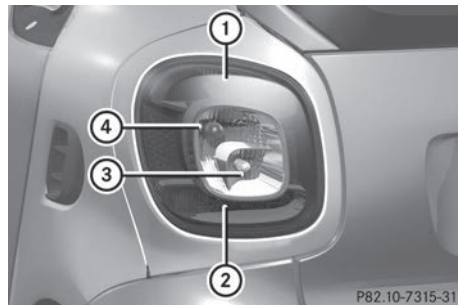

Tail lamp

- ① Tail lamp/brake lamp/side marker lamp: P 21 5 W
- ② Rear fog lamp: P 21 W

- ③ Backup lamp: W 16 W
- ④ Turn signal lamp: PY 21 W

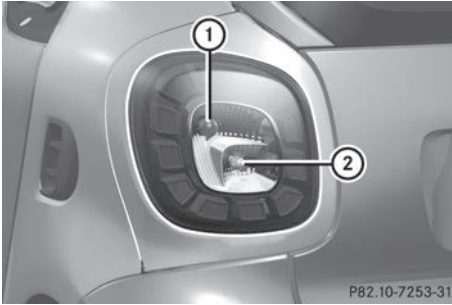

Tail lamps (vehicles with partial LEDs)

- ① Turn signal lamp: PY 21 W
- ② Backup lamp: W 16 W

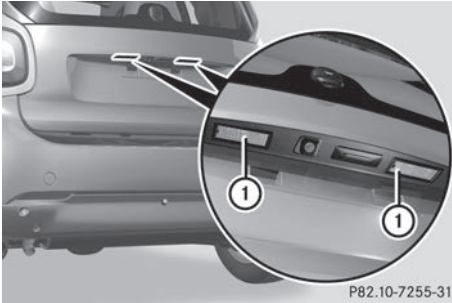

- ① License plate lighting: W 5 W

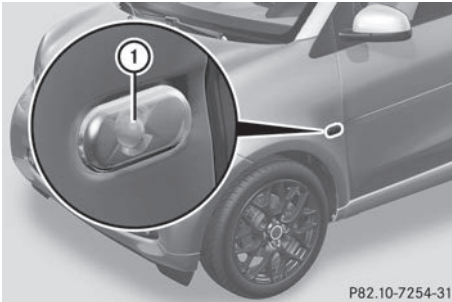

- ① Side turn signal lamps: WY 5 W



- ① Interior lighting: W 5 W

Changing the front bulbs

Important safety notes

⚠ WARNING

The radiator fan may continue to run after the engine has been switched off or start without warning. There is a risk of injury.

If you need to operate in the front area:

- switch off the ignition
- take off jewelry and watches
- never reach into the fan rotation area
- keep clothing and hair, for example, away from the fan.

Turn signal



- ▶ **To remove the cover in the front wheel arch:** switch off the lighting system.
- ▶ Turn the front wheels inwards.
- ▶ Press spring clip ① down.
- ▶ Slide cover ② back and remove it.

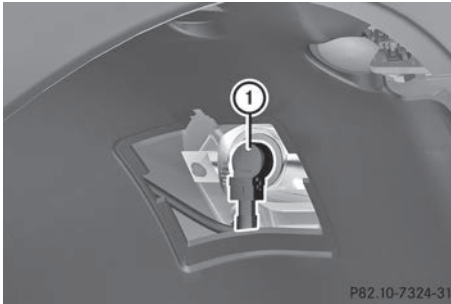

P82.10-7324-31

- ▶ Turn bulb holder ① anti-clockwise and remove.
- ▶ Remove the bulb out of bulb holder ①.
- ▶ Insert the new bulb into bulb holder ①.
- ▶ Insert bulb holder ① and turn it clockwise until it engages.
- ▶ **To fit the cover in the front wheel arch:** insert cover ② again and lock in place.

Low-beam/high-beam headlamps

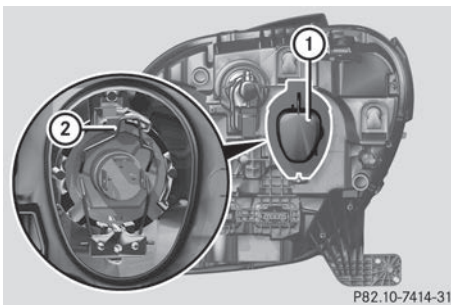

P82.10-7414-31

- ▶ Switch off the lights.
- ▶ Open the service cover (▷ page 147).
- ▶ Remove cover ①.
- ▶ Pull out the connector.
- ▶ Simultaneously press retainer ② forward and to the right and then remove the lamp.
- ▶ Insert the new bulb and engage it in place.
- ▶ Insert the connector.
- ▶ Position cover ① and press into place.

Front fog lamps

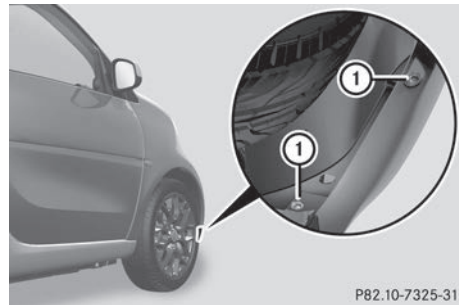

P82.10-7325-31

Due to their location, have the bulbs in the front fog lamps changed at a qualified specialist workshop.

- ▶ Switch off the lights.
- ▶ Remove the two screws ① at the bottom of the front wheel arch using a suitable tool.
- ▶ Bend back the cover using your hand.
- ▶ Turn the bulb holder anti-clockwise and remove it.
- ▶ Remove the bulb out of bulb holder.
- ▶ Insert new bulb into the bulb holder.
- ▶ Insert the bulb holder and turn it clockwise until it engages.
- ▶ Bend the cover back into position.
- ▶ Tighten the two screws ① again.

Side turn signal lamps

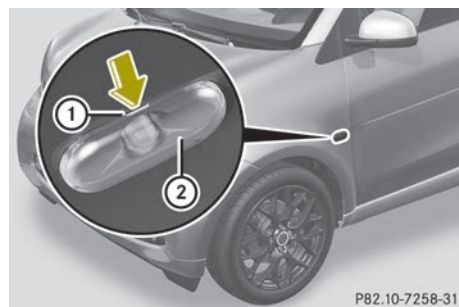

P82.10-7258-31

- ▶ Insert a flat tool into recess ① and lever side turn signal lamp ② forwards and out.
- ▶ Remove the bulb holder from side turn signal lamp ② by turning it a quarter turn anti-clockwise.
- ▶ Pull the bulb out of bulb holder.
- ▶ Insert the new bulb into the bulb holder.

>> Lights and windshield wipers.

- ▶ Insert the bulb holder into side turn signal lamp ② and turn it a quarter turn clockwise.
- ▶ Insert side turn signal lamp ②.

Changing the rear bulbs

Tail lamp

- ▶ Switch off the lights.
- ▶ **To remove:** open the upper and lower tailgate (▷ page 58).

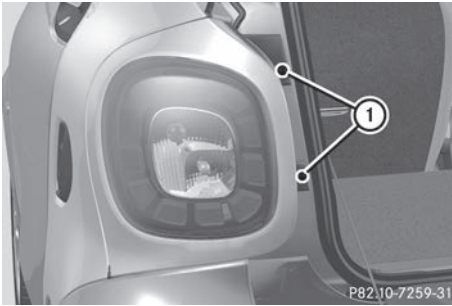

- ▶ Remove two screws ① on the tail lamp using a suitable slotted screwdriver.
- ▶ Carefully take out the lamp.
- ▶ To release the connector: insert a suitable slotted screwdriver under the plastic hanger, lift a small plastic piece upwards and remove the connector.

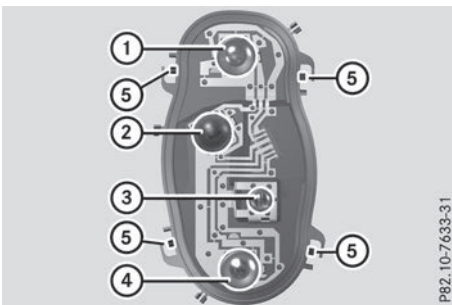

Bulb holder

- ① Tail lamp/brake lamp/side marker lamps (only vehicles without partial LEDs)
- ② Turn signal
- ③ Backup lamp
- ④ Rear foglamp (vehicles without partial LEDs)

- ▶ Unclip four bulb holder tabs ⑤ and carefully remove the bulb holder.
- ▶ Remove the corresponding bulb from the bulb holder.
- ▶ Insert the new bulb.
- ▶ Re-install bulb holder. Four bulb holder tabs ⑤ must audibly engage.
- ▶ Insert the connector.
- ▶ Insert the lamp again.
- ▶ Tighten the two screws ① on the tail lamp again.

License plate lamp

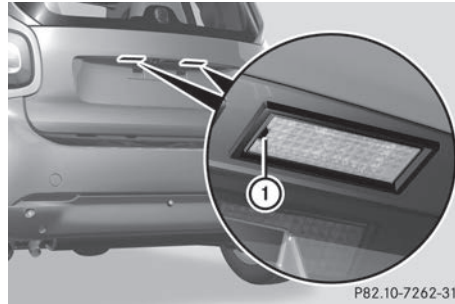

- ▶ **To remove:** release catch ① of the lamp lens using a suitable tool.
- ▶ Remove the lamp lens.

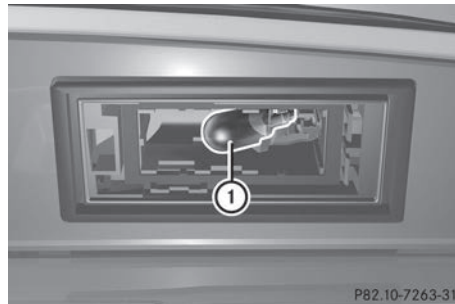

- ▶ Remove bulb ① from the bulb holder.
- ▶ Insert the new bulb.
- ▶ Re-insert the lamp lens into the license plate lamp.

Replacing the interior lighting

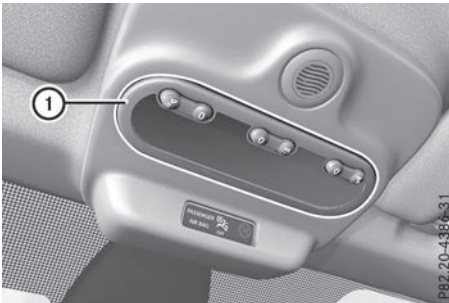

- ▶ Remove lamp lens ① with a flat tool, e.g. a screwdriver.
- ▶ Take the bulb to be replaced out of the bulb holder.
- ▶ Insert the new bulb into the bulb holder.
- ▶ Insert lamp lens ①.

Windshield wipers

Switching the windshield wipers on/off

❗ Do not operate the windshield wipers when the windshield is dry, as this could damage the wiper blades. Moreover, dust that has collected on the windshield can scratch the glass if wiping takes place when the windshield is dry.

If it is necessary to switch on the windshield wipers in dry weather conditions, always use washer fluid when operating the windshield wipers.

❗ Make sure that the front windshield wipers are free of ice. The wiper motor could otherwise overheat.

❗ If the windshield wipers leave smears on the windshield after the vehicle has been washed in an automatic car wash, wax or other residues may be the reason for this. Clean the windshield using washer fluid after washing the vehicle in an automatic car wash.



❗ Vehicles with a rain sensor: if the windshield becomes dirty in dry weather conditions, the windshield wipers may be activated inadvertently. This could then

damage the windshield wiper blades or scratch the windshield.

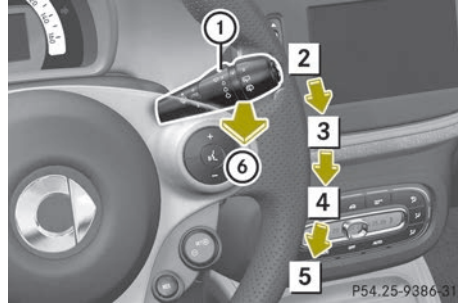
For this reason, you should always switch off the windshield wipers in dry weather.



Combination switch

- ① Control for wiping frequency and sensitivity of the rain sensor
- ② 0 Windshield wipers off
- ③  Intermittent wipe
- AUTO** Automatic wipe (rain sensor)
- ④ 1 Continuous wipe, slow
- ⑤ 2 Continuous wipe, fast
- ⑥  Wipes with washer fluid

▶ **To switch on:** turn the key to position 1 or 2 in the ignition lock (▶ page 86).

▶ Press the combination switch to the  position or 1.

or

▶ Start the engine (▶ page 86).

▶ Press the combination switch down or up to the corresponding position.

▶ To wipe with washer fluid : pull the combination switch towards the steering wheel.

▶ **To switch off:** press the combination switch to position 0.

Position 2 changes to position 1 when the engine is stopped.

In position 1 or in the  position, the windshield wipers stop automatically when the engine is stopped and the driver's door is opened.

Vehicles with a rain sensor: in position **AUTO** the windshield wipers stop automatically when the engine is stopped.

The windshield will no longer be wiped properly if the wiper blades are worn. This could

prevent you from observing the traffic conditions.

Intermittent wipe

Vehicles with a rain sensor: the appropriate wiping frequency is automatically set according to the intensity of the rain. With intermittent wiping you can also adjust the sensitivity of the rain sensor using control ①. When the sensitivity is set to high, the windshield wiper wipes more frequently.

- ▶ **To switch on:** start the engine (▷ page 86).
- ▶ Press the combination switch to the **AUTO** position.
The windshield wipers sweep once.

Switching the rear window wiper on/off

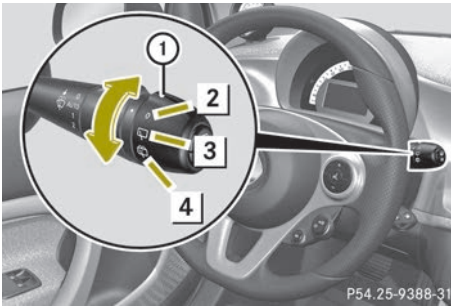

Combination switch

- ① Control
 - 2 0 Rear window wiper off
 - 3 [Wiper icon] Rear window wiper on
 - 4 [Wiper and washer icon] Wiping with washer fluid
- ▶ Turn the key to position **2** in the ignition lock or start the engine (▷ page 86).
 - ▶ Turn control ① on the combination switch to the corresponding position.

Replacing the wiper blades

Important safety notes

WARNING

If the windshield wipers begin to move while you are changing the wiper blades,

you could be trapped by the wiper arm. There is a risk of injury.

Always switch off the windshield wipers and ignition before changing the wiper blades.

! To avoid damaging the wiper blades, make sure that you touch only the wiper arm of the wiper.

! Never open the service cover/tailgate if a windshield wiper arm has been folded away from the windshield/rear window.

Never fold a windshield wiper arm without a wiper blade back onto the windshield/rear window.

Hold the windshield wiper arm firmly when you change the wiper blade. If you release the wiper arm without a wiper blade and it falls onto the windshield/rear window, the windshield/rear window may be damaged by the force of the impact.

smart recommends that you have the wiper blades changed at a qualified specialist workshop.

Changing the windshield wiper blades

Removing the wiper blades

- ▶ Turn the key to position **1** or **2** in the ignition lock (▷ page 86).
- ▶ Press the combination switch to the **5** position (▷ page 75).
The wiper arms move slowly upwards.
- ▶ When the wiper arms are vertical in relation to the service cover, turn the key to position **0** and remove it from the ignition lock.
- ▶ Fold the wiper arm away from the windshield.

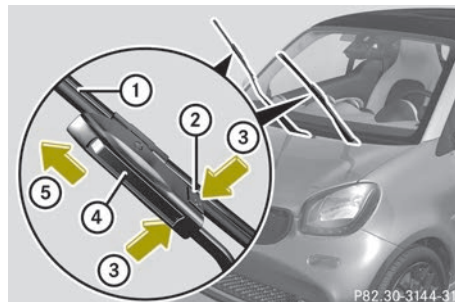

- ▶ Press the two release clips ② on mounting ④ in the direction of arrow ③ and pull away from the wiper arm.
- ▶ Slide wiper blade ① in the direction of arrow ⑤ until the wiper blade securing hook is revealed.
- ▶ Remove wiper blade ①.

Installing the wiper blades

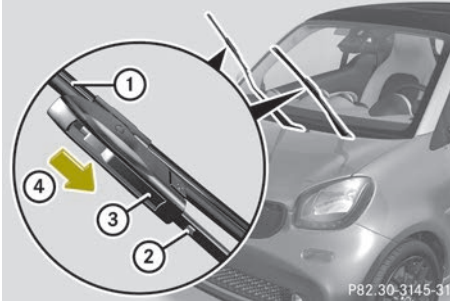

- ▶ Slide new wiper blade ① in the direction of arrow ④ onto mounting ③ of wiper arm ②. Wiper blade ① engages.
- ▶ Make sure that wiper blade ① is seated correctly.
- ▶ Fold wiper arm ② back onto the windshield.

Replacing the rear window wiper blade

Removing a wiper blade

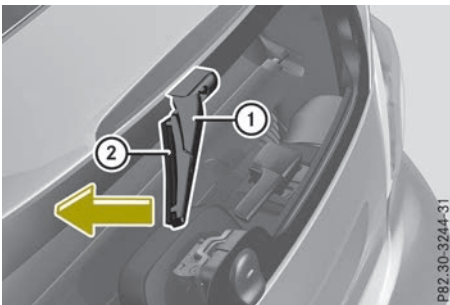

- ▶ Remove the SmartKey from the ignition lock.
- ▶ Fold wiper arm ① away from the rear window until it engages.
- ▶ Pull wiper blade ② in the direction of the arrow until it is released from the retainer on the wiper arm.
- ▶ Remove wiper blade ②.

Installing a wiper blade

- ▶ Push new wiper blade ② onto wiper arm ① until you feel it engage.
- ▶ Turn wiper blade ② parallel to wiper arm ①.
- ▶ Make sure that wiper blade ② is seated correctly.
- ▶ Fold wiper arm ① back onto the rear window.

Problems with the windshield wipers

Problem	Possible causes/consequences and ► Solutions
The windshield wipers do not stop or continue wiping with the same speed regardless of a change in position.	<p>The combination switch or rain sensor is malfunctioning.</p> <ul style="list-style-type: none"> ► Stop the vehicle, paying attention to traffic conditions as you do so and switch off the engine. ► For safety reasons, you should remove the key from the ignition lock and open the driver's door. ► Turn the key to position 1 in the ignition lock. Then try to start the engine again. ► Have the windshield wipers checked at a qualified specialist workshop.
The windshield wipers are jammed.	<p>Leaves or snow, for example, may be obstructing the windshield wiper movement. The wiper motor has been deactivated.</p> <ul style="list-style-type: none"> ► Stop the vehicle, paying attention to traffic conditions as you do so and switch off the engine. ► For safety reasons, you should remove the Smart Key from the ignition lock. ► Remove the cause of the obstruction. ► Switch the windshield wipers on again after 30 seconds.
The windshield wiper has stopped in the middle of the windshield.	<p>The windshield wiper drive has stopped for safety reasons.</p> <ul style="list-style-type: none"> ► Have the windshield wipers checked at a qualified specialist workshop.
The windshield wipers fail completely.	<p>The windshield wiper drive is malfunctioning.</p> <ul style="list-style-type: none"> ► Select another wiper speed on the combination switch. ► Have the windshield wipers checked at a qualified specialist workshop.

Overview of climate control systems

General notes

Observe the settings recommended on the following pages. The windows could otherwise fog up.

To prevent the windows from fogging up:

- switch off climate control only briefly
- switch on air-recirculation mode only briefly
- switch on the cooling with air dehumidification function
- switch on the defrost windshield function briefly, if required

Automatic climate control regulates the temperature and the humidity of the vehicle interior. It also filters undesirable substances out of the air.

Automatic climate control is only available when the engine is running. Optimum opera-

tion is only achieved with the side windows closed.

i When the weather is warm, ventilate the vehicle for a brief period. This will speed up the cooling process, and the desired vehicle interior temperature will be reached more quickly.

i The integrated filter filters out most particles of dust and pollen. It also reduces odors. A clogged filter reduces the amount of air supplied to the vehicle interior. For this reason, you should always observe the interval for replacing the filter, which is specified in the Maintenance Booklet. As it depends on environmental conditions, e.g. heavy air pollution, the interval may be shorter than stated in the Maintenance Booklet.

Automatic climate control panel



- ① Increases the airflow (▷ page 81)
- ② Defrosts the windshield (▷ page 81)
- ③ Switches the air-recirculation mode on/off (▷ page 82)
- ④ Switches the rear window heating on/off (▷ page 82)
- Switches the exterior mirror heating on/off (for vehicles with heated exterior mirrors only)
- ⑤ Sets the air distribution (▷ page 81)
- ⑥ Sets climate control to automatic (▷ page 80)
- ⑦ Switches the climate control on/off (▷ page 80)
- ⑧ Switches cooling with air dehumidification on/off (▷ page 80)
- ⑨ Reduces the airflow (▷ page 81)
- ⑩ Sets the temperature (▷ page 81)

>> Climate control.

P83.30-4980-31

Optimum use of automatic climate control

Automatic climate control

Below, you can find a number of notes and recommendations to help you use climate control optimally.

- Activate climate control primarily using the **AUTO** button.
- Set the temperature to 72 °F (22 °C).
- Only use the "Windshield demisting" function briefly until the windshield is clear again.
- Only use air-recirculation mode briefly, e.g. if there are unpleasant outside odors or when in a tunnel. The windows could otherwise fog up, since no fresh air is drawn into the vehicle in air-recirculation mode.



Operating the climate control systems

Switching climate control on/off

General notes

When the climate control is switched off, the air supply and air circulation are also switched off. The windows could mist up. Therefore, only switch off climate control briefly.

Switching the sound on/off

- ▶ Turn the SmartKey to position **1** or **2** in the ignition lock or start the engine (▷ page 86).
- ▶ **To switch on:** press the **AUTO** button. The indicator lamp under the **AUTO** button lights up.
or
- ▶ Press the  button.
or
- ▶ Press the  button.
- ▶ **To switch off:** press the **OFF** button. The indicator lamp under the **OFF** button lights up.
or
- ▶ Press the  button repeatedly until all the indicator lamps go out.

Switching cooling with air dehumidification on/off

General notes

If you deactivate the "Cooling with air dehumidification" function, the air inside the vehicle will not be cooled. The air inside the vehicle will also not be dehumidified. The windows can fog up more quickly. Therefore, deactivate the cooling with air dehumidification function only briefly.

The "Cooling with air dehumidification" function is only available when the engine is running. The air inside the vehicle is cooled and dehumidified according to the temperature selected.

The "Cooling with air dehumidification" function does not function when the outside temperature is low.

Condensation may drip from the underside of the vehicle when it is in cooling mode. This is normal and not a sign that there is a malfunction.

Switching on/off



- ▶ Start the engine (▷ page 86).
- ▶ **To activate:** press the  and **A/C** buttons. The indicator lamp in the **A/C** button lights up.
- ▶ **To deactivate:** press the **A/C** button. The indicator lamp in the **A/C** button goes out.

Setting climate control to automatic

General notes

In automatic mode, the set temperature is maintained automatically at a constant level. The system automatically regulates the airflow and the air distribution according to the temperature.

Automatic control

- ▶ Turn the ignition key to position **1** or **2** or start the engine (▷ page 86).
- ▶ **To activate:** press the **AUTO** button. The indicator lamp in the **AUTO** button lights up.
- ▶ **To switch to manual mode:** press the  or  button.

or



- ▶ Press the ,  or  button.

or

- ▶ Press the  button. The indicator lamp in the **AUTO** button goes out.

i If you manually change one of the functions, the indicator lamp in the **AUTO** button goes out. All further functions will still be automatically controlled.



Setting the temperature

- ▶ Start the engine (▷ page 86).
- ▶ **To increase or reduce:** push temperature slide  to the right or left (▷ page 79). Push slide  all the way to the right or left (▷ page 79).

Only change the temperature setting in small increments. Start at 72 °F (22 °C).

Setting the air distribution

Air distribution settings



-  Directs air through the defroster vents
-  Directs the airflow to the center and side air vents
-  Directs air through the footwell air vents

i You can also activate several air distribution settings simultaneously. To do this, press multiple air distribution buttons. The air is then directed through various vents.





Recommendation for air distribution in winter: set to  and .

Recommendation for air distribution in summer: set to .

Setting the air distribution

- ▶ Start the engine (▷ page 86).
- ▶ Press one or more of the ,  and  buttons. The indicator lamp next to the selected button lights up.

Setting the airflow

- ▶ Start the engine (▷ page 86).
- ▶ **To increase:** press the  button. Each time the  button is pressed, one of the indicator lamps next to the airflow buttons lights up.
- ▶ **To reduce:** press the  button. Each time the  button is pressed, one of the indicator lamps next to the airflow buttons goes out.





Defrosting the windshield

General notes







You can use this function to defrost the windshield or to clear a fogged up windshield or front side windows on the inside.

i You should only select the "Windshield defrosting" function until the windshield is clear again.

Switching on/off





- ▶ Turn the ignition key to position **1** or **2** or start the engine (▷ page 86).
- ▶ **To activate:** press the  button. The indicator lamp above the  button lights up. The **AUTO** automatic mode is deactivated. The  "Defrosting the windshield" function switches automatic climate control to the following functions:
 - cooling with air dehumidification on
 - high airflow
 - air distribution to the windshield and front side windows
 - air-recirculation mode off
- ▶ **To deactivate:** press the  button.

or



- ▶ Press the  button.
- or
- ▶ Press the  button.
- or
- ▶ Press the ,  or  button.
The indicator lamp above the  button goes out.

Demisting the windows

Windows fogged up on the inside

- ▶ Activate the  "Cooling with air dehumidification" function.
- ▶ Activate automatic mode .
- ▶ If the windows continue to fog up, activate the "Windshield defrosting" function .
-  You should only select this setting until the windshield is clear again.

Windows fogged up on the outside

- ▶ Activate the windshield wipers.
- ▶ Set the air distribution to .
-  You should only select this setting until the windshield is clear again.

Problems with the rear window defroster

Problem	Possible causes/consequences and ▶ Solutions
The rear window defroster has deactivated prematurely or cannot be activated.	The battery has not been sufficiently charged. ▶ Switch off any consumers that are not required, e.g. reading lamps, interior lighting or the seat heating. When the battery is sufficiently charged, the rear window defroster can be activated again.

Switching the air-recirculation mode on/off

General notes

You can deactivate the flow of fresh air temporarily if unpleasant odors are entering the vehicle from outside or if you are driving through a tunnel. The air already inside the vehicle will then be recirculated.

Rear window defroster

General notes





The rear window defroster has a high current draw. You should therefore switch it off as soon as the rear window is clear.

The rear window defroster can only be switched on or off while the engine is running.





The rear window defroster switches off automatically after approximately 10 minutes.

Vehicles with heated exterior mirrors: the exterior mirrors will also be heated when you switch on the rear window defroster. The mirror heating is switched off together with the rear window defroster.

Switching on/off

- ▶ Start the engine (▷ page 86).
- ▶ **To activate:** press the  button.
The indicator lamp above the  button lights up.
- ▶ **To deactivate:** press the  button.
The indicator lamp above the  button goes out.

Switching on/off

- ▶ Start the engine (▷ page 86).
 - ▶ **To activate:** press the  button.
The indicator lamp above the  button lights up.
 - ▶ **To deactivate:** press the  button.
- or
- ▶ Press the  button.
- or
- ▶ Press the **AUTO** button.
The indicator lamp above the  button goes out.

Setting the air vents

Important safety notes

WARNING

Very hot or very cold air can flow from the air vents. This could result in burns or frostbite in the immediate vicinity of the air vents. There is a risk of injury.

Make sure that all vehicle occupants always maintain a sufficient distance to the air outlets. If necessary, redirect the airflow to another area of the vehicle interior.

WARNING

If you spray cleaning products or disinfectant into the ventilation system of the vehicle, this could ignite. There is a risk of fire.

Never spray these or any other substances into the ventilation system. Always have work on the ventilation system carried out at a qualified specialist workshop.

In order to ensure the direct flow of fresh air through the air vents into the vehicle interior, please observe the following notes:

- keep the air inlet between the service cover and the windshield free of blockages, such as ice, snow or leaves.
 - never cover the air vents or air intake grilles in the vehicle interior.
- i** For optimum climate control in the vehicle, open the air vents fully.

Setting the center air vents

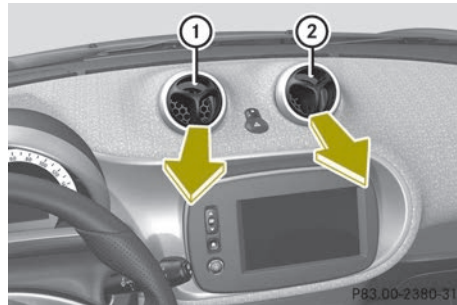

- ▶ **To set the direction of the air flow:** hold center air vent ① or ② in the middle and turn and/or tilt it in the desired air flow direction up, down, to the left or to the right.
- ▶ **To close the center air vent:** hold center air vent ① or ② in the middle and tilt inwards until the vent openings can no longer be seen.

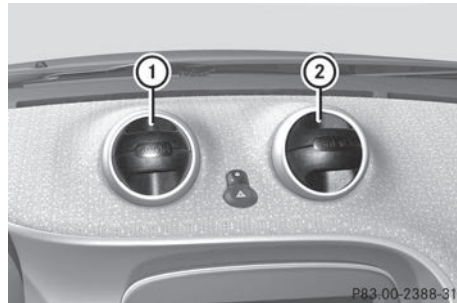

- ▶ **To open the center air vent:** hold center air vent ① or ② in the middle and tilt outwards until the vent openings can be seen.

Setting the side air vents

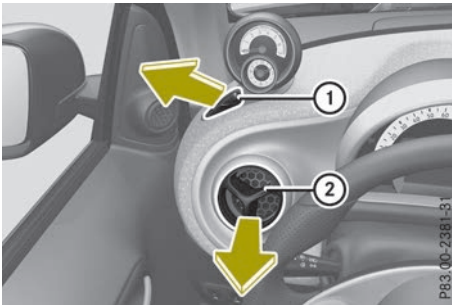

>> Climate control.

- ▶ **To set the direction of the air flow:** hold side air vent ② in the middle and turn and/or tilt it in the desired air flow direction up, down, to the left or to the right.
 - ▶ **To close the side air vent:** hold side air vent ② in the middle and tilt inwards until the vent openings can no longer be seen.
 - ▶ **To open the side air vent:** hold side air vent ② in the middle and tilt outwards until the vent openings can be seen.
- Demister vent ① cannot be adjusted.

Breaking-in notes

Important safety notes

In certain driving and driving safety systems, the sensors adjust automatically while a certain distance is being driven after the vehicle has been delivered or after repairs. Full system effectiveness is not reached until the end of this teach-in procedure.

New and replaced brake pads and discs only reach their optimum braking effect after several hundred kilometers of driving. Compensate for this by applying greater force to the brake pedal.

The first 1000 miles (1500 km)

The more you look after the engine when it is new, the more satisfied you will be with its performance in the future.

- You should therefore drive at varying vehicle and engine speeds for the first 1000 miles (1500 km).
- Avoid heavy loads, e.g. driving at full throttle, during this period.
- Change gear in good time, before the tachometer needle is $\frac{2}{3}$ of the way to the red area of the tachometer.
- Do not manually shift to a lower gear to brake the vehicle.
- Vehicles with automatic transmission: if possible, do not depress the accelerator pedal beyond the pressure point (kick-down).
- Vehicles with automatic transmission: ideally, for the first 1000 miles (1500 km), drive in program **E** (Comfort).

After 1000 miles (1500 km), you can increase the engine speed gradually and bring the vehicle to full speed.

You should also observe these notes on running-in if the engine or parts of the drive train on your vehicle have been replaced.

Observe the maximum permissible speed.

Driving

Important safety notes

WARNING

Objects in the driver's footwell can restrict the pedal travel or obstruct a depressed pedal. The operating and road safety of the vehicle is jeopardized. There is a risk of an accident.

Make sure that all objects in the vehicle are stowed correctly, and that they cannot enter the driver's footwell. Install the floormats securely and as specified in order to ensure sufficient clearance for the pedals. Do not use loose floormats and do not place floormats on top of one another.

WARNING

Unsuitable footwear can hinder correct usage of the pedals, e.g.:

- shoes with thick soles
- shoes with high heels
- slippers

There is a risk of an accident.

Wear suitable footwear to ensure correct usage of the pedals.

WARNING

If you switch off the ignition while driving, safety-relevant functions are only available with limitations, or not at all. This could affect, for example, the power steering and the brake boosting effect. You will require considerably more effort to steer and brake. There is a risk of an accident.

Do not switch off the ignition while driving.

WARNING

If the parking brake has not been fully released when driving, the parking brake can:

- overheat and cause a fire
- lose its hold function.

There is a risk of fire and an accident. Release the parking brake fully before driving off.

! Do not warm up the engine with the vehicle stationary. Drive off immediately. Avoid high engine speeds and driving at full throttle until the engine has reached its operating temperature.

Only shift the automatic transmission to the desired drive position when the vehicle is stationary.

Where possible, avoid spinning the drive wheels when pulling away on slippery roads. You could otherwise damage the drive train.

SmartKey positions

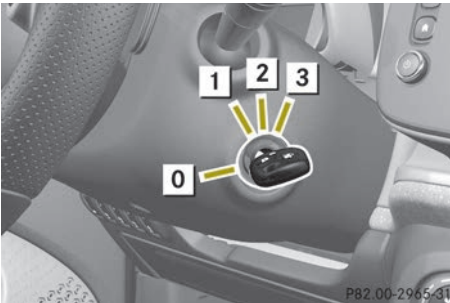

- 0** To remove the SmartKey
- 1** Power supply for some consumers, such as the windshield wipers
- 2** Ignition (power supply for all consumers) and drive position
- 3** Starting the engine

The steering is locked when you remove the SmartKey from the ignition lock.

Starting the engine

Important safety notes

WARNING

If children are left unsupervised in the vehicle, they could:

- open the doors, thus endangering other people or road users.
- get out and disrupt traffic.
- operate the vehicle's equipment.

Additionally, children could set the vehicle in motion if, for example, they:

- release the parking brake.
- shift the automatic transmission out of park position P or shift manual transmission into neutral.
- start the engine.

There is a risk of an accident and injury.

When leaving the vehicle, always take the SmartKey with you and lock the vehicle.

Never leave children or animals unattended in the vehicle. Always keep the SmartKey out of reach of children.

WARNING

Combustion engines emit poisonous exhaust gases such as carbon monoxide. Inhaling these exhaust gases leads to poisoning. There is a risk of fatal injury. Therefore never leave the engine running in enclosed spaces without sufficient ventilation.

WARNING

Flammable materials introduced through environmental influence or by animals can ignite if in contact with the exhaust system or parts of the engine that heat up. There is a risk of fire.

Carry out regular checks to make sure that there are no flammable foreign materials in the engine compartment or in the exhaust system.

- i** During a cold start, the engine runs at higher speeds to enable the catalytic converter to reach its operating temperature. The sound of the engine may change during this time.

Manual transmission

- ▶ Depress the brake pedal and keep it depressed.
- ▶ Depress the clutch pedal fully.
- ▶ Shift to neutral.

Automatic transmission

- ▶ Shift the transmission to position **P** (▷ page 90).
The transmission position display in the multifunction display shows **P** (▷ page 90).

- i** You can start the engine in transmission positions **P** and **N**.
In order to start the engine in transmission position **N** you must depress the brake pedal and keep it depressed.

Starting procedure

- ▶ Turn the key to position **3** in the ignition lock (▷ page 86) and release it as soon as the engine is running.

Pulling away

General notes

WARNING

Vehicles with automatic transmission:
If the engine speed is above the idling speed and you engage transmission position **D** or **R**, the vehicle could pull away suddenly. There is a risk of an accident.
When engaging transmission position **D** or **R**, always firmly depress the brake pedal and do not simultaneously accelerate.

- !** **Vehicles with manual transmission:** change gear in good time and avoid spinning the wheels. You could otherwise damage the vehicle.

- !** Release the parking brake before driving off. The parking brake can otherwise overheat, malfunction and wear out quickly.

Accelerate gently when pulling away.

The vehicle locks centrally once you have pulled away.

You can open the doors from the inside at any time.

You can also deactivate the automatic locking feature (▷ page 57).

Vehicles with automatic transmission: you can only shift the transmission from position **P** to the desired transmission position if:

- the ignition is switched on
- you depress the brake pedal and keep it depressed and
- you press release button on the selector lever (▷ page 90).

Only then is the shift lock released.

- i** **Vehicles with automatic transmission:** transmission shifts take place at higher engine speeds after a cold start. This helps the catalytic converter to reach its operating temperature more quickly.

Hill start assist

Hill start assist helps you when pulling away forwards or in reverse on an uphill gradient. It holds the vehicle for a short time after you have removed your foot from the brake pedal. This gives you enough time to move your foot from the brake pedal to the accelerator pedal and to depress it before the vehicle begins to roll.

WARNING

After a short time, hill start assist will no longer brake your vehicle and it could roll away. There is a risk of an accident and injury.

Therefore, quickly move your foot from the brake pedal to the accelerator pedal. Never leave the vehicle when it is held by hill start assist.

Hill start assist is not active if:

- you pull away on level ground
- you pull away in a forward gear on a downhill slope

- on vehicles with automatic transmission, the transmission is in position **N**.
- the parking brake is applied.
- ESP® is malfunctioning

Problems with the engine

Problem	Possible causes/consequences and ► Solutions
The engine does not start. The starter motor can be heard.	<ul style="list-style-type: none"> • There is a malfunction in the engine electronics. • There is a malfunction in the fuel supply. ► Switch off the engine before attempting to start the engine again (▷ page 98). ► Try to start the engine again (▷ page 86). Avoid excessively long and frequent attempts to start the engine as these will drain the battery. If the engine does not start after several attempts: ► Consult a qualified specialist workshop.
The engine does not start. You cannot hear the starter motor.	The on-board voltage is too low because the battery is too weak or discharged. ► Jump-start the vehicle (▷ page 162). If the engine does not start despite attempts to jump-start it: ► Consult a qualified specialist workshop.
	The starter motor was exposed to a thermal load that was too high. ► Allow the starter motor to cool down for approximately two minutes. ► Try to start the engine again. If the engine still does not start: ► Consult a qualified specialist workshop.
The engine is not running smoothly and is misfiring.	There is a malfunction in the engine electronics or in a mechanical component of the engine management system. ► Only depress the accelerator pedal slightly. Otherwise, non-combusted fuel may get into the catalytic converter and damage it. ► Have the cause rectified immediately at a qualified specialist workshop.
The coolant temperature exceeds 230 °F (110 °C). The red coolant temperature warning lamp comes on while the engine is running. A warning tone also sounds. The Stop Switch Off Engine message appears.	The coolant level is too low. The coolant is too hot and the engine is no longer being cooled sufficiently. ► Stop as soon as possible and allow the engine and the coolant to cool down. ► Check the coolant level (▷ page 149). Observe the warning notes as you do so and add coolant if necessary.

Manual transmission

Gear lever

! Only engage gear when the clutch pedal is depressed.

! When shifting into **5th** gear, you should always push the gear lever all the way to the right. You could otherwise shift unintentionally into **3rd** gear and damage the transmission.

If you shift down at too high a speed (transmission braking), this can cause the engine to overrev, leading to engine damage.

Never hold the vehicle stopped on a hill by using the clutch pedal. There is otherwise a risk of damaging the clutch.

! On long and steep downhill gradients, especially if the vehicle is laden, you must shift into gear **1**, **2** or **3** in good time. By doing so, you will make use of the braking effect of the engine. This relieves the load on the brake system and prevents the brakes from overheating and wearing too quickly.

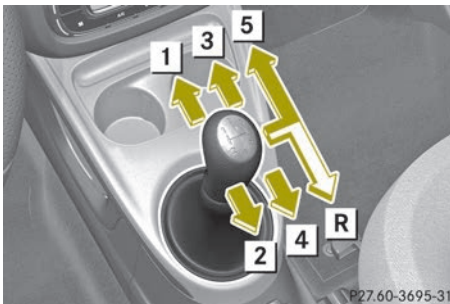

- 1** - **5** Forward gears
R Reverse gear

Shifting to neutral

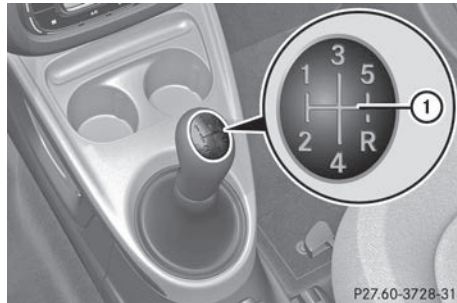

- ▶ Depress the clutch pedal fully.
- ▶ Move the gearshift lever to position ①.

Engaging reverse gear

! Only shift into reverse gear **R** when the vehicle is stationary. Otherwise, you could damage the transmission.

All vehicles except for smart 66 kw Turbo

- ▶ Shift to neutral (▷ page 89).
- ▶ Press the gear lever to the right and then pull it back.



smart 66 kw Turbo

- ▶ Shift to neutral (▷ page 89).
- ▶ Pull collar ① upwards.
- ▶ Press the gear lever to the right and then pull it back.

Shift recommendation

The gearshift recommendations assist you in adopting an economical driving style.

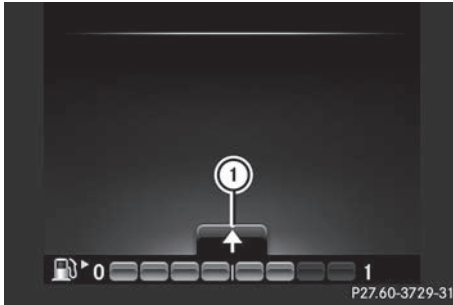

- ▶ Shift one gear up or down according to gearshift recommendation ① when shown in the multifunction display of the instrument cluster.

Further information on the transmission display (▷ page 108).

Automatic transmission

Important safety notes

WARNING

If the engine speed is above the idling speed and you engage transmission position **D** or **R**, the vehicle could pull away suddenly. There is a risk of an accident.

When engaging transmission position **D** or **R**, always firmly depress the brake pedal and do not simultaneously accelerate.

WARNING

The automatic transmission switches to neutral position **N** when you switch off the engine. The vehicle may roll away. There is a risk of an accident.

Before switching off the engine, always switch to parking position **P**. Prevent the parked vehicle from rolling away by applying the parking brake.

Selector lever

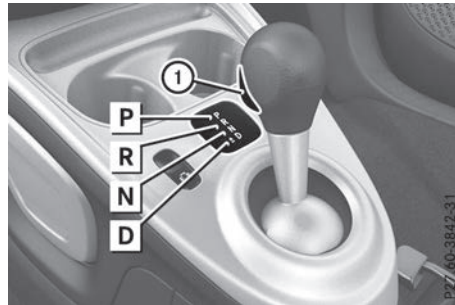

- P** Park position with parking lock
- R** Reverse gear
- N** Neutral
- D** Drive

- ▶ **To shift transmission position:** press release button ① and shift the gear lever to the desired transmission position.

The ignition must also be switched on, when you:

- shift the transmission from positions **N** or **P** to position **R**
- shift to position **P**

- i** When you shift the transmission from positions **D** or **R** to position **N**, you do not need to press release button ①.

Transmission position and drive program display

The current transmission position and drive program appear in the multifunction display.

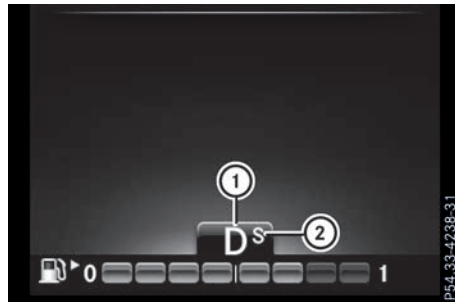

- ① Transmission position display
- ② Drive program display

Transmission positions

P	<p>Park position</p> <p>This prevents the vehicle from rolling away when stopped.</p> <p>Only shift the transmission into position P (▷ page 90) when the vehicle is stationary. The parking lock should not be used as a brake when parking. Always apply the parking brake in addition to the parking lock in order to secure the vehicle.</p> <p>The key can only be removed if the transmission is in position P. If the SmartKey is removed from the ignition lock, the selector lever is locked.</p> <p>In the event of a malfunction of the vehicle's electronics, the transmission may lock. Information on manually disconnecting the selector lever lock (▷ page 95).</p> <p>Have the vehicle electronics checked immediately at a qualified specialist workshop.</p>
R	<p>Reverse gear</p> <p>Only shift the transmission into position R when the vehicle is stationary.</p>

N	<p>Neutral</p> <p>Do not shift the transmission to N while driving. Otherwise, the automatic transmission could be damaged.</p> <p>No power is transmitted from the engine to the drive wheels.</p> <p>Releasing the parking brake and brake pedal will allow you to move the vehicle freely, e.g. to push it or tow it away.</p> <p>If esp® is deactivated or faulty: shift the transmission to position N if the vehicle is in danger of skidding, e.g. on icy roads.</p> <p>! Rolling in neutral N can damage the drive train.</p>
D	<p>Drive</p> <p>The automatic transmission changes gear automatically. All forward gears are available.</p>

Driving tips

Changing gear

The automatic transmission shifts to the individual gears automatically when it is in transmission position **D**. This automatic gearshifting behavior is determined by:

- the selected drive program;
- the position of the accelerator pedal
- the road speed

Accelerator pedal position

Your style of driving influences how the automatic transmission shifts gear:

- little throttle: early upshifts
- more throttle: late upshifts

Kickdown

If you want maximum acceleration, use kick-down:

- ▶ Depress the accelerator pedal beyond the pressure point.
The automatic transmission shifts to a lower gear depending on the engine speed.
- ▶ Ease off the accelerator pedal once the desired speed is reached.
The automatic transmission shifts back up.

Rocking the vehicle free

Shifting the transmission repeatedly between gears **D** and **R** may help to free the vehicle if it has become stuck in slush or snow.

- ▶ Shift the selector lever alternately between positions **D** and **R**.

The vehicle's engine management system limits the speed to a maximum of 5 mph (9 km/h) when shifting back and forth.

Program selector button

The program selector button allows you to choose between drive programs with different driving characteristics.

The automatic transmission switches to drive program **E** (Comfort) every time the engine is started.



- ▶ Press program selector button ① to change the drive program.
The letter of the selected drive program appears in the multifunction display.

E (Comfort)	Comfortable, economical driving
S (Dynamic)	Dynamic, agile driving

More information on drive programs (> page 92).

Drive programs

Drive program **E** (Comfort)

Drive program **E** (Comfort) is characterized by the following:

- comfort-oriented engine settings
- optimal fuel consumption resulting from the automatic transmission shifting up sooner
- the automatic transmission shifting up sooner. This results in the vehicle being driven at lower engine speeds and the wheels being less likely to spin

Drive program **S** (Dynamic)

Drive program **S** (Dynamic) is characterized by the following:

- the automatic transmission shifting up later
- the fuel consumption possibly being higher as a result of the later automatic transmission shift points

Manual gearshifting

General notes

You can shift the gears manually using either the selector lever or the shift paddles. The transmission must be in position **D**.

If it is permissible, the automatic transmission shifts to the next highest or next lowest gear.

To use manual gearshifting, you have two possibilities:

- long-term setting
- short-term setting (vehicles with Sports package)

If you activate the manual gearshift setting, the currently selected gear is shown in the multifunction display instead of **D**.

Long-term setting



- ▶ **To activate:** shift the selector lever to **D**.
- ▶ Push the selector lever to the left.



- ▶ **To deactivate:** push the selector lever to the right.

Short-term setting (vehicles with Sports package)



- ▶ **To activate:** shift the selector lever to **D**.
- ▶ Pull shift paddle ① or ②.

The short-term setting remains active for a certain length of time. Under certain conditions this minimum time is increased, e.g. in the case of lateral acceleration, during an overrun phase or while driving on steep terrain.

- ▶ **To deactivate:** pull and hold shift paddle ②.
- or
- ▶ Change the transmission position with the selector lever.
- or
- ▶ Change the drive program with the program selector button.

Shifting with the selector lever



- ▶ **To shift up:** push the selector lever in the **+** direction.
The automatic transmission shifts up to the next gear.

To prevent engine damage the automatic transmission shifts up automatically:

- if the maximum engine speed on the currently engaged gear is reached and
- you continue to accelerate

- ▶ **To shift down:** pull the selector lever in the **-** direction.

The automatic transmission shifts down to the next gear.

Downshifting occurs automatically while coasting.

If the engine exceeds the maximum engine speed when shifting down, the automatic transmission protects against engine damage by not shifting down.

Shifting with shift paddles (vehicles with Sports package)



- ▶ **To shift up:** pull shift paddle ②.
The automatic transmission shifts up to the next gear.
To prevent engine damage the automatic transmission shifts up automatically:
 - if the maximum engine speed on the currently engaged gear is reached and
 - you continue to accelerate.
- ▶ **To shift down:** pull shift paddle ①.
The automatic transmission shifts down to the next gear.
Downshifting occurs automatically while coasting.
If the engine exceeds the maximum engine speed when shifting down, the automatic transmission protects against engine damage by not shifting down.

Shift recommendation

The gearshift recommendations assist you in adopting an economical driving style.



- ▶ Shift one gear up or down according to gearshift recommendation ① when shown in the multifunction display of the instrument cluster.

Further information on the transmission display (▷ page 108).

Kickdown

If you want maximum acceleration, you can also change the kickdown to be manually switched on:

- ▶ Depress the accelerator pedal beyond the pressure point.
The automatic transmission shifts to a lower gear depending on the engine speed.
- ▶ Shift back up once the desired speed is reached.
- ⓘ If you apply full throttle, the automatic transmission shifts up to the next gear when the maximum engine speed is reached. This prevents the engine from overrevving.

Problems with the transmission

Problem	Possible causes/consequences and ► Solutions
The transmission has problems shifting gear.	The transmission is losing oil. ► Have the transmission checked at a qualified specialist workshop immediately.
The acceleration ability is deteriorating. The transmission no longer shifts into all of the gears. Reverse gear can no longer be engaged.	The transmission is in emergency mode. ► Stop the vehicle. ► Shift the transmission to position P . ► Switch off the engine. ► Wait at least ten seconds before restarting the engine. ► Shift the transmission to position D . ► Have the transmission checked at a qualified specialist workshop immediately.

Manually releasing the selector lever lock

You can manually release the selector level lock in the event of an electrical malfunction. This is the case, for example, when you want to release the parking brake while towing away the vehicle and then apply it again.

! Do not use any sharp-edged objects to prise out the cover from the center console. Otherwise, the cover or the center console could be damaged.



- Apply the parking brake.
- Prise out cover ① at lower edge ② with a flat, blunt object (e.g. a screwdriver wrapped in cloth).
- Pull cover ① in the direction of the arrow.

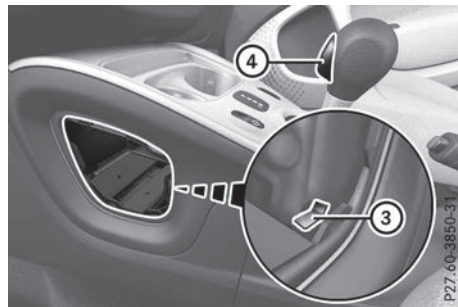

- Pull yellow release ③ behind the trim up and simultaneously press release button ④ on the selector lever.
- Shift the selector lever to **N** or **P**.

Refueling

Important safety notes

⚠ WARNING

Fuel is highly flammable. If you handle fuel incorrectly, there is a risk of fire and explosion.

You must avoid fire, open flames, creating sparks and smoking. Switch off the engine and, if applicable, the auxiliary heating before refueling.

⚠ WARNING

Fuel is poisonous and hazardous to health. There is a risk of injury.

You must make sure that fuel does not come into contact with your skin, eyes or clothing and that it is not swallowed. Do not inhale fuel vapors. Keep fuel away from children.

If you or others come into contact with fuel, observe the following:

- Wash away fuel from skin immediately using soap and water.
- If fuel comes into contact with your eyes, immediately rinse them thoroughly with clean water. Seek medical assistance without delay.
- If fuel is swallowed, seek medical assistance without delay. Do not induce vomiting.
- Immediately change out of clothing which has come into contact with fuel.

⚠ WARNING

Electrostatic buildup can create sparks and ignite fuel vapors. There is a risk of fire and explosion.

Always touch the vehicle body before opening the fuel filler flap or touching the fuel pump nozzle. Any existing electrostatic buildup is thereby discharged.

Do not get into the vehicle again during the refueling process. Otherwise, electrostatic charge could build up again.

! Do not use diesel to refuel vehicles with a gasoline engine. Do not switch on the ignition if you accidentally refuel with the wrong fuel. Otherwise, the fuel will enter the fuel system. Even small amounts of the wrong fuel could result in damage to the fuel system and the engine. Notify a qualified specialist workshop and have the fuel tank and fuel lines drained completely.

! Overfilling the fuel tank could damage the fuel system.

! Take care not to spill any fuel on painted surfaces. You could otherwise damage the paintwork.

! Use a filter when refueling from a fuel can. Otherwise, the fuel lines and/or injection system could be blocked by particles from the fuel can.

If you overfill the fuel tank, fuel could spray out when the fuel pump nozzle is removed.

For further information on fuel and fuel quality (▷ page 200).

Refueling

General information

The fuel filler flap is unlocked or locked automatically when you lock or unlock the vehicle with the key.

The position of the fuel filler cap is displayed  in the instrument cluster. The arrow next to the filling pump indicates the side of the vehicle.

Opening the fuel filler flap

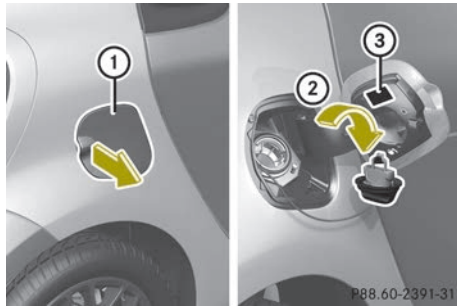

① Opening the fuel filler flap



② Attaches the fuel filler cap

③ Fuel type instruction label

- ▶ Switch the engine off.
- ▶ Remove the SmartKey from the ignition lock.
- ▶ Open the fuel filler flap in the direction of arrow ①.
- ▶ Turn the fuel filler cap counterclockwise and remove it.
- ▶ Hang the fuel filler cap on the hook on the inside of the fuel filler flap.

- ▶ Completely insert the filler neck of the fuel pump nozzle into the tank, hook in place and refuel.
- ▶ Only fill the tank until the pump nozzle switches off.
- i** Do not add any more fuel after the pump stops filling for the first time. Otherwise, fuel may leak out.

i Close the fuel filler flap before locking the vehicle.

i If you are driving with the fuel filler cap open, the  reserve fuel warning lamp flashes. A message appears in the multi-function display (▷ page 121). In addition, the  Check Engine warning lamp may light up (▷ page 132). For further information on warning and indicator lamps in the instrument cluster, see (▷ page 132).

Closing the fuel filler flap

- ▶ Replace the cap on the filler neck and turn clockwise until it engages audibly.
- ▶ Close the fuel filler flap.

Problems with fuel and fuel tank	
Problem	Possible causes/consequences and ▶ Solutions
Fuel is leaking from the vehicle.	The fuel line or the fuel tank is faulty. ⚠ WARNING Risk of explosion or fire. ▶ Turn the key to position 0 in the ignition lock and remove it immediately (▷ page 86). ▶ Do not restart the engine under any circumstances. ▶ Consult a qualified specialist workshop.
The fuel filler flap cannot be opened.	The fuel filler flap is not unlocked. ▶ Unlock the vehicle (▷ page 53).
	The SmartKey battery is discharged or nearly discharged. ▶ Unlock the vehicle using the key element in the emergency lock (▷ page 57).
	The fuel filler flap is unlocked, but the opening mechanism is jammed. ▶ Consult a qualified specialist workshop.

Parking

Important safety notes

⚠ WARNING
 Flammable material such as leaves, grass or twigs may ignite if they come into contact with hot parts of the exhaust system or exhaust gas flow. There is a risk of fire.

Park the vehicle so that no flammable materials come into contact with parts of the vehicle which are hot. Take particular care not to park on dry grassland or harvested grain fields.

 **WARNING**

If you leave children unsupervised in the vehicle, they could set it in motion by, for example:

- release the parking brake.
- shift the automatic transmission out of park position **P** or shift manual transmission into neutral.
- start the engine.

In addition, they may operate vehicle equipment and become trapped. There is a risk of an accident and injury.

When leaving the vehicle, always take the SmartKey with you and lock the vehicle.

Never leave children unsupervised in the vehicle.

- ❗ Always secure the vehicle correctly against rolling away. Otherwise, the vehicle or its drivetrain could be damaged.

To ensure that the vehicle is secured against rolling away unintentionally:

- the parking brake must be applied.
- a gear must be engaged on vehicles with manual transmission.
- the selector lever must be in position **P** on vehicles with automatic transmission.
- the SmartKey must be removed from the ignition lock.
- on uphill or downhill gradients, the front wheels must be turned towards the curb.

Switching off the engine

Vehicles with manual transmission

- ▶ Select a gear.
- ▶ Turn the key to position **0** in the ignition lock and remove it. The immobilizer is activated.
- ▶ Apply the parking brake.

Vehicles with automatic transmission

 **WARNING**

The automatic transmission switches to neutral position **N** when you switch off the engine. The vehicle may roll away. There is a risk of an accident.

Before switching off the engine, always switch to parking position **P**. Prevent the parked vehicle from rolling away by applying the parking brake.

- ▶ Apply the parking brake.
- ▶ Shift the transmission to position **P**.
- ▶ Turn the key to position **0** in the ignition lock and remove it. The immobilizer is activated. The key can only be removed if the transmission is in position **P**.

Parking brake

General notes

 **WARNING**

If you must brake the vehicle with the parking brake, the braking distance is considerably longer and the wheels could lock. There is an increased danger of skidding and accidents.

Only use the parking brake to brake the vehicle when the service brake is faulty. Do not apply the parking brake too firmly. If the wheels lock, release the parking brake until the wheels begin turning again.

 **WARNING**

If you leave children unsupervised in the vehicle, they could set it in motion by, for example:

- release the parking brake.
- shift the automatic transmission out of park position **P** or shift manual transmission into neutral.
- start the engine.

In addition, they may operate vehicle equipment and become trapped. There is a risk of an accident and injury.

When leaving the vehicle, always take the SmartKey with you and lock the vehicle. Never leave children unsupervised in the vehicle.

If you brake the vehicle with the parking brake, the brake lamps will not light up.

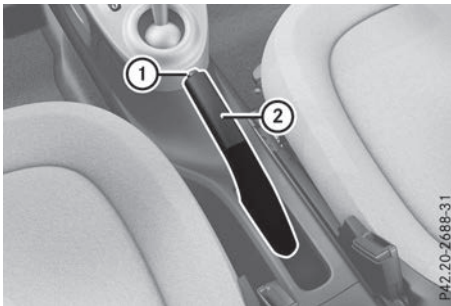

- ▶ **To apply:** firmly pull parking brake ② upwards.
When the engine is running, the **BRAKE** (USA only) or **(P)** (Canada only) indicator lamp lights up in the instrument cluster.
- ▶ **To release:** depress the brake pedal and keep it depressed.
- ▶ Press release button ① on parking brake ② and guide the parking brake down to the stop.
The **BRAKE** (USA only) or **(P)** (Canada only) indicator lamp in the instrument cluster goes out.

The parking brake is not yet engaged if:

- a warning tone sounds
- The **Release Parking Brake** message appears in the multifunction display and
- the **(P)** indicator lamp in the instrument cluster lights up

Parking the vehicle for a long period

If you leave the vehicle parked for longer than four weeks, the battery may be damaged by exhaustive discharging.

If you leave the vehicle parked for longer than six weeks, the vehicle may suffer damage as a result of lack of use.

- ▶ Visit a qualified specialist workshop and seek advice.
- ❗ You can obtain information about trickle chargers from a qualified specialist workshop.

Driving tips

General notes

Important safety notes

⚠ WARNING

If you switch off the ignition while driving, safety-relevant functions are only available with limitations, or not at all. This could affect, for example, the power steering and the brake boosting effect. You will require considerably more effort to steer and brake. There is a risk of an accident.

Do not switch off the ignition while driving.

⚠ WARNING

If you operate mobile communication equipment while driving, you will be distracted from traffic conditions. You could also lose control of the vehicle. There is a risk of an accident.

Only operate this equipment when the vehicle is stationary.

Observe the legal requirements for the country in which you are driving. Some jurisdictions prohibit the driver from using a mobile phone while driving a vehicle.

If you make a call while driving, always use hands-free mode. Only use the telephone when the traffic situation permits. If you are unsure, pull over to a safe location and stop before using the telephone.

Bear in mind that at a speed of only 30 mph (approximately 50 km/h), the vehicle covers a distance of 44 ft (approximately 14 m) per second.

Drive sensibly – save fuel

Observe the following tips to save fuel:

- The tires should always be inflated to the recommended tire pressure.
- Remove unnecessary loads.
- Warm up the engine at low engine speeds.
- Avoid frequent acceleration or braking.
- Have all maintenance work carried out as indicated by the service intervals in the Maintenance Booklet or by the service interval display.

Fuel consumption also increases when driving in cold weather, in stop-start traffic and in hilly terrain.

Drinking and driving

WARNING

Drinking and driving and/or taking drugs and driving are very dangerous combinations. Even a small amount of alcohol or drugs can affect your reflexes, perceptions and judgment.

The possibility of a serious or even fatal accident is greatly increased when you drink or take drugs and drive.

Do not drink or take drugs and drive or allow anyone to drive who has been drinking or taking drugs.

Emission control

WARNING

Combustion engines emit poisonous exhaust gases such as carbon monoxide. Inhaling these exhaust gases leads to poisoning. There is a risk of fatal injury. Therefore never leave the engine running in enclosed spaces without sufficient ventilation.

Certain engine systems are designed to keep the level of poisonous components in exhaust fumes within legal limits.

These systems only work at peak efficiency if they are serviced exactly in accordance with the manufacturer's specifications. There-

fore, only allow qualified and authorized technicians to perform work on the engine. The engine settings must not be changed under any circumstances. Furthermore, all specific service work must be performed at regular intervals and in accordance with smart service requirements. Details can be found in the Maintenance Booklet.

Braking

Important safety notes

WARNING

If you shift down on a slippery road surface in an attempt to increase the engine's braking effect, the drive wheels could lose their grip. There is an increased danger of skidding and accidents.

Do not shift down for additional engine braking on a slippery road surface.

Downhill gradients

- ❗ On long and steep gradients, you must reduce the load on the brakes by shifting to a lower gear in good time. This allows you to take advantage of the engine's braking effect. This helps you to avoid overheating the brakes and wearing them out excessively.

When you use engine braking, a drive wheel may not turn for some time, e.g. on a slippery road surface. This could cause damage to the drive train, which is not covered by the smart warranty.

Heavy and light loads

WARNING

If you rest your foot on the brake pedal while driving, the braking system can overheat. This increases the stopping distance and can even cause the braking system to fail. There is a risk of an accident. Never use the brake pedal as a footrest. Never depress the brake pedal and the accelerator pedal at the same time.

! Depressing the brake pedal constantly results in excessive and premature wear to the brake pads.

If the brakes have been subjected to a heavy load, do not stop the vehicle immediately. Drive on for a short while. This allows the airflow to cool the brakes more quickly.

Wet roads

If you have driven for a long time in heavy rain without braking, there may be a delayed reaction from the brakes when braking for the first time. This may also occur after the vehicle has been washed or driven through deep water.

You then have to depress the brake pedal more firmly. Maintain a greater distance from the vehicle in front.

After driving on a wet road or having the vehicle washed, brake firmly while paying attention to the traffic conditions. This will warm up the brake discs, thereby drying them more quickly and protecting them against corrosion.

Limited braking performance on salt-treated roads

If you drive on salted roads, a layer of salt residue may form on the brake discs and brake pads. This can result in a significantly longer braking distance.

- Brake occasionally to remove any possible salt residue. Make sure that you do not endanger other road users when doing so.
- Carefully depress the brake pedal and the beginning and end of a journey.
- Maintain a greater distance to the vehicle ahead.

Servicing the brakes

! The brake fluid level may be too low, if:

- if the red brake warning lamp lights up in the instrument cluster and
- you hear a warning tone while the engine is running

Observe additional warning messages in the multifunction display.

The brake fluid level may be too low due to brake pad wear or leaking brake lines.

Have the brake system checked immediately. Consult a qualified specialist workshop to arrange this.

! A function or performance test should only be carried out on a 2-axle dynamometer. If you wish to operate the vehicle on such a dynamometer, please consult a qualified specialist workshop in advance. You could otherwise damage the drive train or the brake system.

! As the ESP® system operates automatically, the engine and the ignition must be switched off (the SmartKey must be in position **0** or **1** in the ignition lock) if:

- the parking brake is tested using a brake dynamometer (maximum 10 seconds).
- the vehicle is towed with the front axle raised.

Braking triggered automatically by ESP® may seriously damage the brake system.

All checks and maintenance work on the brake system must be carried out at a qualified specialist workshop.

Have brake pads installed and brake fluid replaced at a qualified specialist workshop.

If the brake system has only been subject to moderate loads, you should test the functionality of your brakes at regular intervals.

When having brake pads/linings fitted, smart recommends that you only use those which are approved for smart vehicles or are of an equivalent quality standard. Brake pads/linings which have not been approved for smart vehicles or which are not of an equivalent quality could affect your vehicle's operating safety.

smart recommends that you only use brake fluid which is approved for smart vehicles or is of an equivalent quality standard. Brake fluid which has not been approved for smart vehicles or which is not of an equivalent quality could affect your vehicle's operating safety.

Driving on wet roads

Hydroplaning

If water has accumulated to a certain depth on the road surface, there is a danger of hydroplaning occurring, even if:

- you drive at low speeds.
- the tires have adequate tread depth.

For this reason, in the event of heavy rain or in conditions in which hydroplaning may occur, you must drive in the following manner:

- lower your speed.
- avoid ruts.
- avoid sudden steering movements
- brake carefully.

Driving on flooded roads

! Bear in mind that vehicles traveling in front or in the opposite direction create waves. This may cause the maximum permissible water depth to be exceeded.

Failure to observe these notes may result in damage to the engine, electrical systems and transmission.

Prevent water from entering the vehicle interior or the engine compartment. If you must drive through standing water, bear in mind that:

- the water level should not exceed the lower edge of the vehicle body in still water
- you should drive no faster than at walking pace.

Winter driving

WARNING

If you shift down on a slippery road surface in an attempt to increase the engine's braking effect, the drive wheels could lose their grip. There is an increased danger of skidding and accidents.

Do not shift down for additional engine braking on a slippery road surface.

DANGER

If the exhaust pipe is blocked or adequate ventilation is not possible, poisonous gases such as carbon monoxide (CO) may enter the vehicle. This is the case, e.g. if the vehicle becomes trapped in snow. There is a risk of fatal injury.

If you have to leave the engine running, keep the exhaust pipe and the area around the vehicle free of snow. To ensure an adequate supply of fresh air, open a window on the side of the vehicle that is not facing into the wind.

Have your vehicle winterproofed at a qualified specialist workshop at the onset of winter.

Drive particularly carefully on slippery road surfaces. Avoid sudden acceleration, steering and braking maneuvers. Do not use cruise control.

If the vehicle threatens to skid or cannot be stopped when moving at low speed:

- ▶ Try to bring the vehicle under control using corrective steering.
- ▶ **Vehicles with automatic transmission:** shift the transmission to position **N**.

The outside temperature indicator is not designed to serve as an ice-warning device and is therefore unsuitable for that purpose. Changes in the outside temperature are displayed after a short delay.

Indicated temperatures just above the freezing point do not guarantee that the road surface is free of ice. The road may still be icy, especially in wooded areas or on bridges.

You should pay special attention to road conditions when temperatures are around freezing point.

For more information on driving with snow chains, see (▷ page 173).

For more information on driving with summer tires, see (▷ page 173).

Observe the notes in the "Winter operation" section (▷ page 172).

Driving systems

Cruise control

General notes

Cruise control maintains a constant road speed for you. Cruise control does not brake the vehicle automatically. Only the engine's braking effect is available. In order to reduce speed and maintain distance to other road users, you need to brake yourself. This interrupts cruise control.

Use cruise control only if road and traffic conditions make it appropriate to maintain a steady speed for a prolonged period. You can use cruise control at speeds above 20 mph (30 km/h).

Important safety notes

If you fail to adapt your driving style, cruise control can neither reduce the risk of an accident nor override the laws of physics. Cruise control cannot take into account road, weather or traffic conditions. Cruise control is only an aid. You are responsible for the distance to the vehicle in front, for vehicle speed, for braking in good time and for staying in lane.

Do not use cruise control:

- in road and traffic conditions which do not allow you to maintain a constant speed e.g. in heavy traffic or on winding roads
- on slippery road surfaces. Braking or accelerating could cause the drive wheels to lose traction and the vehicle could then skid
- when there is poor visibility, e.g. due to fog, heavy rain or snow

If there is a change of drivers, advise the new driver of the speed stored.

Cruise control buttons

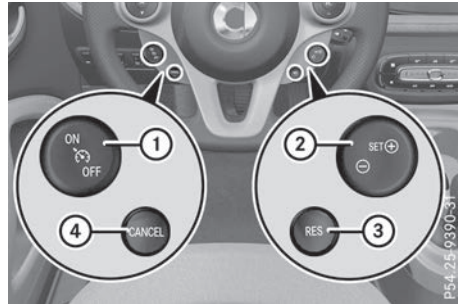

- ① Activates/deactivates cruise control
- ② Stores, increases or reduces the current speed
- ③ Calls up the last speed stored
- ④ Interrupts cruise control

Activating cruise control

Cruise control must be activated before it can be used.

- ▶ Press switch ① (ON).

Cruise control is activated.

The  symbol appears in the multifunction display.

- i** When you switch off the engine, cruise control remains activated and the last speed stored is cleared.

Storing and maintaining the current speed

While cruise control is active, you can set the current speed starting from 20 mph (30 km/h).

- ▶ Accelerate the vehicle to the desired speed.

- ▶ Press switch ② () and release it.

- ▶ Remove your foot from the accelerator pedal.

Cruise control is activated. The vehicle automatically maintains the stored speed.

 SET is shown in the multifunction display.

- i** Cruise control may be unable to maintain the stored speed on uphill gradients. The stored speed is resumed when the gradient evens out.

On downhill gradients, only the engine's braking effect is available. You have to operate the brakes yourself to reduce speed. This interrupts cruise control.

Calling up the last speed stored

WARNING

If you call up the stored speed and it is different to the current speed, the vehicle will accelerate. If you are not aware of the stored speed, the vehicle may accelerate unexpectedly. There is a risk of an accident.

Pay attention to the road and traffic conditions before calling up the stored speed. If you do not know the stored speed, store the desired speed again.



- ▶ Press button **③**  and release it. Cruise control is activated and adjusts the vehicle's speed to the last speed stored.
- ▶ Remove your foot from the accelerator pedal.

i When you switch off the engine, the last speed stored is cleared.

Increasing or decreasing the speed

In order to be able to increase or decrease the speed, a speed must already have been stored.

i Cruise control is not deactivated if you depress the accelerator pedal. For example, if you accelerate briefly to overtake, cruise control adjusts the vehicle's speed to the last speed stored after you have finished overtaking.

- : increases the speed
- -: decreases the speed
- ▶ Press switch **②** () or (-) repeatedly until the desired speed is reached. The speed is gradually increased or reduced.

or

- ▶ Press and hold switch **②** () or (-) until the desired speed is reached.
- ▶ Release the switch. The new speed is stored.

Interrupting cruise control

When cruise control is switched on, you can cancel cruise control at any time and call up the stored speed again later.

i When you switch off the engine, the last speed stored is cleared.

- ▶ Press button **④**  and release it.

or

- ▶ Brake. Cruise control is interrupted.

Cruise control is also canceled when:

- you engage the parking brake
- you depress the clutch
- ESP[®] intervenes

Deactivating cruise control

- ▶ Press switch **①** (OFF). Cruise control is deactivated. The  symbol goes out in the multifunction display.

Parking aid

General notes

The rear parking aid uses an acoustic signal to indicate the distance between your vehicle and an obstacle. If you engage reverse gear while the engine is running, the parking aid is activated automatically.

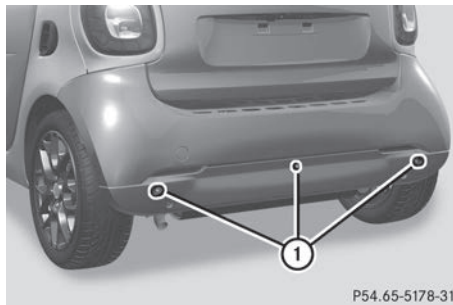

The parking aid uses three sensors **①** in the rear bumper to monitor the area behind your vehicle. The sensors must be free from dirt, ice or slush. They can otherwise not function correctly. Clean the sensors regularly, taking care not to scratch or damage them.

When reverse gear is engaged the system measures the distance between your vehicle and an object. If the proximity to the object behind the vehicle is less than 4.0 ft (1.20 m) a beeping sound is issued. As the distance to the object decreases the frequency increases. When the object is a maximum of 1.0 ft (30 cm) a continuous tone is issued.

Important safety notes

The parking aid feature is only intended as an aid. It is not a replacement for your attention to your immediate surroundings. You are always responsible for safe maneuvering, parking and exiting a parking space. When maneuvering, parking or pulling out of a parking space, make sure that there are no persons, animals or objects in the area in which you are maneuvering.

! When parking, pay particular attention to objects above or below the sensors, such as flower pots or trailer drawbars. The parking aid does not detect such objects if they are in the immediate vicinity of the vehicle. You could damage the vehicle or the objects.

The sensors may not detect snow and other objects that absorb ultrasonic waves.

Ultrasonic sources such as an automatic car wash, the compressed-air brakes of a truck or a pneumatic drill could cause the parking aid to malfunction.

The parking aid may not function correctly on uneven terrain.

The parking aid does not take into account obstacles located:

- below the detection range, e.g. people, animals or objects
- above the detection range, e.g. overhanging loads, truck overhangs or loading ramps.

Deactivating/activating the parking aid

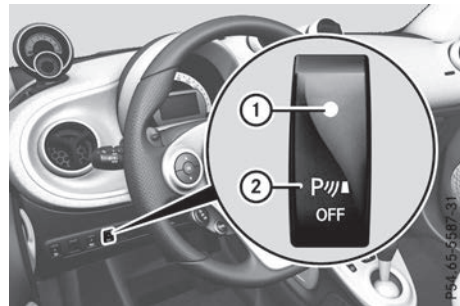

- ▶ Press button ②. Indicator lamp ① lights up. The system is deactivated.
- ▶ Press button ② again. Indicator lamp ① goes out. The system is reactivated.

i The parking aid is automatically activated when you start the engine.

If you engage reverse gear while the engine is running, the parking aid is activated automatically. An acoustic signal sounds when reverse gear is selected.

If reverse gear is no longer engaged, the parking aid is deactivated.

Important safety notes

WARNING

If you operate information systems and communication equipment integrated in the vehicle while driving, you will be distracted from traffic conditions. You could also lose control of the vehicle. There is a risk of an accident.

Only operate the equipment when the traffic situation permits. If you are not sure that this is possible, park the vehicle paying attention to traffic conditions and operate the equipment when the vehicle is stationary.

You must observe the legal requirements for the country in which you are currently driving when operating the on-board computer.

WARNING

If the instrument cluster has failed or malfunctioned, you may not recognize function restrictions in systems relevant to safety. The operating safety of your vehicle may be impaired. There is a risk of an accident.

Drive on carefully. Have the vehicle checked at a qualified specialist workshop immediately.

The on-board computer only shows display messages and/or warnings from certain systems in the display. You should therefore make sure your vehicle is operating safely at all times. Otherwise, you may cause an accident by driving a vehicle that is not operating reliably.

If the operating safety of your vehicle is impaired, park the vehicle as soon as possible paying attention to road and traffic conditions. Contact a qualified specialist workshop.

Read and follow the notes in the overview of warning and indicator lamps in the instrument cluster (▷ page 26).

Displays and operation

Instrument cluster lighting

Instrument cluster lighting includes illumination of the instrument cluster, the additional instruments on the dashboard, the displays and the controls.

The instrument cluster lighting is switched automatically between day and night lighting depending on the ambient light conditions (▷ page 68).

You can additionally set the brightness of the instrument cluster lighting to different levels in the on-board computer (▷ page 111).

Speedometer

If you turn the key to position **2** in the ignition lock, the warning and indicator lamps in the instrument cluster will briefly light up for a lamp test. During the lamp test, the illuminated speedometer needle moves in the speedometer.

The display can show a digital speedometer. The digital speedometer can be hidden/ displayed and its speed unit selected (▷ page 112).

Outside temperature display

You should pay special attention to road conditions when temperatures are around freezing point.

Bear in mind that the outside temperature display indicates the temperature measured and does not record the road temperature.

The outside temperature is displayed on the far right in the top bar.

Changes in the outside temperature are displayed after a short delay.

You can set the temperature unit of the outdoor temperature display (▷ page 113).

Fuel gauge



Fuel gauge

- ① Reserve fuel display
- ② Fuel gauge
- ③ Fuel filler flap location indicator
 - ▶ The fuel filler cap is located on the right
- ④  Reserve fuel (yellow)

Fuel gauge ② is shown in the display as a segment display with eight segments.

When the fuel level falls below the reserve range of 5.0 l, the last illuminated segment of the fuel display will flash and a warning tone will sound. Reserve fuel display ① will also appear. The reserve fuel display shows the numeric value of the remaining fuel level in 0.5 l increments.

In addition:

-  symbol ④ also appears in yellow
- a display message is also shown (▷ page 121).

Additional instruments on the dashboard

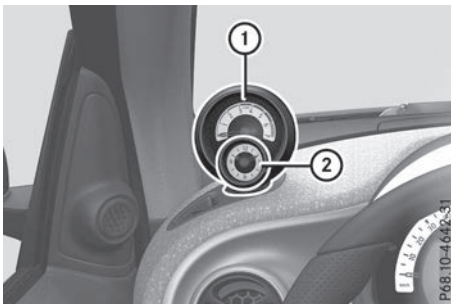

! Do not drive in the overrevving range, as this could damage the engine.

 **Environmental note**

Avoid driving at high engine speeds. This unnecessarily increases the fuel consumption of your vehicle and harms the environment as a result of increased emissions.

The overrevving range of the engine is shown with dashed lines in the orange marking of rev counter ①. The fuel supply is interrupted to protect the engine when the overrevving range is reached.

Dashboard clock ② is synchronized with the clock in the on-board computer.

Rev counter ①, together with dashboard clock ②, can be rotated approximately 60° on the dashboard.

You can additionally set the brightness of the instrument cluster lighting to different levels (▷ page 111).

Operating the on-board computer

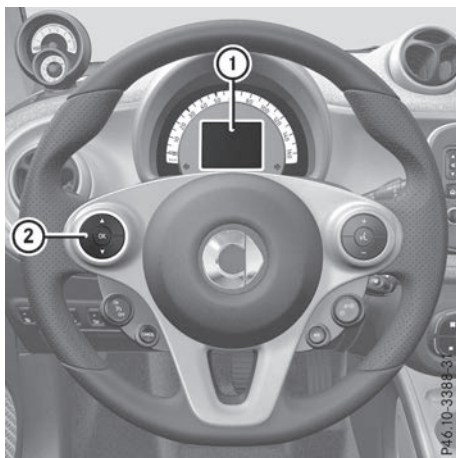

- ① Color display
- ② Left control panel

▶ **To activate the on-board computer:** unlock the vehicle and open a door. If you do not subsequently lock the door, the on-board computer will remain active for

approximately 15 minutes without any further activity.

or

- ▶ Turn the key to position **1** in the ignition lock.

You can control the display and the settings in the on-board computer using the steering wheel buttons on left control panel ②.

Left control panel ②



Press briefly:

- To scroll through a menu
- To scroll through a sub-menu or list

Press and hold:

- To switch directly to the **Dis-tance** menu at menu level
- To switch directly to the **back** function at the submenu level



- Confirms your selection
- In certain menus, switches to the **Reset Values?** function
- Hides the display message

Display

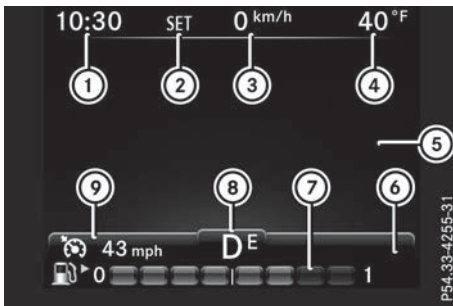

- ① Time (▷ page 111)
- ② SET
- ③ Digital speedometer (▷ page 112)
- ④ Outside temperature display (▷ page 106)
- ⑤ Display field for display messages, menus and lists
- ⑥ Reserve fuel display (▷ page 107)
- ⑦ Fuel level (▷ page 107)
- ⑧ Transmission display

Vehicles with manual transmission:

- Standard display

Vehicles with automatic transmission:

- Standard display with drive program
- or Gear indicator (manual mode)

- Vehicles with manual transmission: gearshift recommendation (▷ page 89)

- Transmission malfunction (▷ page 95)

- ⑨ Cruise control (▷ page 103)

Menus and sub menus

Menu overview

Picture the arrangement of the menus and displays as a circle.

At the menu level, a segment display is shown on the right side of the display to help navigation. The segment marked corresponds with the list position of the menu in the following list. For long lists within the menus and submenus, a scroll bar on the right side of the display serves to assist orientation.

Operating the on-board computer (▷ page 107).

Depending on the vehicle equipment, you can call up the following menus one after the other:

- **Distance** menu (▷ page 109)
- **from Start** trip computer menu (▷ page 109)
- **from Reset** trip computer menu (▷ page 109)
- **Fuel consumption** menu (▷ page 109)
- **Coolant Temperature** menu (▷ page 109)
- **Messages and Service** menu (▷ page 110)
- **Settings** menu (▷ page 110)

Odometer menu



Example: distance

- ▶ **To show:** press the or button on the steering wheel to select the trip meter display. The display shows trip meter ① and total distance recorder ②.
- ▶ **To reset the data:** press the button on the steering wheel.
- ▶ Press the or button to select **yes** and press the button to confirm. The trip meter is reset.

You can change the unit for the trip meter in the **Display** submenu (▷ page 112).

Trip computer menu "From start" or "From reset"

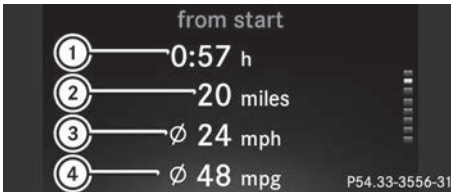

Example: trip computer "From start"

- ① Elapsed time
 - ② Distance
 - ③ Average speed
 - ④ Average fuel consumption
- ▶ **To display:** press the or button on the steering wheel to select the **from Start** or **from Reset** trip computer menu.

The data in the **from Start** trip computer menu refers to the start of the journey. The data in the **from Reset** trip computer submenu refers to the last time the submenu was reset.

The **from Start** trip computer is automatically reset when:

- the ignition has been switched off for more than 4 hours.
- 999 hours have been exceeded.
- 9,999 miles have been exceeded.

The **from Reset** trip computer is automatically reset if the value exceeds 9,999 hours or 99,999 miles.

The unit of distance for the journey, speed and consumption information can be changed in the **Display** submenu (▷ page 112).

Fuel consumption menu

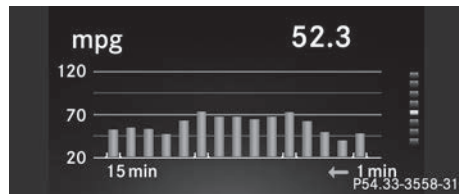

Example: fuel consumption

- ▶ Press the or button on the steering wheel to select the display of current fuel consumption.

The display shows the fuel consumption over the previous 15 minutes as a bar chart. The display additionally shows the current fuel consumption as a numeric value in the upper right section of the display.

If you switch off the ignition, or change the distance unit, the fuel consumption data is deleted automatically.



You can change the distance unit in the **Display** submenu (▷ page 112).

Coolant temperature menu

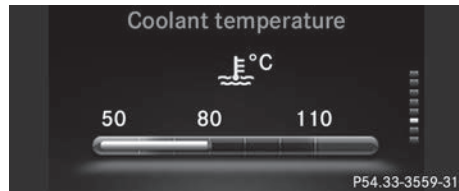
Under normal operating conditions and with the specified coolant level, the coolant temperature may rise to 230 °F (110 °C).



Example: coolant temperature

- ▶ Press the  or  button on the steering wheel to select the coolant temperature display. The display shows the current coolant temperature as a bar in the range between 50 and 110 °C. If the coolant temperature rises above 110 °C, then the display shows a display message (▷ page 121). Observe the display message. You could otherwise damage the engine.



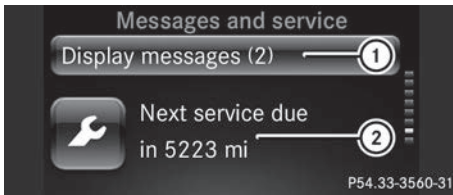

You can change the temperature unit in the **Display** submenu (▷ page 113).

Messages and service menu



Example: messages and service

If you have hidden display messages these are saved in the message memory. The menu shows the number of display messages in message memory ① and next service due date ② (▷ page 149). The message memory can only be called up when the ignition is switched on.

- ▶ Press the  or  button on the steering wheel to select the **Messages and Service** menu. The display shows the number of display messages in the message memory and the next service due date. If there are no display messages, then the value in brackets is 0 and the information on the  button is hidden.
- ▶ **To show display messages:** press the  button on the steering wheel. The lower area on the right of the display shows the display message, its list number and then number of display messages in the message memory.
- ▶ Press  to scroll through the display messages in the message memory.

Pressing  only allows you to scroll back to messages which have already been read.

If you scroll back from the first display message using , the **Messages and Service** menu will again be shown in the display. Existing display messages are not shown.

Settings menu

Introduction

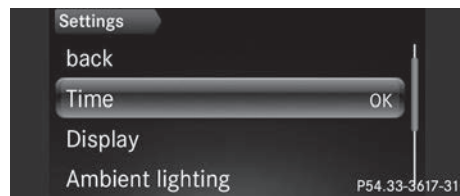



In the **Settings** menu, as well as in its submenu, a navigation bar is also shown at the top of the display field. The navigation bar serves for quick orientation and shows the navigation path to the current selection shown in the display (submenu/function). The selection shown in the display is highlighted in the navigation path.

Depending on the vehicle equipment, you can call up the following submenus in the **Settings** menu:



- **Time** submenu (▷ page 111)
 - For vehicles with a smart Media-System, the time is set using the smart Media-System.
 - Sets the time and the time format (12/24 h)
- **Display** submenu (▷ page 111)
 - Adjusts the instrument cluster lighting
 - Shows and sets the digital speedometer
 - Sets the units for distance and temperature
- **Ambient Lighting** submenu (▷ page 113)
 - Sets and switches the ambient lighting on/off
- **Tire Pressure Monitor** submenu
 - Restarts the tire pressure monitor (▷ page 179)
- **Language (Language)** submenu (▷ page 113)
 - Sets the menu language

The **Settings** menu and some submenus also show the **back** function.

If the **back** function is shown, you have to select the function to leave the menu.

- ▶ Press the  or  button on the steering wheel to select the **back** function and press  on the steering wheel to confirm.

This exits the menu, and the display shows the next higher menu level.

- i** If you press and hold  or , you change directly to the **back** function.



Time submenu

Introduction



This submenu is not available on vehicles with a smart Media-System. You set the time using the smart Media-System.

The **Time** submenu offers the following options:



- Setting the time
- Setting the time format (12/24 h)

- ▶ **To leave the submenu:** press the  or  button on the steering wheel to select the **back** function and press  on the steering wheel to confirm.

The display shows the **Settings** menu.



- i** If you press and hold  or , you change directly to the **back** function.

Setting the time

- ▶ Press the  or  button on the steering wheel to select the **Settings** menu and press  on the steering wheel to confirm.



- ▶ Press the  or  button to select the **Time** submenu and confirm with .

- ▶ Press the  or  button to select **Set Clock** and press the  button to confirm.



- ▶ Press the  or  button to set the hour and confirm with .

- ▶ Press the  or  button to set the minutes and confirm with .

The time is set and the display shows the **Time** submenu.



- i** If you are setting the time and keep the  or  button depressed, then the numerical value changes continuously.

Setting the time format (12/24 h)

- ▶ Press the  or  button on the steering wheel to select the **Settings** menu and press  on the steering wheel to confirm.

- ▶ Press the  or  button to select the **Time** submenu and confirm with .

- ▶ Press  or  to select **Time Format (12/24 h)** and confirm with .

- ▶ Press  or  to select the desired time format **24 Hours** or **12 Hours (am/pm)** and confirm with .



The time format is accepted and the display shows the **Time** submenu.

Display submenu



Introduction

In the **Display** submenu, you can call up the following submenus:

- **Brightness Display/Switches** submenu (▷ page 111)
 - Adjusting the instrument cluster lighting
- **Digital Speedometer** submenu, see (▷ page 112)
 - Shows and sets the digital speedometer
- **Units of Distance** submenu (▷ page 112)
 - Setting the units of distance
- **Units of Temperature** submenu (▷ page 113)
 - Setting the units of temperature

- ▶ **To leave the submenu:** press the  or  button on the steering wheel to select the **back** function and press  on the steering wheel to confirm.













The display shows the **Settings** menu.

- i** If you press and hold  or , you change directly to the **back** function.

Adjusting the instrument cluster lighting













Instrument cluster lighting includes illumination of the instrument cluster, the additional instruments on the dashboard, the displays and the controls.











You can set the brightness of the instrument cluster to different levels with the **Brightness Display/Switches** function.

- ▶ Press the  or  button on the steering wheel to select the **Settings** menu and press  on the steering wheel to confirm.
- ▶ Press the  or  button to select the **Display** submenu and confirm with .
- ▶ Press the  or  button to select **Brightness Display/Switches** and press the  button to confirm.
- ▶ Press the  or  button to set the brightness level. Level 1 corresponds to dimmed instrument lighting and level 5 to bright instrument lighting. With the selection during night-time driving, the instrument cluster brightness level is set at the same time.
- ▶ Press the  button to confirm the setting. The instrument lighting is set and the display shows the **Display** submenu.

Digital speedometer submenu

In the **Digital Speedometer** submenu you have the following options:

- showing/hiding the digital speedometer
- setting the unit for speed in the digital speedometer
- ▶ **To call up the submenu:** press the  or  button on the steering wheel to select the **Settings** menu and press  on the steering wheel to confirm.
- ▶ Press the  or  button to select the **Display** submenu and confirm with .
- ▶ Press the  or  button to select the **Digital Speedometer** submenu and confirm with .
- ▶ **To show/hide the digital speedometer:** press the  or  button to select the **On** function.
- ▶ Activate or deactivate the **On** function by pressing the  button. When the function is highlighted, it is activated and the display shows the digital speedometer (▷ page 108).













- ▶ **To set the unit of speed:** press the  or  button to select **Unit** and press the  button to confirm.
- ▶ Press the  or  button to select the unit of speed **km/h** or **mph** and confirm with .
- The display shows the **Digital Speedometer** submenu.
- ▶ **To leave the submenu:** press the  or  button to select the **back** function and confirm with .
- The display shows the **Display** submenu.
- ❗ If you press and hold  or , you change directly to the **back** function.

Setting the unit of measurement for distance

If you change the unit of measurement for distance, the values in the:

- trip computer "From start" or "From reset" (▷ page 109)
 - Fuel consumption (▷ page 109)
- menus are also reset automatically.

You can only set the unit of measurement for distance when the vehicle is stationary.













- ▶ Press the  or  button on the steering wheel to select the **Settings** menu and press  on the steering wheel to confirm.
- ▶ Press the  or  button to select the **Display** submenu and confirm with .
- ▶ Press the  or  button to select **Units of Distance** and press the  button to confirm.
- ▶ Press the  or  button to select **Kilometers** or **Miles** as the unit of measurement for distance and press  to confirm. The display shows the **Display** submenu.

The selected unit of measurement for distance applies as the basis for:

- the trip computer
- the service display
- the fuel consumption display
- the total distance recorder and the trip meter display
- the cruise control speed display

Setting the temperature unit





You can switch the display of the outside temperature and the coolant temperature between °C and °F.

- ▶ Press the  or  button on the steering wheel to select the **Settings** menu and press  on the steering wheel to confirm.
 - ▶ Press the  or  button to select the **Display** submenu and confirm with .
 - ▶ Press the  or  button to select **Units of Temperature** and press the  button to confirm.
 - ▶ Press the  or  button to select the unit of temperature °C or °F and confirm with .
- The display shows the **Display** submenu.









Ambient lighting submenu

Introduction

In the **Ambient Lighting** submenu you have the following options:













- switching the ambient lighting on/off
 - setting the brightness of the ambient lighting to different levels
 - ▶ **To leave the submenu:** press the  or  button on the steering wheel to select the **back** function and press  on the steering wheel to confirm.
- The display shows the **Settings** menu.
- i** If you press and hold  or , you change directly to the **back** function.

Switching the ambient lighting on/off















- ▶ Press the  or  button on the steering wheel to select the **Settings** menu and press  on the steering wheel to confirm.
 - ▶ Press the  or  button to select the **Ambient Lighting** submenu and confirm by pressing the .
 - ▶ Press the  or  button to select the **on** function.
 - ▶ Activate or deactivate the **on** function by pressing the .
- When the function is highlighted it is activated and the ambient lighting is switched on.

To set the brightness

You can set the brightness of the ambient lighting to different levels.

- ▶ Press the  or  button on the steering wheel to select the **Settings** menu and press  on the steering wheel to confirm.
- ▶ Press the  or  button to select the **Ambient Lighting** submenu and confirm by pressing the  button. You will see the selected setting.
- ▶ Press the  or  button to select **Brightness** and press the  button to confirm.
- ▶ Press the  or  button to set the brightness level. Level **1** corresponds to dimmed ambient lighting and level **5** to bright ambient lighting. With the selection, the ambient lighting brightness level is set at the same time.
- ▶ Press the  button to save the setting. The brightness of the ambient lighting is set and the display shows the **Ambient Lighting** submenu.

Language submenu

- ▶ Press the  or  button on the steering wheel to select the **Settings** menu and press  on the steering wheel to confirm.
 - ▶ Use  or  to select the **Language (Language)** submenu and confirm with .
 - ▶ Press the  or  button to select the desired language for the displays and messages and confirm with .
 - ▶ Press the  or  button on the steering wheel to select the **back** function and press  on the steering wheel to confirm. The display shows the **Settings** menu in the selected language.
- i** If you press and hold  or , you change directly to the **back** function.

Display messages









Introduction



Display messages with graphic symbols are simplified in the Operator's Manual and may differ from the symbols in the display. The display shows high-priority messages in red. For certain display messages a warning tone also sounds.





Please respond in accordance with the display messages and follow the additional notes in this Operator's Manual.



You can use the button on the multifunction steering wheel to hide low-priority messages. The display messages are stored in the message memory and can be called up as for as long as the ignition remains switched on (▷ page 110). When the ignition is turned off, the message memory is deleted and no display messages are stored. The cause of a display message should be remedied as soon as possible.



High-priority display messages cannot be hidden. The multifunction display shows these messages continuously until the causes for the messages have been remedied.





Safety systems	
Display messages	Possible causes/consequences and ► Solutions
 Malfunction Visit Workshop	<p>The restraint system is faulty.</p> <p> WARNING</p> <p>The air bags or Emergency Tensioning Devices may either be triggered unintentionally or, in the event of an accident, may not be triggered.</p> <p>There is an increased risk of injury.</p> <ul style="list-style-type: none"> ► Drive on carefully. ► Have the restraint system checked at a qualified specialist workshop immediately. <p>For further information about the restraint system, see (► page 31).</p>
Electronics Malfunction Stop See Operator's Manual	<p>In addition, the , ABS and BRAKE (USA) or   and  (Canada) warning lamps light up in the instrument cluster and a warning tone sounds.</p> <p>ABS (Anti-lock Braking System) and ESP® (Electronic Stability Program) are malfunctioning. This means that Crosswind Assistance hill start assist, for example, are also unavailable.</p> <p>Other driving systems could be switched off automatically.</p> <p> WARNING</p> <p>The brake system continues to function normally, but without the functions listed above. The front and rear wheels could therefore lock if you brake hard, for example.</p> <p>The steerability and braking characteristics may be severely affected. The braking distance in an emergency braking situation can increase.</p> <p>If ESP® is not operational, ESP® is unable to stabilize the vehicle. There is an increased risk of skidding and an accident.</p> <ul style="list-style-type: none"> ► Pull over and stop the vehicle safely as soon as possible, paying attention to road and traffic conditions. Do not continue driving under any circumstances. ► Secure the vehicle against rolling away (► page 97). ► Consult a qualified specialist workshop.
<p>BRAKE (USA only)  (Canada only)</p> Release Parking Brake	<p>You are driving with the parking brake engaged.</p> <ul style="list-style-type: none"> ► Release the parking brake.



Display messages	Possible causes/consequences and ► Solutions
<p>Brake Force Distribution Inoperative Stop See Operator's Manual</p>	<p>In addition, the BRAKE (USA) or  warning lamps light up in the instrument cluster and a warning tone sounds.</p> <p>EBD is malfunctioning. This means that ABS, ESP®, Crosswind Assist and hill start assist, for example, are also unavailable. Other driving systems could be switched off automatically.</p> <p>⚠ WARNING</p> <p>The brake system continues to function normally, but without the functions listed above. The front and rear wheels could therefore lock if you brake hard, for example.</p> <p>The steerability and braking characteristics may be severely affected. The braking distance in an emergency braking situation can increase.</p> <p>If ESP® is not operational, ESP® is unable to stabilize the vehicle. There is an increased risk of skidding and an accident.</p> <ul style="list-style-type: none"> ► Pull over and stop the vehicle safely as soon as possible, paying attention to road and traffic conditions. Do not continue driving under any circumstances. ► Secure the vehicle against rolling away (▷ page 97). ► Consult a qualified specialist workshop.
<p>BRAKE (USA only)  (Canada only) Check Brake Fluid Level</p>	<p>There is not enough brake fluid in the brake fluid reservoir.</p> <p>⚠ WARNING</p> <p>The braking effect may be impaired. There is a risk of an accident.</p> <ul style="list-style-type: none"> ► Pull over and stop the vehicle safely as soon as possible, paying attention to road and traffic conditions. Do not continue driving under any circumstances. ► Secure the vehicle against rolling away (▷ page 97). ► Do not add brake fluid. This does not correct the malfunction. ► Consult a qualified specialist workshop.

Display messages	Possible causes/consequences and ► Solutions
<p> (USA only)  (Canada only) System Inoperative</p>	<p>ABS is malfunctioning. This means that ESP®, Crosswind Assist and hill start assist, for example, are also unavailable. Other driving systems could be switched off automatically.</p> <p> WARNING</p> <p>The brake system continues to function normally, but without the functions listed above. The wheels could therefore lock if you brake hard, for example. The steerability and braking characteristics may be severely affected. The braking distance in an emergency braking situation can increase. If ESP® is not operational, ESP® is unable to stabilize the vehicle. There is an increased risk of skidding and an accident.</p> <ul style="list-style-type: none"> ► Drive on carefully. ► Visit a qualified specialist workshop. <p>If the ABS control unit is faulty, there is also a possibility that other systems may be unavailable.</p>
<p> System Inoperative</p>	<p>ESP® is not available due to a malfunction. Other driving systems could be switched off automatically.</p> <p> WARNING</p> <p>The brake system continues to function normally, but without the functions listed above. The braking distance in an emergency braking situation can thus increase. The brake lamps may not be functioning and thus no longer working when braking. If ESP® is not operational, ESP® is unable to stabilize the vehicle. There is an increased risk of skidding and an accident.</p> <ul style="list-style-type: none"> ► Pull over and stop the vehicle safely as soon as possible, paying attention to road and traffic conditions. Do not continue driving under any circumstances. ► Secure the vehicle against rolling away (▷ page 97). ► Check that the brake lamps are working. <p>If the brake lamps are not working:</p> <ul style="list-style-type: none"> ► Consult a qualified specialist workshop. <p>If the brake lamps are working:</p> <ul style="list-style-type: none"> ► Drive on carefully. ► Visit a qualified specialist workshop.

Display messages	Possible causes/consequences and ► Solutions
<p>Hill Start Assist Inoperative</p>	<p>The  warning lamp also lights up in the instrument cluster. Hill start assist is malfunctioning. If you release the brake, your vehicle will not be held automatically when pulling away uphill and may roll away immediately. Other driving systems could be switched off automatically.</p> <p> WARNING</p> <p>The brake system continues to function normally, but without the functions listed above. If ESP® is not operational, ESP® is unable to stabilize the vehicle. There is an increased risk of skidding and an accident.</p> <ul style="list-style-type: none"> ► Drive on carefully. ► Visit a qualified specialist workshop.

Display messages	Possible causes/consequences and ► Solutions
 <p>Distance Warning Inoperative</p>	<p>The distance warning function is temporarily inoperative. Possible causes are:</p> <ul style="list-style-type: none"> • the smart logo in the radiator trim is dirty. • function is impaired due to heavy rain or snow. • the radar sensor system is temporarily inoperative, e.g. due to electromagnetic radiation emitted by nearby TV or radio stations or other sources of electromagnetic radiation. • the system is outside the operating temperature range. • the on-board voltage is too low. <p>When the causes stated above no longer apply, the display message disappears.</p> <p>The distance warning function is operational again.</p> <p>If the display message does not disappear:</p> <ul style="list-style-type: none"> ► Pull over and stop the vehicle safely as soon as possible, paying attention to road and traffic conditions. ► Secure the vehicle against rolling away (> page 97). ► Clean the smart logo in the radiator trim (> page 154). ► Restart the engine.
 <p>Electronics Malfunction Visit Workshop</p>	<p>The distance warning function is malfunctioning or temporarily inoperative. Possible causes are:</p> <ul style="list-style-type: none"> • the smart logo in the radiator trim is dirty. • function is impaired due to heavy rain or snow. • the radar sensor system is temporarily inoperative, e.g. due to electromagnetic radiation emitted by nearby TV or radio stations or other sources of electromagnetic radiation. • the system is outside the operating temperature range. • the on-board voltage is too low. <p>If the causes listed above no longer apply, the distance warning function is operational again.</p> <p>If the display message continues to light up, the electronics of the distance warning function are malfunctioning.</p> <ul style="list-style-type: none"> ► Visit a qualified specialist workshop.

Engine	
Display messages	Possible causes/consequences and ► Solutions
 <p>Reduced Power See Operator's Manual</p>	<p>The engine is running in emergency mode. For example, the fuel injection may be faulty.</p> <ul style="list-style-type: none"> ► Drive on carefully. ► Visit a qualified specialist workshop immediately. <p>i In some states, you must immediately visit a qualified specialist workshop as soon as the yellow Check Engine warning lamp lights up. This depends on the locally applicable legal requirements. If in doubt, check whether such legal regulations apply in the state in which you are currently driving.</p>
 <p>Malfunction Visit Workshop</p>	<p>The battery monitoring is malfunctioning.</p> <ul style="list-style-type: none"> ► Visit a qualified specialist workshop.
 <p>Stop See Operator's Manual</p>	<p>The battery is not being charged.</p> <p>Possible causes are:</p> <ul style="list-style-type: none"> • a defective alternator • a torn poly-V-belt • a malfunction in the electronics <ul style="list-style-type: none"> ► Pull over and stop the vehicle safely and switch off the engine, paying attention to road and traffic conditions. <p>! Do not continue driving. The engine could otherwise overheat.</p> <ul style="list-style-type: none"> ► Secure the vehicle against rolling away (▷ page 97). ► Consult a qualified specialist workshop.
 <p>Stop Switch Off Engine</p>	<p>The oil pressure is too low. There is a risk of engine damage.</p> <ul style="list-style-type: none"> ► Pull over and stop the vehicle safely and switch off the engine, paying attention to road and traffic conditions. ► Secure the vehicle against rolling away (▷ page 97). ► Check the oil level (▷ page 146). ► If necessary, add engine oil (▷ page 146). <p>Information on approved engine oils can also be obtained from any qualified specialist workshop.</p>

Display messages	Possible causes/consequences and ► Solutions
 <p>Stop Switch Off Engine</p>	<p>The coolant temperature has exceeded 230 °F (110 °C). The airflow to the engine radiator may be blocked or the coolant level may be too low.</p> <p>⚠ WARNING</p> <p>The engine is not being cooled sufficiently and may be damaged. Do not drive when your engine is overheated. This can cause some fluids which may have leaked into the engine compartment to catch fire.</p> <p>Steam from an overheated engine can cause serious burns, which can occur just by opening the engine compartment cover.</p> <p>There is a risk of injury.</p> <ul style="list-style-type: none"> ► Pull over and stop the vehicle safely and switch off the engine, paying attention to road and traffic conditions. ► Secure the vehicle against rolling away (▷ page 97). ► Leave the vehicle and keep a safe distance from the vehicle until the engine has cooled down. ► Check the coolant level and top up the coolant. Observe the notes as you do so (▷ page 203). ► If you need to add coolant more often than usual, have the engine coolant system checked. ► Make sure that the air supply to the engine radiator is not blocked, e.g. by snow, slush or ice. ► Do not start the engine again until the coolant temperature is below 230 °F (110 °C). Otherwise, the engine could be damaged. <p>Avoid subjecting the engine to heavy loads, e.g. driving in mountainous terrain, and stop-and-go traffic.</p>
 <p>Low Fuel Level</p>	<p>The fuel level has dropped into the reserve range.</p> <ul style="list-style-type: none"> ► Refuel at the nearest gas station.
 <p>Gas Cap Loose</p>	<p>The pressure in the fuel system has dropped. The fuel filler cap is not closed correctly or the fuel system is leaking.</p> <ul style="list-style-type: none"> ► Check that the fuel filler cap is correctly closed. <p>If the fuel filler cap is not correctly closed:</p> <ul style="list-style-type: none"> ► Close the fuel filler cap. <p>If the fuel filler cap is correctly closed:</p> <ul style="list-style-type: none"> ► Visit a qualified specialist workshop.

Driving systems

Display messages

Possible causes/consequences and ► Solutions



Cruise Control Inoperative

The  symbol in the display footer also flashes for approximately 10 seconds and a warning tone sounds. The symbol is then hidden.

Cruise control is malfunctioning and deactivated automatically.

- Visit a qualified specialist workshop.

Tires

Display messages

Possible causes/consequences and ► Solutions



Warning Tire Failure Correct Tire Pressure

The tire pressure in one or more tires has dropped suddenly.

WARNING

If you drive with a flat tire, there is a risk of the following hazards:

- A flat tire affects the ability to steer or brake the vehicle.
- You could lose control of the vehicle.
- Continued driving with a flat tire will cause excessive heat build-up and possibly a fire.

There is a risk of an accident.

- Stop the vehicle without making any sudden steering or braking maneuvers. Pay attention to the traffic conditions as you do so.
- Secure the vehicle against rolling away (▷ page 97).
- Check the tires and, if necessary, follow the instructions for a flat tire (▷ page 156).



Tire Pressure Monitor Inoperative

The tire pressure monitor is malfunctioning or was not restarted after a wheel change.

WARNING



The system is possibly unable to recognize or register low tire pressure.

There is a risk of an accident.







- Restart the tire pressure monitor after a wheel change (▷ page 179)
The tire pressure monitor is activated automatically after driving for a few minutes.

















If the display message continues to be displayed:



- Drive on carefully.
- Visit a qualified specialist workshop.

Display messages	Possible causes/consequences and ► Solutions
 <p>Tire Pressure Monitor Inoperative Wheel Sensors Missing</p>	<p>There is no signal from the tire pressure sensor of one or several wheels, or the wheels fitted do not have suitable tire pressure sensors. The tire pressure monitor was not restarted after a wheel change.</p> <p> WARNING</p> <p>The system is possibly unable to recognize or register low tire pressure. There is a risk of an accident.</p> <ul style="list-style-type: none"> ► Have the faulty tire pressure sensor replaced at a qualified specialist workshop. <p>or</p> <ul style="list-style-type: none"> ► Mount wheels with suitable tire pressure sensors. <p>or</p> <ul style="list-style-type: none"> ► Restart the tire pressure monitor after a wheel change (► page 179) The tire pressure monitor is activated automatically after driving for a few minutes. <p>If the display message continues to be displayed:</p> <ul style="list-style-type: none"> ► Drive on carefully. ► Visit a qualified specialist workshop.
 <p>Correct Tire Pressure</p>	<p>The tire pressure is too low in at least one of the tires, or the tire pressure difference between the wheels is too great.</p> <ul style="list-style-type: none"> ► Check the tire pressures at the next opportunity (► page 177). ► If necessary, correct the tire pressure. ► Restart the tire pressure monitor (► page 179).



Vehicle	
Display messages	Possible causes/consequences and ► Solutions
 <p>Brake Lights Inoperative</p>	<p>The brake lights are not functioning. The actuation or the bulbs/LEDs are faulty.</p> <p> WARNING</p> <p>Bulbs and lamps are an important aspect of vehicle safety. The brake lamps are not functioning and are no longer working when braking.</p> <p>There is a risk of an accident.</p> <ul style="list-style-type: none"> ► Pull over and stop the vehicle safely as soon as possible, paying attention to road and traffic conditions. ► Secure the vehicle against rolling away (▷ page 97). ► Consult a qualified specialist workshop.
<p>Switch Off Lights</p>	<p>The lights are still switched on when you leave the vehicle. A warning tone also sounds.</p> <ul style="list-style-type: none"> ► Turn the light switch to AUTO or 0.
 <p>(Example of all doors and tailgate open)</p>	<p>A door or the tailgate is open. A warning tone also sounds. The display shows the open doors/tailgate.</p> <ul style="list-style-type: none"> ► Pull over paying attention to road and traffic conditions and stop the vehicle, then close the doors and tailgate.
 <p>Power Steering Malfunction See Operator's Manual</p>	<p>The power steering is malfunctioning.</p> <p> WARNING</p> <p>You will need to use more force to steer.</p> <p>There is a risk of an accident.</p> <ul style="list-style-type: none"> ► Check whether you are able to apply the extra force required. ► If you are able to steer safely: carefully drive on to a qualified specialist workshop. ► If you are unable to steer safely: do not continue driving. Contact the nearest qualified specialist workshop.
 <p>Electronics Malfunction See Operator's Manual</p>	<p>The power steering assistance may be malfunctioning. You may need to use more force to steer.</p> <ul style="list-style-type: none"> ► Drive on carefully to a qualified specialist workshop and have the steering checked immediately.
 <p>Parking Lock Malfunction To Park: Apply Parking Brake</p>	<p>Only for vehicles with automatic transmission: the letter N flashes in the middle of the display if you try to shift to P. A warning tone also sounds.</p> <p>The parking lock is malfunctioning.</p> <ul style="list-style-type: none"> ► Apply the parking brake to park.



Display messages	Possible causes/consequences and ► Solutions
 To Start Engine: Apply Brake	<p>Vehicles with automatic transmission only: N is shown in the middle of the display.</p> <p>You have tried to start the engine in transmission position N without depressing the brake pedal.</p> <ul style="list-style-type: none"> ► Depress the brake pedal.
Transmission Not in P Risk of Vehicle Rolling Away	<p>Vehicles with automatic transmission only: a warning tone also sounds.</p> <p>The driver's door is open/not fully closed and the gear lever is in position R, N or D.</p> <p> WARNING</p> <p>The vehicle may roll away. There is a risk of an accident.</p> <ul style="list-style-type: none"> ► Shift the selector lever to position P. ► Secure the vehicle to prevent it from rolling away. ► Fully close the driver's door.
 Transmission Mal- function Visit Work- shop	<p>Vehicles with automatic transmission only:  is shown.</p> <p>The automatic transmission is malfunctioning.</p> <ul style="list-style-type: none"> ► Notify a qualified specialist workshop or breakdown service.
 or   /   Clutch Protection Active See Opera- tor's Manual	<p>Vehicles with automatic transmission only:  flashes alternately with the currently selected transmission position.</p> <p>The automatic transmission clutch has overheated. You will feel the clutch pedal pulsate.</p> <ul style="list-style-type: none"> ► Initially try to avoid pulling away or crawling maneuvers. The automatic transmission is available again when the display message goes out.
 or   /   Transmission Over- heated See Opera- tor's Manual	<p>Only for vehicles with automatic transmission:  flashes alternately with the currently selected transmission position. A warning tone also sounds.</p> <p>Further pulling away or crawling maneuvers have led to a critical clutch temperature.</p> <ul style="list-style-type: none"> ► Pull over and stop the vehicle safely as soon as possible, paying attention to road and traffic conditions. ► Secure the vehicle to prevent it from rolling away. ► Wait until the automatic transmission has cooled down and the display message does not reappear after acknowledging it.

Display messages	Possible causes/consequences and ► Solutions
Electronics Mal-function Visit Workshop	<p>In addition the  door warning lamp and other warning lamps, e.g. , light up.</p> <p>The central vehicle electronics system is malfunctioning.</p> <p>After the engine is switched off:</p> <ul style="list-style-type: none"> • do not lock/unlock the doors using the remote control function of the key • you can no longer start the engine. <p>► Pull over and stop the vehicle safely as soon as possible, paying attention to road and traffic conditions. Do not continue driving under any circumstances.</p> <p>► Secure the vehicle against rolling away (▷ page 97).</p> <p>► Consult a qualified specialist workshop.</p>
Electronics Mal-function Visit Workshop	<p>The transmission electronics are malfunctioning or the neutral sensor is faulty.</p> <p>Cruise control is automatically deactivated.</p> <p>Starting the engine is only possible with the clutch pedal fully depressed.</p> <p>► Visit a qualified specialist workshop.</p>
 Remove key	<p>The key is in the ignition lock, the engine is switched off and the driver's door is open.</p> <p>► Remove the key.</p>
Rain and Light Sensor Inoperative	<p>The rain/light sensor is malfunctioning.</p> <p>Automatic headlamp mode and automatic intermittent wipe are not available.</p> <ul style="list-style-type: none"> ► Switch on exterior lighting manually if required (▷ page 68). ► Switch the windshield wipers on or off manually as required (▷ page 75). <p>► Visit a qualified specialist workshop.</p>









Warning and indicator lamps in the instrument cluster







Safety







Seat belts





Problem	Possible causes/consequences and ► Solutions
 <p>After starting the engine, the red seat belt warning lamp lights up for six seconds.</p>	<p>The seat belt warning lamp reminds the driver and front passenger to fasten their seat belts. An additional warning tone will sound if the driver's seat belt is not fastened.</p> <ul style="list-style-type: none"> ► Fasten your seat belt (► page 33). The warning tone ceases.
 <p>After starting the engine, the red seat belt warning lamp lights up.</p>	<p>The driver or front passenger has not fastened their seat belt.</p> <ul style="list-style-type: none"> ► Fasten your seat belt (► page 33). The warning lamp goes out.
 <p>The red seat belt warning lamp flashes and a warning tone sounds.</p>	<p>The driver or front passenger has not fastened their seat belt. The vehicle is being driven faster than 12 mph (20 km/h) or has briefly been driven faster than 12 mph (20 km/h).</p> <ul style="list-style-type: none"> ► Fasten your seat belt (► page 33). The warning lamp goes out and the warning tone ceases.



Safety systems

Problem	Possible causes/consequences and ► Solutions
 <p>The red restraint system warning lamp is lit while the engine is running.</p>	<p>The restraint system is faulty.</p> <p> WARNING</p> <p>The air bags or Emergency Tensioning Devices may either be triggered unintentionally or, in the event of an accident, may not be triggered.</p> <p>There is an increased risk of injury.</p> <ul style="list-style-type: none"> ► Drive on carefully. ► Have the restraint system checked at a qualified specialist workshop immediately. <p>For further information about the restraint system, see (▷ page 31).</p>
<p> (USA only)</p> <p> (Canada only)</p> <p> </p> <p>The red brake system warning lamp, the yellow ESP® warning lamp and the yellow ABS warning lamp light up while the engine is running.</p>	<p> WARNING</p> <p>The brake system continues to function normally, but without the functions listed above. The front and rear wheels could therefore lock if you brake hard, for example.</p> <p>The steerability and braking characteristics may be severely affected. The braking distance in an emergency braking situation can increase.</p> <p>If ESP® is not operational, ESP® is unable to stabilize the vehicle. There is an increased risk of skidding and an accident.</p> <ul style="list-style-type: none"> ► Pull over and stop the vehicle safely as soon as possible, paying attention to road and traffic conditions. Do not continue driving under any circumstances. ► Secure the vehicle against rolling away (▷ page 97). ► Consult a qualified specialist workshop.
<p> (USA only)</p> <p> (Canada only)</p> <p>The red brake system warning lamp comes on while the vehicle is moving. A warning tone also sounds.</p>	<p>You are driving with the parking brake engaged.</p> <ul style="list-style-type: none"> ► Release the parking brake. The warning lamp goes out and the warning tone ceases.



Problem	Possible causes/consequences and ► Solutions
<p> (USA only)  (Canada only) The red brake system warning lamp comes on while the engine is running. A warning tone also sounds.</p>	<p>There is not enough brake fluid in the brake fluid reservoir.</p> <p> WARNING</p> <p>The braking effect may be impaired. There is a risk of an accident.</p> <ul style="list-style-type: none"> ► Observe the additional display messages. ► Pull over and stop the vehicle safely as soon as possible, paying attention to road and traffic conditions. Do not continue driving under any circumstances. ► Secure the vehicle against rolling away (▷ page 97). ► Do not add brake fluid. Adding more will not remedy the malfunction. ► Consult a qualified specialist workshop.
<p> (USA only)  (Canada only) The red brake system warning lamp comes on while the engine is running. A warning tone also sounds.</p>	<p>EBD (electronic brake force distribution) is malfunctioning. This means that ABS, ESP®, Crosswind Assist and hill start assist, for example, are also unavailable. Other driving systems could be switched off automatically.</p> <p> WARNING</p> <p>The brake system continues to function normally, but without the functions listed above. The wheels could therefore lock early if you brake hard, for example. The steerability and braking characteristics may be severely affected. The braking distance in an emergency braking situation can increase. If ESP® is not operational, ESP® is unable to stabilize the vehicle. There is an increased risk of skidding and an accident.</p> <ul style="list-style-type: none"> ► Pull over and stop the vehicle safely as soon as possible, paying attention to road and traffic conditions. Do not continue driving under any circumstances. ► Secure the vehicle against rolling away (▷ page 97). ► Consult a qualified specialist workshop.



Problem	Possible causes/consequences and ► Solutions
 <p>The yellow ABS warning lamp is lit while the engine is running.</p>	<p>ABS is malfunctioning. This means that ESP[®], Crosswind Assist and hill start assist, for example, are also unavailable. Other driving systems could be switched off automatically.</p> <p> WARNING</p> <p>The brake system continues to function normally, but without the functions listed above. The wheels could therefore lock if you brake hard, for example. The steerability and braking characteristics may be severely affected. The braking distance in an emergency braking situation can increase.</p> <p>If ESP[®] is not operational, ESP[®] is unable to stabilize the vehicle. There is an increased risk of skidding and an accident.</p> <ul style="list-style-type: none"> ► Drive on carefully. ► Visit a qualified specialist workshop. <p>If the ABS control unit is faulty, there is also a possibility that other systems may be unavailable.</p>
 <p>The yellow ESP[®] warning lamp is on when you are driving.</p> <p>In addition, the  door warning lamp and other warning lamps, e.g. , light up.</p>	<p>The central vehicle electronics system is malfunctioning. After the engine is switched off:</p> <ul style="list-style-type: none"> • do not lock/unlock the doors using the remote control function of the key • you can no longer start the engine. <ul style="list-style-type: none"> ► Observe the additional display messages in the display. ► Pull over and stop the vehicle safely as soon as possible, paying attention to road and traffic conditions. Do not continue driving under any circumstances. ► Secure the vehicle against rolling away (▷ page 97). ► Consult a qualified specialist workshop.
 <p>The yellow ESP[®] warning lamp flashes while the vehicle is in motion.</p>	<p>ESP[®] or traction control has intervened because there is a risk of skidding or at least one wheel has started to spin. Cruise control is automatically deactivated.</p> <ul style="list-style-type: none"> ► When pulling away, only depress the accelerator pedal as far as necessary. ► Ease off the accelerator pedal while the vehicle is in motion. ► Adapt your driving style to suit the road and weather conditions.



Problem	Possible causes/consequences and ► Solutions
 <p>The yellow ESP® warning lamp is lit while the engine is running.</p>	<p>ESP® is not available due to a malfunction. Other driving systems could be switched off automatically.</p> <p> WARNING</p> <p>The brake system continues to function normally, but without the functions listed above. The braking distance in an emergency braking situation can thus increase. The brake lamps may not be functioning and thus no longer working when braking. If ESP® is not operational, ESP® is unable to stabilize the vehicle. There is an increased risk of skidding and an accident.</p> <ul style="list-style-type: none"> ► Pull over and stop the vehicle safely as soon as possible, paying attention to road and traffic conditions. Do not continue driving under any circumstances. ► Secure the vehicle against rolling away (▷ page 97). ► Observe the additional display messages in the display. ► Check that the brake lamps are working. <p>If the brake lamps are not working:</p> <ul style="list-style-type: none"> ► Consult a qualified specialist workshop. <p>If the brake lamps are working:</p> <ul style="list-style-type: none"> ► Drive on carefully. ► Visit a qualified specialist workshop.
 <p>The yellow distance warning function warning lamp comes on while the vehicle is moving.</p> <p>In addition the  door warning lamp and other warning lamps, e.g. , light up.</p>	<p>The central vehicle electronics system is malfunctioning. After the engine is switched off:</p> <ul style="list-style-type: none"> • do not lock/unlock the doors using the remote control function of the key • you can no longer start the engine. <ul style="list-style-type: none"> ► Pull over and stop the vehicle safely as soon as possible, paying attention to road and traffic conditions. Do not continue driving under any circumstances. ► Secure the vehicle against rolling away (▷ page 97). ► Consult a qualified specialist workshop.

Problem	Possible causes/consequences and ► Solutions
 <p>The yellow distance warning function warning lamp comes on while the vehicle is moving.</p>	<p>The distance warning function is malfunctioning or temporarily inoperative. Possible causes are:</p> <ul style="list-style-type: none"> • the smart logo in the radiator trim is dirty. • function is impaired due to heavy rain or snow. • the radar sensor system is temporarily inoperative, e.g. due to electromagnetic radiation emitted by nearby TV or radio stations or other sources of electromagnetic radiation. • the system is outside the operating temperature range. • The on-board voltage is too low. <p>If the causes listed above no longer apply, the distance warning function is operational again.</p> <p>If the distance warning lamp continues to light up, the distance warning function electronics are malfunctioning.</p> <p>► Visit a qualified specialist workshop.</p>
 <p>The red distance warning lamp lights up while the vehicle is in motion. A warning tone also sounds.</p>	<p>You are approaching a vehicle or a stationary obstacle in your line of travel at too high a speed.</p> <ul style="list-style-type: none"> ► Be prepared to brake immediately. ► Pay careful attention to the traffic situation. You may have to brake or take evasive action. <p>Further information on the distance warning function (▷ page 50).</p>





Engine



Problem	Possible causes/consequences and ► Solutions
 <p>The yellow Check Engine warning lamp flashes while the engine is running.</p>	<p>The ignition system is malfunctioning. The engine is misfiring, for example, which means the catalytic converter could become damaged.</p> <p>► Visit a qualified specialist workshop immediately.</p> <p>i In some states, you must immediately visit a qualified specialist workshop as soon as the yellow Check Engine warning lamp lights up. This depends on the locally applicable legal requirements. If in doubt, check whether such legal regulations apply in the state in which you are currently driving.</p>
 <p>The yellow Check Engine warning lamp lights up while the engine is running. The engine power output is also reduced.</p>	<p>The engine is running in emergency mode. This may lead to a malfunctioning of the fuel injection system, for example.</p> <ul style="list-style-type: none"> ► Drive on carefully. ► Visit a qualified specialist workshop immediately. <p>i In some states, you must immediately visit a qualified specialist workshop as soon as the yellow Check Engine warning lamp lights up. This depends on the locally applicable legal requirements. If in doubt, check whether such legal regulations apply in the state in which you are currently driving.</p>





Problem	Possible causes/consequences and ► Solutions
 <p>The yellow Check Engine warning lamp lights up while the engine is running.</p>	<p>There may be a malfunction, for example:</p> <ul style="list-style-type: none"> • in the engine management • in the exhaust system • in the fuel system • with the accelerator pedal sensor <p>► Visit a qualified specialist workshop immediately.</p> <p>i In some states, you must immediately visit a qualified specialist workshop as soon as the yellow Check Engine warning lamp lights up. This depends on the locally applicable legal requirements. If in doubt, check whether such legal regulations apply in the state in which you are currently driving.</p>
 <p>The red battery warning lamp is lit while the engine is running. A warning tone also sounds.</p>	<p>The battery is not being charged.</p> <p>Possible causes are:</p> <ul style="list-style-type: none"> • a defective alternator • the battery is faulty • a torn poly-V-belt • a malfunction in the electronics <p>► Pull over and stop the vehicle safely and switch off the engine, paying attention to road and traffic conditions.</p> <p>! Do not continue driving. The engine could otherwise overheat.</p> <p>► Secure the vehicle against rolling away (► page 97).</p> <p>► Consult a qualified specialist workshop.</p>

Problem	Possible causes/consequences and ► Solutions
 <p>The red oil pressure indicator lamp is lit while the engine is running. A warning tone also sounds.</p>	<p>The engine oil pressure is too low. There is a risk of engine damage.</p> <ul style="list-style-type: none"> ► Pull over and stop the vehicle safely as soon as possible, paying attention to road and traffic conditions. Do not continue driving under any circumstances. ► Switch off the engine. ► Secure the vehicle against rolling away (▷ page 97). ► Check the oil level (▷ page 146). ► If necessary, add engine oil (▷ page 146). <p>Information on approved engine oils can also be obtained from any qualified specialist workshop.</p>
 <p>The red coolant temperature warning lamp comes on while the engine is running. A warning tone also sounds.</p>	<p>The coolant temperature has exceeded 230 °F (110 °C). The airflow to the engine radiator may be blocked or the coolant level may be too low.</p> <p> WARNING</p> <p>The engine is not being cooled sufficiently and may be damaged. Do not drive when your engine is overheated. This can cause some fluids which may have leaked into the engine compartment to catch fire.</p> <p>Steam from an overheated engine can cause serious burns, which can occur just by opening the engine compartment cover. There is a risk of injury.</p> <ul style="list-style-type: none"> ► Pull over and stop the vehicle safely as soon as possible, paying attention to road and traffic conditions. Do not continue driving under any circumstances. ► Switch off the engine. ► Secure the vehicle against rolling away (▷ page 97). ► Leave the vehicle and keep a safe distance from the vehicle until the engine has cooled down. ► Check the coolant level and top up the coolant. Observe the notes as you do so (▷ page 203). ► If you need to add coolant more often than usual, have the engine coolant system checked. ► Make sure that the air supply to the engine radiator is not blocked, e.g. by snow, slush or ice. ► Do not start the engine again until the coolant temperature is below 230 °F (110 °C). Otherwise, the engine could be damaged. <p>Avoid subjecting the engine to heavy loads, e.g. driving in mountainous terrain, and stop-and-go traffic.</p>

Tires

Problem	Possible causes/consequences and ► Solutions
<p> You are driving and the yellow tire pressure monitor warning lamp (pressure loss/malfunction) is lit. In addition the  door warning lamp and other warning lamps, e.g. , light up.</p>	<p>The central vehicle electronics system is malfunctioning. After the engine is switched off:</p> <ul style="list-style-type: none"> • do not lock/unlock the doors using the remote control function of the key • you can no longer start the engine. <p>► Observe the additional display messages in the display. ► Pull over and stop the vehicle safely as soon as possible, paying attention to road and traffic conditions. Do not continue driving under any circumstances. ► Secure the vehicle against rolling away (▷ page 97). ► Consult a qualified specialist workshop.</p>
<p> You are driving and the yellow tire pressure monitor warning lamp (pressure loss/malfunction) is lit. A warning tone also sounds.</p>	<p>The tire pressure in one or more tires has dropped suddenly.</p> <p> WARNING</p> <p>If you drive with a flat tire, there is a risk of the following hazards:</p> <ul style="list-style-type: none"> • A flat tire affects the ability to steer or brake the vehicle. • you could lose control of the vehicle. • Continued driving with a flat tire will cause excessive heat build-up and possibly a fire. <p>There is a risk of an accident.</p> <p>► Stop the vehicle without making any sudden steering or braking maneuvers. Pay attention to the traffic conditions as you do so. ► Secure the vehicle against rolling away (▷ page 97). ► Check the tires and, if necessary, follow the instructions for a flat tire (▷ page 156).</p>

Problem	Possible causes/consequences and ► Solutions
<p> The yellow tire pressure monitor warning lamp (pressure loss/malfunction) flashes for approximately 1 minute and then remains lit.</p>	<p>There is no signal from the tire pressure sensor of one or several wheels, or the wheels fitted do not have suitable tire pressure sensors. The tire pressure monitor was not restarted after a wheel change.</p> <p> WARNING</p> <p>The system is possibly unable to recognize or register low tire pressure. There is a risk of an accident.</p> <ul style="list-style-type: none"> ► Observe the additional display messages in the display. ► Have the faulty tire pressure sensor replaced at a qualified specialist workshop. <p>or</p> <ul style="list-style-type: none"> ► Mount wheels with suitable tire pressure sensors. <p>or</p> <ul style="list-style-type: none"> ► Restart the tire pressure monitor after a wheel change (▷ page 179) The tire pressure monitor is activated automatically after driving for a few minutes. <p>If the yellow tire pressure monitor warning lamp continues to remain on:</p> <ul style="list-style-type: none"> ► Drive on carefully. ► Visit a qualified specialist workshop.
<p> You are driving and the yellow tire pressure monitor warning lamp (pressure loss/malfunction) is lit.</p>	<p>The tire pressure is too low in at least one of the tires, or the tire pressure difference between the wheels is too great.</p> <ul style="list-style-type: none"> ► Check the tire pressures at the next opportunity (▷ page 177). ► If necessary, correct the tire pressure. ► Restart the tire pressure monitor (▷ page 179).

Vehicle	
Problem	Possible causes/consequences and ► Solutions
 <p>The red door warning lamp comes on while the vehicle is moving. In addition, further warning lamps light up, such as .</p>	<p>The central vehicle electronics system is malfunctioning. After the engine is switched off:</p> <ul style="list-style-type: none"> • do not lock/unlock the doors using the remote control function of the key • you can no longer start the engine. <p>► Observe the additional display messages in the display.</p> <p>► Pull over and stop the vehicle safely as soon as possible, paying attention to road and traffic conditions. Do not continue driving under any circumstances.</p> <p>► Secure the vehicle against rolling away (▷ page 97).</p> <p>► Consult a qualified specialist workshop.</p>
 <p>The red door warning lamp is on.</p>	<p>A door or the tailgate is open. If you are driving at speeds above 13 mph (20 km/h), an additional warning tone will sound.</p> <p>► Observe the additional display messages in the display.</p> <p>► Pull over at a suitable place and stop the vehicle safely, paying attention to road and traffic conditions.</p> <p>► Secure the vehicle against rolling away (▷ page 97).</p> <p>► Close all doors and the tailgate.</p>
 <p>The yellow power steering warning lamp is lit while the engine is running.</p>	<p>The power steering is malfunctioning.</p> <p> WARNING</p> <p>You may need to use more force to steer. There is a risk of an accident.</p> <p>► Observe the additional display messages in the display.</p> <p>► Check whether you are able to apply the extra force required.</p> <p>► If you are able to steer safely: carefully drive on to a qualified specialist workshop.</p> <p>► If you are unable to steer safely: do not continue driving. Contact the nearest qualified specialist workshop.</p>

Stowage areas

Loading guidelines

WARNING

If objects, luggage or loads are not secured or not secured sufficiently, they could slip, tip over or be flung around and thereby hit vehicle occupants. There is a risk of injury, particularly in the event of sudden braking or a sudden change in direction.

Always store objects so that they cannot be flung around. Secure objects, luggage or loads against slipping or tipping before the journey.

WARNING

Combustion engines emit poisonous exhaust gases such as carbon monoxide. If the tailgate is open when the engine is running, particularly if the vehicle is moving, exhaust fumes could enter the passenger compartment. There is a risk of poisoning.

Turn off the engine before opening the tailgate. Never drive with the tailgate open.

Your vehicle has not been approved by the manufacturer for towing a trailer. A trailer could seriously impair driving safety.

Mounting a basic rack, a cycle rack or a ski/snowboard rack on the rear of the vehicle will change the axle load distribution as specified by the vehicle manufacturer. Read the operating instructions for the individual accessories.

The handling characteristics of a laden vehicle are dependent on the distribution of the load within the vehicle. For this reason, you should observe the following notes when transporting a load:

- never exceed the maximum permissible gross vehicle weight or the permissible axle loads for the vehicle (including occupants). The values are specified on the

vehicle identification plate on the B-pillar of the driver's door

- the load must not protrude above the upper edge of the head restraints
- ensure that no items of luggage can enter the vehicle interior above or between the front seats
- ensure that loaded objects are stowed safely and are secured
- load heavy objects at the bottom and light objects at the top

Stowage space

Important safety notes

WARNING

If you stow objects in the vehicle interior in an unsuitable way, they could slip or be thrown around and thus hit vehicle occupants. Additionally, the cup holders, open stowage spaces and mobile phone brackets cannot restrain the objects placed in them in the event of an accident. There is a risk of injury, especially in the event of braking or sudden changes in direction.

- Always stow objects so they cannot be thrown around in these or similar situations.
- Always ensure that objects do not protrude from the stowage compartments or stowage nets.
- All closable stowage compartments should be closed before beginning your journey.
- Always stow and secure heavy, hard, pointed, sharp-edged, fragile objects or objects which are too large behind the last bench seat or under the passenger seats.

Observe the loading guidelines (▷ page 138).

Glove box



P68.00-7950-31

- ▶ **To open:** pull handle ①.

The glove box can be locked with the SmartKey.

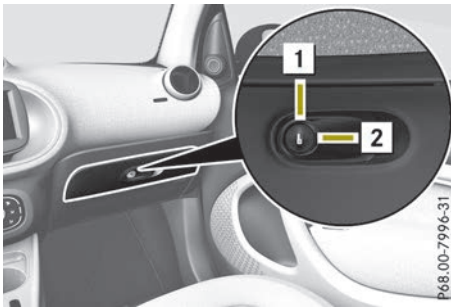

P68.00-7996-31

- ▶ **To lock:** insert the SmartKey into the lock and turn it 90° clockwise to position ②.
- ▶ **To unlock:** insert the SmartKey into the lock and turn it 90° counter-clockwise to position ①.

Storage compartment in the doors

The storage compartments are located in the driver's door and front-passenger door.



P68.00-7259-31

① Storage compartment

Bottles can be stowed in the doors.

Drawer in the center console

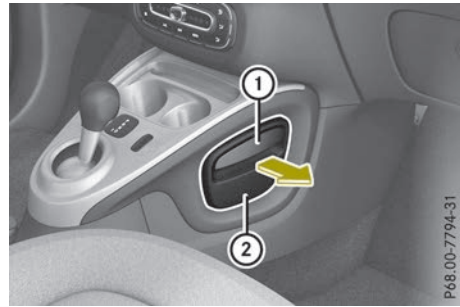

P68.00-7794-31

- ▶ Pull drawer ② by handle ① in the direction of the arrow.

Additional storage areas

- Bracket on the front-passenger seat for a tablet, such as an iPad Air®
- Storage net in front-passenger footwell

Storage compartment in the tailgate

The storage compartment in the tailgate offers additional storage space for small objects. You can keep the fluorescent jacket, first-aid kit and warning triangle here, for example.

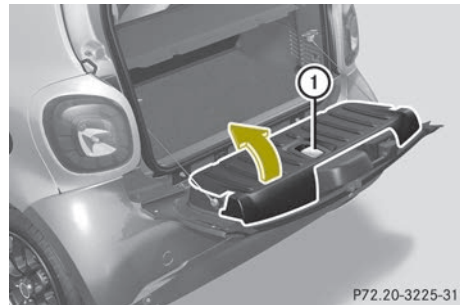

P72.20-3225-31

- ▶ **To open:** open the tailgate.
- ▶ Pull back handle ① on the inside of the tailgate.
- ▶ Fold the lid of the storage compartment forwards in the direction of the arrow.

- ▶ **To close:** fold the lid of the stowage compartment back in the opposite direction to the arrow.
- ▶ Press the cover firmly closed in the middle until it engages audibly.

Cargo compartment cover

Important safety notes

WARNING

The trunk cover alone cannot retain or secure any heavy objects, items of luggage or heavy loads. You may be struck by unsecured loads in the event of sudden changes in direction, braking or an accident. There is a risk of injury or even fatal injury.

Always stow objects in such a way that they cannot be thrown around. Secure objects, luggage or loads by, for example, lashing them down to prevent them from slipping or tipping over, even if you use the trunk cover.

Observe the loading guidelines (▷ page 138).
The trunk cover:

- conceals objects in the vehicle's trunk
- prevents smaller objects from slipping from the trunk into the vehicle interior, but will not restrain loads in the event of an accident

The luggage net bag:

- serves to hold small, light objects
- prevents smaller objects from slipping within the vehicle interior

Fitting

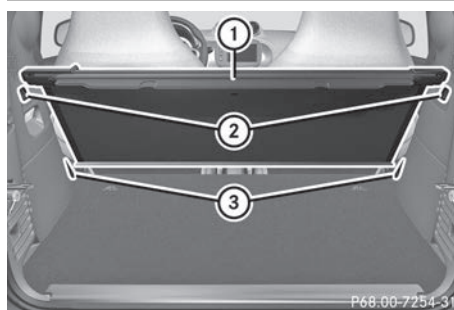

If you use the trunk cover under normal circumstances, install it in brackets (2). If you do not need to use the trunk cover, install it in brackets (3).

- ▶ For easier fitting, fold the front-passenger seat backrests forwards (▷ page 64).
- ▶ Open the upper and lower tailgate (▷ page 58).
- ▶ Hold trunk cover (1) in the trunk with the luggage net bag at the front.
- ▶ Insert the trunk cover into upper bracket (2) or into lower bracket (3) on the right-hand side.

i Lower bracket (3) can only be used if there is no subwoofer fitted.

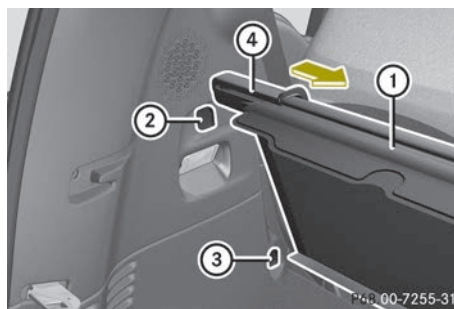

- ▶ Slide handle (4) to the right in the direction of the arrow.
- ▶ Insert the trunk cover into bracket (2) or (3) on the left side paneling and release the handle. Trunk cover (1) snaps into place.

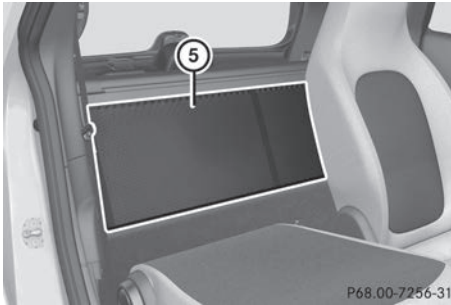

P68.00-7256-31

- ▶ Pull luggage net bag (5) down slightly and secure with the Velcro fasteners.

To remove, follow the sequence in reverse.

Installing and removing the trunk cover

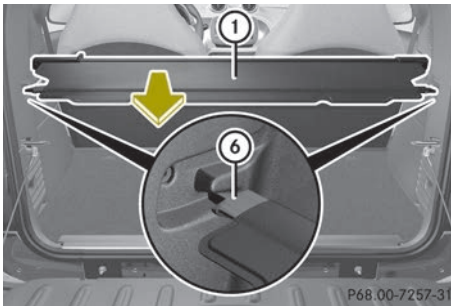

P68.00-7257-31

- ▶ **To install:** grip trunk cover (1) in the middle and pull it back.
- ▶ Hook trunk cover (1) into left and right rear brackets (6) and release.
- ▶ **To remove:** grip trunk cover (1) in the middle, pull it back and unhook it from rear brackets (6).
- ▶ Slide trunk cover (1) back.

Fitting/removing the subwoofer

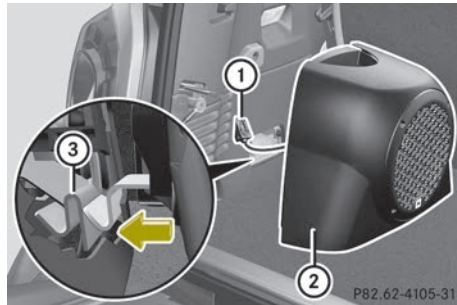

P82.62-4105-31

- ▶ **To fit:** insert connector (1).
- ▶ Place subwoofer (2) on the side trim.
- ▶ Slide subwoofer (2) to bracket (3).

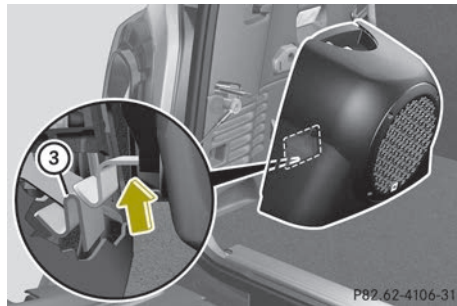

P82.62-4106-31

- ▶ Slide the subwoofer up in the direction of the arrow on bracket (3).

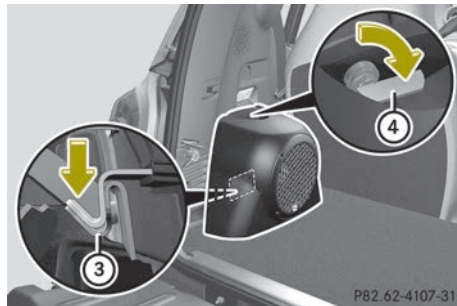

P82.62-4107-31

- ▶ Then slide the subwoofer over bracket (3) in the direction of the arrow until the subwoofer slides down.
- ▶ Close quick-release fastener (4).
- ▶ **To remove:** release quick-release fastener (4).
- ▶ Slide the subwoofer up over bracket (3) and remove.

- ▶ Disconnect plug ①.
- ▶ Take out subwoofer ①.

Features

Cup holders

Important safety notes

WARNING

The cup holder cannot hold a container secure whilst traveling. If you use a cup holder whilst traveling, the container may be flung around and liquid may be spilled. The vehicle occupants may come into contact with the liquid and if it is hot, they may be scalded. You may be distracted from the traffic conditions and you could lose control of the vehicle. There is a risk of an accident and injury.

Only use the cup holder when the vehicle is stationary. Only use the cup holder for containers of the right size. Always close the container, particularly if the liquid is hot.

WARNING

If you transport objects in the vehicle interior and these are not adequately secured, they could slip or be flung around and thereby strike vehicle occupants. In addition, cup holders, open stowage spaces and mobile phone brackets may not always be able to hold the objects placed in them in the event of an accident. There is a risk of injury, particularly in the event of sharp braking or sudden changes of direction.

- Always stow objects in such a way that they cannot be tossed about in these or similar situations.
- Always make sure that objects do not protrude out of the stowage spaces, luggage nets or stowage nets.

- Ensure that closable stowage spaces are shut before beginning your journey.
- Always stow and secure heavy, hard, pointed, sharp-edged, fragile or large objects in the cargo compartment.

 Only use the cup holders for containers of the right size and which have lids. The drinks could otherwise spill.

Observe the loading guidelines (▷ page 138).

Cup holder in the front-compartment center console



① Cup holder

Cup holder in the center console

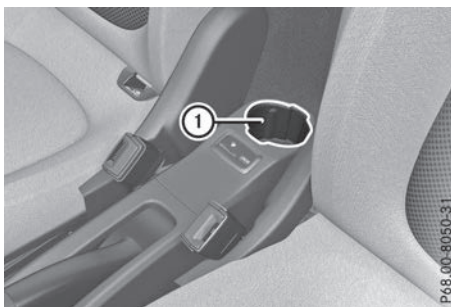

① Cup holder

The cup holder has a recess for storing selected mobile phones.

Sun visors

Overview

WARNING

If the mirror cover of the vanity mirror is folded up when the vehicle is in motion, you could be blinded by incident light. There is a risk of an accident.

Always keep the mirror cover folded down while driving.

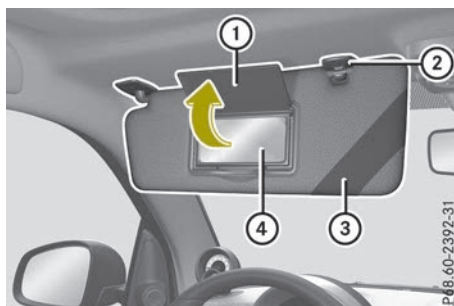

- ① Mirror cover
- ② Bracket
- ③ Retaining strap
- ④ Vanity mirror

Glare from the side

- ▶ Fold down the sun visor.
- ▶ Pull the sun visor out of bracket ②.
- ▶ Swing the sun visor to the side.

Ashtray

! The cup holder in the center console is not heat resistant. Before placing lit cigarettes in the ashtray, make sure that the ashtray is fully inserted in the cup holder. Make sure that lit cigarettes do not fall into the cup holder.

Otherwise, the cup holder could be damaged.

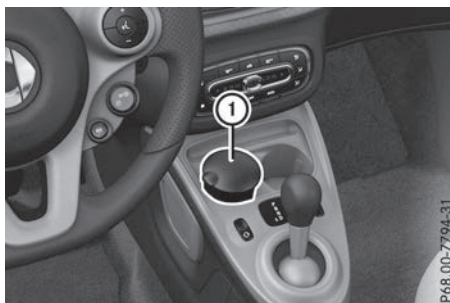

- ▶ **To open:** lift up cover ①.
- ▶ **To close:** push down cover ①.
- ▶ **To remove:** pull the ashtray up and out.
- ▶ **To insert:** insert the ashtray into the cup holder.

i If you remove the ashtray, you can use the resulting compartment for stowage.

12 V sockets

General notes

- ▶ Turn the SmartKey to position **1** in the ignition lock (▷ page 86).

The sockets can be used for accessories with a maximum draw of 120 W (10 A). Example accessories include mobile phone chargers.

If you use the sockets for long periods when the engine is switched off, the battery may discharge.

Socket in the front-compartment center console

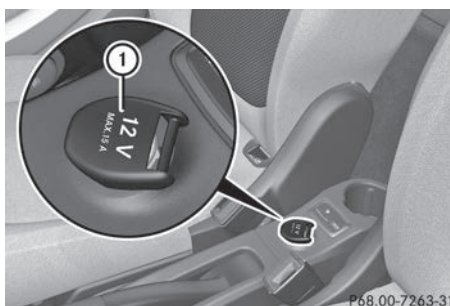

- ▶ Lift up the cover of socket ①.

Floormat on the driver's side

WARNING

Objects in the driver's footwell can restrict the pedal travel or obstruct a depressed pedal. The operating and road safety of the vehicle is jeopardized. There is a risk of an accident.

Make sure that all objects in the vehicle are stowed correctly, and that they cannot enter the driver's footwell. Install the floormats securely and as specified in order to ensure sufficient clearance for the pedals. Do not use loose floormats and do not place floormats on top of one another.

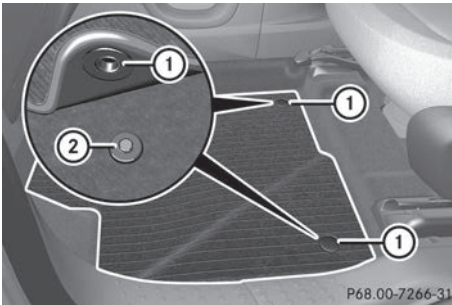

- ▶ Slide the driver's seat backwards.
- ▶ **To install:** place the floor mat in the footwell.
- ▶ Press safety catch knobs ① onto retainers ②.
- ▶ **To remove:** pull the floor mat off retainers ②.
- ▶ Remove the floor mat.

Checking service products

Engine compartment (rear)

Engine compartment cover

⚠ WARNING

The engine compartment cover may become very hot. If you remove the cover to do work on the engine compartment, there is a risk of injury!

Allow the engine to cool down and then remove the engine compartment cover after cooling has taken place.

⚠ WARNING

Combustion engines emit poisonous exhaust gases such as carbon monoxide. If the engine compartment cover has not been installed correctly, when the engine is running, particularly if the vehicle is moving, exhaust fumes could enter the passenger compartment. There is a risk of poisoning.

Always switch off the engine before removing the engine compartment cover. Make sure that the engine compartment cover has been installed correctly.

- ▶ **To open:** apply the parking brake.
- ▶ Select a gear.
- ▶ Switch the ignition off.
- ▶ Remove the SmartKey from the ignition lock.
- ▶ Open the upper and lower tailgate (▷ page 58).
- ▶ For vehicles with the subwoofer: remove the subwoofer (▷ page 145).

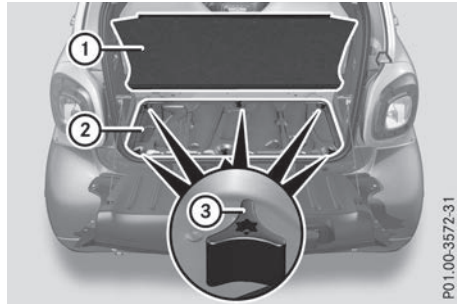

PO1.00-3572-31

- ▶ Remove luggage compartment cover ① if necessary (▷ page 140).
- ▶ Hold the carpet on the right and left sides and fold upwards.
- ▶ Vehicles with a trunk cover: attach the hook to upper bracket of trunk cover ① (▷ page 140).
- ▶ Unscrew screws ③ from engine compartment cover ② manually.
- ▶ Remove engine compartment cover ②.
- ▶ **To close:** slide engine compartment cover ② forward as far as it will go.
- ▶ Retighten screws ③ manually.
- ▶ Vehicles with a trunk cover: unhook the hooks.
- ▶ Put the carpet back into the vehicle.
- ▶ Fold down the carpet and push it under the side paneling.
- ▶ For vehicles with the subwoofer: fit the subwoofer again (▷ page 145).
- ▶ Close the tailgate.

Engine oil

General notes

Depending on your driving style, the vehicle consumes up to 0.55 US qt (0.5 liters) of oil per 600 miles (1000 km). The oil consumption may be higher than this when the vehicle is new or if you frequently drive at high engine speeds. When checking the oil level:

- park the vehicle on a level surface.
- the engine should be switched off for approximately 5 minutes if the engine is at normal operating temperature
- if the engine is not at normal operating temperature, e.g. if the engine was only started briefly, wait approximately

30 minutes before carrying out the measurement

Checking the oil level using the oil dipstick

WARNING

Certain components in the engine compartment, such as the engine, radiator and parts of the exhaust system, can become very hot. Working in the engine compartment poses a risk of injury.

Where possible, let the engine cool down and touch only the components described in the following.

WARNING

Opening the hood when the engine is overheated or when there is a fire in the engine compartment could expose you to hot gases or other service products. There is a risk of injury.

Let an overheated engine cool down before opening the hood. If there is a fire in the engine compartment, keep the hood closed and contact the fire department.

WARNING

The engine compartment contains moving components. Certain components, such as the radiator fan, may continue to run or start again suddenly when the ignition is off. There is a risk of injury.

If you need to do any work inside the engine compartment:

- switch off the ignition
- never reach into the area where there is a risk of danger from moving components, such as the fan rotation area
- remove jewelry and watches
- keep items of clothing and hair, for example, away from moving parts

- ▶ Open the engine compartment cover (▷ page 145).

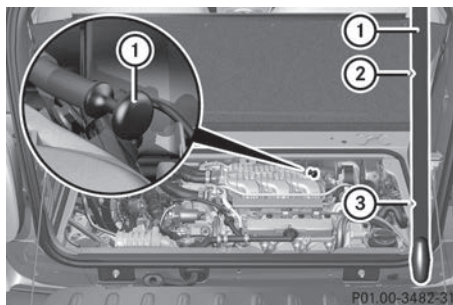

Example

- ▶ Pull oil dipstick ① out of the dipstick guide tube.
- ▶ Wipe off oil dipstick ①.
- ▶ Slowly slide oil dipstick ① into the guide tube to the stop, and take it out again. If the level is between MIN mark ③ and MAX mark ②, the oil level is correct.

Adding engine oil

WARNING

Certain components in the engine compartment, such as the engine, radiator and parts of the exhaust system, can become very hot. Working in the engine compartment poses a risk of injury.

Where possible, let the engine cool down and touch only the components described in the following.

WARNING

If engine oil comes into contact with hot components in the engine compartment, it may ignite. There is a risk of fire and injury.

Make sure that engine oil is not spilled next to the filler neck. Let the engine cool down and thoroughly clean the engine oil off the components before starting the engine.

Environmental note

When adding oil, take care not to spill any. If oil enters the soil or waterways, it is harmful to the environment.

! Do not add too much oil. adding too much engine oil can result in damage to the engine or to the catalytic converter. Have excess engine oil siphoned off.

You will find further information on engine oils you can use in the "Technical data" section (> page 202).

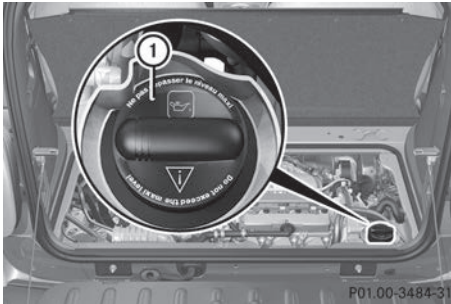

- ▶ Turn cap ① counter-clockwise and remove it.
- ▶ Add engine oil.
If the oil level is at or below the MIN mark on the oil dipstick, top up once with a maximum of 1.1 US qt (1 l) of engine oil.
- ▶ Replace cap ① on the filler neck and turn clockwise.
Ensure that the cap locks into place securely.
- ▶ Check the oil level again with the oil dipstick (> page 146).

Front compartment

Service cover

Important safety notes

⚠ WARNING

If the service cover is not locked, it may come loose during driving and block your view or endanger other road users. There is a risk of an accident and injury.

Therefore, make sure that the service cover is locked before every journey.

⚠ WARNING

If the windshield wipers begin to operate while the service cover is open, there is a

danger of injury from the wiper arms. There is a risk of injury.

Always switch off the windshield wipers and the ignition before opening the service cover.

! To ensure unhindered air intake, carefully remove any snow or dirt from the ventilation slots above the service cover.

To prevent it from becoming damaged or dirty, the service cover can be removed and hung on the front of the vehicle.

The service cover is attached to the rear side of the vehicle body with a strap.

- ▶ Park the vehicle on a flat, level surface.
- ▶ Apply the parking brake.
- ▶ Select a gear.
- ▶ Switch the ignition off.

Removing

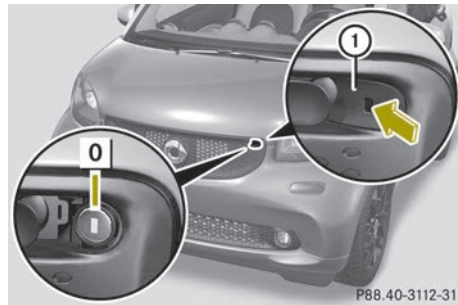

- ▶ **To unlock:** remove lock cover ① (driver's side only) with the key.
- ▶ Insert the key into the lock and turn it to position 0.

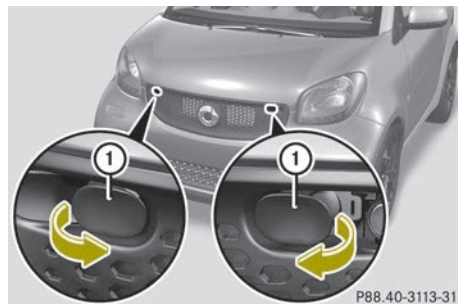

- ▶ Pull both levers ① with both index fingers in the direction of the arrows.

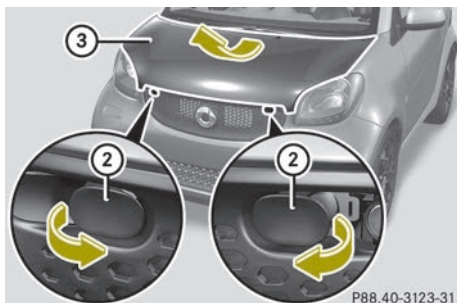

- ▶ First pull both levers (2) forwards and then completely out.
- ▶ Lift service cover (3) and pull forwards.

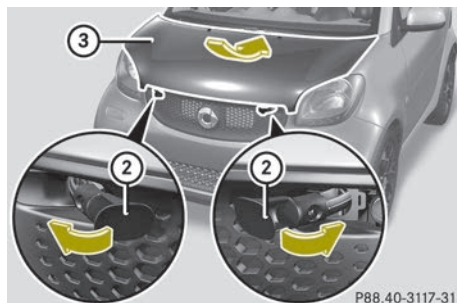

- ▶ Press service cover (3) down in the direction of the arrow.
- ▶ Slide both levers (2) in and then back.
- ▶ Press lever (2) in the radiator trim and allow it to engage.

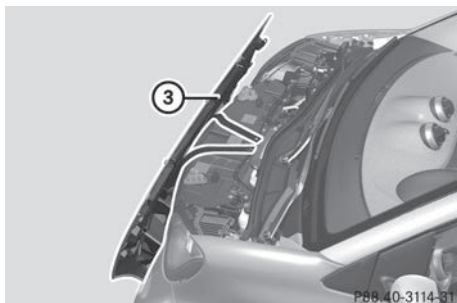

- ▶ Hook service cover (3) at the top rear in the openings on the vehicle.

Inserting

- ▶ Lift service cover (3).

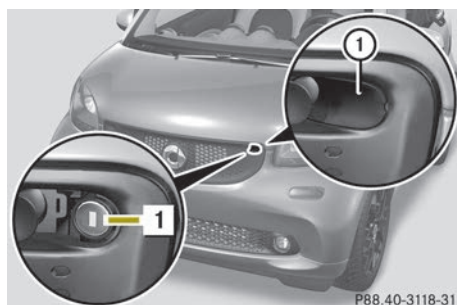

- ▶ **To lock:** insert the key into the lock and turn it to position [1]. Insert lock cover (1) flush (on the driver's side) and clip it into place.

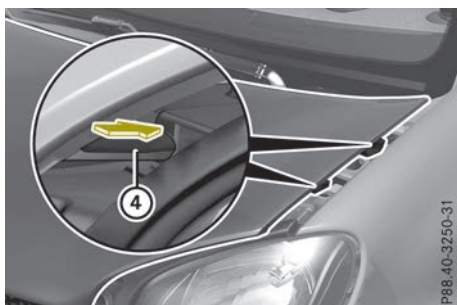

- ▶ Slide bars (4) on the left and right of the service cover under the bars on fender.

Coolant

Important safety notes

WARNING

The cooling system is pressurized, particularly when the motor is warm. If you open the cap, you could be scalded if hot coolant sprays out. There is a risk of injury.

Let the engine cool down before you open the cap. Wear gloves and eye protection. Slowly open the cap to relieve pressure.

Checking the coolant

The coolant expansion tank is in the area under the service cover.

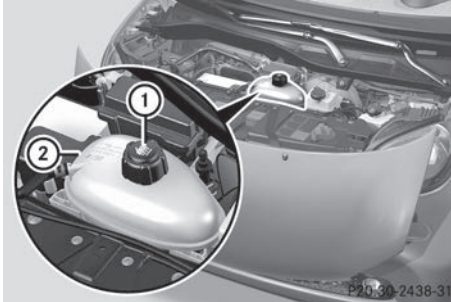

- ▶ Open the service cover (▷ page 147).
- ▶ Let the coolant cool down for at least 30 minutes.
- ▶ Park the vehicle on a level surface.
Only check the coolant level when the vehicle is on a level surface and the engine has cooled down.
- ▶ Check the reservoir visually.
The fluid level must be between MIN and MAX.

Adding coolant

- ▶ Cover cap ① of coolant expansion tank ② with a cloth.
- ▶ Slowly turn cover cap ① anti-clockwise to allow excess pressure to escape.
- ▶ Turn cap ① further anti-clockwise and remove it.
- ▶ Do not exceed the maximum filling level when adding coolant.
- ▶ Screw on cap ① tightly.

For further information on coolant, see (▷ page 203).

Windshield washer system

WARNING

Windshield washer concentrate is highly flammable. If it comes into contact with hot components in the front compartment, it may ignite. There is a risk of fire and injury.

Make sure that no windshield washer concentrate is spilled next to the filler neck.

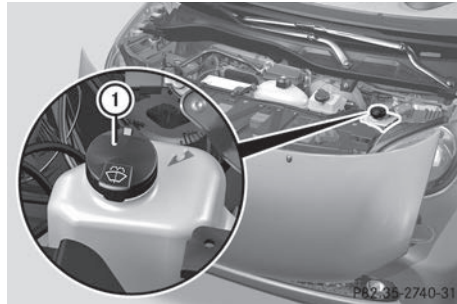

- ▶ Open the service cover (▷ page 147).
- ▶ **To open:** pull cap ① upwards by the tab.
- ▶ If available, pull the removable nozzle up as far as the stop.
- ▶ Add the premixed washer fluid.
- ▶ **To close:** if available, push the removable nozzle down and push it inside.
- ▶ Press cap ① onto the filler neck until it engages.

Further information on windshield washer fluid/antifreeze (▷ page 203).

Maintenance

Service display

Service message



The service display informs you of the next service due date. Depending on the operating conditions of the vehicle, the remaining time or distance until the next service due date is displayed.



Information on the type of service and service intervals (see the separate Maintenance Booklet).

For further information inquire at any smart center or look under <http://www.smartUSA.com> (only USA).

- ❗ The service display does not show any information on the engine oil level.
Observe the notes on the engine oil level (▷ page 146).

Whenever a service is due, this is shown approximately 30 days or 1500 km (1000 miles) beforehand. After starting the engine, a service message appears in the instrument cluster display for a few seconds; see the following example.

Next Service in .. Days together with the  or  symbol. If the service due date has been exceeded, **Service Due .. Days Ago**.

The symbol shows the type of service.  stands for a minor service and  for a major service.

The service display does not take into account any periods of time during which the battery is disconnected.

Maintaining the time-dependent service schedule:

- ▶ Note down the service due date in the service display before disconnecting the battery.



or

- ▶ After reconnecting the battery, subtract the battery disconnection periods from the service date shown on the display.

Hiding a service message

- ▶ Press the  button on the multifunction steering wheel.

Calling up the service display

- ▶ Switch on the ignition.
- ▶ Press the  or  button on the steering wheel to select the **Messages and Service** menu.
The service display shows when the service is due.

Information about Service

Resetting the service display

! Have service work carried out as described in the Maintenance Booklet. This may otherwise lead to increased wear and damage to the major assemblies or the vehicle.

A qualified specialist workshop, e.g. a smart center, will reset the service interval display after the service work has been carried out. You can also obtain further information on maintenance work, for example.

Special service requirements

The prescribed service interval is based on normal operation of the vehicle. Service work will need to be performed more often if the vehicle is operated under arduous conditions or increased loads, for example:

- regular city driving with frequent intermediate stops
- if the vehicle is primarily used to travel short distances
- for frequent operation in mountainous terrain or on poor road surfaces
- if the engine is often left idling for long periods

In these or similar operating conditions, have, for example, the air filter, engine oil and oil filter changed more frequently. The tires must be checked more frequently if the vehicle is operated under increased loads. You can obtain further information at a qualified specialist workshop, e.g. a smart center.

Driving abroad

An extensive smart service network is also available in other countries. For further information inquire at any smart center.

Care

General notes

Environmental note

Dispose of empty packaging and cleaning cloths in an environmentally responsible manner.

! For cleaning your vehicle, do not use any of the following:

- dry, rough or hard cloths
- abrasive cleaning agents
- solvents
- cleaning agents containing solvents

Do not scrub.

Do not touch the surfaces or protective films with hard objects, e.g. a ring or ice scraper. You could otherwise scratch or damage the surfaces and protective film.

! Do not park the vehicle for an extended period straight after cleaning it, particularly after having cleaned the wheels with wheel cleaner. Wheel cleaners could cause increased corrosion of the brake discs and brake pads/linings. For this reason, you should drive for a few minutes after cleaning. Braking heats the brake discs and the brake pads/linings, thus drying them. The vehicle can then be parked.

Regular care of your vehicle is a condition for retaining the quality in the long term. Use care products and cleaning agents recommended and approved by smart.

Exterior care

Automatic car wash

WARNING

Braking efficiency is reduced after washing the vehicle. There is a risk of an accident.

After the vehicle has been washed, brake carefully while paying attention to the traffic conditions until full braking power is restored.

! Never clean your vehicle in a Touchless Automatic Car Wash as these use special cleaning agents. These cleaning agents can damage the paintwork or plastic parts.

! Make sure that:

- the side windows are fully closed
- the climate control blower is switched off
- the windshield wiper switch is at position **0**

The vehicle may otherwise be damaged.

You can wash the vehicle in an automatic car wash from the very start.

If the vehicle is very dirty, pre-wash it before cleaning it in an automatic car wash.

After using an automatic car wash, wipe off wax from the windshield and the wiper blades. This will prevent smears and reduce wiping noises caused by residue on the windshield.

Washing by hand

In some countries, washing by hand is only allowed at specially equipped washing bays. Observe the legal requirements in each country.

- ▶ Do not use hot water and do not wash the vehicle in direct sunlight.
- ▶ Use a soft sponge to clean.
- ▶ Use a mild cleaning agent, such as a car shampoo approved by smart.
- ▶ Thoroughly hose down the vehicle with a gentle jet of water.
- ▶ Do not point the water jet directly towards the air inlet.
- ▶ Use plenty of water and rinse out the sponge frequently.
- ▶ Rinse the vehicle with clean water and dry thoroughly with a chamois.
- ▶ Do not let the cleaning agent dry on the paintwork.

Carefully remove all deposits of road salt as soon as possible when driving in winter.

Power washers

WARNING

The water jet from a circular jet nozzle (dirt blasters) can cause invisible exterior damage to the tires or chassis components. Components damaged in this way may fail unexpectedly. There is a risk of an accident.

Do not use power washers with circular jet nozzles to clean the vehicle. Have damaged tires or chassis components replaced immediately.

! Always maintain a distance of at least 11.8 in (30 cm) between the vehicle and the power washer nozzle. Information about the correct distance is available from the equipment manufacturer.

Move the power washer nozzle around when cleaning your vehicle.

Do not aim directly at any of the following:

- tires
- door gaps, roof gaps, joints, etc.
- electrical components

- battery
- connectors
- lights
- seals
- trim
- ventilation slots

Damaged seals or electrical components can lead to leaks or failures.

Cleaning the paintwork

! Do not affix:

- stickers
- films
- magnetic plates or similar items

to painted surfaces. You could otherwise damage the paintwork.

- ▶ Remove dirt immediately, where possible, while avoiding rubbing too hard.
- ▶ Soak insect remains with insect remover and rinse off the treated areas afterwards.
- ▶ Soak bird droppings with water and rinse off the treated areas afterwards.
- ▶ Remove coolant, brake fluid, tree resin, oils, fuels and greases by rubbing gently with a cloth soaked in petroleum ether or lighter fluid.
- ▶ Use tar remover to remove tar stains.
- ▶ Use silicone remover to remove wax.
- ▶ Use a suitable touch-up stick, e.g. MB Touch-Up Stick, to repair slight damage to the paintwork quickly and provisionally.

The following cannot always be completely repaired:

- scratches
- corrosive deposits
- areas affected by corrosion
- damage caused by inadequate care

In such cases, visit a qualified specialist workshop.

When water no longer forms beads on the paint surface, use the care product Paint Care, which has been approved by smart. This is the case approximately every three to five months, depending on the climate conditions and the care product used.

If the dirt has penetrated the paint surface or if the paintwork has become dull, then the paintwork should be cleaned. Use the care

product Paint Care, which has been approved by smart to clean the paintwork.

Do not use these care products in the sun or on the hood while the hood is hot.

Matte finish care

! Never polish the vehicle or the light alloy wheels. Polishing causes the finish to shine.

! The following may cause the paint to become shiny and thus reduce the matte effect:

- strong rubbing of the paintwork with unsuitable materials
- frequent use of automatic car washes
- washing the vehicle in direct sunlight

! Never use paint cleaner, buffing or polishing products, or gloss preserver, e.g. wax. These products are only suitable for high-gloss surfaces. Their use on vehicles with matte finish leads to considerable surface damage (shiny, mottled areas).

Always have paintwork repairs carried out at a qualified specialist workshop.

! Do not use wash programs with a hot wax treatment under any circumstances.

Observe these notes if your vehicle has a clear matte finish. This will help you to avoid damage to the paintwork due to incorrect treatment.

These notes also apply to light alloy wheels with a clear matte finish.

i The vehicle should preferably be washed by hand using a soft sponge, car shampoo and plenty of water.

i Use only insect remover and car shampoo from the range of approved smart care products.

Cleaning the panoramic roof

! Only use cleaning agents or cleaning cloths which are suitable for plastic light lenses. Unsuitable cleaning agents or cleaning cloths could scratch or damage the plastic windows of the panoramic roof. Do not use cleaning agents which contain solvents.

- ▶ Clean the plastic panes of the panoramic roof using a wet sponge and a mild cleaning agent, e.g. smart car shampoo, a commercially available glass cleaner or cleaning cloths.

Cleaning the wheels

WARNING

The water jet from a circular jet nozzle (dirt blasters) can cause invisible exterior damage to the tires or chassis components. Components damaged in this way may fail unexpectedly. There is a risk of an accident.

Do not use power washers with circular jet nozzles to clean the vehicle. Have damaged tires or chassis components replaced immediately.

- ❗ Do not use acidic wheel cleaning products to remove brake dust. This could damage wheel bolts and brake components.
- ❗ Do not park the vehicle for an extended period straight after cleaning it, particularly after having cleaned the wheels with wheel cleaner. Wheel cleaners could cause increased corrosion of the brake discs and brake pads/linings. For this reason, you should drive for a few minutes after cleaning. Braking heats the brake discs and the brake pads/linings, thus drying them. The vehicle can then be parked.

Cleaning the windows

WARNING

You could become trapped by the windshield wipers if they start moving while cleaning the windshield or wiper blades. There is a risk of injury.

Always switch off the windshield wipers and the ignition before cleaning the windshield or wiper blades.

- ❗ Do not use dry cloths, abrasive products, solvents or cleaning agents containing solvents to clean the inside of the windows. Do not touch the insides of the windows with hard objects, e.g. an ice scraper or ring.

There is otherwise a risk of damaging the windows.

- ❗ Clean the water drainage channels of the windshield and the rear window at regular intervals. Deposits such as leaves, petals and pollen may under certain circumstances prevent water from draining away. This can lead to corrosion damage and damage to electronic components.

- ▶ Clean the inside and outside of the windows with a damp cloth and a cleaning agent that is recommended and approved by smart.

Cleaning wiper blades

WARNING

You could become trapped by the windshield wipers if they start moving while cleaning the windshield or wiper blades. There is a risk of injury.

Always switch off the windshield wipers and the ignition before cleaning the windshield or wiper blades.

- ❗ Do not pull the wiper blade. Otherwise, the wiper blade could be damaged.
- ❗ Do not clean wiper blades too often and do not rub them too hard. Otherwise, the graphite coating could be damaged. This could cause wiper noise.
- ▶ Fold the windshield wiper arms away from the windshield.
- ▶ Carefully clean the wiper blades with a damp cloth.
- ▶ Fold the windshield wiper arms back again before switching on the ignition.
- ❗ Hold the wiper arm securely when folding back. The windshield could be damaged if the wiper arm smacks against it suddenly.

Cleaning the exterior lighting

- ❗ Only use cleaning agents or cleaning cloths which are suitable for plastic light lenses. Unsuitable cleaning agents or cleaning cloths could scratch or damage the plastic light lenses.
- ▶ Clean the plastic lenses of the exterior lighting using a wet sponge and a mild

cleaning agent, e.g. smart car shampoo or cleaning cloths.

Cleaning the sensors

- ❗ If you clean the sensors with a power washer, make sure that you keep a distance of at least 11.8 in (30 cm) between the vehicle and the power washer nozzle. Information about the correct distance is available from the equipment manufacturer.

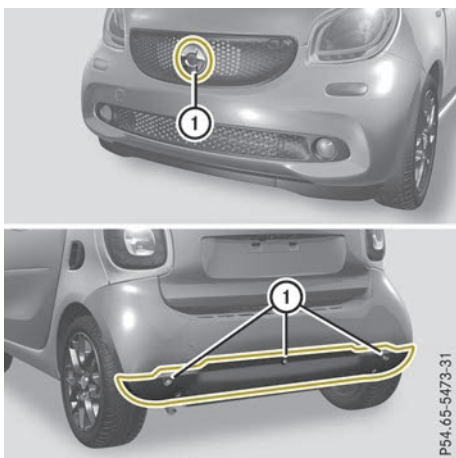

- ▶ Clean sensors ① of the driving systems with water, car shampoo and a soft cloth.

Cleaning the exhaust pipe

Impurities combined with the effects of road grit and corrosive environmental factors may cause flash rust to form on the surface. You can restore the original shine of the exhaust pipe by cleaning it regularly, especially in winter and after washing.

- ❗ Do not clean the exhaust pipe with acid-based cleaning agents, such as bathroom cleaner or wheel cleaner.
- ▶ Clean the exhaust pipe with a care product tested and approved by smart.

Interior care

Cleaning the display

- ❗ For cleaning, do not use any of the following:

- alcohol-based thinner or gasoline
- abrasive cleaning agents
- commercially-available household cleaning agents

These may damage the display surface. Do not put pressure on the display surface when cleaning. This could lead to irreparable damage to the display.

- ▶ Before cleaning the display, make sure that it is switched off and has cooled down.
- ▶ Clean the display surface using a commercially available microfiber cloth and TFT/LCD display cleaner.
- ▶ Dry the display surface using a dry microfiber cloth.

Cleaning the plastic trim

⚠ WARNING

Care products and cleaning agents containing solvents cause surfaces in the cockpit to become porous. As a result, plastic parts may come loose in the event of air bag deployment. There is a risk of injury.

Do not use any care products and cleaning agents to clean the cockpit.

- ❗ Do not affix the following to plastic surfaces:

- stickers
- films
- scented oil bottles or similar items

You can otherwise damage the plastic.

- ❗ Do not allow cosmetics, insect repellent or sunscreen to come into contact with the plastic trim. This maintains the high-quality look of the surfaces.

- ▶ Wipe the plastic trim with a damp, lint-free cloth, e.g. a microfiber cloth.
- ▶ **Heavy soiling:** use care products and cleaning agents recommended and approved by smart.
The surface may change color temporarily. Wait until the surface is dry again.

Cleaning the steering wheel and gear or selector lever

- ▶ Thoroughly wipe with a damp cloth or use leather care agents that have been recommended and approved by smart.

Cleaning the seat covers

General notes

! Do not use a microfiber cloth to clean covers made out of real leather, artificial leather or DINAMICA. If used often, these can damage the cover.

- i** Note that regular care is essential to ensure that the appearance and comfort of the covers is retained over time.

Genuine leather seat covers

Leather is a natural product.

It exhibits natural surface characteristics, for example:

- Differences in the texture
- marks caused by growth and injury
- Slight nuances of color

These are characteristics of leather and not material defects.

! To retain the natural appearance of the leather, observe the following cleaning instructions:

- Clean genuine leather covers carefully with a damp cloth and then wipe the covers down with a dry cloth.
- Make sure that the leather does not become soaked. It may otherwise become rough and cracked.
- Only use leather care agents that have been recommended by smart. You can obtain these from a qualified specialist workshop.

Seat covers of other materials

! Observe the following when cleaning:

- clean artificial leather covers with a cloth moistened with a solution containing 1% detergent (e.g. dish washing liquid).
- clean cloth covers with a microfiber cloth moistened with a solution containing 1% detergent (e.g. dish washing liquid). Rub carefully and always wipe entire seat sections to avoid leaving visible lines. Leave the seat to dry afterwards. Cleaning results depend on the type of dirt and how long it has been there.
- clean DINAMICA covers with a damp cloth. Make sure that you wipe entire seat sections to avoid leaving visible lines.

Cleaning the seat belts

! WARNING

Seat belts can become severely weakened if bleached or dyed. This could cause the seat belts to tear or fail, for instance, in the event of an accident. This poses an increased risk of injury or fatal injury.

Never bleach or dye the seat belts.

! Do not clean the seat belts using chemical cleaning agents. Do not dry the seat belts by heating at temperatures above 176 °F (80 °C) or in direct sunlight.

- ▶ Use clean, lukewarm water and soap solution.

Cleaning the headliner and carpets

- ▶ **Roof lining:** if it is very dirty, use a soft brush or a cleaning agent recommended and approved by smart.
- ▶ **Carpets:** use the carpet and textile cleaning agents recommended and approved by smart.

Where will I find...?

Vehicle tool kit

The TIREFIT kit and the towing eye are located in the stowage well under the front-passenger footwell.

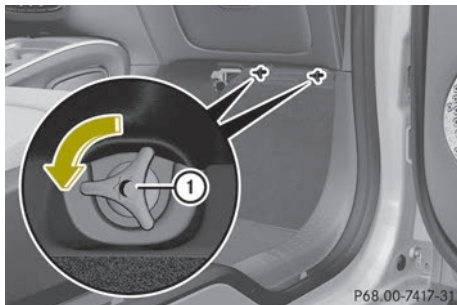

- ▶ Unscrew wing nuts ①.
- ▶ Remove the vehicle tool tray.

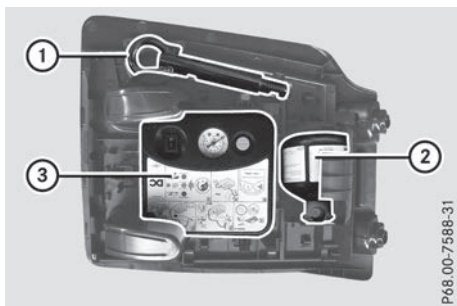

- ① Towing eye
- ② Tire sealant filler bottle
- ③ Tire inflation compressor

Flat tire

Preparing the vehicle

Your vehicle may be equipped with a TIREFIT kit (▷ page 156).

Information on changing/mounting a wheel (▷ page 190).

- ▶ Stop the vehicle on solid, non-slippery and level ground, as far away as possible from traffic.
- ▶ Switch on the hazard warning lamps.
- ▶ Secure the vehicle against rolling away (▷ page 97).

- ▶ If possible, bring the front wheels into the straight-ahead position.
- ▶ Switch off the engine.
- ▶ Remove the SmartKey from the ignition lock.
- ▶ Make sure that the passengers are not endangered as they get out of the vehicle. Make sure that no one is near the danger area while a wheel is being changed. Anyone who is not directly assisting in the wheel change should, for example, stand behind the barrier.
- ▶ Get out of the vehicle. Pay attention to traffic conditions when doing so.
- ▶ Close the driver's door.

TIREFIT kit

Important safety notes

TIREFIT is a tire sealant.

You can use TIREFIT to seal punctures of up to 0.16 in (4 mm), particularly those in the tire tread. You can use TIREFIT at outside temperatures down to -4 °F (-20 °C).

In the case of a flat tire, without TIREFIT the vehicle cannot be made roadworthy again using the on-board equipment. If your vehicle is equipped with a smart Audio-System, you cannot use it to place an emergency call. You are responsible for equipping the vehicle with a corresponding breakdown kit and seeking assistance in the event of a breakdown.

⚠ WARNING

In the following situations, the tire sealant is unable to provide sufficient breakdown assistance, as it is unable to seal the tire properly:

- there are cuts or punctures in the tire larger than those mentioned above.
- the wheel rim is damaged.
- you have driven at very low tire pressures or on a flat tire.

There is a risk of an accident.

Do not drive the vehicle. Contact a qualified specialist workshop.

⚠ WARNING

The tire sealant is harmful and causes irritation. It must not come into contact with your skin, eyes or clothing or be swallowed. Do not inhale TIREFIT fumes. Keep tire sealant away from children. There is a risk of injury.

If you come into contact with the tire sealant, observe the following:

- ▶ Rinse off the tire sealant from your skin immediately with water.
- ▶ If the tire sealant comes into contact with your eyes, immediately rinse them thoroughly with clean water.
- ▶ If tire sealant is swallowed, immediately rinse your mouth out thoroughly and drink plenty of water. Do not induce vomiting, and seek medical attention immediately.
- ▶ Immediately change out of clothing which has come into contact with tire sealant.
- ▶ If an allergic reaction occurs, seek medical attention immediately.

! Do not operate the tire inflation compressor for longer than 15 minutes at a time without a break. It may otherwise overheat. The tire inflation compressor can be operated again once it has cooled down.

Comply with the manufacturer's safety instructions on the sticker on the tire inflation compressor.

Using the TIREFIT kit

- ▶ Do not remove any foreign objects which have penetrated the tire, e.g. screws or nails.
- ▶ Remove the tire sealant bottle and the tire inflation compressor from the front-passenger footwell (▷ page 156).
- ▶ Affix the 50 mph (80 km/h) maximum permissible speed sticker to the instrument cluster within the driver's field of vision.

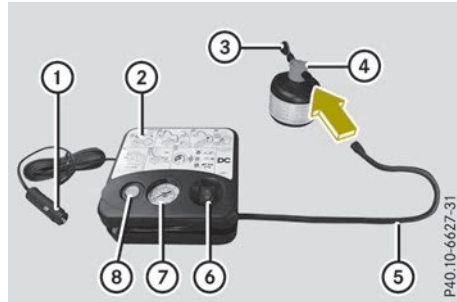

- ▶ Unwind plug ① with the cable from the tire inflation compressor ②.
- ▶ Remove hose ⑤ from the bottom section of tire inflation compressor housing ②.
- ▶ Remove cap on tire sealant bottle ④ and connect hose ⑤.

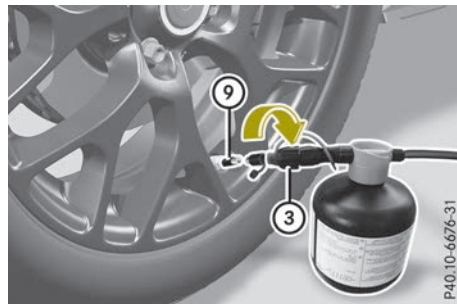

- ▶ Remove the cap from valve ⑨ on the faulty tire.
- ▶ Remove cap on filler hose ③ and screw filler hose ③ onto the valve.
- ▶ Insert connector ① into the 12 V socket in your vehicle (▷ page 143).
- ▶ Turn the SmartKey to position 1 in the ignition lock (▷ page 86).
- ▶ Press on/off switch ⑥ on tire inflation compressor ② to **I**. The tire inflation compressor is switched on. The tire is inflated.

i First, tire sealant is pumped into the tire. The pressure can briefly rise to approximately 600 kPa (6.0 bar/86 psi).

Do not switch off the tire inflation compressor during this phase.

- ▶ Let the tire inflation compressor run for a maximum of 15 minutes. The tire should then have attained a pressure of at least 180 kPa (1.8 bar/26 psi).

>> Breakdown assistance.

If a tire pressure of 180 kPa (1.8 bar/26 psi) is achieved after a maximum of 15 minutes, see "Tire pressure is achieved" (▷ page 158).

If a tire pressure of 180 kPa (1.8 bar/26 psi) has not been achieved after a maximum of 15 minutes, see "Tire pressure is not achieved" (▷ page 158).

- ❗ If tire sealant leaks out, allow it to dry. It can then be removed like a layer of film.

If your clothes are soiled with tire sealant, have them cleaned with perchloroethylene at a dry cleaner as soon as possible.

Tire pressure not reached

If a tire pressure of 180 kPa (1.8 bar/26 psi) has not been achieved after a maximum of 10 minutes:

- ▶ Switch off the tire inflation compressor.
- ▶ Unscrew the filler hose from the valve of the faulty tire.
- ▶ Very slowly drive forwards or reverse approximately 30 ft (10 m).
- ▶ Pump up the tire again.
After a maximum of 10 minutes, the tire pressure must be at least 180 kPa (1.8 bar/26 psi).

WARNING

If the required tire pressure is not reached after the specified time, the tire is too badly damaged. The tire sealant cannot repair the tire in this instance. Damaged tires and a tire pressure that is too low can significantly impair the vehicle's braking and driving characteristics. There is a risk of accident.

Do not continue driving. Contact a qualified specialist workshop.

Tire pressure reached

WARNING

A tire temporarily sealed with tire sealant impairs the driving characteristics and is not suitable for higher speeds. There is a risk of accident.

You should therefore adapt your driving style accordingly and drive carefully. Do

not exceed the specified maximum speed with a tire that has been repaired using tire sealant.

The maximum permissible speed for a tire sealed with tire sealant is 50 mph (80 km/h). The 50 mph (80 km/h) maximum speed sticker must be affixed to the instrument cluster within the driver's field of vision.

- ❗ After use, excess tire sealant may run out of the filler hose. This could cause stains. Therefore, place the filler hose in the plastic bag that contained the TIREFIT kit.

Environmental note

Have the used tire sealant bottle disposed of professionally, e.g. at a qualified specialist workshop.

If a tire pressure of 180 kPa (1.8 bar/26 psi) has been achieved after 10 minutes:

- ▶ Switch off the tire inflation compressor.
- ▶ Unscrew the filler hose from the valve of the faulty tire.
- ▶ Stow the tire sealant bottle and the tire inflation compressor.
- ▶ **Pull away immediately.**
- ▶ Stop after driving for approximately 2 miles (3 km) and check the tire pressure with the tire inflation compressor. The tire pressure must now be at least 130 kPa (1.3 bar/19 psi).

WARNING

If the required tire pressure is not reached after driving for a short period, the tire is too badly damaged. The tire sealant cannot repair the tire in this instance. Damaged tires and a tire pressure that is too low can significantly impair the vehicle's braking and driving characteristics. There is a risk of accident.

Do not continue driving. Contact a qualified specialist workshop.

- ▶ Correct the tire pressure if it is still at least 130 kPa (1.3 bar/19 psi). For values, see the tire and loading information table on the driver's side B-pillar.

- ▶ **To increase the tire pressure:** switch on the tire inflation compressor.



- ▶ **To reduce the tire pressure:** depress pressure release button ① next to pressure gauge ②.
- ▶ If the tire pressure is correct, unscrew the filler hose from the valve of the sealed tire.
- ▶ Screw the valve cap onto the valve of the sealed tire.
- ▶ Drive to the nearest qualified specialist workshop and have the tire changed there.
- ▶ Have the tire sealant bottle and the filler hose replaced as soon as possible at a qualified specialist workshop.
- ▶ Have the tire sealant bottle replaced every four years at a qualified specialist workshop.

Battery (vehicle)

Important safety notes

Special tools and expert knowledge are required when working on the battery, e.g. removal and installing. You should therefore have all work involving the battery carried out at a qualified specialist workshop.

WARNING

Work carried out incorrectly on the battery can lead, for example, to a short circuit and thus damage the vehicle electronics. This can lead to function restrictions applying to safety-relevant systems, e.g. the lighting system, the ABS (anti-lock braking system) or the ESP® (Electronic Stability Program).

The operating safety of your vehicle may be restricted.

You could lose control of the vehicle, for example:

- when braking
- in the event of abrupt steering maneuvers and/or when the vehicle's speed is not adapted to the road conditions

There is a risk of an accident.

In the event of a short circuit or a similar incident, contact a qualified specialist workshop immediately. Do not drive any further. You should have all work involving the battery carried out at a qualified specialist workshop.

Further information about ABS (> page 49) and esp® (> page 51).

WARNING

Electrostatic build-up can lead to the creation of sparks, which could ignite the highly explosive gases of a battery. There is a risk of an explosion.

Before handling the battery, touch the vehicle body to remove any existing electrostatic build-up.

The highly flammable gas mixture forms when charging the battery as well as when jump-starting.

Always make sure that neither you nor the battery is electrostatically charged. There is a build-up of electrostatic charge, e.g.:

- by wearing clothing made from synthetic fibers
- due to friction between clothing and seats
- if you push or pull the battery across the carpet or other synthetic materials
- if you wipe the battery with a cloth.

WARNING

During the charging process, a battery produces hydrogen gas. If a short circuit occurs or sparks are created, the hydrogen gas can ignite. There is a risk of an explosion.

- Make sure that the positive terminal of a connected battery does not come into contact with vehicle parts.
- Never place metal objects or tools on a battery.
- It is important that you observe the described order of the battery terminals when connecting and disconnecting a battery.
- When jump-starting, make sure that the battery poles with identical polarity are connected.
- It is particularly important to observe the described order when connecting and disconnecting the jumper cables.
- Never connect or disconnect the battery terminals while the engine is running.

 **WARNING**

Battery acid is caustic. There is a risk of injury.

Avoid contact with skin, eyes or clothing. Do not inhale any battery gases. Do not lean over the battery. Keep children away from batteries. Wash away battery acid immediately with plenty of clean water and seek medical attention.

 **Environmental note**



Batteries contain dangerous substances. It is against the law to dispose of them with the household rubbish. They must be collected separately and recycled to protect the environment.



Dispose of batteries in an environmentally friendly manner. Take discharged batteries to a qualified specialist workshop or a special collection point for used batteries.

- ❗ Have the battery checked regularly at a qualified specialist workshop.

Observe the service intervals in the Maintenance Booklet or contact a qualified specialist workshop for more information.

- ❗ You should have all work involving the battery carried out at a qualified specialist workshop. In the exceptional case that it is necessary for you to disconnect the battery yourself, make sure that:

- you switch off the engine and remove the SmartKey. Check that all the indicator lamps in the instrument cluster are off. Otherwise, electronic components, such as the alternator, may be damaged.
- you first remove the negative terminal clamp and then the positive terminal clamp. Never swap the terminal clamps. Otherwise, the vehicle's electronic system may be damaged.

The battery and the cover of the positive terminal clamp must be installed securely during operation.

Comply with safety precautions and take protective measures when handling batteries.



WARNING



Fire, open flames and smoking are prohibited when handling the battery. Avoid creating sparks.



Battery acid is caustic. Avoid contact with skin, eyes or clothing. Wear suitable protective clothing, especially gloves, apron and face-guard.

Rinse any acid spills immediately with clear water. Contact a physician if necessary.



Wear eye protection.



Keep children away.



Observe this Operator's Manual.

For safety reasons, smart recommends that you only use batteries which have been tested and approved specifically for your vehicle by smart. These batteries provide increased impact protection to prevent vehicle occupants from suffering acid burns should the battery be damaged in the event of an accident.

In order for the battery to achieve the maximum possible service life, it must always be sufficiently charged.

Like other batteries, the vehicle battery may discharge over time if you do not use the vehicle. In this case, have the battery disconnected at a qualified specialist workshop. To maintain the charge, you can also charge the battery with a charger recommended by smart. Contact a qualified specialist workshop for further information.

Have the battery charge status checked more frequently if you use the vehicle mainly for short trips or if you leave it standing idle for a lengthy period. Consult a qualified specialist workshop if you wish to leave your vehicle parked for a long period of time.

When replacing a battery, only use a battery recommended by smart.

- i** Remove the SmartKey if you park the vehicle and do not require any electrical consumers. The vehicle will then use very little energy, thus conserving battery power.

Checking the battery condition of charge

Batteries with a Magic Eye display must be checked at regular intervals. You can check the condition of charge of the battery via the Magic Eye display.

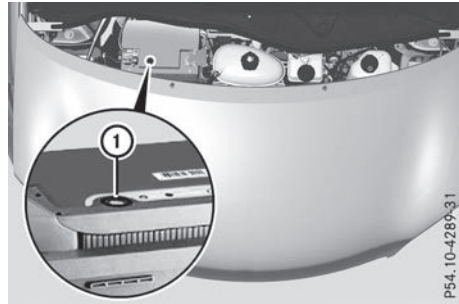

- ▶ Open the service cover (▷ page 147).
- ▶ Check which color is shown in Magic Eye display ①.

Color	Battery status
Green	Battery is fully functional
Dark green	Charging the battery
White	Replace the battery

- i** If the Magic Eye display shows white, do not:
 - drive the vehicle
 - charge the battery
 - jump-start the vehicle

Have the battery replaced immediately at a qualified specialist workshop.

Observe the notes on charging the battery (▷ page 161).

Charging the battery

⚠ WARNING

During charging and jump-starting, explosive gases can escape from the battery. There is a risk of an explosion.

Particularly avoid fire, open flames, creating sparks and smoking. Ensure there is sufficient ventilation while charging and jump-starting. Do not lean over a battery.

⚠ WARNING

Battery acid is caustic. There is a risk of injury.

>> Breakdown assistance.

Avoid contact with skin, eyes or clothing. Do not inhale any battery gases. Do not lean over the battery. Keep children away from batteries. Wash away battery acid immediately with plenty of clean water and seek medical attention.

 **WARNING**

A discharged battery can freeze at temperatures below freezing point. When jump-starting the vehicle or charging the battery, gases can escape from the battery. There is a risk of an explosion. Allow the frozen battery to thaw out before charging it or jump-starting.

 Only use battery chargers with a maximum charging voltage of 14.8 V.

- ▶ Open the service cover (▷ page 147).
- ▶ Connect the battery charger to the positive terminal and ground point in the same

order as when connecting the donor battery in the jump-starting procedure (▷ page 162).

If, at low temperatures, the indicator lamps/warning lamps in the instrument cluster do not light up, it is highly likely that the discharged battery has frozen. In this case you may neither jump-start the vehicle nor charge the battery. The service life of a thawed-out battery may be shorter. The starting characteristics can be impaired, particularly at low temperatures. Have the thawed-out battery checked at a qualified specialist workshop.

Only charge the fitted battery with a battery charger which has been tested and approved by smart. A battery charger specially adapted for smart vehicles, and tested and approved by smart, is available as an accessory. It permits the charging of the battery in its installed position. Contact a smart center for further information and availability. Read the battery charger's operating instructions before charging the battery.

>>> Breakdown assistance.

Jump-starting

 **WARNING**

Battery acid is caustic. There is a risk of injury.

Avoid contact with skin, eyes or clothing. Do not inhale any battery gases. Do not lean over the battery. Keep children away from batteries. Wash away battery acid immediately with plenty of clean water and seek medical attention.

 **WARNING**

During charging and jump-starting, explosive gases can escape from the battery. There is a risk of an explosion.

Particularly avoid fire, open flames, creating sparks and smoking. Ensure there is sufficient ventilation while charging and jump-starting. Do not lean over a battery.

 **WARNING**

During the charging process, a battery produces hydrogen gas. If a short circuit occurs or sparks are created, the hydrogen gas can ignite. There is a risk of an explosion.

- Make sure that the positive terminal of a connected battery does not come into contact with vehicle parts.
- Never place metal objects or tools on a battery.
- It is important that you observe the described order of the battery terminals when connecting and disconnecting a battery.

- When jump-starting, make sure that the battery poles with identical polarity are connected.
- It is particularly important to observe the described order when connecting and disconnecting the jumper cables.
- Never connect or disconnect the battery terminals while the engine is running.

 **WARNING**

A discharged battery can freeze at temperatures below freezing point. When jump-starting the vehicle or charging the battery, gases can escape from the battery. There is a risk of an explosion.

Allow the frozen battery to thaw out before charging it or jump-starting.

- !** Avoid repeated and lengthy starting attempts. Otherwise, the catalytic converter could be damaged by the non-combusted fuel.

If, at low temperatures, the indicator lamps/warning lamps in the instrument cluster do not light up, it is highly likely that the discharged battery has frozen. In this case you may neither jump-start the vehicle nor charge the battery. The service life of a thawed-out battery may be shorter. The starting characteristics can be impaired, particularly at low temperatures. Have the thawed-out battery checked at a qualified specialist workshop.

Do not start the vehicle using a rapid charging device. If your vehicle's battery is discharged, the engine can be jump-started from another vehicle or from a second battery using jumper cables. Observe the following points:

- The battery is not accessible in all vehicles. If the other vehicle's battery is not accessible, jump-start the vehicle using a second battery or a jump-starting device.
- You may only jump-start the vehicle when the engine and exhaust system are cold.
- Do not start the engine if the battery is frozen. Let the battery thaw first.
- Only jump-start from batteries with a 12 V voltage rating.
- Only use jumper cables which have a sufficient cross-section and insulated terminal clamps.
- If the battery is fully discharged, leave the battery that is being used to jump-start connected for a few minutes before attempting to start. This charges the battery slightly.
- Make sure that the two vehicles do not touch.

Make sure that:

- The jumper cables are not damaged.
- Bare parts of the terminal clamp do not come into contact with other metal parts while the jumper cables are connected to the battery.
- The jump leads cannot come into contact with parts which can move when the engine is running, such as the wiper rods or the fan.
- ▶ Secure the vehicle using the parking brake.
- ▶ Turn the key to position **0** in the ignition lock and remove it.
- ▶ Switch off all electrical consumers, e.g. rear window heating, lighting etc.
- ▶ Open the service cover.

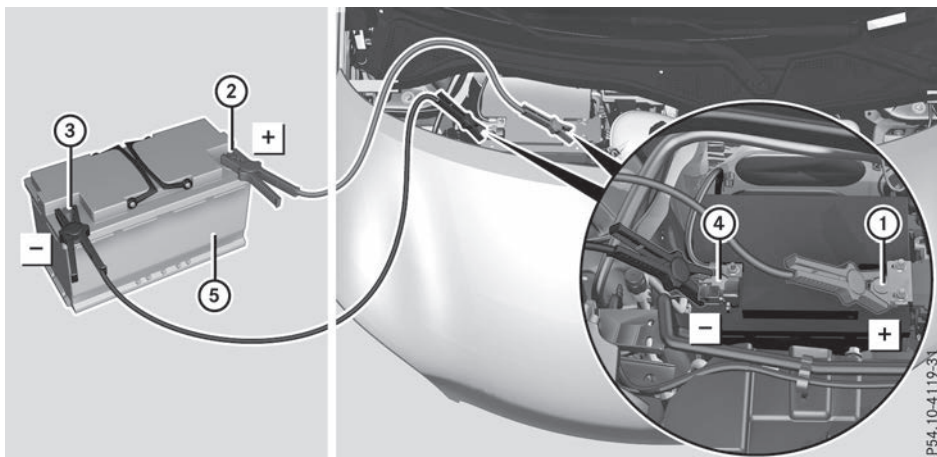

>> Breakdown assistance.

Position number ⑤ identifies the charged battery of the other vehicle or an equivalent jump-starting device.

- ▶ Remove the protective cover from positive terminal ①.
 - ▶ Connect positive terminal ① on your battery to positive terminal ② of donor battery ⑤ using the jump lead, beginning with your own battery.
 - ▶ Start the engine of the donor vehicle and run it at idling speed.
 - ▶ Connect negative terminal ③ of donor battery ⑤ to negative terminal ④ of your battery using the jump lead. Connect the jump lead to donor battery ⑤ first.
 - ▶ Start the engine.
 - ▶ Before disconnecting the jumper cables, let the engine run for several minutes.
 - ▶ First disconnect the jump lead from negative terminal ④ and negative terminal ③ and then from positive terminal ① and positive terminal ②. Begin each time at the contacts on your own vehicle first.
 - ▶ Attach the protective cover to positive terminal ①.
 - ▶ Have the battery checked at a qualified specialist workshop.
- i** Jump-starting is not considered to be a normal operating condition.
- i** Jumper cables and further information regarding jump starting can be obtained at any qualified specialist workshop.

Towing and tow-starting

Important safety notes

WARNING

Functions relevant to safety are restricted or no longer available if:

- the engine is not running
- the brake system or the power steering is malfunctioning
- there is a malfunction in the power supply or the vehicle's electrical system

When your vehicle is towed away or towed started, you may require considerably more effort to steer and brake. There is a risk of an accident.

In such cases, use a tow bar. Before being towed away or tow started, make sure the steering moves freely.

WARNING

You can no longer steer the vehicle if the steering wheel lock has been engaged. There is a risk of an accident.

Always switch off the ignition when towing the vehicle with a tow cable or a tow bar.

WARNING

When towing or tow-starting another vehicle and its weight is greater than the permissible gross weight of your vehicle, the:

- the towing eye could detach itself
- the vehicle/trailer combination could rollover.

There is a risk of an accident.

When towing or tow-starting another vehicle, its weight should not be greater than the permissible gross weight of your vehicle.

Information on your vehicle's gross vehicle weight rating can be found on the vehicle identification plate (> page 198).

-  Do not use the towing eyes for recovery purposes as this could damage the vehicle.

If in doubt, recover the vehicle with a crane.

-  Drive slowly and smoothly when towing. Excessive tractive power could otherwise damage the vehicles.

-  Do not tow with sling-type equipment. This could damage the vehicle.

-  The vehicle can be towed a maximum of 30 miles (50km). The towing speed of 30 mph (50 km/h) must not be exceeded.

If the vehicle has to be towed more than 30 miles (50km), the entire vehicle must be raised and transported.

It is better to have the vehicle transported than to have it towed.

Vehicles with automatic transmission: when towing a vehicle, the transmission must be in position **N**.

-  Deactivate the automatic locking feature (> page 57). You could otherwise be locked out when pushing or towing the vehicle.

-  **Vehicles with the basic carrier fitted:**

Do not tow away the vehicle with the basic carrier fitted.

Do not secure the tow cable or tow bar to the basic carrier.

Installing/removing the towing eye

Installing the towing eye

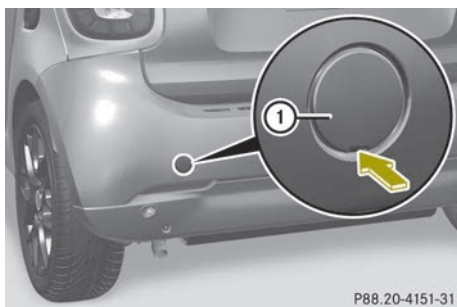

- ▶ Remove the towing eye from the stowage space. The towing eye is located in the vehicle tool kit stowage compartment in the front-passenger footwell (▷ page 156).
- ▶ Carefully prise out cover ① using a suitable tool, e.g. a plastic wedge.
- ▶ Screw in the towing eye clockwise to the stop and tighten it.

Removing the towing eye

- ▶ Unscrew and remove the towing eye.
- ▶ Position top of cover ① in the bumper and press it in at the bottom until it engages.
- ▶ Place the towing eye in the vehicle tool kit stowage compartment in the front-passenger footwell (▷ page 156).

Towing the vehicle with the rear axle raised

When towing your vehicle with the rear axle raised, it is important that you observe the safety instructions (▷ page 165).

- ⚠ The ignition must be switched off if you are towing the vehicle with the rear axle raised. Intervention by ESP® could otherwise damage the brake system.
- ▶ Switch on the hazard warning lamps (▷ page 70).
- ▶ Bring the front wheels into the straight-ahead position.
- ▶ **Vehicles with automatic transmission:** turn the SmartKey to position **2** in the ignition lock. Shift the automatic transmission to position **P**.

or

- ▶ **Vehicles with manual transmission:** depress the clutch pedal fully and select neutral.
- ▶ Turn the SmartKey to position **0** in the ignition lock and remove the SmartKey from the ignition lock.
- ▶ Take the SmartKey with you when you leave the vehicle.

It is important that you observe the safety instructions when towing away your vehicle (▷ page 165).

Vehicles with automatic transmission: observe the notes on the selector lever when towing away your vehicle (▷ page 90).

Towing a vehicle with both axles on the ground

i In order to signal a change of direction when towing with the hazard warning lamps switched on, use the combination switch as usual. In this case, only the indicator lamps for the direction of travel flash. After resetting the combination switch, the hazard warning lamp starts flashing again.

Vehicles with automatic transmission:

- ▶ Make sure that the vehicle is stationary.
- ▶ Turn the SmartKey to position **2** in the ignition lock.

- ▶ Depress and hold the brake pedal.
- ▶ Shift the automatic transmission to position **N**.
You can manually release the selector lever lock in the event of an electrical malfunction (▷ page 95).
- ▶ Release the brake pedal.
- ▶ Release the parking brake.
- ▶ Switch on the hazard warning lamps (▷ page 70).

Vehicles with manual transmission:

- ▶ Leave the SmartKey in position **2** in the ignition lock.
- ▶ Release the brake pedal.
- ▶ Release the parking brake.
- ▶ Switch on the hazard warning lamps (▷ page 70).

It is important that you observe the safety instructions when towing away your vehicle (▷ page 165).

Vehicles with automatic transmission:

observe the notes on the selector lever when towing away your vehicle (▷ page 90).

Transporting the vehicle

! You may only secure the vehicle by the wheels, not by parts of the vehicle such as axle or steering components. Otherwise, the vehicle could be damaged.

- ▶ **Vehicles with automatic transmission:** turn the SmartKey to position **2** in the ignition lock (▷ page 86).
- ▶ Shift the transmission to position **N**.
- ▶ **Vehicles with manual transmission:** depress the clutch pedal fully and select neutral.

As soon as the vehicle has been loaded:

- ▶ Prevent the vehicle from rolling away by applying the parking brake.
- ▶ **Vehicles with automatic transmission:** shift the transmission to position **P**.
- ▶ **Vehicles with manual transmission:** depress the clutch pedal fully and engage first or reverse gear.
- ▶ Turn the SmartKey to position **0** in the ignition lock and remove it.
- ▶ Secure the vehicle.

The towing eye can be used to pull the vehicle onto a trailer or transporter for transporting purposes.

Tow-starting (emergency engine starting)

i You can find information on "Jump-starting" at (▷ page 162).

Before tow-starting:

- the battery must be connected
- the engine must be cold
- the exhaust system has cooled down.
- ▶ Switch on the hazard warning lamps (▷ page 70).
- ▶ Install the towing eye (▷ page 166).
- ▶ Secure the rigid towing bar or the towing rope.
- ▶ Depress and hold the brake pedal.
- ▶ Turn the SmartKey to position **2** in the ignition lock.
- ▶ **Vehicles with automatic transmission:** activate manual gearshifting (▷ page 92).
- ▶ **Vehicles with manual transmission:** depress the clutch pedal fully, engage second gear and keep the clutch pedal fully depressed.
- ▶ Release the brake pedal.
- ▶ Tow-start the vehicle.
- ▶ **Vehicles with automatic transmission:** Press and hold the selector lever towards **+**, until the engine starts. Do not depress the accelerator pedal while doing so.
- ▶ **Vehicles with manual transmission:** release the clutch pedal slowly; do not depress the accelerator pedal while doing so.
- ▶ **Vehicles with manual transmission:** when the engine is started, immediately depress the clutch pedal fully and select neutral.
- ▶ Pull over at a suitable place and stop the vehicle safely, paying attention to road and traffic conditions.
- ▶ Secure the vehicle against rolling away with the parking brake.
- ▶ Remove the rigid towing bar or towing rope.
- ▶ Remove the towing eye (▷ page 166).
- ▶ Switch off the hazard warning lamps.

Fuses

Important safety notes

WARNING

If you manipulate or bridge a faulty fuse or if you replace it with a fuse with a higher amperage, the electric cables could be overloaded. This could result in a fire. There is a risk of an accident and injury. Always replace faulty fuses with the specified new fuses having the correct amperage.

- ❗ Only use fuses that have been approved for smart vehicles and which have the correct fuse rating for the system concerned. Otherwise, components or systems could be damaged.

The fuses in your vehicle serve to close down faulty circuits. If a fuse blows, all the components on the circuit and their functions stop operating.

Blown fuses must be replaced with fuses of the same rating, which you can recognize by the color and value. The fuse ratings are listed in the fuse allocation chart (> page 169).

If a newly inserted fuse also blows, have the cause traced and rectified at a qualified specialist workshop, e.g. an authorized Mercedes-Benz Center.

Certain vehicle functions are protected via the fuse box in the front area. Access to the fuses is very restricted. Have a blown fuse in the front area replaced at a qualified specialist workshop.

Before changing a fuse

- ▶ Secure the vehicle against rolling away (> page 97).
- ▶ Switch off all electrical consumers.
- ▶ Turn the key to position **0** in the ignition lock and remove it (> page 86). All indicator lamps in the instrument cluster must be off.

The fuses are located in various fuse boxes:

- Fuse box in the front area
- Fuse box in the glove compartment

Fuse box in the glove box

Fuse box

- ❗ Do not use a pointed object such as a screwdriver to open the cover in the dashboard. You could damage the dashboard or the cover.
- ❗ Make sure that no moisture can enter the fuse box when the cover is open.
- ❗ When closing the cover, make sure that it is lying correctly on the fuse box. Moisture seeping in or dirt could otherwise impair the operation of the fuses.

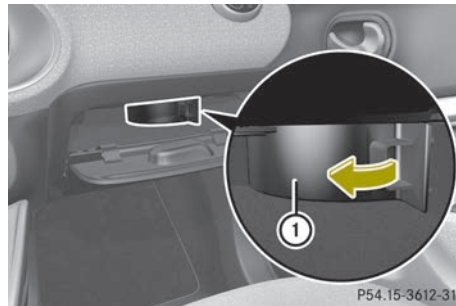

- ▶ Open the driver's door.
- ▶ Open the glove box.
- ▶ **To open:** open cover ① in the direction of the arrow.
- ▶ **To close:** insert and fold in cover ① until it engages.
- ▶ Close the glove box.

Fuse allocation

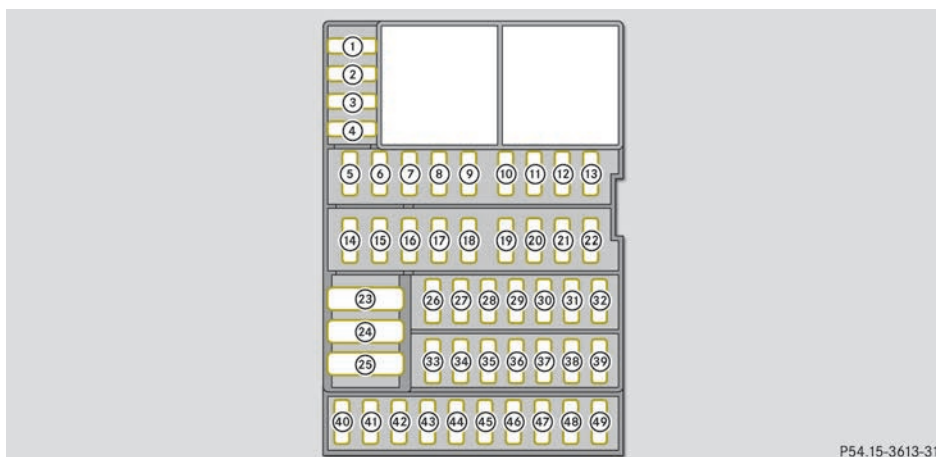

P54.15-3613-31

No.	Consumer	Current	Color coding
1	Starter motor	5 A	Brown
2	Power steering control unit	5 A	Brown
3	Lighting control unit	5 A	Brown
4	Air bag	5 A	Brown
5	-	-	-
6	Instrument cluster	10 A	Red
7	Horn, alarm system	15 A	Blue
8	Control unit power supply	10 A	Red
9	Control unit power supply	10 A	Red
10	Central control unit	20 A	Yellow
11	Turn signals	15 A	Blue
12	Central control unit	10 A	Red
13	Central control unit	15 A	Blue
14	Power windows (automatic reversing feature)	30 A	Green
15	ESP®	5 A	Brown
16	Interior lighting	10 A	Red
17	Immobilizer	3 A	Violet
18	Electrical exterior mirror	5 A	Brown
19	Brake lamps	10 A	Red
20	Parking aid, headlamp settings	15 A	Blue

>> Breakdown assistance.

>> Breakdown assistance.

No.	Consumer	Current	Color coding
21	Engine control unit	5 A	Brown
22	Rear window wiper	15 A	Blue
23	Starter motor	30 A	Green
24	Central locking	40 A	Orange
25	Front windshield wiper	30 A	Green
26	Radio	20 A	Yellow
27	-	-	-
28	12 V socket	15 A	Blue
29	Power supply control unit	5 A	Brown
30	Horn	15 A	Blue
31	-	-	-
32	Central locking	15 A	Blue
33	Tail lamps, front foglamps, hazard warning lamp button, locking button, power windows, license plate lamp, radio, control unit for air-conditioning system, cruise control, parking aid button, program selector button, tailgate unlocking	25 A	Cyan
34	Headlamps, daytime running lamps	25 A	Cyan
35	Headlamps, daytime running lamps	25 A	Cyan
36	-	-	-
37	-	-	-
38	-	-	-
39	-	-	-
40	-	-	-
41	-	-	-
42	-	-	-
43	Exterior mirror heating	5 A	Brown
44	Automatic reversing feature	25 A	Cyan
45	Transmission control unit	5 A	Brown
46	Radio amplifier	20 A	Yellow
47	-	-	-
48	-	-	-
49	-	-	-

Important safety notes

WARNING

If wheels and tires of the wrong size are used, the wheel brakes or suspension components may be damaged. There is a risk of an accident.

Always replace wheels and tires with those that fulfill the specifications of the original part.

When replacing wheels, make sure to use the correct:

- designation
- model

When replacing tires, make sure to use the correct:

- designation
- manufacturer
- model

Warning

A flat tire severely impairs the driving, steering and braking characteristics of the vehicle. There is a risk of an accident. do not drive with a flat tire. Immediately replace the flat tire with your spare wheel, or consult a qualified specialist workshop.

Accessories that are not approved for your vehicle by smart or that are not being used correctly can impair driving safety.

Before purchasing and using non-approved accessories, visit a qualified specialist workshop and inquire about:

- suitability
- legal stipulations
- factory recommendations

Information on dimensions and types of wheels and tires for your vehicle (▷ page 193).

Information on air pressure for the tires on your vehicle can be found:

- on the tire and loading information table on the driver's side B-pillar
- under "Tire pressure" (▷ page 174)

- i** Further information on wheels and tires can be obtained at any qualified specialist workshop.

Operation

Information on driving

- Check the tire pressures when the vehicle is heavily laden and, if necessary, adjust before beginning your journey.
- While driving, pay attention to vibrations, noises and unusual handling characteristics, e.g. pulling to one side. This may indicate that the wheels or tires are damaged. If you suspect that a tire is defective, reduce your speed immediately. Stop the vehicle as soon as possible to check the wheels and tires for damage. Hidden tire damage could also be causing the unusual handling characteristics. If you find no signs of damage, have the tires and wheels checked at a qualified specialist workshop.
- When parking your vehicle, make sure that the tires do not get deformed by the curb or other obstacles. If it is necessary to drive over curbs, speed humps or similar elevations, try to do so slowly and at an obtuse angle. Otherwise, the tires, particularly the sidewalls, may be damaged.

Regular checking of wheels and tires

WARNING

Damaged tires can cause tire inflation pressure loss. As a result, you could lose control of your vehicle. There is a risk of accident.

Check the tires regularly for signs of damage and replace any damaged tires immediately.

Regularly check the wheels and tires of your vehicle for damage, at least once a month, as well as after driving on rough roads. Damaged wheels can cause a loss of tire pressure. Pay particular attention to damage such as:

- cuts in the tires
- punctures in the tires

- tears in the tires
- bulges on tires
- deformation or severe corrosion on wheels

Regularly check the tire tread depth and the condition of the tread across the whole width of the tire (▷ page 172). If necessary, turn the front wheels to full lock in order to inspect the inner side of the tire surface.

All wheels must have a valve cap to protect the valve against dirt and moisture. Do not fit anything onto the valve other than the standard valve cap or other valve caps approved for your vehicle by smart. Do not use any other valve caps or systems, e.g. tire pressure monitoring systems.

Regularly check the pressure of all the tires particularly prior to long trips. Adjust the tire pressure as necessary (▷ page 174).

The service life of tires depends, among other things, on the following factors:

- Driving style
- Tire pressure
- Distance covered

>> Wheels and tires.

Notes on tire profile

WARNING

Insufficient tire tread will reduce tire traction. The tire is no longer able to dissipate water. This means that on wet road surfaces, the risk of hydroplaning increases, in particular where speed is not adapted to suit the driving conditions. There is a risk of accident.

If the tire pressure is too high or too low, tires may exhibit different levels of wear at different locations on the tire tread. Thus, you should regularly check the tread depth and the condition of the tread across the entire width of all tires.

Minimum tire tread depth for:

- Summer tires: $\frac{1}{8}$ in (3 mm)
- M+S tires: $\frac{1}{6}$ in (4 mm)

For safety reasons, replace the tires before the legally prescribed limit for the minimum tire tread depth is reached.

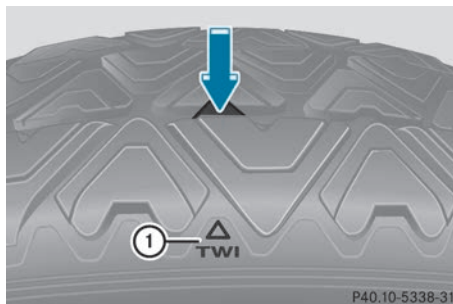

Indicator ① shows which position the bar marking (arrow) for tread wear is integrated into the tire tread.

Treadwear indicators (TWI) are required by law. Six indicators are positioned on the tire tread. They are visible once a tread depth of approximately $\frac{1}{16}$ in (1.6 mm) has been reached. If this is the case, the tire is so worn that it must be replaced.

Selecting, mounting and replacing tires

- Only mount tires and wheels of the same type and make.
Exception: it is permissible to fit a different type or make in the event of a flat tire.
- Only mount tires of the correct size onto the wheels.
- After fitting new tires, run them in at moderate speeds for the first 60 miles (100 km), as they only reach their full performance after this distance.
- Do not drive with tires which have too little tread depth, as this significantly reduces the traction on wet roads (hydroplaning).
- Replace the tires after six years at the latest, regardless of wear.

Winter operation

General notes

Have your vehicle winterproofed at a qualified specialist workshop at the onset of winter.

Observe the notes in the "Changing a wheel" section (▷ page 189).

Driving with summer tires

At temperatures below 45 °F (+7 °C), summer tires lose elasticity and therefore traction and braking power. Change the tires on your vehicle to M+S tires. Using summer tires at very cold temperatures could cause tears to form, thereby damaging the tires permanently. smart cannot accept responsibility for this type of damage.

WARNING

Damaged tires can cause tire inflation pressure loss. As a result, you could lose control of your vehicle. There is a risk of accident.

Check the tires regularly for signs of damage and replace any damaged tires immediately.

M+S tires

WARNING

M+S tires with a tire tread depth of less than $\frac{1}{8}$ in (4 mm) are not suitable for use in winter and do not provide sufficient traction. There is a risk of an accident.

M+S tires with a tread depth of less than $\frac{1}{8}$ in (4 mm) must be replaced immediately.

At temperatures below 45 °F (+7 °C) use winter tires marked with M+S.

Only winter tires bearing the  snowflake symbol in addition to the M+S marking provide the best possible grip in wintry road conditions. Only these tires will allow driving safety systems such as ABS and ESP® to function optimally in winter. These tires have been developed specifically for driving in snow.

Use M+S tires of the same make and tread on all wheels to maintain safe handling characteristics.

Always observe the maximum permissible speed specified for the M+S tires you have mounted. Therefore, only use tire types and sizes approved for smart. Observe the tire load rating and speed rating required for smart.

Tires with a specified direction of rotation have additional benefits, e.g. if there is a risk of aquaplaning. These advantages can only be gained if the tires are mounted corresponding to the direction of rotation.

An arrow on the sidewall of the tire indicates its correct direction of rotation.

When you have mounted the M+S tires:

- ▶ Check the tire pressures (▷ page 174).
- ▶ **Vehicles for USA:** restart the tire pressure monitor (▷ page 179).

Snow chains

WARNING

If snow chains are installed to the front wheels, they may drag against the vehicle body or chassis components. This could cause damage to the vehicle or the tires. There is a risk of an accident.

To avoid hazardous situations:

- never install snow chains to the front wheels
- always install snow chains in pairs to the rear wheels.

! **Vehicles with steel wheels:** if you mount snow chains on steel wheels, you may damage the hub caps. Remove the hub caps from the relevant wheels before mounting the snow chains.

smart recommends that you only use snow chains that have been specially approved for smart. For more information, please contact the smart center or a qualified specialist workshop.

Bear in mind that snow chains are designed for a certain wheel size. If you mount tires that are larger or smaller than the original tires, you will require new snow chains of the correct size.

If you intend to mount snow chains, please bear the following points in mind:

- Snow chains may not be mounted on all wheel/tire combinations. Permissible wheel-tire combinations (▷ page 193).
- Only use snow chains when driving on roads completely covered by snow. Remove the

snow chains as soon as possible when you come to a road that is not snow-covered.

- Local regulations may restrict the use of snow chains. Observe the appropriate regulations if you wish to mount snow chains.
- Do not exceed the maximum permissible speed of 30 mph (50 km/h).

Tire pressure

Tire pressure specifications

WARNING

Underinflated or overinflated tires pose the following risks:

- the tires may burst, especially as the load and vehicle speed increase.
- the tires may wear excessively and/or unevenly, which may greatly impair tire traction.
- the driving characteristics, as well as steering and braking, may be greatly impaired.

There is a risk of an accident.

Follow recommended tire inflation pressures and check the pressure of all the tires including the spare wheel:

- monthly, at least
- if the load changes
- before beginning a long journey
- under different operating conditions, e.g. off-road driving

If necessary, correct the tire pressure.

The specifications on the sample Tire and Loading Information placard and tire pressure tables are examples. Tire pressure specifications are vehicle-specific and may deviate from the data shown here. The tire pressure specifications that are valid for your vehicle can be found on the Tire and Loading Information placard and tire pressure table on the vehicle.

The recommended tire pressures for the tires mounted at the factory can be found on the labels described here.

Further information on tire pressures can be obtained at a qualified specialist workshop.

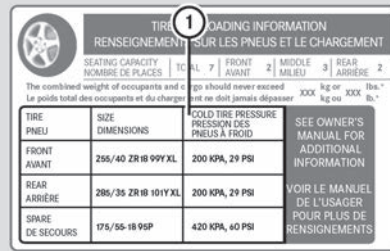

TIRE LOADING INFORMATION
RENSEIGNEMENTS POUR LES PNEUS ET LE CHARGEMENT

SEATING CAPACITY / NOMBRE DE PLACES: TOTAL 7, FRONT AVANT 2, MIDDLE MILIEU 3, REAR ARRIERE 2

The combined weight of occupants and cargo should never exceed XXX kg or XXX lbs. *
 Le poids total des occupants et du chargement ne doit jamais dépasser XXX kg ou XXX lbs. *

TIRE / PNEU	SIZE / DIMENSIONS	COLD TIRE PRESSURE / PRESSION DES PNEUS À FROID
FRONT / AVANT	255/40 ZR18 99Y XL	200 KPA, 29 PSI
REAR / ARRIERE	285/35 ZR18 101Y XL	200 KPA, 29 PSI
SPARE / DE SECOURS	175/55-18 95P	420 KPA, 60 PSI

SEE OWNER'S MANUAL FOR ADDITIONAL INFORMATION.
 VOIR LE MANUEL DE L'USAGER POUR PLUS DE RENSEIGNEMENTS

P40.00-2205-31

① Recommended tire pressures

The Tire and Loading Information placard is on the B-pillar on the driver's side (> page 179).

The Tire and Loading Information placard contains the recommended tire pressures for cold tires. The recommended tire pressures are valid for the maximum permissible load and up to the maximum permissible vehicle speed.

The tire pressure table is on the inside of the fuel filler flap.

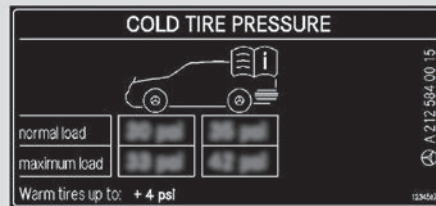

COLD TIRE PRESSURE

normal load	250 psi	250 psi
maximum load	330 psi	430 psi

Warm tires up to: + 4 psi

134547

P40.00-2179-31

Example: tire pressure table for all tires permitted for this vehicle by the factory

The tire pressure table contains the recommended pressures for cold tires for various operating conditions, i.e. differing load and speed conditions.

LUFTDRUCK PRESSURE PRESSION PRESIÓN
für kalte Reifen for cold tires des pneus froids de Inflado

100 kPa = 1 bar

	kPa	psi	kPa	psi
195/55 R16	230	33	250	36
215/45 R17	250	36	270	39
215/40 R18	250	36	270	39

Warme Reifen bis: + 30 kPa + 4 psi
Warm tires up to: + 30 kPa + 4 psi

Pneus échauffés jusqu'à: Neumáticos calientes hasta:

P40.00-2183-31

Example: tire pressure table with tire dimensions

If a tire size precedes a tire pressure, the tire pressure information following is only valid for that tire size. The load conditions "partially laden" and "fully laden" are defined in the table for different numbers of occupants and amounts of luggage. The actual number of seats may differ.

Luftdruck für kalte Reifen
Tire pressure cold tires
Pression des pneus froids
Presión de inflado

100 kPa = 1 bar

	kPa	psi	kPa	psi
R18	250	36	270	39
R19	250	36	270	39

bis up to 240 km/h
hasta 150 mph

Wintereif bis: Winter tires
Neumáticos de invierno: + 30 kPa + 4 psi

Warme Reifen bis: Pneu échauffés jusqu'à:
Warm tires up to: Neumáticos calientes hasta: + 30 kPa + 4 psi

A 2 12 584 02 17

P40.00-2184-31

Some tire pressure tables show only the rim diameters instead of the full tire size, e.g. **R18**. The rim diameter is part of the tire size and can be found on the tire sidewall (▷ page 184).

If the tire pressures have been set to the lower values for lighter loads and/or lower road speeds, the pressures should be reset to the higher values:

- if you want to drive with an increased load and/or
 - if you want to drive at higher road speeds.
- i** The tire pressures for increased loads and/or higher road speeds, shown in the tire pressure table, may have a negative effect on driving comfort.

If the tire pressure is not set correctly, this can lead to an excessive build up of heat and a sudden loss of pressure.

For more information, contact a qualified specialist workshop.

Important notes on tire pressure

⚠ WARNING

If the tire pressure drops repeatedly, the wheel, valve or tire may be damaged. Tire pressure that is too low may result in a tire blow-out. There is a risk of an accident.

- Check the tire for foreign objects.
- Check whether the wheel is losing air or the valve is leaking.

If you are unable to rectify the damage, contact a qualified specialist workshop.

⚠ WARNING

If you fit unsuitable accessories onto tire valves, the tire valves may be overloaded and malfunction, which can cause tire pressure loss. Due to their design, retrofitted tire pressure monitors keep the tire valve open. This can also result in tire pressure loss. There is a risk of an accident.

Only screw the standard valve cap or other valve caps approved by Mercedes-Benz for your vehicle onto the tire valve.

Use a suitable pressure gauge to check the tire pressure. The outer appearance of a tire does not permit any reliable conclusion about the tire pressure. On vehicles equipped with the electronic tire pressure monitor, the tire pressure can be checked in the on-board computer.

The tire temperature and pressure increase when the vehicle is in motion. This is dependent on the driving speed and the load. Therefore, you should only correct tire pressures when the tires are cold.

The tires are cold:

- if the vehicle has been parked with the tires out of direct sunlight for at least three hours and
- if the vehicle has not been driven further than 1 mile (1.6 km)

The tire temperature changes depending on the outside temperature, the vehicle speed

and the tire load. If the tire temperature changes by 18 °F (10 °C), the tire pressure changes by approximately 10 kPa (0.1 bar/ 1.5 psi). Take this into account when checking the pressure of warm tires. Only correct the tire pressure if it is too low for the current operating conditions. If you check the tire pressure when the tires are warm, the resulting value will be higher than if the tires were cold. This is normal. Do not reduce the tire pressure to the value specified for cold tires. The tire pressure would otherwise be too low.

Observe the recommended tire pressures for cold tires:

- on the Tire and Loading Information placard on the B-pillar on the driver's side
- in the tire pressure table in the fuel filler flap (▷ page 96).

>> Wheels and tires.

Underinflated or overinflated tires

WARNING

Tires with pressure that is too low can overheat and burst as a consequence. In addition, they also suffer from excessive and/or irregular wear, which can severely impair the braking properties and the driving characteristics. There is a risk of an accident.

Avoid tire pressures that are too low in all the tires, including the spare wheel.

Underinflated tires

Underinflated tires may:

- overheat, leading to tire defects
- adversely affect handling
- wear excessively and/or unevenly
- have an adverse effect on fuel consumption

WARNING

Tires with excessively high pressure can burst because they are damaged more easily by road debris, potholes etc. In addition, they also suffer from irregular wear, which can severely impair the braking properties and the driving characteristics. There is a risk of an accident.

Avoid tire pressures that are too high in all the tires, including the spare wheel.

Overinflated tires

Overinflated tires may:

- increase the braking distance
- adversely affect handling
- wear excessively and/or unevenly
- have an adverse effect on ride comfort
- be more susceptible to damage

Maximum tire pressures



- ① Example: maximum permissible tire pressure

Never exceed the maximum permissible tire inflation pressure. Always observe the recommended tire pressure for your vehicle when adjusting the tire pressure (▷ page 174).

-  The actual values for tires are vehicle-specific and may deviate from the values in the illustration.

Checking the tire pressures

Important safety notes

Observe the notes on tire pressure (▷ page 174).

Information on air pressure for the tires on your vehicle can be found:

- on the vehicle's Tire and Loading Information placard on the B-pillar
- in the tire pressure table in the fuel filler flap (▷ page 96)
- in the "Tire pressure" section

Checking tire pressures manually

To determine and set the correct tire pressure, proceed as follows:

- ▶ Remove the valve cap of the tire that is to be checked.
- ▶ Press the tire pressure gauge securely onto the valve.
- ▶ Read the tire pressure and compare it with the recommended value on the Tire and Loading Information placard (▷ page 174).
- ▶ If the tire pressure is too low increase the tire pressure to the recommended value.
- ▶ If the tire pressure is too high, release air. To do this, press down the metal pin in the valve using the tip of a pen, for example. Then check the tire pressure again using the tire pressure checker.
- ▶ Screw the valve cap onto the valve.
- ▶ Repeat these steps for the other tires.

Tire pressure monitor

General notes

- i** This function is only available in the USA.

If a tire pressure monitor is installed, the vehicle's wheels have sensors that monitor the tire pressures in all four tires. The tire pressure monitor warns you if the pressure drops in one or more of the tires. The tire pressure monitor only functions if the corresponding sensors are fitted to all wheels.

Important safety notes

WARNING

Each tire, including the spare (if provided), should be checked at least once every two weeks when cold and inflated to the pressure recommended by the vehicle manufacturer on the Tire and Loading Information placard on the driver's door B-pillar or the tire pressure label on the inside of the fuel filler flap. If your vehicle has tires of a different size than the size indicated on the Tire and Loading Information placard or, if available, the tire pressure

label, you should determine the proper tire pressure for those tires.

As an added safety feature, your vehicle has been equipped with a tire pressure monitoring system (TPMS) that illuminates a low tire pressure telltale when one or more of your tires are significantly underinflated. Accordingly, when the low tire pressure telltale lights up, you should stop and check your tires as soon as possible, and inflate them to the proper pressure. Driving on a significantly underinflated tire causes the tire to overheat and can lead to tire failure.

Underinflation also reduces fuel efficiency and tire tread life, and may affect the vehicle's handling and stopping ability. Please note that the TPMS is not a substitute for proper tire maintenance, and it is the driver's responsibility to maintain correct tire pressure, even if underinflation has not reached the level to trigger illumination of the TPMS low tire pressure telltale.

Your vehicle has also been equipped with a TPMS malfunction indicator to indicate when the system is not operating properly. The TPMS malfunction indicator is combined with the low tire pressure telltale. When the system detects a malfunction, the warning lamp will flash for approximately a minute and then remain continuously illuminated. This sequence will be repeated every time the vehicle is started as long as the malfunction exists. When the malfunction indicator is illuminated, the system may not be able to detect or signal low tire pressure as intended.

TPMS malfunctions may occur for a variety of reasons, including the installation of incompatible replacement or alternate tires or wheels on the vehicle that prevent the TPMS from functioning properly. Always check the TPMS malfunction telltale after replacing one or more tires or wheels on your vehicle to ensure that the replacement

or alternate Tires and wheels allow the TPMS to continue to function properly.

It is the driver's responsibility to set the tire pressure to that recommended for cold tires which is suitable for the operating situation (▷ page 174). Note that the correct tire pressure for the current operating situation must first be taught-in to the tire pressure monitor. If there is a substantial loss of pressure, the warning threshold for the warning message is aligned to the reference values taught-in. Restart the tire pressure monitor after adjusting to the cold tire pressure. The current pressures are saved as new reference values. As a result, a warning message will appear if the tire pressure drops significantly.

The tire pressure monitor does not warn you of an incorrectly set tire pressure. Observe the notes on the recommended tire pressure (▷ page 174).

The tire pressure monitor is not able to warn you of a sudden loss of pressure, e.g. if the tire is penetrated by a foreign object. In the event of a sudden loss of pressure, bring the vehicle to a halt by braking carefully. Avoid abrupt steering maneuvers.

The tire pressure monitor has a yellow warning lamp in the instrument cluster for indicating a pressure loss or malfunction.

Whether the warning lamp flashes or lights up indicates whether a tire pressure is too low or the tire pressure monitor is malfunctioning:

- If the warning lamp is lit continuously, the tire pressure on one or more tires is significantly too low. The tire pressure monitor is not malfunctioning.
- If the warning lamp flashes for around a minute and then remains lit constantly, the tire pressure monitor is malfunctioning.

i A message appears in the display in addition to the warning lamp.

Observe the information on display messages (▷ page 122).

If the tire pressure monitor is malfunctioning, it may take up to ten minutes for the tire pressure warning lamp to inform you of the malfunction. The malfunction will be indicated first by the tire pressure warning lamp flashing for approximately one minute and

then remaining lit. When the malfunction has been rectified, the tire pressure warning lamp goes out after a few minutes of driving.

The operation of the tire pressure monitor can be affected by interference from radio transmitting equipment (e.g. radio headphones, two-way radios) that may be being operated in or near the vehicle.

Tire pressure monitor warning messages

If the tire pressure monitor detects a pressure loss in one or more tires, a warning message is shown in the display. The yellow warning light in the tire pressure monitor lights up. For certain display messages a warning tone also sounds.

- If the **Correct Tire Pressure** message appears in the display, the tire pressure in at least one tire is too low. Correct the tire pressure at the next opportunity.
- If the **Tire Pressure Warning Tire Failure** message appears in the display, the tire pressure in one or more tires has dropped suddenly and the tires must be checked.

Observe the instructions and safety notes for the display messages in the "Tires" section (▷ page 122) and the indicator and warning lamps in the instrument cluster in the "Tires" section (▷ page 135).

Restarting the tire pressure monitor

When you restart the tire pressure monitor, all existing warning messages are deleted and the warning lamps go out. The monitor uses the currently set tire pressures as the reference values for monitoring. In most cases, the tire pressure monitor will automatically detect the new reference values after you have changed the tire pressure. However, you can also define reference values manually as described here. The tire pressure monitor then monitors the new tire pressure values.







- ▶ Set the tire pressure to the value recommended for the corresponding driving situation on the Tire and Loading Information placard on the B-pillar on the driver's side (▷ page 174).

Additional tire pressure values for different loads can also be found on the tire





pressure table on the inside of the fuel filler flap (> page 174).

- ▶ Make sure that the tire pressure is correct on all four wheels.

On-board computer with a color display

- ▶ **To restart the tire pressure monitor:** press the  or  button on the steering wheel to select the **Settings** menu and press  on the steering wheel to confirm.
- ▶ Press the  or  button to select the **Tire Pressure Monitor** submenu and confirm with . The **Tire Pressure Monitor Use Current Pressures As New Reference Values?** message appears in the display.



If you wish to confirm the restart:

- ▶ Press the  or  button to select **yes** and press the  button to confirm. The **Tire Pressure Monitor Restarted** message appears in the display.
- ▶ Press  to confirm.

After a short while, the message is also hidden without pressing the  button. After driving for a few minutes, the system checks whether the current tire pressures are within the specified range. The new tire pressures are then accepted as reference values and monitored.

- i** If the **Tire Pressure Monitor Restarted** message does not appear after approximately 5 seconds, the restart was not successful. If this occurs, repeat the restart.

If you wish to cancel the restart:

- ▶ Press the  or  button to select **no** and press the  button to confirm. The tire pressure values stored at the last restart will continue to be monitored.

Radio type approval for the tire pressure monitor

Country	Radio type approval number
USA	FCC ID: MRXMW2433A FCC ID: MRXGG4 FCC ID: MRXMC34MA4
Canada	IC: 2546A-MW2433A IC: 2546A-GG4 IC: 2546A-MC34MA4

Loading the vehicle

Instruction labels for tires and loads

WARNING

Overloaded tires can overheat, causing a blowout. Overloaded tires can also impair the steering and driving characteristics and lead to brake failure. There is a risk of accident.

Observe the load rating of the tires. The load rating must be at least half of the GAWR of your vehicle. Never overload the tires by exceeding the maximum load.

Two instruction labels on your vehicle show the maximum possible load.

- (1) The Tire and Loading Information placard is on the B-pillar on the driver's side. The Tire and Loading Information placard shows the maximum permissible number of occupants and the maximum permissible vehicle load. It also contains details of the tire sizes and corresponding pressures for tires mounted at the factory.
- (2) The vehicle identification plate is on the B-pillar on the driver's side. The vehicle identification plate informs you of the gross vehicle weight rating. It is made up of the vehicle weight, all vehicle occupants, the fuel and the cargo. You can also find information about the maximum gross axle weight rating on the front and rear axle.

The maximum gross axle weight rating is the maximum weight that can be carried by one axle (front or rear axle). Never

exceed the maximum load or the maximum gross axle weight rating for the front or rear axle.

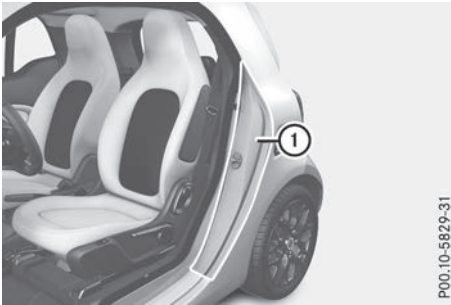

① B-pillar, driver's side

P00.10-5829-31

Maximum permissible gross vehicle weight rating

TIRE RENSEIGNEMENTS		LOADING INFORMATION	
SUR LES PNEUS ET LE CHARGEMENT		SUR LES PNEUS ET LE CHARGEMENT	
SEATING CAPACITY NOMBRE DE PLACES	TOTAL	FRONT AVANT	MIDDLE MILIEU
REAR ARRIERE	2	2	2
The combined weight of occupants and cargo should never exceed XXX kg or XXX lbs.* Le poids total des occupants et du chargement ne doit jamais dépasser XXX kg ou XXX lbs.*			
TIRE PNEU	SIZE DIMENSIONS	COLD TIRE PRESSURE PRESSION DES PNEUS A FROID	
FRONT AVANT	255/40 ZR18 99Y XL	200 KPA, 29 PSI	
REAR ARRIERE	285/35 ZR18 101Y XL	200 KPA, 29 PSI	
SPARE DE SECOURS	175/55-18 95P	420 KPA, 60 PSI	

P40.00-2224-31

- Specification for maximum gross vehicle weight ① is listed in the Tire and Loading Information placard: "The combined weight of occupants and cargo should never exceed XXX kilograms or XXX lbs."

The gross weight of all vehicle occupants, load and luggage must not exceed the specified value.

- ① The specifications shown on the Tire and Loading Information placard in the illustration are examples. The maximum permissible gross vehicle weight rating is vehicle-specific and may differ from that in the illustration. You can find the valid maximum permissible gross vehicle weight rating for your vehicle on the Tire and Loading Information placard.

Number of seats

TIRE RENSEIGNEMENTS		LOADING INFORMATION	
SUR LES PNEUS ET LE CHARGEMENT		SUR LES PNEUS ET LE CHARGEMENT	
SEATING CAPACITY NOMBRE DE PLACES	TOTAL	FRONT AVANT	MIDDLE MILIEU
REAR ARRIERE	2	2	2
The combined weight of occupants and cargo should never exceed XXX kg or XXX lbs.* Le poids total des occupants et du chargement ne doit jamais dépasser XXX kg ou XXX lbs.*			
TIRE PNEU	SIZE DIMENSIONS	COLD TIRE PRESSURE PRESSION DES PNEUS A FROID	
FRONT AVANT	255/40 ZR18 99Y XL	200 KPA, 29 PSI	
REAR ARRIERE	285/35 ZR18 101Y XL	200 KPA, 29 PSI	
SPARE DE SECOURS	175/55-18 95P	420 KPA, 60 PSI	

P40.00-2225-31

Maximum number of seats ① indicates the maximum number of occupants allowed to travel in the vehicle. This information can be found on the Tire and Loading Information placard.

- ① The specifications shown on the Tire and Loading Information placard in the illustration are examples. The number of seats is vehicle-specific and can differ from the details shown. The number of seats in your vehicle can be found on the Tire and Loading Information placard.

Determining the correct load limit

Step-by-step instructions

The following steps have been developed as required of all manufacturers under Title 49, Code of U.S. Federal Regulations, Part 575 pursuant to the "National Traffic and Motor Vehicle Safety Act of 1966".

- **Step 1:** Locate the statement "The combined weight of occupants and cargo should never exceed XXX kg or XXX lbs." on your vehicle's Tire and Loading Information placard.
- **Step 2:** Determine the combined weight of the driver and passengers that will be riding in your vehicle.
- **Step 3:** Subtract the combined weight of the driver and passengers from XXX kilograms or XXX lbs.
- **Step 4:** The resulting figure equals the available amount of cargo and luggage load capacity. For example: at a sum "XXX" of 1400 lbs and five occupants each weighing 150 lbs, the amount of available cargo and

luggage load capacity is 650 lbs (1400 - 750 (5 x 150) = 650 lbs).

- **Step 5:** Determine the combined weight of luggage and cargo being loaded on the

vehicle. That weight may not safely exceed the available cargo and luggage load capacity calculated in step 4.

Example: steps 1 to 3

The following table shows examples on how to calculate total and cargo load capacities with varying seating configurations and number and size of occupants. The following examples use a load limit of 1500 lbs (680 kg). **This is for illustration purposes only.** Make sure you are using the actual load limit for your vehicle stated on your vehicle's Tire and Loading Information placard (▷ page 179).

The greater the combined weight of the occupants, the lower the maximum luggage load.

Step 1

	Example 1	Example 2	Example 3
Combined maximum weight of occupants and cargo (data from the Tire and Loading Information placard)	1500 lbs (680 kg)	1500 lbs (680 kg)	1500 lbs (680 kg)

Step 2

	Example 1	Example 2	Example 3
Number of people in the vehicle (driver and occupants)	5	3	1
Distribution of the occupants	Front: 2 Rear: 3	Front: 1 Rear: 2	Front: 1
Weight of the occupants	Occupant 1: 150 lbs (68 kg) Occupant 2: 180 lbs (82 kg) Occupant 3: 160 lbs (73 kg) Occupant 4: 140 lbs (63 kg) Occupant 5: 120 lbs (54 kg)	Occupant 1: 200 lbs (91 kg) Occupant 2: 190 lbs (86 kg) Occupant 3: 150 lbs (68 kg)	Occupant 1: 150 lbs (68 kg)
Gross weight of all occupants	750 lbs (340 kg)	540 lbs (245 kg)	150 lbs (68 kg)

Step 3

	Example 1	Example 2	Example 3
Permissible load (maximum gross vehicle weight rating from the Tire and Loading Information placard minus the gross weight of all occupants)	1500 lbs (680 kg) -750 lbs (340 kg) = 750 lbs (340 kg)	1500 lbs (680 kg) -540 lbs (245 kg) = 960 lbs (435 kg)	1500 lbs (680 kg) -150 lbs (68 kg) = 1350 lbs (612 kg)

Vehicle identification plate

Even if you have calculated the total cargo carefully, you should still make sure that the gross vehicle weight rating and the gross axle weight rating are not exceeded. Details can be found on the vehicle identification plate on the B-pillar on the driver's side of the vehicle (▷ page 179).

Permissible gross vehicle weight: the gross weight of the vehicle, all passengers, load and trailer load/noseweight (if applicable) must not exceed the permissible gross vehicle weight.

Gross axle weight rating: the maximum permissible weight that can be carried by one axle (front or rear axle).

To ensure that your vehicle does not exceed the maximum permissible values (gross vehicle weight and maximum gross axle weight rating), have your loaded vehicle (including driver, occupants, cargo, and full trailer load if applicable) weighed on a suitable vehicle weighbridge.

>> Wheels and tires.

All about wheels and tires

Uniform Tire Quality Grading Standards

Overview of Tire Quality Grading Standards

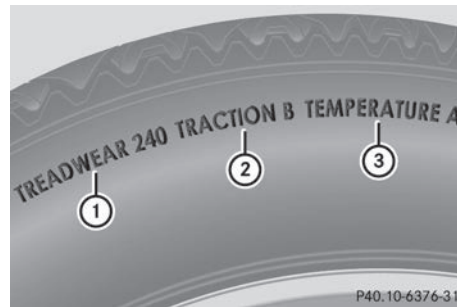

Uniform Tire Quality Grading Standards are U.S. government specifications. Their purpose is to provide drivers with uniform reliable information on tire performance data. Tire manufacturers have to grade tires using three performance factors: ① tread wear grade, ② traction grade and ③ temperature grade. These regulations do not apply to Canada. Nevertheless, all tires sold in North America are provided with the corresponding quality grading markings on the sidewall of the tire.

Quality grades can be found, where applicable, on the tire sidewall between the tread shoulder and maximum tire width.

Example:

- **Treadwear grade:** 200
- **Traction grade:** AA
- **Temperature grade:** A

All passenger car tires must conform to the statutory safety requirements in addition to these grades.

- i** The actual values for tires are vehicle-specific and may deviate from the values in the illustration.

Treadwear

The treadwear grade is a comparative rating based on the wear rate of the tire when tested under controlled conditions on a specified U.S. government course. For example, a tire graded 150 would wear one and one-half times as well on the government test track as a tire graded 100.

The relative performance of tires depends upon the actual conditions of their use, however, and may depart significantly from the norm due to variations in driving habits, service practices and differences in road characteristics and climate conditions.

Traction

WARNING

The traction grade assigned to this tire is based on straight-ahead braking traction tests, and does not include acceleration, cornering, hydroplaning, or peak traction characteristics.

- !** Avoid wheelspin. This can lead to damage to the drive train.

The traction grades – from highest to lowest – are AA, A, B and C. Those grades represent the tire's ability to stop on wet pavement as measured under controlled conditions on specified government test surfaces of asphalt and concrete. A tire marked C may have poor traction performance.

The safe speed on a wet, snow covered or icy road is always lower than on dry road surfaces.

You should pay special attention to road conditions when temperatures are around freezing point.

smart recommends a minimum tread depth of $\frac{1}{8}$ in (4 mm) on all four winter tires. Observe the legally required minimum tire tread depth (▷ page 172). Winter tires can reduce the braking distance on snow-covered surfa-

ces in comparison with summer tires. The braking distance is still much further than on surfaces that are not icy or covered with snow. Take appropriate care when driving.

Further information on winter tires (M+S tires) (▷ page 173).

Temperature

WARNING

The temperature grade for this tire is established for a tire that is properly inflated and not overloaded. Excessive speed, underinflation, or excessive loading, either separately or in combination, can cause excessive heat build-up and possible tire failure.

The temperature grades are A (the highest), B and C. They represent the tire's resistance to the generation of heat and its ability to dissipate heat when tested under controlled conditions on a specified indoor laboratory test wheel. Sustained high temperature can cause the material of the tire to degenerate and reduce tire life, and excessive temperature can lead to sudden tire failure. The grade C corresponds to a level of performance which all passenger car tires must meet under the Federal Motor Vehicle Safety Standard No. 109. Grades B and A represent higher levels of performance on the laboratory test wheel than the minimum required by law.

Tire labeling

Overview of tire labeling

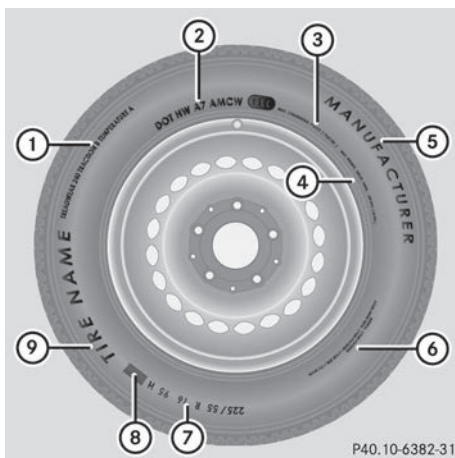

- ① Uniform Tire Quality Grading Standard (▷ page 187)
- ② DOT, Tire Identification Number (▷ page 186)
- ③ Maximum tire load (▷ page 186)
- ④ Maximum tire pressure (▷ page 176)
- ⑤ Manufacturer
- ⑥ Tire material (▷ page 187)
- ⑦ Tire size designation, load-bearing capacity and speed rating (▷ page 184)
- ⑧ Load index (▷ page 186)
- ⑨ Tire name

The markings described above are on the tire in addition to the tire name (sales designation) and the manufacturer's name.

- i** Tire data is vehicle-specific and may deviate from the data in the example.

Tire size designation, load-bearing capacity and speed rating

⚠ WARNING

Exceeding the stated tire load-bearing capacity and the approved maximum speed could lead to tire damage or the tire bursting. There is a risk of accident.

Therefore, only use tire types and sizes approved for your vehicle model. Observe

the tire load rating and speed rating required for your vehicle.

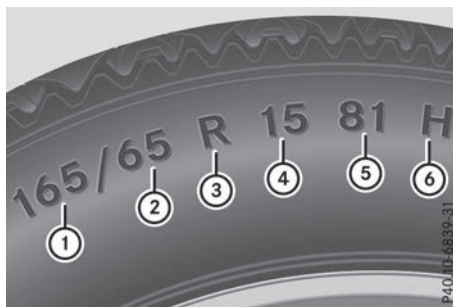

- ① Tire width
- ② Nominal aspect ratio in %
- ③ Tire code
- ④ Rim diameter
- ⑤ Load bearing index
- ⑥ Speed rating

General: depending on the manufacturer's standards, the size imprinted in the tire wall may not contain any letters or may contain one letter that precedes the size description.

If there is no letter preceding the size description (as shown above): these are passenger vehicle tires according to European manufacturing standards.

If "P" precedes the size description: these are passenger vehicle tires according to U.S. manufacturing standards.

If "LT" precedes the size description: these are light truck tires according to U.S. manufacturing standards.

If "T" precedes the size description: compact emergency wheels with high tire pressure that are only designed for temporary use in an emergency.

Tire width: tire width ① shows the nominal tire width in millimeters.

Height-width ratio: aspect ratio ② is the size ratio between the tire height and tire width and is shown in percent. The aspect ratio is calculated by dividing the tire width by the tire height.

Tire code: tire code ③ specifies the tire type. "R" represents radial tires; "D" represents diagonal tires; "B" represents diagonal radial tires.

Optionally, tires with a maximum speed of over 149 mph (240 km/h) may have "ZR" in the size description, depending on the manufacturer (e.g. 245/40 ZR 18).

Rim diameter: rim diameter ④ is the diameter of the bead seat, not the diameter of the rim flange. The rim diameter is specified in inches (in).

Load-bearing index: load-bearing index ⑤ is a numerical code that specifies the maximum load-bearing capacity of a tire.

Do not overload the tires by exceeding the specified load limit. The maximum permissible load can be found on the vehicle's Tire and Loading Information placard on the B-pillar on the driver's side (▷ page 179).

Example:

Load-bearing index 91 indicates a maximum load of 1,356 lb (615 kg) that the tires can bear. For further information on the maximum tire load in kilograms and lbs, see (▷ page 186). For further information on the load bearing index, see "Load index" (▷ page 186).

Speed rating: speed rating ⑥ specifies the approved maximum speed of the tire.

- i** Tire data is vehicle-specific and may deviate from the data in the example.

Regardless of the speed rating, always observe the speed limits. Drive carefully and adapt your driving style to the traffic conditions.

Summer tires

Index	Speed rating
Q	up to 100 mph (160 km/h)
R	up to 106 mph (170 km/h)
S	up to 112 mph (180 km/h)
T	up to 118 mph (190 km/h)
H	up to 130 mph (210 km/h)
V	up to 149 mph (240 km/h)
W	up to 168 mph (270 km/h)
Y	up to 186 mph (300 km/h)
ZR...Y	up to 186 mph (300 km/h)

Index	Speed rating
ZR...(.Y)	over 186 mph (300 km/h)
ZR	over 149 mph (240 km/h)

- Optionally, tires with a maximum speed of over 149 mph (240 km/h) may have "ZR" in the size description, depending on the manufacturer (e.g. 245/40 ZR18).

The service specification is made up of load-bearing index ⑤ and speed rating ⑥.

- If the size description of your tire includes "ZR" and there are no service specifications, ask the tire manufacturer in order to find out the maximum speed.

If a service specification is available, the maximum speed is limited according to the speed rating in the service specification. Example: 245/40 ZR18 97 Y. In this example, "97 Y" is the service specification. The letter "Y" represents the speed rating. The maximum speed of the tire is limited to 186 mph (300 km/h).

- The size description for all tires with maximum speeds of over 186 mph (300 km/h) must include "ZR", **and** the service specification must be given in parentheses. Example: 275/40 ZR 18 (99 Y). Speed rating "(Y)" indicates that the maximum speed of the tire is over 186 mph (300 km/h). Ask the tire manufacturer about the maximum speed.

All-weather tires and winter tires

Index	Speed rating
Q M+S ²	up to 100 mph (160 km/h)
T M+S ²	up to 118 mph (190 km/h)
H M+S ²	up to 130 mph (210 km/h)
V M+S ²	up to 149 mph (240 km/h)

- i** Not all tires with the M+S marking provide the driving characteristics of winter tires. In addition to the M+S marking, winter tires also have the  snowflake symbol on the tire wall. Tires with this marking fulfill the requirements of the Rubber Manufacturers Association (RMA) and the

² Or M+S  for winter tires.

Rubber Association of Canada (RAC) regarding the tire traction on snow. They have been especially developed for driving on snow.

An electronic speed limiter prevents your vehicle from exceeding a speed of 130 mph (210 km/h).

The speed rating of tires mounted at the factory may be higher than the maximum speed that the electronic speed limiter permits.

Make sure that your tires have the required speed rating, e.g. when buying new tires. The required speed rating for your vehicle can be found in the "Tires" section (▷ page 193).

Further information about reading tire data can be obtained from any qualified specialist workshop.

Load index



In addition to the load-bearing index, load rating ① may also be imprinted on the sidewall of the tire. This is located after the letters that identify the speed rating (▷ page 184).

- If no specification is given: no text (as in the example above), represents a standard load (SL) tire
- XL or Extra Load: represents a reinforced tire
- Light Load: represents a light load tire
- C, D, E: represents a load range that depends on the maximum load that the tire can carry at a certain pressure

i Tire data is vehicle-specific and may deviate from the data in the example.

Maximum load rating



Maximum tire load ① is the maximum permissible weight for which the tire is approved.

Do not overload the tires by exceeding the specified load limit. The maximum permissible load can be found on the vehicle's Tire and Loading Information placard on the B-pillar on the driver's side (▷ page 179).

i The actual values for tires are vehicle-specific and may deviate from the values in the illustration.

DOT, Tire Identification Number (TIN)

U.S. tire regulations prescribe that every tire manufacturer or retreader must imprint a TIN in or on the sidewall of every tire produced.

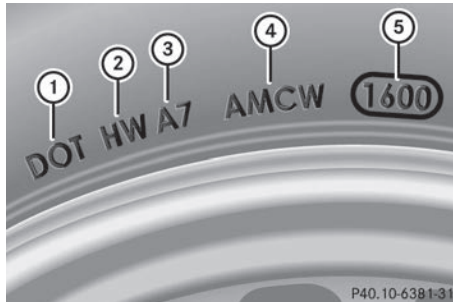

The TIN is a unique identification number. The TIN enables the tire manufacturers or retreaders to inform purchasers of recalls and other safety-relevant matters. It makes it possible for the purchaser to easily identify the affected tires.

The TIN is made up of manufacturer identification code ②, tire size ③, tire type code ④ and manufacturing date ⑤.

DOT (Department of Transportation): tire symbol ① indicates that the tire complies with the requirements of the U.S. Department of Transportation.

Manufacturer identification code: manufacturer identification code ② provides details on the tire manufacturer. New tires have a code with two symbols. Retreaded tires have a code with four symbols.

For further information about retreaded tires, see (▷ page 193).

Tire size: identifier ③ describes the tire size.

Tire type code: tire type code ④ can be used by the manufacturer as a code to describe specific characteristics of the tire.

Date of manufacture: date of manufacture ⑤ provides information about the age of a tire. The first and second positions represent the week of manufacture, starting with "01" for the first calendar week. Positions three and four represent the year of manufacture. For example, a tire that is marked with "3208", was manufactured in week 32 in 2008.

- ① Tire data is vehicle-specific and may deviate from the data in the example.

Tire characteristics

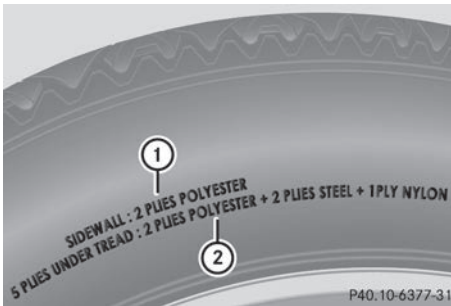

This information describes the type of tire cord and the number of layers in sidewall ① and under tire tread ②.

- ① Tire data is vehicle-specific and may deviate from the data in the example.

Definition of terms for tires and loading

Tire ply composition and material used

Describes the number of plies or the number of layers of rubber-coated fabric in the tire tread and sidewall. These are made of steel, nylon, polyester and other materials.

Bar

Metric unit for tire pressure. 14.5038 pounds per square inch (psi) and 100 kilopascals (kPa) are the equivalent of 1 bar.

DOT (Department of Transportation)

DOT marked tires fulfill the requirements of the United States Department of Transportation.

Normal occupant weight

The number of occupants for which the vehicle is designed multiplied by 68 kilograms (150 lbs).

Uniform Tire Quality Grading Standards

A uniform standard to grade the quality of tires with regards to tread quality, tire traction and temperature characteristics. The quality grading assessment is made by the manufacturer following specifications from the U.S. government. The ratings are molded into the sidewall of the tire.

Recommended tire pressures

The recommended tire pressure applies to the tires mounted at the factory.

The Tire and Loading Information placard contains the recommended tire pressures for cold tires on a fully loaded vehicle and for the maximum permissible vehicle speed.

The tire pressure table contains the recommended pressures for cold tires for various operating conditions, i.e. differing load and speed conditions.

Increased vehicle weight due to optional equipment

The combined weight of all standard and optional equipment available for the vehicle, regardless of whether it is actually installed on the vehicle or not.

Rim

This is the part of the wheel on which the tire is mounted.

GAWR (Gross Axle Weight Rating)

The GAWR is the maximum gross axle weight rating. The actual load on an axle must never exceed the gross axle weight rating. The gross axle weight rating can be found on the vehicle identification plate on the B-pillar on the driver's side.

Speed rating

The speed rating is part of the tire identification. It specifies the speed range for which the tire is approved.

GVW (Gross Vehicle Weight)

The gross vehicle weight includes the weight of the vehicle including fuel, tools, the spare wheel, accessories installed, occupants, luggage and the drawbar noseweight, if applicable. The gross vehicle weight must not exceed the gross vehicle weight rating GVWR as specified on the vehicle identification plate on the B-pillar on the driver's side.

GVWR (Gross Vehicle Weight Rating)

The GVWR is the maximum permissible gross weight of a fully loaded vehicle (the weight of the vehicle including all accessories, occupants, fuel, luggage and the drawbar noseweight, if applicable). The gross vehicle weight rating is specified on the vehicle identification plate on the B-pillar on the driver's side.

Maximum loaded vehicle weight

The maximum weight is the sum of:

- the curb weight of the vehicle
- the weight of the accessories
- the load limit
- the weight of the factory installed optional equipment

Kilopascal (kPa)

Metric unit for tire pressure. 6.9 kPa corresponds to 1 psi. Another unit for tire pressure is bar. 100 kilopascals (kPa) are the equivalent of 1 bar.

Load index

In addition to the load-bearing index, the load index may also be imprinted on the sidewall of the tire. This specifies the load-bearing capacity more precisely.

Curb weight

The weight of a vehicle with standard equipment including the maximum capacity of fuel, oil and coolant. It also includes the air-conditioning system and optional equipment if these are installed in the vehicle, but does not include passengers or luggage.

Maximum load rating

The maximum load rating is the maximum permissible weight in kilograms or pounds for which a tire is approved.

Maximum permissible tire pressure

Maximum permissible tire pressure for one tire.

Maximum load on one tire

Maximum load on one tire. This is calculated by dividing the maximum axle load of one axle by two.

PSI (pounds per square inch)

A standard unit of measure for tire pressure.

Aspect ratio

Relationship between tire height and tire width in percent.

Tire pressure

This is pressure inside the tire applying an outward force to each square inch of the tire's surface. The tire pressure is specified in pounds per square inch (psi), in kilopascal (kPa) or in bar. The tire pressure should only be corrected when the tires are cold.

Cold tire pressure

The tires are cold:

- if the vehicle has been parked with the tires out of direct sunlight for at least three hours and
- if the vehicle has not been driven further than 1 mile (1.6 km)

Tread

The part of the tire that comes into contact with the road.

Bead

The tire bead ensures that the tire sits securely on the wheel. There are several steel wires in the bead to prevent the tire from coming loose from the wheel rim.

Sidewall

The part of the tire between the tread and the bead.

Weight of optional extras

The combined weight of those optional extras that weigh more than the replaced standard parts and more than 5 lbs (2.3 kilograms). These optional extras, such as high-performance brakes, level control, a roof rack or a high-performance battery, are not included in the curb weight and the weight of the accessories.

TIN (Tire Identification Number)

This is a unique identifier which can be used by a tire manufacturer to identify tires, for example for a product recall, and thus identify the purchasers. The TIN is made up of the manufacturer's identity code, tire size, tire type code and the manufacturing date.

Load bearing index

The load bearing index (also load index) is a code that contains the maximum load bearing capacity of a tire.

Traction

Traction is the result of friction between the tires and the road surface.

Treadwear indicators

Narrow bars (tread wear bars) that are distributed over the tire tread. If the tire tread is level with the bars, the wear limit of $\frac{1}{16}$ in (1.6 mm) has been reached.

Occupant distribution

The distribution of occupants in a vehicle at their designated seating positions.

Total load limit

Nominal load and luggage load plus 68 kg (150 lbs) multiplied by the number of seats in the vehicle.

Changing a wheel**Flat tire**

You can find information on what to do in the event of a flat tire in the "Flat tire" section (> page 156).

Rotating the wheels**⚠ WARNING**

Never interchange the front and rear wheels as they have different dimensions, e.g. size, wheel offset etc. Otherwise, there could be a negative effect on the road holding and you could endanger yourself or others.

❗ On vehicles equipped with a tire pressure monitor, electronic components are located in the wheel.

Tire-mounting tools should not be used near the valve. This could damage the electronic components.

Only have tires changed at a qualified specialist workshop.

Various types of steel wheel can be fitted on your vehicle. Some steel wheels have a red mark in the hub cap area. The hub cap has to be removed to see the red mark, see "Raising the vehicle" in the "Wheel change" section (> page 190). When changing the wheels, always fit wheels of the same type on all axles.

Always pay attention to the instructions and safety notes when changing a wheel (> page 189).

The wear patterns on the front and rear tires differ, depending on the operating conditions. Front tires typically wear more on the shoulders and the rear tires in the center.

Clean the contact surfaces of the wheel and the brake disc thoroughly every time a wheel is rotated. Check the tire pressure and reactivate the tire pressure monitor if necessary.

Direction of rotation

Tires with a specified direction of rotation have additional benefits, e.g. if there is a risk of hydroplaning. These advantages can only be gained if the tires are fitted corresponding to the direction of rotation.

An arrow on the sidewall of the tire indicates its correct direction of rotation.

Storing wheels

Store wheels that are not being used in a cool, dry and preferably dark place. Protect the tires from oil, grease, gasoline and diesel.

Mounting a wheel

Preparing the vehicle

- ▶ Make sure that you have the appropriate tire-changing tools. For further information inquire at any smart center.
- ▶ Stop the vehicle on solid, non-slippery and level ground.
- ▶ Apply the parking brake (▷ page 98).
- ▶ Bring the front wheels into the straight-ahead position.
- ▶ **Vehicles with automatic transmission:** shift the transmission to position **P**.
- ▶ **Vehicles with manual transmission:** depress the clutch pedal fully and engage first or reverse gear.
- ▶ Switch off the engine.
- ▶ Remove the SmartKey from the ignition lock.
- ▶ Also secure the vehicle against rolling away.

Securing the vehicle to prevent it from rolling away



P40.10-6521-31

- ▶ **On level ground:** place chocks or other suitable items under the front and rear of the wheel that is diagonally opposite the wheel you wish to change.



P40.10-6522-31

- ▶ **On light downhill gradients:** place chocks or other suitable items in front of the wheels of the front and rear axle.

Raising the vehicle

WARNING

If you do not position the jack correctly at the appropriate jacking point of the vehicle, the jack could tip over with the vehicle raised. There is a risk of injury.

Only position the jack at the appropriate jacking point of the vehicle. The base of the jack must be positioned vertically, directly under the jacking point of the vehicle.

Observe the following when raising the vehicle:

- make sure you have a suitable jack and wheel wrench. If used incorrectly, the jack could tip over with the vehicle raised. For further information inquire at any smart center.
- the jack is designed only to raise and hold the vehicle for a short time while a wheel is being changed. It is not suited for performing maintenance work under the vehicle.
- avoid changing the wheel on uphill and downhill slopes.
- before raising the vehicle, secure it from rolling away by applying the parking brake and inserting wheel chocks. Never disengage the parking brake while the vehicle is raised.
- the jack must be placed on a firm, flat and non-slip surface. On a loose surface, a large, flat load-bearing underlay must be used. On a slippery surface, a non-slip underlay must be used, e.g. rubber mats.
- do not use wooden blocks or similar objects as a jack underlay. Otherwise, the jack will not be able to achieve its load-bearing capacity due to the restricted height.
- make sure that the distance between the underside of the tires and the ground does not exceed 1.2 in (3 cm).
- never place your hands and feet under the raised vehicle.
- do not lie under the vehicle.
- do not start the engine when the vehicle is raised.
- do not open or close a door or the tailgate while the vehicle is raised.
- make sure that no persons are present in the vehicle when the vehicle is raised.

! The jack is designed exclusively for jacking up the vehicle at the jacking points. Otherwise, your vehicle could be damaged.

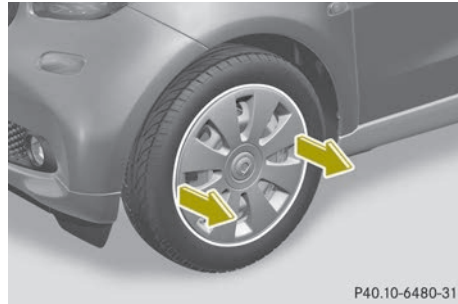

P40.10-6480-31

Steel wheel with hub cap

- **Vehicles with steel wheels and hub caps:** carefully reach into two of the hub cap openings and remove the hub cap.



P40.10-6481-31

Steel wheel with hub cap

- **Vehicles with steel wheels and hub caps:** remove the hub cap.

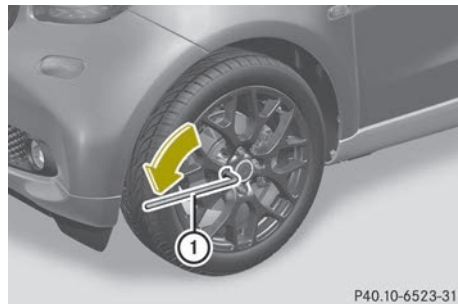

P40.10-6523-31

- Using wheel wrench ①, loosen the bolts on the wheel you wish to change by about one full turn. Do not unscrew the bolts completely.

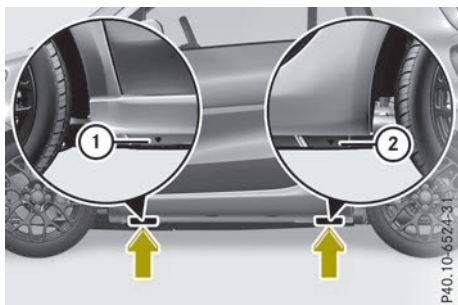

The vehicle may only be raised at the designated jacking points on the sill.

The jacking points are located just behind front wheel arches ① and just in front of rear wheel arches ②. You can identify the jacking points by the triangular indentations on the sill.

To avoid damage, position the jack centrally under the triangular indentations.

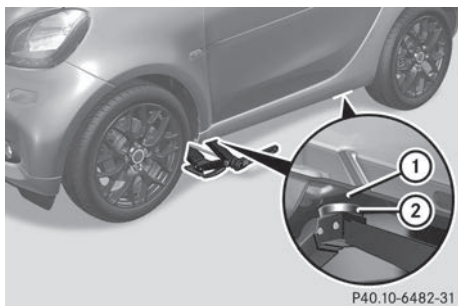

- Position jack ② centrally under the triangular indentations at the jacking points on the sill ①.

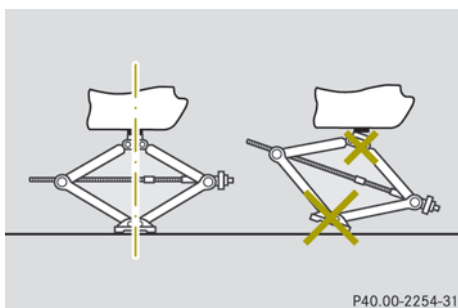

Example

- Make sure the foot of the jack is directly beneath the jacking point.

- Raise the vehicle with jack ② until the tire is a maximum of 1.2 in (3 centimeters) off the ground.

Removing a wheel

- ❗ Do not place wheel bolts in sand or on a dirty surface. The bolt and wheel hub threads could otherwise be damaged when you screw them in.

- Unscrew the wheel bolts.
- Remove the wheel.

Mounting a new wheel

⚠ WARNING

Oiled or greased wheel bolts or damaged wheel bolts/hub threads can cause the wheel bolts to come loose. As a result, you could lose a wheel while driving. There is a risk of accident.

Never oil or grease wheel bolts. In the event of damage to the threads, contact a qualified specialist workshop immediately. Have the damaged wheel bolts or hub threads replaced/renewed. Do not continue driving.

⚠ WARNING

If you tighten the wheel bolts or wheel nuts when the vehicle is raised, the jack could tip over. There is a risk of injury.

Only tighten the wheel bolts or wheel nuts when the vehicle is on the ground.

Always pay attention to the instructions and safety notes in the "Changing a wheel" section (> page 189).

Only use wheel bolts that are designed for the wheel and the vehicle. For safety reasons, smart recommends that you only use wheel bolts which have been approved for smart vehicles and the respective wheel.

- ❗ To prevent damage to the paintwork, hold the wheel securely against the wheel hub while screwing in the first wheel bolt.



- ▶ Clean the wheel and wheel hub contact surfaces.
- ▶ Place the new wheel on the wheel hub and push it on.
- ▶ Tighten the wheel bolts until they are finger-tight.

Lowering the vehicle

⚠ WARNING

The wheels could work loose if the wheel nuts and bolts are not tightened to the specified tightening torque. There is a risk of accident.

Have the tightening torque immediately checked at a qualified specialist workshop after a wheel is changed.

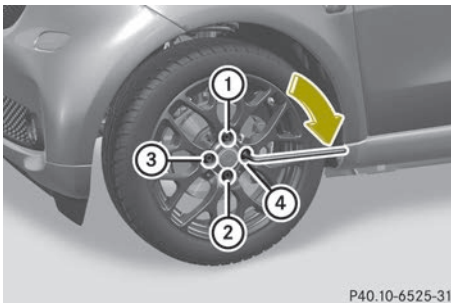

- ▶ Lower the vehicle until it is once again standing firmly on the ground.
- ▶ Place the jack to one side.
- ▶ Tighten the wheel bolts in the sequence indicated ① to ④.
Do this evenly in a crosswise pattern. The tightening torque must be **77 lb-ft (105 Nm)**.

- ▶ Check the tire pressure of the newly mounted wheel and adjust it if necessary. Observe the recommended tire pressure (▷ page 174).

i Vehicles with tire pressure monitor: all wheels mounted must be equipped with functioning sensors.

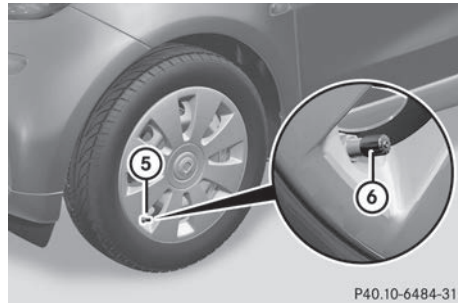

Steel wheel with hub cap

- ▶ **Vehicles with steel wheels and hub caps:** fit hub cap ⑤ so that tire valve ⑥ is not trapped.
- ▶ Press the hub cap ⑤ evenly onto the wheel with both hands.
- ▶ Check to make sure the hub cap ⑤ is seated safely on the wheel.
- ▶ **Vehicles with steel wheels and hub caps:** fit the hub cap.

Wheel and tire combinations

General notes

! For safety reasons, smart recommends that you only use tires and wheels which have been specifically approved by smart for your vehicle. These are specially adapted to the control systems, such as ABS or ESP®. Only use tires and wheels specifically tested and approved by smart. Certain characteristics, e.g. handling, vehicle noise emissions or fuel consumption, may otherwise be adversely affected. In addition, when driving with a load, dimensional variations and different tire deformation characteristics could cause the tires to make contact with the bodywork and axle components. This could result in damage to the tires or the vehicle.

>> Wheels and tires.

smart accepts no liability for damage resulting from the use of tires or wheels other than those tested and approved.

Information on wheels and tires can be obtained at a qualified specialist workshop, e.g. a smart center.

- !** Retreaded tires have not been tested by smart and are not recommended. Previous damage sustained by the tires (before the retreading process) cannot always be recognized. As a result, smart cannot guarantee vehicle safety if retreaded tires are fitted.

Overview of abbreviations used in the following tire tables:

- BA: both axles
- FA: front axle
- RA: rear axle

The recommended pressures for various operating conditions can be found:

- on the Tire and Loading Information placard with the recommended tire pressures on the B-pillar on the driver's side
- in the tire pressure table on the inside of the fuel filler flap

Observe the notes on recommended tire pressures under various operating conditions (▷ page 174).

Check tire pressures regularly, and only when the tires are cold. Comply with the mainte-

nance recommendations of the tire manufacturer in the vehicle document wallet.

Notes on the vehicle equipment – always equip the vehicle with:

- tires of the same size on a given axle (left/right)
- with the same type of tires on all wheels at a given time (summer tires, winter tires)
Exception: it is permissible to fit a different type or make in the event of a flat tire.

i The following pages contain information on approved wheel rim and tire sizes for equipping your vehicle with winter tires. Winter tires are not available at the factory as standard equipment or optional extras.

If you want to equip your vehicle with approved winter tires, it may be necessary to obtain wheel rims in the corresponding size. The size of the approved winter tires may differ from the standard tires. This is dependent on the model and the equipment installed at the factory.

The tires and wheel rims, as well as further information, can be obtained at a qualified specialist workshop.

i Not all wheel and tire combinations are available at the factory for all countries.

Tires**smart fortwo coupe 66 kW Turbo****All-weather tires****R 15**



Tires	Wheels
FA: 165/65 R15 81 T M+S RA: 185/60 R15 84 T M+S	Steel wheels: FA: 5.0 J x 15 H2 Wheel offset: 1.25 in (32 mm) RA: 5.5 J x 15 H2 Wheel offset: 1.65 in (42 mm) Light-alloy wheels: FA: 5.0 J x 15 CH Wheel offset: 1.25 in (32 mm) RA: 5.5 J x 15 CH Wheel offset: 1.65 in (42 mm)
FA: 165/65 R15 81 H M+S RA: 185/60 R15 84 H M+S	Steel wheels: FA: 5.0 J x 15 H2 Wheel offset: 1.25 in (32 mm) RA: 5.5 J x 15 H2 Wheel offset: 1.65 in (42 mm) Light-alloy wheels: FA: 5.0 J x 15 CH Wheel offset: 1.25 in (32 mm) RA: 5.5 J x 15 CH Wheel offset: 1.65 in (42 mm)

R 16

Tires	Wheels
FA: 185/50 R16 81 H M+S RA: 205/45 R16 83 H M+S	Light-alloy wheels: FA: 6.0 J x 16 CH Wheel offset: 1.73 in (44 mm) RA: 6.5 J x 16 CH Wheel offset: 1.57 in (40 mm)

Winter tires

R 15

Tires	Wheels
FA: 165/65 R15 81 T M+S  RA: 185/60 R15 84 T M+S 	Steel wheels: FA: 5.0 J x 15 H2 Wheel offset: 1.25 in (32 mm) RA: 5.5 J x 15 H2 Wheel offset: 1.65 in (42 mm) Light-alloy wheels: FA: 5.0 J x 15 CH Wheel offset: 1.25 in (32 mm) RA: 5.5 J x 15 CH Wheel offset: 1.65 in (42 mm)

>> Wheels and tires.

Information regarding technical data

General information

- i** The data stated here specifically refers to a vehicle with standard equipment. Consult a smart center for the data for all vehicle variants and trim levels.

Vehicle electronics

Retrofitting two-way radios and mobile phones (RF transmitters)

⚠ WARNING

The electromagnetic radiation from modified or incorrectly retrofitted RF-transmitters can interfere with the vehicle electronics. This can compromise the operational safety of the vehicle. There is a risk of an accident.

You should have all work to electrical and electronic equipment carried out at a qualified specialist workshop.

⚠ WARNING

The electromagnetic radiation from incorrectly operated RF transmitters can interfere with the vehicle electronics, for example:

- if the RF transmitter is not connected with an exterior antenna
- the exterior antenna has been installed incorrectly or is not a low-reflection type

This can compromise the operational safety of the vehicle. There is a risk of an accident.

Have the low-reflection exterior antenna mounted at a qualified specialist workshop. When operating RF transmitters in the vehicle, always connect them with the low-reflection exterior antenna.

- !** The operating permit may be invalidated if the instructions for installation and use of RF transmitters are not observed.

In particular, the following conditions must be complied with:

- only approved wavebands may be used.
- compliance with the maximum permissible output in these wavebands is required.
- only approved antenna positions may be used.

Excessive levels of electromagnetic radiation may cause damage to your health and the health of others. Using an exterior antenna takes into account current scientific discussions relating to the possible health hazards that may result from electromagnetic fields. The following antenna positions may be used if RF transmitters have been properly installed:

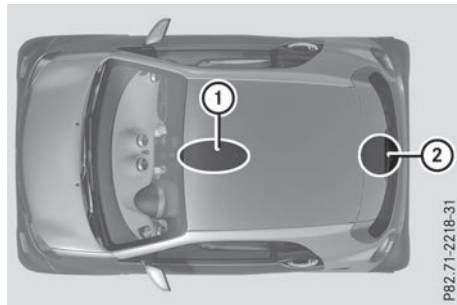

Approved antenna positions

- ① Front roof area
- ② Rear roof area

Use the Technical Specification ISO/TS 21609 when retrofitting RF transmitters (Road Vehicles - EMC guidelines for installation of aftermarket radio frequency transmitting equipment). Observe the legal requirements for retrofittings.

If your vehicle has fittings for two-way radio equipment, use the power supply or antenna connections intended for use with the basic wiring. Be sure to observe the manufacturer's additional instructions when installing.

Deviations with respect to wavebands, maximum transmission outputs or antenna positions must be approved by smart.

- i** Damage or consequential damage arising from retrofitting RF transmitters in the vehicle, is not covered by the smart warranty.

The maximum transmission output (PEAK) at the base of the antenna must not exceed the following values:

Waveband	Maximum transmission output
Tetra 380 - 410 MHz	20 W
Mobile communications generation 2G/3G/4G	6 W

The following can be used in the vehicle without restrictions:

- RF transmitters with a maximum transmission output of up to 100 mW
- Mobile phones (2G/3G/4G)

There is no restriction for antenna positions on the outside of the vehicle for the following wavebands:

- Tetra
- Mobile communications (2G/3G/4G)

Identification plates

Vehicle identification plate with vehicle identification number (VIN)

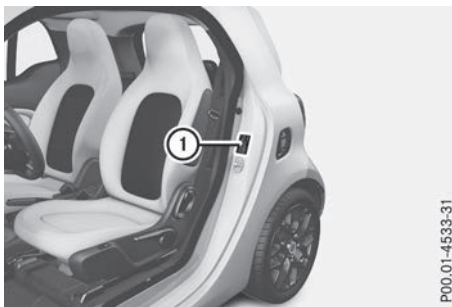

P00.01-4533-31

- ▶ Open the driver's door. You will see vehicle identification plate ①.

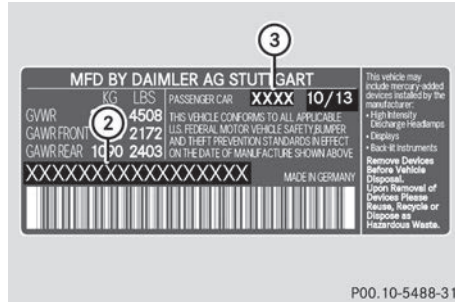

P00.10-5488-31

Example: vehicle identification plate (USA only)

- ② Vehicle model
- ③ Paint code

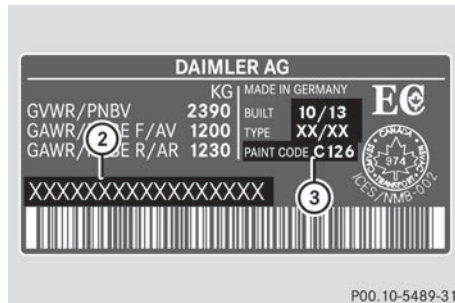

P00.10-5489-31

Example: vehicle identification plate (Canada only)

- ② VIN
- ③ Paint code

- ⓘ The data shown on the vehicle identification plate is used only as an example. This data is different for every vehicle and can deviate from the data shown here. You can find the data applicable to your vehicle on the vehicle identification plate.

Vehicle identification number (VIN)

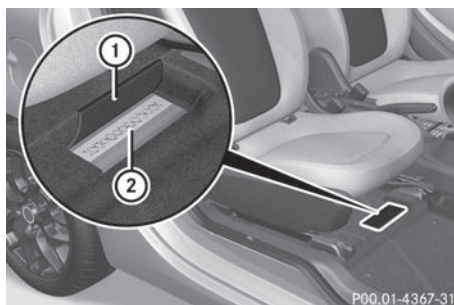

- ▶ Slide the right-hand front seat to its rear-most position.
- ▶ Fold up floor covering ① in front of the right-hand front seat. You will see VIN ②.

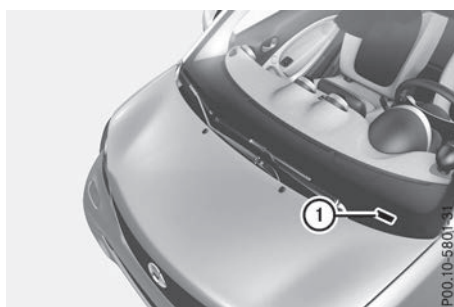

The VIN can also be found in the following locations:

- at lower edge of the windshield ①
- on the vehicle identification plate (▷ page 198)

Engine number

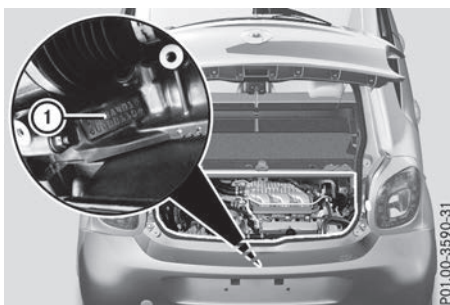

- ① Engine number (stamped into the crankcase)



- ① Emissions control information plate

Service products and filling capacities

Important safety notes

⚠ WARNING

Service products may be poisonous and hazardous to health. There is a risk of injury. Comply with instructions on the use, storage and disposal of service products on the labels of the respective original containers. Always store service products sealed in their original containers. Always keep service products out of the reach of children.

♻ Environmental note

Dispose of service products in an environmentally responsible manner.

Service products include the following:

- Fuels
- Lubricants (e.g. engine oil, transmission oil)
- Coolant
- Brake fluid
- Windshield washer fluid
- Climate control system refrigerant

Components and service products must be matched. You should therefore only use products that have been tested and approved by Mercedes-Benz.

Information on tested and approved products can be obtained at a smart center.

You can recognize service products approved by Mercedes-Benz by the following inscription on the containers:

- MB-Freigabe (e.g. MB-Freigabe 229.51)
- MB Approval (e.g. MB Approval 229.51)

Other designations or recommendations indicate a level of quality or a specification in accordance with an MB Sheet Number (e.g. MB 229.5). They have not necessarily been approved by Mercedes-Benz.

- i** For further information inquire at any smart center.

Fuel

Important safety notes

WARNING

Fuel is highly flammable. If you handle fuel incorrectly, there is a risk of fire and explosion.

You must avoid fire, open flames, creating sparks and smoking. Switch off the engine and, if applicable, the auxiliary heating before refueling.

WARNING

Fuel is poisonous and hazardous to health. There is a risk of injury.

You must make sure that fuel does not come into contact with your skin, eyes or clothing and that it is not swallowed. Do not

inhale fuel vapors. Keep fuel away from children.

If you or others come into contact with fuel, observe the following:

- Wash away fuel from skin immediately using soap and water.
- If fuel comes into contact with your eyes, immediately rinse them thoroughly with clean water. Seek medical assistance without delay.
- If fuel is swallowed, seek medical assistance without delay. Do not induce vomiting.
- Immediately change out of clothing which has come into contact with fuel.

Tank capacity

Model	Total capacity
All models	8.7 US gal (33.0 l)

Model	Of which reserve
All models	Approx. 1.3 US gal (5.0 l)

Gasoline

Fuel grade

! Do not use diesel to refuel vehicles with a gasoline engine. Do not switch on the ignition if you accidentally refuel with the wrong fuel. Otherwise, the fuel will enter the fuel system. Even small amounts of the wrong fuel could result in damage to the fuel system and the engine. Notify a qualified specialist workshop and have the fuel tank and fuel lines drained completely.

! Only refuel using premium-grade unleaded gasoline with at least 91 AKI/95 RON (91 octane).

! Only use the fuel recommended. Operating the vehicle with other fuels can lead to engine failure.

! Do not use the following:

- E85 (gasoline with 85% ethanol)
- E100 (100% ethanol)
- M15 (gasoline with 15% methanol)
- M30 (gasoline with 30% methanol)
- M85 (gasoline with 85% methanol)
- M100 (100% methanol)
- Gasoline with metalliferous additives
- Diesel

Do not mix such fuels with the fuel recommended for your vehicle. Do not use additives. Engine failure may otherwise occur. This does not include cleaning additives for the removal and prevention of residue build-up. Gasoline must only be mixed with cleaning additives recommended by smart (see "Additives"). For further information inquire at any smart center.

! To ensure the longevity and full performance of the engine, only premium-grade unleaded gasoline must be used.

If standard unleaded gasoline is unavailable and you have to refuel with unleaded gasoline of a lower grade, observe the following precautions:

- Only fill the fuel tank to half full with regular unleaded gasoline and fill the rest with premium-grade unleaded gasoline as soon as possible.
- Do not drive at the maximum speed.
- Avoid sudden acceleration and engine speeds over 3,000 rpm.

You will usually find information about the fuel grade on the pump. If you cannot find the label on the pump, ask the staff for assistance.

i For further information, consult a qualified specialist workshop or on the Internet at <http://www.smartusa.com> (USA only).

i E10 fuel contains up to 10% bioethanol. Your vehicle is E10-compatible. You can refuel your vehicle using E10 fuel.

As a temporary measure, if the recommended fuel is not available, you may also use regular unleaded gasoline with an octane rating of 87 AKI/91 RON. This may reduce engine per-

formance and increase fuel consumption. Avoid driving at full throttle and sudden acceleration. Never refuel using fuel with a lower octane rating.

Information on refueling (> page 95).

Additives

! Operating the engine with subsequently added fuel additives can lead to engine damage. Do not mix any fuel additives with the fuel. This does not include additives for the removal and prevention of residue buildup. Gasoline must only be mixed with additives recommended by smart. Comply with the instructions for use on the product label. For further information on recommended additives, inquire at any smart center.

smart recommends that you use fuel brands that have additives.

The quality of the fuel available in some countries may not be sufficient. Residue could build up in the fuel injection system as a result. In this case, in consultation with a smart center, the gasoline may be mixed with the cleaning additive recommended by smart. You must observe the notes and mixing ratios specified on the container.

Fuel consumption information

Environmental note

CO₂ (carbon dioxide) is the gas which scientists believe to be principally responsible for global warming (the greenhouse effect). Your vehicle's CO₂ emissions are directly related to fuel consumption and therefore depend on:

- efficient use of the fuel by the engine
- driving style
- other non-technical factors, such as environmental influences, road conditions or traffic flow

You can minimize your vehicle's CO₂ emissions by driving carefully and having it serviced regularly.

The vehicle will use more fuel than usual in the following situations:

- at very low outside temperatures
- in city traffic
- on short journeys
- in mountainous terrain

Engine oil

General notes



- ❗ Never use engine oil or an oil filter of a specification other than is necessary to fulfill the prescribed service intervals. Do not change the engine oil or oil filter in order to achieve longer replacement intervals than those prescribed. You could otherwise cause engine damage or damage to the exhaust gas aftertreatment. Follow the instructions in the service interval display regarding the oil change. Otherwise, you may damage the engine and the exhaust gas aftertreatment.

When handling engine oil, observe the important safety notes on service products (> page 199).

The engine oils are matched to the performance of smart engines and service intervals. You should therefore only use engine oils and oil filters that are approved for vehicles with maintenance systems.

Consult a smart center to view a list of approved engine oils and filters. Or visit the website <http://bevo.mercedes-benz.com>.

The table shows which engine oils have been approved for your vehicle.

Model	MB-Freigabe or MB-Approval
All models	229.51, 229.53

- ❗ MB approval is indicated on the oil containers.

Filling capacities

The following values refer to an oil change including the oil filter.

Model	Capacity
All models	3.8 US qt (3.4 l)

Additives

- ❗ Do not use any additives in the engine oil. This could damage the engine.

Engine oil viscosity

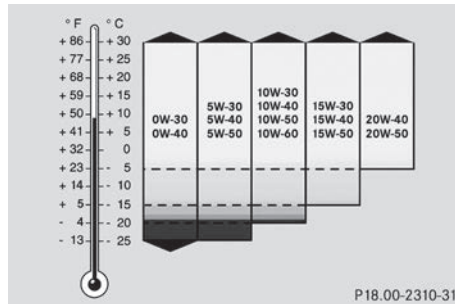

Viscosity describes the flow characteristics of a fluid. If an engine oil has a high viscosity, this means that it is thick; a low viscosity means that it is thin.

Select an engine oil with an SAE (viscosity) classification suitable for the prevailing outside temperatures. The table shows you which SAE classifications are to be used. The low-temperature properties of engine oils can be significantly impaired during operation due to, for example, aging or soot and fuel accretion. It is therefore strongly recommended that you carry out regular oil changes using an approved engine oil with the appropriate SAE classification.

Brake fluid

When handling brake fluid, observe the important safety notes on service products (> page 199).

The brake fluid change intervals can be found in the Maintenance Booklet.

Only use brake fluid approved by Mercedes-Benz according to MB Approval 331.0.

Information about approved brake fluid can be obtained at any qualified specialist workshop or on the Internet at <http://bevo.mercedes-benz.com>.

- i** Have the brake fluid regularly replaced at a qualified specialist workshop and the replacement confirmed in the Maintenance Booklet.

Coolant

General notes

- !** Only add coolant that has been premixed with the desired antifreeze protection. You could otherwise damage the engine. Further information on coolants can be found in the Mercedes-Benz Specifications for Service Products, MB BeVo 310.1, e.g. on the Internet at <http://bevo.mercedes-benz.com>. Or contact a qualified specialist workshop.

- !** Always use a suitable coolant mixture, even in countries where high temperatures prevail.

Otherwise, the engine cooling system is not sufficiently protected from corrosion and overheating.

- i** Have the coolant regularly replaced at a qualified specialist workshop and the replacement confirmed in the Maintenance Booklet.

Comply with the important safety precautions for service products when handling coolant (> page 199).

The coolant is a mixture of water and antifreeze/corrosion inhibitor. It performs the following tasks:

- corrosion protection
- antifreeze protection
- raising the boiling point

If the coolant has antifreeze protection down to -35 °F (-37 °C), the boiling point of the coolant during operation is approximately 266 °F (130 °C).

The antifreeze/corrosion inhibitor concentration in the engine cooling system should:

- be at least 50%. This will protect the engine cooling system against freezing down to around -13 °F (-25 °C).
- not exceed 50% (antifreeze protection down to -35 °F [-37 °C]). Otherwise, heat will not be dissipated as effectively.

smart recommends an antifreeze/corrosion inhibitor concentrate in accordance with MB Specifications for Operating Fluids 310.1 or 325.6.

Antifreeze/corrosion inhibitor concentrate in accordance with MB Specifications for Operating Fluids 310.1 and 325.6 can be mixed together. An orange discoloration depending on the mixing ratio does not affect the function.

- i** When the vehicle is first delivered, it is filled with a coolant mixture that ensures adequate antifreeze and corrosion protection.
- i** The coolant is checked with every maintenance interval at a qualified specialist workshop.

Windshield washer system

General notes

- !** Do not add distilled or de-ionized water to the washer fluid container. Otherwise, the level sensor may be damaged.

- !** Only MB SummerFit and MB WinterFit washer fluid should be mixed together. The spray nozzles may otherwise become blocked.

When handling washer fluid, observe the important safety notes on service products (> page 199).

At temperatures above freezing:

- ▶ Fill the washer fluid reservoir with a mixture of water and windshield washer fluid, e.g. MB SummerFit.

Add 1 part MB SummerFit to 100 parts water.

At temperatures below freezing:

- Fill the washer fluid reservoir with a mixture of water and washer fluid, e.g. MB WinterFit.

The correct mixing ratio can be taken from the information on the antifreeze protection container.

- ❗ Add windshield washer fluid, e.g. MB SummerFit or MB WinterFit, to the washer fluid all year round.

Climate control system refrigerant

Important safety notes

Your vehicle's climate control system is filled with R-134a refrigerant.

The instruction label regarding the refrigerant type used can be found on the left, on the underside of the hood.

- ❗ Only the refrigerant R-134a and the PAG oil approved by Mercedes-Benz may be used. The approved PAG oil may not be mixed with any other PAG oil that is not approved for R-134a refrigerant. Otherwise, the climate control system may be damaged.

Service work, such as topping-up refrigerant or replacing components, may only be carried out at a qualified specialist workshop. All applicable regulations such as the SAE standard J639 must be adhered to.

Always have all work on the climate control system carried out at a qualified specialist workshop.

Refrigerant instruction label



P00.10-5824-31

The refrigerant instruction label:

- is located at the front on the right on the body frame.
- indicates having service work carried out at a qualified specialist workshop

Vehicle data

General notes

Please note that for the specified vehicle data:

- The heights specified may vary as a result of:
 - Tires
 - Load
 - Condition of the suspension
 - Optional equipment
- Optional equipment reduces the maximum payload.

You can find the correct values for your model with the help of the VIN on the vehicle identification plate (► page 198).

Dimensions and weights



P72.20-3238-31

Model	① Opening height
All models	73.0 in (1855 mm)

All models	
Vehicle length	106.1 in (2695 mm)
Vehicle width including exterior mirrors	74.5 in (1893 mm)
Vehicle width without exterior mirrors	65.4 in (1663 mm)
Vehicle height	61.2 in (1555 mm)
Wheelbase	73.7 in (1873 mm)
Turning radius	22.8 ft (6.95 m)
Maximum trunk load	165 lb (75.0 kg)
Maximum tailgate load	220 lb (100.0 kg)

Vehicle width excluding exterior mirrors for vehicles equipped with wheel trims 65.8 in (1672 mm).

>> Technical data.

