



S-Class

Operator's Manual

S-Class Operator's Manual



Order no. 6515 2539 13 Part no. 222 584 00 03 Edition C 2015



Mercedes-Benz

Symbols

Registered trademarks:

- Bluetooth® is a registered trademark of Bluetooth SIG Inc.
- DTS is a registered trademark of DTS, Inc.
- Dolby and MLP are registered trademarks of DOLBY Laboratories.
- BabySmart™, ESP® and PRE-SAFE® are registered trademarks of Daimler AG.
- HomeLink® is a registered trademark of Johnson Controls.
- iPod® and iTunes® are registered trademarks of Apple Inc.
- Burmester® is a registered trademark of Burmester Audiosysteme GmbH.
- Microsoft® and Windows media® are registered trademarks of Microsoft Corporation.
- SIRIUS is a registered trademark of Sirius XM Radio Inc.
- HD Radio is a registered trademark of iBiquity Digital Corporation.
- Gracenote® is a registered trademark of Gracenote, Inc.
- ZAGATSurvey® and related brands are registered trademarks of ZagatSurvey, LLC.

In this Operator's Manual you will find the following symbols:

WARNING

Warning notes make you aware of dangers which could pose a threat to your health or life, or to the health and life of others.

Environmental note

Environmental notes provide you with information on environmentally aware actions or disposal.

 Notes on material damage alert you to dangers that could lead to damage to your vehicle.

 Practical tips or further information that could be helpful to you.

 This symbol indicates an instruction that must be followed.

 Several of these symbols in succession indicate an instruction with several steps.

 This symbol tells you where you can find more information about a topic.

 This symbol indicates a warning or an instruction that is continued on the next page.

Display This text indicates a message in the multifunction/COMAND/Audio display.

 This symbol tells you that you can find further information in the Digital Operator's Manual.

Parts of the software in the vehicle are protected by copyright © 2005
The FreeType Project
<http://www.freetype.org>. All rights reserved.

Publication details

Internet

Further information about Mercedes-Benz vehicles and about Daimler AG can be found on the following websites:

<http://www.mbusa.com> (USA only)

<http://www.mercedes-benz.ca> (Canada only)

Editorial office

©Daimler AG: Not to be reprinted, translated or otherwise reproduced, in whole or in part, without written permission from Daimler AG.

Vehicle manufacturer

Daimler AG
Mercedesstraße 137
70327 Stuttgart
Germany

Welcome to the world of Mercedes-Benz

We urge you to read this Operator's Manual carefully and familiarize yourself with the vehicle before driving. For your own safety and a longer vehicle life, follow the instructions and warning notices in this manual.

Ignoring them could result in damage to the vehicle or personal injury to you or others.

Vehicle damage caused by failure to follow instructions is not covered by the Mercedes-Benz Limited Warranty.

This Operator's Manual provides information on the most important functions of your vehicle.

Additional information on convenience functions can be found in COMAND in your Digital Operator's Manual.

The equipment or product designation of your vehicle may vary depending on:

- model
- order
- country specification
- availability

Mercedes-Benz therefore reserves the right to introduce changes in the following areas:

- design
- equipment
- technical features

The equipment in your vehicle may therefore differ from that shown in the descriptions and illustrations.

The following are integral components of the vehicle:

- Operator's Manual
- Maintenance Booklet
- Equipment-dependent supplements

Keep these documents in the vehicle at all times. If you sell the vehicle, always pass all documents on to the new owner.

You can also use the S-Class Guide smartphone app:



Apple® iOS



Android™

Please note that the Mercedes-Benz Guides App may not yet be available in your country.

The technical documentation team at Daimler AG wishes you safe and pleasant motoring.

Mercedes-Benz USA, LLC

Mercedes-Benz Canada, Inc.

A Daimler Company

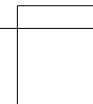
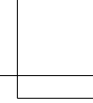

| | | | | |
|--|-----------|---|------------|--|
| Index | 4 | At a glance | 33 | |
| Digital Operator's Manual | 23 | Safety | 43 | |
| Introduction | 25 | Opening and closing | 87 | |
| | | Seats, steering wheel and mirrors .. | 109 | |
| | | Lights and windshield wipers | 115 | |
| | | Climate control | 123 | |
| | | Driving and parking | 131 | |
| | | On-board computer and displays | 189 | |
| | | COMAND | 223 | |
| | | Stowage and features | 231 | |
| | | Maintenance and care | 245 | |
| | | Roadside Assistance | 255 | |
| | | Wheels and tires | 275 | |
| | | Technical data | 319 | |

1, 2, 3 ...

4ETS

see ETS/4ETS (Electronic Traction System)

4MATIC (permanent four-wheel

drive) 170

12 V socket

see Sockets

115 V socket 235

360° camera

Cleaning 253

Function/notes 175

A**ABS (Anti-lock Braking System)**

Display message 196

Function/notes 74

Important safety notes 75

Warning lamp 214

Accident

Automatic measures after an accident 66

Activating/deactivating cooling

with air dehumidification 129

Activating/deactivating Night**View Assist Plus**

With spotlight function 181

Active Blind Spot Assist

Activating/deactivating (on-board computer) 194

Display message 195

Function/information 181

Active Body Control (ABC)

Function/notes 169

Active Lane Keeping Assist

Activating/deactivating (on-board computer) 194

Display message 195

Function/information 184

Active multicontour seat 112

Active Parking Assist

Display message 195

Function/notes 172

Important safety notes 172

ADAPTIVE BRAKE 82

Adaptive Brake Assist

Function/notes 79

Adaptive Highbeam Assist

Display message 195

Adaptive Highbeam Assist PLUS

Function/notes 118

Switching on/off 119

Additives (engine oil) 324

Address book

see also Digital Operator's Manual 224

Air bags

Belt bags 51

Cushion air bags 57

Deployment 63

Display message 205

Front air bag (driver, front

passenger) 55

Important safety notes 54

Introduction 54

Knee bag 56

PASSENGER AIR BAG indicator

lamps 48

Side impact air bag 56

Window curtain air bag 57

Air vents

Setting 129

Air-conditioning system

see Climate control

AIRMATIC

Function/notes 169

Alarm

ATA (Anti-Theft Alarm system) 84

Switching off (ATA) 84

Switching the function on/off

(ATA) 84

Alarm system

see ATA (Anti-Theft Alarm system)

Anti-lock braking system

see ABS (Anti-lock Braking System)

Anti-Theft Alarm system

see ATA (Anti-Theft Alarm system)

Ashtray 235

Assistance display (on-board computer)

..... 194

ASSYST PLUS

Displaying a service message 252

Hiding a service message 252

- Notes 252
 - Resetting the service interval display 252
 - Service message 252
 - Special service requirements 252
 - ATA (Anti-Theft Alarm system)**
 - Activating/deactivating 84
 - Function 84
 - Switching off the alarm 84
 - ATTENTION ASSIST**
 - Activating/deactivating 194
 - Display message 195
 - Function/notes 177
 - Authorized Mercedes-Benz Center**
see Qualified specialist workshop
 - Authorized workshop**
see Qualified specialist workshop
 - AUTO lights**
 - Display message 195
 - Automatic car wash (care)** 252
 - Automatic engine start (ECO start/stop function)** 137
 - Automatic engine switch-off (ECO start/stop function)** 137
 - Automatic headlamp mode** 117
 - Automatic transmission**
 - Accelerator pedal position 139
 - Automatic drive program 139
 - Changing gear 139
 - DIRECT SELECT lever 138
 - Display message 195
 - Driving tips 139
 - Emergency running mode 139
 - Engaging drive position 138
 - Engaging neutral 139
 - Engaging park position automatically 138
 - Engaging reverse gear 138
 - Engaging the park position 138
 - Kickdown 139
 - Manual drive program (AMG vehicles) 139
 - Overview 138
 - Problem (malfunction) 139
 - Program selector button 139
 - Pulling away 136
 - Starting the engine 136
 - Steering wheel paddle shifters 139
 - Transmission position display 139
 - Transmission positions 139
 - Automatic transmission emergency mode** 139
- ## B
- Back button** 229
 - BAS (Brake Assist System)** 75
 - BAS PLUS Q (Brake Assist System PLUS) with Cross-Traffic Assist**
 - Function/notes 75
 - Important safety notes 76
 - Battery (high-voltage)**
see High-voltage battery
 - Battery (SmartKey)**
 - Checking 91
 - Important safety notes 91
 - Replacing 91
 - Battery (vehicle)**
 - Charging 264
 - Important safety notes 261
 - Jump starting 266
 - Belt**
see Seat belts
 - Belt bag** 51
 - Blind Spot Assist**
see Active Blind Spot Assist
 - Bluetooth®**
see also Digital Operator's Manual 224
 - Brake Assist**
see BAS (Brake Assist System)
 - Brake fluid**
 - Display message 199
 - Notes 324
 - Brake force distribution, electronic**
see EBD (electronic brake force distribution)
 - Brake lamps**
 - Display message 195
 - Brake pedal**
 - Pedal resistance/pedal travel 46
 - Brakes**
 - ABS 74
 - Adaptive Brake Assist 79
 - BAS 75

- BAS PLUS with Cross-Traffic Assist 75
 - Brake fluid (notes) 324
 - Display message 196
 - EBD 81
 - High-performance brake system 157
 - Hill start assist 137
 - HOLD function 167
 - Important safety notes 157
 - Maintenance 157
 - Parking brake 155
 - Recuperative Brake System 46
 - Riding tips 157
 - Warning lamp 213
 - Breakdown**
 - see Flat tire
 - see Towing away
 - Brightness control (instrument cluster lighting)** 37
 - Buttons and controller** 228
 - Buttons on the steering wheel** 191
- C**
- California**
 - Important notice for retail customers and lessees 27
 - Calling up a malfunction**
 - see Display messages
 - Car**
 - see Vehicle
 - Car key**
 - see SmartKey
 - Care**
 - 360° camera 253
 - Car wash 252
 - Carpets 254
 - Display 254
 - Exhaust pipe 253
 - Exterior lights 253
 - Gear or selector lever 254
 - Interior 254
 - Matte finish 253
 - Night View Assist Plus 254
 - Notes 252
 - Paint 253
 - Plastic trim 254
 - Power washer 253
 - Rear view camera 253
 - Roof lining 254
 - Seat belt 254
 - Seat cover 254
 - Sensors 253
 - Trim pieces 254
 - Washing by hand 253
 - Wheels 253
 - Windows 253
 - Wiper blades 253
 - Wooden trim 254
 - CD**
 - see also Digital Operator's Manual 224
 - CD player/CD changer (on-board computer)** 194
 - Center console**
 - Overview 39
 - Center console in the rear compartment**
 - Stowage compartment 233
 - Central locking**
 - Locking/unlocking (SmartKey) 89
 - Charging**
 - see Charging the high-voltage battery (important safety notes)
 - Charging cable**
 - Connecting 149
 - Controls 147
 - Important safety notes 147
 - Indicator lamp 149
 - Removing 150
 - Storing 147
 - Warming up 146
 - Charging the high-voltage battery (important safety notes)** 144
 - Chauffeur mode**
 - Display message 210
 - Installing the head restraint 112
 - Removing the head restraint 112
 - Child**
 - Restraint system 68
 - Child seat**
 - Forward-facing restraint system 72
 - LATCH-type (ISOFIX) child seat anchors 69
 - On the front-passenger seat 72
 - Rearward-facing restraint system 72

- Top Tether 71
- Child-proof locks**
- Important safety notes 72
- Rear doors 73
- Children**
- In the vehicle 67
- Special seat belt retractor 67
- Cigarette lighter** 235
- Cleaning**
- Mirror turn signal 253
- Climate control**
- Automatic climate control 125
- Controlling automatically 129
- Cooling with air dehumidification .. 129
- Defrosting the windows 129
- Defrosting the windshield 129
- General notes 124
- Indicator lamp 129
- Ionization 129
- Overview of systems 124
- Perfume atomizer 129
- Pre-entry climate control at departure time (REMOTE CLIMATE CONTROL) 129
- Pre-entry climate control via key ... 129
- Problem with the rear window defroster 129
- Problems with cooling with air dehumidification 129
- Rear control panel 125
- Refrigerant 326
- Refrigerant filling capacity 327
- Setting the air distribution 129
- Setting the airflow 129
- Setting the climate mode 129
- Setting the temperature 129
- Switching air-recirculation mode on/off 129
- Switching on/off 129
- Switching residual heat on/off 129
- Switching the rear window defroster on/off 129
- Switching the synchronization function on and off 129
- Cockpit**
- Overview 34
- see Instrument cluster
- COLLISION PREVENTION ASSIST PLUS**
- Activating/deactivating 194
- Operation/notes 77
- COMAND**
- Controller 228
- Display 228
- Telephone keypad overview 230
- Combination switch** 117
- Connecting a USB device**
- see also Digital Operator's Manual 224
- Consumption statistics (on-board computer)** 194
- Coolant (engine)**
- Checking the level 250
- Display message 207
- Filling capacity 325
- Important safety notes 325
- Temperature gauge 190
- Warning lamp 218
- Coolbox** 235
- Cooling**
- see Climate control
- Copyright** 32
- Cornering light function**
- Display message 195
- Function/notes 117
- Crash-responsive emergency lighting** 119
- Crosswind Assist (vehicles with MAGIC BODY CONTROL)** 169
- Crosswind Assist (vehicles without MAGIC BODY CONTROL)** 81
- Cruise control**
- Activation conditions 159
- Cruise control lever 159
- Deactivating 159
- Display message 195
- Driving system 158
- Function/notes 158
- Important safety notes 158
- Selecting 159
- Setting a speed 159
- Storing and maintaining current speed 159

- Cup holder**
 - Important safety notes 235
 - Rear compartment 235
 - Temperature controlled 235
 - Cushion air bags** 57
 - Customer Assistance Center (CAC)** 30
 - Customer Relations Department** 30
- D**
- Data**
 - see Technical data
 - Daytime running lamps**
 - Display message 195
 - Function/notes 117
 - Switching on/off (on-board computer) 194
 - Declarations of conformity** 29
 - Diagnostics connection** 29
 - Digital Operator's Manual**
 - Help 23
 - Introduction 23
 - Digital speedometer** 194
 - DIRECT SELECT lever**
 - Automatic transmission 138
 - Display**
 - see Display messages
 - see Warning and indicator lamps
 - Display (cleaning instructions)** 254
 - Display messages**
 - ASSYST PLUS 252
 - Calling up (on-board computer) 195
 - Engine 207
 - General notes 195
 - Hiding (on-board computer) 195
 - Introduction 195
 - KEYLESS-GO 195
 - Lights 195
 - Safety systems 196
 - SmartKey 195
 - Tires 208
 - Vehicle 210
 - Distance recorder** 194
 - see Odometer
 - see Trip odometer
 - Distance warning (warning lamp)** 219
 - Distance warning function**
 - Activating/deactivating 194
 - Function/notes 78
 - DISTRONIC PLUS**
 - Activating 161
 - Activation conditions 161
 - Cruise control lever 161
 - Deactivating 163
 - Display message 195
 - Displays in the multifunction display 163
 - Driving tips 164
 - Function/notes 159
 - Important safety notes 160
 - Setting the specified minimum distance 163
 - Door control panel**
 - Overview 41
 - Doors**
 - Automatic locking (switch) 92
 - Central locking/unlocking (SmartKey) 89
 - Display message 195
 - Emergency locking 93
 - Emergency unlocking 93
 - Important safety notes 92
 - Opening (from inside) 92
 - Power closing 92
 - Drinking and driving** 156
 - Drive program**
 - Automatic 139
 - Manual (AMG vehicles) 139
 - Driver's door**
 - see Doors
 - Driving abroad**
 - Mercedes-Benz Service 252
 - Symmetrical low beam 116
 - Driving Assistance package** 181
 - Driving safety systems**
 - ABS (Anti-lock Braking System) 74
 - ADAPTIVE BRAKE 82
 - Adaptive Brake Assist 79
 - BAS (Brake Assist System) 75
 - BAS PLUS with Cross-Traffic Assist 75
 - COLLISION PREVENTION ASSIST PLUS 77
 - Distance warning function 78

- EBD (electronic brake force distribution) 81
- ESP® (Electronic Stability Program) 79
- ETS/4ETS (Electronic Traction System) 80
- Important safety information 74
- Overview 74
- PRE-SAFE® Brake 82
- Recuperative Brake System 46
- STEER CONTROL 84
- Driving systems**
- 360° camera 175
- Active Blind Spot Assist 181
- Active Body Control ABC 169
- Active Lane Keeping Assist 184
- Active Parking Assist 172
- AIRMATIC 169
- ATTENTION ASSIST 177
- Cruise control 158
- DISTRONIC PLUS 159
- DISTRONIC PLUS with Steering Assist and Stop&Go Pilot 165
- Driving Assistance package 181
- HOLD function 167
- Night View Assist Plus 178
- PARKTRONIC 171
- Rear view camera 173
- Driving tips**
- AMG ceramic brakes 157
- Automatic transmission 139
- Brakes 157
- Break-in period 132
- DISTRONIC PLUS 164
- Downhill gradient 157
- Drinking and driving 156
- Driving abroad 116
- Driving in winter 157
- Driving on flooded roads 157
- Driving on wet roads 157
- Exhaust check 156
- Fuel 156
- General 156
- Hydroplaning 157
- Icy road surfaces 157
- Limited braking efficiency on salted roads 157
- Snow chains 279
- Symmetrical low beam 116
- The first 1000 miles (1500 km) 132
- Wet road surface 157
- DVD video**
- Operating (on-board computer) 194
- see also Digital Operator's Manual 224
- E**
- EASY-ENTRY feature**
- Function/notes 113
- EASY-EXIT feature**
- Function/notes 113
- EBD (electronic brake force distribution)**
- Display message 199
- Function/notes 81
- ECO display**
- Function/notes 157
- ECO start/stop function**
- Automatic engine start 137
- Automatic engine switch-off 137
- Deactivating/activating 137
- General information 137
- Important safety notes 137
- Introduction 137
- Electronic Stability Program**
- see ESP® (Electronic Stability Program)
- Emergency**
- Automatic measures after an accident 66
- Emergency release**
- Driver's door 93
- Trunk 99
- Vehicle 93
- Emergency Tensioning Devices**
- Activation 63
- Emissions control**
- Service and warranty information 26
- Engine**
- Check Engine warning lamp 211
- Display message 207
- ECO start/stop function 137
- Engine number 321
- Irregular running 138
- Jump-starting 266
- Starting problems 138

- Starting the engine with the SmartKey 136
 - Starting with the Start/Stop button 136
 - Switching off 155
 - Switching off with the Start/Stop button 155
 - Switching off with the vehicle key .. 155
 - Tow-starting (vehicle) 272
 - Engine electronics**
 - Problem (malfunction) 138
 - Engine emergency stop** 274
 - Engine oil**
 - Adding 249
 - Additives 324
 - Checking the oil level 247
 - Checking the oil level using the dipstick 247
 - Checking the oil level using the on-board computer 249
 - Display message 195
 - Filling capacity 324
 - Notes about oil grades 323
 - Notes on oil level/consumption 247
 - Viscosity 324
 - Entering an address**
 - see also Digital Operator's Manual 224
 - ESP® (Electronic Stability Program)**
 - Characteristics 80
 - Deactivating/activating 80
 - Display message 196
 - ETS/4ETS 80
 - Function/notes 79
 - General notes 79
 - Important safety information 80
 - Warning lamp 216
 - ETS/4ETS (Electronic Traction System)** 80
 - Exhaust check** 156
 - Exhaust pipe (cleaning instructions)** 253
 - Exhaustive discharging (high-voltage battery)** 263
 - Exterior lighting**
 - see Lights
 - Exterior mirrors**
 - Adjusting 113
 - Dipping (automatic) 113
 - Folding in/out (automatically) 113
 - Folding in/out (electrically) 113
 - Out of position (troubleshooting) ... 113
 - Setting 113
 - Storing settings (memory function) 113
 - Storing the parking position 113
 - Eyeglasses compartment** 233
- F**
- Features** 235
 - Filler cap**
 - see Fuel filler flap
 - Filling capacities (Technical data)** ... 321
 - Flat tire**
 - Changing a wheel/mounting the spare wheel 298
 - MOExtended tires 257
 - Preparing the vehicle 257
 - TIREFIT kit 258
 - Floormats** 243
 - Front-passenger seat**
 - Adjusting from the rear compartment 112
 - Fuel**
 - Additives 323
 - Consumption statistics 194
 - Displaying the current consumption 194
 - Displaying the range 194
 - Driving tips 156
 - Fuel gauge 35
 - Grade (gasoline) 322
 - Important safety notes 322
 - Problem (malfunction) 144
 - Refueling 141
 - Tank content/reserve fuel 322
 - Fuel filler flap**
 - Opening 142
 - Opening (PLUG-IN HYBRID vehicles) 142
 - Fuel level**
 - Calling up the range (on-board computer) 194

- Fuel tank**
- Capacity 322
 - Problem (malfunction) 144
- Fuses**
- Allocation chart 274
 - Before changing 272
 - Dashboard fuse box 273
 - Engine emergency stop 274
 - Fuse box in the engine compartment 273
 - Fuse box in the front-passenger footwell 273
 - Fuse box in the trunk 274
 - Important safety notes 272
- G**
- Garage door opener**
- Clearing the memory 243
 - General notes 240
 - Important safety notes 240
 - Opening/closing the garage door .. 243
 - Programming (button in the rear-view mirror) 240
 - Synchronizing the rolling code 241
- Gasoline** 322
- Gear or selector lever (cleaning guidelines)** 254
- Genuine parts** 25
- Glove box** 233
- Google™ Local Search**
- see also Digital Operator's Manual 224
- H**
- HANDS-FREE ACCESS** 96
- Hazard warning lamps** 116
- Head bags**
- Display message 203
- Head restraints**
- Adjusting (rear) 112
- Head-up display**
- Adjusting the brightness 194
 - Function/notes 192
 - Important safety notes 192
 - Setting the position 194
 - Switching on or off 192
- Switching the display on/off 194
- Headlamps**
- Fogging up 116
 - see Automatic headlamp mode
- Heating**
- see Climate control
- High-beam headlamps**
- Adaptive Highbeam Assist PLUS 118
 - Display message 195
 - Switching on/off 117
- High-voltage battery**
- Battery care 146
 - Charging (charging station) 151
 - Charging (mains socket) 147
 - Charging (wallbox) 150
 - Charging cable warming 146
 - Cruise range 146
 - Energy consumption 146
 - General notes 46
 - Method of operation 145
 - Outside temperatures 145
 - Overvoltage protection 146
 - Problems with the charging process 152
 - Terms of use 146
 - Vehicle fire 46
- Hill start assist** 137
- HOLD function**
- Activating 168
 - Deactivating 168
 - Function/notes 167
- Home address**
- see also Digital Operator's Manual 224
- Hood**
- Closing 247
 - Display message 210
 - Important safety notes 246
 - Opening 246
- Horn** 34
- Hybrid system**
- Automatic deactivation 44
 - Danger of electric shock 44
 - High-voltage battery 46
 - Important safety notes 44
 - Manual deactivation 45
 - Opening the hood 46

Hybrid vehicles

Important safety notes 44

Hydroplaning 157

I**Ignition lock**

see Key positions

Immobilizer 84

Indicator and warning lamps

COLLISION PREVENTION ASSIST

PLUS 219

Indicator lamps

see Warning and indicator lamps

Indicators

see Turn signals

Instrument cluster

Overview 35

Warning and indicator lamps 36

Instrument cluster lighting 37

Intelligent Light System

Display message 195

Interior lighting

Automatic control 119

Emergency lighting 119

Manual control 119

Overview 119

Reading lamp 119

iPod®

see also Digital Operator's Manual 224

J**Jack**

Using 300

Jump starting (engine) 266

K**Key positions**

SmartKey 133

Start/Stop button 133

KEYLESS-GO

Deactivation 89

Display message 195

Locking 89

Unlocking 89

Kickdown

Driving tips 139

Manual drive program 140

Knee bag 56

L**Lamps**

see Warning and indicator lamps

Lane Keeping Assist

see Active Lane Keeping Assist

LATCH-type (ISOFIX) child seat

anchors 69

License plate lamp (display mes-

sage) 195

Light function, active

Display message 195

Light sensor (display message) 195

Lights

Adaptive Highbeam Assist PLUS 118

Automatic headlamp mode 117

Cornering light function 117

Driving abroad 116

Hazard warning lamps 116

High beam flasher 117

High-beam headlamps 117

Light switch 116

Low-beam headlamps 117

Parking lamps 117

Setting exterior lighting 116

Standing lamps 117

Switching the daytime running

lamps on/off (on-board com-

puter) 194

Switching the spotlight on/off 194

Turn signals 117

see Replacing bulbs

Loading guidelines 232

Locking

see Central locking

Locking (doors)

Automatic 92

Emergency locking 93

From inside (central locking but-

ton) 92

Locking centrally

see Central locking

- Low-beam headlamps**
 - Display message 195
 - Setting for driving abroad (symmetrical) 116
 - Switching on/off 117
 - Lumbar support**
 - Adjusting the 4-way lumbar support 112
- M**
- M+S tires** 278
 - Magic Body Control** 169
 - MAGIC SKY CONTROL** 105
 - Malfunction message**
 - see Display messages
 - Matte finish (cleaning instructions)** 253
 - Maximum charge current**
 - Setting (charging cable) 148
 - MBC**
 - see Magic Body Control
 - mbrace**
 - Call priority 239
 - Display message 195
 - Downloading destinations (COMAND) 236
 - Downloading routes 236
 - Emergency call 237
 - General notes 236
 - Geo fencing 236
 - Locating a stolen vehicle 236
 - MB info call button 239
 - Remote vehicle locking 236
 - Roadside Assistance button 238
 - Search & Send 236
 - Self-test 236
 - Speed alert 236
 - System 236
 - Triggering the vehicle alarm 236
 - Vehicle remote malfunction diagnosis 236
 - Vehicle remote unlocking 236
 - Mechanical key**
 - Function/notes 90
 - Inserting 90
 - Locking vehicle 93
 - Removing 90
 - Unlocking the driver's door 93
 - Memory card (audio)** 194
 - Memory function** 113
 - Storing settings (rear compartment) 113
 - Mercedes-Benz Intelligent Drive**
 - 360° camera 175
 - ABS (Anti-lock Brake System) 74
 - Active Blind Spot Assist 181
 - Active Lane Keeping Assist 184
 - Active Parking Assist 172
 - ATTENTION ASSIST 177
 - BAS (Brake Assist) 75
 - BAS PLUS (Brake Assist PLUS) with Cross-Traffic Assist 75
 - Crosswind Assist (vehicles with MAGIC BODY CONTROL) 169
 - Crosswind Assist (vehicles without MAGIC BODY CONTROL) 81
 - Cruise control 158
 - DISTRONIC PLUS 159
 - DISTRONIC PLUS with Steering Assist and Stop&Go Pilot 165
 - ESP® (Electronic Stability Program) 79
 - General notes 158
 - MAGIC BODY CONTROL 169
 - Night View Assist Plus 178
 - PARKTRONIC 171
 - PRE-SAFE® (anticipatory occupant protection) 65
 - PRE-SAFE® Brake 82
 - PRE-SAFE® PLUS (anticipatory occupant protection PLUS) 66
 - Rear view camera 173
 - ROAD SURFACE SCAN 169
 - Message memory (on-board computer)** 195
 - Messages**
 - see Display messages
 - see Warning and indicator lamps
 - Mirrors**
 - see Exterior mirrors
 - see Rear-view mirror
 - see Vanity mirror (in the sun visor)
 - Modifying the programming (SmartKey)** 90

- MOExtended tires** 257
- Mounting wheels**
- Lowering the vehicle 303
 - Mounting a new wheel 303
 - Preparing the vehicle 299
 - Raising the vehicle 300
 - Removing a wheel 302
 - Securing the vehicle against rolling away 299
- MP3**
- Operation 194
 - see also Digital Operator's Manual 224
 - see separate operating instructions
- Multicontour seat** 112
- Multifunction display**
- Function/notes 190
 - Permanent display 194
- Multifunction steering wheel**
- Operating the on-board computer .. 191
 - Overview 37
- Music files**
- see also Digital Operator's Manual 224
- N**
- Navigation**
- Menu (on-board computer) 194
 - see also Digital Operator's Manual 224
 - see separate operating instructions
- Night View Assist Plus**
- Activating/deactivating 180
 - Cleaning 254
 - Function/notes 178
 - Problem (malfunction) 181
 - Switching automatic activation on/off 194
- Notes on breaking-in a new vehicle** 132
- O**
- Occupant Classification System (OCS)**
- Conditions 57
 - Faults 62
 - Operation 58
 - System self-test 60
- Occupant safety**
- Automatic measures after an accident 66
 - Children in the vehicle 67
 - Important safety notes 47
 - Pets in the vehicle 74
 - PRE-SAFE® (anticipatory occupant protection) 65
- OCS**
- Conditions 57
 - Faults 62
 - Operation 58
 - System self-test 60
- Odometer** 194
- Oil**
- see Engine oil
- On-board computer**
- Assistance graphic menu 194
 - Display messages 195
 - Displaying a service message 252
 - DISTRONIC PLUS 163
 - Factory settings submenu 194
 - Head-up display 192
 - Important safety notes 190
 - Lighting submenu 194
 - Media menu 194
 - Menu overview 194
 - Message memory 195
 - Navigation menu 194
 - Operation 191
 - Radio menu 194
 - Service menu 194
 - Standard display 194
 - Video DVD operation 194
- Online access** 153
- Operating safety**
- Declaration of conformity 29
 - Important safety notes 28
- Operating system**
- see On-board computer
- Operation**
- Digital Operator's Manual 23
- Operator's Manual**
- Overview 26
 - Vehicle equipment 26

- Outside temperature display** 190
 - Overhead control panel** 40
 - Override feature**
 - Rear side windows 73
- P**
- Paint code number** 320
 - Paintwork (cleaning instructions)** ... 253
 - Panic alarm** 47
 - Panorama roof with power tilt/
sliding panel**
 - Important safety notes 101
 - Opening/closing 102
 - Problem (malfunction) 108
 - Resetting 106
 - Parcel net hooks** 233
 - Parking**
 - Important safety notes 154
 - Parking brake 155
 - Position of exterior mirror, front-
passenger side 113
 - Rear view camera 173
 - see PARKTRONIC
 - Parking aid**
 - Active Parking Assist 172
 - see Exterior mirrors
 - see PARKTRONIC
 - Parking assistance**
 - see PARKTRONIC
 - Parking brake**
 - Display message 195
 - Electric parking brake 155
 - Parking lamps**
 - Switching on/off 117
 - PARKTRONIC**
 - Deactivating/activating 172
 - Driving system 171
 - Function/notes 171
 - Important safety notes 171
 - Problem (malfunction) 172
 - Range of the sensors 171
 - Warning display 172
 - PASSENGER AIR BAG**
 - Indicator lamps 48
 - PASSENGER AIR BAG indicator
lamp**
 - Problem (malfunction) 205
 - Pets in the vehicle** 74
 - Phone book**
 - see also Digital Operator's Man-
ual 224
 - Plastic trim (cleaning instruc-
tions)** 254
 - PLUG-IN HYBRID operation**
 - Automatic engine start (ECO
start/stop function) 188
 - Automatic engine switch-off (ECO
start/stop function) 188
 - Condition of charge, high-voltage
battery 188
 - Displaying the total range and
electrical range 188
 - Driving tips 188
 - ECO start/stop function 188
 - Electric motor (power display) 188
 - Energy flow display 188
 - Fuel consumption 188
 - Fuel consumption (COMAND) 188
 - General information 187
 - Generated electrical energy 188
 - Generated electrical energy
(COMAND) 188
 - Haptic accelerator pedal 188
 - High-voltage battery (condition of
charge) 188
 - Important safety notes 187
 - Instrument cluster (power dis-
play) 188
 - Manual drive program 188
 - Map-based energy management ... 188
 - Noiseless start 188
 - Operating (on-board computer) 188
 - Operating mode 188
 - Overrun mode 188
 - Overview, hybrid system 188
 - Overview, instrument cluster 188
 - Parking 188
 - Power display, electric motor 188
 - Problems with SRS (Supplemental
Restraint System) 188
 - Problems with the combustion
engine 188
 - Problems with the hybrid system ... 188
 - Program selector button 188
 - Pulling away 188

- RBS (Recuperative Brake System) 187
 - RBS (Recuperative Brake System) problems 188
 - READY indicator 188
 - Resetting values (COMAND) 188
 - Starting the vehicle 188
 - Stationary vehicle 188
 - Power locks** 92
 - Power washers** 253
 - Power windows**
see Side windows
 - PRE-SAFE® (anticipatory occupant protection)**
Operation 65
 - PRE-SAFE® Brake**
Activating/deactivating 194
Function/notes 82
Important safety notes 82
Warning lamp 219
 - PRE-SAFE® PLUS (anticipatory occupant protection PLUS)**
Operation 66
 - Program selector button** 139
 - Protection against theft**
ATA (Anti-Theft Alarm system) 84
Immobilizer 84
 - Protection of the environment**
General notes 25
 - Pulling away**
Automatic transmission 136
General notes 136
Hill start assist 137
- Q**
- QR code**
Rescue card 31
 - Qualified specialist workshop** 30
- R**
- Radio**
Selecting a station 194
see separate operating instructions
 - Radio mode**
see also Digital Operator's Manual 224
 - Radio-wave reception/transmission in the vehicle**
Declaration of conformity 29
 - Reading lamp** 119
 - Rear compartment**
Activating/deactivating climate control 129
Setting the air distribution 129
Setting the airflow 129
Setting the temperature 129
Stowage compartment 233
 - Rear fog lamp**
Display message 195
 - Rear lamps**
see Lights
 - Rear seats**
Adjusting 112
Overview 42
 - Rear view camera**
Cleaning instructions 253
Function/notes 173
Switching on/off 174
 - Rear window blind** 235
 - Rear window defroster**
Problem (malfunction) 129
Switching on/off 129
 - Rear-view mirror**
Anti-glare (manual) 113
Dipping (automatic) 113
 - Recuperative Brake System**
Driving safety systems 46
Important safety notes 46
 - Refrigerant (air-conditioning system)**
Important safety notes 326
 - Refueling**
Fuel gauge 35
Important safety notes 141
Refueling process 141
see Fuel
 - Remote control**
Garage door opener 240
Programming (garage door opener) 240
 - Replacing bulbs**
General notes 119
 - Reporting safety defects** 31
 - Rescue card** 31

- Reserve (fuel tank)**
 - see Fuel
 - Reserve fuel**
 - Display message 195
 - Warning lamp 211
 - Residual heat (climate control)** 129
 - Restraint system**
 - Display message 201
 - Introduction 47
 - Warning lamp 217
 - Warning lamp (function) 48
 - Reversing feature**
 - Panorama sliding sunroof 102
 - Roller sunblinds 103
 - Side windows 100
 - Trunk lid 94
 - Reversing lamps (display message)** 195
 - ROAD SURFACE SCAN** 169
 - Roadside Assistance (breakdown)** 27
 - Roller sunblind**
 - Panorama roof with power tilt/sliding panel 103
 - Rear side windows 235
 - Rear window 235
 - Roller sunblind of the panorama roof with power tilt/sliding panel**
 - Operating (front roller sunblind) 104
 - Operating (rear roller sunblind) 104
 - Roof**
 - Display message 195
 - Roof carrier** 234
 - Roof lining and carpets (cleaning guidelines)** 254
 - Roof load (maximum)** 327
 - Route (navigation)**
 - see Route guidance (navigation)
 - Route guidance**
 - see also Digital Operator's Manual 224
 - Route guidance (navigation)** 194
- S**
- Safety**
 - Occupant Classification System (OCS) 57
 - see Operating safety
 - Safety notes**
 - Hybrid vehicles 44
 - Safety system**
 - see Driving safety systems
 - SD memory card**
 - see also Digital Operator's Manual 224
 - Search & Send**
 - see also Digital Operator's Manual 224
 - Seat belt buckle extender**
 - Display message 200
 - Seat belt extender**
 - Function/notes 53
 - Seat belts**
 - Adjusting the driver's and front-passenger seat belt 53
 - Adjusting the height 52
 - Cleaning 254
 - Correct usage 51
 - Fastening 52
 - Important safety guidelines 49
 - Introduction 49
 - Releasing 53
 - Seat belt extender 53
 - Warning lamp 212
 - Warning lamp (function) 54
 - Seating**
 - Seating comfort package 112
 - Seating comfort package** 112
 - Seats**
 - Active multicontour seat 112
 - Adjusting (electrically) 112
 - Adjusting (rear compartment) 112
 - Adjusting the 4-way lumbar support 112
 - Chauffeur mode 112
 - Cleaning the cover 254
 - Correct driver's seat position 110
 - Display message 210
 - Important safety notes 111
 - Seat heating 112
 - Seat heating problem 113
 - Storing settings (memory function) 113
 - Switching seat heating on/off 112
 - Switching seat ventilation on/off .. 112

- Section**
Wheels and tires 276
- Selector lever**
see Automatic transmission
- Sensors (cleaning instructions)** 253
- Service menu (on-board computer)** 194
- Service products**
Brake fluid 324
Coolant (engine) 325
Engine oil 323
Fuel 322
Important safety notes 321
Refrigerant (air-conditioning system) 326
Washer fluid 326
- Setting the air distribution** 129
- Setting the airflow** 129
- Setting the date/time format**
see also Digital Operator's Manual 224
- Setting the language**
see also Digital Operator's Manual 224
- Setting the time**
see also Digital Operator's Manual 224
- Settings**
Factory (on-board computer) 194
On-board computer 194
- Side impact air bag** 56
- Side marker lamp (display message)** 195
- Side windows**
Cleaning 253
Important safety information 100
Opening/closing (all) 100
Opening/closing (front) 100
Problem (malfunction) 101
Resetting 100
- SIRIUS services**
see also Digital Operator's Manual 224
- Sliding sunroof**
see Panorama roof with power tilt/sliding panel
- SmartKey**
Changing the battery 91
Changing the programming 90
Checking the battery 91
Display message 195
Door central locking/unlocking 89
Important safety notes 88
KEYLESS-GO start function 90
Loss 92
Mechanical key 90
Overview 88
Positions (ignition lock) 133
Problem (malfunction) 92
Starting the engine 136
- SMS**
see also Digital Operator's Manual 224
- Snow chains** 279
- Sockets**
Center console 235
General notes 235
Rear compartment 235
Trunk 235
- Special seat belt retractor** 67
- Specialist workshop** 30
- Speed, controlling**
see Cruise control
- Speedometer**
In the Instrument cluster 35
Selecting the unit of measurement 194
see Instrument cluster
- Standing lamps**
Display message 195
Switching on/off 117
- Start/Stop button**
Removing 135
Starting the engine 136
- Start/stop function**
see ECO start/stop function
- Starting (engine)** 135
- STEER CONTROL** 84
- Steering**
Warning lamps 221
- Steering (display message)** 211
- Steering Assist (DISTRONIC PLUS)**
Display message 195

Steering assistant STEER CONTROL

see STEER CONTROL

Steering wheel

- Adjusting (electrically) 113
- Button overview 37
- Buttons (on-board computer) 191
- Important safety notes 113
- Paddle shifters 139
- Steering wheel heating 113
- Storing settings (memory function) 113

Steering wheel (cleaning instructions) 254**Steering wheel heating**

- Switching on/off 113

Steering wheel paddle shifters 139**Stowage areas** 232**Stowage compartments**

- Armrest (under) 233
- Center console 233
- Center console in rear compartment 233
- Cup holders 235
- Door 233
- Eyeglasses compartment 233
- Glove box 233
- Important safety information 232
- Rear 233
- Rear seat backrest 233
- Stowage net 233

Stowage net 233**Stowage space**

- Parcel net retainers 233
- Securing a load 233

Stowage well beneath the trunk floor 234**Summer tires**

- In winter 278

Sun visor 235**Suspension tuning**

- Active Body Control ABC 169
- AIRMATIC 170

Switching air-recirculation mode on/off 129**T****Tachometer** 190**Tail lamps**

- Display message 195
- see Lights

Tank content

- Fuel gauge 35

Technical data

- Capacities 321
- Information 320
- Tires/wheels 304
- Vehicle data 327

Telephone

- Accepting a call (multifunction steering wheel) 194
- Number from the phone book 194
- Redialing 194
- Rejecting/ending a call 194
- see also Digital Operator's Manual 224

Telephone keypad overview

- COMAND 230

Temperature

- Setting (climate control) 129

Tire pressure

- Calling up (on-board computer) 282
- Checking manually 282
- Display message 208
- Important safety notes 282
- Maximum 282
- Not reached (TIREFIT) 260
- Notes 280
- Reached (TIREFIT) 260
- Recommended 279

Tire pressure loss warning system

- General notes 285
- Important safety notes 285
- Restarting 286

Tire pressure monitor

- Checking the tire pressure electronically 284
- Function/notes 282
- General notes 282
- Important safety notes 282
- Radio type approval for the tire pressure monitor 285
- Restarting 284

- Warning lamp 220
- Warning message 284
- TIREFIT kit** 258
- Tires**
- Aspect ratio (definition) 297
- Average weight of the vehicle occupants (definition) 296
- Bar (definition) 296
- Changing a wheel 298
- Characteristics 296
- Checking 277
- Curb weight (definition) 297
- Definition of terms 296
- Direction of rotation 299
- Display message 208
- Distribution of the vehicle occupants (definition) 298
- DOT (Department of Transportation) (definition) 296
- DOT, Tire Identification Number (TIN) 295
- GAWR (Gross Axle Weight Rating) (definition) 296
- GVW (Gross Vehicle Weight) (definition) 297
- GVWR (Gross Vehicle Weight Rating) (definition) 297
- Important safety notes 276
- Increased vehicle weight due to optional equipment (definition) 296
- Kilopascal (kPa) (definition) 297
- Labeling (overview) 292
- Load bearing index (definition) 298
- Load index 295
- Load index (definition) 297
- Maximum load on a tire (definition) 297
- Maximum loaded vehicle weight (definition) 297
- Maximum permissible tire pressure (definition) 297
- Maximum tire load 295
- Maximum tire load (definition) 297
- MOExtended tires 278
- Optional equipment weight (definition) 298
- PSI (pounds per square inch) (definition) 297
- Replacing 298
- Service life 278
- Sidewall (definition) 298
- Speed rating (definition) 297
- Storing 299
- Structure and characteristics (definition) 296
- Summer tires in winter 278
- Temperature 292
- TIN (Tire Identification Number) (definition) 298
- Tire bead (definition) 298
- Tire pressure (definition) 297
- Tire pressures (recommended) 296
- Tire size (data) 304
- Tire size designation, load-bearing capacity, speed rating 292
- Tire tread 277
- Tire tread (definition) 298
- Total load limit (definition) 298
- Traction 291
- Traction (definition) 298
- Tread wear 291
- Uniform Tire Quality Grading Standards 291
- Uniform Tire Quality Grading Standards (definition) 296
- Wear indicator (definition) 298
- Wheel and tire combination 306
- Wheel rim (definition) 296
- see Flat tire
- Top Tether** 71
- Tow-starting**
- Emergency engine starting 272
- Important safety notes 269
- Towing away**
- Important safety guidelines 269
- Installing the towing eye 270
- Notes for 4MATIC vehicles 272
- Removing the towing eye 270
- With both axles on the ground 270
- With the rear axle raised 271
- Towing eye** 256
- Traffic reports**
- see also Digital Operator's Manual 224

Traffic Sign Assist

- Activating/deactivating the warning function 194
- Display message 195

Transfer case 140**Transmission**

- see Automatic transmission

Transporting the vehicle 271**Trim pieces (cleaning instructions)** 254**Trip computer (on-board computer)** 194**Trip odometer**

- Calling up 194

Trunk

- Emergency release 99
- Important safety notes 94
- Locking separately 98
- Opening/closing (automatically from inside) 98
- Opening/closing (automatically from outside) 95
- Opening/closing (from outside, HANDS-FREE ACCESS) 96
- Opening/closing (manually from outside) 95
- Power closing 92

Trunk lid

- Display message 195
- Obstacle recognition 94
- Opening dimensions 327
- Opening/closing 94

Trunk load (maximum) 327**Turn signals**

- Display message 195
- Switching on/off 117

TV

- see Separate operating instructions

Two-way radio

- Windshield (infrared reflective) 235

Type identification plate

- see Vehicle identification plate

U**Unlocking**

- Emergency unlocking 93

- From inside the vehicle (central unlocking button) 92

V**Vanity mirror (in the sun visor)** 235**Vehicle**

- Correct use 30
- Data acquisition 31
- Display message 210
- Equipment 26
- Limited Warranty 31
- Loading 286
- Locking (in an emergency) 93
- Locking (SmartKey) 89
- Lowering 303
- Maintenance 27
- Operating safety 28
- Parking for a long period 155
- Pulling away 136
- Raising 300
- Reporting problems 30
- Securing from rolling away 299
- Towing away 269
- Transporting 271
- Unlocking (in an emergency) 93
- Unlocking (SmartKey) 89
- Vehicle data 327

Vehicle dimensions 327**Vehicle emergency locking** 93**Vehicle Homepage**

- Data protection 153
- Functions 154
- General information 153
- Internet connection 154

Vehicle identification number

- see VIN

Vehicle identification plate 320**Vehicle level**

- Active Body Control ABC 169

Vehicle maintenance

- see ASSYST PLUS

Vehicle tool kit 256**Video**

- see also Digital Operator's Manual 224

Video (DVD) 194**VIN** 320

Voice Control System

see Separate operating instructions

W**Warning**

Stickers 44

Warning and indicator lamps

ABS 214

Brakes 213

Check Engine 211

Coolant 218

Distance warning 219

ESP® 216

ESP® OFF 217

General notes 211

Overview 36

PASSENGER AIR BAG 48

Reserve fuel 211

Restraint system 217

Seat belt 212

Steering 221

Tire pressure monitor 220

Warranty 26

Washer fluid

Display message 195

Wheel and tire combination

see Tires

Wheel bolt tightening torque 303

Wheel chock 299

Wheels

Changing a wheel 298

Checking 277

Cleaning 253

Important safety notes 276

Interchanging/changing 298

Mounting a new wheel 303

Mounting a wheel 299

Removing a wheel 302

Storing 299

Tightening torque 303

Wheel size/tire size 304

Window curtain air bag

Operation 57

Windows

see Side windows

Windshield

Defrosting 129

Infrared reflective 235

Windshield washer fluid

see Windshield washer system

Windshield washer system

Adding washer fluid 251

Notes 326

Windshield wipers

Problem (malfunction) 122

Replacing the wiper blades 120

Switching on/off 120

Winter driving

Important safety notes 278

Slippery road surfaces 157

Snow chains 279

Winter operation

Summer tires 278

Winter tires

M+S tires 278

Wiper blades

Cleaning 253

Important safety notes 120

Replacing 120

Wooden trim (cleaning instructions)

..... 254

Workshop

see Qualified specialist workshop

Introduction

The printed Operator's Manual provides information about the safe operation of your vehicle. The Digital Operator's Manual additionally describes further functions and equipment installed in your vehicle. The vehicle functions and functions of COMAND are described in the Digital Operator's Manual. You can call up the Digital Operator's Manual via COMAND.

- i** You will not incur any costs when calling up the Digital Operator's Manual. The Digital Operator's Manual works without connecting to the Internet.

There are three ways to access the topics of the Digital Operator's Manual:

• Visual search

The visual search allows you to explore your vehicle "virtually". Starting from either the vehicle exterior view or interior view, you can access many of the different topics covered by the Digital Operator's Manual. To access the vehicle interior section, select the "Vehicle interior" view.

• Keyword Search

The keyword search allows you to search for a keyword by entering characters. Further information can be found in the Digital Operator's Manual in the "COMAND" section under the "Character entry (telephony)" keyword.





• Contents

You can select individual sections in the contents.

- i** The Digital Operator's Manual is deactivated for safety reasons while driving.

Operation

Calling up the Digital Operator's Manual

- ▶ Press the  button in the center console. The overview relating to the vehicle opens.
- ▶ Select the "Operator's Manual" menu item by turning  or sliding  the controller.
- ▶ Confirm  the message about the warning and safety notes. The basic menu for the Digital Operator's Manual opens.

Operating the Digital Operator's Manual



General notes





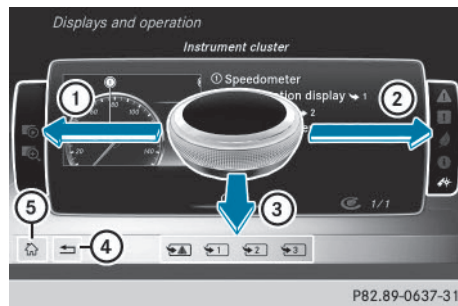







Please observe the information about the operation of the controller ([▷ page 228](#)).

Content pages

The content pages can be accessed by means of a visual search, a keyword search or using the contents.



- ▶ **To scroll forward/backward:** turn  the controller.
- ▶ **To display in full-screen/animation:** slide  the controller to the left .

- ▶ **To select information texts/save bookmarks:** slide  the controller to the right .
- ▶ **To select a link:** slide  the controller downwards .
- ▶ **To exit a content page:** actuate the   symbol.
- ▶ **To call up the basic menu of the Digital Operator's Manual:** actuate symbol  .
- ▶ **To switch functions to COMAND using the buttons on the center console:** press the , ,  or  button. The selected menu opens. The Digital Operator's Manual remains open in the background.

Protection of the environment

General notes

Environmental note

Daimler's declared policy is one of comprehensive environmental protection.

The objectives are for the natural resources that form the basis of our existence on this planet to be used sparingly and in a manner that takes the requirements of both nature and humanity into account.

You too can help to protect the environment by operating your vehicle in an environmentally responsible manner.

Fuel consumption and the rate of engine, transmission, brake and tire wear are affected by these factors:

- operating conditions of your vehicle
- your personal driving style

You can influence both factors. You should bear the following in mind:

Operating conditions:

- avoid short trips as these increase fuel consumption.
- always make sure that the tire pressures are correct.
- do not carry any unnecessary weight.
- remove roof racks once you no longer need them.
- a regularly serviced vehicle will contribute to environmental protection. You should therefore adhere to the service intervals.
- always have service work carried out at a qualified specialist workshop.

Personal driving style:

- do not depress the accelerator pedal when starting the engine.
- do not warm up the engine when the vehicle is stationary.
- drive carefully and maintain a safe distance from the vehicle in front.
- avoid frequent, sudden acceleration and braking.

- change gear in good time and use each gear only up to $\frac{2}{3}$ of its maximum engine speed.
- switch off the engine in stationary traffic.
- keep an eye on the vehicle's fuel consumption.

Environmental note

Have a defective high-voltage battery disposed of in an environmentally-responsible manner. Contact a qualified specialist workshop which has the necessary specialist knowledge and tools to carry out the work required. Mercedes-Benz recommends that you use an authorized Mercedes-Benz Center for this purpose.

Environmental concerns and recommendations

Wherever the operating instructions require you to dispose of materials, first try to regenerate or re-use them. Observe the relevant environmental rules and regulations when disposing of materials. In this way you will help to protect the environment.

Genuine Mercedes-Benz parts

Environmental note

Daimler AG also supplies reconditioned major assemblies and parts which are of the same quality as new parts. They are covered by the same Limited Warranty entitlements as new parts.

! Air bags and Emergency Tensioning Devices, as well as control units and sensors for these restraint systems, may be installed in the following areas of your vehicle:

- doors
- door pillars
- door sills
- seats
- cockpit

- instrument cluster
- center console

Do not install accessories such as audio systems in these areas. Do not carry out repairs or welding. You could impair the operating efficiency of the restraint systems.

Have aftermarket accessories installed at a qualified specialist workshop.

You could jeopardize the operating safety of your vehicle if you use parts, tires and wheels as well as accessories relevant to safety which have not been approved by Mercedes. This could lead to malfunctions in safety-relevant systems, e.g. the brake system. Use only genuine Mercedes-Benz parts or parts of equal quality. Only use tires, wheels and accessories that have been specifically approved for your vehicle.

Genuine Mercedes-Benz parts are subject to strict quality control. Every part has been specifically developed, manufactured or selected for and adapted to Mercedes-Benz vehicles. Only genuine Mercedes-Benz parts should therefore be used.

More than 300,000 different genuine Mercedes-Benz parts are available for Mercedes-Benz models.

All authorized Mercedes-Benz Centers maintain a supply of genuine Mercedes-Benz parts for necessary service and repair work. In addition, strategically located parts delivery centers provide quick and reliable parts service. Always specify the vehicle identification number (VIN) when ordering genuine Mercedes-Benz parts (▷ page 320).

Operator's Manual

Vehicle equipment

This Operator's Manual describes all models and all standard and optional equipment of your vehicle available at the time of going to print. Country-specific differences are possible. Bear in mind that your vehicle may not

feature all functions described here. This also applies to safety-relevant systems and functions. The equipment in your vehicle may therefore differ from that shown in the descriptions and illustrations.

The original purchase agreement lists all systems installed in your vehicle.

Should you have any questions concerning equipment and operation, please consult an authorized Mercedes-Benz Center.

The Operator's Manual and Maintenance Booklet are important documents and should be kept in the vehicle.

Service and vehicle operation

Warranty

The implied warranty for your vehicle applies in accordance with the warranty terms and conditions in the Service and Warranty Information booklet.

Your authorized Mercedes-Benz Center will replace and repair all factory-installed parts in accordance with the following warranty terms and conditions:

- New Vehicle Limited Warranty
- Emission System Warranty
- Emission Performance Warranty
- California, Connecticut, Maine, Massachusetts, New York, Pennsylvania, Rhode Island and Vermont Emission Control System Warranty
- State warranty enforcement laws (lemon laws)

Replacement parts and accessories are covered by the Mercedes-Benz Parts and Accessories warranties. These are available at any authorized Mercedes-Benz Center.

i Should you lose your Service and Warranty Information booklet, have an authorized Mercedes-Benz Center arrange for a replacement. The new Service and Warranty Information booklet will be posted to you.

Information for customers in California

Under California law you may be entitled to a replacement of your vehicle or a refund of the purchase price or lease price, if after a reasonable number of repair attempts Mercedes-Benz USA, LLC and/or its authorized repair or service facilities fail to fix one or more substantial defects or malfunctions in the vehicle that are covered by its express warranty. During the period of 18 months from original delivery of the vehicle or the accumulation of 18,000 miles (approximately 29,000 km) on the odometer of the vehicle, whichever occurs first, a reasonable number of repair attempts is presumed for a retail buyer or lessee if one or more of the following occurs:

- (1) the same substantial defect or malfunction results in a condition that is likely to cause death or serious bodily injury if the vehicle is driven, that defect or malfunction has been subject to repair two or more times, and you have directly notified Mercedes-Benz USA, LLC in writing of the need for its repair,
- (2) the same substantial defect or malfunction of a less serious nature than category (1) has been subject to repair four or more times and you have directly notified us in writing of the need for its repair, or
- (3) the vehicle is out of service by reason of repair of the same or different substantial defects or malfunctions for a cumulative total of more than 30 calendar days.

Please send your written notice to:
 Mercedes-Benz USA, LLC
 Customer Assistance Center
 One Mercedes Drive
 Montvale, NJ 07645-0350

Maintenance

The Service and Warranty Booklet describes all the necessary maintenance work which should be done at regular intervals.

Always have the Service and Warranty Booklet with you when you bring the vehicle to an authorized Mercedes-Benz Center. The service advisor will record every service for you in the Service and Warranty Booklet.

Roadside Assistance

The Mercedes-Benz Roadside Assistance Program offers technical help in the event of a breakdown. Calls to the toll-free Roadside Assistance Hotline are answered by our agents 24 hours a day, 365 days a year.

1-800-FOR-MERCEdes(1-800-367-6372) (USA)

1-800-387-0100 (Canada)

For additional information, refer to the Mercedes-Benz Roadside Assistance Program brochure (USA) or the "Roadside Assistance" section in the Service and Warranty booklet (Canada). You will find both in your vehicle literature portfolio.

Change of address or change of ownership

In the event of a change of address, please send us the "Notification of Address Change" in the Service and Guarantee booklet or simply call the Mercedes-Benz Customer Assistance Center (USA) at the hotline number 1-800-FOR-MERCEdes(1-800-367-6372) or Customer Service Center (Canada) at 1-800-387-0100. This will assist us in contacting you in a timely manner should the need arise.

If you sell your Mercedes, please leave the entire literature in the vehicle so that it is available to the next owner.

If you have purchased a used car, please send us the "Notification of Used Car Purchase" in

the Service and Guarantee booklet or simply call the Mercedes-Benz Customer Assistance Center (USA) at the hotline number 1-800-FOR-MERCEDES(1-800-367-6372) or Customer Service (Canada) at 1-800-387-0100.

Vehicle operation outside the USA and Canada

If you plan to operate your vehicle in foreign countries, please be aware that:

- service facilities or replacement parts may not be readily available.
- unleaded fuel for vehicles with a catalytic converter may not be available. Leaded fuel may cause damage to the catalytic converter.
- the fuel may have a considerably lower octane rating. Unsuitable fuel can cause engine damage.

Some Mercedes-Benz models are available for delivery in Europe through our European Delivery Program. For details, consult an authorized Mercedes-Benz Center or write to one of the following addresses.

In the USA

Mercedes-Benz USA, LLC
European Delivery Department
One Mercedes Drive
Montvale, NJ 07645-0350

In Canada

Mercedes-Benz Canada, Inc.
European Delivery Department
98 Vanderhoof Avenue
Toronto, Ontario M4G 4C9

Operating safety

Important safety notes

WARNING

If you do not have the prescribed service/maintenance work or any required repairs

carried out, this can result in malfunctions or system failures. There is a risk of an accident. Always have the prescribed service/maintenance work as well as any required repairs carried out at a qualified specialist workshop.

WARNING

Flammable material such as leaves, grass or twigs may ignite if they come into contact with hot parts of the exhaust system. There is a risk of fire.

When driving off road or on unpaved roads, check the vehicle's underside regularly. In particular, remove parts of plants or other flammable materials which have become trapped. In the case of damage, contact a qualified specialist workshop.

WARNING

Modifications to electronic components, their software as well as wiring can impair their function and/or the function of other networked components. In particular, systems relevant to safety could also be affected. As a result, these may no longer function as intended and/or jeopardize the operating safety of the vehicle. There is an increased risk of an accident and injury.

Never tamper with the wiring as well as electronic components or their software. You should have all work to electrical and electronic equipment carried out at a qualified specialist workshop.

If you make any changes to the vehicle electronics, the general operating permit is rendered invalid.

 There is a risk of damage to the vehicle if:

- the vehicle becomes stuck, e.g. on a high curb or an unpaved road
- you drive too fast over an obstacle, e.g. a curb or a hole in the road
- a heavy object strikes the undercarriage or parts of the chassis

In situations like this, the body, the undercarriage, chassis parts, wheels or tires could be damaged without the damage being visible. Components damaged in this way can unexpectedly fail or, in the case of an accident, no longer withstand the strain they are designed to.

If the underbody paneling is damaged, combustible materials such as leaves, grass or twigs can gather between the underbody and the underbody paneling. If these materials come in contact with hot parts of the exhaust system, they can catch fire.

In such situations, have the vehicle checked and repaired immediately at a qualified specialist workshop. If on continuing your journey you notice that driving safety is impaired, pull over and stop the vehicle immediately, paying attention to road and traffic conditions. In such cases, consult a qualified specialist workshop.

Hybrid vehicles have a combustion engine and an electric motor. The voltage supply for operating the vehicle electrically is provided by the vehicle's high-voltage electrical system.

DANGER

The vehicle's high voltage electrical system is under high voltage. If you modify components in the vehicle's high-voltage electrical system or touch damaged components, you may be electrocuted. The components in the vehicle's high-voltage electrical system may be damaged in an accident, although the damage is not visible. There is a risk of fatal injury.

Following an accident, do not touch any high-voltage components and never modify the vehicle's high-voltage electrical system. Have the vehicle towed away after an accident and the vehicle's high-voltage electrical system checked by a qualified specialist workshop.

The components of the vehicle's high-voltage electrical system are marked with yellow warning stickers. The cables of the vehicle's

high-voltage electrical system are orange in color.

Vehicles with an electric motor generate much less driving noise than vehicles with internal combustion engines. As a result, your vehicle may not be heard by other road users in certain situations. This can happen, for example, when you are parking and your vehicle is not seen by other road users. This requires you to adopt a particularly anticipatory driving style, as it is necessary to allow for the possibility that other road users may behave erratically.

Declarations of conformity

Vehicle components which receive and/or transmit radio waves

USA: "The wireless devices of this vehicle comply with Part 15 of the FCC Rules. Operation is subject to the following two conditions: 1) These devices may not cause harmful interference, and 2) These devices must accept any interference received, including interference that may cause undesired operation. Changes or modifications not expressly approved by the party responsible for compliance could void the user's authority to operate the equipment."

Canada: "The wireless devices of this vehicle comply with Industry Canada license-exempt RSS standard(s). Operation is subject to the following two conditions: (1) These devices may not cause interference, and (2) These devices must accept any interference, including interference that may cause undesired operation of the device."

Diagnostics connection

The diagnostics connection is only intended for the connection of diagnostic equipment at a qualified specialist workshop.

⚠ WARNING

If you connect equipment to the diagnostics connection in the vehicle, it may affect the operation of the vehicle systems. As a result, the operating safety of the vehicle could be affected. There is a risk of an accident.

Do not connect any equipment to a diagnostics connection in the vehicle.

⚠ WARNING

Objects in the driver's footwell can restrict the pedal travel or obstruct a depressed pedal. The operating and road safety of the vehicle is jeopardized. There is a risk of an accident.

Make sure that all objects in the vehicle are stowed correctly, and that they cannot enter the driver's footwell. Install the floor mats securely and as specified in order to ensure sufficient clearance for the pedals. Do not use loose floor mats and do not place floor mats on top of one another.

! If the engine is switched off and equipment on the diagnostics connection is used, the starter battery may discharge.

Connecting equipment to the diagnostics connection can lead to emissions monitoring information being reset, for example. This may lead to the vehicle failing to meet the requirements of the next emissions test during the main inspection.

Qualified specialist workshop

An authorized Mercedes-Benz Center is a qualified specialist workshop. It has the necessary specialist knowledge, tools and qualifications to correctly carry out the work required on your vehicle. This is especially the case for work relevant to safety.

Observe the notes in the Maintenance Booklet.

Always have the following work carried out at an authorized Mercedes-Benz Center:

- work relevant to safety
- service and maintenance work
- repair work
- alterations, installation work and modifications
- work on electronic components
- work on the hybrid system

Correct use

If you remove any warning stickers, you or others could fail to recognize certain dangers. Leave warning stickers in position.

Observe the following information when driving your vehicle:

- the safety notes in this manual
- the Technical Data section in this manual
- traffic rules and regulations
- laws and safety standards pertaining to motor vehicles

Problems with your vehicle

If you should experience a problem with your vehicle, particularly one that you believe may affect its safe operation, we urge you to contact an authorized Mercedes-Benz Center immediately to have the problem diagnosed and rectified. If the problem is not resolved to your satisfaction, please discuss the problem again with a Mercedes-Benz Center or contact us at one of the following addresses.

In the USA

Customer Assistance Center
Mercedes-Benz USA, LLC
One Mercedes Drive
Montvale, NJ 07645-0350

In Canada

Customer Relations Department
Mercedes-Benz Canada, Inc.
98 Vanderhoof Avenue

Toronto, Ontario M4G 4C9

Reporting safety defects

USA only:

The following text is published as required of manufacturers under Title 49, Code of U.S. Federal Regulations, Part 575 pursuant to the "National Traffic and Motor Vehicle Safety Act of 1966".

If you believe that your vehicle has a defect which could cause a crash or could cause injury or death, you should immediately inform the National Highway Traffic Safety Administration (NHTSA) in addition to notifying Mercedes-Benz USA, LLC.

If NHTSA receives similar complaints, it may open an investigation, and if it finds that a safety defect exists in a group of vehicles, it may order a recall and remedy campaign. However, NHTSA cannot become involved in individual problems between you, your dealer, or Mercedes-Benz USA, LLC.

To contact NHTSA, you may call the Vehicle Safety Hotline toll-free at 1-888-327-4236 (TTY: 1-800-424-9153); go to <http://www.safercar.gov>; or write to: Administrator, NHTSA, 400 Seventh Street, SW., Washington, DC 20590.

You can also obtain other information about motor vehicle safety from

<http://www.safercar.gov>

Limited Warranty

! Follow the instructions in this manual about the proper operation of your vehicle as well as about possible vehicle damage. Damage to your vehicle that arises from culpable contraventions against these instructions is not covered either by the Mercedes-Benz Limited Warranty or by the New or Used-Vehicle Warranty.

QR codes for the rescue card

The QR code is secured in the fuel filler flap and on the opposite side on the B-pillar. In the event of an accident, rescue services can use the QR code to quickly find the appropriate rescue card for your vehicle. The current rescue card contains the most important information about your vehicle in a compact form, e.g. the routing of the electric cables.

You can find more information at <https://portal.aftersales.i.daimler.com>.

Data stored in the vehicle

Data recording

This vehicle is capable of recording diagnostic information relating to vehicle operation, malfunctions, and user settings. This may include information about the performance or status of various systems, including but not limited to, engine, throttle, steering or brake systems, that is stored and can be read out with suitable devices, particularly when the vehicle is serviced. The data obtained is used to properly diagnose and service your vehicle or to further optimize and develop vehicle functions.

COMAND/mbrace

If the vehicle is equipped with COMAND or mbrace, additional data about the vehicle's operation, the use of the vehicle in certain situations, and the location of the vehicle may be compiled through COMAND or the mbrace system.

For additional information please refer to the COMAND User Manual and/or the mbrace Terms and Conditions.

Event data recorders

This vehicle is equipped with an event data recorder (EDR). The main purpose of an EDR

is to record data that will assist in understanding how a vehicle's systems performed in certain crash or near crash-like situations, such as during air bag deployment or when hitting a road obstacle. The EDR is designed to record data related to vehicle dynamics and safety systems for a short period of time, typically 30 seconds or less.

The EDR in this vehicle is designed to record such data as:

- how various systems in your vehicle are operating
- whether or not the driver and passenger seat belts are fastened
- how far (if at all) the driver is depressing the accelerator and/or brake pedal and
- how fast the vehicle is traveling

This data can help provide a better understanding of the circumstances in which crashes and injuries occur. NOTE: EDR data is recorded by your vehicle only if a non-trivial crash situation occurs; no data is recorded by the EDR under normal driving conditions and no personal data (e.g., name, gender, age, and crash location) are recorded. However, other parties, such as law enforcement, can combine the EDR data with the type of personal identification data routinely acquired during a crash investigation.

To read data recorded by an EDR, special equipment is required, and access to the vehicle or the EDR is needed. In addition to the vehicle manufacturer, other parties that have the special equipment, such as law enforcement, can read the information by accessing the vehicle or the EDR.

EDR data may be used in civil and criminal matters as a tool in accident reconstruction, accident claims, and vehicle safety. Since the Crash Data Retrieval CDR tool that is used to extract data from the EDR is commercially available, Mercedes-Benz USA, LLC ("MBUSA") expressly disclaims any and all liability arising from the extraction of this information by unauthorized Mercedes-Benz personnel.

MBUSA will not share EDR data with others without the consent of the vehicle owners or, if the vehicle is leased, without the consent of the lessee. Exceptions to this representation include responses to subpoenas by law enforcement; by federal, state or local government; in connection with or arising out of litigation involving MBUSA or its subsidiaries and affiliates; or, as required by law.

Warning: The EDR is a component of the Restraint System Module. Tampering with, altering, modifying or removing the EDR component may result in a malfunction of the Restraint System Module and other systems.

State laws or regulations regarding EDRs that conflict with federal regulation are pre-empted. This means that in the event of such conflict, the federal regulation governs. As of February 2013, 13 states have enacted laws relating to EDRs.

Information on copyright

General information

Information on license for free and open-source software used in your vehicle and its electronic components is available on the following website:

<http://www.mercedes-benz.com/opensource>

Cockpit 34
Instrument cluster 35
Multifunction steering wheel 37
Center console 39
Overhead control panel 40
Door control panel 41
Rear seats 42

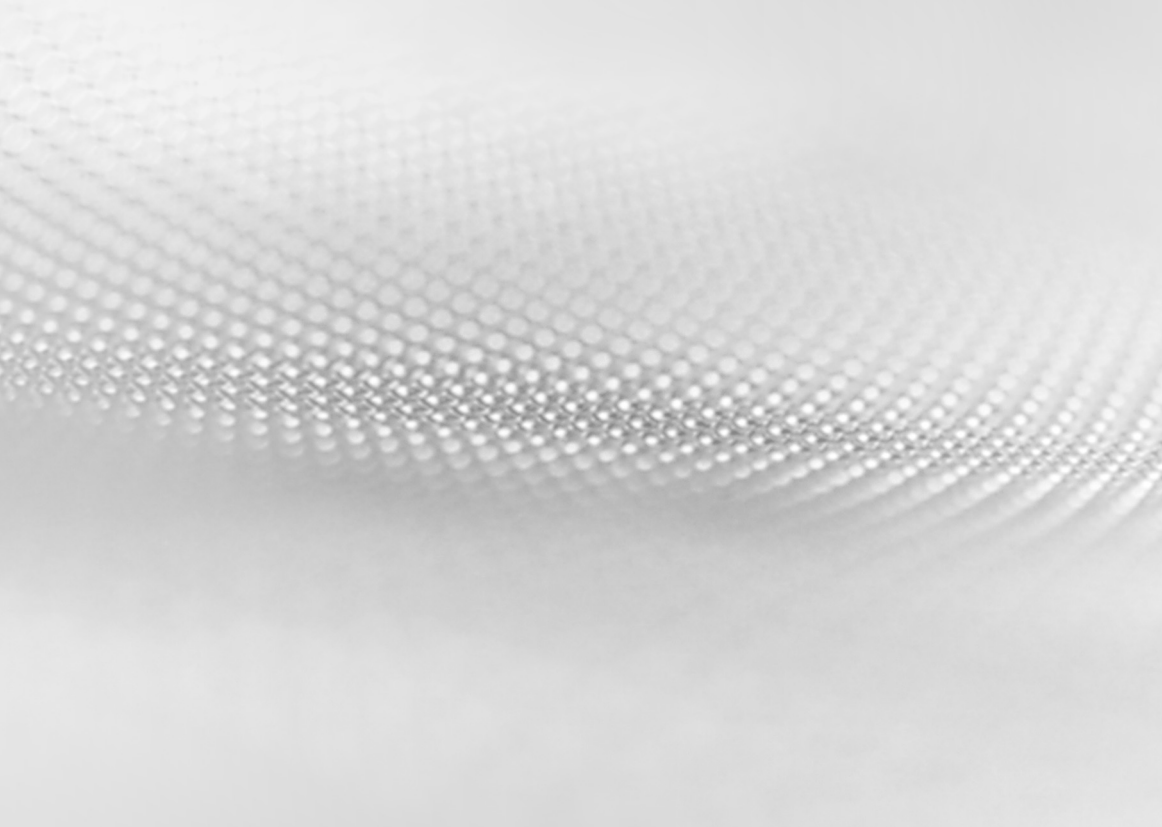

Cockpit

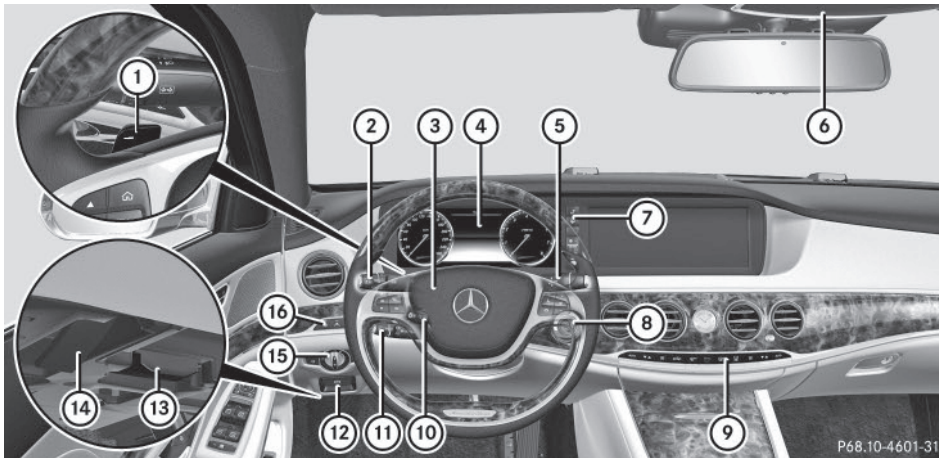

| | Function | Page |
|---|---|-------------------|
| ① | Steering wheel paddle shifters | |
| ② | Combination switch | 117 |
| ③ | Horn | |
| ④ | Instrument cluster | 35 |
| ⑤ | DIRECT SELECT lever | 138 |
| ⑥ | Overhead control panel | 40 |
| ⑦ | Control panel for: Lowering the rear seat head restraints Extending/retracting the rear roller sunblind PASSENGER AIR BAG indicator lamp Setting the brightness of the instrument cluster lighting and the COMAND display | 235 48 |
| ⑧ | Ignition lock | 133 |
| | Start/Stop button | 133 |
| ⑨ | Climate control systems | 124 |



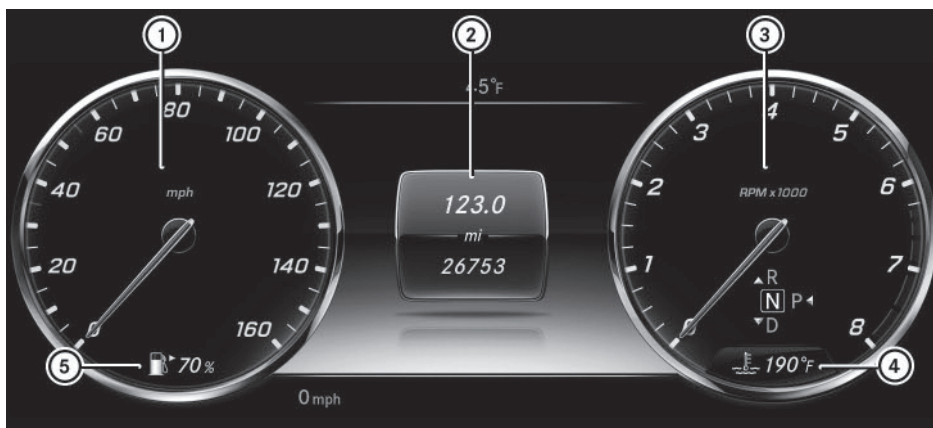

| | Function | Page |
|---|--|---|
| ⑩ | Adjusts the steering wheel Steering wheel heating | |
| ⑪ | Cruise control lever | 159 |
| ⑫ | Electric parking brake | 155 |
| ⑬ | Diagnostics connection | 29 |
| ⑭ | Opens the hood | 246 |
| ⑮ | Light switch | 116 |
| ⑯ | Control panel for: Activating Steering Assist and Stop&Go Pilot Switching on Active Lane Keeping Assist Deactivating PARKTRONIC Switching on the 360° camera Activating Night View Assist Switching on the head-up display | 165 184 171 175 178 |

Instrument cluster

Displays and controls



P54.33-3001-31

| | Function | Page | | Function | Page |
|---|--|--|---|--|---|
| ① | Speedometer | | ④ | Coolant temperature |  |
| ② | Multifunction display with outside temperature display |  | ⑤ | Fuel level and fuel filler flap location indicator |  |
| ③ | Tachometer |  | | | |

Fuel filler flap location indicator : the fuel filler cap is on the right-hand side.

Warning and indicator lamps

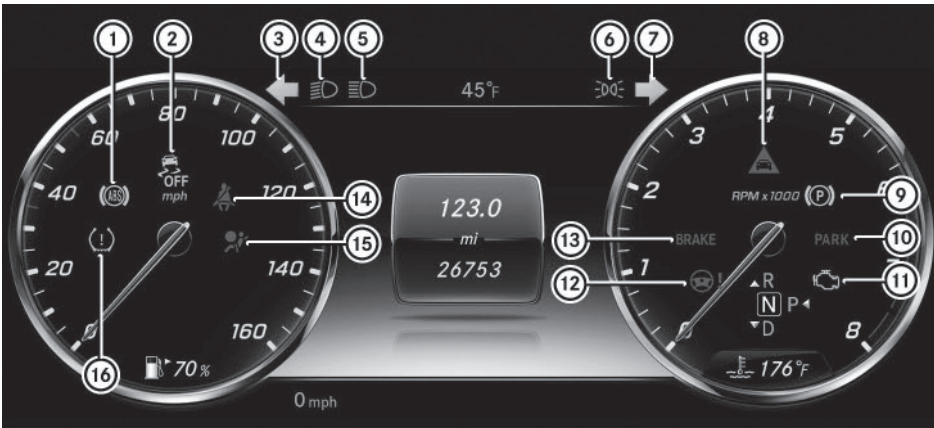

P54.33-3003-31

| | Function | Page |
|---|---|------------|
| ① | ABS | 214 |
| ② | ESP® OFF ESP® | 216 216 |
| ③ | Turn signal, left | |
| ④ | Low-beam headlamps | |
| ⑤ | High-beam headlamps | |
| ⑥ | Parking lamps, license plate lamp and instrument cluster lighting | 117 |
| ⑦ | Turn signal, right | 117 |
| ⑧ | Distance warning signal | 219 |

| | Function | Page |
|---|---|------|
| ⑨ | Electric parking brake (yellow) | |
| ⑩ | Electric parking brake (red) USA only Canada only | |
| ⑪ | Check Engine | 211 |
| ⑫ | Power steering | 221 |
| ⑬ | Brakes (red) USA only Canada only | 213 |
| ⑭ | Seat belt | 212 |
| ⑮ | Restraint system | 217 |
| ⑯ | Tire pressure monitor | 220 |

i Information on warning and indicator lamps in PLUG-IN HYBRID vehicles can be found in the "PLUG-IN HYBRID drive" section in the Digital Operator's Manual.

Multifunction steering wheel

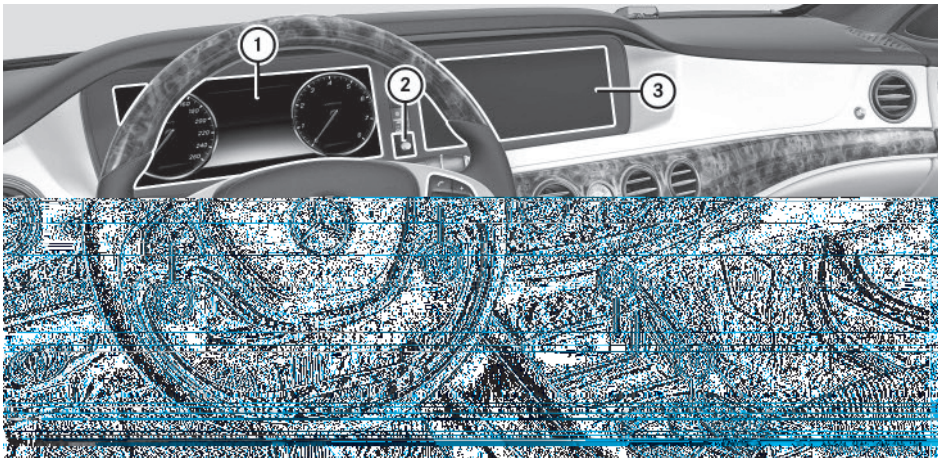











At a glance

| | Function | Page |
|---|---|------|
| ① | Multifunction display | |
| ② | Sets the brightness of the instrument cluster lighting and the COMAND display | |
| ③ | COMAND display; see the separate COMAND operating instructions | |
| ④ | CD and DVD player / changer; see the separate COMAND operating instructions | |
| ⑤ | COMAND controller and buttons; see the separate COMAND operating instructions | |

| | Function | Page |
|---|---|------|
| ⑥ | Rejects or ends a call Exits phone book/redial memory Makes or accepts a call Switches to the redial memory Adjusts the volume Mute Switches on the Voice Control System; see the separate operating instructions | |

At a glance

| | Function | Page |
|---|--|---|
| ⑦ |  Calls up the main menu | |
| |   Selects a menu/submenu or scrolls through lists |  |
| |  Confirms your selection |  |
| | Hides display messages |  |
| |  Back |  |
| |  Switches off the Voice Control System; see the separate operating instructions | |

Center console

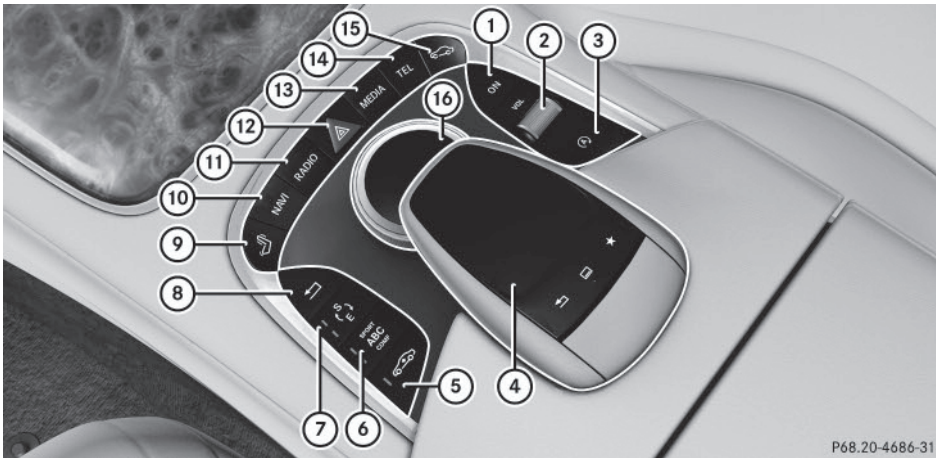

P68.20-4686-31

At a glance

| | Function | Page | | Function | Page |
|---|--|-------------|---|---|------|
| ① | Switches COMAND on/off | | ⑧ | Back button | |
| ② | Adjusts the volume/mute | | ⑨ | Seat adjustment button | |
| ③ | ECO start/stop function | | ⑩ | Navigation button | |
| ④ | Touchpad Telephone keypad | | ⑪ | Radio button | |
| ⑤ | Sets the vehicle level | 169, 169 | ⑫ | Hazard warning lamps | 116 |
| | Selects the operating mode (PLUG-IN HYBRID vehicles) | 188 | ⑬ | Media button | |
| ⑥ | Adjusts the suspension settings | 169, 169 | ⑭ | Telephone, address book and Internet button | |
| ⑦ | Selects the drive program/program selector button | 139 | ⑮ | Vehicle and system settings button | |
| | Selects the drive program/program selector button (AMG vehicles) | 139 | ⑯ | COMAND controller | |
| | Selects automatic drive programs E, S and E+ (PLUG-IN HYBRID vehicles) | | | | |

i Information on the ECO start/stop function for PLUG-IN HYBRID vehicles can be

found in the "PLUG-IN hybrid drive" section in the Digital Operator's Manual.

Overhead control panel

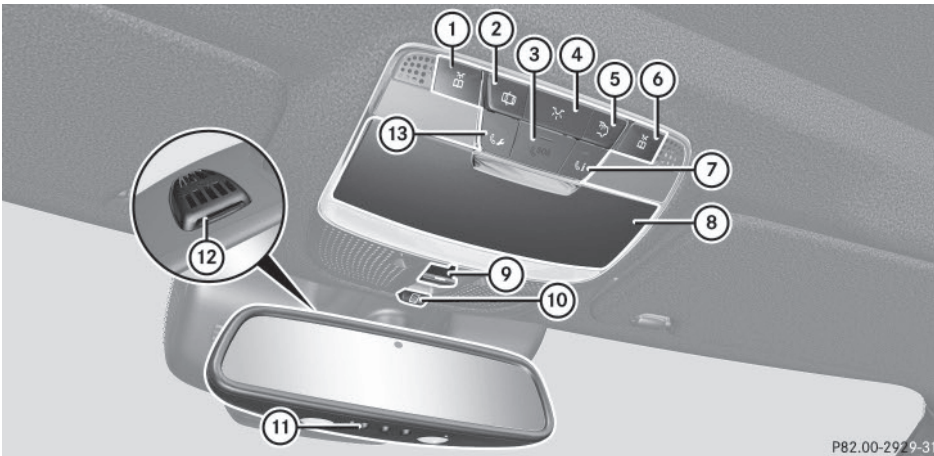

P82.00-29 9-31

| | Function | Page |
|---|--|------|
| ① | Switches the left-hand reading lamp on/off | |
| ② | Switches the automatic interior lighting control on/off | |
| ③ | SOS button (mbrace system) | 237 |
| ④ | Switches the front interior lighting on/off | |
| ⑤ | Switches the rear interior lighting on/off | |
| ⑥ | Switches the right-hand reading lamp on/off | |
| ⑦ | MB Info call button (mbrace system) | 239 |
| ⑧ | Eyeglasses compartment | |
| ⑨ | Opens/closes the panorama roof with power tilt/sliding panel | 102 |
| | Opens/closes the front roller sunblinds | 104 |

| | Function | Page |
|---|--|------------|
| ⑩ | Operates MAGIC SKY CONTROL Opens/closes the rear roller sunblind | 105 104 |
| ⑪ | Buttons for the garage door opener | 240 |
| ⑫ | Microphone for mbrace (emergency call system), telephone and the Voice Control System; see the separate operating instructions | |
| ⑬ | Roadside Assistance call button (mbrace system) | 238 |

Door control panel

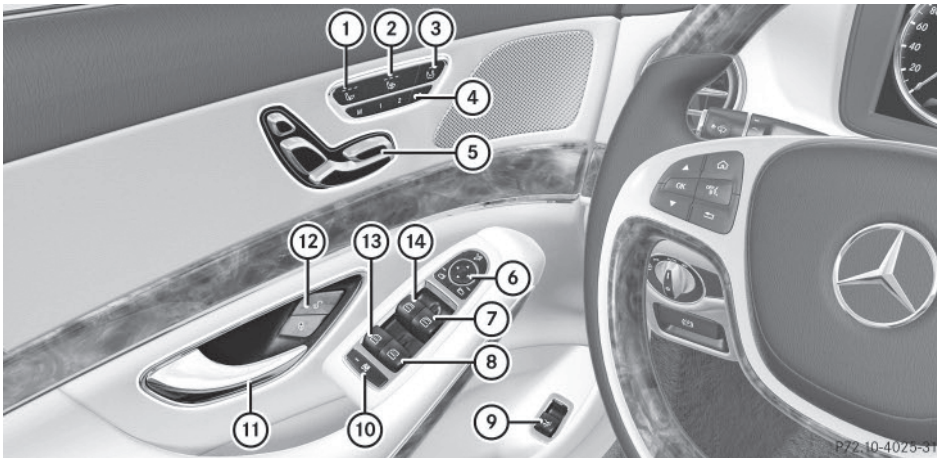

At a glance

| | Function | Page |
|---|--|------|
| ① | Seat ventilation | |
| ② | Seat heating | |
| ③ | Adjusts the front-passenger seat from the driver's seat | |
| ④ | M 1 2 3 Stores settings for the seat, exterior mirrors and steering wheel | 113 |
| ⑤ | Adjusts the seats electrically | |
| ⑥ | Adjusts and folds the exterior mirrors in/out electrically | |
| ⑦ | Opens/closes the right side window | |

| | Function | Page |
|---|---|------|
| ⑧ | Opens/closes the rear right side window | |
| ⑨ | Opens/closes the trunk lid | 98 |
| ⑩ | Override feature for the controls in the rear compartment | 73 |
| ⑪ | Opens the door | |
| ⑫ | Unlocks/locks the vehicle | |
| ⑬ | Opens/closes the rear left side window | |
| ⑭ | Opens/closes the left side window | |

Rear seats

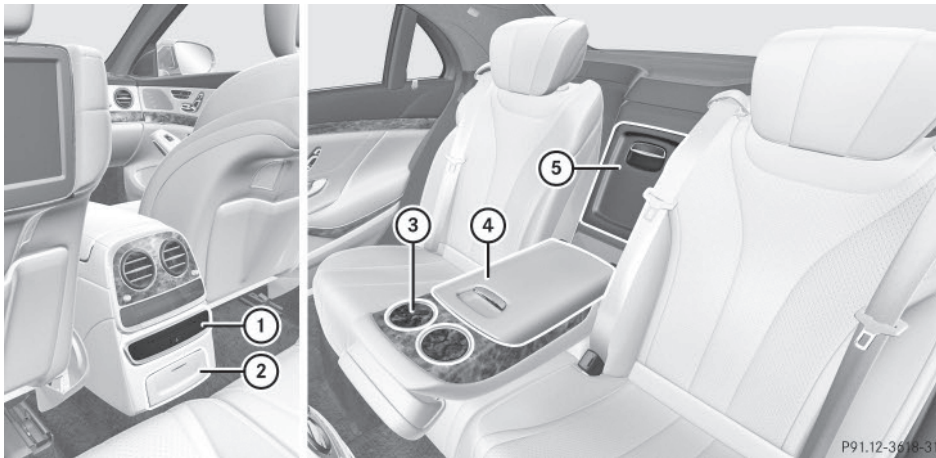

P91.12-36/8-31

i Example: vehicles with Rear Seat Entertainment System

| | Function | Page |
|---|-----------------------------|------|
| ① | DVD player | |
| ② | Cigarette lighter Socket | |
| ③ | Cup holder | |

| | Function | Page |
|---|---|------|
| ④ | Stowage compartment in the rear seat armrest | |
| ⑤ | Stowage box in the seat backrest Coolbox | |

| | |
|--------------------------------|----|
| Useful information | 44 |
| Hybrid vehicles | 44 |
| Panic alarm | 47 |
| Occupant safety | 47 |
| Children in the vehicle | 67 |
| Pets in the vehicle | 74 |
| Driving safety systems | 74 |
| Protection against theft | 84 |

Useful information

- i** This Operator's Manual describes all models and all standard and optional equipment of your vehicle available at the time of publication of the Operator's Manual. Country-specific differences are possible. Please note that your vehicle may not be equipped with all features described. This also applies to safety-related systems and functions.
- i** Read the information on qualified specialist workshops (> page 30).

Hybrid vehicles

General notes

Hybrid technology combines a fuel efficient internal combustion engine with a powerful electric motor.

Important safety notes

Danger of electric shock

DANGER

The vehicle's high voltage electrical system is under high voltage. If you modify components in the vehicle's high-voltage electrical system or touch damaged components, you may be electrocuted. The components in the vehicle's high-voltage electrical system may be damaged in an accident, although the damage is not visible. There is a risk of fatal injury. Following an accident, do not touch any high-voltage components and never modify the vehicle's high-voltage electrical system. Have the vehicle towed away after an accident and the vehicle's high-voltage electrical system checked by a qualified specialist workshop.

When towing a vehicle after an accident, be sure to observe the following sections:

- Transporting the vehicle (> page 271)
- Towing the vehicle with the rear axle raised (> page 271)
- Towing a vehicle with both axles on the ground (> page 270)

Read the safety instructions on towing and tow-starting (> page 269).

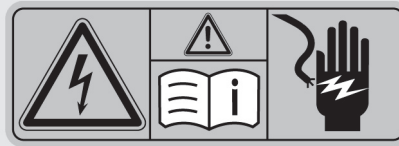

P08.00-2054-31

All components of the hybrid system are marked with yellow warning stickers that warn you of the danger of high voltage. The cables of the vehicle's high-voltage electrical system are orange in color.

The ignition must be switched off when carrying out general tasks, such as adding washer fluid to the windshield washer system or checking the coolant level.

Automatic deactivation of the hybrid system

DANGER

If the restraint system is malfunctioning, individual restraint system components may be triggered unintentionally or might not be triggered at all in the event of an accident with a high rate of vehicle deceleration. This could affect Emergency Tensioning Devices or air bags, for example. The vehicle's high-voltage electrical system may also not be deactivated as intended in the event of an accident. You could suffer an electric shock if you touch the damaged components of the vehicle's high-

voltage electrical system. This poses an increased risk of injury or even fatal injury. Have the restraint system checked and repaired immediately at a qualified specialist workshop. Immediately switch off the ignition and remove the SmartKey from the ignition lock after an accident.

If components of the restraint system are activated during an accident, the hybrid system is automatically deactivated.

The hybrid system is not activated when the vehicle is started if:

- a short circuit is detected in the hybrid system.
- one of the hybrid system's electrical connections is disconnected.

This ensures that you do not come into contact with high voltage.

Manual deactivation of the hybrid system

The hybrid system can be deactivated manually using the high voltage switch-off device.

! To prevent damage to the hybrid system please observe the following instructions:

- only deactivate the hybrid system manually in the following situations.
- work on the hybrid system may only be carried out at a qualified specialist workshop, even when it has been deactivated manually.
- if the  restraint system warning lamp in the instrument cluster lights up after an accident.
- if the vehicle is badly damaged, e.g. after an accident, and the restraint system components were not activated.
- if the vehicle is badly damaged and has to be towed or transported.

► **If possible, move the vehicle out of the danger zone:** shift the automatic transmission into position **N**.

► Release the electric parking brake.

► Roll the vehicle to a safe place and park it safely.

Get assistance from others if necessary.

i The vehicle is locked automatically when the ignition is switched on and the wheels are turning. There is therefore a risk of being locked out if the vehicle is being pushed or tested on a dynamometer.

► Switch the ignition off.

► Shift the automatic transmission to park position **P**.

Depress the electric parking brake (▷ page 155).

Secure the vehicle against rolling away (▷ page 299).

► **To use the high-voltage switch-off device:** open the trunk lid.

► Lift the trunk floor upwards (▷ page 234).

► Remove the right-hand paneling in the trunk.

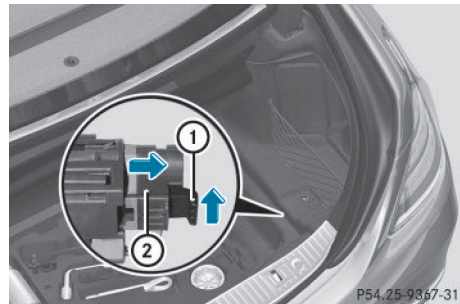

► Press release clip ① in the direction of the arrow and pull it out.

► Pull the high voltage switch-off device ② apart until it engages in the stop position.

If the hybrid system has been deactivated due to reasons mentioned above, have it checked at a qualified specialist workshop before reactivation.

High-voltage battery

WARNING

In the event of a vehicle fire, the internal pressure of the high-voltage battery can exceed a critical value. In this case flammable gas escapes through a ventilation valve on the underbody. The gas can ignite. There is a risk of injury.

Leave the danger zone immediately. Secure the danger area at a suitable distance, whilst observing legal requirements.

WARNING

If the housing of the high-voltage battery has been damaged, electrolyte and gases may leak out. These are poisonous and caustic. There is a risk of injury.

Avoid contact with skin, eyes or clothing. Immediately rinse electrolyte splashes off with water and seek medical attention straight away.

! Exhaustive discharge caused by the vehicle standing idle for lengthy periods can damage the high-voltage battery.

Hybrid vehicles: if the vehicle is idle for lengthy periods, run it for a few minutes once every six weeks to charge up the high-voltage battery. During the charging process, switch off all electrical consumers, e.g. the automatic climate control or the seat heating.

Plug-in hybrid vehicles: if the vehicle is idle for lengthy periods leave the high-voltage battery connected to a charging station.

PLUG-IN HYBRID vehicles: charging the high-voltage battery (> page 144).

Engine compartment

Before opening the hood:

- ▶ Apply the electric parking brake.
- ▶ Shift the automatic transmission to park position **P**.

- ▶ Switch the ignition off.
 - ▶ Remove the Start/Stop button from the ignition lock (> page 133).
- or
- ▶ If the SmartKey is inserted in the ignition lock: remove the SmartKey from the ignition lock.
 - ▶ Observe the warning notes on the risk of electric shock (> page 44).
 - ▶ Observe the warning notices about the hood (> page 246).

RBS driving safety system (Regenerative Brake System)

The Regenerative Braking System supports you when braking with an electronically-controlled brake boost mode and enables the recovery of kinetic energy (recuperation).

WARNING

If the Regenerative Braking System malfunctions, braking resistance may be reduced and brake pedal travel may be longer than usual. If you subsequently depress the brake pedal as usual, the braking effect may not be sufficient. There is a risk of an accident.

In the event of this malfunction, continue to depress the brake pedal. Stop the vehicle in accordance with the traffic conditions. If necessary, contact a qualified specialist workshop.

Further information about the Regenerative Braking System (> page 187).

Panic alarm

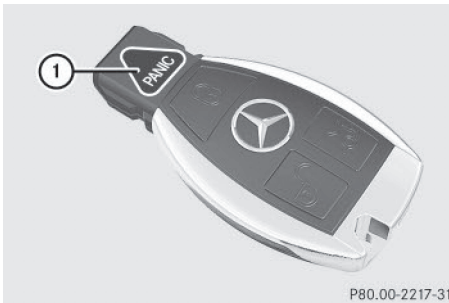

P80.00-2217-31

- ▶ **To activate:** press **PANIC** button ① for at least one second.
An alarm sounds and the exterior lighting flashes.
 - ▶ **To deactivate:** press **PANIC** button ① again.
- or
- ▶ Press the Start/Stop button.
The SmartKey must be in the vehicle.

Occupant safety

Restraint system: introduction

The restraint system reduces the risk of vehicle occupants coming into contact with parts of the vehicle's interior in the event of an accident. The restraint system can also reduce the forces to which vehicle occupants are subjected during an accident.

The restraint system comprises:

- Seat belt system
- Air bags
- Child restraint system
- Child seat securing systems

The components of the restraint system work in conjunction with each other. They can only deploy their protective function if, at all times, all vehicle occupants:

- have fastened their seat belts correctly (▷ page 51)
- have adjusted their seat and head restraint properly (▷ page 111).

As the driver, you also have to make sure that the steering wheel is adjusted correctly. Observe the information relating to the correct driver's seat position (▷ page 110).

You also have to make sure that an air bag can inflate properly if deployed (▷ page 54).

An air bag supplements a correctly worn seat belt. As an additional safety device, the air bag increases the level of protection for vehicle occupants in the event of an accident. For example, if, in the event of an accident, the protection offered by the seat belt is sufficient, the air bags are not deployed. When an accident occurs, only the air bags that increase protection in that particular accident situation are deployed. However, seat belts and air bags generally do not protect against objects penetrating the vehicle from the outside.

Information on restraint system operation can be found under "Deployment of Emergency Tensioning Devices and air bags" (▷ page 63).

For more information about children traveling with you in the vehicle and on child restraint systems, see "Children in the vehicle" (▷ page 67).

Important safety notes

WARNING

Modifications to the restraint system may cause it to no longer work as intended. The restraint system may then not perform its intended protective function and may fail in an accident or trigger unexpectedly, for example.

This poses an increased risk of injury or even fatal injury.

Never modify parts of the restraint system. Never tamper with the wiring, the electronic components or their software.

If it is necessary to modify an air bag system to accommodate a person with disabilities, contact an authorized Mercedes-Benz Center for details. USA only: for further information contact our Customer Assistance Center at 1-800-FOR-MERCEDES (1-800-367-6372).

Restraint system warning lamp

The functions of the restraint system are checked after the ignition is switched on and at regular intervals while the engine is running. Therefore, malfunctions can be detected in good time.

The  restraint system warning lamp in the instrument cluster lights up when the ignition is switched on. It goes out no later than a few seconds after the vehicle is started. The components of the restraint system are in operational readiness.

A malfunction has occurred if the  restraint system warning lamp:

- does not light up after the ignition is switched on
- does not go out after a few seconds with the engine running
- lights up again while the engine is running

All vehicles, except hybrid vehicles:

WARNING

If restraint system is malfunctioning, restraint system components may be triggered unintentionally or might not be triggered at all in the event of an accident with a high rate of vehicle deceleration. This can affect the Emergency Tensioning Device or air bag, for example. This poses an increased risk of injury or even fatal injury.

Have the restraint system checked and repaired in a qualified specialist workshop as soon as possible.

Hybrid vehicles:

DANGER

If the restraint system is malfunctioning, individual restraint system components may be triggered unintentionally or might not be triggered at all in the event of an accident with a high rate of vehicle deceleration. This could affect Emergency Tensioning Devices or air bags, for example. The vehicle's high-voltage electrical system may also not be deactivated as intended in the event of an accident. You could suffer an electric shock if you touch the damaged components of the vehicle's high-voltage electrical system. This poses an increased risk of injury or even fatal injury.

Have the restraint system checked and repaired immediately at a qualified specialist workshop. Immediately switch off the ignition and remove the SmartKey from the ignition lock after an accident.

PASSENGER AIR BAG indicator lamp



PASSENGER AIR BAG OFF indicator lamp ① and PASSENGER AIR BAG ON indicator lamp ② are part of the Occupant Classification System (OCS).

The indicator lamps display the status of the front-passenger front air bag.

- PASSENGER AIR BAG OFF ① lights up: the front-passenger front air bag is deactiva-

ted. It will then not be deployed in the event of an accident.

- PASSENGER AIR BAG ON ② lights up: the front-passenger front air bag is enabled. If, in the event of an accident, all deployment criteria are met, the front-passenger front air bag is deployed.

Depending on the person in the front-passenger seat, the front-passenger front air bag must either be deactivated or enabled; see the following points. You must make sure of this both before and during a journey.

- **Children in a child restraint system:**

whether the front-passenger front air bag is enabled or deactivated depends on the installed child restraint system, and the age and size of the child. Therefore, be sure to observe the notes on the "Occupant Classification System (OCS)" (> page 57) and on "Children in the vehicle" (> page 67).

There you will also find instructions on rearward and forward-facing child restraint systems on the front-passenger seat.

- **All other persons:** depending on the classification of the person in the front-passenger seat, the front-passenger front air bag is enabled or deactivated (> page 57). Be sure to observe the notes on "Seat belts" (> page 49) and "Air bags" (> page 54). There you can also find information on the correct seat position.

Seat belts

Introduction

Seat belts are the most effective means of restricting the movement of vehicle occupants in the event of an accident or the vehicle rolling over. This reduces the risk of vehicle occupants coming into contact with parts of the vehicle interior or being ejected from the vehicle. Furthermore, the seat belt helps to keep the vehicle occupant in the best position in relation to the air bag.

The seat belt system comprises:

- Seat belts
- Emergency Tensioning Devices for the front seat belts and the outer seat belts in the rear
- Seat belt force limiters for the front seat belts and the outer seat belts in the rear
- Belt bags for the outer seat belts in the rear, depending on the vehicle's equipment

If the seat belt is pulled out of the belt outlet quickly or with a jerky movement, the belt retractor locks. The belt strap cannot be extracted any further.

The Emergency Tensioning Device tightens the seat belt in an accident, pulling the belt close against the body. However it does not pull the vehicle occupant back in the direction of the backrest.

The Emergency Tensioning Device does not correct an incorrect seat position or the routing of an incorrectly fastened seat belt.

When triggered, seat belt force limiters help to reduce the force exerted by the seat belt on the vehicle occupant.

The seat belt force limiters for the front seats are synchronized with the front air bags, which absorb part of the deceleration force. This can reduce the force exerted on the vehicle occupants during an accident.

! If the front-passenger seat is unoccupied, do not insert the belt tongue into the buckle of the front-passenger seat. This may otherwise lead to the triggering of the Emergency Tensioning Device in the event of an accident, which will then need to be replaced.

Important safety notes

The use of seat belts and child restraint systems is required by law in:

- all 50 states
- the U.S. territories
- the District of Columbia
- all Canadian provinces

Even where this is not required by law, all vehicle occupants should correctly fasten their seat belts before starting the journey.

 **WARNING**

If the seat belt is incorrectly fastened, it cannot protect as intended. Furthermore, an incorrectly fastened seat belt can cause additional injury, for example, in an accident, during braking or when abruptly changing direction. This poses an increased risk of injury or even fatal injury.

Make sure that all vehicle occupants are seated properly with a correctly fastened seat belt.

 **WARNING**

The seat belt does not offer the intended level of protection if you have not moved the backrest to an almost vertical position. When braking or in the event of an accident, you could slide underneath the seat belt and sustain abdomen or neck injuries, for example. This poses an increased risk of injury or even fatal injury.

Adjust the seat properly before beginning your journey. Always ensure that the backrest is in an almost vertical position and that the shoulder section of your seat belt is routed across the center of your shoulder.

 **WARNING**

Objects next to the front seat that block the belt buckle or the moving belt anchorage on the front seat impair the function of the Emergency Tensioning Devices. The Emergency Tensioning Devices may not function as intended and the seat belt may no longer provide the intended protection. This poses an increased risk of injury or even fatal injury.

Before starting the journey, make sure that there are no objects around the belt buckle or between the front seat and door.

 **WARNING**

Persons under 5 ft (1.50 m) in height cannot fasten the seat belt correctly without an addi-

tional suitable restraint system. If the seat belt is incorrectly fastened, it cannot protect as intended. Furthermore, an incorrectly fastened seat belt can cause additional injury, for example, in an accident, during braking or an abrupt change of direction. This poses an increased risk of injury or even fatal injury.

For this reason, always secure persons under 5 ft (1.50 m) in height in suitable restraint systems.

If a child younger than 12 years and under 5 ft (1.50 m) in height is traveling in the vehicle:

- always secure the child in a child restraint system suitable for this Mercedes-Benz vehicle. The child restraint system must be appropriate to the age, weight and size of the child
- always observe the instructions and safety notes on the belt bags for the outer seat belts in the rear (> page 51)
- always observe the instructions and safety notes in the "Children in the vehicle" section of this Operator's Manual (> page 67) in addition to the child restraint system manufacturer's installation instructions
- be sure to observe the instructions and safety notes on the "Occupant classification system (OCS)" (> page 57)

 **WARNING**

The seat belts may not perform their intended protective function if:

- they are damaged, modified, extremely dirty, bleach or dyed
- the seat belt buckle is damaged or extremely dirty
- the Emergency Tensioning Devices, belt anchorages or inertia reels have been modified

Seat belts may sustain non-visible damage in an accident, e.g. due to glass splinters. Modified or damaged seat belts may tear or fail, e.g. in an accident. Modified Emergency Tensioning Devices could accidentally trigger or

fail to deploy when necessary. This poses an increased risk of injury or even fatal injury. Never modify the seat belts, Emergency Tensioning Devices, belt anchorages or inertia reels. Make sure that the seat belts are undamaged, not worn out and clean. Following an accident, have the seat belts checked immediately at a qualified specialist workshop.

Only use seat belts that have been approved for your vehicle by Mercedes-Benz. Any such modifications could invalidate the vehicle's general operating permit.

Proper use of the seat belts

Observe the safety notes on the seat belt (▷ page 49).

All vehicle occupants must be wearing the seat belt correctly before beginning the journey. Also make sure that all vehicle occupants are always wearing the seat belt correctly while the vehicle is in motion.

When fastening the seat belt, always make sure that:

- the seat belt tongue is only inserted to the belt buckle belonging to that seat.
- the seat belt is tight across your body.
Avoid wearing bulky clothing, e.g. a winter coat.
- the seat belt is not twisted.
Only then can the forces which occur be distributed over the area of the belt.
- the shoulder section of the belt is always routed across the center of your shoulder.
The shoulder section of the belt must not come into contact with your neck or be routed under your arm. Where possible, adjust the seat belt to the appropriate height.
- the lap belt passes tightly and as low down as possible across your lap.
The lap belt must always be routed across your hip joints and not across your abdomen. This applies particularly to pregnant

women. If necessary, push the lap belt down to your hip joint and pull it tight using the shoulder section of the belt.

- the seat belt is not routed across sharp, pointed or fragile objects.
If you have such items located on or in your clothing, e.g. pens, keys or eyeglasses, store these in a suitable place.
- only one person is using a seat belt at a time.
Infants and children must never travel sitting on the lap of a vehicle occupant. In the event of an accident, they could be crushed between the vehicle occupant and seat belt.
- objects are never secured with a seat belt if the seat belt is also being used by one of the vehicle's occupants.

Seat belts are only intended to secure and restrain vehicle occupants. Always observe the "Loading guidelines" for securing objects, luggage or loads (▷ page 232).

Rear beltbags

- **i** Observe the "Important safety notes" section (▷ page 54).

Depending on the vehicle's equipment, the outer rear seat belts are equipped with a belt bag. This can be seen from the BELTBAG identification on the rear seat belt.

WARNING

In an accident, the belt bag may damage a non-approved child restraint system. As a result, the child restraint system may not be able to provide the intended level of protection. This poses an increased risk of injury or even fatal injury.

For this reason, a child restraint system with an integrated seat belt should always be installed using LATCH-type (ISOFIX). In a vehicle with optional belt bags for the rear seats, you should only ever use a booster seat with integrated backrest that has been tested and approved by Mercedes-Benz in conjunction

with a belt bag. Never use a seat belt equipped with a belt bag to secure a forward or rearward-facing child restraint system or a booster seat that has not been approved. For information on approved child restraint systems, please contact an authorized Mercedes-Benz Center.

Further information on child restraint systems (▷ page 67).



When triggered, belt bags ① open, increasing the protected area of the occupants' ribcages. The beltbags are triggered depending on the type and severity of the accident.

Fastening and adjusting the seat belts

Observe the safety notes on the seat belt (▷ page 49) and the notes on correct use of seat belts (▷ page 51).



- ▶ Adjust the seat (▷ page 110). The seat backrest must be in an almost vertical position.
- ▶ Pull the seat belt smoothly from belt outlet ③ and engage belt tongue ② into belt buckle ①. The seat belt on the driver's seat and the front-passenger seat may be tightened automatically, see "Belt adjustment" (▷ page 53).
- ▶ If necessary, pull upwards on the shoulder section of the seat belt to tighten the belt across your body.

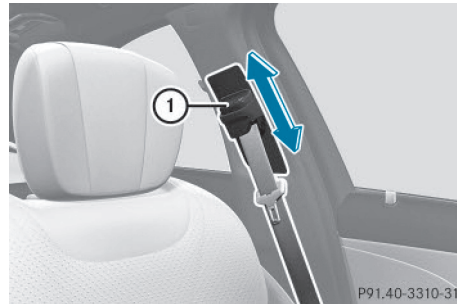

The shoulder section of the seat belt must always be routed across the center of the shoulder. Adjust the belt outlet if necessary.

- ▶ **To raise:** slide the belt outlet upwards. The belt outlet will engage in various positions.
- ▶ **To lower:** hold belt outlet release ① and slide the belt outlet downwards.
- ▶ Let go of belt outlet release ① in the desired position and make sure that the belt outlet engages.

All seat belts except the driver's seat belt are equipped with a special seat belt retractor to securely fasten child restraint systems in the vehicle. Further information can be found under "Special seat belt retractor" (▷ page 67).

Rear seat belt buckle extenders

The seat belt extender is an integral part of the PRE-SAFE® convenience function. It is used on the outer rear seats.

Always ensure that it is possible to move the belt buckle freely. Always stow objects in the vehicle correctly.

To assist you in finding the seat belt buckle and fastening the seat belt:

- the belt buckle moves forwards to a convenient position
- the belt buckle is illuminated

After the seat belt is fastened, the belt buckle returns to its normal position. The seat belt then lies tight across the lap and thorax areas.

Incorporation into the PRE-SAFE® system: the belt buckle is lowered quickly in certain hazardous situations. This pre-tensions the seat belt.

Incorporation into the automatic measures after the accident: in this situation, the belt buckle is illuminated and extended after a rear door is opened.

Releasing seat belts

! Make sure that the seat belt is fully rolled up. Otherwise, the seat belt or belt tongue will be trapped in the door or in the seat mechanism. This could damage the door, the door trim panel and the seat belt. Damaged seat belts can no longer fulfill their protective function and must be replaced. Visit a qualified specialist workshop.

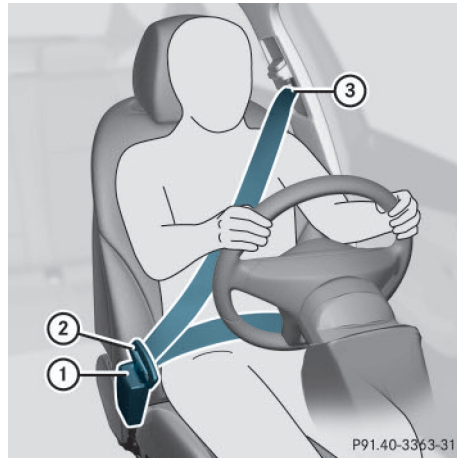

- Press release button ①, hold belt tongue ② firmly and guide it back towards belt outlet ③.

Seat belt adjustment

The seat-belt adjustment is an integral part of the PRE-SAFE® convenience function. This function adjusts the driver's and front-passenger seat belt to the upper body of the occupants.

The belt strap is tightened slightly when:



- the belt tongue is engaged in the buckle and
- the ignition is switched on

The seat-belt adjustment will apply a certain retraction force if any slack is detected between the vehicle occupant and the seat belt. Do not hold on to the seat belt tightly while it is adjusting.

You can switch the seat-belt adjustment on and off using COMAND. Information on switching the belt adjustment function on and off can be found in the Digital Operator's Manual or in the separate COMAND operating instructions.

Belt warning for the driver and front passenger



The  seat belt warning lamp in the instrument cluster is a reminder that all occupants must fasten their seat belts. It may light up continuously or flash. In addition, there may be a warning tone.

Regardless of whether the driver's seat belt has already been fastened, the  seat belt warning lamp lights up for six seconds each time the engine is started. If, after six seconds, the driver or front-passenger seat belt has not been fastened and the doors are closed, the  seat belt warning lamp lights up. As soon as the driver's and front-passenger seat belts are fastened or a front door is opened again, the  seat belt warning lamp goes out.

If the driver's seat belt is not fastened after the engine is started, an additional warning tone will sound. This warning tone stops after six seconds or when the driver's seat belt is fastened.

If the vehicle's speed exceeds 15 mph (25 km/h) once and the driver's and front-passenger seat belts are not fastened, a warning tone sounds. A warning tone also sounds with increasing intensity for 60 seconds or until the driver or front passenger have fastened their seat belts.

If the driver or front passenger unfasten their seat belts during the journey, the seat belt warning is activated again.

 For more information on the  seat belt warning lamp, see "Warning and indicator lamps in the instrument cluster, seat belts" (> page 212).

Air bags

Introduction

The installation point of an air bag can be recognized by the AIR BAG symbol.

An air bag complements the correctly fastened seat belt. It is no substitute for the seat

belt. The air bag provides additional protection in applicable accident situations.

Not all air bags are deployed in an accident. The different air bag systems function independently from one another (> page 63).

However, no system available today can completely eliminate injuries and fatalities.

It is also not possible to rule out a risk of injury caused by an air bag due to the high speed at which the air bag must be deployed.

Important safety notes

WARNING

If you do not sit in the correct seat position, the air bag cannot protect as intended and could even cause additional injury when deployed. This poses an increased risk of injury or even fatal injury.

To avoid hazardous situations, always make sure that all of the vehicle's occupants:

- have fastened their seat belts correctly, including pregnant women
- are sitting correctly and maintain the greatest possible distance to the air bags
- follow the following instructions

Always make sure that there are no objects between the air bag and the vehicle's occupants.

- Adjust the seats properly before beginning your journey. Always make sure that the seat is in an almost upright position. The center of the head restraint must support the head at about eye level.
- Move the driver's and front-passenger seats as far back as possible. The driver's seat position must allow the vehicle to be driven safely.
- Only hold the steering wheel on the outside. This allows the air bag to be fully deployed.
- Always lean against the backrest while driving. Do not lean forwards or lean against the door or side window. You may other-

wise be in the deployment area of the air bags.

- Always keep your feet in the footwell in front of the seat. Do not put your feet on the dashboard, for example. Your feet may otherwise be in the deployment area of the air bag.
- For this reason, always secure persons less than 5 ft (1.50 m) tall in suitable restraint systems. Up to this height, the seat belt cannot be worn correctly.

If a child is traveling in your vehicle, also observe the following notes:

- Always secure children under 12 years of age and less than 5 ft (1.50 m) in height in suitable child restraint systems.
- Child restraint systems should be installed on the rear seats.
- Only secure a child in a rearward-facing child restraint system on the front-passenger seat when the front-passenger front air bag is deactivated. If the PASSENGER AIR BAG OFF indicator lamp is permanently lit, the front-passenger front air bag is deactivated (▷ page 48).
- Always observe the instructions and safety notes on the "Occupant Classification System (OCS)" (▷ page 57) and on "Children in the vehicle" (▷ page 67) in addition to the child restraint system manufacturer's installation instructions.

Objects in the vehicle interior may prevent an air bag from functioning correctly.

Before starting your journey and to avoid risks resulting from the speed of the air bag as it deploys, make sure that:

- there are no people, animals or objects between the vehicle occupants and an air bag.
- there are no objects between the seat, door and B-pillar.
- no hard objects, e.g. coat hangers, hang on the grab handles or coat hooks.
- no accessories, such as cup holders, are attached to the vehicle within the deploy-

ment area of an air bag, e.g. to doors, side windows, rear side trim or side walls.

- no heavy, sharp-edged or fragile objects are in the pockets of your clothing. Store such objects in a suitable place.

⚠ WARNING

If you modify the air bag cover or affix objects such as stickers to it, the air bag can no longer function correctly. There is an increased risk of injury.

Never modify an air bag cover or affix objects to it.

⚠ WARNING

Sensors to control the air bags are located in the doors. Modifications or work not performed correctly to the doors or door paneling, as well as damaged doors, can lead to the function of the sensors being impaired. The air bags might therefore not function properly any more. Consequently, the air bags cannot protect vehicle occupants as they are designed to do. There is an increased risk of injury.

Never modify the doors or parts of the doors. Always have work on the doors or door paneling carried out at a qualified specialist workshop.

Front air bags

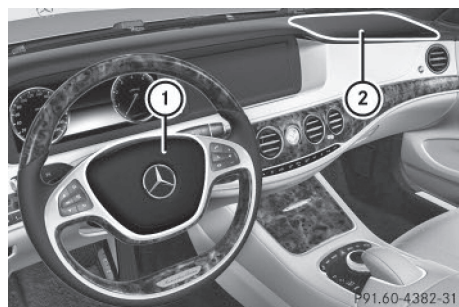

Driver's air bag ① deploys in front of the steering wheel. Front-passenger front air bag ② deploys in front of and above the glove box.

When deployed, the front air bags offer additional head and thorax protection for the occupants in the front seats.

The PASSENGER AIR BAG OFF and PASSENGER AIR BAG ON indicator lamps inform you about the status of the front-passenger front air bag (▷ page 48).

Front-passenger front air bag ② will only deploy if:

- the system, based on the OCS weight sensor readings, detects that the front-passenger seat is occupied (▷ page 57). The PASSENGER AIR BAG ON indicator lamp is lit (▷ page 58)
- the restraint system control unit predicts a high accident severity

Driver's knee bag



Driver's knee bag ① deploys under the steering column. The driver's knee bag is always deployed along with the driver's front air bag. The driver's knee bag offers additional thigh, knee and lower leg protection for the occupant in the driver's seat.

Side impact air bags

WARNING

Unsuitable seat covers could restrict or even prevent the deployment of the air bags integrated into the seats. Consequently, the air bags cannot protect vehicle occupants as they are designed to do. In addition, the function of the Occupant Classification System

(OCS) could be restricted. This poses an increased risk of injury or even fatal injury. You should only use seat covers that have been approved for the respective seat by Mercedes-Benz.

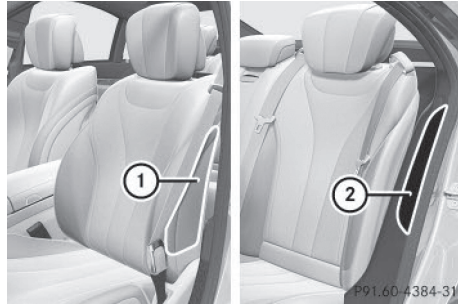

Front side impact air bags ① and rear side impact air bags ② deploy next to the outer bolster of the seat backrest.

When deployed, the side impact air bag offers additional thorax protection. It also offers additional pelvis protection for occupants in the front seats. However, it does not protect the:

- head
- neck
- arms

In the event of a side impact, the side impact air bag is deployed on the side on which the impact occurs.

The side impact air bag on the front-passenger side (front) deploys in the following situations:

- the OCS system detects that the front-passenger seat is occupied or
- the belt tongue is engaged in the belt buckle of the front-passenger seat

If the belt tongue is engaged in the belt buckle, the side impact air bag on the front-passenger side deploys if an appropriate accident situation occurs. In this case, deployment is independent of whether the front-passenger seat is occupied or not.

Window curtain air bags

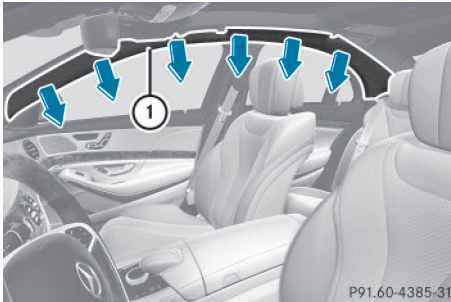

Window curtain air bags ① are integrated into the side of the roof frame and deployed in the area from the A-pillar to the C-pillar.

When deployed, the window curtain air bag enhances the level of protection for the head. However, it does not protect the chest or arms.

In the event of a side impact, the window curtain air bag is deployed on the side on which the impact occurs.

If the system determines that they can offer additional protection to that provided by the seat belt, a window curtain air bag may be deployed in other accident situations (▷ page 63).

Cushion air bags

i Observe the "Important safety notes" section (▷ page 54).

The rear reclining seat is equipped with a cushion air bag. If the seat backrest is reclined, the cushion air bag can provide additional occupant protection in the event of frontal collision situations. When triggered, the cushion air bag deploys under the seat cushion. This helps prevent the occupant from slipping off the seat cushion.

⚠ WARNING

If a child restraint system is installed and the seat backrest is reclined too far backwards, the cushion air bag may deploy by mistake in the event of an accident. There is an increased risk of injury.

When using a child restraint system, always ensure that the seat is correctly adjusted and that the backrest is almost vertical.

If you install a child restraint system on the rear reclining seat, always observe:

- the instructions and safety notes in "Children in the vehicle" (▷ page 67)
- the child restraint system manufacturer's installation instructions.

Occupant Classification System (OCS)

Introduction

The Occupant Classification System (OCS) categorizes the person in the front-passenger seat. Depending on that result, the front-passenger front air bag is either enabled or deactivated.

The system does not deactivate:

- the side impact air bag
- the window curtain air bag
- the Emergency Tensioning Devices

Prerequisites

To be classified correctly, the front passenger must sit:

- with the seat belt fastened correctly
- in an almost upright position with their back against the seat backrest
- with their feet resting on the floor, if possible

If the front passenger does not observe these conditions, OCS may produce a false classification, e.g. because the front passenger:

- transfers their weight by supporting themselves on a vehicle armrest
- sits in such a way that their weight is raised from the seat cushion

If it is absolutely necessary to install a child restraint system on the front-passenger seat, be sure to observe the correct positioning of

the child restraint system. Never place objects under or behind the child restraint system, e.g. cushions. Fully retract the seat cushion length. The entire base of the child restraint system must always rest on the seat cushion of the front-passenger seat. The backrest of the forwards-facing child restraint system must, as far as possible, be resting on the backrest of the front-passenger seat.

The child restraint system must not touch the roof or be put under strain by the head restraint. Adjust the angle of the seat backrest and the head restraint position accordingly.

Only then can OCS be guaranteed to function correctly. Always observe the child restraint system manufacturer's installation instructions.

Occupant Classification System operation (OCS)

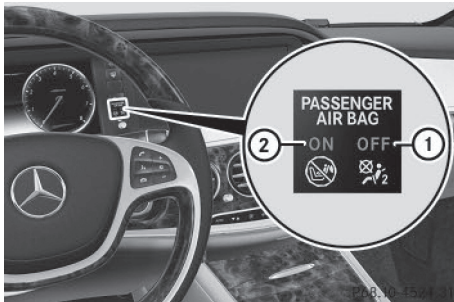

- ① PASSENGER AIR BAG OFF indicator lamp
- ② PASSENGER AIR BAG ON indicator lamp

The indicator lamps inform you whether the front-passenger front air bag is deactivated or enabled.

- ▶ Press the Start/Stop button once or twice, or turn the SmartKey to position **1** or **2** in the ignition lock.
The system carries out self-diagnostics.

The PASSENGER AIR BAG OFF and PASSENGER AIR BAG ON indicator lamps must light up simultaneously for approximately six seconds.

The indicator lamps display the status of the front-passenger front air bag.

- PASSENGER AIR BAG OFF ① lights up: the front-passenger front air bag is deactivated. It will then not be deployed in the event of an accident.
- PASSENGER AIR BAG ON ② lights up: the front-passenger front air bag is enabled. If, in the event of an accident, all deployment criteria are met, the front-passenger front air bag is deployed.

If the status of the front-passenger front air bag changes while the vehicle is in motion, an air bag display message appears in the instrument cluster (▷ page 205). When the front-passenger seat is occupied, always pay attention to the PASSENGER AIR BAG ON and PASSENGER AIR BAG OFF indicator lamps. Be aware of the status of the front-passenger front air bag both before and during the journey.

⚠ WARNING

If the PASSENGER AIR BAG OFF indicator lamp is lit, the front-passenger front air bag is disabled. It will not be deployed in the event of an accident and cannot perform its intended protective function. A person in the front-passenger seat could then, for example, come into contact with the vehicle's interior, especially if the person is sitting too close to the dashboard. This poses an increased risk of injury or even fatal injury.

When the front-passenger seat is occupied, always ensure that:

- the classification of the person in the front-passenger seat is correct and the front-passenger front air bag is enabled or disabled in accordance with the person in the front-passenger seat
- the front-passenger seat has been moved back as far back as possible.
- the person is seated correctly.

Make sure, both before and during the journey, that the status of the front-passenger front air bag is correct.

⚠ WARNING

If you secure a child in a rearward-facing child restraint system on the front-passenger seat and the PASSENGER AIR BAG ON indicator lamp is lit up, the front-passenger front air bag may deploy in an accident. The child could be struck by the air bag. This poses an increased risk of injury or even fatal injury.

Make sure that the front-passenger front air bag has been disabled. The PASSENGER AIR BAG OFF indicator lamp must be lit.

If the PASSENGER AIR BAG OFF indicator lamp remains off and/or the PASSENGER AIR BAG ON indicator lamp lights up, do not install a rearward-facing child restraint system on the front-passenger seat. You can find more information on OCS under "Problems with the Occupant Classification System" (▷ page 62).

⚠ WARNING

If you secure a child in a forward-facing child restraint system on the front-passenger seat and you position the front-passenger seat too close to the dashboard, in the event of an accident, the child could:

- come into contact with the vehicle's interior if the PASSENGER AIR BAG OFF indicator lamp is lit, for example
- be struck by the air bag if the PASSENGER AIR BAG ON is lit up

This poses an increased risk of injury or even fatal injury.

Always move the front-passenger seat as far back as possible and fully retract the seat cushion length. Always make sure that the shoulder belt strap is correctly routed from the vehicle belt sash guide to the shoulder belt guide on the child restraint system. The shoulder belt strap must be routed forwards and downwards from the vehicle belt sash guide. If necessary, adjust the vehicle belt sash guide and the front-passenger seat accordingly. Always observe the child restraint system manufacturer's installation instructions.

If OCS determines that:

- the front-passenger seat is unoccupied, the PASSENGER AIR BAG OFF indicator lamp lights up after the system self-test and remains lit. This indicates that the front-passenger front air bag is deactivated.
- the front-passenger seat is occupied by a child of up to 12 months old in a standard child restraint system, the PASSENGER AIR BAG OFF indicator lamp lights up after the system self-test and remains lit. This indicates that the front-passenger front air bag is deactivated.

But in the case of a 12-month-old child in a standard child restraint system, the PASSENGER AIR BAG ON can light up permanently after the system self-test. This indicates that the front-passenger front air bag is activated. The result of the classification is dependent on, among other factors, the child restraint system and the child's stature. It is recommended that you install the child restraint system on a suitable rear seat.

- the front-passenger seat is occupied by a person of smaller stature (e.g. a teenager or small adult), either the PASSENGER AIR BAG ON or PASSENGER AIR BAG OFF indicator lamp lights up and remains lit after the system self-test depending on the result of the classification.
 - If the PASSENGER AIR BAG ON indicator lamp lights up, move the front-passenger seat as far back as possible. Alternatively, a person of smaller stature can sit on a rear seat.
 - If the PASSENGER AIR BAG OFF indicator lamp is lit, a person of smaller stature should not use the front-passenger seat.
- the front-passenger seat is occupied by an adult or a person of a stature corresponding to that of an adult, the PASSENGER AIR BAG ON indicator lamp lights up after the system self-test and remains lit. This indicates that the front-passenger front air bag is activated.

If children are traveling in the vehicle, be sure to observe the notes on "Children in the vehicle" (▷ page 67).

When OCS is malfunctioning, the red  restraint system warning lamp in the instrument cluster and the PASSENGER AIR BAG OFF indicator lamp light up simultaneously. The front-passenger front air bag is deactivated in this case and does not deploy during an accident. Have the system checked by qualified technicians as soon as possible. Consult an authorized Mercedes-Benz Center. The front-passenger seat should only be repaired at an authorized Mercedes-Benz Center.

If the front-passenger seat, the seat cover or the seat cushion is damaged, have the necessary repair work carried out at an authorized Mercedes-Benz Center.

For safety reasons, Mercedes-Benz recommends that you only use seat accessories that have been approved by Mercedes-Benz. If the driver's air bag deploys, this does not mean that the front-passenger front air bag will also deploy. The Occupant Classification System (OCS) categorizes the occupant in the front-passenger seat. Depending on that result, the front-passenger front air bag is either enabled or deactivated.

System self-test

DANGER

If both the PASSENGER AIR BAG OFF and PASSENGER AIR BAG ON indicator lamps do not light up during the system self-test, the system is malfunctioning. The front-passenger front air bag might be triggered unintentionally or might not be triggered at all in the event of an accident with high deceleration. This poses an increased risk of injury or even fatal injury.

In this case the front-passenger seat may not be used. Do not install a child restraint system on the front-passenger seat. Have the Occupant Classification System (OCS) checked and repaired immediately at a qualified specialist workshop.

DANGER

If the PASSENGER AIR BAG OFF indicator lamp remains lit after the system self-test, the front-passenger front air bag is disabled. It will not be deployed in the event of an accident. In this case, the front-passenger front air bag cannot perform its intended protective function, e.g. when a person is seated in the front-passenger seat.

That person could, for example, come into contact with the vehicle's interior, especially if the person is sitting too close to the dashboard. This poses an increased risk of injury or even fatal injury.

When the front-passenger seat is occupied, always ensure that:

- the classification of the person in the front-passenger seat is correct and the front-passenger front air bag is enabled or disabled in accordance with the person in the front-passenger seat
- the person is seated properly with a correctly fastened seatbelt
- the front-passenger seat has been moved back as far back as possible

If the PASSENGER AIR BAG OFF indicator lamp remains lit when it should not, the front-passenger seat may not be used. Do not install a child restraint system on the front-passenger seat. Have the Occupant Classification System (OCS) checked and repaired immediately at a qualified specialist workshop.

WARNING

Objects between the seat surface and the child restraint system could affect OCS operation. This could result in the front-passenger air bag not functioning as intended during an accident. This poses an increased risk of injury or even fatal injury.

Do not place any objects between the seat surface and the child restraint system. The entire base of the child restraint system must always rest on the seat cushion of the front-passenger seat. The backrest of the forward-

facing child restraint system must, as far as possible, be resting on the backrest of the front-passenger seat. Always comply with the child restraint system manufacturer's installation instructions.

After the system self-test, the PASSENGER AIR BAG OFF or PASSENGER AIR BAG ON indicator lamp display the status of the front-passenger front air bag (▷ page 58).

For more information about the OCS, see "Problems with the Occupant Classification System" (▷ page 62).

Problems with the Occupant Classification System (OCS)

Be sure to observe the notes on "System self-test" (▷ page 60).

| Problem | Possible causes/consequences and ► Solutions |
|--|---|
| <p>The PASSENGER AIR BAG OFF indicator lamp lights up and remains lit, even though the front-passenger seat is occupied by an adult or a person of a stature corresponding to that of an adult.</p> | <p>The classification of the person on the front-passenger seat is incorrect.</p> <ul style="list-style-type: none"> ► Make sure the conditions for a correct classification of the person on the front-passenger seat are met (▷ page 57). ► If the PASSENGER AIR BAG OFF indicator lamp remains lit, the front-passenger seat may not be used. ► Have OCS checked as soon as possible at an authorized Mercedes-Benz Center. |
| <p>The PASSENGER AIR BAG OFF indicator lamp does not light up and/or does not stay on.</p> <p>The front-passenger seat is:</p> <ul style="list-style-type: none"> • unoccupied • occupied by the weight of a child up to 12 months old in a child restraint system | <p>OCS is malfunctioning.</p> <ul style="list-style-type: none"> ► Make sure there is nothing between the seat cushion and the child seat. ► Make sure that the entire base of the child restraint system rests on the seat cushion of the front-passenger seat. The backrest of the forward-facing child restraint system must lie as flat as possible against the backrest of the front-passenger seat. If necessary, adjust the position of the front-passenger seat. ► Make sure that the seat cushion length is fully retracted. ► When installing the child restraint system, make sure that the seat belt is tight. Do not pull the seat belt tight using the front-passenger seat adjustment. This could result in the seat belt and the child restraint system being pulled too tightly. ► Check for correct installation of the child restraint system. Make sure that the head restraint does not apply a load to the child restraint system. If necessary, adjust the head restraint accordingly. ► Make sure that no objects are applying additional weight onto the seat. ► If the PASSENGER AIR BAG OFF indicator lamp remains off and/or the PASSENGER AIR BAG ON indicator lamp lights up, do not install a child restraint system on the front-passenger seat. It is recommended that you install the child restraint system on a suitable rear seat. ► Have OCS checked as soon as possible at an authorized Mercedes-Benz Center. |

Deployment of Emergency Tensioning Devices and air bags

Important safety notes

WARNING

The air bag parts are hot after an air bag has been deployed. There is a risk of injury.

Do not touch the air bag parts. Have a deployed air bag replaced at a qualified specialist workshop as soon as possible.

WARNING

A deployed air bag no longer offers any protection and cannot provide the intended protection in an accident. There is an increased risk of injury.

Have the vehicle towed to a qualified specialist workshop in order to have a deployed air bag replaced.

It is important for your safety and that of your passenger to have deployed air bags replaced and to have any malfunctioning air bags repaired. This will help to make sure the air bags continue to perform their protective function for the vehicle occupants in the event of a crash.

WARNING

Pyrotechnic Emergency Tensioning Devices that have been deployed are no longer operational and are unable to perform their intended protective function. This poses an increased risk of injury or even fatal injury.

Therefore, have pyrotechnic Emergency Tensioning Devices which have been triggered immediately replaced at a qualified specialist workshop.

An electric motor is used by PRE-SAFE® to trigger the tightening of the seat belt in hazardous situations. This procedure is reversible.

If Emergency Tensioning Devices are triggered or air bags are deployed, you will hear a bang, and a small amount of powder may also

be released. The  restraint system warning lamp lights up.

Only in rare cases will the bang affect your hearing. The powder that is released generally does not constitute a health hazard, but it may cause short-term breathing difficulties in people with asthma or other respiratory problems. To avoid this, you may wish to get out of the vehicle or open the windows as soon as it is safe to do so.

Air bags and pyrotechnic Emergency Tensioning Devices (ETDs) contain perchlorate material, which may require special handling and regard for the environment. National guidelines must be observed during disposal. In California, see www.dtsc.ca.gov/HazardousWaste/Perchlorate/index.cfm.

Method of operation

During the first stage of a collision, the restraint system control unit evaluates important physical data relating to vehicle deceleration or acceleration, such as:

- duration
- direction
- intensity

Based on the evaluation of this data, the restraint system control unit triggers the Emergency Tensioning Devices during a frontal or rear collision.

An Emergency Tensioning Device can only be triggered, if:

- the ignition is switched on
- the components of the restraint system are operational; see "Restraint system warning lamp" (> page 48)
- the belt tongue is engaged in the buckle on the respective front-passenger seat

The Emergency Tensioning Devices in the rear compartment are triggered independently of the lock status of the seat belts.

Vehicles with belt bags: the belt bags are also deployed depending on the type and severity of the accident.

Vehicles with a rear reclining seat: the Emergency Tensioning Device is only triggered if the belt buckle tongue is engaged in the belt buckle.

If the seat backrest is reclined, the cushion air bag will also be deployed depending on the type and severity of the accident.

If the restraint system control unit detects a more severe accident, further components of the restraint system are activated independently of each other in certain frontal collision situations:

- Front air bags and driver's knee bag
- Window curtain air bag, if the system determines that deployment can offer additional protection to that provided by the seat belt

The front-passenger front air bag is activated or deactivated depending on the person on the front-passenger seat. The front-passenger front air bag can only deploy in an accident if the PASSENGER AIR BAG ON indicator lamp is lit. Observe the information on the PASSENGER AIR BAG indicator lamps (> page 48).

Your vehicle has two-stage front air bags. During the first deployment stage, the front air bag is filled with propellant gas to reduce the risk of injuries. The front air bag is fully deployed with the maximum amount of propellant gas if a second deployment threshold is reached within a few milliseconds.

The activation threshold of the Emergency Tensioning Devices and the air bag are determined by evaluating the rate of vehicle deceleration or acceleration which occurs at various points in the vehicle. This process is pre-emptive in nature. Deployment should take place in good time at the start of the collision.

The rate of vehicle deceleration or acceleration and the direction of the force are essentially determined by:

- the distribution of forces during the collision
- the collision angle
- the deformation characteristics of the vehicle
- the characteristics of the object with which the vehicle has collided

Factors which can only be seen and measured after a collision has occurred do not play a decisive role in the deployment of an air bag. Nor do they provide an indication of air bag deployment.

The vehicle can be deformed considerably, without an air bag being deployed. This is the case if only parts which are relatively easily deformed are affected and the rate of deceleration is not high. Conversely, air bags may be deployed even though the vehicle suffers only minor deformation. This is the case if, for example, very rigid vehicle parts such as longitudinal body members are hit, and sufficient deceleration occurs as a result.

If the restraint system control unit detects a side impact or that the vehicle is rolling over, the relevant restraint system components are activated independently of one another depending on the apparent type of accident. If the system determines a need for additional protection for the vehicle occupants, the Emergency Tensioning Devices are triggered.

- Side impact air bags on the side of impact, independently of the Emergency Tensioning Device and the use of the seat belt on the driver's seat and outer seats in the second row

The side impact air bag on the front-passenger side (front) deploys in the following situations:

- the OCS system detects that the front-passenger seat is occupied or
- the belt tongue is engaged in the belt buckle of the front-passenger seat
- Window curtain air bag on the side of impact, independently of the use of the seat belt and independently of whether the front-passenger seat is occupied
- Window curtain air bags on the driver's and front-passenger side in certain situations when the vehicle rolls over, if the system determines that deployment can offer additional protection to that provided by the seat belt

i Not all air bags are deployed in an accident. The different air bag systems work independently of each other.

How the air bag system works is determined by the severity of the accident detected, especially the vehicle deceleration or acceleration and the apparent type of accident:

- frontal collision
- side impact
- rollover

PRE-SAFE® (anticipatory occupant protection system)

Introduction

In certain hazardous situations, PRE-SAFE® takes pre-emptive measures to protect the vehicle occupants.

Important safety notes

i Make sure that there are no objects in the footwell under or behind the seats when moving the seats back. There is a risk that the seats and/or the objects could be damaged.

Despite your vehicle being equipped with the PRE-SAFE® system, the possibility of personal injuries occurring as a result of an accident cannot be eliminated. Always adapt your driving style to suit the prevailing road and weather conditions and maintain a safe distance from the vehicle in front. Drive carefully.

Function

PRE-SAFE® intervenes:

- in emergency braking situations, e.g. when BAS is activated
- in critical driving situations, e.g. when physical limits are exceeded and the vehicle understeers or oversteers severely
- vehicles with the Driving Assistance package: when a driver assistance system intervenes powerfully or the radar sensor system detects an imminent danger of collision in certain situations

PRE-SAFE® takes the following measures depending on the hazardous situation detected:

- the front seat belts are pre-tensioned.
- if the vehicle skids, the panorama roof with power tilt/sliding panel and the side windows are closed so that only a small gap remains.
- the front-passenger seat is adjusted if it is in an unfavorable position.
- for vehicles with electrically adjustable rear seats: the outer rear seats are adjusted if they are in an unfavorable position.
- vehicles with a multicontour seat: the air pressure in the side bolsters of the seat backrest is increased.
- vehicles with seat belt extenders: the seat belts of the outer rear seats are pre-tensioned.

If the hazardous situation passes without resulting in an accident, PRE-SAFE® slackens the belt pre-tensioning. On vehicles with multicontour seats, the air pressure in the side

bolsters is reduced again. All settings made by PRE-SAFE® can then be reversed.

If the seat belt pre-tensioning is not reduced:

- ▶ Move the seat backrest or seat back slightly when the vehicle is stationary. The seat belt pre-tensioning is reduced and the locking mechanism is released.

The seat-belt adjustment is an integral part of the PRE-SAFE® convenience function. Information about the convenience function can be found under "Belt adjustment" (> page 53).

PRE-SAFE® PLUS (anticipatory occupant protection system PLUS)

Introduction

PRE-SAFE® PLUS is only available in vehicles with the Driving Assistance package.

Using the radar sensor system, PRE-SAFE® PLUS is able to detect that a head-on or rear-end collision is imminent. In certain hazardous situations, PRE-SAFE® PLUS takes pre-emptive measures to protect the vehicle occupants.

Important safety notes

The intervention of PRE-SAFE® PLUS cannot prevent an imminent collision.

The driver is not warned when PRE-SAFE® PLUS intervenes.

PRE-SAFE® PLUS does not intervene if the vehicle is backing up.

PRE-SAFE® PLUS does not perform braking actions while the vehicle is in motion or when Parking Guidance is active.

Function

PRE-SAFE® PLUS intervenes in certain situations if the radar sensor system detects an imminent head-on or rear-end collision.

PRE-SAFE® PLUS takes the following measures depending on the hazardous situation detected:

- if the radar sensor system detects that a head-on collision is imminent, the seat belts are pre-tensioned.
- if the radar sensor system detects that a rear-end collision is imminent:
 - the brake pressure is increased if the driver applies the brakes when the vehicle is stationary.
 - the seat belts are pre-tensioned.

The PRE-SAFE® PLUS braking application is canceled:

- if the accelerator pedal is depressed when a gear is engaged
- if the risk of a collision passes or is no longer detected
- if DISTRONIC PLUS indicates an intention to pull away

If the hazardous situation passes without resulting in an accident, the original settings are restored.

Automatic measures after an accident

Immediately after an accident, the following measures are implemented, depending on the type and severity of the impact:

- the hazard warning lamps are activated
- the emergency lighting is activated
- the vehicle doors are unlocked
- the front side windows are lowered
- the electrically adjustable steering wheel is raised
- the engine is switched off and the fuel supply is cut off
- vehicles with seat belt extenders: the seat-belt buckles for the outer rear seats are illuminated and extend forwards

- vehicles with mbrace: automatic emergency call
- vehicles with the hybrid drive system: the hybrid system and the high-voltage electrical system are deactivated

Children in the vehicle

Important safety notes

Accident statistics show that children secured in the rear seats are safer than children secured in the front-passenger seat. For this reason, Mercedes-Benz strongly advises that you install a child restraint system on a rear seat. Children are generally better protected there.

If a child younger than 12 years and under 5 ft (1.50 m) in height is traveling in the vehicle:

- always secure the child in a child restraint system suitable for Mercedes-Benz vehicles. The child restraint system must be appropriate to the age, weight and size of the child
- be sure to observe the instructions and safety notes in this section in addition to the child restraint system manufacturer's installation instructions
- be sure to observe the instructions and safety notes on the "Occupant classification system (OCS)" (▷ page 57)

WARNING

If you leave children unsupervised in the vehicle, they could set it in motion by, for example:

- release the parking brake.
- shift the automatic transmission out of the parking position **P**.
- start the engine.

In addition, they may operate vehicle equipment and become trapped. There is a risk of an accident and injury.

When leaving the vehicle, always take the SmartKey with you and lock the vehicle. Never leave children unsupervised in the vehicle.

WARNING

If persons, particularly children are subjected to prolonged exposure to extreme heat or cold, there is a risk of injury, possibly even fatal. Never leave children unattended in the vehicle.

WARNING

If the child restraint system is subjected to direct sunlight, parts may get very hot. Children may burn themselves on these parts, particularly on the metal parts of the child restraint system. There is a risk of injury.

If you leave the vehicle, taking the child with you, always ensure that the child restraint system is not exposed to direct sunlight. Protect it with a blanket, for example. If the child restraint system has been exposed to direct sunlight, let it cool down before securing the child in it. Never leave children unattended in the vehicle.

Always ensure that all vehicle occupants have their seat belts fastened correctly and are sitting properly. Particular attention must be paid to children.

Observe the safety notes on the seat belt (▷ page 49) and the notes on correct use of seat belts (▷ page 51).

A booster seat may be necessary to achieve proper seat belt positioning for children over 41 lbs (18 kg) or until they reach a height where a lap/shoulder belt can be fastened properly without a booster seat.

Special seat belt retractor

WARNING

If the seat belt is released while driving, the child restraint system will no longer be secured properly. The special seat belt retractor is disabled and the inertia reel draws in a portion of the seat belt. The seat belt cannot be immediately refastened. There is an increased risk of injury, possibly even fatal.

Stop the vehicle immediately, paying attention to road and traffic conditions. Reactivate the special seat belt retractor and secure the child restraint system properly.

All seat belts except the driver's seat belt are equipped with a special seat belt retractor. When activated, the special seat belt retractor ensures that the seat belt will not slacken once the child restraint system has been secured.

Installing a child restraint system:

- ▶ Always comply with the child restraint system manufacturer's installation instructions.
- ▶ Pull the seat belt smoothly from the belt outlet.
- ▶ Engage the seat belt tongue in the belt buckle.

Activating the special seat belt retractor:

- ▶ Pull the seat belt out fully and let the inertia reel retract it again.
While the seat belt is retracting, you should hear a ratcheting sound. The special seat belt retractor is activated.
- ▶ Push the child seat restraint system down so that the seat belt is tight and does not loosen.

Removing a child restraint system/deactivating the special seat belt retractor:

- ▶ Always comply with the child restraint system manufacturer's installation instructions.
- ▶ Press the release button on the belt buckle, hold the belt tongue firmly and guide it back towards the belt outlet.
The special seat belt retractor is deactivated.

Child restraint system

The use of seat belts and child restraint systems is required by law in:

- all 50 states
- the U.S. territories
- the District of Columbia
- all Canadian provinces

You can obtain further information about the correct child restraint system from any authorized Mercedes-Benz Center.

WARNING

If the child restraint system is installed incorrectly on a suitable seat, it cannot protect as intended. The child cannot then be restrained in the event of an accident, heavy braking or sudden changes of direction. There is an increased risk of injury, possibly even fatal.

Make sure that you observe the child restraint system manufacturer's installation instructions and the notes on use. Please ensure, that the base of the child restraint system is always resting completely on the seat cushion. Never place objects, e.g. cushions, under or behind the child restraint system. Only use child restraint systems with the original cover designed for them. Only replace damaged covers with genuine covers.

WARNING

If the child restraint system is installed incorrectly or is not secured, it can come loose in the event of an accident, heavy braking or a sudden change in direction. The child restraint system could be thrown about, striking vehicle occupants. There is an increased risk of injury, possibly even fatal.

Always install child restraint systems properly, even if they are not being used. Make sure that you observe the child restraint system manufacturer's installation instructions.

You will find further information on stowing objects, luggage or loads under "Loading guidelines" (> page 232).

⚠ WARNING

Child restraint systems or their securing systems which have been damaged or subjected to a load in an accident can no longer protect as intended. The child cannot then be restrained in the event of an accident, heavy braking or sudden changes of direction. There is an increased risk of injury, possibly even fatal.

Replace child restraint systems which have been damaged or subjected to a load in an accident as soon as possible. Have the securing systems on the child restraint system checked at a qualified specialist workshop, before you install a child restraint system again.

The securing systems of child restraint systems are:

- the seat belt system
- the LATCH-type (ISOFIX) securing rings
- the Top Tether anchorages

If it is absolutely necessary to carry a child on the front-passenger seat, be sure to observe the information on the "Occupant Classification System (OCS)" (▷ page 57). There you will also find information on deactivating the front-passenger front air bag.

All child restraint systems must meet the following standards:

- U.S. Federal Motor Vehicle Safety Standards 213 and 225
- Canadian Motor Vehicle Safety Standards 213 and 210.2

Confirmation that the child restraint system corresponds to the standards can be found on an instruction label on the child restraint system. This confirmation can also be found in the installation instructions that are included with the child restraint system.

Observe the warning labels in the vehicle interior and on the child restraint system.

Vehicles with seat belt extenders: when securing a child in a child restraint system on a rear seat, observe the following instructions:

- make sure that the seat belt on the child restraint system is fastened according to the manufacturer's installation instructions for the child restraint system.
- for child restraint systems with a belt clamp: engage the belt tongue in the buckle before you tighten the seat belt using the belt clamp.

Vehicles with a rear reclining seat: when installing a child restraint system, move the rear reclining seat backrest to an almost vertical position. The rear reclining seat backrest must rest against the child restraint system. Observe the notes on the cushion air bag (▷ page 57).

Vehicles with belt bags: only use a child restraint system which has been approved by Mercedes-Benz. Always observe the instructions and safety notes on belt bags for the outer seat belts in the rear (▷ page 51).

LATCH-type (ISOFIX) child seat securing system**⚠ WARNING**

LATCH-type (ISOFIX) child restraint systems do not offer sufficient protective effect for children whose weight is greater than 48 lbs (22 kg) who are secured using the safety belt integrated in the child restraint system. In the event of an accident, a child might not be restrained correctly. This poses an increased risk of injury or even fatal injury.

If the child weighs more than 48 lbs (22 kg), only use LATCH-type (ISOFIX) child restraint systems with which the child is also secured with the vehicle seat belt. Also secure the child restraint system with the Top Tether belt, if available.

Always comply with the manufacturer's installation and operating instructions for the child restraint system used.

Before every trip, make sure that the LATCH-type (ISOFIX) child restraint system is engaged correctly in both LATCH-type (ISOFIX) securing rings

- ❗ When installing the child restraint system, make sure that the seat belt for the middle seat does not get trapped. The seat belt could otherwise be damaged.

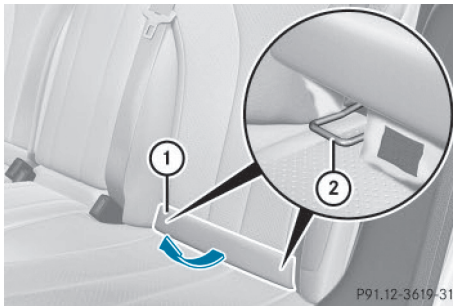

LATCH-type (ISOFIX) securing rings ② on the rear seats are covered by a Velcro-fastened upholstered lining ①.

- ▶ **Vehicles with a rear reclining seat:** adjust the rear reclining seat backrest down a little before installing the LATCH-type (ISOFIX) child restraint system.
- ▶ **Vehicles without rear reclining seat:** fold upholstered lining ① upwards.
- ▶ **Vehicles with a rear reclining seat:** remove upholstered lining ①.
- ▶ **Vehicles without a rear reclining seat:** turn the support on the rear side of upholstered lining ① by 90°. Upholstered lining ① remains folded upwards.
- ▶ Install the LATCH-type (ISOFIX) child restraint system on both LATCH-type (ISOFIX) securing rings ②.
- ▶ **Vehicles with a rear reclining seat:** move the rear reclining seat backrest to an upright position. The rear reclining seat

backrest must rest against the child restraint system.

⚠ WARNING

Vehicles with electrically adjustable rear bench seats:

If you adjust the seat after installing a child restraint system:

- the seat belt could slacken or become too tight
- the child restraint system could become loose, incorrectly positioned or damaged

As a result, the child restraint system may not be able to provide the intended level of protection. This poses an increased risk of injury or even fatal injury.

Never adjust the seat after installing the child restraint system.

Vehicles without rear reclining seat: after you have removed the LATCH-type (ISOFIX) child restraint system, you must turn the support on the rear side of upholstered lining ① by 90° again. Then fold upholstery lining ① down.

ISOFIX is a standardized securing system for specially designed child restraint systems on the rear seats. LATCH-type (ISOFIX) securing rings ② for two LATCH-type (ISOFIX) child restraint systems are installed on the left and right rear seats.

Vehicles with rear seat armrest: adjust the rear seat armrest so that LATCH-type (ISOFIX) securing rings ② for the LATCH-type (ISOFIX) child restraint system are accessible.

Non-LATCH-type (ISOFIX) child seats may also be used and can be installed using the vehicle's seat belt system. Install the child seat according to the manufacturer's instructions.

Top Tether

Introduction

Top Tether provides an additional connection between the child restraint system secured with a LATCH-type (ISOFIX) child seat mount and the vehicle. This helps reduce the risk of injury even further. If the child restraint system is equipped with a Top Tether belt, this should always be used.

Important safety notes

WARNING

If the rear seat backrests are not locked, they could fold forwards in the event of an accident, heavy braking or sudden changes of direction. As a result, child restraint systems cannot perform their intended protective function. Rear seat backrests that are not locked can also cause additional injuries, e.g. in the event of an accident. This poses an increased risk of injury or even fatal injury.

Always lock rear seat backrests after installing a Top Tether belt. Observe the lock verification indicator. Adjust the rear seat backrests so that they are in an upright position.

WARNING

Vehicles with electrically adjustable rear bench seats:

If you adjust the seat after installing a child restraint system:

- the seat belt could slacken or become too tight
- the child restraint system could become loose, incorrectly positioned or damaged

As a result, the child restraint system may not be able to provide the intended level of protection. This poses an increased risk of injury or even fatal injury.

Never adjust the seat after installing the child restraint system.

If the rear seat backrest is not engaged and locked, this will be shown in the multifunction

display in the instrument cluster. A warning tone also sounds.

Top Tether anchorages



The Top Tether anchorage points are installed in the rear compartment behind the head restraints on the parcel shelf.

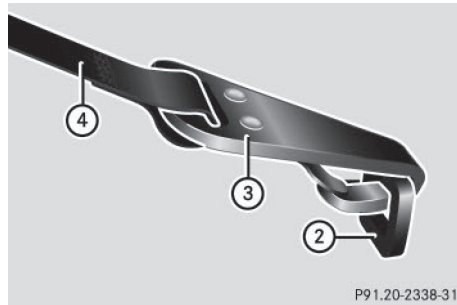

- ▶ Move the head restraint upwards.
- ▶ Fold up cover ① of the Top Tether anchorage.
- ▶ Install the LATCH-type (ISOFIX) child restraint system with Top Tether. Always comply with the child restraint system manufacturer's installation instructions when doing so.
- ▶ Route Top Tether belt ④ under the head restraint between the two head restraint bars.
- ▶ Hook Top Tether hook ③ of Top Tether belt ④ into Top Tether anchorage ②. Make sure that Top Tether belt ④ is not twisted.

- ▶ Tension Top Tether belt ④. Always comply with the child restraint system manufacturer's installation instructions when doing so.
- ▶ Fold down cover ① of the Top Tether anchorage.
- ▶ If necessary, move the head restraint back down again slightly (▷ page 112). Make sure that you do not interfere with the correct routing of Top Tether belt ④.

Child restraint system on the front-passenger seat

General notes

Accident statistics show that children secured in the rear seats are safer than children secured in the front-passenger seat. For this reason, Mercedes-Benz strongly advises that you install the child restraint system on a rear seat.

If it is absolutely necessary to install a child restraint system on the front-passenger seat, be sure to observe the instructions and safety notes on the "Occupant Classification System (OCS)" (▷ page 57).

You can thus avoid the risks that could arise as a result of:

- an incorrectly categorized person in the front-passenger seat
- the unintentional deactivation of the front-passenger front air bag
- the unsuitable positioning of the child restraint system, e.g. too close to the dashboard

Rearward-facing child restraint system

If it is absolutely necessary to install a rearward-facing child restraint system on the front-passenger seat, always make sure that the front-passenger front air bag is deactivated. Only if the PASSENGER AIR BAG OFF indicator lamp is permanently lit (▷ page 48) is the front-passenger front air bag deactivated.

Always observe the child restraint system manufacturer's installation and operating instructions.

Forward-facing child restraint system

If it is absolutely necessary to install a forward-facing child restraint system on the front-passenger seat, always move the front-passenger seat as far back as possible. Fully retract the seat cushion length. The entire base of the child restraint system must always rest on the seat cushion of the front-passenger seat. The backrest of the child restraint system must lie as flat as possible against the backrest of the front-passenger seat. The child restraint system must not touch the roof or be subjected to a load by the head restraint. Adjust the angle of the seat backrest and the head restraint position accordingly. Always make sure that the shoulder belt strap is correctly routed from the vehicle belt outlet to the shoulder belt guide on the child restraint system. The shoulder belt strap must be routed forwards and downwards from the vehicle belt outlet. If necessary, adjust the vehicle belt outlet and the front-passenger seat accordingly.

Always observe the child restraint system manufacturer's installation and operating instructions.

Child-proof locks

Important safety notes

WARNING

If children are traveling in the vehicle, they could:

- open doors, thus endangering other people or road users
- exit the vehicle and be caught by oncoming traffic
- operate vehicle equipment and become trapped

There is a risk of an accident and injury.

Always activate the child-proof locks and override feature if children are traveling in the vehicle. When leaving the vehicle, always take the key with you and lock the vehicle. Never leave children unattended in the vehicle.

Override feature for:

- the rear doors (▷ page 73)
- the rear side windows (▷ page 73)

WARNING

If you leave children unsupervised in the vehicle, they could set it in motion by, for example:

- release the parking brake.
- shift the automatic transmission out of the parking position **P**.
- start the engine.

In addition, they may operate vehicle equipment and become trapped. There is a risk of an accident and injury.

When leaving the vehicle, always take the SmartKey with you and lock the vehicle. Never leave children unsupervised in the vehicle.

WARNING

If persons, particularly children are subjected to prolonged exposure to extreme heat or cold, there is a risk of injury, possibly even fatal. Never leave children unattended in the vehicle.

WARNING

If the child restraint system is subjected to direct sunlight, parts may get very hot. Children may burn themselves on these parts, particularly on the metal parts of the child restraint system. There is a risk of injury.

If you leave the vehicle, taking the child with you, always ensure that the child restraint system is not exposed to direct sunlight. Protect it with a blanket, for example. If the child restraint system has been exposed to direct sunlight, let it cool down before securing the child in it. Never leave children unattended in the vehicle.

Child-proof locks for the rear doors

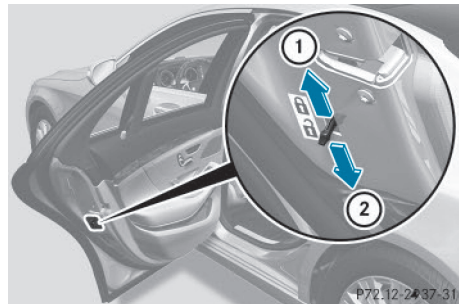

You secure each door individually with the child-proof locks on the rear doors. A door secured with a child-proof lock cannot be opened from inside the vehicle. When the vehicle is unlocked, the door can be opened from the outside.

- ▶ **To activate:** press the child-proof lock lever up in the direction of arrow ①.
- ▶ Make sure that the child-proof locks are working properly.
- ▶ **To deactivate:** press the child-proof lock lever down in the direction of arrow ②.

Override feature for the rear side windows

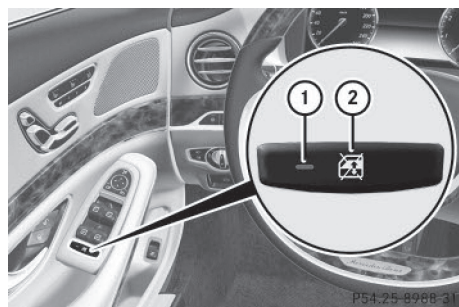

- ▶ **To activate/deactivate:** press button ②. If indicator lamp ① is lit, operation of the rear side windows is disabled. Operation is only possible using the switches in the driver's door. If indicator lamp ① is off, operation is possible using the switches in the rear compartment.

When the override feature is activated, the controls in the rear compartment are disabled for:

- the rear side windows
- adjustment of the front-passenger seat from the rear compartment
- the sunblinds:
 - of the rear side windows
 - of the rear window
 - in the roof

- COLLISION PREVENTION ASSIST PLUS (distance warning function and Adaptive Brake Assist) (▷ page 77)
- ESP® (Electronic Stability Program) (▷ page 79)
- EBD (Electronic Brake force Distribution) (▷ page 81)
- ADAPTIVE BRAKE (▷ page 82)
- PRE-SAFE® Brake (▷ page 82)
- STEER CONTROL (▷ page 84)

Pets in the vehicle

WARNING

If you leave animals unattended or unsecured in the vehicle, they could press buttons or switches, for example.

As a result, they could:

- activate vehicle equipment and become trapped, for example
- activate or deactivate systems, thereby endangering other road users

Unsecured animals could also be flung around the vehicle in the event of an accident or sudden steering or braking, thereby injuring vehicle occupants. There is a risk of an accident and injury.

Never leave animals unattended in the vehicle. Always secure animals properly during the journey, e.g. use a suitable animal transport box.

Important safety notes

If you fail to adapt your driving style or if you are inattentive, the driving safety systems can neither reduce the risk of an accident nor override the laws of physics. Driving safety systems are merely aids designed to assist driving. You are responsible for maintaining the distance to the vehicle in front, for vehicle speed, for braking in good time and for staying in lane. Always adapt your driving style to suit the prevailing road and weather conditions and maintain a safe distance from the vehicle in front. Drive carefully.

The driving safety systems described only work as effectively as possible when there is adequate contact between the tires and the road surface. Pay particular attention to the information regarding tires, recommended minimum tire tread depths etc. in the "Wheels and tires" section (▷ page 276).

In wintry driving conditions, always use winter tires (M+S tires) and if necessary, snow chains. Only in this way will the driving safety systems described in this section work as effectively as possible.

Driving safety systems

Overview of driving safety systems

In this section, you will find information about the following driving safety systems:

- ABS (Anti-lock Braking System) (▷ page 74)
- BAS (Brake Assist System) (▷ page 75)
- BAS PLUS (Brake Assist System PLUS) with Cross-Traffic Assist (▷ page 75)

ABS (Anti-lock Braking System)

General information

ABS regulates brake pressure in such a way that the wheels do not lock when you brake. This allows you to continue steering the vehicle when braking.

The  ABS warning lamp in the instrument cluster lights up when the ignition is switched on. It goes out when the engine is running.

Important safety notes

- i** Observe the "Important safety notes" section (▷ page 74).

WARNING

If ABS is faulty, the wheels could lock when braking. The steerability and braking characteristics may be severely impaired. Additionally, further driving safety systems are deactivated. There is an increased danger of skidding and accidents.

Drive on carefully. Have ABS checked immediately at a qualified specialist workshop.

When ABS is malfunctioning, other systems, including driving safety systems, will also become inoperative. Observe the information on the ABS warning lamp (▷ page 214) and display messages which may be shown in the instrument cluster (▷ page 196).

ABS works from a speed of about 5 mph (8 km/h), regardless of road-surface conditions. ABS works on slippery surfaces, even when you only brake gently.

Braking

- ▶ **If ABS intervenes:** continue to depress the brake pedal vigorously until the braking situation is over.
- ▶ **To make a full brake application:** depress the brake pedal with full force.

If ABS intervenes when braking, you will feel a pulsing in the brake pedal.

The pulsating brake pedal can be an indication of hazardous road conditions, and functions as a reminder to take extra care while driving.

BAS (Brake Assist System)

General information

BAS operates in emergency braking situations. If you depress the brake pedal quickly, BAS automatically boosts the braking force, thus shortening the stopping distance.

Important safety notes

- i** Observe the "Important safety notes" section (▷ page 74).

WARNING

If BAS is malfunctioning, the braking distance in an emergency braking situation is increased. There is a risk of an accident.

In an emergency braking situation, depress the brake pedal with full force. ABS prevents the wheels from locking.

Braking

- ▶ Keep the brake pedal firmly depressed until the emergency braking situation is over. ABS prevents the wheels from locking.

The brakes will function as usual once you release the brake pedal. BAS is deactivated.

BAS PLUS (Brake Assist System PLUS) with Cross-Traffic Assist

General information

- i** Observe the "Important safety notes" section (▷ page 74).

BAS PLUS is only available on vehicles with the Driving Assistance package.

For BAS PLUS to assist you when driving, the radar sensor system and the camera system must be operational.

With the help of a sensor system and a camera system, BAS PLUS can detect obstacles:

- that are in the path of your vehicle for an extended period of time
- that cross the path of your vehicle

In addition, pedestrians in the path of your vehicle can be detected.

BAS PLUS detects pedestrians by using typical characteristics such as the body contours and posture of a person standing upright.

If the radar sensor system or the camera system is malfunctioning, BAS PLUS functions are restricted or no longer available. The brake system is still available with complete brake boosting effect and BAS.

i Observe the restrictions described in the "Important safety notes" section" (▷ page 76).

BAS PLUS can help you to minimize the risk of a collision with a vehicle or a pedestrian and reduce the effects of such a collision. If BAS PLUS detects a danger of collision, you are assisted when braking.

Important safety notes

WARNING

BAS PLUS cannot always clearly identify objects and complex traffic situations.

In such cases, BAS PLUS may:

- intervene unnecessarily
- not intervene

There is a risk of an accident.

Always pay careful attention to the traffic situation and be ready to brake. Terminate the intervention in a non-critical driving situation.

WARNING

BAS PLUS does not react:

- to small people, e.g. children
- to animals
- to oncoming vehicles
- when cornering

As a result, BAS PLUS may not intervene in all critical situations. There is a risk of an accident.

Always pay careful attention to the traffic situation and be ready to brake.

In the event of snowfall or heavy rain, the recognition can be impaired.

Recognition by the radar sensor system is also impaired in the event of:

- there is dirt on the sensors or anything else covering the sensors
- there is interference by other radar sources
- there are strong radar reflections, for example in parking garages
- a narrow vehicle traveling in front, e.g. a motorbike
- a vehicle traveling in front on a different line
- vehicles quickly moving into the radar sensor system detection range

Recognition by the camera system is also impaired in the event of:

- dirt on the camera or if the camera is covered
- there is glare on the camera system, e.g. from the sun being low in the sky
- darkness
- if:
 - pedestrians move quickly, e.g. into the path of the vehicle
 - the camera system no longer recognizes a pedestrian as a person due to special clothing or other objects
 - a pedestrian is concealed by other objects
 - the typical outline of a person is not distinguishable from the background

Following damage to the front end of the vehicle, have the configuration and operation of the radar sensors checked at a qualified specialist workshop. This also applies to collisions at low speeds where there is no visible damage to the front of the vehicle.

Following damage to the windshield, have the configuration and operation of the camera system checked at a qualified specialist workshop.

Function

To avoid a collision, BAS PLUS calculates the brake force necessary if:

- you approach an obstacle, and
- BAS PLUS has detected a risk of collision

When driving at a speed under 20 mph (30 km/h): if you depress the brake pedal, BAS PLUS is activated. The increase in brake pressure will be carried out at the last possible moment.

When driving at a speed above 20 mph (30 km/h): if you depress the brake pedal sharply, BAS PLUS automatically raises the brake pressure to a value adapted to the traffic situation.

BAS PLUS provides braking assistance in hazardous situations with vehicles in front within a speed range between 4 mph (7 km/h) and 155 mph (250 km/h).

At speeds of up to approximately 44 mph (70 km/h), BAS PLUS can react to:

- stationary objects in the path of your vehicle, e.g. stopped or parked vehicles
- pedestrians in the path of your vehicle
- objects crossing your path and that are recognized in the detection range of the sensors

i If BAS PLUS demands particularly high braking force, preventative passenger protection measures (PRE-SAFE®) are activated simultaneously.

- ▶ Keep the brake pedal depressed until the emergency braking situation is over. ABS prevents the wheels from locking.

BAS PLUS is deactivated and the brakes function as usual again, if:

- you release the brake pedal.
- there is no longer a risk of collision.
- no obstacle is detected in front of your vehicle.
- you depress the accelerator pedal.
- you activate kickdown.

COLLISION PREVENTION ASSIST PLUS

General information

COLLISION PREVENTION ASSIST PLUS consists of a distance warning function with an autonomous braking function and adaptive Brake Assist.

COLLISION PREVENTION ASSIST PLUS can help you to minimize the risk of a front-end collision with a vehicle ahead or reduce the effects of such a collision.

If COLLISION PREVENTION ASSIST PLUS detects that there is a risk of a collision, you will be warned visually and acoustically. If you do not react to the visual and audible collision warning, autonomous braking can be initiated in critical situations. If you apply the brake yourself in a critical situation, the COLLISION PREVENTION ASSIST PLUS adaptive Brake Assist assists you.

Important safety notes

In particular, the detection of obstacles can be impaired if:

- there is dirt on the sensors or anything else covering the sensors
 - there is snow or heavy rain
 - there is interference by other radar sources
 - there are strong radar reflections, for example in parking garages
 - a narrow vehicle traveling in front, e.g. a motorbike
 - a vehicle traveling in front on a different line
 - new vehicles or after a service on the COLLISION PREVENTION ASSIST PLUS system
- Observe the notes in the section on braking-in (> page 132).

Following damage to the front end of the vehicle, have the configuration and operation of the radar sensor checked at a qualified specialist workshop. This also applies to collisions at low speeds where there is no visible damage to the front of the vehicle.

Distance warning function

Important safety notes

- ❗ Observe the "Important safety notes" section for driving safety systems (▷ page 74).

WARNING

The distance warning function does not react:

- to people or animals
- to oncoming vehicles
- to crossing traffic
- when cornering

Thus, the distance warning function cannot provide a warning in all critical situations. There is a risk of an accident.

Always pay careful attention to the traffic situation and be ready to brake.

WARNING

The distance warning function cannot always clearly identify objects and complex traffic situations.

In such cases, the distance warning function may:

- give an unnecessary warning
- not give a warning

There is a risk of an accident.

Always pay careful attention to the traffic situation and do not rely solely on the distance warning function.

Function

- ▶ **To activate/deactivate:** activate or deactivate the distance warning function in the on-board computer (▷ page 194).

If the distance warning function is not activated, the  symbol appears in the assistance graphics display.

The distance warning function can help you to minimize the risk of a front-end collision with a vehicle ahead or reduce the effects of such a collision. If the distance warning function detects that there is a risk of a collision, you will be warned visually and acoustically.

Starting at a speed of around 4 mph (7 km/h), the distance warning function warns you if you rapidly approach a vehicle in front. An intermittent warning tone will then sound, and the  distance warning lamp will light up in the instrument cluster.

- ▶ Brake immediately in order to increase the distance from the vehicle in front.

or

- ▶ Take evasive action, provided it is safe to do so.

Due to the nature of the system, particularly complicated but non-critical driving conditions may also cause the system to display a warning.

With the help of the radar sensor system, the distance warning function can detect obstacles that are in the path of your vehicle for an extended period of time.

Up to a speed of around 44 mph (70 km/h), the distance warning function can also react to stationary obstacles, such as stopped or parked vehicles.

If you approach an obstacle and the distance warning function detects a risk of a collision, the system will initially alert you both visually and acoustically.

Autonomous braking function

If the driver does not react to the distance warning signal in a critical situation, COLLISION PREVENTION ASSIST PLUS can assist with the autonomous braking function.

The autonomous braking function:

- gives the driver more time to react to critical driving situations
- can help the driver to avoid an accident or
- reduces the effects of an accident

The autonomous braking function is available in the following speed ranges:

- from 5 mph (7 km/h) to approx. 65 mph (105 km/h) for moving objects
- from 5 mph (7 km/h) to approx. 31 mph (50 km/h) for stationary objects

If the autonomous braking function requires a particularly high braking force, preventative passenger protection measures (PRE-SAFE®) are activated simultaneously.

Adaptive Brake Assist

i Observe the "Important safety notes" section (▷ page 74).

Adaptive Brake Assist provides braking assistance in hazardous situations at speeds above 4 mph (7 km/h). It uses radar sensor technology to assess the traffic situation.

⚠ WARNING

Adaptive Brake Assist cannot always clearly identify objects and complex traffic situations.

In such cases, Adaptive Brake Assist can:

- intervene unnecessarily
- not intervene

There is a risk of an accident.

Always pay careful attention to the traffic situation and be ready to brake. Terminate the intervention in a non-critical driving situation.

⚠ WARNING

Adaptive Brake Assist does not react:

- to people or animals
- to oncoming vehicles
- to crossing traffic
- when cornering

As a result, the Adaptive Brake Assist may not intervene in all critical conditions. There is a risk of an accident.

Always pay careful attention to the traffic situation and be ready to brake.

Due to the nature of the system, particularly complicated but non-critical driving conditions may also cause Brake Assist to intervene.

If adaptive Brake Assist is not available due to a malfunction in the radar sensor system, the

brake system remains available with full brake boosting effect and BAS.

With the help of adaptive Brake Assist, the distance warning signal can detect obstacles that are in the path of your vehicle for an extended period of time.

If adaptive Brake Assist detects a risk of collision with the vehicle in front, it calculates the braking force necessary to avoid a collision. If you apply the brakes forcefully, adaptive Brake Assist will automatically increase the braking force to a level suitable for the traffic conditions.

- ▶ Keep the brake pedal depressed until the emergency braking situation is over. ABS prevents the wheels from locking.

The brakes will work normally again if:

- you release the brake pedal.
- there is no longer any danger of a collision.
- no obstacle is detected in front of your vehicle.

Adaptive Brake Assist is then deactivated.

If adaptive Brake Assist demands particularly high braking force, preventative passenger protection measures (PRE-SAFE®) are activated simultaneously.

Up to a speed of approximately 155 mph (250 km/h), adaptive Brake Assist is capable of reacting to moving objects that have already been detected as such at least once over the period of observation.

Up to a speed of approximately 44 mph (70 km/h), adaptive Brake Assist reacts to stationary obstacles.

ESP® (Electronic Stability Program)

General notes

i Observe the "Important safety notes" section (▷ page 74).

ESP® monitors driving stability and traction, i.e. power transmission between the tires and the road surface.

If ESP® detects that the vehicle is deviating from the direction desired by the driver, one or more wheels are braked to stabilize the vehicle. The engine output is also modified to keep the vehicle on the desired course within physical limits. ESP® assists the driver when pulling away on wet or slippery roads. ESP® can also stabilize the vehicle during braking.

ETS/4ETS (Electronic Traction System)

i Observe the "Important safety notes" section (▷ page 74).

ETS traction control is part of ESP®. On vehicles with 4MATIC, 4ETS is part of ESP®.

Traction control brakes the drive wheels individually if they spin. This enables you to pull away and accelerate on slippery surfaces, for example if the road surface is slippery on one side. In addition, more drive torque is transferred to the wheel or wheels with traction.

Traction control remains active, even if you deactivate ESP®.

Important safety notes

WARNING

If ESP® is malfunctioning, ESP® is unable to stabilize the vehicle. Additionally, further driving safety systems are deactivated. This increases the risk of skidding and an accident.

Drive on carefully. Have ESP® checked at a qualified specialist workshop.

Vehicles without 4MATIC: observe the notes on ESP® (▷ page 27 1) when towing the vehicle with a raised rear axle.

ESP® is only deactivated if the  warning lamp is lit continuously.

If the  warning lamp lights up continuously, ESP® is not available due to a malfunction.

Observe the information on warning lamps (▷ page 216) and display messages which may be shown in the instrument cluster (▷ page 196).

Only use wheels with the recommended tire sizes. Only then will ESP® function properly.

Characteristics of ESP®

General information

If the  ESP warning lamp goes out before beginning the journey, ESP® is automatically active.

If ESP® intervenes, the  ESP® warning lamp flashes in the instrument cluster.

If ESP® intervenes:

- ▶ Do not deactivate ESP® under any circumstances.
- ▶ Only depress the accelerator pedal as far as necessary when pulling away.
- ▶ Adapt your driving style to suit the prevailing road and weather conditions.

ECO start/stop function

The ECO start/stop function switches the engine off automatically when the vehicle stops moving. The engine starts automatically when the driver wants to pull away again. ESP® remains in its previously selected status. **Example:** if ESP® was deactivated before the engine was switched off, ESP® remains deactivated when the engine is switched on again.

Deactivating/activating ESP®

Important safety notes

i Observe the "Important safety notes" section (▷ page 74).

You can select between the following states of ESP®:

- ESP® is activated.
- ESP® is deactivated.

WARNING

If you deactivate ESP®, ESP® no longer stabilizes the vehicle. There is an increased risk of skidding and an accident.

Only deactivate ESP® in the situations described in the following.

It may be best to deactivate ESP® in the following situations:

- when using snow chains
- in deep snow
- on sand or gravel

i Activate ESP® as soon as the situations described above no longer apply. ESP® will otherwise not be able to stabilize the vehicle if the vehicle starts to skid or a wheel starts to spin.

! Avoid spinning the driven wheels for an extended period with ESP® deactivated. You could otherwise damage the drivetrain.

Deactivating/activating ESP®

You can deactivate or activate ESP® via the on-board computer.

▶ **To deactivate:** (▷ page 80).

The  ESP® OFF warning lamp in the instrument cluster lights up.

▶ **To activate:** (▷ page 80).

The  ESP® OFF warning lamp in the instrument cluster goes out.

Characteristics when ESP® is deactivated

If ESP® is deactivated and one or more wheels start to spin, the  ESP® warning lamp in the instrument cluster flashes. In such situations, ESP® will not stabilize the vehicle.

If you deactivate ESP®:

- ESP® no longer improves driving stability.
- engine torque is no longer limited and the drive wheels are able to spin.

The spinning of the wheels results in a cutting action for better traction on loose surfaces.

- traction control is still activated.
- ESP® still provides support when you brake.

Crosswind Assist (vehicles without MAGIC BODY CONTROL)

General information

Vehicles with MAGIC BODY CONTROL: information on stabilizing the vehicle in the event of crosswind (▷ page 169).

Strong crosswinds can cause your vehicle to deviate from a straight course. The crosswind driving assistance function integrated into ESP® significantly reduces these effects.

ESP® intervenes automatically according to the direction and intensity of the crosswinds affecting your vehicle.

ESP intervenes with stabilizing braking to assist you in keeping the vehicle in the lane.

Crosswind Assist is active at vehicle speeds above 50 mph (80 km/h) when driving straight ahead or cornering gently.

Important safety notes

Crosswind Assist does not work if ESP® is deactivated or disabled because of a malfunction.

EBD (electronic brake force distribution)

General information

EBD monitors and controls the brake pressure on the rear wheels to improve driving stability while braking.

Important safety notes

i Observe the "Important safety notes" section (▷ page 74).

WARNING

If EBD is malfunctioning, the rear wheels can lock, e.g. under full braking. This increases the risk of skidding and an accident.

You should therefore adapt your driving style to the different handling characteristics. Have the brake system checked at a qualified specialist workshop.

Observe information regarding indicator and warning lamps (▷ page 214) as well as display messages (▷ page 199).

ADAPTIVE BRAKE

ADAPTIVE BRAKE enhances braking safety and offers increased braking comfort. In addition to the braking function, ADAPTIVE BRAKE also has the HOLD function (▷ page 167) and hill start assist (▷ page 137).

PRE-SAFE® Brake

General information

i Pay attention to the important safety notes in the "Driving safety systems" section (▷ page 74).

PRE-SAFE® Brake is only available for vehicles with the Driving Assistance package.

For PRE-SAFE® Brake to assist you when driving, the radar sensor system and the camera system must be switched on and be operational.

With the help of the radar sensor system and the camera system, PRE-SAFE® Brake can detect obstacles that are in front of your vehicle for an extended period of time.

In addition, pedestrians in the path of your vehicle can be detected.

PRE-SAFE® Brake detects pedestrians using typical characteristics such as the body contours and posture of a person standing upright.

Observe the restrictions described in the "Important safety notes" section (▷ page 82).

PRE-SAFE® Brake can help you to minimize the risk of a collision with a vehicle ahead or a pedestrian, and reduce the effects of such a collision. If PRE-SAFE® Brake has detected a risk of collision, you will be warned visually and acoustically as well as by automatic braking.

Important safety notes

WARNING

PRE-SAFE® Brake will initially brake your vehicle by a partial application of the brakes if a danger of collision is detected. There may be a collision unless you brake yourself. Even after subsequent full application of the brakes a collision cannot always be avoided, particularly when approaching at too high a speed. There is a risk of an accident.

Always apply the brakes yourself and try to take evasive action, provided it is safe to do so.

WARNING

PRE-SAFE® Brake cannot always clearly identify objects and complex traffic conditions.

In these cases, PRE-SAFE® Brake may:

- give an unnecessary warning and then brake the vehicle
- not give a warning or intervene

There is a risk of an accident.

Always pay particular attention to the traffic situation and be ready to brake, especially if PRE-SAFE® Brake warns you. Terminate the intervention in a non-critical driving situation.

In order to maintain the appropriate distance to the vehicle in front and thus prevent a collision, you must apply the brakes yourself.

PRE-SAFE® Brake can also brake the vehicle automatically under the following conditions:

- the driver and front-passenger have their seat belts fastened and
- the vehicle speed is between approximately 4 mph (7 km/h) and 124 mph (200 km/h)

At a speed of up to approximately 44 mph (70 km/h), PRE-SAFE® Brake can also detect:

- stationary objects in the path of your vehicle, e.g. stopped or parked vehicles
- pedestrians in the path of your vehicle

⚠ WARNING

PRE-SAFE® Brake does not react:

- to small people, e.g. children
- to animals
- to oncoming vehicles
- to crossing traffic
- when cornering

As a result, PRE-SAFE® Brake may neither give warnings nor intervene in all critical situations. There is a risk of an accident.

Always pay careful attention to the traffic situation and be ready to brake.

In the event of snowfall or heavy rain, the recognition can be impaired.

Recognition by the radar sensor system is also impaired in the event of:

- there is dirt on the sensors or anything else covering the sensors
- there is interference by other radar sources
- there are strong radar reflections, for example in parking garages
- a narrow vehicle traveling in front, e.g. a motorbike
- a vehicle traveling in front on a different line relative to the center of your vehicle

Recognition by the camera system is also impaired in the event of:

- dirt on the camera or if the camera is covered
- there is glare on the camera system, e.g. from the sun being low in the sky
- darkness
- if:
 - pedestrians move quickly, e.g. into the path of the vehicle
 - the camera system no longer recognizes a pedestrian as a person due to special clothing or other objects
 - a pedestrian is concealed by other objects
 - the typical outline of a person is not distinguishable from the background

Following damage to the front end of the vehicle, have the configuration and operation of the radar sensors checked at a qualified specialist workshop. This also applies to collisions at low speeds where there is no visible damage to the front of the vehicle.

Following damage to the windshield, have the configuration and operation of the camera system checked at a qualified specialist workshop.

Function

► **To activate/deactivate:** activate or deactivate PRE-SAFE® Brake in the on-board computer (▷ page 194).

If the PRE-SAFE® Brake is not activated, the  symbol appears in the multifunction display.

Starting at a speed of around 4 mph (7 km/h), this function warns you if you rapidly approach a vehicle in front. An intermittent warning tone will then sound and the  distance warning lamp will light up in the instrument cluster.

► Brake immediately to defuse the situation.

or

► Take evasive action provided it is safe to do so.

i If there is an increased risk of collision, preventive passenger protection measures (PRE-SAFE®) are activated.

If the risk of collision with the vehicle in front remains and you do not brake, take evasive action or accelerate significantly, the vehicle may perform automatic emergency braking, up to the point of full brake application. Automatic emergency braking is not performed until immediately prior to an imminent accident.

You can prevent the intervention of the PRE-SAFE® Brake at any time by:

- depressing the accelerator pedal further.
- activating kickdown.
- releasing the brake pedal.

The braking action of PRE-SAFE® Brake is ended automatically if:

- you maneuver to avoid the obstacle.
- there is no longer a risk of collision.
- there is no longer an obstacle detected in front of your vehicle.

STEER CONTROL

General information

STEER CONTROL helps you by transmitting a noticeable steering force to the steering wheel in the direction required for vehicle stabilization.

This steering assistance is provided in particular if:

- both right wheels or both left wheels are on a wet or slippery road surface when you brake.
- the vehicle starts to skid.

Important safety notes

- i** Observe the "Important safety notes" section (> page 74).

No steering support is provided from STEER CONTROL, if:

- ESP® is malfunctioning.
- the lighting is faulty.

Power steering will, however, continue to function.

Protection against theft

Immobilizer

The immobilizer prevents your vehicle from being started without the correct SmartKey.

- ▶ **To activate with the SmartKey:** remove the SmartKey from the ignition lock.
- ▶ **To activate with KEYLESS-GO:** switch the ignition off and open the driver's door.
- ▶ **To deactivate:** switch on the ignition.

When leaving the vehicle, always take the SmartKey with you and lock the vehicle. Anyone can start the engine if a valid SmartKey has been left inside the vehicle.

- i** The immobilizer is always deactivated when you start the engine.

In the event that the engine cannot be started (yet the vehicle's battery is charged), the system is not operational. Contact an authorized Mercedes-Benz Center or call 1-800-FOR-MERCEdes (in the USA) or 1-800-387-0100 (in Canada).

ATA (anti-theft alarm system)



- ▶ **To arm:** lock the vehicle with the SmartKey or KEYLESS-GO. Indicator lamp ① flashes. The alarm system is armed after approximately 15 seconds.

- ▶ **To disarm:** unlock the vehicle with the SmartKey or KEYLESS-GO.

or

- ▶ Insert the SmartKey into the ignition lock.

A visual and audible alarm is triggered if the alarm system is armed and you open:

- a door
- the vehicle with the mechanical key
- the trunk lid
- the hood

► **To turn the alarm off with the SmartKey:**

press the  or  button on the SmartKey.

The alarm is switched off.

or

- Remove the Start/Stop button from the ignition lock.
- Insert the SmartKey into the ignition lock. The alarm is switched off.

► **To stop the alarm using KEYLESS-GO:**

grasp the outside door handle. The SmartKey must be outside the vehicle.

The alarm is switched off.

or

- Press the Start/Stop button on the dashboard. The SmartKey must be inside the vehicle. The alarm is switched off.

The alarm is not switched off, even if you close the open door that triggered it, for example.

i If the alarm stays on for more than 30 seconds, the mbrace emergency call system automatically sends a message to the Customer Assistance Center. This is done either by text message or data connection. The emergency call system sends the message or data provided that:

- you have subscribed to the mbrace service.
- the mbrace service has been activated properly.
- the necessary mobile phone network is available.

| | |
|---|-----|
| Useful information | 88 |
| SmartKey | 88 |
| Doors | 92 |
| Trunk | 94 |
| Side windows | 100 |
| Panorama roof with power tilt/ sliding panel | 101 |

Useful information

- i** This Operator's Manual describes all models and all standard and optional equipment of your vehicle available at the time of publication of the Operator's Manual. Country-specific differences are possible. Please note that your vehicle may not be equipped with all features described. This also applies to safety-related systems and functions.
- i** Read the information on qualified specialist workshops (▷ page 30).

SmartKey

Important safety notes

WARNING

If children are left unsupervised in the vehicle, they could:

- open the doors, thus endangering other people or road users.
- get out and disrupt traffic.
- operate the vehicle's equipment.

Additionally, children could set the vehicle in motion if, for example, they:

- release the parking brake.
- shifting the automatic transmission out of park position **P**
- Start the engine.

There is a risk of an accident and injury.

When leaving the vehicle, always take the SmartKey with you and lock the vehicle. Never leave children or animals unattended in the vehicle. Always keep the SmartKey out of reach of children.

WARNING

If you attach heavy or large objects to the SmartKey, the SmartKey could be unintentionally turned in the ignition lock. This could cause the engine to be switched off. There is a risk of an accident.

Do not attach any heavy or large objects to the SmartKey. Remove any bulky key rings before inserting the SmartKey into the ignition lock.

- !** Keep the SmartKey away from strong magnetic fields. Otherwise, the remote control function could be affected. Strong magnetic fields can occur in the vicinity of powerful electrical installations.

Do not keep the SmartKey:

- with electronic devices, e.g. a mobile phone or another SmartKey
- with metallic objects, e.g. coins or metal foil
- inside metallic objects, e.g. a metal case
This can affect the functionality of the SmartKey.

Do not keep the SmartKey in the temperature-controlled cup holder (▷ page 235). On vehicles with the KEYLESS-GO start function, do not keep it on the parcel shelf or in the trunk. Otherwise, the SmartKey may not be detected, e.g. when starting the engine using the Start/Stop button.



A check which periodically establishes a radio connection between the vehicle and the SmartKey determines whether a valid SmartKey is in the vehicle. This occurs, for example:

- when starting the engine
- whilst driving
- when using HANDS-FREE ACCESS
- when the external door handles are touched
- during convenience closing

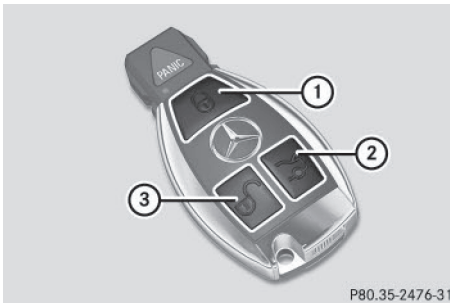
SmartKey functions



P80.35-2476-31

- ①  To lock the vehicle
- ②  To open/close the trunk lid
- ③  To unlock the vehicle

► **To unlock centrally:** press button ③.

If you do not open the vehicle within approximately 40 seconds of unlocking:

- the vehicle is locked again.
- the anti-theft alarm system is armed again.

► **To lock centrally:** press button ①.

The SmartKey centrally locks/unlocks:

- the doors
- the trunk lid
- the fuel filler flap

The turn signals flash once when unlocking and three times when locking.

i You can also set an audible signal to confirm that the vehicle has been locked. The audible signal can be activated and deactivated using COMAND (see the Digital Operating Instructions).

i When the surround lighting is activated in COMAND, it comes on when it is dark after the vehicle is unlocked using the remote control. Information on activating and deactivating the surround lighting can be found in the Digital Operator's Manual.

► **To open the trunk lid automatically from outside the vehicle:** press and hold button ② until the trunk lid opens.

KEYLESS-GO

General notes

Bear in mind that the engine can be started by any of the vehicle occupants if there is a SmartKey in the vehicle.

Locking/unlocking centrally

You can start, lock or unlock the vehicle using KEYLESS-GO. To do this, you only need carry the SmartKey with you. You can combine the functions of KEYLESS-GO with those of a conventional SmartKey. Unlock the vehicle by using KEYLESS-GO, for instance, and lock it using the  button on the SmartKey.

The driver's door and the door at which the handle is used, must both be closed. The SmartKey must be outside the vehicle. When locking or unlocking with KEYLESS-GO, the distance between the SmartKey and the corresponding door handle must not be greater than 3 ft (1 m).

A check which periodically establishes a radio connection between the vehicle and the SmartKey determines whether a valid SmartKey is in the vehicle. This occurs, for example:

- when starting the engine
- whilst driving
- when using HANDS-FREE ACCESS
- when the external door handles are touched
- during convenience closing

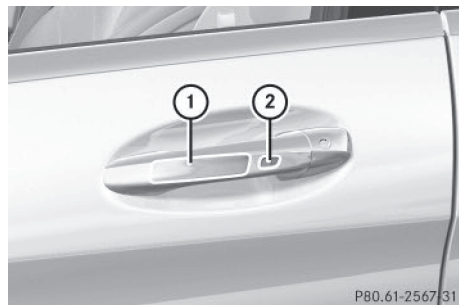

P80.61-2567-31

- ▶ **To unlock the vehicle:** touch the inner surface of the door handle.
- ▶ **To lock the vehicle:** touch sensor surface ① or ②.
Make sure that you do not touch the inner surface of the door handle.
- ▶ **Convenience closing feature:** touch recessed sensor surface ② for an extended period.
- ▶ **To unlock the trunk lid:** pull the handle on the trunk lid.

Deactivating

If you do not intend to use the vehicle for a longer period of time, you can deactivate KEYLESS-GO. The SmartKey will then use very little power, thereby conserving battery power. For the purposes of activation/deactivation, the vehicle must not be nearby.

- ▶ **To deactivate:** press the  button on the SmartKey twice in rapid succession. The battery check lamp of the SmartKey lights up twice briefly and KEYLESS-GO is deactivated.
- ▶ **To activate:** press any button on the SmartKey or insert the SmartKey into the ignition lock. KEYLESS-GO and all of its associated features are available again.

KEYLESS-GO start function

Bear in mind that the engine can be started by any of the vehicle occupants if there is a SmartKey in the vehicle.

Changing the settings of the locking system

You can find information about this in the Digital Operator's Manual.

Mechanical key

General notes

If the vehicle can no longer be locked or unlocked with the SmartKey or KEYLESS-GO, use the mechanical key.

If you use the mechanical key to unlock and open the driver's door, the anti-theft alarm system will be triggered. Switch off the alarm (▷ page 84).

If you unlock the vehicle using the mechanical key, the fuel filler flap will not be unlocked automatically.

- ▶ **To unlock the fuel filler flap:** insert the SmartKey into the ignition lock.

Removing the mechanical key



- ▶ Push release catch ① in the direction of the arrow and at the same time remove mechanical key ② from the SmartKey.

For further information about:

- unlocking the driver's door (▷ page 93)
- unlocking the trunk (▷ page 99)
- locking the vehicle (▷ page 93)

Inserting the mechanical key

- ▶ Push mechanical key ② completely into the SmartKey until it engages and release catch ① is back in its basic position.

SmartKey battery

Important safety notes

WARNING

Batteries contain toxic and corrosive substances. If batteries are swallowed, it can result in severe health problems. There is a risk of fatal injury.

Keep batteries out of the reach of children. If a battery is swallowed, seek medical attention immediately.

Environmental note



Batteries contain dangerous substances. It is against the law to dispose of them with the household rubbish. They must be collected separately and recycled to protect the environment.



Dispose of batteries in an environmentally friendly manner. Take discharged batteries to a qualified specialist workshop or a special collection point for used batteries.





The SmartKey batteries contain perchlorate material, which may require special handling and regard for the environment. National guidelines must be observed during disposal. In California, see www.dtsc.ca.gov/HazardousWaste/Perchlorate/index.cfm.

Mercedes-Benz recommends that you have the batteries replaced at a qualified specialist workshop.

Checking the battery



P80.35-2473-31

- ▶ Press the  or  button.
 - The battery is working properly if battery check lamp ① lights up briefly.
 - The battery is discharged if battery check lamp ① does not light up briefly.
- ▶ Change the battery (▷ page 91).
- i** If the SmartKey battery is checked within the signal reception range of the vehicle, pressing the  or  button:
 - locks or
 - unlocks the vehicle
- i** You can get a battery at any qualified specialist workshop.

Replacing the battery

You require a CR 2025 3 V cell battery.

- ▶ Take the mechanical key out of the SmartKey (▷ page 90).

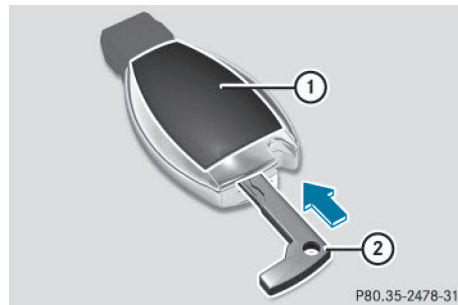

P80.35-2478-31

- ▶ Press mechanical key ② into the opening in the SmartKey in the direction of the arrow until battery compartment cover ①

opens. Do not hold battery compartment cover ① closed while doing so.

- ▶ Remove battery compartment cover ①.

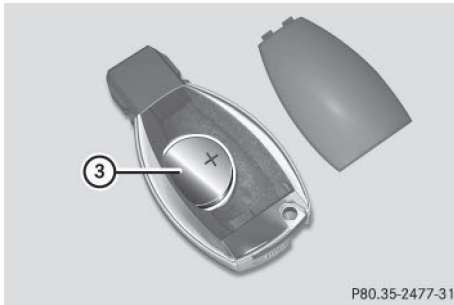

- ▶ Repeatedly tap the SmartKey against your palm until battery ③ falls out.
- ▶ Insert the new battery with the positive terminal facing upwards. Use a lint-free cloth to do so.
- ▶ Make sure that the surface of the battery is free of lint, grease and other contaminants.
- ▶ Insert the front tabs of battery compartment cover ① into the housing first and then press to close it.
- ▶ Insert mechanical key ② into the SmartKey.
- ▶ Check the function of all SmartKey buttons on the vehicle.

Problems with the SmartKey

You can find information about this in the Digital Operator's Manual.

Doors

Important safety notes

⚠ WARNING

If children are left unsupervised in the vehicle, they could:

- open the doors, thus endangering other people or road users.
- get out and disrupt traffic.
- operate the vehicle's equipment.

Additionally, children could set the vehicle in motion if, for example, they:

- release the parking brake.
- shifting the automatic transmission out of park position **P**
- Start the engine.

There is a risk of an accident and injury.

When leaving the vehicle, always take the SmartKey with you and lock the vehicle. Never leave children or animals unattended in the vehicle. Always keep the SmartKey out of reach of children.

You should preferably place luggage or loads in the trunk. Observe the loading guidelines (▷ page 232).

Information in the Digital Operator's Manual

In the Digital Operator's Manual you will find information on the following topics:

- Unlocking and opening doors from the inside
- Centrally locking and unlocking the vehicle from the inside
- Automatic locking feature
- Power closing

Unlocking the driver's door (mechanical key)

If the vehicle can no longer be locked or unlocked with the SmartKey or KEYLESS-GO, use the mechanical key.

- ▶ Take the mechanical key out of the SmartKey (▷ page 90).

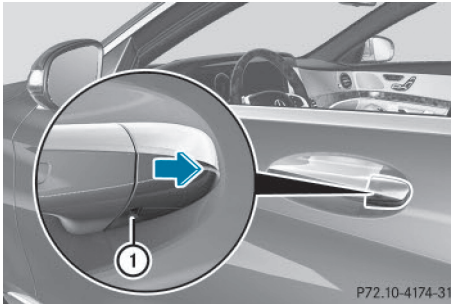

- ▶ Insert the mechanical key as far as it will go into opening ① in the protective cap.
- ▶ Pull and hold the door handle.
- ▶ Pull the protective cap on the mechanical key as straight as possible away from the vehicle until it releases.
- ▶ Release the door handle.

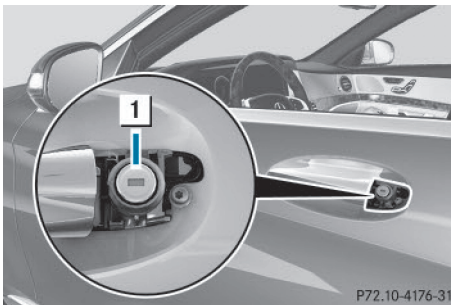

- ▶ Insert the mechanical key into the lock of the driver's door as far as it will go.
- ▶ Turn the mechanical key counter-clockwise as far as it will go to position ①. The locking knob pops up and the door unlocks.

- ▶ Turn the mechanical key back and remove it.
- ▶ Insert the mechanical key into the SmartKey (▷ page 90).
- ▶ Carefully press the protective cap onto the lock cylinder until it engages and is seated firmly. Do not pull the door handle when doing so.

If you use the mechanical key to unlock and open the driver's door, the anti-theft alarm system will be triggered. Switch off the alarm (▷ page 84).

Locking the vehicle (mechanical key)

If the vehicle can no longer be locked with the SmartKey or KEYLESS-GO, use the mechanical key.

- ▶ Open the driver's door.
- ▶ Close the front-passenger door, the rear doors and the trunk lid.
- ▶ Press the locking button (▷ page 92).
- ▶ Check whether the locking knobs on the front-passenger door and the rear doors are still visible. Press down the locking knobs by hand, if necessary.
- ▶ Close the driver's door.
- ▶ Take the mechanical key out of the SmartKey (▷ page 90).

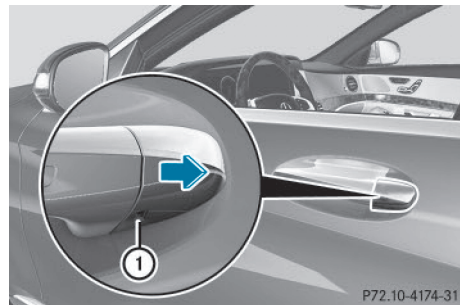

- ▶ Insert the mechanical key as far as it will go into opening ① in the protective cap.
- ▶ Pull and hold the door handle.

- ▶ Pull the protective cap on the mechanical key as straight as possible away from the vehicle until it releases.
- ▶ Release the door handle.

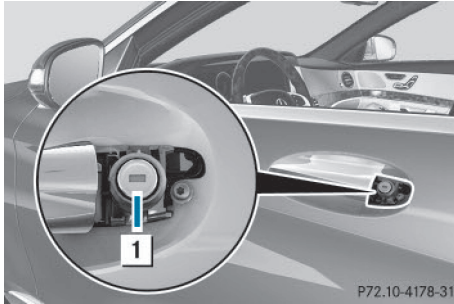

- ▶ Insert the mechanical key into the lock of the driver's door as far as it will go.
- ▶ Turn the mechanical key clockwise as far as it will go to position **1**. The locking knob drops down and the driver's door is locked.
- ▶ Turn the mechanical key back and remove it.
- ▶ Make sure that the doors and the trunk lid are locked.
- ▶ Insert the mechanical key into the SmartKey (> page 90).
- ▶ Carefully press the protective cap onto the lock cylinder until it engages and is seated firmly. Do not pull the door handle when doing so.

- i** If you lock the vehicle as described above, the fuel filler flap is not locked. The anti-theft alarm system is not armed.

Trunk

Important safety notes

⚠ WARNING

If objects, luggage or loads are not secured or not secured sufficiently, they could slip, tip over or be flung around and thereby hit vehicle occupants. There is a risk of injury, particu-

larly in the event of sudden braking or a sudden change in direction.

Always store objects so that they cannot be flung around. Secure objects, luggage or loads against slipping or tipping before the journey.

- !** The trunk lid swings upwards when opened. Therefore, make sure that there is sufficient clearance above the trunk lid.
- i** You can limit the opening angle of the trunk lid in COMAND; see the separate operating instructions.
- i** The opening dimensions of the trunk lid can be found in the "Vehicle data" section (> page 327).

Do not leave the SmartKey in the trunk. You could otherwise lock yourself out.

You should preferably place luggage or loads in the trunk. Observe the loading guidelines (> page 232).

Obstacle recognition with trunk lid reversing feature

On vehicles with trunk lid remote closing feature, the trunk lid is equipped with automatic obstacle recognition with reversing feature. If a solid object blocks or restricts the trunk lid when automatically opening or closing, this procedure is stopped. If the trunk lid is stopped during the closing procedure, it will open again automatically. The automatic obstacle recognition with reversing feature is only an aid. It is not a substitute for your attentiveness when opening and closing the trunk lid.

⚠ WARNING

The reversing feature does not react:

- to soft, light and thin objects, e.g. small fingers
- over the last 1/3 in (8 mm) of the closing movement

This means that the reversing feature cannot prevent someone being trapped in these situations. There is a risk of injury.

Make sure that no body parts are in close proximity during the closing procedure.

If somebody becomes trapped:

- press the  button on the SmartKey, or
- pull or press the remote operating switch on the driver's door or
- press the closing or locking button on the trunk lid, or
- pull on the trunk lid handle

Opening and closing manually

Opening

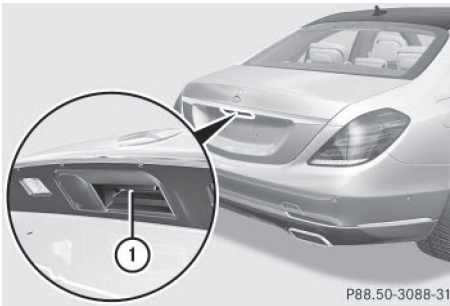

- ▶ Press the  button on the SmartKey. or
- ▶ Pull handle ①.
The trunk lid opens.

Closing

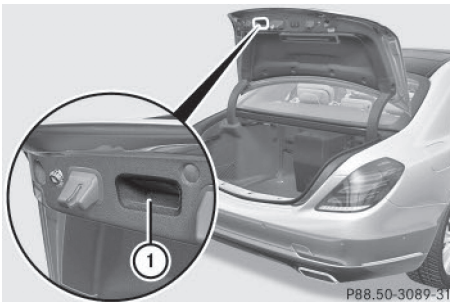

- ▶ Pull the trunk lid down using recess ①.

Vehicles with trunk lid remote closing feature or power closing:

- ▶ Lightly push the trunk lid closed.
The power closing function pulls the trunk lid closed.
- ▶ Lock the vehicle if necessary with the  button on the SmartKey or with KEYLESS-GO (▷ page 89).

- ⓘ If KEYLESS-GO detects a SmartKey in the trunk, the trunk lid cannot be locked. It then opens again.

Opening/closing automatically from outside

Important safety notes

WARNING

Parts of the body could become trapped during automatic closing of the trunk lid. Moreover, people, e.g. children, may be standing in the closing area or may enter the closing area during the closing process. There is a risk of injury.

Make sure that nobody is in the vicinity of the closing area during the closing process.

Use one of the following options to stop the closing process:

- press the  button on the SmartKey.
- pull or press the remote operating switch on the driver's door.
- press the closing or locking button on the trunk lid.
- pull the trunk lid handle.

WARNING

Combustion engines emit poisonous exhaust gases such as carbon monoxide. Exhaust gases can enter the vehicle interior if the trunk lid is open when the engine is running, especially if the vehicle is in motion. There is a risk of poisoning.

Always switch off the engine before opening the trunk lid. Never drive with the trunk lid open.

! The trunk lid swings upwards when opened. Therefore, make sure that there is sufficient clearance above the trunk lid.

i The opening dimensions of the trunk lid can be found in the "Vehicle data" section (> page 327).

Opening

You can open the trunk lid automatically using the SmartKey or the handle in the trunk lid.

- ▶ Press and hold the  button on the SmartKey until the trunk lid opens.
- or
- ▶ If the trunk lid is unlocked, pull the trunk lid handle and let it go again immediately.

Closing

You can close the trunk lid automatically using the SmartKey or the closing button in the trunk lid.

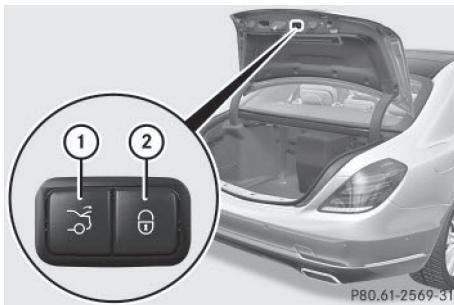

- ▶ Press and release closing button ① on the trunk lid.
- or
- ▶ If the SmartKey is located in the immediate vicinity of the vehicle: press the  button on the SmartKey. You can release the button as soon as the trunk lid starts to close.

▶ To stop the closing process:

- Press the  button on the SmartKey, or
- Pull the trunk lid handle, or
- Press closing button ① or locking button ② on the trunk lid, or
- Press the remote operating switch on the driver's door, or
- In vehicles with HANDS-FREE ACCESS: kick into the sensor detection range under the bumper with your foot.

i If the  button on the SmartKey is pressed or HANDS-FREE ACCESS is initiated after the closing process is stopped, the trunk lid opens.

Vehicles with trunk lid remote closing feature and KEYLESS-GO:

when all the doors are closed, you can simultaneously close the trunk lid and lock the vehicle. The key must be located to the rear of the vehicle.

- ▶ Press and release locking button ② on the trunk lid. If a KEYLESS-GO key is detected outside the vehicle, the trunk lid closes and the vehicle locks.

i If KEYLESS-GO detects a SmartKey in the trunk, the trunk lid opens again after it is closed. If KEYLESS-GO detects a second SmartKey outside the vehicle, the trunk lid remains closed.

HANDS-FREE ACCESS

Important safety notes

WARNING

The vehicle's exhaust system may be very hot. You could burn yourself by touching the exhaust system if you use HANDS-FREE ACCESS. There is a risk of injury. Always ensure that you only make the kicking movement within the detection range of sensors.

! If the SmartKey is within the rear detection range of KEYLESS-GO, the following situations, for example, could lead to the unintentional opening of the trunk:

- using a car wash
- using a power washer

Make sure that the SmartKey is at least 10 ft (3 m) away from the vehicle.

General notes

With KEYLESS-GO and HANDS-FREE ACCESS, you can open or close the trunk lid or stop the procedure without using your hands. This is useful if you have your hands full. To do this, make a kicking movement under the bumper with your foot.

Observe the following points:

- Carry your KEYLESS-GO key about your person. The KEYLESS-GO key must be in the rear detection range of the vehicle.
- When making the kicking movement, make sure that you are standing firmly on the ground and that there is sufficient clearance to the rear of the vehicle. You could otherwise lose your balance e.g. on ice.



P80.61-2583-31

- Always ensure that you only make the kicking movement within the detection range of sensors ①.
- Stand at least 12 in (30 cm) away from the rear area while doing so.
- Do not come into contact with the bumper while making the kicking movement. Otherwise, the sensors may not function correctly.

- HANDS-FREE ACCESS does not function when the engine is started.
- If a KEYLESS-GO key is within the rear detection range of KEYLESS-GO, HANDS-FREE ACCESS could be triggered. The trunk lid could thus be opened or closed unintentionally, for example, if you:
 - sit on the edge of the trunk.
 - set something down or lift something up behind the vehicle.
 - move the charging cable through the detection range of the sensors.
 - polish the rear of the vehicle.

Do not carry the KEYLESS-GO key about your person in these situations or in situations similar to these. This will prevent the unintentional opening/closing of the trunk.

- Dirt caused by road salt around sensors ① may restrict functionality.
- Using the HANDS-FREE ACCESS with a prosthetic leg may restrict functionality.

Operation

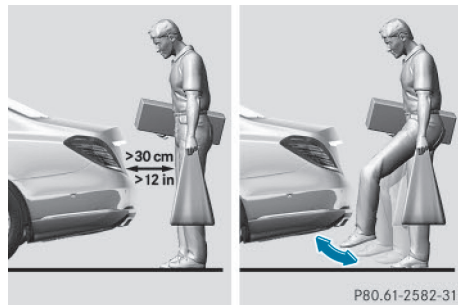

► **To open/close:** kick into sensor detection range ① under the bumper with your foot. You will hear a warning tone while the trunk lid is opening or closing.

► **If the trunk lid does not open after several attempts:** wait at least ten seconds then move your leg under the bumper once again.

i If you hold your foot under the bumper for too long, the trunk lid does not open or

close. Repeat the leg movement more quickly if this occurs.

To stop the opening or closing procedure:

- kick with your leg in the sensor detection range ① under the bumper or
- pull the handle on the outside of the trunk lid or
- press the closing button in the trunk lid or
- press the  button on the SmartKey

If the trunk lid closing procedure has been stopped:

- move your foot under the bumper again and the trunk lid will open.

If the trunk lid opening procedure has been stopped:

- move your foot under the bumper again and the trunk lid will close.

Opening/closing automatically from inside

Important safety notes

WARNING

Parts of the body could become trapped during automatic closing of the trunk lid. Moreover, people, e.g. children, may be standing in the closing area or may enter the closing area during the closing process. There is a risk of injury.

Make sure that nobody is in the vicinity of the closing area during the closing process.

Use one of the following options to stop the closing process:

- press the  button on the SmartKey.
- pull or press the remote operating switch on the driver's door.
- press the closing or locking button on the trunk lid.
- pull the trunk lid handle.

WARNING

Combustion engines emit poisonous exhaust gases such as carbon monoxide. Exhaust gases can enter the vehicle interior if the trunk lid is open when the engine is running, especially if the vehicle is in motion. There is a risk of poisoning.

Always switch off the engine before opening the trunk lid. Never drive with the trunk lid open.

- ❗ The trunk lid swings upwards when opened. Therefore, make sure that there is sufficient clearance above the trunk lid.

- i The opening dimensions of the trunk lid can be found in the "Vehicle data" section (▷ page 327).

Opening and closing

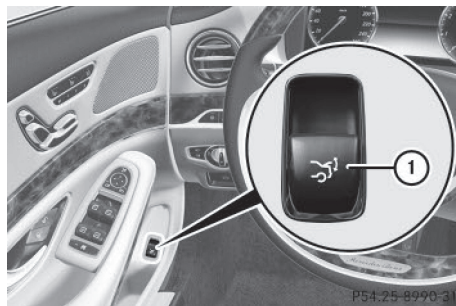

You can open and close the trunk lid from the driver's seat when the vehicle is stationary and unlocked.

- ▶ **To open:** pull remote operating switch for trunk lid ① until the trunk lid opens.
- ▶ **To close:** press remote operating switch for trunk lid ① until the trunk lid is completely closed.

Locking the trunk separately

You can lock the trunk separately. If you then unlock the vehicle centrally, the trunk remains locked and cannot be opened.

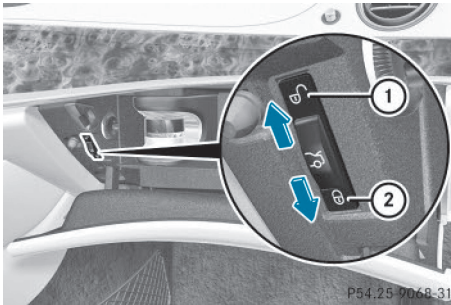

Activating the function to lock the trunk separately:

- ▶ Close the trunk lid.
- ▶ Open the glove box.
- ▶ Push the switch to position ②.
If the vehicle is unlocked centrally, the trunk remains locked.

i You can also lock the glove box
(▷ page 233).

Deactivating the function to lock the trunk separately:

- ▶ Open the glove box.
- ▶ Push the switch to position ①.
If the vehicle is unlocked centrally, the trunk will also be unlocked.

Unlocking the trunk (mechanical key)

! The trunk lid swings upwards when opened. Therefore, make sure that there is sufficient clearance above the trunk lid.

If the trunk lid can no longer be unlocked:

- using the SmartKey, or
- using HANDS-FREE ACCESS, or
- using the remote operating switch in the door control panel:

Use the emergency release.

If you use the mechanical key to unlock and open the trunk lid, the anti-theft alarm system will be triggered. Switch off the alarm (▷ page 84).

- ▶ Take the mechanical key out of the Smart-Key (▷ page 90).
- ▶ Insert the mechanical key into the trunk lid lock as far as it will go.

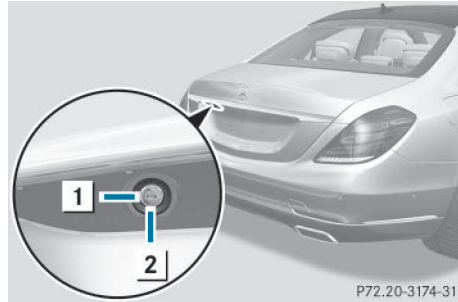

- ▶ Turn the mechanical key from position ① counter-clockwise as far as it will go to position ②.
The trunk is unlocked.
- ▶ Turn the mechanical key back to position ① and remove it.
- ▶ Insert the mechanical key into the Smart-Key.

Trunk emergency release

You can unlock the trunk lid from the inside with the emergency release button.

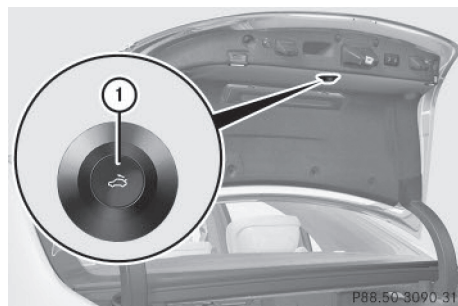

- ▶ Press emergency release button ① briefly.
The trunk lid unlocks and opens.

The trunk lid can be unlocked with the trunk lid emergency release when the vehicle is stationary or while driving.

The trunk lid emergency release does not unlock the trunk lid if the battery is disconnected or discharged.

Trunk lid emergency release light:

- emergency release button ① flashes for 30 minutes after the trunk lid is opened
- emergency release button ① flashes for 60 minutes after the trunk lid is closed

Side windows

Important safety notes

WARNING

While opening the side windows, body parts could become trapped between the side window and the door frame as the side window moves. There is a risk of injury.

Make sure that nobody touches the side window during the opening procedure. If somebody becomes trapped, release the switch or pull the switch to close the side window again.

WARNING

While closing the side windows, body parts in the closing area could become trapped. There is a risk of injury.

When closing make sure that no parts of the body are in the closing area. If somebody becomes trapped, release the switch or press the switch to open the side window again.

WARNING

If children operate the side windows they could become trapped, particularly if they are left unsupervised. There is a risk of injury.

Activate the override feature for the rear side windows. When leaving the vehicle, always take the SmartKey with you and lock the vehicle. Never leave children unsupervised in the vehicle.

Side window reversing feature

The side windows are equipped with an automatic reversing feature. If a solid object blocks or restricts a side window from traveling upwards during automatic operation, the side window opens again automatically. During the manual closing process, the side window only opens again automatically after the corresponding switch is released. The automatic reversing feature is only an aid and is no substitute for your attention when closing a side window.

WARNING

The reversing feature does not react:

- to soft, light and thin objects, e.g. small fingers
- while resetting

This means that the reversing feature cannot prevent someone being trapped in these situations. There is a risk of injury.

Make sure that no body parts are in close proximity during the closing procedure. If someone becomes trapped, press the switch to open the side window again.

Information in the Digital Operator's Manual

In the Digital Operator's Manual you will find information on the following topics:

- Opening and closing the side windows
- Convenience opening
- Convenience closing feature
- Resetting the side windows

Problems with the side windows **WARNING**

If you close a side window again immediately after it has been blocked or reset, the side window closes with increased or maximum force. The reversing feature is then not active. Parts of the body could be trapped in the closing area in the process. This poses an increased risk of injury or even fatal injury.

Make sure that no parts of the body are in the closing area. To stop the closing process, release the switch or push the switch again to reopen the side window.

| Problem | Possible causes/consequences and ► Solutions |
|---|--|
| A side window cannot be closed because it is blocked by objects, e.g. leaves in the window guide. | <ul style="list-style-type: none"> ► Remove the objects. ► Close the side window. |
| A side window cannot be closed and you cannot see the cause. | <p>If a side window is obstructed during closing and reopens again slightly:</p> <ul style="list-style-type: none"> ► Immediately after the window blocks, pull the corresponding switch again until the side window has closed. The side window is closed with increased force. <p>If a side window is obstructed again during closing and reopens again slightly:</p> <ul style="list-style-type: none"> ► Immediately after the window blocks, pull the corresponding switch again until the side window has closed. The side window is closed without the anti-entrapment feature. |

Panorama roof with power tilt/sliding panel**Important safety notes**

In the following section, the term "sliding sunroof" refers to the panorama roof with power tilt/sliding panel.

 **WARNING**

While opening and closing the sliding sunroof, body parts in close proximity could become trapped. There is a risk of injury.

Make sure that no body parts are in close proximity during the opening and closing procedures.

If somebody becomes trapped:

- release the switch immediately, or
- during automatic operation, push the switch briefly in any direction

The opening or closing procedure will be stopped.

 **WARNING**

If children operate the sliding sunroof they could become trapped, particularly if they are left unsupervised. There is a risk of injury.

When leaving the vehicle, always take the SmartKey with you and lock the vehicle. Never leave children unsupervised in the vehicle.

⚠ WARNING

At high speeds the raised sliding sunroof automatically lowers slightly at the rear. This could trap you or other persons. There is a risk of injury. Make sure that nobody reaches into the sweep of the sliding sunroof whilst the vehicle is in motion.

If somebody becomes trapped, immediately push the sliding sunroof switch up or pull it back. The sliding sunroof raises at the rear.

! Only open the sliding sunroof if it is free of snow and ice. Otherwise, malfunctions may occur.

Do not allow anything to protrude from the sliding sunroof. Otherwise, the seals could be damaged.

! The weather can change abruptly. It could start to rain or snow. Make sure that the sliding sunroof is closed when you leave the vehicle. The vehicle electronics can be damaged if water enters the vehicle interior.

! When the sliding sunroof is open, water can get into the vehicle and cause damage. The vehicle electronics can be damaged if water enters the vehicle interior. Only clean the sliding sunroof when it is closed.

i Resonance noises can occur in addition to the usual airflow noises when the sliding sunroof is open. They are caused by minor pressure fluctuations in the vehicle interior. Change the position of the sliding sunroof or open a side window slightly to reduce or eliminate these noises.

Sliding sunroof reversing feature

The sliding sunroof is equipped with an automatic reversing feature. If a solid object blocks or restricts the sliding sunroof during the closing process, the sliding sunroof opens again automatically. The automatic reversing feature is only an aid and is no substitute for your attention when closing the sliding roof.

⚠ WARNING

The reversing feature does not react:

- to soft, light and thin objects, e.g. small fingers
- over the last 1/6 in (4 mm) of the closing movement
- during resetting
- when closing the sliding sunroof again manually immediately after automatic reversing

This means that the reversing feature cannot prevent someone being trapped in these situations. There is a risk of injury.

Make sure that no body parts are in close proximity during the closing procedure.

If somebody becomes trapped:

- release the switch immediately, or
- during automatic operation, push the switch briefly in any direction

The closing process is stopped.

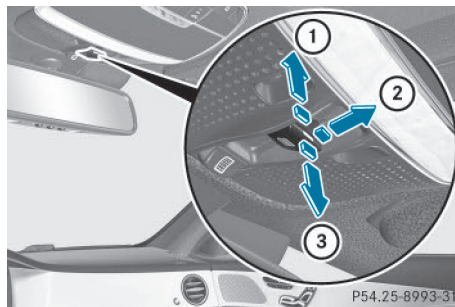
Operating the sliding sunroof**Opening and closing**

- ① To raise
- ② To open
- ③ To close/lower

► Turn the SmartKey to position 1 or 2 in the ignition lock (▷ page 133).

► Press or pull the  switch in the corresponding direction.

i If you press or pull the  switch beyond the point of resistance, automatic

operation is started in the corresponding direction. You can stop automatic operation by pressing or pulling again.

- i** If the sliding sunroof is raised at the rear, it lowers slightly automatically at higher speeds. The noise level in the vehicle interior is reduced as a result.

At low speeds it raises again automatically.

You can also temporarily deactivate automatic lowering. To do so, press the  switch. The sliding sunroof raises again automatically.

- i** You can continue to operate the sliding sunroof after switching off the engine or removing the SmartKey from the ignition lock. This function remains active for five minutes or until you open a front door.

- i** The sliding sunroof cannot be opened if a roof carrier is installed. In order to allow ventilation of the vehicle interior, you can raise the sliding sunroof.

If contact is made with a roof carrier approved by Mercedes-Benz, the sliding sunroof lowers slightly but remains raised at the rear .

- i** Before opening, raising or closing the sliding sunroof, a check is carried out to see whether a valid SmartKey is in the vehicle, if:

- the  switch is pressed or pulled and
- the Start/Stop button is used instead of the SmartKey in the ignition lock and
- the engine is not running

This is carried out by means of a brief radio connection between the vehicle and the SmartKey.

Rain-closing feature

The raised sliding sunroof automatically lowers at the rear when driving if it starts to rain. The sliding sunroof is lowered depending on:

- the road speed and
- the intensity of the rain.

You can manually cancel the automatic closing procedure. Press or pull the  switch in any direction.

To raise the sliding sunroof again, press the  switch in direction ①. The rain-closing feature remains activated.

Operating the roller sunblinds for the sliding sunroof

Important safety notes

WARNING

When opening or closing the roller sunblind, parts of the body could be trapped between the roller sunblind and the frame or sliding sunroof. There is a risk of injury.

When opening or closing make sure that no parts of the body are in the sweep of the roller sunblind.

If somebody becomes trapped:

- release the switch immediately, or
- during automatic operation, push the switch briefly in any direction

The opening or closing procedure will be stopped.

The roller sunblinds shield the vehicle interior from sunlight. The front roller sunblind can only be opened and closed when the sliding sunroof is closed.

Roller sunblind reversing feature

The roller sunblinds are equipped with an automatic reversing feature. If a solid object blocks or restricts a roller sunblind during the closing process, the roller sunblind opens again automatically. The automatic reversing

feature is only an aid and is not a substitute for your attention when closing the roller sunblinds.

WARNING

The reversing feature especially does not react to soft, light and thin objects such as small fingers. This means that the reversing feature cannot prevent someone being trapped in these situations. There is a risk of injury.

When closing make sure that no parts of the body are in the sweep of the roller sunblind.

If somebody becomes trapped:

- release the switch immediately, or
- during automatic operation, push the switch briefly in any direction

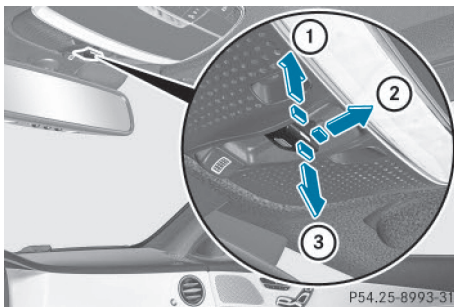

The closing process is stopped.

Opening and closing the front roller sunblind



- ① Opens
- ② Opens
- ③ Closes

i The front roller sunblind can only be closed when the sliding sunroof is closed.

- ▶ Turn the SmartKey to position **1** or **2** in the ignition lock (▷ page 133).
- ▶ Press the  switch in direction **①**.
The front roller sunblind opens, then the sliding roof is raised.
- ▶ Pull the  switch in direction **②**.

The front roller sunblind opens.

- ▶ Pull the  switch in direction **③**.

The front roller sunblind closes if the sliding sunroof is closed.

- i** If you press or pull the  switch beyond the point of resistance, automatic operation is started in the corresponding direction. You can stop automatic operation by pressing or pulling again.

Opening and closing the rear roller sunblind

Operating from the front

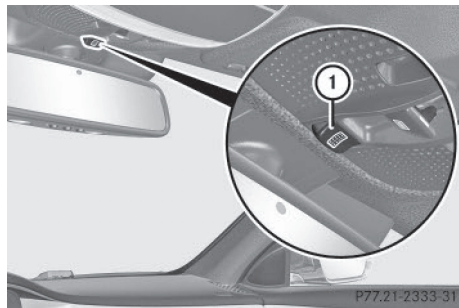

Vehicles without MAGIC SKY CONTROL: you can operate the rear roller sunblind from the front.

- ▶ **To open or close:** press button **①**.
The rear roller sunblind opens or closes fully.
- ▶ **To stop:** press button **①** again.
- i** You must first open or close the rear roller sunblind fully before you can move it in the other direction.

Operating from the rear compartment

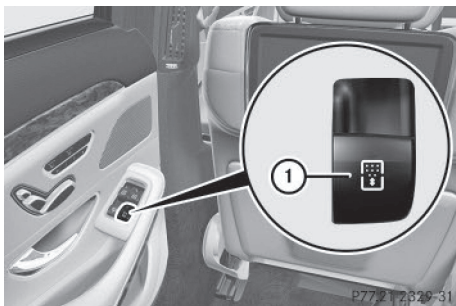

- ▶ **To open/close manually:** press or pull switch ① to the point of resistance and hold it until the rear roller sunblind has reached the desired position.
- ▶ **To open/close fully:** press or pull switch ① beyond the point of resistance and release it.
- ❗ If you press switch ① again when the rear roller sunblind is fully opened, the degree of transparency of the rear MAGIC SKY CONTROL element changes. If you pull switch ① again when the rear roller sunblind is fully closed, the degree of transparency changes only when the roller sunblind is opened (> page 105).
- ❗ If the rear roller sunblind closes when the rear MAGIC SKY CONTROL element is not tinted, this tints automatically.

MAGIC SKY CONTROL

General notes

MAGIC SKY CONTROL is a glass roof, the transparency of which can be changed by applying electrical voltage.

MAGIC SKY CONTROL can be switched between darkened and transparent states.

- ❗ MAGIC SKY CONTROL darkens automatically after a short period when you turn the SmartKey to position 0 or remove it.

Risk of electric shock

⚠ DANGER

MAGIC SKY CONTROL operates using high voltage. If the headliner is damaged or removed, electrical components will be exposed. If you touch these components, you could get an electric shock. There is a risk of fatal injury.

- Never remove the headliner.
- If the headliner is damaged, never touch the electrical components behind it.
- Always have work on the MAGIC SKY CONTROL carried out at a qualified specialist workshop.

The high-voltage components of MAGIC SKY CONTROL are protected behind the headliner.

These are in the hidden portion of the movable roof element of the panorama roof with power tilt/sliding panel and above the left rear door.

The MAGIC SKY CONTROL voltage transformer is stamped with a high-voltage symbol, warning you about the high voltage. The electric cables of the high-voltage section are color orange.

Operating MAGIC SKY CONTROL from the front

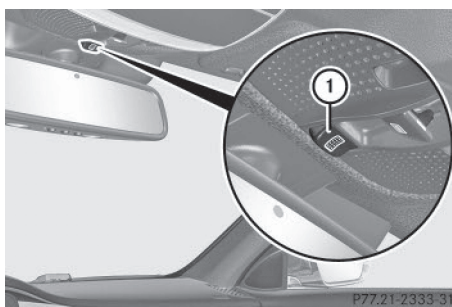

- ▶ Turn the SmartKey to position **1** or **2** in the ignition lock (▷ page 133).
MAGIC SKY CONTROL switches to the status it was set to before the engine was switched off.
- ▶ **To change the degree of transparency:** press button ①.

If the rear MAGIC SKY CONTROL element is in a different state than the front element, the degree of transparency will change only in the front element. Both elements will then be in the same state and any further changes will again occur synchronously.

- ❗ At sub-zero temperatures, the change is slower and uneven. The entire process may take some time.

Operating the rear MAGIC SKY CONTROL element from the rear

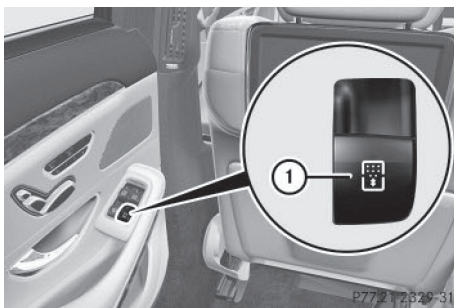



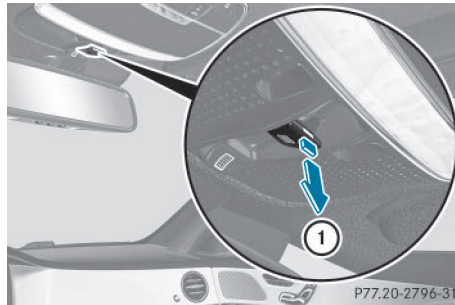

- ▶ **To change the degree of transparency of the fully opened roller sunblind:** press switch ①.
- ▶ **To change the degree of transparency of the fully closed roller sunblind:** pull switch ①.
The degree of transparency will change only after the roller sunblind is opened.
- ❗ If the rear roller sunblind closes when the rear MAGIC SKY CONTROL element is not tinted, this tints automatically.

Resetting the sliding sunroof and the roller sunblind

Resetting the sliding sunroof or the front roller sunblinds



Reset the sliding sunroof or the front roller sunblind if the sliding sunroof or the front roller sunblind does not move smoothly.

- ▶ Turn the SmartKey to position **1** or **2** in the ignition lock (▷ page 133).
- ▶ Pull the  switch repeatedly to the point of resistance in the direction of arrow ① until the sliding sunroof is fully closed.
- ▶ Keep the  switch pulled for an additional second.
- ▶ Pull the  switch in the direction of arrow ① repeatedly until the front roller sunblind is closed.
- ▶ Keep the  switch pulled for an additional second.
- ▶ Make sure that the sliding sunroof (▷ page 102) and the front roller sunblind (▷ page 104) can be fully opened again.
- ▶ If this is not the case, repeat the steps above again.

Resetting the rear sunblind

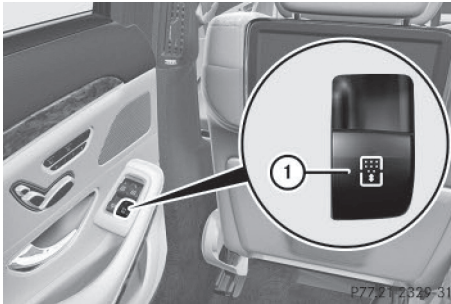

- ▶ Turn the SmartKey to position **1** or **2** in the ignition lock (▷ page 133).
- ▶ Pull switch ① repeatedly until the rear roller sunblind is fully closed.
- ▶ Keep switch ① pulled for an additional second.
- ▶ Make sure that the rear roller sunblind can be opened fully again (▷ page 104).
- ▶ If this is not the case, repeat the steps above again.

Problems with the sliding sunroof**⚠ WARNING**

If you close the sliding sunroof again immediately after it has been blocked or reset, the sliding sunroof closes with increased or maximum force. The reversing feature is then not active. Parts of the body could be trapped in the closing area in the process. This poses an increased risk of injury or even fatal injury.



Make sure that no parts of the body are in the closing area.

If somebody becomes trapped:

- release the switch immediately, or
- during automatic operation, push the switch briefly in any direction

The closing process is stopped.

! If the sliding sunroof still cannot be opened or closed as a result of a malfunction, contact a qualified specialist workshop.

| Problem | Possible causes/consequences and ► Solutions |
|--|--|
| The sliding sunroof cannot be closed and you cannot see the cause. | <p>If the sliding sunroof is obstructed during closing and reopens again slightly:</p> <ul style="list-style-type: none"> ► Immediately after it blocks, pull the  switch down again to the point of resistance until the sliding sunroof is closed. The sliding sunroof is closed with increased force. <p>If the sliding sunroof is obstructed again during closing and then reopens slightly:</p> <ul style="list-style-type: none"> ► Immediately after it blocks, pull the  switch down again to the point of resistance until the sliding sunroof is closed. The sliding sunroof is closed without the anti-entrapment feature. |

| | |
|--------------------------------------|-----|
| Useful information | 110 |
| Correct driver's seat position | 110 |
| Seats | 111 |
| Steering wheel | 113 |
| Mirrors | 113 |
| Memory function | 113 |

Useful information

- i** This Operator's Manual describes all models and all standard and optional equipment of your vehicle available at the time of publication of the Operator's Manual. Country-specific differences are possible. Please note that your vehicle may not be equipped with all features described. This also applies to safety-related systems and functions.
- i** Read the information on qualified specialist workshops (▷ page 30).

Correct driver's seat position

⚠ WARNING

You could lose control of your vehicle if you do the following while driving:

- adjust the driver's seat, head restraint, steering wheel or mirrors
- fasten the seat belt

There is a risk of an accident.

Adjust the driver's seat, head restraint, steering wheel and mirror and fasten your seat belt before starting the engine.



- ▶ Observe the safety guidelines on seat adjustment (▷ page 111).
- ▶ Check whether you have adjusted seat ③ properly (▷ page 112).

When adjusting the seat, make sure that:

- you are as far away from the driver's air bag as possible
 - you are sitting in a normal upright position
 - you can fasten the seat belt properly
 - you have moved the backrest to an almost vertical position
 - you have set the seat cushion angle so that your thighs are gently supported
 - you can depress the pedals properly
- ▶ Check whether the head restraint is adjusted properly.

When doing so, make sure that you have adjusted the head restraint so that the back of your head is supported at eye level by the center of the head restraint.

- ▶ Observe the safety guidelines on steering wheel adjustment (▷ page 113).
- ▶ Make sure that steering wheel ① is adjusted properly (▷ page 113).

When adjusting the steering wheel, make sure that:

- you can hold the steering wheel with your arms slightly bent
 - you can move your legs freely
 - you can see all the displays in the instrument cluster clearly
- ▶ Observe the safety guidelines for seat belts (▷ page 49).
- ▶ Check whether you have fastened seat belt ② properly (▷ page 52).

The seat belt should:

- fit snugly across your body
- be routed across the middle of your shoulder
- be routed in your pelvic area across the hip joints

- ▶ Before starting off, adjust the rear-view mirror and the exterior mirrors in such a way that you have a good view of road and traffic conditions (> page 113).
- ▶ **Vehicles with a memory function:** save the seat, steering wheel and exterior mirror settings with the memory function (> page 113).

Seats

Important safety notes

WARNING

Children could become trapped if they adjust the seats, particularly when unattended. There is a risk of injury.

When leaving the vehicle, always take the SmartKey with you and lock the vehicle. Never leave children unsupervised in the vehicle.

The seats can still be adjusted when there is no SmartKey in the ignition lock.

WARNING

You could lose control of your vehicle if you do the following while driving:

- adjust the driver's seat, head restraint, steering wheel or mirrors
- fasten the seat belt

There is a risk of an accident.

Adjust the driver's seat, head restraint, steering wheel and mirror and fasten your seat belt before starting the engine.

WARNING

If you adjust the seat height carelessly, you or other vehicle occupants could be trapped and thereby injured. Children in particular could accidentally press the electrical seat adjustment buttons and become trapped. There is a risk of injury.

While moving the seats, make sure that your hands or other body parts do not get under the lever assembly of the seat adjustment system.

WARNING

When you adjust a seat, you or other vehicle occupants could become trapped, e.g. on the seat guide rail. There is a risk of injury.

Make sure when adjusting a seat that no one has any body parts in the sweep of the seat.

WARNING

If head restraints are not installed and adjusted correctly, they cannot provide protection as intended. There is an increased risk of injury in the head and neck area, e.g. in the event of an accident or when braking.

Always drive with the head restraints installed. Before driving off, make sure for every vehicle occupant that the center of the head restraint supports the back of the head at about eye level.

WARNING

The seat belt does not offer the intended level of protection if you have not moved the backrest to an almost vertical position. When braking or in the event of an accident, you could slide underneath the seat belt and sustain abdomen or neck injuries, for example. This poses an increased risk of injury or even fatal injury.

Adjust the seat properly before beginning your journey. Always ensure that the backrest is in an almost vertical position and that the shoulder section of your seat belt is routed across the center of your shoulder.

 To avoid damage to the seats and the seat heating, observe the following information:

- keep liquids from spilling on the seats. If liquid is spilled on the seats, dry them as soon as possible.
- if the seat covers are damp or wet, do not switch on the seat heating. The seat heating should also not be used to dry the seats.
- clean the seat covers as recommended; see the "Interior care" section.

- do not transport heavy loads on the seats. Do not place sharp objects on the seat cushions, e.g. knives, nails or tools. The seats should only be occupied by passengers, if possible.
- when the seat heating is in operation, do not cover the seats with insulating materials, e.g. blankets, coats, bags, seat covers, child seats or booster seats.

! Make sure that there are no objects in the footwell under or behind the seats when moving the seats back. There is a risk that the seats and/or the objects could be damaged.

Information in the Digital Operator's Manual

In the Digital Operator's Manual you will find information on the following topics:

- Adjusting the seats
- Adjusting the rear seat
- Chauffeur mode
- Adjusting the head restraints
- Adjusting the multicontour seat
- Adjusting the active multicontour seat
- Adjusting the 4-way lumbar support
- Switching the seat ventilation on/off

Switching the seat heating on/off

Switching on/off

WARNING

Repeatedly switching on the seat heating can cause the seat cushion and backrest pads to become very hot. The health of persons with limited temperature sensitivity or a limited ability to react to excessively high temperatures may be affected or they may even suffer burn-like injuries. There is a risk of injury.

Therefore, do not switch the seat heating on repeatedly.

The three red indicator lamps in the button indicate the heating level you have selected. The system automatically switches down from level **3** to level **2** after approximately eight minutes.

The system automatically switches down from level **2** to level **1** after approximately ten minutes.

The system automatically switches off approximately 20 minutes after it is set to level **1**.

Vehicles with the Seat Heating Plus package: you can set the distribution of the heated sections of the seat cushion and backrest via COMAND (see the Digital Operator's Manual).

Front seats

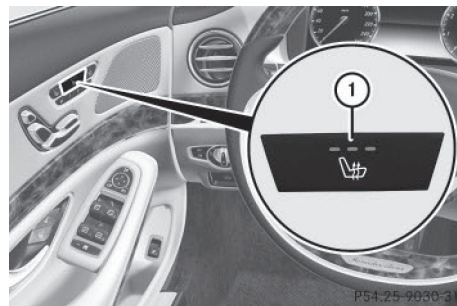

► Turn the SmartKey to position **1** or **2** in the ignition lock (► page 133).

► **To switch on:** press button **1** repeatedly until the desired heating level is set.

► **To switch off:** press button **1** repeatedly until all the indicator lamps go out.

i If the battery voltage is too low, the seat heating may switch off.

Rear seats

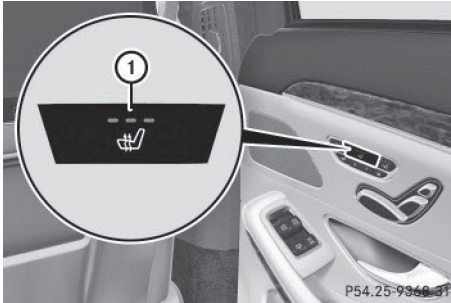

- ▶ Turn the SmartKey to position **1** or **2** in the ignition lock (▷ page 133).
 - ▶ **To switch on:** press button ① repeatedly until the desired heating level is set.
 - ▶ **To switch off:** press button ① repeatedly until all the indicator lamps go out.
- i** If the battery voltage is too low, the seat heating may switch off.

Problems with the seat heating

You can find information about this in the Digital Operator's Manual.

Steering wheel

Important safety notes

WARNING

You could lose control of your vehicle if you do the following while driving:

- adjust the driver's seat, head restraint, steering wheel or mirrors
- fasten the seat belt

There is a risk of an accident.

Adjust the driver's seat, head restraint, steering wheel and mirror and fasten your seat belt before starting the engine.

WARNING

Children could injure themselves if they adjust the steering wheel. There is a risk of injury.

When leaving the vehicle, always take the SmartKey with you and lock the vehicle. Never leave children unsupervised in the vehicle.

The electrically adjustable steering wheel can still be adjusted when there is no SmartKey in the ignition lock.

Information in the Digital Operator's Manual

In the Digital Operator's Manual you will find information on the following topics:

- Adjusting the steering wheel
- Steering wheel heating
- EASY-ENTRY/EXIT feature

Mirrors

In the Digital Operator's Manual you will find information on the following topics:

- Rear-view mirror
- Exterior mirrors
- Automatic anti-glare mirrors
- Parking position for the exterior mirror on the front-passenger side

Memory function

In the Digital Operator's Manual you will find information on the following topics:

- Storing settings
- Calling up a stored setting

| | |
|--------------------------|-----|
| Useful information | 116 |
| Exterior lighting | 116 |
| Interior lighting | 119 |
| Replacing bulbs | 119 |
| Windshield wipers | 120 |

Useful information

- i** This Operator's Manual describes all models and all standard and optional equipment of your vehicle available at the time of publication of the Operator's Manual. Country-specific differences are possible. Please note that your vehicle may not be equipped with all features described. This also applies to safety-related systems and functions.
- i** Read the information on qualified specialist workshops (▷ page 30).

Exterior lighting

General notes

For reasons of safety, Mercedes-Benz recommends that you drive with the lights switched on even during the daytime. In some countries, operation of the headlamps varies due to legal requirements and self-imposed obligations.

Driving abroad

Symmetrical low-beam headlamps

Switch the headlamps to symmetrical low beam in countries in which traffic drives on the opposite side of the road from the country where the vehicle is registered. This prevents glare to oncoming traffic. When using symmetrical lights, the edge of the road is not lit as widely and as far ahead as normal.

Have the headlamps converted at a qualified specialist workshop as close to the border as possible before driving in these countries.

Asymmetrical low beam

Have the headlamps converted back to asymmetrical low-beam headlamps at a qualified specialist workshop as soon as possible after crossing the border again.

Information in the Digital Operator's Manual

In the Digital Operator's Manual you will find information on the following topics:

- Hazard warning lamps
- Headlamps fogged up on the inside

Setting the exterior lighting

Setting options

Exterior lighting can be set using:

- the light switch
- the combination switch (▷ page 117)

Light switch

Operation

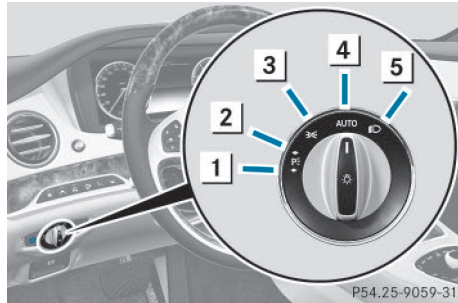

- 1** Left-hand standing lamps
- 2** Right-hand standing lamps
- 3** Parking lamps, license plate and instrument cluster lighting
- 4** **AUTO** Automatic headlamp mode, controlled by the light sensor
- 5** Low-beam/high-beam headlamps

If you hear a warning tone when you leave the vehicle, the lights may still be switched on.

- Turn the light switch to **AUTO**.

The exterior lighting (except the parking/standing lamps) switches off automatically if you:

- remove the SmartKey from the ignition lock
- open the driver's door with the SmartKey in position 0

Information in the Digital Operator's Manual

In the Digital Operator's Manual you will find information on the following topics:

- Automatic headlamp mode
- Low-beam headlamps
- Parking lamps
- Standing lamps

Combination switch

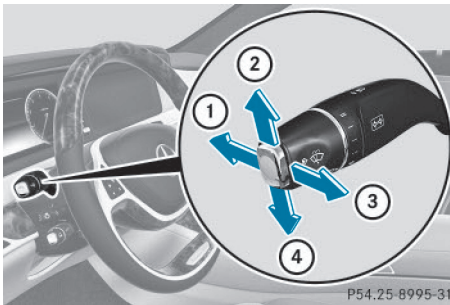

- ① High-beam headlamps
- ② Turn signal, right
- ③ High-beam flasher
- ④ Turn signal, left

In the Digital Operator's Manual you will find information on the following topics:

- Turn signal
- High-beam headlamps
- High-beam flasher

Cornering light function



The cornering light function improves the illumination of the road over a wide angle in the direction you are turning, enabling better visibility in tight bends, for example. It can only be activated when the low-beam headlamps are switched on.

Active:

- if you are driving at speeds below 25 mph (40 km/h) and switch on the turn signal or turn the steering wheel
- if you are driving at speeds between 25 mph (40 km/h) and 45 mph (70 km/h) and turn the steering wheel

The cornering lamp may remain lit for a short time, but is automatically switched off after no more than three minutes.

Adaptive Highbeam Assist Plus

General notes

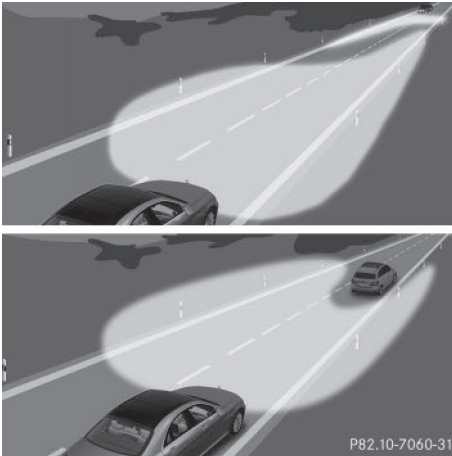

With Adaptive Highbeam Assist Plus, you can automatically switch between low-beam, partial high-beam and high-beam headlamps.

Partial high-beam is a form of illumination whereby the high-beam is directed past other road users. Other road users are kept out of the high-beam. This prevents glare. When there is a vehicle in front, for example, the high-beam headlamps illuminate the areas to its right and left, and the vehicle in front is illuminated by the low-beam headlamps.

The system automatically adapts the low-beam headlamp range depending on the distance to the other vehicle. Once the system no longer detects any other vehicles, it reactivates the high-beam headlamps.

If the high-beam or partial high-beam are causing too much reflection from traffic signs, the lights are automatically dimmed and glare for the driver caused by the reflections is thus avoided.

The system's optical sensor is located behind the windshield near the overhead control panel.

Important safety notes

WARNING

Adaptive Highbeam Assist Plus does not recognize road users:

- who have no lights, e.g. pedestrians
- who have poor lighting, e.g. cyclists
- whose lighting is blocked, e.g. by a barrier

In very rare cases, Adaptive Highbeam Assist Plus may not recognize road users who do have lights, or may recognize them too late. In this or similar situations, the automatic high-beam headlamps will not be deactivated or will be activated regardless. There is a risk of an accident.

Always carefully observe the traffic conditions and switch off the high-beam headlamps in good time.

Adaptive Highbeam Assist Plus cannot take into account road, weather or traffic conditions. Adaptive Highbeam Assist Plus is only an aid. You are responsible for adjusting the vehicle's lighting to the prevailing light, visibility and traffic conditions.

In particular, the detection of obstacles can be restricted if there is:

- poor visibility, e.g. due to fog, heavy rain or snow
- dirt on the sensors or the sensors are obscured

Switching Adaptive Highbeam Assist PLUS on/off

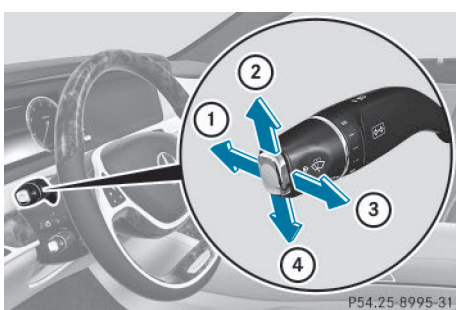

- ① High-beam headlamps
- ② Turn signal, right
- ③ High-beam flasher
- ④ Turn signal, left

▶ **To switch on:** turn the light switch to **AUTO**.

▶ Press the combination switch beyond the pressure point in the direction of arrow ①. The  indicator lamp in the multifunction display lights up if it is dark and the light sensor activates the low-beam headlamps.

If you are driving at speeds above approximately 16 mph (25 km/h):

The headlamp range is set automatically depending on the distance between the vehicle and other road users.

If you are driving at speeds above approximately 19 mph (30 km/h) and no other road users have been detected:

The high-beam headlamps are switched on automatically. The  indicator lamp in the instrument cluster also lights up.

If you are driving at speeds above approximately 28 mph (45 km/h) and other road users have been detected:



Partial high-beam is selected automatically. The  indicator lamp in the instrument cluster also lights up.

If you are driving at speeds below approximately 25 mph (40 km/h):

The partial high-beam headlamps are switched off automatically. If no other road

users are recognized, the high-beam headlamps are switched on.

If you are driving at speeds below approximately 16 mph (25 km/h) or the roads are adequately illuminated:

The high-beam headlamps are switched off automatically. The  indicator lamp in the instrument cluster goes out. The  indicator lamp in the multifunction display remains lit.

▶ **To switch off:** move the combination switch back to its normal position or move the light switch to another position. The  indicator lamp in the multifunction display goes out.

Interior lighting

An overview of the interior lighting and the overhead control panel can be found in the "At a glance" section.

In the Digital Operator's Manual you will find information on the following topics:

- Automatic interior lighting control
- Manual interior lighting control
- Crash-responsive emergency lighting

Replacing bulbs

The front and rear light clusters of your vehicle are equipped with LED light bulbs. Do not replace the bulbs yourself. Contact a qualified specialist workshop which has the necessary specialist knowledge and tools to carry out the work required.

Lamps are an important aspect of vehicle safety. You must therefore make sure that these function correctly at all times. Have the headlamp setting checked regularly.

Windshield wipers

Switching the windshield wipers on/off

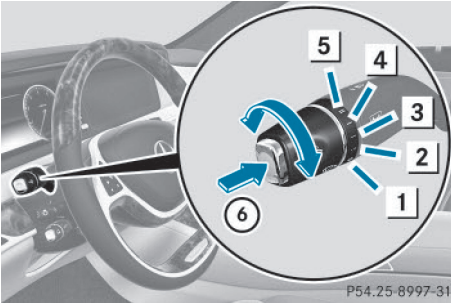

- 1 Windshield wiper off
- 2 Intermittent wipe, low (rain sensor set to low sensitivity)
- 3 Intermittent wipe, high (rain sensor set to high sensitivity)
- 4 Continuous wipe, slow
- 5 Continuous wipe, fast
- 6 Single wipe / to wipe the windshield using washer fluid

If the wiper blades are worn, the windshield will no longer be wiped properly. This could prevent you from observing the traffic conditions.

Replacing the wiper blades

Important safety notes

WARNING

If the windshield wipers begin to move while you are changing the wiper blades, you could be trapped by the wiper arm. There is a risk of injury.

Always switch off the windshield wipers and ignition before changing the wiper blades.

Replacing the wiper blades (standard windshield wipers)

Moving the wiper arms to a vertical position

On vehicles without KEYLESS-GO:

- ▶ Turn the SmartKey to position **0** in the ignition lock (▷ page 133).
- ▶ Set the windshield wiper to the position.
- ▶ Turn the SmartKey to position **1** in the ignition lock (▷ page 133).
- ▶ As soon as the wiper arms are vertical to the hood, turn the SmartKey to position **0** in the ignition lock (▷ page 133).
- ▶ Remove the SmartKey.
- ▶ Fold the wiper arms away from the windshield until you feel them snap into place.

On vehicles with KEYLESS-GO:

- ▶ Switch off the engine.
- ▶ Remove your foot from the brake pedal.
- ▶ Set the windshield wipers to position .
- ▶ Press the Start/Stop button repeatedly until the windshield wiper starts.
- ▶ When the wiper arms have reached the vertical position, press the Start/Stop button repeatedly until the windshield wipers stop.
- ▶ Fold the wiper arms away from the windshield until you feel them snap into place.

Removing the wiper blades

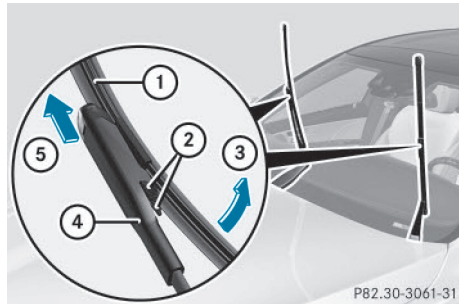

- ▶ Press both release clips ②.
- ▶ Fold wiper blade ① in the direction of arrow ③ away from wiper arm ④.
- ▶ Remove wiper blade ① in the direction of arrow ⑤.

Installing the wiper blades

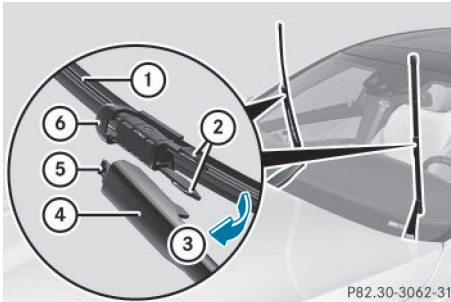

- ▶ Position the new wiper blade ① with recess ⑥ on lug ⑤.
- ▶ Fold wiper blade ① in the direction of arrow ③ onto the wiper arm, until retaining clips ② engage in bracket ④.
- ▶ Make sure that wiper blade ① is seated correctly.
- ▶ Fold the wiper arm back onto the windshield.

Replacing the wiper blades (MAGIC VISION CONTROL)

Moving the wiper arms to a vertical position

On vehicles without KEYLESS-GO:

- ▶ Turn the SmartKey to position **0** in the ignition lock (▷ page 133).
- ▶ Set the windshield wiper to the  position.
- ▶ Turn the SmartKey to position **1** in the ignition lock (▷ page 133).
- ▶ As soon as the wiper arms are vertical to the hood, turn the SmartKey to position **0** in the ignition lock (▷ page 133).

- ▶ Remove the SmartKey.
- ▶ Fold the wiper arms away from the windshield until you feel them snap into place.

On vehicles with KEYLESS-GO:

- ▶ Switch off the engine.
- ▶ Remove your foot from the brake pedal.
- ▶ Set the windshield wipers to position .
- ▶ Press the Start/Stop button repeatedly until the windshield wiper starts.
- ▶ When the wiper arms have reached the vertical position, press the Start/Stop button repeatedly until the windshield wipers stop.
- ▶ Fold the wiper arms away from the windshield until you feel them snap into place.

Removing a wiper blade

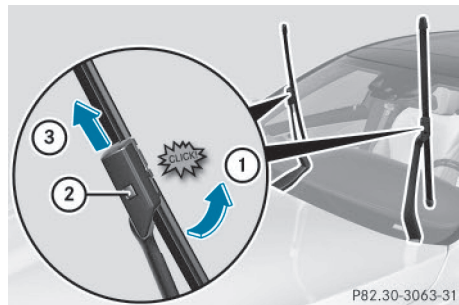

- ▶ **To bring the wiper blade into position to be removed:** hold the wiper arm firmly with one hand. With the other hand, turn the wiper blade in the direction of arrow ① beyond the point of resistance. The wiper blade engages in the removal position with an audible click.
- ▶ **To remove a wiper blade:** firmly press release knob ② and pull the wiper blade upwards ③.

Installing the wiper blades

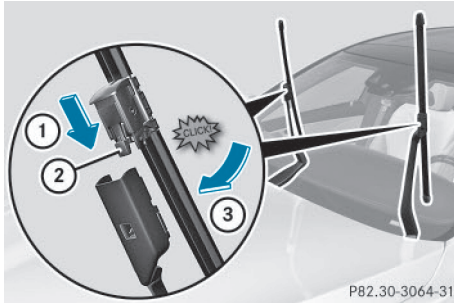

- ▶ Push the new wiper blade in the direction of arrow ① onto the wiper arm until tab ② engages.
- ▶ Push the wiper blade out of the removal position in the direction of arrow ③ beyond the point of resistance. The wiper blade disengages with an audible click and is freely movable again.
- ▶ Make sure that the wiper blade is seated correctly.
- ▶ Fold the wiper arm back onto the windshield.

Problems with the windshield wipers

You can find information about this in the Digital Operator's Manual.

| | |
|---|-----|
| Useful information | 124 |
| Overview of climate control systems | 124 |
| Operating the climate control systems | 129 |

Useful information

- i** This Operator's Manual describes all models and all standard and optional equipment of your vehicle available at the time of publication of the Operator's Manual. Country-specific differences are possible. Please note that your vehicle may not be equipped with all features described. This also applies to safety-related systems and functions.
- i** Read the information on qualified specialist workshops (▷ page 30).

Overview of climate control systems

General notes

Observe the settings recommended on the following pages. The windows could otherwise fog up.

To prevent the windows from fogging up:

- switch off climate control only briefly
- switch on air-recirculation mode only briefly
- switch on the cooling with air dehumidification function
- switch on the defrost windshield function briefly, if required

Climate control regulates the temperature and air humidity in the vehicle interior. The air filter cleans the air, thus improving the interior climate.

The "Cooling with air dehumidification" function is only available when the engine is running. Optimum climate control is only achieved with the side windows and roof closed.

The residual heat function can only be activated or deactivated if the ignition is switched off. See the Digital Operator's Manual, keyword "Residual heat".

- i** Ventilate the vehicle in briefly in warm weather conditions, e.g. with the "Convenience opening" function, see the Digital Operator's Manual, keyword "Convenience

opening". This will speed up the cooling process and the desired interior temperature will be reached more quickly.

- i** The integrated filter filters out most particles of dust and soot and completely filters out pollen. It also reduces gaseous pollutants and odors. A clogged filter reduces the amount of air supplied to the vehicle interior. For this reason, you should always observe the interval for replacing the filter, which is specified in the Maintenance Booklet. As it depends on environmental conditions, e.g. heavy air pollution, the interval may be shorter than stated in the Maintenance Booklet.
- i** It is possible that the blower may be activated automatically 60 minutes after the SmartKey has been removed depending on various factors, e.g. the outside temperature. The vehicle is then ventilated for 30 minutes to dry the climate control system.

Automatic climate control panel

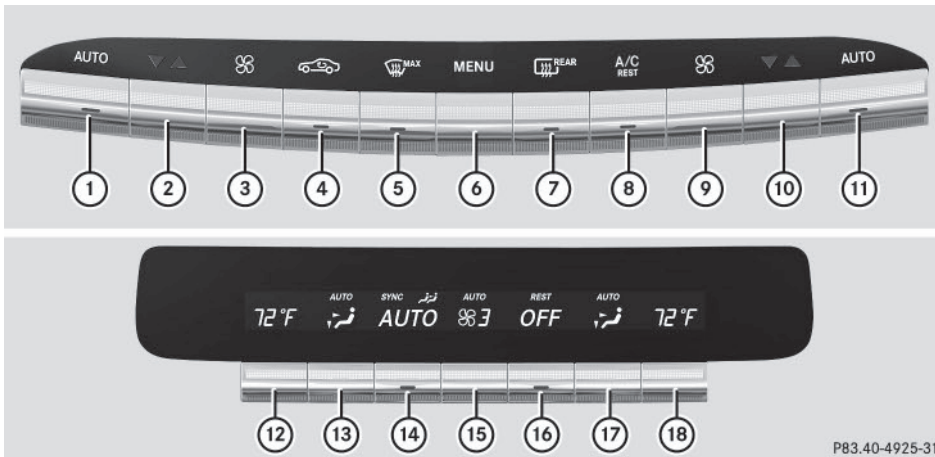

P83.40-4925-31

USA only

Front control panel

- ① Sets climate control to automatic, left
- ② Sets the temperature, left
- ③ Sets the airflow, left
- ④ Activates/deactivates air-recirculation mode
- ⑤ Defrosts the windshield
- ⑥ Calls up the COMAND climate control menu
- ⑦ Switches the rear window defroster on/off
- ⑧ Activates/deactivates cooling with air dehumidification
Activates/deactivates the residual heat function
- ⑨ Sets the airflow, right
- ⑩ Sets the temperature, right
- ⑪ Sets climate control to automatic, right

Rear control panel (vehicles with rear-compartment climate control)

- ⑫ Sets the temperature, left
- ⑬ Sets the air distribution, left
- ⑭ Sets climate control to automatic
- ⑮ Sets the airflow
- ⑯ Switches climate control on/off
Activates/deactivates the residual heat function
- ⑰ Sets the air distribution, right
- ⑱ Sets the temperature, right

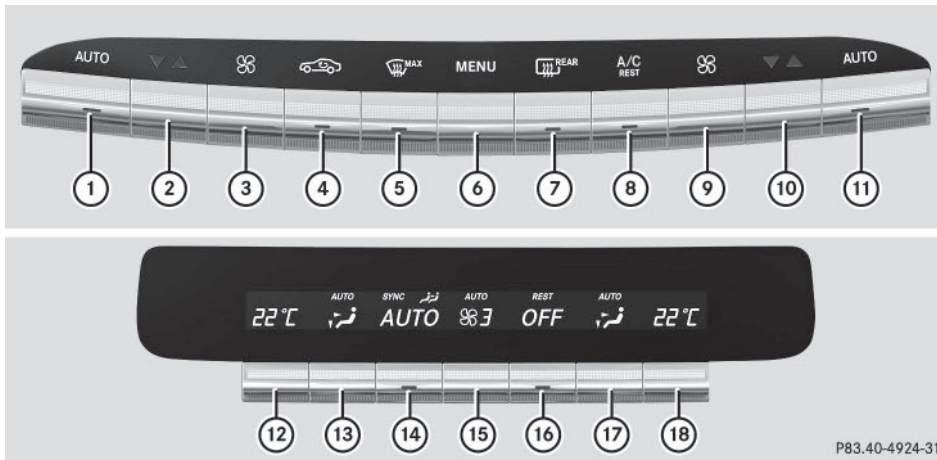

P83.40-4924-31

Climate control

Canada only

Front control panel

- ① Sets climate control to automatic, left
- ② Sets the temperature, left
- ③ Sets the airflow, left
- ④ Activates/deactivates air-recirculation mode
- ⑤ Defrosts the windshield
- ⑥ Calls up the COMAND climate control menu
- ⑦ Switches the rear window defroster on/off
- ⑧ Activates/deactivates cooling with air dehumidification
Activates/deactivates the residual heat function
- ⑨ Sets the airflow, right
- ⑩ Sets the temperature, right
- ⑪ Sets climate control to automatic, right

Rear control panel (vehicles with rear-compartment climate control)

- ⑫ Sets the temperature, left
- ⑬ Sets the air distribution, left
- ⑭ Sets climate control to automatic
- ⑮ Sets the airflow
- ⑯ Switches climate control on/off
Activates/deactivates the residual heat function
- ⑰ Sets the air distribution, right
- ⑱ Sets the temperature, right

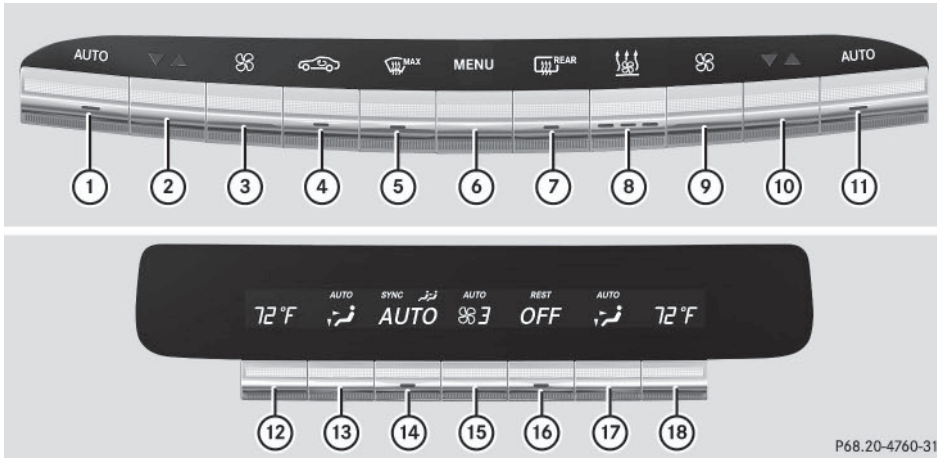

P68.20-4760-31

PLUG-IN HYBRID (USA only)

Front control panel

- ① Sets climate control to automatic, left
- ② Sets the temperature, left
- ③ Sets the airflow, left
- ④ Activates/deactivates air-recirculation mode manually
- ⑤ Defrosts the windshield
- ⑥ Calls up the COMAND climate control menu
Activates/deactivates the residual heat function
- ⑦ Switches the rear window defroster on/off
- ⑧ Activates/deactivates "immediate pre-entry climate control"
- ⑨ Sets the airflow, right
- ⑩ Sets the temperature, right
- ⑪ Sets climate control to automatic, right

Rear control panel (vehicles with rear-compartment climate control)

- ⑫ Sets the temperature, left
- ⑬ Sets the air distribution, left
- ⑭ Sets climate control to automatic
- ⑮ Sets the airflow
- ⑯ Switches climate control on/off
Activates/deactivates the residual heat function
- ⑰ Sets the air distribution, right
- ⑱ Sets the temperature, right

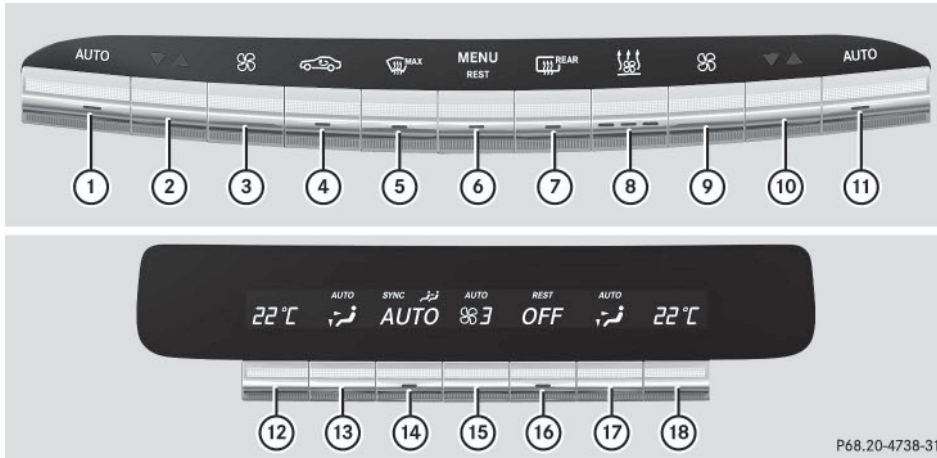

P68.20-4738-31

PLUG-IN HYBRID (Canada only)

Front control panel

- ① Sets climate control to automatic, left
- ② Sets the temperature, left
- ③ Sets the airflow, left
- ④ Activates/deactivates air-recirculation mode manually
- ⑤ Defrosts the windshield
- ⑥ Calls up the COMAND climate control menu
Activates/deactivates the residual heat function
- ⑦ Switches the rear window defroster on/off
- ⑧ Activates/deactivates "immediate pre-entry climate control"
- ⑨ Sets the airflow, right
- ⑩ Sets the temperature, right
- ⑪ Sets climate control to automatic, right

Rear control panel (vehicles with rear-compartment climate control)

- ⑫ Sets the temperature, left
- ⑬ Sets the air distribution, left
- ⑭ Sets climate control to automatic
- ⑮ Sets the airflow
- ⑯ Switches climate control on/off
Activates/deactivates the residual heat function
- ⑰ Sets the air distribution, right
- ⑱ Sets the temperature, right

Operating the climate control systems

In the Digital Operator's Manual you will find information on the following topics:

- Switching climate control on/off
- Switching cooling with air dehumidification on/off
- Setting climate control to automatic
- Adjusting the climate mode settings
- Setting the temperature
- Setting the air distribution
- Setting the airflow
- Switching the synchronization function on/off
- Defrosting the windshield
- Defrosting the windows
- Switching the rear window defroster on/off
- Activating/deactivating air-recirculation mode
- Switching the residual heat function on/off
- Perfume atomizer
- Ionization
- **PLUG-IN HYBRID:** pre-entry climate control via key
- **PLUG-IN HYBRID:** pre-entry climate control at departure time (REMOTE CLIMATE CONTROL)
- Setting the air vents

| | |
|---|-----|
| Useful information | 132 |
| Notes on breaking-in a new vehicle | 132 |
| Driving | 132 |
| Automatic transmission | 138 |
| Refueling | 141 |
| Charging the high-voltage battery (plug-in hybrid vehicles) | 144 |
| Parking | 154 |
| Driving tips | 156 |
| Driving systems | 158 |
| PLUG-IN HYBRID operation | 187 |

Useful information

- i** This Operator's Manual describes all models and all standard and optional equipment of your vehicle available at the time of publication of the Operator's Manual. Country-specific differences are possible. Please note that your vehicle may not be equipped with all features described. This also applies to safety-related systems and functions.
- i** Read the information on qualified specialist workshops (▷ page 30).

Notes on breaking-in a new vehicle

Important safety notes

The sensor system of some driving and driving safety systems adjusts automatically while a certain distance is being driven after the vehicle has been delivered or after repairs. Full system effectiveness is not reached until the end of this teach-in procedure.

New and replaced brake pads and discs only reach their optimum braking effect after several hundred kilometers of driving. Compensate for this by applying greater force to the brake pedal.

The first 1000 miles (1500 km)

The more you look after the engine when it is new, the more satisfied you will be with its performance in the future.

- You should therefore drive at varying vehicle and engine speeds for the first 1000 miles (1500 km).
- Avoid heavy loads, e.g. driving at full throttle, during this period.
- When shifting gears manually, upshift in good time, before the tachometer needle reaches $\frac{2}{3}$ of the way to the red area of the tachometer.

- Do not manually shift to a lower gear to brake the vehicle.
- Try to avoid depressing the accelerator pedal beyond the point of resistance (kick-down).
- **All vehicles (except AMG vehicles):** ideally, for the first 1,000 miles (1,500 km), drive in program **E**.

Additional breaking-in notes for AMG vehicles:

- Do not drive faster than 85 mph (140 km/h) for the first 1,000 miles (1,500 km).
- Only allow the engine to reach a maximum engine speed of 4,500 rpm briefly.
- Change gear in good time.
- Ideally, for the first 1,000 miles (1,500 km), drive in program **C**.

After 1000 miles (1500 km), you can increase the engine speed gradually and accelerate the vehicle to full speed.

You should also observe these notes on breaking in if the engine or parts of the drive train on your vehicle have been replaced.

Always observe the respective speed limits.

Driving

Important safety notes

WARNING

Objects in the driver's footwell can restrict the pedal travel or obstruct a depressed pedal. The operating and road safety of the vehicle is jeopardized. There is a risk of an accident.

Make sure that all objects in the vehicle are stowed correctly, and that they cannot enter the driver's footwell. Install the floormats securely and as specified in order to ensure sufficient clearance for the pedals. Do not use loose floormats and do not place floormats on top of one another.

⚠ WARNING

Unsuitable footwear can hinder correct usage of the pedals, e.g.:

- shoes with thick soles
- shoes with high heels
- slippers

There is a risk of an accident.

Wear suitable footwear to ensure correct usage of the pedals.

⚠ WARNING

If you switch off the ignition while driving, safety-relevant functions are only available with limitations, or not at all. This could affect, for example, the power steering and the brake boosting effect. You will require considerably more effort to steer and brake. There is a risk of an accident.

Do not switch off the ignition while driving.

⚠ WARNING

If the parking brake has not been fully released when driving, the parking brake can:

- overheat and cause a fire
- lose its hold function.

There is a risk of fire and an accident. Release the parking brake fully before driving off.

! Do not warm up the engine with the vehicle stationary. Drive off immediately. Avoid high engine speeds and driving at full throttle until the engine has reached its operating temperature.

Only shift the automatic transmission to the desired drive position when the vehicle is stationary.

Where possible, avoid spinning the drive wheels when pulling away on slippery roads. You could otherwise damage the drive train.

! **AMG vehicles:** at low engine oil temperatures below 68 °F (+20 °C), the maximum engine speed is restricted in order to protect the engine. To protect the engine and

maintain smooth engine operation, avoid driving at full throttle when the engine is cold.

Observe the important safety notes for PLUG-IN HYBRID vehicles (▷ page 44).

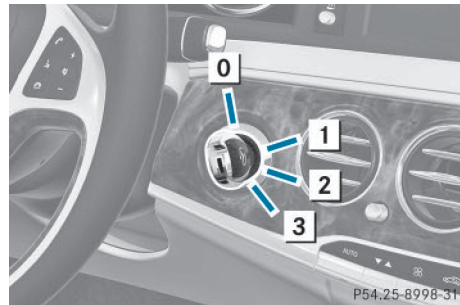
Key positions**SmartKey**

- 0** To remove the SmartKey
- 1** Power supply for some consumers, such as the windshield wipers
- 2** Ignition (power supply for all consumers) and drive position
- 3** To start the engine

The SmartKey can be turned in the ignition lock even if it is not the correct SmartKey for the vehicle. The ignition is not switched on. The engine cannot be started.

Start/Stop button**General notes**

All vehicles are equipped with a removable Start/Stop button.

The Start/Stop button must be inserted in the ignition lock and the SmartKey must be in the vehicle.

When you insert the Start/Stop button into the ignition lock, the system needs approximately two seconds recognition time. You can then use the Start/Stop button.

Pressing the Start/Stop button several times in succession corresponds to the different

key positions in the ignition lock. This is only the case if you are not depressing the brake pedal.

If you depress the brake pedal and press the Start/Stop button, the engine starts immediately.

A check which periodically establishes a radio connection between the vehicle and the SmartKey determines whether a valid SmartKey is in the vehicle. This occurs, for example, when starting the engine.

To start the vehicle without actively using the SmartKey:

- the Start/Stop button must be inserted in the ignition lock.
- the SmartKey must be in the vehicle.
- the vehicle must not be locked with the SmartKey or KEYLESS-GO (▷ page 89).

Do not keep the SmartKey:

- with electronic devices, e.g. a mobile phone or another SmartKey
- with metallic objects, e.g. coins or metal foil
- inside metallic objects, e.g. a metal case

This can affect the functionality of the SmartKey.

Do not keep the SmartKey in the temperature-controlled cup holder (▷ page 235). Otherwise, the SmartKey will not be detected, e.g. when starting the engine with the Start/Stop button.

If you lock the vehicle with the SmartKey's remote control or with KEYLESS-GO, after a short time:

- you will not be able to switch on the ignition with the Start/Stop button.
- you will not be able to start the engine with the Start/Stop button until the vehicle is unlocked again.

If you lock the vehicle centrally using the button on the front door (▷ page 92), you can continue to start the engine with the Start/Stop button.

The engine can be turned off while the vehicle is in motion by pressing and holding the Start/Stop button for approximately three seconds. This function operates independently of the ECO start/stop automatic engine switch-off function.

SmartKey positions with the Start/Stop button

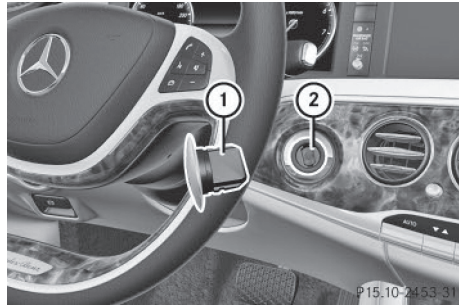

- ① Start/Stop button
- ② Ignition lock

As soon as the ignition is switched on, all the indicator lamps in the instrument cluster light up. If an indicator lamp does not go out after starting the engine or lights up while driving, see (▷ page 213).

If Start/Stop button ① has not yet been pressed, this corresponds to the SmartKey being removed from the ignition.

► **To switch on the power supply:** press Start/Stop button ① once.

The power supply is switched on. You can now activate the windshield wipers, for example.

The power supply is switched off again if:

- the driver's door is opened and
- you press Start/Stop button ① twice when in this position

- ▶ **To switch on the ignition:** press Start/Stop button ① twice.
The ignition is switched on.

The ignition is switched off when:

- the driver's door is opened and
- you press Start/Stop button ① once when in this position

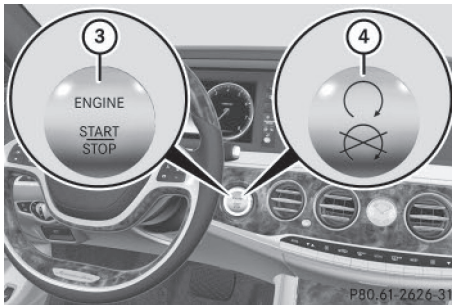

- ③ Start/Stop button USA
- ④ Start/Stop button Canada

Removing the Start/Stop button

You can remove the Start/Stop button from the ignition lock and start the vehicle as normal using the SmartKey.

It is only possible to switch between Start/Stop button mode and SmartKey operation when the transmission is in position **P**.

- ▶ Remove Start/Stop button ① from ignition lock ②.

You do not have to remove the Start/Stop button from the ignition lock when you leave the vehicle. You should, however, always take the SmartKey with you when leaving the vehicle. As long as the SmartKey is in the vehicle:

- the vehicle can be started using the Start/Stop button
- the electrically powered equipment can be operated

Starting the engine

Important safety notes

WARNING

If children are left unsupervised in the vehicle, they could:

- open the doors, thus endangering other people or road users.
- get out and disrupt traffic.
- operate the vehicle's equipment.

Additionally, children could set the vehicle in motion if, for example, they:

- release the parking brake.
- shifting the automatic transmission out of park position **P**
- Start the engine.

There is a risk of an accident and injury.

When leaving the vehicle, always take the SmartKey with you and lock the vehicle. Never leave children or animals unattended in the vehicle. Always keep the SmartKey out of reach of children.

WARNING

Combustion engines emit poisonous exhaust gases such as carbon monoxide. Inhaling these exhaust gases leads to poisoning. There is a risk of fatal injury. Therefore never leave the engine running in enclosed spaces without sufficient ventilation.

WARNING

Flammable materials introduced through environmental influence or by animals can ignite if in contact with the exhaust system or parts of the engine that heat up. There is a risk of fire.

Carry out regular checks to make sure that there are no flammable foreign materials in the engine compartment or in the exhaust system.

- ❗ Do not depress the accelerator when starting the engine.

General notes

During a cold start, the engine runs at higher speeds to enable the catalytic converter to reach its operating temperature. The sound of the engine may change during this time.

Automatic transmission

- ▶ Shift the transmission to position **P**. You can find information about this in the Digital Operator's Manual.

The transmission position display in the multifunction display shows **P**. You can find information about this in the Digital Operator's Manual.

You can start the engine in transmission position **P** and **N**.

Starting procedure with the SmartKey

To start the engine using the SmartKey instead of the Start/Stop button, pull the Start/Stop button out of the ignition lock.

- ▶ Turn the SmartKey to position **3** in the ignition (▷ page 133) lock and release it as soon as the engine is running.

Starting procedure with the Start/Stop button

The Start/Stop button can be used to start the vehicle manually without inserting the SmartKey into the ignition lock. The Start/Stop button must be inserted in the ignition lock and the SmartKey must be in the vehicle. This mode for starting the engine operates independently of the ECO start/stop automatic engine start function.

You can start the engine if a valid SmartKey is in the vehicle. Always take the SmartKey with you when leaving the vehicle, even if you only leave it for a short time. Pay attention to the important safety notes.

- ▶ Depress the brake pedal and keep it depressed.
- ▶ Press the Start/Stop button once (▷ page 133). The engine starts.

Pulling away

General notes

WARNING

If the engine speed is above the idling speed and you engage transmission position **D** or **R**, the vehicle could pull away suddenly. There is a risk of an accident.

When engaging transmission position **D** or **R**, always firmly depress the brake pedal and do not simultaneously accelerate.

Depress the accelerator carefully when pulling away.

The vehicle locks centrally once you have pulled away. The locking knobs in the doors drop down.

You can open the doors from the inside at any time.

You can also deactivate the automatic locking feature (▷ page 92).

It is only possible to shift the transmission from position **P** to the desired position if you depress the brake pedal. Only then is the parking lock released. If the brake pedal is not depressed, the DIRECT SELECT lever can still be moved but the parking lock remains engaged.

-  Upshifts take place at higher engine speeds after a cold start. This helps the catalytic converter to reach its operating temperature more quickly.

Information on the automatic release of the electric parking brake can be found in the Digital Operator's Manual.

Hill start assist

Hill start assist helps you when pulling away forwards or in reverse on an uphill gradient. It holds the vehicle for a short time after you have removed your foot from the brake pedal. This gives you enough time to move your foot from the brake pedal to the accelerator pedal and to depress it before the vehicle begins to roll.

WARNING

After a short time, hill start assist will no longer brake your vehicle and it could roll away. There is a risk of an accident and injury.

Therefore, quickly move your foot from the brake pedal to the accelerator pedal. Never leave the vehicle when it is held by hill start assist.

Hill start assist is not active if:

- you are pulling away on a level road or on a downhill gradient.
- the transmission is in position **N**.
- the electric parking brake is applied.
- ESP® is malfunctioning.

ECO start/stop function (all vehicles except plug-in hybrid)

Introduction

This section describes the ECO start/stop function for all vehicles except PLUG-IN HYBRID vehicles. Information on the ECO start/stop function on PLUG-IN HYBRID vehicles can be found in the "PLUG-IN HYBRID operation" section in the Digital Operator's Manual.

The ECO start/stop function switches the engine off automatically if the vehicle is stopped under certain conditions.

The engine starts automatically when the driver wants to pull away again. The ECO start/stop function thereby helps you to reduce the fuel consumption and emissions of your vehicle.

Important safety notes

WARNING

If the engine is switched off automatically and you exit the vehicle, the engine is restarted automatically. The vehicle may begin moving. There is a risk of accident and injury.

If you wish to exit the vehicle, always turn off the ignition and secure the vehicle against rolling away.

General notes

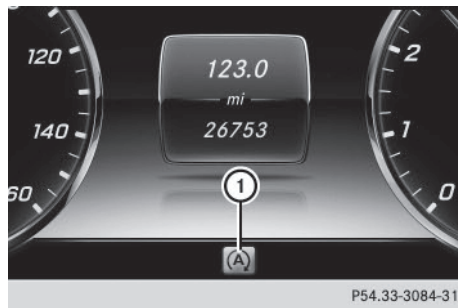

① ECO start/stop display

If the engine has been switched off automatically by the ECO start/stop function, the  ECO symbol is shown in the multifunction display.

Every time you switch on the engine using the SmartKey or the Start/Stop button, the ECO start/stop function is activated.

The ECO start/stop function is only available in drive program **E** (drive program **C** on AMG vehicles).

Information in the Digital Operator's Manual

In the Digital Operator's Manual you will find information on the following topics:

- Automatic engine switch-off
- Automatic engine start
- Deactivating/activating the ECO start/stop function

Problems with the engine

You can find information about this in the Digital Operator's Manual.

Automatic transmission**Important safety notes****⚠ WARNING**

If the engine speed is above the idling speed and you engage transmission position **D** or **R**, the vehicle could pull away suddenly. There is a risk of an accident.

When engaging transmission position **D** or **R**, always firmly depress the brake pedal and do not simultaneously accelerate.

⚠ WARNING

The automatic transmission switches to neutral position **N** when you switch off the engine. The vehicle may roll away. There is a risk of an accident.

After switching off the engine, always switch to parking position **P**. Prevent the parked vehicle from rolling away by applying the parking brake.

Observe the important safety notes for PLUG-IN HYBRID vehicles (▷ page 44).

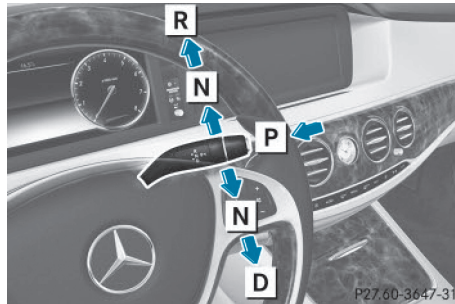
DIRECT SELECT lever**Overview of transmission positions**

- P** Park position with parking lock
- R** Reverse gear
- N** Neutral
- D** Drive

The DIRECT SELECT lever is on the right of the steering column.

The DIRECT SELECT lever always returns to its original position. The current transmission position **P**, **R**, **N** or **D** appears in the transmission position display in the multifunction display. You can find information about this in the Digital Operator's Manual.

Information in the Digital Operator's Manual

In the Digital Operator's Manual you will find information on the following topics:

- Engaging park position P
- Engaging park position P automatically
- Engaging reverse gear R
- Engaging drive position D

Shifting to neutral N

WARNING

If children are left unsupervised in the vehicle, they could:

- open the doors, thus endangering other people or road users.
- get out and disrupt traffic.
- operate the vehicle's equipment.

Additionally, children could set the vehicle in motion if, for example, they:

- release the parking brake.
- shifting the automatic transmission out of park position **P**
- Start the engine.

There is a risk of an accident and injury.

When leaving the vehicle, always take the SmartKey with you and lock the vehicle. Never leave children or animals unattended in the vehicle. Always keep the SmartKey out of reach of children.

- ▶ If the transmission is in position **D** or **R**: push the DIRECT SELECT lever up or down to the first point of resistance.
- ▶ If the transmission is in position **P**: depress the brake pedal and push the DIRECT SELECT lever up or down to the first point of resistance.

If the engine has been switched off, the automatic transmission automatically shifts to **N**. If the automatic transmission is to remain in neutral **N**, e.g. for washing the vehicle in car washes with a towing device, please observe the following instructions:

Using the SmartKey:

- Make sure that the ignition is switched on.
- When the vehicle is stationary, depress the brake pedal and keep it depressed.
- Shift to neutral **N**.
- Release the brake pedal.

- If the electric parking brake is engaged, release it.
- Switch off the ignition and leave the SmartKey in the ignition lock.

With the Start/Stop button:

- Make sure that the ignition is switched on.
- When the vehicle is stationary, depress the brake pedal and keep it depressed.
- Engage park position **P**.
- Release the brake pedal.
- Pull the Start/Stop button out of the ignition.
- Insert the SmartKey into the ignition lock.
- Switch on the ignition.
- Depress the brake pedal and keep it depressed.
- Shift to neutral **N**.
- Release the brake pedal.
- If the electric parking brake is engaged, release it.
- Switch off the ignition and leave the SmartKey in the ignition lock.

Information in the Digital Operator's Manual

In the Digital Operator's Manual you will find information on the following topics:

- Transmission position display
- Transmission positions
- Driving tips
- Program selector button
- Steering wheel paddle shifters
- Automatic drive program
- Problems with the transmission

Manual drive program (AMG vehicles)

General information

In this drive program, you can permanently change gear yourself by using the steering

wheel paddle shifters. The transmission must be in position **D**.

Manual drive program **M** is different from drive program **S** with regard to spontaneity, responsiveness and smoothness of gear changes.

In addition to permanent drive program **M**, you can also activate temporary drive program **M**; see the Digital Operator's Manual.

Switching on the manual drive program

In manual drive program **M**, you can change gear using the steering wheel paddle shifters if the transmission is in position **D**. You can see the currently selected drive program and which gear is engaged in the multifunction display.

- ▶ Press the program selector button until **M** appears in the multifunction display; see the Digital Operator's Manual.

Upshifting

! In manual drive program **M**, the automatic transmission does not shift up automatically even when the engine limiting speed for the current gear is reached. When the engine limiting speed is reached, the fuel supply is cut to prevent the engine from overrevving. Always make sure that the engine speed does not reach the red area of the tachometer. There is otherwise a risk of engine damage.

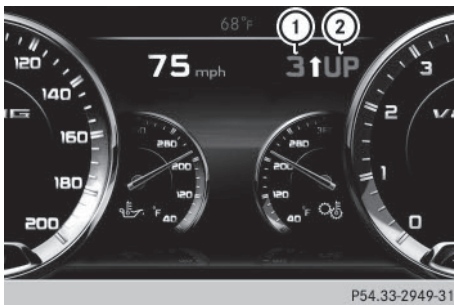

- ① Gear indicator
- ② Upshift indicator

Before the engine speed reaches the red area, an upshift indicator will be shown in the multifunction display.

- ▶ If the color in the speedometer multifunction display changes to red and the **UP** display message is shown, shift up a gear using the right-hand steering wheel paddle shifter.

The automatic transmission shifts up to the next gear if this is permissible.

Information in the Digital Operator's Manual

In the Digital Operator's Manual you will find information on the following topics:

- Downshifting
- Switching off the manual drive program

Transfer case

! Performance tests may only be carried out on a 2-axle dynamometer. The brake system or transfer case could otherwise be damaged. Contact a qualified specialist workshop for a performance test.

! To prevent ESP[®] from intervening, the ignition must be switched off (SmartKey or the Start/Stop button in position **0** or **1**) if:

- the electric parking brake is being tested on a brake dynamometer.
- the vehicle is being towed with only one axle raised (not permitted for vehicles with 4MATIC).

The brake system could otherwise be damaged.

! Vehicles with 4MATIC must not be towed with either the front or the rear axle raised, as doing so will damage the transmission.

This section is only valid for vehicles with 4-wheel drive (4MATIC). Power is always transmitted to both axles.

Refueling

Important safety notes

WARNING

Fuel is highly flammable. If you handle fuel incorrectly, there is a risk of fire and explosion.

You must avoid fire, open flames, creating sparks and smoking. Switch off the engine and, if applicable, the auxiliary heating before refueling.

WARNING

Fuel is poisonous and hazardous to health. There is a risk of injury.

You must make sure that fuel does not come into contact with your skin, eyes or clothing and that it is not swallowed. Do not inhale fuel vapors. Keep fuel away from children.

If you or others come into contact with fuel, observe the following:

- Wash away fuel from skin immediately using soap and water.
- If fuel comes into contact with your eyes, immediately rinse them thoroughly with clean water. Seek medical assistance without delay.
- If fuel is swallowed, seek medical assistance without delay. Do not induce vomiting.
- Immediately change out of clothing which has come into contact with fuel.

WARNING

Electrostatic buildup can create sparks and ignite fuel vapors. There is a risk of fire and explosion.

Always touch the vehicle body before opening the fuel filler flap or touching the fuel pump nozzle. Any existing electrostatic buildup is thereby discharged.

Do not get into the vehicle again during the refueling process. Otherwise, electrostatic charge could build up again.

 Do not use diesel to refuel vehicles with a gasoline engine. Do not switch on the ignition if you accidentally refuel with the wrong fuel. Otherwise, the fuel will enter the fuel system. Even small amounts of the wrong fuel could result in damage to the fuel system and the engine. Notify a qualified specialist workshop and have the fuel tank and fuel lines drained completely.

 Overfilling the fuel tank could damage the fuel system.

 Take care not to spill any fuel on painted surfaces. You could otherwise damage the paintwork.

 Use a filter when refueling from a fuel can. Otherwise, the fuel lines and/or injection system could be blocked by particles from the fuel can.

If you overfill the fuel tank, fuel could spray out when the fuel pump nozzle is removed. For further information on fuel and fuel quality (> page 322).

Refueling

General information

Pay attention to the important safety notes (> page 141).

PLUG-IN HYBRID vehicles: pressure in the fuel tank must be released before refueling.

Except PLUG-IN HYBRID vehicles: If you unlock/lock the vehicle from the outside, the fuel filler flap also unlocks/locks.

The position of the fuel filler cap is displayed  in the instrument cluster. The arrow next to the filling pump indicates the side of the vehicle.

Preparing to refuel

- ▶ Switch off the engine.
- ▶ Open the driver's door.
The on-board electronics now have status **0**. This is the same as the SmartKey having been removed.

or, if the SmartKey is inserted in the ignition lock:

- ▶ Remove the SmartKey from the ignition lock.

Opening the fuel filler flap (except PLUG-IN hybrid vehicles)

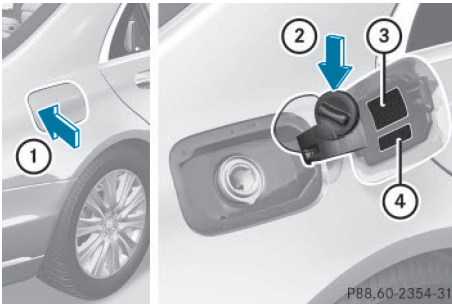

- ① To open the fuel filler flap
 - ② To insert the fuel filler cap
 - ③ Tire pressure table
 - ④ Fuel type to be used
- ▶ Press the fuel filler flap in the direction of arrow ①.
The fuel filler flap swings up.
 - ▶ Turn the fuel filler flap counter-clockwise and remove it.
 - ▶ Insert the fuel filler cap into the holder on the inside of the fuel filler flap.
 - ▶ Completely insert the filler neck of the fuel pump nozzle into the tank, hook in place and refuel.
 - ▶ Only fill the tank until the pump nozzle switches off.
Do not add any more fuel after the pump stops filling for the first time. Otherwise, fuel may leak out.

Opening the fuel filler flap (PLUG-IN HYBRID vehicles)

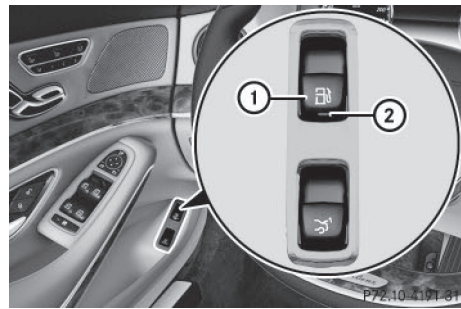

- ▶ Pull switch ①.
Indicator lamp ② flashes and the **Please Wait Depressurizing Tank** message appears in the multifunction display.
If the fuel filler cap is open, indicator lamp ② lights up.
The **Tank is Depressurized Ready for Refueling** message appears in the multifunction display.
Please be sure to observe the information on refueling on the fuel filler flap.

There is a malfunction if:

- indicator lamp ② first flashes and then goes out
 - the yellow engine diagnostics warning lamp lights up
- ① From a speed of 2 km/h, the fuel filler cap can no longer be opened.
 - ① The opening process for the fuel filler cap may take up to 15 minutes.

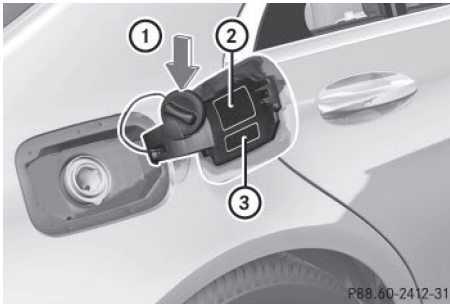

- ① To insert the fuel filler cap
- ② Tire pressure table
- ③ Fuel type to be used

- ▶ Turn the fuel filler flap counter-clockwise and remove it.
- ▶ Insert the fuel filler cap into the holder on the inside of the fuel filler flap.
- ▶ Completely insert the filler neck of the fuel pump nozzle into the tank, hook in place and refuel.
- ▶ Only fill the tank until the pump nozzle switches off.
Do not add any more fuel after the pump stops filling for the first time. Otherwise, fuel may leak out.

Closing the fuel filler flap

- ▶ Replace the cap on the filler neck and turn clockwise until it engages audibly.
- ▶ Close the fuel filler flap.

If you drive at speeds above 2 km/h with the fuel filler flap open, the **Tankklappe offen (Fuel filler flap open)** message is shown in the multifunction display.

- i** Close the fuel filler flap before locking the vehicle.
- i** For further information on warning and indicator lamps in the instrument cluster, see (▷ page 211).
- i** If you are driving with the fuel filler cap open, the  reserve fuel warning lamp flashes. A message appears in the multifunction display (▷ page 195).

In addition, the  Check Engine warning lamp may light up (▷ page 211).

For further information on warning and indicator lamps in the instrument cluster, see (▷ page 211).

Problems with fuel and the fuel tank

This section provides descriptions of and solutions to safety-relevant problems. Descriptions of and solutions to further problems can be found in the Digital Operator's Manual.

| Problem | Possible causes/consequences and ► Solutions |
|-----------------------------------|---|
| Fuel is leaking from the vehicle. | <p> WARNING</p> <p>The fuel line or the fuel tank is faulty. Risk of explosion or fire.</p> <ul style="list-style-type: none"> ► Apply the electric parking brake. ► Switch off the engine. ► Open the driver's door. <p>The on-board electronics now have status 0. This is the same as the SmartKey having been removed.</p> <p>or, if the SmartKey is inserted in the ignition lock:</p> <ul style="list-style-type: none"> ► Remove the SmartKey from the ignition lock. ► Do not restart the engine under any circumstances. ► Consult a qualified specialist workshop. |

Charging the high-voltage battery (plug-in hybrid vehicles)**Important safety notes** **DANGER**

The vehicle's high voltage electrical system is under high voltage. If you modify components in the vehicle's high-voltage electrical system or touch damaged components, you may be electrocuted. The components in the vehicle's high-voltage electrical system may be damaged in an accident, although the damage is not visible. There is a risk of fatal injury.

Following an accident, do not touch any high-voltage components and never modify the vehicle's high-voltage electrical system. Have the vehicle towed away after an accident and the vehicle's high-voltage electrical system checked by a qualified specialist workshop.

 **WARNING**

In the event of a vehicle fire, the internal pressure of the high-voltage battery can exceed a critical value. In this case flammable gas

escapes through a ventilation valve on the underbody. The gas can ignite. There is a risk of injury.

Leave the danger zone immediately. Secure the danger area at a suitable distance, whilst observing legal requirements.

 **DANGER**

If you use incorrectly installed mains sockets or adapters, extension cables or similar to connect the charging cable to a mains socket, this could lead to fires or an electric shock. There is a risk of fatal injury.

To avoid hazardous situations, observe the following:

- Only connect the charging cable to mains sockets that:
 - are installed correctly and
 - have been approved by an electrical specialist.
- For safety reasons, only use the charging cables supplied with the vehicle, or charging cables which have been approved for use with this vehicle.

- Never use a damaged charging cable.
- Do **not** use:
 - Extension cables
 - Cable drums
 - Multiple sockets
- Do not use a socket adapter to connect the charging cable to the mains socket. The only exception is if the adapter has been tested and approved by the manufacturer for charging the high-voltage battery in an electric vehicle.
- Always observe the safety notes in the socket adapter's operating instructions.

DANGER

Connecting the charging cable to the wallbox via an incorrectly installed wallbox or adapter, extension cable or similar could cause a fire or an electric shock. There is a risk of fatal injury.

To avoid hazardous situations, observe the following:

- Only connect the charging cable to a wallbox that:
 - is installed correctly and
 - has been approved by an electrical specialist.
- For safety reasons, only use charging cables that have been tested and approved by the manufacturer for charging the high-voltage battery in an electric vehicle.
- Never use damaged charging cables.
- Do not extend the charging cable.
- Do not use an adapter.
- Always observe the safety notes in the wallbox's operating instructions.

The vehicle's high voltage electrical system is under high voltage.

- Do not tamper with the high-voltage components or the orange cables of the high-voltage electrical system.
- Do not touch high-voltage components or the orange cables of the high-voltage elec-

trical system when a vehicle has been involved in a crash.

- Never touch damaged components or the damaged orange cables of the high-voltage electrical system.
- Do not remove the covers of the high-voltage electrical system components that are marked with a warning sticker.

General notes

Method of operation

The vehicle is equipped with a high-voltage battery for driving. The high-voltage battery stores the energy needed to operate the electric motor and releases it again.

The electric motor uses energy that has been stored in the high-voltage battery when pulling away, accelerating and during the journey.

In overrun mode, kinetic energy is converted by means of energy recuperation into electrical energy and stored in the high-voltage battery.

The high-voltage battery can be charged as follows:

- through energy recuperation while the vehicle is in motion
- during the journey using the CHARGE mode
- with the relevant charging cable at an electrical outlet while the vehicle is stationary
- with the relevant charging cable at a wallbox while the vehicle is stationary
- with the relevant charging cable at a charging station while the vehicle is stationary

The high-voltage battery can be charged in a nominal voltage range from 100 V to 240 V.

High and low outside temperatures

Low outside temperatures

At very low outside temperatures the maximum power output of the high-voltage battery may be reduced. The high-voltage battery is

then no longer able to provide the normal electrical power output.

High outside temperatures

To prevent damage to the high-voltage battery due to very high outside temperatures, the maximum power output of the high-voltage battery is reduced by the vehicle.

Energy consumption and electrical range

The maximum electrical range is generally reduced by:

- high and low outside temperatures
- the use of air conditioning or heating
- switching on consumers

The battery's physical characteristics are such that leaving the vehicle parked for long periods at low outdoor temperatures without charging it can lead to:

- a reduction in battery performance
- longer charge times

Notes on battery care

Avoid storing or transporting the vehicle in temperatures that are too high or too low over a long period (e.g. container transport).

If you park the vehicle and leave it stationary for longer periods, connect it to a power supply.

Conditions of use

Please note the information on exceptions and limitations in warranty documentation and in the Maintenance Booklet.

Handling the charging cable and charging cable controls

Do not leave the charging cable controls (> page 147) hanging loose from an electrical outlet. Otherwise, this could result in a poor contact with the electrical outlet and malfunctions when charging the vehicle.

To ensure that the cable on the controls of the charging cable is not subjected to incorrect loads, observe the following:

- Never lift the controls up at the charging cable connector or the power supply plug.
- Do not carry the controls by the connector.

Heat generated by the charging cable and connector

Pay attention to the "Important safety notes" (> page 144).

During the charging process, the charging cable and connector may heat up.

The charging cable and connector will only heat up within the permissible limiting values, provided that:

- the power supply and the charging cable are not damaged
- the instructions for handling the charging cable and controls on the charging cable are observed

If the charging cable or plug get too hot, have the mains power supply checked.

Protection device against overvoltage

I Overvoltage in the mains supply may damage the vehicle. For this reason, the vehicle is equipped with a protection device against overvoltage in the mains supply. This device may be triggered during severe thunderstorms, for example, and may lead to the building's fuse being tripped and an interruption in the power supply. These functions protect the vehicle. After the building fuse is switched on again, the charging process resumes automatically. Following an interruption in the power supply or tripping of the building's fuse, it may take up to 10 minutes for charging to resume automatically.

Switch on the building's fuse again after it has been triggered. Otherwise, the charging process cannot be continued.

General information about the charging procedure

Pay attention to the important safety notes (▷ page 144).

If you unlock/lock the vehicle from the outside, the charge socket flap also unlocks/locks.

The charge socket flap is behind the bumper on the right-hand side below the rear lamp cluster.

Charging the high-voltage battery via the electrical outlet

Charging cable for mains sockets

Important safety notes

! Only use the charging cable to charge the high-voltage battery. Do not use the charging cable for other purposes. It may otherwise be damaged.

A charging cable for connection to the mains socket is included with the vehicle. Only use the charging cable included with the vehicle or charging cables that have been approved for the vehicle.

- i** If you use the supplied 12 A charging cable to charge a high-voltage battery:
 - the charge time increases considerably
 - electrical consumption increases considerably

Where possible, charge the high-voltage battery at a charging station (▷ page 151). Only then can certified electrical energy consumption levels be reached.

- i** The charging process can vary depending on the power supply. Therefore, always observe the local information.
- i** For short charge times (charging with 16A), connect the fast-charging cable to the wallbox/charging station. You can also use the optionally available charging cable with the CE plug.

Information about charging from a wallbox can be found at (▷ page 150).

Information about charging at a charging station can be found at (▷ page 151).

Stowing the charging cable

The charging cable can be stowed in the bag supplied in the trunk of the vehicle and held in place with the Velcro fastener.

Controls on the charging cable

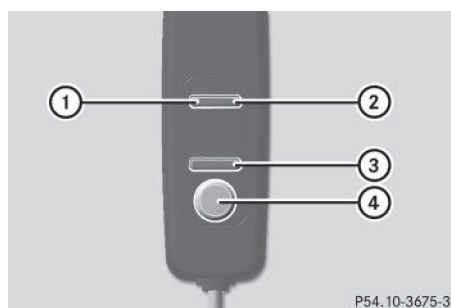

- ① Alternating current status indicator
- ② Control/protection system indicator
- ③ Charge current indicator
- ④ Charge current setting button

When displays ① and ② on the charging cable light up, this means the following:

| Display ① | |
|-----------------|--|
| Lights up green | The external power supply connection is working properly. The high-voltage battery can be charged. |
| Flashes red | A malfunction has been detected in the external power supply. The high-voltage battery is recharged as soon as the electricity signal registers normal values. |
| Lights up red | There is a malfunction. The charging cable must be removed from the electrical outlet and then re-inserted. |

| Display ② | |
|-----------------|---|
| Lights up green | There are no malfunctions. The high-voltage battery can be charged. |
| Lights up red | An impermissible current is being supplied to the control unit. The high-voltage battery cannot be charged. |

- ❗ For information on problems relating to the charging process, see (▶ page 152).

Setting the maximum charge current

WARNING

If the charge current draw via a mains socket is too high during the charging process, the external electrical system may overheat. There is a risk of fire.

Before beginning the charging process, check the maximum permissible charge current locally. Consult a qualified expert to do so where necessary.

If necessary, adjust your vehicle's settings.

- ❗ An excessive charge current can blow a fuse or lead to overheating of the external power supply. Check whether the external power supply is compatible with the set charge current. If necessary, lower the set charge current or use another power socket.

You can set a limit for the values of the charge current used in charging the high-voltage battery. This acts as a means of preventing the power supply from overloading. You can set this limit by using the controls on the charging cable or in the on-board computer's menu. Only set the maximum charge current in the on-board computer menu if there are no charge current settings on the charging cable.

The default standard value in the vehicle corresponds to the maximum charge current value.

The default standard value on the charging cable is the minimum charge current setting. This corresponds to the minimum available charge current from the power supply. The value on the charging cable can be increased and is described in the following section.

- ❗ The value of the maximum setting and the adjustment values may vary depending on the country.

Before charging the high-voltage battery, check the maximum permissible charge current for the relevant power socket.

▶ **To adjust the setting:** press button ④ repeatedly until the desired setting is selected in display ③.

- Two LEDs are flashing: minimum setting
- All LEDs are flashing: maximum setting

If, after the charging process, the charging cable is:

- left connected to the power socket, the currently selected values will be used for the next charging process.
- removed from the power socket, the values will be reset to the minimum setting for the next charging process. You may then need to reset the values of the maximum charge current.

- ❗ If the vehicle requires more time than usual when charging, check the maximum charge current settings using the controls on the charging cable or in the on-board computer's menu.

Indicator lamp on the vehicle socket



When the indicator lamp on the vehicle socket lights up, this means the following:

| Indicator lamp  | |
|--|--|
| Flashes slowly in orange | The connection between the vehicle and the current source is being established before charging begins. |
| Flashes slowly in green | The high-voltage battery is being charged. |
| Flashes rapidly in red | A malfunction has occurred while charging. |
| Lights up orange | A charging break for the high-voltage battery is taking place. |
| Lights up green | The high-voltage battery is fully charged. |

- i** If the indicator lamp is off, lock or unlock the vehicle with the SmartKey. The indicator lamp will then display the current status of the charging process.
- i** You can view the condition of charge of the high-voltage battery in the multifunction display (see the Digital Operator's Manual).

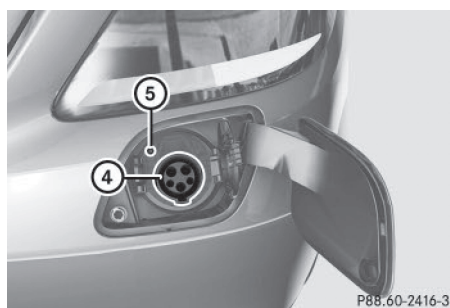
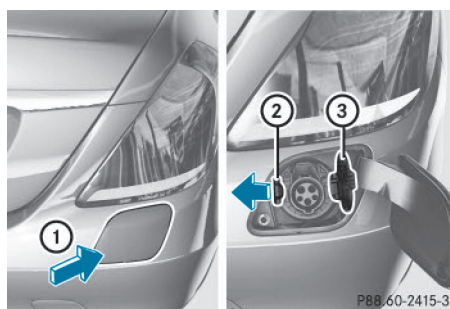
Connecting the charging cable



- ① To open the charge socket flap
 - ② Fastener
 - ③ Vehicle charge socket flap
 - ④ Vehicle socket
 - ⑤ Indicator lamp 
- ▶ Use the DIRECT SELECT lever to shift the automatic transmission to **P**.
 - ▶ Switch the ignition off.
 - ▶ Press the charge socket flap in the direction of arrow ①. The charge socket flap swings up.
 - ▶ Slide fastener ② to the right. Vehicle socket flap ③ is open.
 - ▶ Insert the power supply plug into the electrical outlet to the stop.
 - ▶ Insert the charging cable connector into vehicle socket ④ to the stop. The high-voltage battery is being charged.  indicator lamp ⑤ on vehicle socket ④ flashes slowly green.

- i** The vehicle must not be moved during charging or when the charging cable is connected.
- i** Depending on the temperature, the fan and battery cooling system may audibly switch on during the charging process.

Removing the charging cable

When the charge level display reaches 100 % in the multifunction display, the battery is fully charged.

- i** After the charging cable has been disconnected, the indicator lamp in the vehicle socket remains lit for some time before switching off.

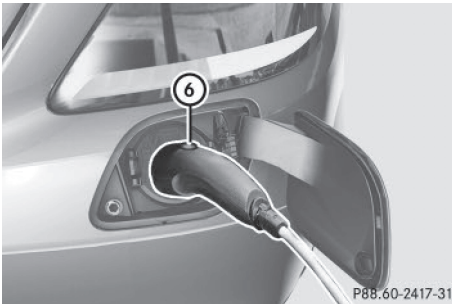

When the battery is fully charged:

- ▶ Unlock the vehicle.
 -  indicator lamp (5) on vehicle socket (4) lights up green.
- ▶ Press and hold button (6) on the charging cable connector and remove the charging cable from the vehicle socket.
- ▶ Close vehicle socket flap (3).
- ▶ Close charge socket flap (1).
- ▶ Remove the charging cable from the electrical outlet.
- ▶ Stow the charging cable safely in the vehicle (▷ page 147).

Charging the high-voltage battery from the wallbox

General notes

It is recommended that you charge your vehicle using a wallbox or at a charging station. Use the optional quick charging cable when charging at a wallbox. The charging cable is stored in a bag in the trunk.

Only use charging cables that have been tested and approved by the manufacturer for charging the high-voltage battery in an electric vehicle.

Pay attention to the "Important safety notes" (▷ page 144).

Connecting the charging cable

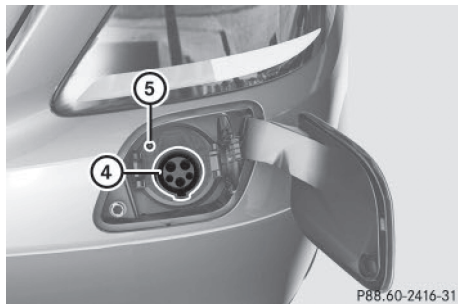
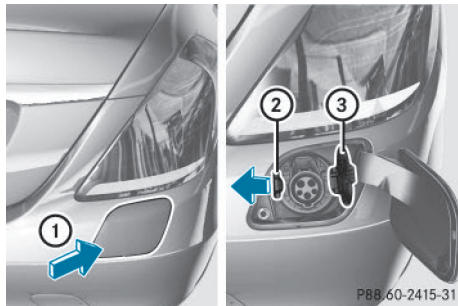

- ① To open the charge socket flap
- ② Fastener
- ③ Vehicle charge socket flap
- ④ Vehicle socket
- ⑤ Indicator lamp 

- ▶ Use the DIRECT SELECT lever to shift the automatic transmission to **P**.
- ▶ Switch the ignition off.
- ▶ Press the charge socket flap in the direction of arrow ①.
The charge socket flap swings up.
- ▶ Slide fastener ② to the right.
Vehicle socket flap ③ is open.
- ▶ Insert the charging cable connector into vehicle socket ④ to the stop.
The high-voltage battery is being charged.
 indicator lamp ⑤ on vehicle socket ④ flashes slowly green.

i The vehicle must not be moved during charging or when the charging cable is connected.

i Depending on the temperature, the fan and battery cooling system may audibly switch on during the charging process.

Removing the charging cable

When the charge level display reaches 100 % in the multifunction display, the battery is fully charged.

i After the charging cable has been disconnected, the indicator lamp in the vehicle socket remains lit for some time before switching off.



P88.60-2417-31

When the battery is fully charged:

- ▶ Unlock the vehicle.
 indicator lamp ⑤ on vehicle socket ④ lights up green.
- ▶ Press and hold button ⑥ on the charging cable connector and remove the charging cable from the vehicle socket.
- ▶ Close vehicle socket flap ③.
- ▶ Close charge socket flap ①.

Charging the high-voltage battery at the charging station

The connection for the vehicle at a charging station is identical to the connection on a wallbox. Read the "Charging a high-voltage battery at a wallbox" section (▷ page 150). Before beginning the charging process at a charging station without communication capabilities, you must first activate the station. You can do this by using an RFID card or via telephone activation. Observe the on-site operator instructions for the charging station.

Problems with the charging process

| Problem | Possible causes/consequences and ► Solutions |
|---|--|
| The charge socket flap cannot be opened. | <p>The charge socket flap is not unlocked.</p> <ul style="list-style-type: none"> ► Unlock the vehicle (▷ page 89). |
| | <p>The SmartKey batteries are discharged.</p> <ul style="list-style-type: none"> ► Unlock the vehicle manually using the SmartKey (▷ page 90). |
| | <p>The charge socket flap is unlocked, but the opening mechanism is jammed.</p> <ul style="list-style-type: none"> ► Lock and unlock the vehicle. <p>If, after that, the opening mechanism is still jammed:</p> <ul style="list-style-type: none"> ► Consult a qualified specialist workshop. |
| The high-voltage battery is not being charged. | <p>A malfunction has occurred during the initialization of the charging process.</p> <ul style="list-style-type: none"> ► Ensure that the charging cable is connected to the electrical outlet. ► Disconnect the charging cable connector from the vehicle socket and plug it back into the vehicle socket. ► If the problem persists, consult a qualified specialist workshop. |
| The high-voltage battery is not charged during the charging process when connected to a power socket. | <p>The electrical outlet is faulty.</p> <ul style="list-style-type: none"> ► Have the electrical outlet checked to test if it is functioning properly. <p>or</p> <ul style="list-style-type: none"> ► Use a different electrical outlet. |
| The charging cable connector cannot be removed from the vehicle socket. | <p>The snap fastener on the charging cable connector is locked.</p> <ul style="list-style-type: none"> ► Press and hold the button on the charging cable connector. The snap fastener on the vehicle socket is unlocked. ► Remove the charging cable connector from the vehicle socket. |
| | <p>The snap fastener on the charging cable connector is blocked.</p> <ul style="list-style-type: none"> ► Press and hold the button on the charging cable connector. ► Try to remove the blockage. |

Online access to the vehicle**General information** **WARNING**

If you operate information systems and communication equipment integrated in the vehicle while driving, you will be distracted from traffic conditions. You could also lose control of the vehicle. There is a risk of an accident.

Only operate the equipment when the traffic situation permits. If you are not sure that this is possible, park the vehicle paying attention to traffic conditions and operate the equipment when the vehicle is stationary.

- i Operation of integrated information systems and communications equipment in the vehicle:** you must observe the legal requirements for the country in which you are currently driving.

From the "My Mercedes Electric - Vehicle Homepage", you can call up remote query and remote configuration functions for your vehicle. This is possible from an Internet-enabled computer, as well as many modern smartphones.

You can access the "Vehicle Homepage" via your web browser.

Please call the Mercedes-Benz Customer Assistance Center (USA) at the hotline number

1-800-FOR-MERCEdes (1-800-367-6372) to obtain the relevant Internet address.

In order to use the "Vehicle Homepage", you must agree to the local terms of use.

The contractual periods of mbrace apply to the "Vehicle Homepage". To use the "Vehicle Homepage", you require an activated access to the mbrace emergency call system and a separate activation/registration for the "Vehicle Homepage".

More information about how to access the "Vehicle Homepage" and the terms of use are available from any authorized Mercedes-Benz Center.

The "Vehicle Homepage" is available in the following languages:

- German
- English
- French
- Italian
- Spanish
- Portuguese
- Dutch
- Chinese

Notes on data protection

Bear in mind that the "Vehicle Homepage" offers access to your data.

Therefore, look after the vehicle verification code (VVC) provided and your user details carefully.

The vehicle verification code (VVC) is required when you register for the first time on the "Vehicle Homepage". This code is used to link the vehicle and the user access on the "Vehicle Homepage" and enables correct use. If you have any questions, please contact the Mercedes-Benz Customer Assistance Center (USA) at the hotline number **1-800-FOR-MERCEdes (1-800-367-6372)**.

- i Prevent unauthorized persons from accessing this data.**

Every person who has access to the information stated can use the functions on the "Vehicle Homepage".

- i Information when selling a vehicle or buying a used vehicle:**

- If you sell your vehicle, you are obliged to delete the vehicle from your personal area on the "Vehicle Homepage". Additionally, you must destroy documents containing the vehicle verification code (VVC).
- If you have bought a used vehicle, it is possible that the previous owner still has access to the "Vehicle Homepage". If in doubt, have a new vehicle verification

code (VVC) issued by the Mercedes-Benz Center after purchase. With this new code you can set up the access to your vehicle. This is described in the "Setting up a personal area" section on the "Vehicle Homepage". There, you may also deactivate the existing access of the previous owner.

Calling up functions in the "My Mercedes Electric - Vehicle Homepage"

The "Vehicle Homepage" allows you access to vehicle information and your vehicle's functions using remote query and remote configuration.

The following functions can be accessed via the "Vehicle Homepage":

- request the current condition of charge of the high-voltage battery
- program the departure time
- set/activate the "Pre-entry climate control at departure time" function (REMOTE CLIMATE CONTROL), (see the Digital Operator's Manual)

Information on additional functions and operating instructions can be found on the "Vehicle Homepage".

Connecting the vehicle to the Internet

i This function is not available in all countries and requires activated access to the mbrace emergency call system.

i This function is only available if the vehicle is equipped with a telephone module.

You can use the "Vehicle Homepage" if the vehicle has a connection to the Internet via the telephone module. The telephone module uses CDMA (Code Division Multiple Access) and transmits the necessary data by radio. The vehicle automatically recognizes whether a connection to the Internet via the telephone module is possible or not. No presets are necessary.

i Restrictions in reception are possible if the vehicle is in an underground car park, for example. Restrictions may also occur in areas with poor mobile network coverage.

To enable the transfer of data via the telephone module, you do not need a SIM card.

Parking

Important safety notes

WARNING

Flammable material such as leaves, grass or twigs may ignite if they come into contact with hot parts of the exhaust system or exhaust gas flow. There is a risk of fire.

Park the vehicle so that no flammable materials come into contact with parts of the vehicle which are hot. Take particular care not to park on dry grassland or harvested grain fields.

WARNING

If you leave children unsupervised in the vehicle, they could set it in motion by, for example:

- release the parking brake.
- shift the automatic transmission out of the parking position **P**.
- start the engine.

In addition, they may operate vehicle equipment and become trapped. There is a risk of an accident and injury.

When leaving the vehicle, always take the SmartKey with you and lock the vehicle. Never leave children unsupervised in the vehicle.

! Always secure the vehicle correctly against rolling away. Otherwise, the vehicle or its drivetrain could be damaged.

To ensure that the vehicle is secured against rolling away unintentionally:

- the electric parking brake must be applied.
- the transmission must be in position **P** and the SmartKey must be removed from the ignition lock.

- the front wheels must be turned towards the curb on steep uphill or downhill gradients.
- the empty vehicle must be secured at the front axle with a wheel chock or similar, for example, on uphill or downhill gradients.
- a laden vehicle must also be secured at the rear axle with a wheel chock or similar, for example, on uphill or downhill gradients.

Switching off the engine

Important safety notes

WARNING

The automatic transmission switches to neutral position **N** when you switch off the engine. The vehicle may roll away. There is a risk of an accident.

After switching off the engine, always switch to parking position **P**. Prevent the parked vehicle from rolling away by applying the parking brake.

If the engine cannot be switched off as described here, see "Emergency engine cutoff" (▷ page 274).

Information in the Digital Operator's Manual

A description of how to switch off the engine can be found in the Digital Operator's Manual.

Electric parking brake

General notes

WARNING

If you leave children unsupervised in the vehicle, they could set it in motion by, for example:

- release the parking brake.
- shift the automatic transmission out of the parking position **P**.
- start the engine.

In addition, they may operate vehicle equipment and become trapped. There is a risk of an accident and injury.

When leaving the vehicle, always take the SmartKey with you and lock the vehicle. Never leave children unsupervised in the vehicle.

The function of the electric parking brake is dependent on the on-board voltage. If the on-board voltage is low or there is a malfunction in the system, it may not be possible to apply the released parking brake.

- ▶ If this is the case, only park the vehicle on level ground and secure it to prevent it rolling away.
- ▶ Shift the automatic transmission to position **P**.

It may not be possible to release an applied parking brake if the on-board voltage is low or there is a malfunction in the system. Contact a qualified specialist workshop.

The electric parking brake performs a function test at regular intervals while the engine is switched off. The sounds that can be heard while this is occurring are normal.

Information in the Digital Operator's Manual

In the Digital Operator's Manual you will find information on the following topics:

- Applying/releasing manually
- Applying automatically
- Releasing automatically
- Emergency braking

Parking the vehicle for a long period

You can find information about this in the Digital Operator's Manual.

Driving tips

General driving tips

Important safety notes

WARNING

If you switch off the ignition while driving, safety-relevant functions are only available with limitations, or not at all. This could affect, for example, the power steering and the brake boosting effect. You will require considerably more effort to steer and brake. There is a risk of an accident.

Do not switch off the ignition while driving.

WARNING

If you operate mobile communication equipment while driving, you will be distracted from traffic conditions. You could also lose control of the vehicle. There is a risk of an accident.

Only operate this equipment when the vehicle is stationary.

Observe the legal requirements for the country in which you are driving. Some jurisdictions prohibit the driver from using a mobile phone while driving a vehicle.

If you make a call while driving, always use hands-free mode. Only operate the telephone when the traffic situation permits. If you are unsure, pull over to a safe location and stop before operating the telephone.

Bear in mind that at a speed of only 30 mph (approximately 50 km/h), the vehicle covers a distance of 44 ft (approximately 14 m) per second.

Drive sensibly – save fuel

Observe the following tips to save fuel:

- ▶ The tires should always be inflated to the recommended tire pressure.
- ▶ Remove unnecessary loads.
- ▶ Remove roof racks when they are not needed.
- ▶ Warm up the engine at low engine speeds.

- ▶ Avoid frequent acceleration or braking.
- ▶ Have all maintenance work carried out as indicated by the service intervals in the Maintenance Booklet or by the service interval display.

Fuel consumption also increases when driving in cold weather, in stop-start traffic and in hilly terrain.

Drinking and driving

WARNING

Drinking and driving and/or taking drugs and driving are very dangerous combinations. Even a small amount of alcohol or drugs can affect your reflexes, perceptions and judgment.

The possibility of a serious or even fatal accident is greatly increased when you drink or take drugs and drive.

Do not drink or take drugs and drive or allow anyone to drive who has been drinking or taking drugs.

Emission control

WARNING

Combustion engines emit poisonous exhaust gases such as carbon monoxide. Inhaling these exhaust gases leads to poisoning. There is a risk of fatal injury. Therefore never leave the engine running in enclosed spaces without sufficient ventilation.

Certain engine systems are designed to keep the level of poisonous components in exhaust fumes within legal limits.

These systems only work at peak efficiency if they are serviced exactly in accordance with the manufacturer's specifications. For this reason, all work on the engine must be carried out by qualified and authorized Mercedes-Benz technicians.

The engine settings must not be changed under any circumstances. Furthermore, all specific service work must be carried out at

regular intervals and in accordance with the Mercedes-Benz service requirements. Details can be found in the Maintenance Booklet.

ECO display

You can find information about this in the Digital Operator's Manual.

Braking

Important safety notes

WARNING

If you shift down on a slippery road surface in an attempt to increase the engine's braking effect, the drive wheels could lose their grip. There is an increased danger of skidding and accidents.

Do not shift down for additional engine braking on a slippery road surface.

Downhill gradients

You can find information about this in the Digital Operator's Manual.

Heavy and light loads

WARNING

If you rest your foot on the brake pedal while driving, the braking system can overheat. This increases the stopping distance and can even cause the braking system to fail. There is a risk of an accident.

Never use the brake pedal as a footrest. Never depress the brake pedal and the accelerator pedal at the same time.

Further information can be found in the Digital Operator's Manual.

Wet roads

You can find information about this in the Digital Operator's Manual.

Limited braking performance on salt-treated roads

You can find information about this in the Digital Operator's Manual.

Servicing the brakes

You can find information about this in the Digital Operator's Manual.

AMG high-performance and ceramic brakes

You can find information about this in the Digital Operator's Manual.

Driving on wet roads

Information in the Digital Operator's Manual

In the Digital Operator's Manual you will find information on the following topics:

- Hydroplaning
- Driving on flooded roads

Winter driving

WARNING

If you shift down on a slippery road surface in an attempt to increase the engine's braking effect, the drive wheels could lose their grip. There is an increased danger of skidding and accidents.

Do not shift down for additional engine braking on a slippery road surface.

DANGER

If the exhaust pipe is blocked or adequate ventilation is not possible, poisonous gases such as carbon monoxide (CO) may enter the vehicle. This is the case, e.g. if the vehicle becomes trapped in snow. There is a risk of fatal injury.

If you leave the engine or the auxiliary heating running, make sure the exhaust pipe and area

around the vehicle are clear of snow. To ensure an adequate supply of fresh air, open a window on the side of the vehicle that is not facing into the wind.

Further information can be found in the Digital Operator's Manual.

Driving systems

Mercedes-Benz Intelligent Drive

Mercedes-Benz Intelligent Drive stands for innovative driver assistance and safety systems which enhance comfort and support the driver in critical situations. With these intelligent co-ordinated systems Mercedes-Benz has set a milestone on the path towards autonomous driving.

Mercedes-Benz Intelligent Drive embraces all elements of active and passive safety in one well thought out system – for the safety of the vehicle occupants and that of other road users.

Further information on driving safety systems (▷ page 74).

Cruise control

General notes

Cruise control maintains a constant road speed for you. It brakes automatically in order to avoid exceeding the set speed. Change into a lower gear in good time on long and steep downhill gradients. This is especially important if the vehicle is laden. By doing so, you will make use of the braking effect of the engine. This relieves the load on the brake system and prevents the brakes from overheating and wearing too quickly.

Use cruise control only if road and traffic conditions make it appropriate to maintain a steady speed for a prolonged period. You can store any road speed above 20 mph (30 km/h).

Important safety notes

If you fail to adapt your driving style, cruise control can neither reduce the risk of an accident nor override the laws of physics. Cruise control cannot take into account the road, traffic and weather conditions. Cruise control is only an aid. You are responsible for the distance to the vehicle in front, for vehicle speed, for braking in good time and for staying in your lane.

Do not use cruise control:

- in road and traffic conditions which do not allow you to maintain a constant speed e.g. in heavy traffic or on winding roads
- on slippery road surfaces. Braking or accelerating could cause the drive wheels to lose traction and the vehicle could then skid
- when there is poor visibility, e.g. due to fog, heavy rain or snow

If there is a change of drivers, advise the new driver of the speed stored.

WARNING

If you call up the stored speed and it differs from the current speed, the vehicle accelerates or decelerates. If you do not know the stored speed, the vehicle could accelerate or brake unexpectedly. There is a risk of an accident.

Pay attention to the road and traffic conditions before calling up the stored speed. If you do not know the stored speed, store the desired speed again.

Cruise control lever

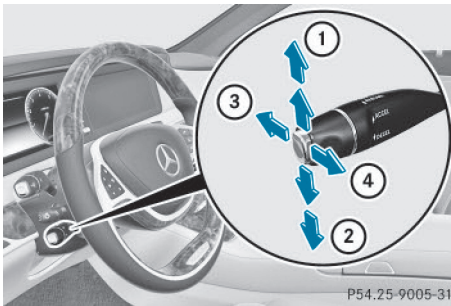

- ① To activate or increase speed
- ② To activate or reduce speed
- ③ To deactivate cruise control
- ④ To activate at the current speed/last stored speed

When you activate cruise control, the stored speed is shown in the multifunction display for five seconds. In the speedometer, the segments between the stored speed and the maximum speed light up.

Information in the Digital Operator's Manual

In the Digital Operator's Manual you will find information on the following topics:

- Activation conditions
- Storing, maintaining and calling up a speed
- Setting a speed
- Deactivating cruise control

DISTRONIC PLUS

General notes

DISTRONIC PLUS regulates the speed and automatically helps you maintain the distance to the vehicle detected in front. Vehicles are detected with the aid of the radar sensor system. DISTRONIC PLUS brakes automatically so that the set speed is not exceeded.

Change into a lower gear in good time on long and steep downhill gradients. This is espe-

cially important if the vehicle is laden. By doing so, you will make use of the braking effect of the engine. This relieves the load on the brake system and prevents the brakes from overheating and wearing too quickly.

If DISTRONIC PLUS detects that there is a risk of a collision, you will be warned visually and acoustically. DISTRONIC PLUS cannot prevent a collision without your intervention. An intermittent warning tone will then sound and the distance warning lamp will light up in the instrument cluster. Brake immediately in order to increase the distance to the vehicle in front or take evasive action provided it is safe to do so.

DISTRONIC PLUS operates in range between 0 mph (0 km/h) and 120 mph (200 km/h).

Do not use DISTRONIC PLUS while driving on roads with steep gradients.

As DISTRONIC PLUS transmits radar waves, it can resemble the radar detectors of the responsible authorities. You can refer to the relevant chapter in the Operator's Manual if questions are asked about this.

i USA only: This device has been approved by the FCC as a "Vehicular Radar System". The radar sensor is intended for use in an automotive radar system only. Removal, tampering, or altering of the device will void any warranties, and is not permitted by the FCC. Do not tamper with, alter, or use in any non-approved way.

Any unauthorized modification to this device could void the user's authority to operate the equipment.

i Canada only: This device complies with RSS-210 of Industry Canada. Operation is subject to the following two conditions:

1. This device may not cause harmful interference, and
2. This device must accept any interference received, including interference that may cause undesired operation of the device.

Removal, tampering, or altering of the device will void any warranties, and is not

permitted. Do not tamper with, alter, or use in any non-approved way.

Any unauthorized modification to this device could void the user's authority to operate the equipment.

Important safety notes

WARNING

DISTRONIC PLUS does not react to:

- people or animals
- stationary obstacles on the road, e.g. stopped or parked vehicles
- oncoming and crossing traffic

As a result, DISTRONIC PLUS may neither give warnings nor intervene in such situations. There is a risk of an accident.

Always pay careful attention to the traffic situation and be ready to brake.

WARNING

DISTRONIC PLUS cannot always clearly identify other road users and complex traffic situations.

In such cases, DISTRONIC PLUS may:

- give an unnecessary warning and then brake the vehicle
- neither give a warning nor intervene
- accelerate or brake unexpectedly

There is a risk of an accident.

Continue to drive carefully and be ready to brake, in particular when warned to do so by DISTRONIC PLUS.

WARNING

DISTRONIC PLUS brakes your vehicle with up to 50% of the maximum possible deceleration. If this braking force is insufficient, DISTRONIC PLUS warns you visually and audibly. There is a risk of an accident.

In such cases, apply the brakes yourself and try to take evasive action.

! If DISTRONIC PLUS or the HOLD function is activated, the vehicle brakes automatically in certain situations. To prevent damage to the vehicle, deactivate DISTRONIC PLUS and the HOLD function in the following or other similar situations:

- when towing the vehicle
- in the car wash

If you fail to adapt your driving style, DISTRONIC PLUS can neither reduce the risk of accident nor override the laws of physics. DISTRONIC PLUS cannot take into account the road, traffic and weather conditions. DISTRONIC PLUS is only an aid. You are responsible for the distance to the vehicle in front, for vehicle speed, for braking in good time and for staying in your lane.

Do not use DISTRONIC PLUS:

- in road and traffic conditions which do not allow you to maintain a constant speed e.g. in heavy traffic or on winding roads
- on slippery road surfaces. Braking or accelerating could cause the drive wheels to lose traction and the vehicle could then skid
- when there is poor visibility, e.g. due to fog, heavy rain or snow

DISTRONIC PLUS may not detect narrow vehicles driving in front, e.g. motorcycles, or vehicles driving on a different line.

In particular, the detection of obstacles can be impaired if:

- there is dirt on the sensors or anything else covering the sensors
- there is snow or heavy rain
- there is interference by other radar sources
- there are strong radar reflections, for example, in parking garages

If DISTRONIC PLUS no longer detects a vehicle in front, DISTRONIC PLUS may unexpectedly accelerate the vehicle to the stored speed.

This speed may:

- be too high if you are driving in a filter lane or an exit lane
- be so high in the right lane that you pass vehicles driving on the left (left-hand drive countries)
- be so high in the left lane that you pass vehicles driving on the right (right-hand drive countries)

If there is a change of drivers, advise the new driver of the speed stored.

Cruise control lever

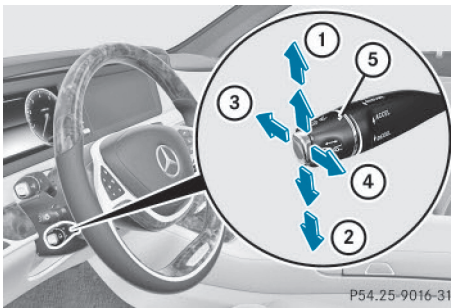

- ① To activate or increase speed
- ② To activate or reduce speed
- ③ To deactivate DISTRONIC PLUS
- ④ To activate at the current speed/last stored speed
- ⑤ To set the specified minimum distance

Activating DISTRONIC PLUS

Activation conditions

In order to activate DISTRONIC PLUS, the following conditions must be fulfilled:

- the engine must be started. It may take up to two minutes after pulling away before DISTRONIC PLUS is operational.
- the electric parking brake must be released.
- ESP® must be active, but not intervening.
- Active Parking Assist must not be activated.
- the transmission must be in position **D**.

- the driver's door must be closed when you shift from **P** to **D** or your seat belt must be fastened.
- the front-passenger door and rear doors must be closed.

Switching on

- ▶ Briefly pull the cruise control lever towards you ④ or press it up ① or down ②. DISTRONIC PLUS is selected.

- ▶ **To adjust the set speed in 1 mph increments (1 km/h increments):** briefly press the cruise control lever up ① to the pressure point for a higher speed, or down ② for a lower speed.

Every time the cruise control lever is pressed up or down, the last speed stored is increased or reduced.

or

- ▶ **To adjust the set speed in 5 mph increments (10 km/h increments):** briefly press the cruise control lever up ① past the pressure point for a higher speed, or down ② for a lower speed.

Every time the cruise control lever is pressed up or down, the last speed stored is increased or reduced.

- ▶ Remove your foot from the accelerator pedal. Your vehicle adapts its speed to that of the vehicle in front, but only up to the desired stored speed.

- ❗ If you do not fully release the accelerator pedal, the **DISTRONIC PLUS Passive** message appears in the multifunction display. The set distance to a slower-moving vehicle in front will then not be maintained. You will be driving at the speed you determine by the position of the accelerator pedal.

You can also activate DISTRONIC PLUS when stationary. The lowest speed that can be set is 20 mph (30 km/h).

- ▶ Briefly pull the cruise control lever towards you ④ or press it up ① or down ②. DISTRONIC PLUS is selected.

Activating at the current speed/last stored speed

WARNING

If you call up the stored speed and it differs from the current speed, the vehicle accelerates or decelerates. If you do not know the stored speed, the vehicle could accelerate or brake unexpectedly. There is a risk of an accident.

Pay attention to the road and traffic conditions before calling up the stored speed. If you do not know the stored speed, store the desired speed again.

- ▶ Briefly pull the cruise control lever towards you .
- ▶ Remove your foot from the accelerator pedal.
DISTRONIC PLUS is activated. The first time it is activated, the current speed is stored. Otherwise, it sets the vehicle cruise speed to the previously stored value.

Driving with DISTRONIC PLUS

Pulling away and driving

- ▶ **If you want to pull away with DISTRONIC PLUS:** remove your foot from the brake pedal.
 - ▶ Briefly pull the cruise control lever towards you .
- or
- ▶ Accelerate briefly.
Your vehicle pulls away and adapts its speed to that of the vehicle in front. If no vehicle is detected in front, your vehicle accelerates to the set speed.

The vehicle can also pull away when it is facing an unidentified obstacle or is driving on a different line from another vehicle. The vehicle then brakes automatically. Be ready to brake at all times.

If there is no vehicle in front, DISTRONIC PLUS operates in the same way as cruise control.

If DISTRONIC PLUS detects that the vehicle in front has slowed down, it brakes your vehicle. In this way, the distance you have selected is maintained.

If DISTRONIC PLUS detects a faster-moving vehicle in front, it increases the driving speed. However, the vehicle is only accelerated up to the speed you have stored.

Selects the drive program

All vehicles (except AMG vehicles):

DISTRONIC PLUS supports a sporty driving style when you select the **S** drive program (> page 139). Acceleration behind the vehicle in front or to the set speed is then noticeably more dynamic. If you have selected the **E** driving program, the vehicle accelerates more gently. This setting is recommended in stop-and-start traffic.

AMG vehicles: DISTRONIC Plus supports a sporty driving style when you select the **S** or **M** drive program (> page 139). Acceleration behind the vehicle in front or to the set speed is then noticeably more dynamic. When you select the **C** drive program, the vehicle accelerates more gently. This setting is recommended in stop-and-start traffic.

Changing lanes

If you change to the passing lane, DISTRONIC PLUS supports you when:

- you are driving faster than 45 mph (70 km/h)
- you switch on the appropriate turn signal
- DISTRONIC PLUS does not detect a danger of collision

If these conditions are fulfilled, your vehicle is accelerated. Acceleration will be interrupted if changing lanes takes too long or if the distance between your vehicle and the vehicle in front becomes too small.

-  When changing lanes, DISTRONIC PLUS monitors the left lane on left-hand drive vehicles and the right lane on right-hand drive vehicles.

Stopping

WARNING

When leaving the vehicle, even if it is braked only by DISTRONIC PLUS, it could roll away if:

- there is a malfunction in the system or in the voltage supply.
- DISTRONIC PLUS has been deactivated with the cruise control lever, e.g. by a vehicle occupant or from outside the vehicle.
- the electrical system in the engine compartment, the battery or the fuses have been tampered with.
- the battery is disconnected.
- the accelerator pedal has been depressed, e.g. by a vehicle occupant.

There is a risk of an accident.

If you wish to exit the vehicle, always turn off DISTRONIC PLUS and secure the vehicle against rolling away.

For further information on deactivating DISTRONIC PLUS (▷ page 163).

If DISTRONIC PLUS detects that the vehicle in front is stopping, it brakes your vehicle until it is stationary.

Once your vehicle is stationary, it remains stationary and you do not need to depress the brake.

After a time, the electric parking brake secures the vehicle and relieves the service brake.

Depending on the specified minimum distance, your vehicle will come to a standstill at a sufficient distance behind the vehicle in front. The specified minimum distance is set using the control on the cruise control lever.

When the HOLD function is activated, the transmission is shifted automatically to position **P** if:

- the driver's seat belt is not fastened and the driver's door is open.
- the engine is switched off, unless it is automatically switched off by the ECO start/stop function.

The electric parking brake secures the vehicle automatically if DISTRONIC PLUS is activated when the vehicle is stationary and:

- a system malfunction occurs.
- the power supply is not sufficient.

If a malfunction in the electric parking brake occurs, then the transmission may also be shifted into position **P** automatically.

Information in the Digital Operator's Manual

In the Digital Operator's Manual you will find information on the following topics:

- Setting a speed
- Setting the specified minimum distance
- DISTRONIC PLUS displays in the instrument cluster

Deactivating DISTRONIC PLUS

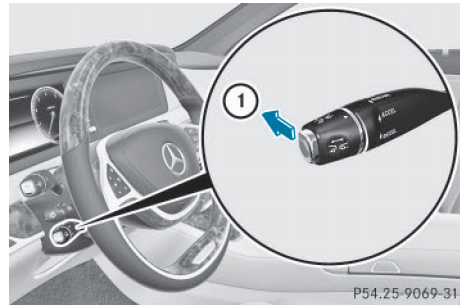

There are several ways to deactivate DISTRONIC PLUS:

- ▶ Briefly press the cruise control lever forwards ①

or

- ▶ Brake, unless the vehicle is stationary

When you deactivate DISTRONIC PLUS, you will see the **DISTRONIC PLUS Off** message in the multifunction display for approximately five seconds.

- ① The last speed stored remains stored until you switch off the engine.

- ❗ DISTRONIC PLUS is not deactivated if you depress the accelerator pedal.

DISTRONIC PLUS is automatically deactivated if:

- you engage the electric parking brake or if the vehicle is automatically secured with the electric parking brake
- ESP® intervenes or you deactivate ESP®
- the transmission is in the **P**, **R** or **N** position
- you pull the cruise control lever towards you in order to pull away and the front-passenger door or one of the rear doors is open
- the vehicle has skidded
- you activate Active Parking Assist

If DISTRONIC PLUS is deactivated, you will hear a warning tone. You will see the **DISTRONIC PLUS Off** message in the multi-function display for approximately five seconds.

Tips for driving with DISTRONIC PLUS

General notes

Pay particular attention in the following traffic situations:

- Cornering, going into and coming out of a bend
- Vehicles traveling on a different line
- Other vehicles changing lanes
- Narrow vehicles
- Obstructions and stationary vehicles
- Crossing vehicles

In such situations, brake if necessary. DISTRONIC PLUS is then deactivated.

Cornering, going into and coming out of a bend

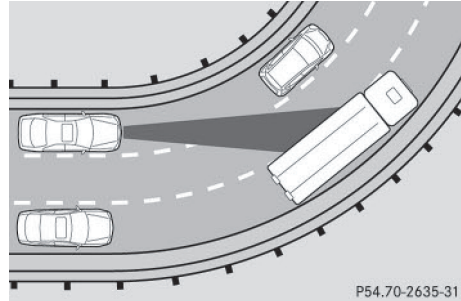

The ability of DISTRONIC PLUS to detect vehicles when cornering is limited. Your vehicle may brake unexpectedly or late.

Vehicles traveling on a different line

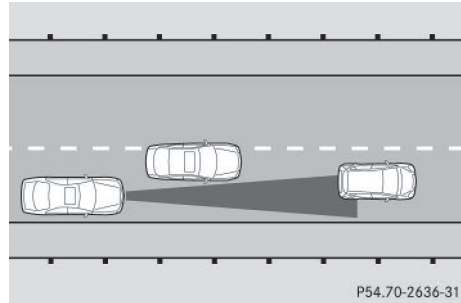

DISTRONIC PLUS may not detect vehicles traveling on a different line. The distance to the vehicle in front will be too short.

Other vehicles changing lanes

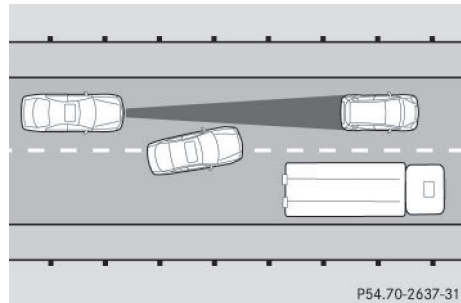

DISTRONIC PLUS has not detected the vehicle cutting in yet. The distance to this vehicle will be too short.

Narrow vehicles

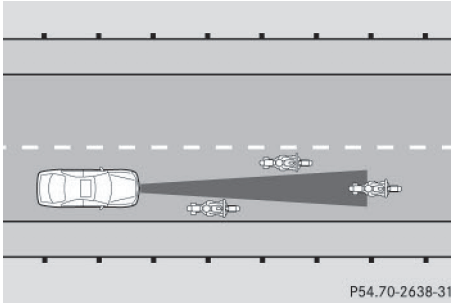

DISTRONIC PLUS has not yet detected the vehicle in front on the edge of the road, because of its narrow width. The distance to the vehicle in front will be too short.

Obstructions and stationary vehicles

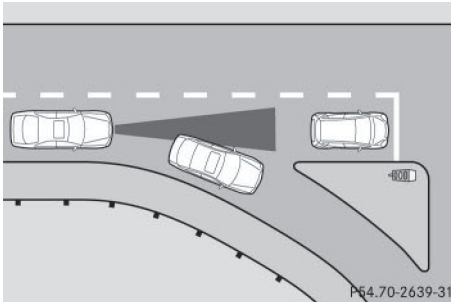

DISTRONIC PLUS does not brake for obstacles or stationary vehicles. If, for example, the detected vehicle turns a corner and reveals an obstacle or stationary vehicle, DISTRONIC PLUS will not brake for these.

Crossing vehicles

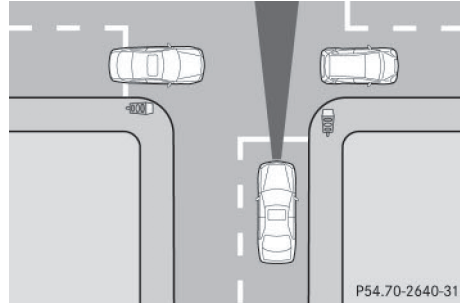

DISTRONIC PLUS may mistakenly detect vehicles that are crossing your lane. Activating DISTRONIC PLUS at traffic lights with crossing traffic, for example, could cause your vehicle to pull away unintentionally.

DISTRONIC PLUS with Steering Assist and Stop&Go Pilot

General notes

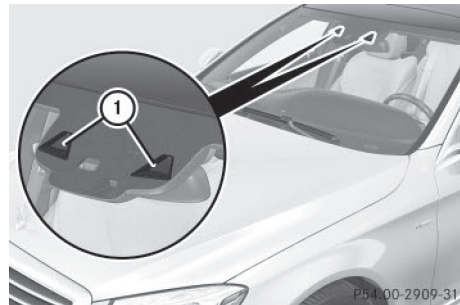

DISTRONIC PLUS with Steering Assist and Stop&Go Pilot aids you in keeping the vehicle in the center of the driving lane by means of moderate steering interventions at speeds of 0 - 125 mph (0 - 200 km/h).

It monitors the area in front of your vehicle by means of camera system ① at the top of the windshield.

At speeds of 0 - 37 mph (0 - 60 km/h), Stop&Go Pilot focuses on the vehicle in front, taking into account lane markings, e.g. when following vehicles in a traffic jam.

At speeds of more than 37 mph (60 km/h) Steering Assist focuses on detected lane

markings (left and right), and only on the vehicle in front if lane markings are missing.

Steering Assist and Stop&Go Pilot do not provide any support if these conditions do not exist.

DISTRONIC PLUS must be active in order for the function to be available.

Important safety notes

If you fail to adapt your driving style, DISTRONIC PLUS with Steering Assist and Stop&Go Pilot can neither reduce the risk of an accident nor override the laws of physics. It cannot take account of road, weather and traffic conditions. DISTRONIC PLUS with Steering Assist and Stop&Go Pilot is only an aid. You are responsible for the distance to the vehicle in front, for vehicle speed, for braking in good time and for staying in your lane.

DISTRONIC PLUS with Steering Assist and Stop&Go Pilot does not detect road and traffic conditions. If you are following a vehicle which is driving towards the edge of the road, your vehicle could come into contact with the curb or other road boundaries. Be particularly aware of other road users, e.g. cyclists, that are directly next to your vehicle.

Obstacles such as building site huts on the lane or projecting out into the lane are not detected.

An inappropriate steering intervention, e.g. after intentionally driving over a lane marking, can be corrected at any time if you steer slightly in the opposite direction.

DISTRONIC PLUS with Steering Assist and Stop&Go Pilot cannot continuously keep your vehicle in lane. In some cases, the steering intervention is not sufficient to bring the vehicle back to the lane. In such cases, you must steer the vehicle yourself to ensure that it does not leave the lane.

The support provided by the system can be impaired if:

- there is poor visibility, e.g. due to insufficient illumination of the road, or due to snow, rain, fog or spray
- there is glare, e.g. from oncoming traffic, the sun or reflections (e.g. when the road surface is wet)
- the windshield is dirty, fogged up, damaged or covered, for instance by a sticker, in the vicinity of the camera
- there are no, several or unclear lane markings for a lane, e.g. in areas with road construction work
- the lane markings are worn away, dark or covered up, e.g. by dirt or snow
- the distance to the vehicle in front is too small and the lane markings thus cannot be detected
- the lane markings change quickly, e.g. lanes branch off, cross one another or merge
- the road is narrow and winding
- there are strong shadows cast on the road

The system is switched to passive and no longer assists you by performing steering interventions if:

- you actively change lane
- you switch on the turn signal
- take your hands off the steering wheel or do not steer for a prolonged period of time

i Steering Assist and Stop&Go Pilot are activated again automatically after a lane change is completed.

Steering Assist and Stop&Go Pilot do not provide any support:

- on very sharp corners
- when a loss of tire pressure or a defective tire has been detected and displayed

Pay attention also to the important safety notes for DISTRONIC PLUS (▷ page 160).

The steering interventions are carried out with a limited steering moment. The system

requires the driver to keep his hands on the steering wheel and to steer himself.

If you do not steer yourself or if you take your hands off the steering wheel for a prolonged period of time, the system will first alert you with a visual warning. A steering wheel symbol appears in the multifunction display. If you have still not started to steer and have not taken hold of the steering wheel after five seconds at the latest, a warning tone also sounds to remind you to take control of the vehicle. Steering Assist and Stop&Go Pilot are switched to passive. DISTRONIC PLUS remains active.

Activating Steering Assist and Stop&Go Pilot

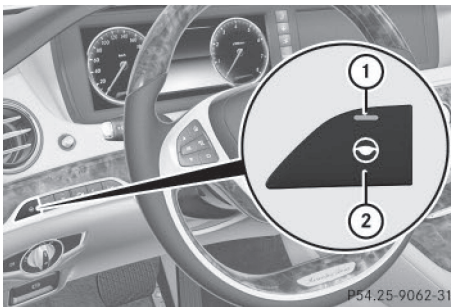

- ▶ Press button ②. Indicator lamp ① lights up. The **DTR+: Steering Assist. On** message appears in the multifunction display. Steering Assist and Stop&Go Pilot are activated.

Information in the multifunction display

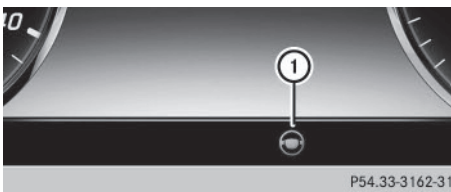

If Steering Assist and Stop&Go Pilot are activated but not ready for a steering intervention, steering wheel symbol ① appears in gray. If the system provides you with support

by means of steering interventions, symbol ① is shown in green.

Deactivating Steering Assist and Stop&Go Pilot

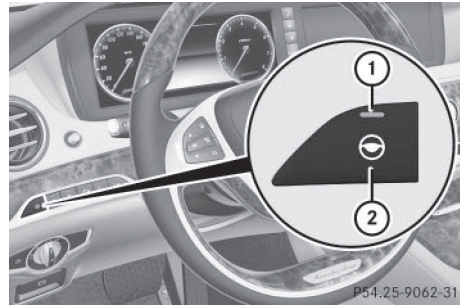

- ▶ Press button ②. Indicator lamp ① goes out. The **DTR+: Steering Assist. Off** message appears in the multifunction display. Steering Assist and Stop&Go Pilot are deactivated.

When DISTRONIC PLUS is deactivated or not available, Steering Assist and Stop&Go Pilot are deactivated automatically.

HOLD function

General notes

The HOLD function can assist the driver in the following situations:

- when pulling away, especially on steep slopes
- when maneuvering on steep slopes
- when waiting in traffic

The vehicle is kept stationary without the driver having to depress the brake pedal.

The braking effect is canceled and the HOLD function deactivated when you depress the accelerator pedal to pull away.

Important safety notes

WARNING

When leaving the vehicle, it can still roll away despite being braked by the HOLD function if:

- there is a malfunction in the system or in the voltage supply.
- the HOLD function has been deactivated by pressing the accelerator pedal or the brake pedal, e.g. by a vehicle occupant.
- the electrical system in the engine compartment, the battery or the fuses have been tampered with.
- the battery is disconnected

There is a risk of an accident.

If you wish to exit the vehicle, always turn off the HOLD function and secure the vehicle against rolling away.

Further information on deactivating the HOLD function (▷ page 168).

! If DISTRONIC PLUS or the HOLD function is activated, the vehicle brakes automatically in certain situations. To prevent damage to the vehicle, deactivate DISTRONIC PLUS and the HOLD function in the following or other similar situations:

- when towing the vehicle
- in the car wash

Activation conditions

You can activate the HOLD function if all of the following conditions are fulfilled:

- the vehicle is stationary.
- the engine is running or if it has been automatically switched off by the ECO start/stop function.
- the driver's door is closed or your seat belt is fastened.
- the electric parking brake is released.
- the transmission is in position **D**, **R** or **N**.
- DISTRONIC PLUS is deactivated.

Activating the HOLD function



- ▶ Make sure that the activation conditions are met.
- ▶ Depress the brake pedal.
- ▶ Quickly depress the brake pedal further until ① appears in the multifunction display. The HOLD function is activated. You can release the brake pedal.

i If depressing the brake pedal the first time does not activate the HOLD function, wait briefly and then try again.

Deactivating the HOLD function

The HOLD function is deactivated automatically if:

- you accelerate and the transmission is in position **D** or **R**.
- you shift the transmission to position **P**.
- you depress the brake pedal again with a certain amount of pressure until **HOLD** disappears from the multifunction display.
- you secure the vehicle using the electric parking brake.
- you activate DISTRONIC PLUS.

i After a time, the electric parking brake secures the vehicle and relieves the service brake. The HOLD function is then deactivated.

When the HOLD function is activated, the transmission is shifted automatically to position **P** if:

- the driver's seat belt is not fastened and the driver's door is open
- the engine is switched off, unless it is automatically switched off by the ECO start/stop function

The electric parking brake secures the vehicle automatically if DISTRONIC PLUS is activated when the vehicle is stationary and:

- a system malfunction occurs.
- the power supply is not sufficient.

If a malfunction in the electric parking brake occurs, then the transmission may also be shifted into position **P** automatically.

Magic Body Control

General notes

MAGIC BODY CONTROL consists of Active Body Control (ABC), ROAD SURFACE SCAN as well as automatic vehicle stabilization in the event of a crosswind.

Your vehicle automatically adjusts its ride height to improve driving safety and reduce fuel consumption. The suspension mode is adjusted according to your selection (sports or comfort), the road surface conditions and the vehicle load. A multifunction camera detects bumps in the road surface before the vehicle drives over them. This reduces chassis movements.

Important safety notes

WARNING

When the vehicle is being lowered, people could become trapped if their limbs are between the vehicle body and the wheels or underneath the vehicle. There is a risk of injury.

Make sure no one is underneath the vehicle or in the immediate vicinity of the wheel arches when the vehicle is being lowered.

- ❗ The vehicle is lowered when the engine is switched off. When parking, position your vehicle so that it does not make contact with the curb as the vehicle is lowered. Your vehicle could otherwise be damaged.

Information in the Digital Operator's Manual

In the Digital Operator's Manual you can find information about:

- Crosswind driving assistance
- Active Body Control (ABC)
- ROAD SURFACE SCAN

AIRMATIC

General notes

AIRMATIC is an air suspension with variable damping for improved driving comfort. All-round level control ensures the best possible suspension and constant ground clearance, even with a laden vehicle. When you drive fast, the vehicle is lowered automatically to improve driving safety and to reduce fuel consumption. There is also the option to manually adjust the vehicle level. AIRMATIC consists of level setting, level control and the Adaptive Damping System ADS PLUS.

Important safety notes

WARNING

When the vehicle is being lowered, people could become trapped if their limbs are between the vehicle body and the wheels or underneath the vehicle. There is a risk of injury.

Make sure no one is underneath the vehicle or in the immediate vicinity of the wheel arches when the vehicle is being lowered.

Vehicle level

Setting the raised vehicle level

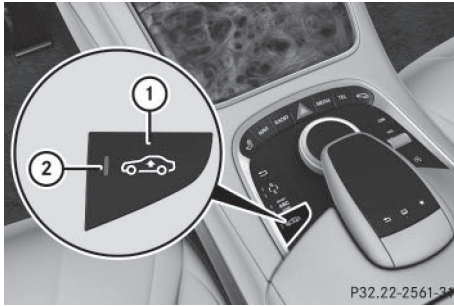

It is possible to choose between the "Normal" and "Raised" vehicle levels. Select the "Normal" setting for normal road surfaces and "Raised" for driving with snow chains or on particularly poor road surfaces. Your selection remains stored even if you remove the SmartKey from the ignition lock.

- ▶ Start the engine.

If indicator lamp ② is not lit:

- ▶ Press button ①.
Indicator lamp ② lights up. The vehicle is raised by 1.0 in (25 mm) compared to the normal level.

The **Vehicle Rising** message appears in the multifunction display.

- i** The message disappears after ten seconds, irrespective of the level reached. If necessary, the vehicle is raised further.

The "Raised level" setting is canceled if you:

- drive at a speed over approximately 75 mph (120 km/h)
- drive for approximately three minutes at a speed over 50 mph (80 km/h)

Setting the normal vehicle level

- ▶ Start the engine.

If indicator lamp ② is lit:

- ▶ Press button ①.
Indicator lamp ② goes out. The vehicle is adjusted to normal level.

Suspension tuning

In the Digital Operator's Manual you can find information about:

- General notes
- Sports tuning
- Comfort tuning

4MATIC (permanent four-wheel drive)

4MATIC ensures that all four wheels are permanently driven. Together with ESP[®], it improves the traction of your vehicle whenever a drive wheel spins due to insufficient grip.

If you fail to adapt your driving style, 4MATIC can neither reduce the risk of accident nor override the laws of physics. 4MATIC cannot take account of road, weather and traffic conditions. 4MATIC is only an aid. You are responsible for the distance to the vehicle in front, for vehicle speed, for braking in good time and for staying in your lane.

If a drive wheel spins due to insufficient grip:

- Only depress the accelerator pedal as far as necessary when pulling away.
- Accelerate less when driving.

! Never tow the vehicle with one axle raised. This may damage the transfer case. Damage of this sort is not covered by the Mercedes-Benz Limited Warranty. All wheels must remain either on the ground or be fully raised. Observe the instructions for towing the vehicle with all wheels in full contact with the ground.

- i** In wintry driving conditions, the maximum effect of 4MATIC can only be achieved if you use winter tires (M+S tires), with snow chains if necessary.

PARKTRONIC

Important safety notes

PARKTRONIC is an electronic parking aid with ultrasonic sensors. It monitors the area around your vehicle using six sensors in the front bumper and six sensors in the rear bumper. PARKTRONIC indicates visually and audibly the distance between your vehicle and an object.

PARKTRONIC is only an aid. It is not a replacement for your attention to your immediate surroundings. You are always responsible for safe maneuvering, parking and exiting a parking space. When maneuvering, parking or pulling out of a parking space, make sure that there are no persons, animals or objects in the area in which you are maneuvering.

! When parking, pay particular attention to objects above or below the sensors, such as flower pots or trailer drawbars. PARKTRONIC does not detect such objects when they are in the immediate vicinity of the vehicle. You could damage the vehicle or the objects.

The sensors may not detect snow and other objects that absorb ultrasonic waves.

Ultrasonic sources such as an automatic car wash, the compressed-air brakes on a truck or a pneumatic drill could cause PARKTRONIC to malfunction.

PARKTRONIC may not function correctly on uneven terrain.

PARKTRONIC is activated automatically when you:

- switch on the ignition
- shift the transmission to position **D**, **R** or **N**

PARKTRONIC is deactivated at speeds above 11 mph (18 km/h). It is reactivated at lower speeds.

Range of the sensors

General notes

PARKTRONIC does not take objects into consideration that are:

- below the detection range, e.g. people, animals or objects.
- above the detection range, e.g. overhanging loads, truck overhangs or loading ramps.

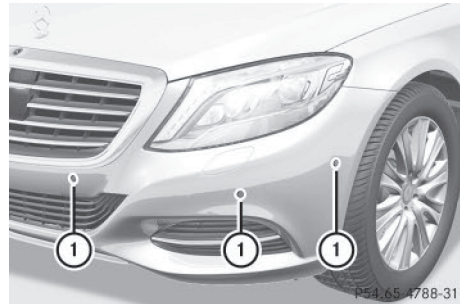

① Sensors in the front bumper, left-hand side (example)

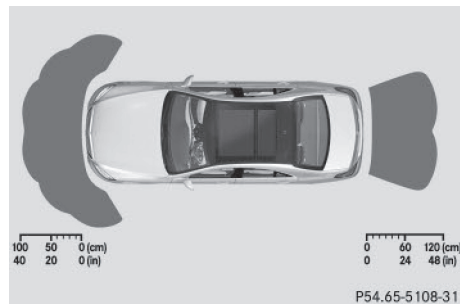
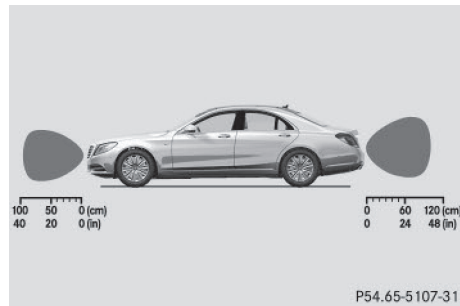

The sensors must be free from dirt, ice or slush. They can otherwise not function cor-

rectly. Clean the sensors regularly, taking care not to scratch or damage them (▷ page 253).

Front sensors

| | |
|---------|--------------------------------|
| Center | Approx. 40 in (approx. 100 cm) |
| Corners | Approx. 24 in (approx. 60 cm) |

Rear sensors

| | |
|---------|--------------------------------|
| Center | Approx. 48 in (approx. 120 cm) |
| Corners | Approx. 32 in (approx. 80 cm) |

Minimum distance

| | |
|---------|------------------------------|
| Center | Approx. 8 in (approx. 20 cm) |
| Corners | Approx. 6 in (approx. 15 cm) |

If there is an obstacle within this range, the relevant warning displays light up and a warning tone sounds. If the distance falls below the minimum, the distance may no longer be shown.

Information in the Digital Operator's Manual

In the Digital Operator's Manual you will find information on the following topics:

- Warning displays
- Deactivating/activating PARKTRONIC
- Problems with PARKTRONIC

Active Parking Assist

General notes

Active Parking Assist is an electronic parking aid with ultrasound. It measures the road on both sides of the vehicle. A parking symbol

indicates a suitable parking space. Active steering intervention and brake application can assist you during parking and when exiting a parking space. You may also use PARKTRONIC (▷ page 171).

Important safety notes

Active Parking Assist is merely an aid. It is not a replacement for your attention to your immediate surroundings. You are always responsible for safe maneuvering, parking and exiting a parking space. Make sure that no persons, animals or objects are in the maneuvering range.

When PARKTRONIC is switched off, Active Parking Assist is also unavailable.

WARNING

If there are objects above the detection range:

- Active Park Assist may steer too early
- the vehicle may not stop in front of these objects.

You may cause a collision as a result. There is a risk of an accident.

If there are objects above the detection range, stop and deactivate Active Parking Assist.

WARNING

While parking or pulling out of a parking space, the vehicle swings out and can drive onto areas of the oncoming lane. This could result in a collision with another road user. There is a risk of an accident.

Pay attention to other road users. Stop the vehicle if necessary or cancel the Active Parking Assist parking procedure.

- ❗ If unavoidable, you should drive over obstacles such as curbs slowly and not at a sharp angle. Otherwise, you may damage the wheels or tires.

Active Parking Assist may possibly indicate parking spaces which are not suitable for parking, for example:

- where parking or stopping is prohibited
- in front of driveways or entrances and exits
- on unsuitable surfaces

Parking tips:

- On narrow roads, drive as close to the parking space as possible.
- Parking spaces that are littered or overgrown might be identified or measured incorrectly.
- Parking spaces that are partially occupied by trailer drawbars might not be identified as such or be measured incorrectly.
- Snowfall or heavy rain may lead to a parking space being measured inaccurately.
- Pay attention to the PARKTRONIC (▷ page 172) warning messages during the parking procedure.
- You can intervene in the steering procedure to correct it at any time. Active Parking Assist will then be canceled.
- When transporting a load which protrudes from your vehicle, you should not use Active Parking Assist.
- Never use Active Parking Assist when snow chains are installed.
- Make sure that the tire pressures are always correct. This has a direct influence on the parking characteristics of the vehicle.

Use Active Parking Assist for parking spaces:

- parallel or at right angles to the direction of travel
- that are on straight roads, not bends
- that are on the same level as the road, e.g. not on the pavement

Information in the Digital Operator's Manual

In the Digital Operator's Manual you will find information on the following topics:

- Detecting parking spaces
- Parking
- Exiting a parking space
- Canceling Active Parking Assist

Rear view camera

General notes

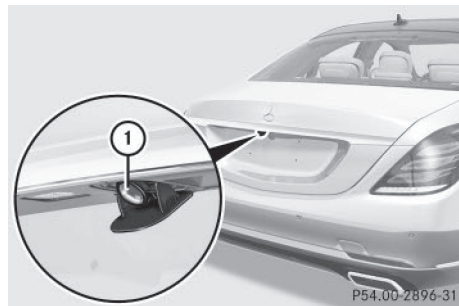

Rear view camera ① is in the trunk lid handle.

Rear view camera ① is an optical parking and maneuvering aid. It shows the area behind your vehicle with guide lines in the COMAND display.

The area behind the vehicle is displayed as a mirror image, as in the rear view mirror.

i The text of messages shown in the COMAND display depends on the language setting. The following are examples of rear view camera messages in the COMAND display.

Important safety notes

The rear view camera is only an aid. It is not a replacement for your attention to your immediate surroundings. You are always responsible for safe maneuvering and parking. When maneuvering or parking, make sure that there are no persons, animals or objects in the area in which you are maneuvering.

Under the following circumstances, the rear view camera will not function, or will function in a limited manner:

- if the trunk lid is open
- in heavy rain, snow or fog
- at night or in very dark places
- if the camera is exposed to very bright light
- if the area is lit by fluorescent bulbs or LED lighting (the display may flicker)
- if the camera lens fogs up, e.g. when driving into a heated garage in winter, causing a rapid change in temperature
- if the camera lens is dirty or obstructed. Observe the notes on cleaning (> page 253)
- if the rear of your vehicle is damaged. In this event, have the camera position and setting checked at a qualified specialist workshop

The field of vision and other functions of the rear view camera may be restricted due to additional accessories on the rear of the vehicle (e.g. license plate holder, bicycle rack). The guide lines in the COMAND display show the distances to your vehicle. The distances only apply to road level.

i The rear view camera is protected from raindrops and dust by means of a flap. When the rear view camera is activated, this flap opens.

The flap closes again when:

- you have finished the maneuvering process
- you switch off the engine
- you open the trunk

Observe the notes on cleaning (> page 253).

For technical reasons, the flap may remain open briefly after the rear view camera has been deactivated.

! Objects not at ground level may appear to be further away than they actually are, e.g.:

- the bumper of a parked vehicle
- the drawbar of a trailer

- the ball coupling of a trailer tow hitch
- the rear section of an HGV
- a slanted post

Use the guidelines only for orientation.

Approach objects no further than the bottom-most guideline.

The rear view camera may show a distorted view of obstacles, show them incorrectly or not at all. The rear view camera does not show objects in the following positions:

- very close to the rear bumper
- under the rear bumper
- in the area immediately above the tailgate handle

Activating/deactivating the rear view camera

- ▶ **To activate:** make sure that the SmartKey is in position **2** in the ignition lock.
- ▶ Make sure that the **Activation by R gear** function is selected in COMAND (see Digital Operator's Manual).

- ▶ Engage reverse gear.

The rear view camera flap opens. The area behind the vehicle is shown in the COMAND display with guide lines.

The image from the rear view camera is available throughout the maneuvering process.

To deactivate: the rear view camera deactivates if you shift the transmission to **P** or after driving forwards a short distance.

Information in the Digital Operator's Manual

In the Digital Operator's Manual you will find information on the following topics:

- Displays in the COMAND display
- "Reverse parking" function
- Wide-angle function
- Object detection

360° camera (surround view)

General notes

The 360° camera is a system consisting of four cameras.

The system analyzes images from the following cameras:

- Rear view camera
- Front camera
- Two side cameras in the exterior mirrors

The cameras capture the immediate surroundings of the vehicle. The 360° camera assists you, for instance when parking or at exits with reduced visibility.

The 360° camera images can be shown in full screen mode or in seven different split-screen views on the COMAND display. A split-screen view also includes a top view of the vehicle. This view is calculated from the data supplied by the installed cameras (virtual camera).

The seven split-screen views are:

- top view and picture from the rear view camera (130° viewing angle)
- top view and image from the front camera (130° viewing angle without displaying the maximum steering wheel angle)
- top view and enlarged rear view
- top view and enlarged front view
- top view and trailer view (vehicles with trailer tow hitch)
- top view and images from the rear-facing side cameras (rear wheel view)
- top view and images from the forward-facing side cameras (front wheel view)

When the function is active and you shift the transmission from **D** or **R** to **N**, the guide lines in the COMAND display are hidden.

When you change between transmission positions **D** and **R**, you see the previously selected front or rear view.

Important safety notes

The 360° camera is only an aid and may show a distorted view of obstacles, show them incorrectly or not at all. The 360° camera is not a substitute for attentive driving.

You are always responsible for safe maneuvering and parking. When maneuvering or parking, make sure that there are no persons, animals or objects in the area in which you are maneuvering.

You are always responsible for safety, and must always pay attention to your surroundings when parking and maneuvering. This applies to the areas behind, in front of and beside the vehicle. You could otherwise endanger yourself and others.

The 360° camera will not function or will function in a limited manner:

- if the doors are open
- if the exterior mirrors are folded in
- if the trunk lid is open
- in heavy rain, snow or fog
- at night or in very dark places
- if the cameras are exposed to very bright light
- if the area is lit by fluorescent bulbs or LED lighting (the display may flicker)
- if the camera lenses fog up, e.g. when driving into a heated garage in winter, causing a rapid change in temperature
- if the camera lenses are dirty or covered. Observe the notes on cleaning (> page 253)
- if the vehicle components in which the cameras are installed are damaged. In this event, have the camera position and setting checked at a qualified specialist workshop.

Do not use the 360° camera in this case. You can otherwise injure others or cause damage to objects or the vehicle.

The guide lines in the COMAND display show the distances to your vehicle. The distances only apply to road level.

In trailer mode, the guide lines show the distances at the level of the trailer coupling.

The cameras in the front and in the rear area are each protected by a flap. These flaps are opened when the 360° camera is activated. Observe the notes on cleaning (▷ page 253). For technical reasons, the flaps may remain open briefly after the 360° camera has been deactivated.

Activation conditions

The 360° camera image can be displayed if:

- COMAND is switched on (see the Digital Operator's Manual).
- The **360° Camera** function is switched on.

i If the 360° camera is activated at speeds above approximately 19 mph (30 km/h), a warning message appears.

The warning message disappears if:

- the vehicle's speed falls below approximately 19 mph (30 km/h). The 360° camera is then activated.
- the message is confirmed with the  button.

Switching the 360° camera on and off using the button

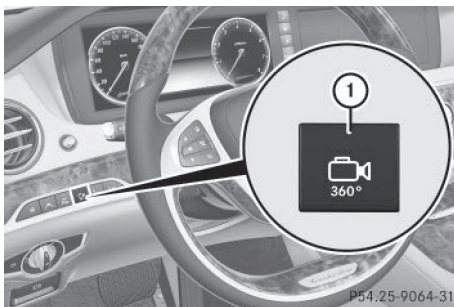

- ▶ **To switch on:** press button **1**. Depending on whether position **D** or **R** is engaged, the following is shown:

- full screen display with the image from the front camera
- full screen display with the image from the rear view camera

▶ **To deactivate:** press button **1** again.

i You can also switch to the split-screen view from the full-screen view.

Activating the 360° camera with COMAND

▶ Press the  button in the center console.

The vehicle menu is displayed.

▶ To select the 360° camera: turn and press the controller.

Depending on whether position **D** or **R** is engaged, the following is shown:

- a split screen with top view and the image from the front camera or
- a split screen with top view and the image from the rear view camera

Further information on the COMAND controller can be found in the Digital Operator's Manual.

Activating the 360° camera using reverse gear

The 360° camera images can be automatically displayed by engaging reverse gear.

- ▶ Make sure that the SmartKey is in position **2** in the ignition lock.
- ▶ Make sure that the **Activation by R gear** function is selected in COMAND (see Digital Operator's Manual).
- ▶ **To show the 360° camera image:** engage reverse gear.

The area behind the vehicle is shown in the COMAND display in split-screen mode. You see the top view of the vehicle and the image from the rear view camera.

Information in the Digital Operator's Manual

In the Digital Operator's Manual you will find information on the following topics:

- Selecting the split-screen and full screen displays
- Displays in the COMAND display
- Display with the PARKTRONIC display

Exiting 360° camera display mode

The 360° camera display is stopped

- when you select transmission position **P**, or
- when you are driving at moderate speeds

The view which was active before the 360° camera was displayed appears in the COMAND display. You can also stop the 360° camera display split-screen view by selecting the  symbol in the display and then confirming with the COMAND controller.

ATTENTION ASSIST

General notes

ATTENTION ASSIST helps you during long, monotonous journeys, such as on highways. It is active in the 37 mph (60 km/h) to 125 mph (200 km/h) range. If ATTENTION ASSIST detects typical indicators of fatigue or increasing lapses in concentration on the part of the driver, it suggests taking a break.

Important safety notes

ATTENTION ASSIST is only an aid to the driver. It might not always recognize fatigue or increasing inattentiveness in time or fail to recognize them at all. The system is not a substitute for a well-rested and attentive driver.

The functionality of ATTENTION ASSIST is restricted and warnings may be delayed or not occur at all:

- if the length of the journey is less than approximately 30 minutes
 - if the road condition is poor, e.g. if the surface is uneven or if there are potholes
 - if there is a strong side wind
 - if you have adopted a sporty driving style with high cornering speeds or high rates of acceleration
 - if you are predominantly driving slower than 37 mph (60 km/h) or faster than 125 mph (200 km/h)
 - if you are driving with the active Steer Assist of DISTRONIC PLUS
 - if the time has been set incorrectly
 - in active driving situations, such as when you change lanes or change your speed
- ATTENTION ASSIST is reset when you continue your journey and starts assessing your tiredness again if:
- you switch off the engine.
 - you take off your seat belt and open the driver's door, e.g. for a change of drivers or to take a break.

Displaying the attention level



You can have current status information displayed in the assistance menu of the on-board computer.

- ▶ Select the Assistance display for Attention Assist using the on-board computer (▷ page 194).

The following information is displayed:

- length of the journey since the last break.
- the attention level determined by ATTENTION ASSIST, displayed in a bar display in five levels from high to low.
- if ATTENTION ASSIST is unable to calculate the attention level and cannot output a warning, the **System Passive** message appears. The bar display then changes the display, e.g. if you are driving at a speed below 37 mph (60 km/h) or above 124 mph (200 km/h).

Activating ATTENTION ASSIST

- ▶ Activate ATTENTION ASSIST using the on-board computer (▷ page 194).

The system determines the attention level of the driver depending on the setting selected:

Standard selected: the sensitivity with which the system determines the attention level is set to normal.

Sensitive selected: the sensitivity is set higher. The attention level detected by Attention Assist is adapted accordingly and the driver is warned earlier.

When ATTENTION ASSIST is deactivated, the  symbol appears in the multifunction display in the assistance graphic display.

When ATTENTION ASSIST has been deactivated, it is automatically reactivated after the engine has been stopped. The sensitivity selected corresponds to the last selection activated (standard/sensitive).

Warning in the multifunction display

If fatigue or increasing lapses in concentration are detected, a warning appears in the multifunction display: **Attention Assist: Take a break!**

In addition to the message shown in the multifunction display, you will then hear a warning tone.

- ▶ If necessary, take a break.
- ▶ Confirm the message by pressing the  button on the steering wheel.

On long journeys, take regular breaks in good time to allow yourself to rest properly. If you do not take a break and ATTENTION ASSIST continues to detect increasing lapses in concentration, you will be warned again after 15 minutes at the earliest. This will only happen if ATTENTION ASSIST still detects typical indicators of fatigue or increasing lapses in concentration.

If a warning is output in the multifunction display, a service station search is performed in COMAND. You can select a service station and navigation to this service station will then begin. This function can be activated and deactivated in COMAND.

Night View Assist Plus

General notes

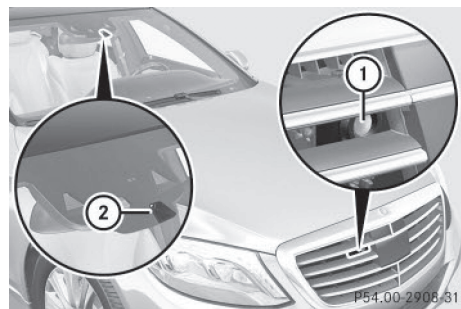

In addition to the illumination provided by the normal headlamps, Night View Assist Plus uses infrared light to illuminate the road. Night View Assist Plus camera ② picks up the infrared light and displays a monochrome image in the multifunction display. The image shown in the display corresponds to a road lit up by high-beam headlamps. This enables you to see the road's course and any obstacles in good time. When pedestrian recognition is

active, pedestrians recognized by the system are visually highlighted in color in the Night View Assist Plus display with small frame corners.

In addition, an infrared camera is integrated into the radiator trim ①. The camera helps detect pedestrians and animals. Observe the notes on cleaning the infrared camera (▷ page 254).

- ❗ Infrared light is not visible to the human eye and therefore does not glare. Night View Assist Plus can therefore remain switched on even if there is oncoming traffic.

Important safety notes

Night View Assist Plus is only an aid and is not a substitute for attentive driving. Do not rely on the Night View Assist Plus display. You are responsible for the distance to the vehicle in front, for vehicle speed and for braking in good time. Drive carefully and always adapt your driving style to suit the prevailing road and traffic conditions.

The system may be impaired or may not function if:

- if there is poor visibility, e.g. due to snow, rain, fog or spray
- if the windshield is dirty, fogged up or covered, for instance by a sticker, in the vicinity of the camera
- if the thermal imaging camera in the radiator grill is dirty, fogged up or covered
- on bends, hilltops or downhill gradients
- at high outside temperatures

Night View Assist Plus cannot display objects directly in front of or beside the vehicle.

It may be the case that other objects are marked or highlighted as well as pedestrians and animals.

Pedestrian and animal recognition

General notes

Pedestrian or animal recognition may be impaired or inoperative if:

- pedestrians or animals are partially or entirely obscured by other objects, e.g. parked vehicles
- the silhouette of the pedestrian or of the animal in the Night View Assist Plus display is incomplete or interrupted, e.g. by powerful light reflections
- pedestrians or animals do not contrast with the surroundings
- the camera system no longer recognizes pedestrians as persons due to special clothing or other objects
- pedestrians are not in an upright position, e.g. sitting, squatting or lying
- animals are not recognized by the system, e.g. because of their size or shape

The pedestrian and animal recognition is deactivated at temperatures above 90 °F (32 °C). The spotlight function and automatic delayed switch-off are then no longer active.

Pedestrian recognition

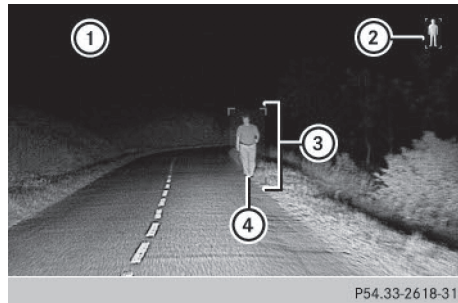

- ① Night View Assist Plus display
- ② Readiness symbol for active pedestrian recognition
- ③ Highlighting
- ④ Pedestrian recognized

Night View Assist Plus can recognize pedestrians using typical characteristics, e.g. the

body contours and posture of a person standing upright.

Pedestrian recognition is then switched on automatically if:

- Night View Assist Plus is activated.
- you are driving faster than approximately 6 mph (10 km/h).
- it is dark.

If pedestrian recognition is active, readiness symbol ② appears. Persons who are detected are highlighted by framing ③. If the pedestrian recognition system has brought a pedestrian to your attention, look through the windshield to evaluate the situation. The actual distance to objects and pedestrians cannot be gaged accurately by looking at a screen.

Animal recognition

Animals can be recognized in the following situations:

- darkness
- outside built-up areas
- below an outside temperature of 90 °F (32 °C)

Night View Assist Plus can recognize larger animals such as deer, cows or horses using typical characteristics.

The system does not detect:

- smaller animals, e.g. dogs and cats
- animals whose silhouette is not clearly recognizable.

When detected, animals are marked with small color frame corners. In contrast to pedestrian recognition, there is no separate readiness symbol in the multifunction display.

Switching Night View Assist on/off

Activation conditions

You can only activate Night View Assist Plus if all of the following conditions are met:

- the ignition is switched on (▷ page 133) or the engine has been started.
- the light switch is in the **AUTO** or  position.
- reverse gear has not been engaged.

Activating Night View Assist Plus

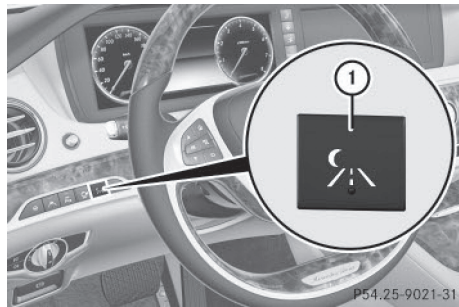

- ▶ Press button ①.

The Night View Assist Plus display appears in the multifunction display.

- i** The infrared headlamps only switch on in the dark from speeds of approximately 6 mph (10 km/h). This means that you do not have the full visual range while the vehicle is stationary and cannot check whether Night View Assist Plus is working. The infrared headlamps are deactivated at speeds below 3 mph (5 km/h). The Night View image continues to be displayed until you deactivate it by pressing button ①.

Automatic activation

You can select the **Night View Assist Automatic Activation** option via the Night View Assist menu. The pedestrian and animal search function remains active even when the Night View image is not displayed. In the dark, in unlit surroundings and at speeds of more than 60 km/h, the Night View image is automatically displayed in the multifunction display.

play as soon as pedestrians or animals are detected.

- ▶ In the assistance menu, select automatic delayed switch-off of Night View Assist Plus (▷ page 194).

Deactivating Night View Assist Plus

- ▶ Press button ①.
The Night View Assist Plus display disappears from the multifunction display. Night View Assist is deactivated.

Spotlight function

General notes

Under certain conditions, the spotlight function uses the headlamps to flash at detected pedestrians.

The spotlight function is only active if:

- pedestrian recognition is active
- the road surface is not lit
- the driving speed is at least 40 mph (60 km/h)
- the "Adaptive Highbeam Assist PLUS" function is activated (▷ page 119)

The spotlight function is not active or is active only to a limited extent if:

- you are driving in city traffic
- there are pedestrians located in the area of an oncoming vehicle or a vehicle in front

Activating the spotlight function

The pedestrian detection with spotlight function is running the background. If the prerequisites are met, the spotlight function uses the headlamps to flash four short pulses at a pedestrian detected on or near to the road surface.

- ▶ In the light menu, select the spotlight function of Night View Assist (▷ page 194).

The spotlight function does not flash at animals.

Display in the assistance graphic



Pedestrian symbol ① in the assistance graphic indicates the status of the spotlight function. If the symbol is displayed not filled in, the function is switched on. If the symbol is displayed filled in, the conditions for the spotlight function are met.

Displaying the assistance graphic

- ▶ Select the **Assistance Graphic** menu on the on-board computer (▷ page 194).

Problems with Night View Assist

You can find information about this in the Digital Operator's Manual.

Driving Assistance PLUS package

General notes

The Active Driving Assistance PLUS package consists of DISTRONIC PLUS (▷ page 159), Active Blind Spot Assist (▷ page 181) and Active Lane Keeping Assist (▷ page 184).

Active Blind Spot Assist

General notes

Active Blind Spot Assist uses a radar sensor system, pointed toward the rear of the vehicle, to monitor the area to the sides of the vehicle which the driver is unable to see. A warning display in the exterior mirrors draws your attention to vehicles detected in the monitored area. If you then switch on the corresponding turn signal to change lanes, you

will also receive a visual and audible collision warning. If a risk of lateral collision is detected, corrective braking may help you avoid a collision. Before a course-correcting brake application, Active Blind Spot Assist evaluates the space in the direction of travel and at the sides of the vehicle. For this, Active Blind Spot Assist uses radar sensors which are pointed in the direction of travel.

Active Blind Spot Assist supports you from a speed of approximately 20 mph (30 km/h).

Important safety notes

Active Blind Spot Assist is only an aid and is not a substitute for attentive driving.

WARNING

Active Blind Spot Assist does not react to:

- vehicles overtaken too closely on the side, placing them in the blind spot area
- vehicles which approach with a large speed differential and overtake your vehicle

As a result, Active Blind Spot Assist may neither give warnings nor intervene in such situations. There is a risk of an accident.

Always observe the traffic conditions carefully, and maintain a safe lateral distance.

- i** USA only: This device has been approved by the FCC as a "Vehicular Radar System". The radar sensor is intended for use in an automotive radar system only. Removal, tampering, or altering of the device will void any warranties, and is not permitted by the FCC. Do not tamper with, alter, or use in any non-approved way.

Any unauthorized modification to this device could void the user's authority to operate the equipment.

- i** Canada only: This device complies with RSS-210 of Industry Canada. Operation is subject to the following two conditions:
 1. This device may not cause harmful interference, and

2. This device must accept any interference received, including interference that may cause undesired operation of the device.

Removal, tampering, or altering of the device will void any warranties, and is not permitted. Do not tamper with, alter, or use in any non-approved way.

Any unauthorized modification to this device could void the user's authority to operate the equipment.

Radar sensors

The Active Blind Spot Assist radar sensors are integrated into the front and rear bumpers and behind a cover in the radiator trim. Make sure that the bumpers and the cover in the radiator grill are free of dirt, ice or slush. The rear sensors must not be covered, e.g. by bicycle racks or overhanging loads. Following a severe impact or in the event of damage to the bumpers, have the function of the radar sensors checked at a qualified specialist workshop. Active Blind Spot Assist may otherwise no longer work properly.

Monitoring area

WARNING

Active Blind Spot Assist does not detect all traffic situations and road users. There is a risk of an accident.

Always make sure that there is sufficient distance on the side for other traffic or obstacles.

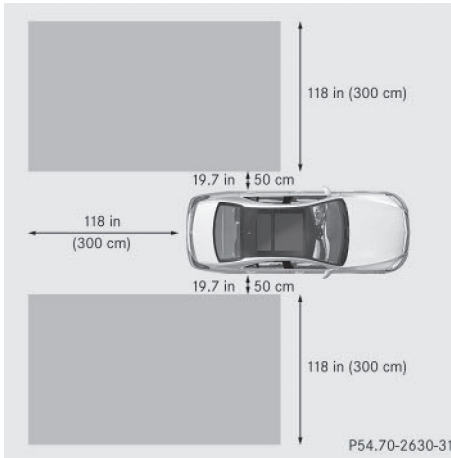

Active Blind Spot Assist monitors the area up to 10 ft (3.0 m) behind your vehicle and directly next to your vehicle, as shown in the diagram.

The detection of obstacles can be impaired in the case of:

- there is dirt on the sensors or anything else covering the sensors
- poor visibility, e.g. due to rain, snow or spray

Vehicles in the monitoring range are then not indicated.

Active Blind Spot Assist may not detect narrow vehicles, such as motorcycles or bicycles, or may only detect them too late.

If the lanes are narrow, vehicles driving in the lane beyond the lane next to your vehicle may be indicated, especially if the vehicles are not driving in the middle of their lane. This may be the case if there are vehicles at the inner edge of your lane.

Due to the nature of the system:

- warnings may be issued in error when driving close to crash barriers or similar solid lane borders.
- warnings may be interrupted when driving alongside particularly long vehicles, e.g. trucks, for a prolonged time.

Warning display

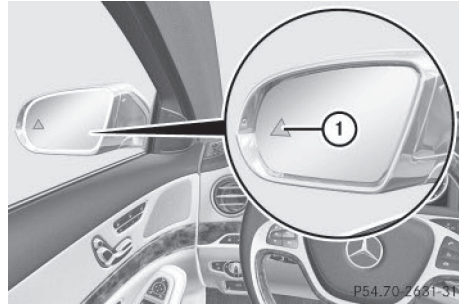

① Warning display

Active Blind Spot Assist is not operational at speeds below approximately 20 mph (30 km/h). Vehicles in the monitoring range are then not indicated.

If a vehicle is detected within the blind spot monitoring range at speeds above 20 mph (30 km/h), warning lamp ① on the corresponding side lights up red. This warning is always emitted when a vehicle enters the blind spot monitoring range from behind or from the side. When you overtake a vehicle, the warning only occurs if the difference in speed is less than 7 mph (12 km/h).

If you select the reverse gear, Active Blind Spot Assist is not operational.

The brightness of the warning lamps is automatically adapted to the brightness of the surroundings.



When Active Blind Spot Assist is activated, gray radar waves propagating backwards appear next to the vehicle in the assistance display in the multifunction display. Above a speed of 20 mph (30 km/h), the color of the radar waves in the assistance display changes to green ②. Active Blind Spot Assist is then ready for use.

Visual and acoustic collision warning

If you switch on the turn signals to change lanes and a vehicle is detected in the side monitoring range, you receive a visual and acoustic collision warning. You will then hear a double warning tone and red warning lamp ① flashes. If the turn signal remains on, detected vehicles are indicated by the flashing of red warning lamp ①. There are no further warning tones.

Course-correcting brake application

If Active Blind Spot Assist detects a risk of a lateral collision in the monitoring range, a course-correcting brake application is carried out. This is meant to assist you in avoiding a collision.

⚠ WARNING

A course-correcting brake application cannot always prevent a collision. There is a risk of an accident.

Always steer, brake or accelerate yourself, especially if Active Blind Spot Assist warns you or makes a course-correcting brake application. Always maintain a safe distance at the sides.

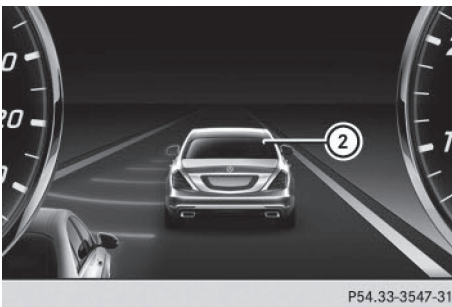

P54.33-3547-31

If a course-correcting brake application occurs, red warning lamp ① flashes in the exterior mirror and a dual warning tone sounds. In addition, display ② underlining the danger of a side collision appears in the multifunction display.

In very rare cases, the system may make an inappropriate brake application. A course-correcting brake application may be interrup-

ted at any time if you steer slightly in the opposite direction or accelerate.

The course-correcting brake application is available in the speed range between 20 mph (30 km/h) and 120 mph (200 km/h).

Either no braking application, or a course-correcting brake application adapted to the driving situation occurs if:

- there are vehicles or obstacles, e.g. crash barriers, located on both sides of your vehicle.
- a vehicle approaches you too closely at the side.
- you have adopted a sporty driving style with high cornering speeds.
- you clearly brake or accelerate.
- a driving safety system intervenes, e.g. ESP® or PRE-SAFE® Brake.
- ESP® is switched off.
- a loss of tire pressure or a defective tire is detected.

Information in the Digital Operator's Manual

In the Digital Operator's Manual you can find information about:

- switching on Active Blind Spot Assist

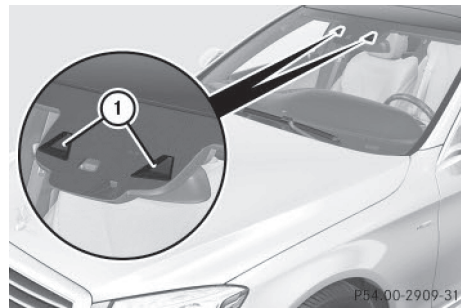
Active Lane Keeping Assist**General notes**

P54.00-2909-31

Active Lane Keeping Assist monitors the area in front of your vehicle by means of camera system ① at the top of the windshield. Vari-

ous different areas to the front, rear and side of your vehicle are also monitored with the aid of the radar sensor system. Active Lane Keeping Assist detects lane markings on the road and can warn you before you leave your lane unintentionally. If you do not react to the warning, a lane-correcting application of the brakes can bring the vehicle back into the original lane.

If you select **km** in the **Display Unit Speed-/Odometer**: function on the on-board computer (▷ page 194), Active Lane Keeping Assist is activated starting at a speed of 60 km/h. If the **miles** display unit is selected, the assistance range begins at 40 mph.

Important safety notes

If you fail to adapt your driving style, Active Lane Keeping Assist can neither reduce the risk of accident nor override the laws of physics. Active Lane Keeping Assist cannot take account of road and weather conditions. It may not recognize traffic situations. Active Lane Keeping Assist is only an aid. You are responsible for the distance to the vehicle in front, for vehicle speed, for braking in good time and for staying in your lane.

Active Lane Keeping Assist cannot continuously keep your vehicle in its lane.

WARNING

Active Lane Keeping Assist cannot always clearly detect lane markings.

In such cases, Active Lane Keeping Assist can:

- give an unnecessary warning and then make a course-correcting brake application to the vehicle
- not give a warning or intervene

There is a risk of an accident.

Always pay particular attention to the traffic situation and keep within the lane, especially if Active Lane Keeping Assist alerts you. Terminate the intervention in a non-critical driving situation.

The system may be impaired or may not function if:

- there is poor visibility, e.g. due to insufficient illumination of the road, or due to snow, rain, fog or spray
- there is glare, e.g. from oncoming traffic, the sun or reflections (e.g. when the road surface is wet)
- the windshield is dirty, fogged up, damaged or covered, for instance by a sticker, in the vicinity of the camera
- the radar sensors in the front or rear bumpers or the radiator trim are dirty, e.g. obscured by snow
- there are no, several or unclear lane markings for a lane, e.g. in areas with road construction work
- the lane markings are worn away, dark or covered up, e.g. by dirt or snow
- the distance to the vehicle in front is too small and the lane markings thus cannot be detected
- the lane markings change quickly, e.g. lanes branch off, cross one another or merge
- the road is narrow and winding
- there are strong shadows cast on the road

If no vehicle is detected in the adjacent lane and broken lane markings are detected, no lane-correcting brake application is made.

Warning vibration in the steering wheel

A warning may be given if a front wheel passes over a lane marking. It will warn you by means of intermittent vibration in the steering wheel for up to 1.5 seconds.

Lane-correcting brake application

If you leave your lane, under certain circumstances the vehicle will brake briefly on one side. This is meant to assist you in bringing the vehicle back to the original lane.

⚠ WARNING

A lane-correcting brake application cannot always bring the vehicle back into the original lane. There is a risk of an accident.

Always steer, brake or accelerate yourself, especially if Active Lane Keeping Assist warns you or makes a lane-correcting brake application.

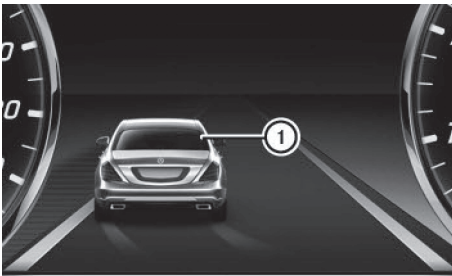

P54.33-3546-31

If a lane-correcting brake application occurs, display ① appears in the multifunction display. The brake application also slightly reduces vehicle speed.

This function is available in the range between 40 mph and 120 mph (60 km/h and 200 km/h).

A lane-correcting brake application can be made after driving over a lane marking recognized as being solid or broken. Before this, a warning must be given by means of intermittent vibration in the steering wheel. In addition, a lane with lane markings on both sides must be recognized.

In the case of a broken lane marking being detected, a lane-correcting brake application can only be made if a vehicle has been detected in the adjacent lane. Oncoming vehicles, overtaking vehicles and vehicles in adjacent lanes can be detected.

i A further lane-correcting brake application can only occur after your vehicle has returned to the original lane.

No lane-correcting brake application occurs if:

- you clearly and actively steer, brake or accelerate.
- you cut the corner on a sharp bend.
- you have switched on the turn signal.
- a driving safety system intervenes, e.g. ESP[®], PRE-SAFE[®] Brake or Active Blind Spot Assist.
- you have adopted a sporty driving style with high cornering speeds or high rates of acceleration.
- ESP[®] is switched off.
- the transmission is not in position **D**.
- a loss of tire pressure or a defective tire has been detected and displayed.
- an obstacle in the lane in which you are driving has been detected.

Active Lane Keeping Assist may not detect other road users or traffic situations. An inappropriate brake application may be interrupted at any time if you:

- steer slightly in the opposite direction
- switch on the turn signal
- clearly brake or accelerate

A lane-correcting brake application is interrupted automatically if:

- a driving safety system intervenes, e.g. ESP[®], PRE-SAFE[®] Brake or Active Blind Spot Assist.
- lane markings can no longer be recognized.

Information in the Digital Operator's Manual

In the Digital Operator's Manual you can find information about:

- Switching on Active Lane Keeping Assist

PLUG-IN HYBRID operation

Points to remember

General notes

Hybrid technology combines a fuel efficient internal combustion engine with a powerful electric motor. In **HYBRID** mode, the hybrid system automatically selects the most efficient operating mode for every driving situation. Drive the vehicle in the usual manner.

To save fuel, in **HYBRID** mode, the hybrid system switches off the combustion engine as often as possible during the journey when power output requirements are low. When power output requirements are low, the electric motor powers the vehicle. The engine is switched on, even while the vehicle is in motion, when a higher power output is required. The engine is usually switched off when the vehicle is stationary. Consequently, there is usually no engine idling as with combustion engine vehicles.

For pulling away and accelerating, the electric motor supports the internal combustion engine using the power stored in the high-voltage battery. This energy is also used for driving in partially electric mode, to operate the electric refrigerant compressor and support the 12 V on-board electrical system. In this way the hybrid drive helps to reduce your vehicle's fuel consumption.

Observe the driving tips on PLUG-IN HYBRID operation; see the Digital Operator's Manual.

Recuperative Brake System

If you release the accelerator pedal when the vehicle is in motion, overrun recuperation is initiated. The electric motor is operated as a generator when in overrun mode and when you brake. Hybrid technology converts the kinetic energy of the vehicle into electricity and stores it in the high-voltage battery.

Observe the important safety notes for the Recuperative Brake System (▷ page 46).

Important safety notes

If the engine is switched off by the ECO start/stop function and you open the driver's door:

- a message appears in the multifunction display and
- a warning tone sounds

Further information .

All of the vehicle's systems remain active, if:

- the vehicle is stationary
- the combustion engine is switched off and
- the READY indicator in the instrument cluster lights up

If you remove your foot from the brake pedal while in transmission position D or R, the vehicle may pull away automatically.

Observe the notes on the READY display of the ECO start/stop function (▷ page 188).

Vehicles with an electric motor generate much less driving noise than vehicles with internal combustion engines. As a result, your vehicle may not be heard by other road users in certain situations.

Depending on the vehicle's equipment and country-specific regulations, the vehicle can be equipped with Acoustic Vehicle Indication.

Acoustic Vehicle Indication generates a certain sound at a speed between 0 and 20 mph (30 km/h). This helps other road users, particularly pedestrians and cyclists, to hear your vehicle better. The sound can also be heard inside the vehicle.

The volume depends on the engine speed.

The faster you accelerate, the louder the sound is. At a speed of over 20 mph (30 km/h) the sound is switched off. Above this speed, the natural sounds from the vehicle are sufficient that it can be heard in good time by other road users.

Hybrid system overview

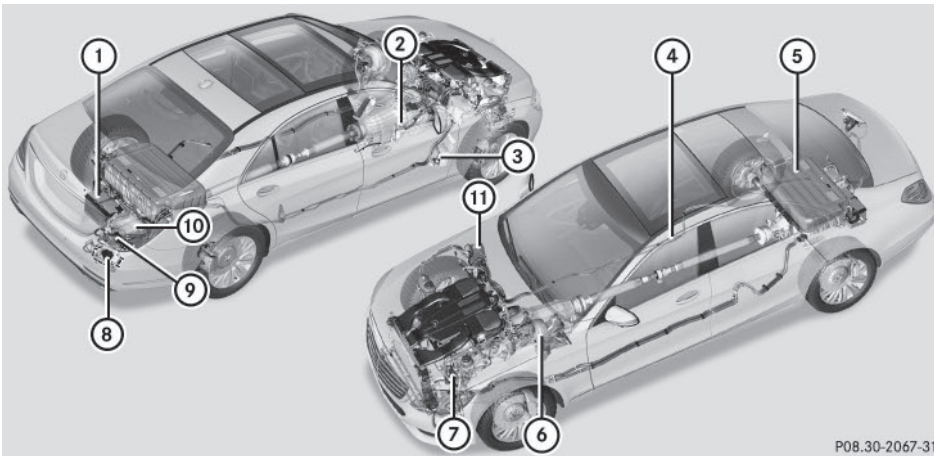

P08.30-2067-31

- ① 12 V battery
- ② Transmission with electric motor
- ③ Electric heater
- ④ High-voltage electrical system cables
- ⑤ High-voltage battery
- ⑥ Recuperative Brake System
- ⑦ Electric refrigerant compressor
- ⑧ Vehicle socket
- ⑨ Charger
- ⑩ Voltage transformer
- ⑪ Power electronics

You can deactivate the hybrid system manually. For further information on the high-voltage switch-off device, see (▷ page 45).

Information in the Digital Operator's Manual

In the Digital Operator's Manual you will find information on the following topics:

- Instrument cluster
- Displays and operation
- Menus and submenus
- Starting the engine
- Pulling away
- Driving
- Parking
- Problems with PLUG-IN HYBRID operation

| | |
|--|-----|
| Useful information | 190 |
| Important safety notes | 190 |
| Displays and operation | 190 |
| Menus and submenus | 194 |
| Display messages | 195 |
| Warning and indicator lamps in the instrument cluster | 211 |

Useful information

- i** This Operator's Manual describes all models and all standard and optional equipment of your vehicle available at the time of publication of the Operator's Manual. Country-specific differences are possible. Please note that your vehicle may not be equipped with all features described. This also applies to safety-related systems and functions.
- i** Read the information on qualified specialist workshops (▷ page 30).

Important safety notes**⚠ WARNING**

If you operate information systems and communication equipment integrated in the vehicle while driving, you will be distracted from traffic conditions. You could also lose control of the vehicle. There is a risk of an accident.

Only operate the equipment when the traffic situation permits. If you are not sure that this is possible, park the vehicle paying attention to traffic conditions and operate the equipment when the vehicle is stationary.

You must observe the legal requirements for the country in which you are currently driving when operating the on-board computer.

Only PLUG-IN HYBRID vehicles:**⚠ WARNING**

If the instrument cluster has failed or malfunctioned, you may not recognize function restrictions in systems relevant to safety. The operating safety of your vehicle may be impaired. There is a risk of an accident.

Pull over as soon as it is safe to do so and consult a qualified specialist workshop.

All vehicles except PLUG-IN HYBRID vehicles:**⚠ WARNING**

If the instrument cluster has failed or malfunctioned, you may not recognize function restrictions in systems relevant to safety. The operating safety of your vehicle may be impaired. There is a risk of an accident.

Drive on carefully. Have the vehicle checked at a qualified specialist workshop immediately.

If the operating safety of your vehicle is impaired, pull over as soon as it is safe to do so. Contact a qualified specialist workshop.

The on-board computer only shows messages or warnings from certain systems in the multifunction display. You should therefore make sure your vehicle is operating safely at all times.

For an overview, see the instrument panel illustration (▷ page 35).

Displays and operation**Information in the Digital Operator's Manual**

In the Digital Operator's Manual you will find information on the following topics:

- Coolant temperature display
- Tachometer
- Multifunction display
- Outside temperature display

Operating the on-board computer



- ① Multifunction display
- ② Right control panel
- ③ Left control panel

► **To activate the on-board computer:** turn the SmartKey to position **1** in the ignition lock.

You can control the multifunction display and the settings in the on-board computer using the buttons on the multifunction steering wheel.





Left control panel

| | |
|----------|---|
| | • Calls up the main menu |
| ▲ | <p>Press briefly:</p> <ul style="list-style-type: none"> • Scrolls in lists • Selects a menu or function • In the Radio/Media menu: opens the track or station list and selects an audio track or video scene • In the Telephone menu: switches to the phone book and selects a name or a telephone number |
| ▼ | |

| | |
|-----------|---|
| ▲ | <p>Press and hold:</p> <ul style="list-style-type: none"> • Rapid scrolling in all lists • In the Radio/Media menu: selects a station, audio track or video scene using rapid scrolling • In the Telephone menu: starts rapid scrolling if the phone book is open |
| ▼ | |
| OK | <ul style="list-style-type: none"> • In all menus: confirms the selected entry in the list • In the Radio/Media menu: opens the list of available radio sources/media • In the Telephone menu: switches to the phone book and starts dialing the selected number |
| | Switches off the Voice Control System; see the separate operating instructions |
| | <p>Press briefly:</p> <ul style="list-style-type: none"> • Back • In the Radio/Media menu: deselects the track or station list or list of available radio sources/media • Hides display messages • Exits the telephone book/redial memory |
| | <p>Press and hold:</p> <ul style="list-style-type: none"> • Calls up the standard display in the Trip menu |

Right control panel

| | |
|--|--|
| | <ul style="list-style-type: none"> • Rejects or ends a call • Exits phone book/redial memory |
| | <ul style="list-style-type: none"> • Makes or accepts a call • Switches to the redial memory |

| | |
|---|---|
|  | • Adjusts the volume |
|  | |
|  | • Mute |
|  | Switches on the Voice Control System; see the separate operating instructions |

Head-up display

General notes

The head-up display projects information from the navigation system and the driver assistance system above the dashboard into the driver's field of vision.

A requirement for the display of the contents is that the following functions are available in the vehicle and are switched on:

- Cruise control
- DISTRONIC PLUS
- Navigation

The head-up display allows the driver to see all of the information without having to take his eyes off the road.

Important safety notes

The head-up display is only an aid and is not a substitute for attentive driving.

The visibility of the head-up display is influenced by the following conditions:

- the driver's seat position
- the positioning of the display image
- the general ambient light
- sunglasses with polarization filters
- Wet roads
- blocking of sunlight by objects on the display cover

In the event of extreme sunlight, sections of the display may fade. This can be reversed by switching the head-up display off and on again.

- i** Vehicles with the head-up display are equipped with a special windshield. Should repairs be necessary, have the windshield replaced at a qualified specialist workshop.

Displays and operation

Switching the head-up display on or off



- Press button ①.

When the head-up display is switched on, the display appears in the driver's field of vision.

AMG vehicles: press button ① to change from Standard on the AMG display and then press button ① to turn off the head-up display.

Head-up display



Content and information for the following systems are shown in the head-up display:

- ① Navigation messages
- ② Current speed
- ③ Set DISTRONIC PLUS speed (> page 159)
The selected cruise control speed (> page 158)

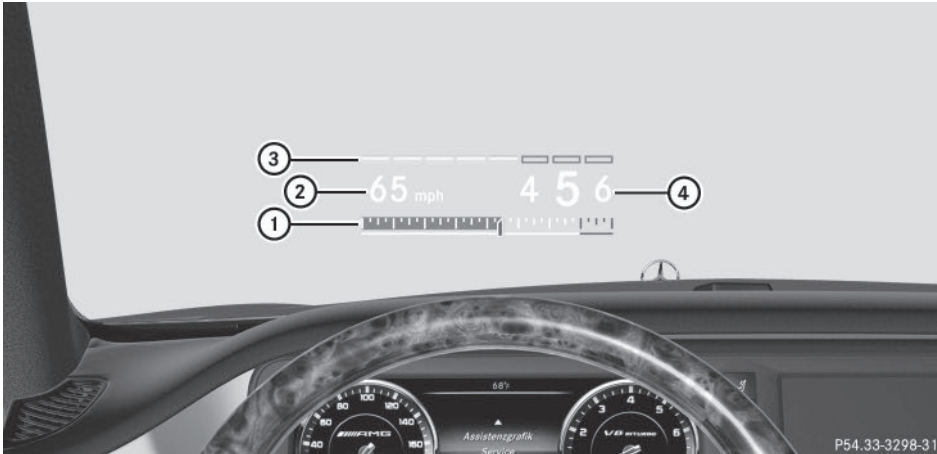

Contents and Information in the AMG display in AMG vehicles:

- ① Current engine speed
- ② Current speed
- ③ Upshift indicator
- ④ Currently selected gear, gearshift options when shifting manually



In the Settings menu, in the submenu head-up display, you have the following settings options:

- Switching other displays on/off (▷ page 194)
- Setting the position (▷ page 194)
- Setting the brightness (▷ page 194)

Menus and submenus

Menu overview

Press the  button on the steering wheel to call up the list of menus and select a menu.

Operating the on-board computer (▷ page 191).

You can find more information on the individual menus in the Digital Operator's Manual.

Depending on the equipment installed in the vehicle, you can call up the following menus:

- **Trip** menu
- **Navi** menu (navigation instructions)
- **Radio** menu
- **Media** menu
- **Telephone** menu
- **Assistance Graphic** menu
- **Service** menu
- **Settings** menu
- **AMG** menu in AMG vehicles

Display messages

Introduction

General notes

This section describes display messages relevant to safety together with their solutions. A description of other messages and their solutions can be found in the Digital Operator's Manual.

Display messages appear in the multifunction display.

Display messages with graphic displays may be shown in simplified form in the Operator's Manual and may therefore differ from the multifunction display.



Please respond in accordance with the display messages and follow the additional notes in this Operator's Manual.

With certain display messages, you will also hear a warning tone.

You can hide the display messages. The display messages are then stored in the message memory. Rectify the cause of a display message as soon as possible.

When you stop and park the vehicle, please observe the notes on the HOLD function (> page 167) and parking (> page 154).

Hiding display messages









- ▶ Press the  or  button on the steering wheel to hide the display message. The display message is cleared.

The multifunction display shows high-priority display messages in red. Some high-priority display messages cannot be hidden.

The multifunction display shows these messages continuously until the causes for the messages have been remedied.

Message memory

The on-board computer saves certain display messages in the **message memory**. You can call up the display messages:

- ▶ Use  on the steering wheel to call up the list of menus.
- ▶ Press the  or  button on the steering wheel to select the **Service** menu.
- ▶ Confirm by pressing  on the steering wheel.
- ▶ Press  or  to select the message memory.
 - If there are no display messages, you will see **No Messages** in the multifunction display.
 - If there are display messages, the number of messages stored is shown.
- ▶ Press  to confirm.
- ▶ Press the  or  button to scroll through the display messages.

Safety systems

Display messages



Currently Unavailable See Operator's Manual

Possible causes/consequences and ► Solutions

ABS (Anti-lock Brake System), ESP® (Electronic Stability Program), BAS (Brake Assist), PRE-SAFE®, the HOLD function, Hill Start Assist, Crosswind Assist, STEER CONTROL, Active Lane Keeping Assist and Active Blind Spot Assist are temporarily unavailable.

BAS PLUS with Cross-Traffic Assist, PRE-SAFE® Brake, PRE-SAFE® PLUS and COLLISION PREVENTION ASSIST PLUS may also have failed.

In addition, the  and  warning lamps light up in the instrument cluster.

ATTENTION ASSIST is deactivated.

For example, the on-board voltage may be insufficient.

 **WARNING**

The brake system continues to function normally, but without the functions listed above. The wheels could therefore lock if you brake hard, for example.

The steerability and braking characteristics may be severely affected. The braking distance in an emergency braking situation can increase.

If ESP® is not operational, ESP® is unable to stabilize the vehicle. There is an increased risk of skidding and an accident.

► Drive on carefully.

Carefully drive a suitable distance, making slight steering movements at a speed above 12 mph (20 km/h).

If the display message disappears, the functions mentioned above are available again.

If the display message continues to be displayed:

► Drive on carefully.



► Visit a qualified specialist workshop.



Inoperative See Operator's Manual



ABS, ESP®, BAS, PRE-SAFE®, the HOLD function, Hill Start Assist, Crosswind Assist, STEER CONTROL, Active Lane Keeping Assist and Active Blind Spot are unavailable due to a malfunction.

BAS PLUS with Cross-Traffic Assist, PRE-SAFE® Brake, PRE-SAFE® PLUS and COLLISION PREVENTION ASSIST PLUS may also have failed.

The **BRAKE** (USA only) /  (Canada only),  and  warning lamps in the instrument cluster may also light up.

ATTENTION ASSIST is deactivated.

 **WARNING**

| Display messages | Possible causes/consequences and ► Solutions |
|--|--|
| | <p>The brake system continues to function normally, but without the functions listed above. The wheels could therefore lock if you brake hard, for example.</p> <p>The steerability and braking characteristics may be severely affected. The braking distance in an emergency braking situation can increase.</p> <p>If ESP® is not operational, ESP® is unable to stabilize the vehicle. There is an increased risk of skidding and an accident.</p> <ul style="list-style-type: none"> ► Drive on carefully. ► Visit a qualified specialist workshop immediately. |
|  <p>Inoperative See Operator's Manual</p> | <p>ESP®, BAS, PRE-SAFE®, the HOLD function, Hill Start Assist, Crosswind Assist, STEER CONTROL, Active Lane Keeping Assist and Active Blind Spot are unavailable due to a malfunction.</p> <p>BAS PLUS with Cross-Traffic Assist, PRE-SAFE® Brake, PRE-SAFE® PLUS and COLLISION PREVENTION ASSIST PLUS may also have failed.</p> <p>The  warning lamp also lights up in the instrument cluster. ATTENTION ASSIST is deactivated.</p> <p>⚠ WARNING</p> <p>The brake system continues to function normally, but without the functions listed above.</p> <p>The braking distance in an emergency braking situation can thus increase.</p> <p>If ESP® is not operational, ESP® is unable to stabilize the vehicle. There is an increased risk of skidding and an accident.</p> <ul style="list-style-type: none"> ► Drive on carefully. ► Visit a qualified specialist workshop. |

Display messages

Currently Unavailable See Operator's Manual

Possible causes/consequences and ► Solutions

ESP®, BAS, PRE-SAFE®, the HOLD function, Hill Start Assist, Crosswind Assist, STEER CONTROL, Active Lane Keeping Assist and Active Blind Spot are unavailable due to a malfunction.

BAS PLUS with Cross-Traffic Assist, PRE-SAFE® Brake, PRE-SAFE® PLUS and COLLISION PREVENTION ASSIST PLUS may also have failed.

The  warning lamp also lights up in the instrument cluster. The self-diagnosis function might not be complete, for example. ATTENTION ASSIST is deactivated.

 **WARNING**

The brake system continues to function normally, but without the functions listed above. The wheels could therefore lock if you brake hard, for example.

The braking distance in an emergency braking situation can thus increase.







If ESP® is not operational, ESP® is unable to stabilize the vehicle. There is an increased risk of skidding and an accident.

► Carefully drive a suitable distance, making slight steering movements at a speed above 12 mph (20 km/h).

If the display message disappears, the functions mentioned above are available again.

If the display message continues to be displayed:

- Drive on carefully.
- Visit a qualified specialist workshop.

| Display messages | Possible causes/consequences and ► Solutions |
|---|---|
| <div style="display: flex; align-items: center; gap: 10px;"> <div style="border: 1px solid black; padding: 2px; font-weight: bold;">EBD</div> <div style="border: 1px solid black; padding: 2px; font-weight: bold;">(ABS)</div> </div> <div style="text-align: center; margin: 5px 0;">  </div> <p style="color: #0070C0;">Inoperative See Operator's Manual</p> | <p>EBD (electronic brake force distribution), ABS, ESP[®], BAS, PRE-SAFE[®], the HOLD function, Hill Start Assist, Crosswind Assist, STEER CONTROL, Active Lane Keeping Assist and Active Blind Spot Assist are unavailable due to a malfunction.</p> <p>BAS PLUS with Cross-Traffic Assist, PRE-SAFE[®] Brake, PRE-SAFE[®] PLUS and COLLISION PREVENTION ASSIST PLUS may also have failed.</p> <p>In addition, the  and  warning lamps light up in the instrument cluster and a warning tone sounds.</p> <p>⚠ WARNING</p> <p>The brake system continues to function normally, but without the functions listed above. The front and rear wheels could therefore lock if you brake hard, for example.</p> <p>The steerability and braking characteristics may be severely affected. The braking distance in an emergency braking situation can increase.</p> <p>If ESP[®] is not operational, ESP[®] is unable to stabilize the vehicle. There is an increased risk of skidding and an accident.</p> <ul style="list-style-type: none"> ► Drive on carefully. ► Visit a qualified specialist workshop immediately. |
| <div style="display: flex; align-items: center; gap: 10px;"> <div style="border: 1px solid black; padding: 2px; font-weight: bold;">BRAKE</div> <div>(USA only)</div> </div> <div style="text-align: center; margin: 5px 0;">  </div> <div style="display: flex; align-items: center; gap: 10px;"> <div>(Canada only)</div> <div style="border: 1px solid black; padding: 2px; font-weight: bold;">!</div> </div> <p style="color: #0070C0;">Check Brake Fluid Level</p> | <p>There is not enough brake fluid in the brake fluid reservoir. In addition, the  (USA only)/ (Canada only) warning lamp lights up in the instrument cluster and a warning tone sounds.</p> <p>⚠ WARNING</p> <p>The braking effect may be impaired. There is a risk of an accident.</p> <ul style="list-style-type: none"> ► Pull over and stop the vehicle safely as soon as possible, paying attention to road and traffic conditions. Do not continue driving under any circumstances. ► Secure the vehicle against rolling away (▷ page 154). ► Consult a qualified specialist workshop. ► Do not add brake fluid. This does not correct the malfunction. |



Inoperative See Operator's Manual

BRAKE (USA

only)



(Canada only)



Check Brake Fluid Level









⚠ WARNING









⚠ WARNING



- Drive on carefully.
- Visit a qualified specialist workshop immediately.

- Pull over and stop the vehicle safely as soon as possible, paying attention to road and traffic conditions. Do not continue driving under any circumstances.
- Secure the vehicle against rolling away (▷ page 154).
- Consult a qualified specialist workshop.
- Do not add brake fluid. This does not correct the malfunction.

| Display messages | Possible causes/consequences and ► Solutions |
|--|--|
| <p>Check Left Rear Belt See Operator's Manual or Check Right Rear Belt See Operator's Manual</p> | <p>The seat belt buckle extender on the right or left of the rear compartment is not in the predefined position. The belt strap may be jammed in the belt tongue.</p> <p> WARNING</p> <p>If the seat belt buckle extender is not in the predefined position, the seat belt cannot provide the intended level of protection. There is an increased risk of injury.</p> <ul style="list-style-type: none"> ► Pull over and stop the vehicle safely as soon as possible, paying attention to road and traffic conditions. ► Release the jamming. ► Repeat the seat belt fastening procedure. |
| | <p>The seat belt buckle extender on the right or left of the rear compartment is not in the predefined position. The seat belt buckle extender may be jammed.</p> <p> WARNING</p> <p>If the seat belt buckle extender is not in the predefined position, the seat belt cannot provide the intended level of protection. There is an increased risk of injury.</p> <ul style="list-style-type: none"> ► Move the seat cushion forwards (► page 112) and remove the cause of the jamming. ► Repeat the seat belt fastening procedure. |
| | <p>The seat belt buckle extender on the right or left of the rear compartment is not in the predefined position. The seat belt may be locked.</p> <p> WARNING</p> <p>If the seat belt buckle extender is not in the predefined position, the seat belt cannot provide the intended level of protection. There is an increased risk of injury.</p> <ul style="list-style-type: none"> ► Completely take off your seat belt. ► Repeat the seat belt fastening procedure. |

| Display messages | Possible causes/consequences and ► Solutions |
|--|--|
| | <p>The seat belt buckle extender on the right or left of the rear compartment is not in the predefined position. There is not enough belt slack in the system.</p> <p> WARNING</p> <p>If the seat belt buckle extender is not in the predefined position, the seat belt cannot provide the intended level of protection. There is an increased risk of injury.</p> <ul style="list-style-type: none"> ► Loosen the seat belt. ► Repeat the seat belt fastening procedure. <hr/> <p>The seat belt buckle extender on the right or left of the rear compartment is not in the predefined position. The assistance measures specified have been carried out. There is still a malfunction.</p> <p> WARNING</p> <p>If the seat belt buckle extender is not in the predefined position, the seat belt cannot provide the intended level of protection. There is an increased risk of injury.</p> <ul style="list-style-type: none"> ► Visit a qualified specialist workshop. |
| <p> SRS Malfunction Service Required</p> | <p>The restraint system is faulty. The  warning lamp also lights up in the instrument cluster.</p> <p> WARNING</p> <p>The air bags or Emergency Tensioning Devices may either be triggered unintentionally or, in the event of an accident, may not be triggered.</p> <p>There is an increased risk of injury.</p> <ul style="list-style-type: none"> ► Visit a qualified specialist workshop. <p>For further information about the restraint system, see (► page 47).</p> |
| <p> Front Left Malfunction Service Required or Front Right Malfunction Service Required</p> | <p>The restraint system has malfunctioned at the front on the left or right. The  warning lamp also lights up in the instrument cluster.</p> <p> WARNING</p> <p>The air bags or Emergency Tensioning Devices may either be triggered unintentionally or, in the event of an accident, may not be triggered.</p> <p>There is an increased risk of injury.</p> <ul style="list-style-type: none"> ► Visit a qualified specialist workshop. |

| Display messages | Possible causes/consequences and ► Solutions |
|--|---|
|  <p>Rear Left Malfunction Service Required or Rear Right Malfunction Service Required</p> | <p>The restraint system has malfunctioned at the rear on the left or right. The  warning lamp also lights up in the instrument cluster.</p> <p> WARNING</p> <p>The air bags or Emergency Tensioning Devices may either be triggered unintentionally or, in the event of an accident, may not be triggered.</p> <p>There is an increased risk of injury.</p> <p>► Visit a qualified specialist workshop.</p> |
|  <p>Rear Left Malfunction Service Required or Rear Right Malfunction Service Required</p> | <p> WARNING</p> <p>If the seat belt buckle extender is not in the predefined position, the seat belt cannot provide the intended level of protection.</p> <p>There is an increased risk of injury.</p> <p>► Pull over and stop the vehicle safely as soon as possible, paying attention to road and traffic conditions.</p> <p>► Perform the specified assistance measures when display message Check Left Rear Belt See Operator's Manual or Check Right Rear Belt See Operator's Manual is shown (> page 200).</p> <p>If the display message does not disappear:</p> <p>► Visit a qualified specialist workshop immediately.</p> |
|  <p>Rear Center Malfunction Service Required</p> | <p>The restraint system has malfunctioned at the rear center. The  warning lamp also lights up in the instrument cluster.</p> <p> WARNING</p> <p>The air bags or Emergency Tensioning Devices may either be triggered unintentionally or, in the event of an accident, may not be triggered.</p> <p>There is an increased risk of injury.</p> <p>► Visit a qualified specialist workshop.</p> |

| Display messages | Possible causes/consequences and ► Solutions |
|--|---|
| <div data-bbox="218 275 300 320" data-label="Image"> </div> <p data-bbox="210 324 442 532">Left Side Curtain Airbag Malfunction Service Required or Right Side Curtain Airbag Malfunction Service Required</p> | <p data-bbox="465 272 1135 358">There is a malfunction in the left-hand or right-hand window curtain air bag. The  warning lamp also lights up in the instrument cluster.</p> <p data-bbox="479 378 632 408"> WARNING</p> <p data-bbox="465 419 1110 505">The left or right window curtain air bag may either be triggered unintentionally or, in the event of an accident, may not be triggered.</p> <p data-bbox="465 512 827 541">There is an increased risk of injury.</p> <p data-bbox="465 550 864 578">► Visit a qualified specialist workshop.</p> |



Display messages

Front Passenger
Airbag Disabled
See Operator's Manual

Possible causes/consequences and ► Solutions

The front-passenger air bag is deactivated during the journey, even though:

- an adult
or
- a person of the corresponding stature is on the front-passenger seat

If additional forces are applied to the seat, the system may interpret the occupant's weight as lower than it actually is.

 **WARNING**

The front-passenger air bag does not deploy during an accident. There is an increased risk of injury.

- Pull over and stop the vehicle safely as soon as possible, paying attention to road and traffic conditions.
- Secure the vehicle against rolling away (▷ page 154).
- Switch the ignition off.
- Have the occupant get out of the vehicle.
- Keep the seat unoccupied, close the front-passenger door and switch on the ignition.
- Observe the PASSENGER AIR BAG indicator lamps in the center console and the multifunction display and check the following:

Seat unoccupied and ignition switched on:

 - the PASSENGER AIR BAG OFF and PASSENGER AIR BAG ON indicator lamps must light up simultaneously for approximately six seconds.
 - the PASSENGER AIR BAG OFF indicator lamp must then light up and remain lit. If the indicator lamp is on, OCS has disabled the front-passenger air bag (▷ page 58).
 - the display messages [Front Passenger Airbag Enabled See Operator's Manual](#) or [Front Passenger Airbag Disabled See Operator's Manual](#) must not appear in the multifunction display.
- Wait for a period of at least 60 seconds until the necessary system checks have been completed.
- Make sure that the display messages do not appear in the multifunction display.

If these conditions are fulfilled, the front-passenger seat can be occupied again. Whether the PASSENGER AIR BAG OFF or ON indicator lamp remains lit or goes out depends on how OCS classifies the occupant.

If the conditions are not fulfilled, the system is not operating correctly.

| Display messages | Possible causes/consequences and ► Solutions |
|---|---|
| | <p>► Visit a qualified specialist workshop immediately.</p> <p>For further information about the Occupant Classification System, see (► page 58).</p> |
| <p>Front Passenger Airbag Enabled See Operator's Manual</p> | <p>The front-passenger air bag is enabled during the journey, even though:</p> <ul style="list-style-type: none"> • a child, a small adult or an object weighing less than the system's weight threshold is located on the front-passenger seat or • the front-passenger seat is unoccupied <p>The system may detect objects or forces applying additional weight on the seat.</p> <p> WARNING</p> <p>The air bag may deploy unintentionally. There is an increased risk of injury.</p> <ul style="list-style-type: none"> ► Pull over and stop the vehicle safely as soon as possible, paying attention to road and traffic conditions. ► Secure the vehicle against rolling away (► page 154). ► Switch the ignition off. ► Open the front-passenger door. ► Remove the child and the child restraint system from the front-passenger seat. ► Make sure that there are no objects on the seat adding to the weight. <p>The system may otherwise detect the additional weight and interpret the seat occupant's weight as greater than it actually is.</p> <ul style="list-style-type: none"> ► Keep the seat unoccupied, close the front-passenger door and switch on the ignition. ► Observe the PASSENGER AIR BAG indicator lamps in the center console and the multifunction display and check the following: Seat unoccupied and ignition switched on: <ul style="list-style-type: none"> • the PASSENGER AIR BAG OFF and PASSENGER AIR BAG ON indicator lamps must light up simultaneously for approximately six seconds. • the PASSENGER AIR BAG OFF indicator lamp must then light up and remain lit. If the indicator lamp is on, OCS (Occupant Classification System) has deactivated the front-passenger air bag (► page 58). • the display messages Front Passenger Airbag Enabled See Operator's Manual or Front Passenger Airbag |

| Display messages | Possible causes/consequences and ► Solutions |
|------------------|---|
| | <p data-bbox="484 259 1108 318">Disabled See Operator's Manual must not appear in the multifunction display.</p> <ul style="list-style-type: none"> <li data-bbox="439 327 1108 387">► Wait for a period of at least 60 seconds until the necessary system checks have been completed. <li data-bbox="439 396 1108 455">► Make sure that the display messages do not appear in the multifunction display. <p data-bbox="439 464 1108 577">If these conditions are fulfilled, the front-passenger seat can be occupied again. Whether the PASSENGER AIR BAG OFF or ON indicator lamp remains lit or goes out depends on how OCS classifies the occupant.</p> <p data-bbox="439 585 1108 645">If the conditions are not fulfilled, the system is not operating correctly.</p> <ul style="list-style-type: none"> <li data-bbox="439 654 1108 677">► Visit a qualified specialist workshop immediately. <p data-bbox="439 686 1108 745">For further information about the Occupant Classification System, see (► page 58).</p> |

Engine

Display messages



Coolant Too Hot
Stop Vehicle Turn
Engine Off

Possible causes/consequences and ► Solutions

The coolant is too hot.
A warning tone also sounds.

 **WARNING**



Do not drive when your engine is overheated. This can cause some fluids which may have leaked into the engine compartment to catch fire.

Steam from the overheated engine can also cause serious burns which can occur just by opening the hood.

There is a risk of injury.



- Pull over and stop the vehicle safely and switch off the engine, paying attention to road and traffic conditions.
- Secure the vehicle against rolling away (► page 154).
- Wait until the engine has cooled down.
- Make sure that the air supply to the engine radiator is not blocked, e.g. by snow, slush or ice.
- Do not start the engine again until the display message goes out and the coolant temperature is below 257 °F (125 °C). Otherwise, the engine could be damaged.
- Pay attention to the coolant temperature display.
- If the temperature increases again, visit a qualified specialist workshop immediately.

Under normal operating conditions and with the specified coolant level, the coolant temperature may rise to 255 °F (124 °C).

| Tires | |
|--------------------------|---|
| Display messages | Possible causes/consequences and ► Solutions |
| Check Tire Pressure Soon | <p>Canada only: The tire pressure loss warning system has detected a significant loss in pressure. A warning tone also sounds. Possible causes:</p> <ul style="list-style-type: none"> • you have changed the positions of the wheels and tires or installed new wheels and tires. • the tire pressure in one or more tires is not correct. <p> WARNING</p> <p>With tire pressures which are too low, there is a risk of the following hazards:</p> <ul style="list-style-type: none"> • they may burst, especially as the load and vehicle speed increase. • they may wear excessively and/or unevenly, which may greatly impair tire traction. • the driving characteristics, as well as steering and braking, may be greatly impaired. <p>There is a risk of an accident.</p> <ul style="list-style-type: none"> ► Stop the vehicle without making any sudden steering or braking maneuvers. Pay attention to the traffic conditions as you do so. ► Secure the vehicle against rolling away (▷ page 154). ► Check the tires and, if necessary, follow the instructions for a flat tire (▷ page 257). ► Check the tire pressures and, if necessary, correct the tire pressure. ► Restart the tire pressure loss warning system when the tire pressure is correct (▷ page 286). |
| Check Tires | <p>The tire pressure in one or more tires has dropped significantly. The wheel position is displayed in the multifunction display. A warning tone also sounds.</p> <p> WARNING</p> |

| Display messages | Possible causes/consequences and ► Solutions |
|---------------------------------|--|
| | <p>With tire pressures which are too low, there is a risk of the following hazards:</p> <ul style="list-style-type: none"> • they may burst, especially as the load and vehicle speed increase. • they may wear excessively and/or unevenly, which may greatly impair tire traction. • the driving characteristics, as well as steering and braking, may be greatly impaired. <p>There is a risk of an accident.</p> <ul style="list-style-type: none"> ► Stop the vehicle without making any sudden steering or braking maneuvers. Pay attention to the traffic conditions as you do so. ► Secure the vehicle against rolling away (▷ page 154). ► Check the tires and, if necessary, follow the instructions for a flat tire (▷ page 257). ► Check the tire pressure (▷ page 282). ► If necessary, correct the tire pressure. |
| <p>Warning Tire Malfunction</p> | <p>The tire pressure in one or more tires has dropped suddenly. The wheel position is shown in the multifunction display.</p> <p> WARNING</p> <p>If you drive with a flat tire, there is a risk of the following hazards:</p> <ul style="list-style-type: none"> • a flat tire affects the ability to steer or brake the vehicle. • you could lose control of the vehicle. • continued driving with a flat tire will cause excessive heat build-up and possibly a fire. <p>There is a risk of an accident.</p> <ul style="list-style-type: none"> ► Stop the vehicle without making any sudden steering or braking maneuvers. Pay attention to the traffic conditions as you do so. ► Secure the vehicle against rolling away (▷ page 154). ► Check the tires and, if necessary, follow the instructions for a flat tire (▷ page 257). |

| Vehicle | |
|---|--|
| Display messages | Possible causes/consequences and ► Solutions |
|  | <p>The hood is open. A warning tone also sounds.</p> <p>⚠ WARNING</p> <p>The open hood may block your view when the vehicle is in motion. There is a risk of an accident.</p> <ul style="list-style-type: none"> ► Pull over and stop the vehicle safely as soon as possible, paying attention to road and traffic conditions. ► Secure the vehicle against rolling away (▷ page 154). ► Close the hood. |
| <p>To view the ext. mirror, adjust front-passenger seat or remove the head restraint.</p> | <p>The front-passenger seat is in the chauffeur mode position and the head restraint is folded down.</p> <p>⚠ WARNING</p> <p>If the front-passenger seat is in the chauffeur mode position and the head restraint is folded down, the view of the front-passenger exterior mirror can be impaired. There is a risk of an accident.</p> <ul style="list-style-type: none"> ► Remove the head restraint on the front-passenger seat (▷ page 112). <p>or</p> <ul style="list-style-type: none"> ► Move the front-passenger seat into the normal position (▷ page 112). |

| Display messages | Possible causes/consequences and ► Solutions |
|---|--|
| <p>Front-Passenger Seat Cannot Be Used Visit Workshop</p> | <ul style="list-style-type: none"> • The front-passenger seat cannot be moved from the chauffeur mode position into the normal position. There is a malfunction. • The front-passenger seat head restraint is folded down and there is a malfunction. The head restraint can no longer be folded up. <p> WARNING</p> <p>If head restraints are not adjusted correctly, they cannot provide protection as intended.</p> <p>There is an increased risk of injury in the head and neck area, e.g. in the event of an accident or when braking.</p> <ul style="list-style-type: none"> ► Do not use the front-passenger seat. ► Visit a qualified specialist workshop. |
| <p> Power Steering Malfunction See Operator's Manual</p> | <p>The power steering is malfunctioning. A warning tone also sounds.</p> <p> WARNING</p> <p>You will need to use more force to steer. There is a risk of an accident.</p> <ul style="list-style-type: none"> ► Check whether you are able to apply the extra force required. ► If you are able to steer safely: carefully drive on to a qualified specialist workshop. ► If you are unable to steer safely: do not drive on. Contact the nearest qualified specialist workshop. |

Warning and indicator lamps in the instrument cluster

General notes

This section describes indicator and warning lamps in the instrument cluster relevant to safety and solutions. A description of other indicator and warning lamps in the instrument cluster and their solutions can be found in the Digital Operator's Manual.

Safety

Seat belts

Warning/
indicator
lamp

▷ Signal type

Possible causes/consequences and ▶ Solutions



▷ After starting the engine, the red seat belt warning lamp lights up for 6 seconds.

The seat belt warning lamp reminds the driver and front passenger to fasten their seat belts.

- ▶ Fasten your seat belt (▷ page 52).



▷ After starting the engine, the red seat belt warning lamp lights up. In addition, a warning tone sounds for up to 6 seconds.

The driver's seat belt is not fastened.

- ▶ Fasten your seat belt (▷ page 52).

The warning tone ceases.



▷ The red seat belt warning lamp lights up after the engine starts, as soon as the driver's or the front-passenger door is closed.

The driver or front passenger has not fastened their seat belt.

- ▶ Fasten your seat belt (▷ page 52).

The warning lamp goes out.

There are objects on the front-passenger seat.

- ▶ Remove the objects from the front-passenger seat and stow them in a secure place.

The warning lamp goes out.



▷ The red seat belt warning lamp flashes and an intermittent audible warning sounds.

The driver or front passenger has not fastened their seat belt. The vehicle is being driven faster than 15 mph (25 km/h) or has briefly been driven faster than 15 mph (25 km/h).

- ▶ Fasten your seat belt (▷ page 52).











The warning lamp goes out and the intermittent warning tone ceases.

There are objects on the front-passenger seat. The vehicle is being driven faster than 15 mph (25 km/h) or has briefly been driven faster than 15 mph (25 km/h).

- ▶ Remove the objects from the front-passenger seat and stow them in a secure place.

The warning lamp goes out and the intermittent warning tone ceases.

Safety systems

| Warning/ indicator lamp | ▷ Signal type Possible causes/consequences and ▶ Solutions |
|---|---|
|   | <p>▷  (USA only),  (Canada only): the red brake system warning lamp is lit while the engine is running. A warning tone also sounds.</p> <p> WARNING</p> <p>The brake boosting effect is malfunctioning and the braking characteristics may be affected.</p> <p>There is a risk of an accident.</p> <ul style="list-style-type: none"> ▶ Pull over and stop the vehicle safely as soon as possible, paying attention to road and traffic conditions. Do not continue driving under any circumstances. ▶ Secure the vehicle against rolling away (▷ page 154). ▶ Consult a qualified specialist workshop. ▶ Observe the additional display messages in the multifunction display. |
|   | <p>▷  (USA only),  (Canada only): the red brake system warning lamp is lit while the engine is running. A warning tone also sounds.</p> <p>There is not enough brake fluid in the brake fluid reservoir.</p> <p> WARNING</p> <p>The braking effect may be impaired.</p> <p>There is a risk of an accident.</p> <ul style="list-style-type: none"> ▶ Pull over and stop the vehicle safely as soon as possible, paying attention to road and traffic conditions. Do not continue driving under any circumstances. ▶ Secure the vehicle against rolling away (▷ page 154). ▶ Do not add brake fluid. Adding more will not remedy the malfunction. ▶ Consult a qualified specialist workshop. ▶ Observe the additional display messages in the multifunction display. |

Warning/
indicator
lamp

▷ Signal type

Possible causes/consequences and ▶ Solutions



▷ The yellow ABS warning lamp is lit while the engine is running.

ABS (Anti-lock Braking System) is deactivated due to a malfunction. Therefore BAS (Brake Assist System), BAS PLUS with Cross-Traffic Assist, COLLISION PREVENTION ASSIST PLUS, ESP® (Electronic Stability Program), PRE-SAFE®, PRE-SAFE® PLUS, PRE-SAFE® Brake, the HOLD function, hill start assist, Crosswind Assist, STEER CONTROL, Active Lane Keeping Assist and Active Blind Spot Assist are also deactivated.

ATTENTION ASSIST is deactivated.

WARNING

The brake system continues to function normally, but without the functions listed above. The wheels could therefore lock if you brake hard, for example. The steerability and braking characteristics may be severely affected. The braking distance in an emergency braking situation can increase.

If ESP® is not operational, ESP® is unable to stabilize the vehicle.

There is an increased risk of skidding and an accident.

- ▶ Observe the additional display messages in the multifunction display.
- ▶ Drive on carefully.
- ▶ Visit a qualified specialist workshop.

If the ABS control unit is faulty, there is also a possibility that other systems, such as the navigation system or the automatic transmission, will not be available.

**Warning/
indicator
lamp****▷ Signal type****Possible causes/consequences and ▶ Solutions**

▷ The yellow ABS warning lamp is lit while the engine is running. A warning tone also sounds.

EBD is not available due to a malfunction. Therefore ABS, BAS, BAS PLUS with Cross-Traffic Assist, COLLISION PREVENTION ASSIST PLUS, ESP®, PRE-SAFE®, PRE-SAFE® PLUS, PRE-SAFE® Brake, the HOLD function, hill start assist, Crosswind Assist, STEER CONTROL, Active Lane Keeping Assist and Active Blind Spot Assist are also unavailable.

ATTENTION ASSIST is deactivated.

 WARNING

The brake system continues to function normally, but without the functions listed above. The front and rear wheels could therefore lock if you brake hard, for example.

The steerability and braking characteristics may be severely affected. The braking distance in an emergency braking situation can increase.

If ESP® is not operational, ESP® is unable to stabilize the vehicle.

There is an increased risk of skidding and an accident.

- ▶ Observe the additional display messages in the multifunction display.
- ▶ Drive on carefully.
- ▶ Visit a qualified specialist workshop.

Warning/
indicator
lamp

▷ Signal type

Possible causes/consequences and ▶ Solutions



▷ (USA only), (Canada only): the red brake warning lamp, the yellow ESP[®] warning lamp and the yellow ABS warning lamp are lit while the engine is running.

ABS and ESP[®] are not available due to a malfunction. Therefore BAS, BAS PLUS with Cross-Traffic Assist, COLLISION PREVENTION ASSIST PLUS, EBD, PRE-SAFE[®], PRE-SAFE[®] PLUS, PRE-SAFE[®] Brake, the HOLD function, hill start assist, Crosswind Assist, STEER CONTROL, Active Lane Keeping Assist and Active Blind Spot Assist are also unavailable.

ATTENTION ASSIST is deactivated.

WARNING

The brake system continues to function normally, but without the functions listed above. The front and rear wheels could therefore lock if you brake hard, for example.

The steerability and braking characteristics may be severely affected. The braking distance in an emergency braking situation can increase.

If ESP[®] is not operational, ESP[®] is unable to stabilize the vehicle.

There is an increased risk of skidding and an accident.

- ▶ Observe the additional display messages in the multifunction display.
- ▶ Drive on carefully.
- ▶ Visit a qualified specialist workshop.



▷ The yellow ESP[®] warning lamp is lit while the engine is running.

ESP[®], BAS, BAS PLUS with Cross-Traffic Assist, COLLISION PREVENTION ASSIST PLUS, PRE-SAFE[®], PRE-SAFE[®] PLUS, PRE-SAFE[®] Brake, the HOLD function, hill start assist, Crosswind Assist, STEER CONTROL, Active Lane Keeping Assist and Active Blind Spot Assist are unavailable due to a malfunction.

ATTENTION ASSIST is deactivated.

WARNING





The brake system continues to function normally, but without the functions listed above.

The braking distance in an emergency braking situation can thus increase.

If ESP[®] is not operational, ESP[®] is unable to stabilize the vehicle.

There is an increased risk of skidding and an accident.

- ▶ Observe the additional display messages in the multifunction display.
- ▶ Drive on carefully.
- ▶ Visit a qualified specialist workshop.

| Warning/ indicator lamp | ▷ Signal type Possible causes/consequences and ▶ Solutions |
|---|---|
|  | <p>▷ The yellow ESP[®] OFF warning lamp is lit while the engine is running. ESP[®] is deactivated.</p> <p> WARNING</p> <p>If ESP[®] is switched off, ESP[®] is unable to stabilize the vehicle. There is an increased risk of skidding and an accident.</p> <ul style="list-style-type: none"> ▶ Reactivate ESP[®]. <ul style="list-style-type: none"> In rare cases (▷ page 80), it may be best to deactivate ESP[®]. Observe the important safety notes on ESP[®] (▷ page 80). ▶ Adapt your driving style to suit the road and weather conditions. <p>If ESP[®] cannot be activated:</p> <ul style="list-style-type: none"> ▶ Drive on carefully. ▶ Have ESP[®] checked at a qualified specialist workshop. |
|  | <p>▷ The red restraint system warning lamp is lit while the engine is running. The restraint system is faulty.</p> <p> WARNING</p> <p>The air bags or Emergency Tensioning Devices may either be triggered unintentionally or, in the event of an accident, may not be triggered. There is an increased risk of injury.</p> <ul style="list-style-type: none"> ▶ Observe the additional display messages in the multifunction display. ▶ Drive on carefully. ▶ Have the restraint system checked at a qualified specialist workshop immediately. <p>For further information about the restraint system, see (▷ page 47).</p> |

Engine

Warning/
indicator
lamp

▷ Signal type

Possible causes/consequences and ▶ Solutions



▷ The red coolant warning lamp comes on while the engine is running. A warning tone also sounds.

The coolant temperature has exceeded 255 °F (124 °C). The airflow to the engine radiator may be blocked or the coolant level may be too low.

 **WARNING**

The engine is not being cooled sufficiently and may be damaged.

Do not drive when your engine is overheated. This can cause some fluids which may have leaked into the engine compartment to catch fire.

Steam from the overheated engine can also cause serious burns which can occur just by opening the hood.

There is a risk of injury.

- ▶ Observe the additional display messages in the multifunction display.
- ▶ Pull over and stop the vehicle safely and switch off the engine, paying attention to road and traffic conditions.
- ▶ Secure the vehicle against rolling away (▷ page 154).
- ▶ Leave the vehicle and keep a safe distance from the vehicle until the engine has cooled down.
- ▶ Check the coolant level and add coolant, observing the warning notes (▷ page 250).
- ▶ If you need to add coolant more often than usual, have the engine coolant system checked.
- ▶ Make sure that the air supply to the engine radiator is not blocked, e.g. by snow, slush or ice.
- ▶ At coolant temperatures below 257 °F (125 °C), you can continue driving to the nearest qualified specialist workshop.
- ▶ Avoid subjecting the engine to heavy loads, e.g. driving in mountainous terrain, and stop-and-go traffic.

Driving systems

Warning/
indicator
lamp

▷ Signal type

Possible causes/consequences and ► Solutions





▷ The red distance warning lamp lights up while the vehicle is in motion. A warning tone also sounds.

You are approaching a vehicle or a stationary obstacle in your line of travel at too high a speed.

- ▶ Be prepared to brake immediately.
- ▶ Pay careful attention to the traffic situation. You may have to brake or take evasive action.

Further information on PRE-SAFE® Brake (▷ page 82).

For further information about the distance warning function of COLLISION PREVENTION ASSIST PLUS, see (▷ page 78).

| Tires | |
|---|--|
| Warning/ indicator lamp | ▷ Signal type Possible causes/consequences and ▶ Solutions |
|  | <p>▷ The yellow tire pressure monitor warning lamp (pressure loss/malfunction) is lit.</p> <p>The tire pressure monitor has detected a loss of pressure in at least one of the tires.</p> <p>⚠ WARNING</p> <p>With tire pressures which are too low, there is a risk of the following hazards:</p> <ul style="list-style-type: none"> • they may burst, especially as the load and vehicle speed increase. • they may wear excessively and/or unevenly, which may greatly impair tire traction. • the driving characteristics, as well as steering and braking, may be greatly impaired. <p>There is a risk of an accident.</p> <ul style="list-style-type: none"> ▶ Stop the vehicle without making any sudden steering or braking maneuvers. Pay attention to the traffic conditions as you do so. ▶ Secure the vehicle against rolling away (▷ page 154). ▶ Observe the additional display messages in the multifunction display. ▶ Check the tires and, if necessary, follow the instructions for a flat tire (▷ page 257). ▶ Check the tire pressure (▷ page 282). ▶ If necessary, correct the tire pressure. |
|  | <p>▷ The yellow tire pressure monitor warning lamp (pressure loss/malfunction) flashes for approximately one minute and then remains lit.</p> <p>The tire pressure monitor is faulty.</p> <p>⚠ WARNING</p> <p>The system is possibly unable to recognize or register low tire pressure. There is a risk of an accident.</p> <ul style="list-style-type: none"> ▶ Observe the additional display messages in the multifunction display. ▶ Visit a qualified specialist workshop. |

Vehicle

Warning/
indicator
lamp

▷ Signal type

Possible causes/consequences and ► Solutions



▷ The red power steering warning lamp is lit while the engine is running. The power steering is malfunctioning. A warning tone also sounds.

 **WARNING**

You will need to use more force to steer.
There is a risk of an accident.

- ▶ Check whether you are able to apply the extra force required.
- ▶ **If you are able to steer safely:** carefully drive on to a qualified specialist workshop.
- ▶ **If you are unable to steer safely:** do not drive on. Contact the nearest qualified specialist workshop.

| | |
|----------------------------------|-----|
| Useful information | 224 |
| General notes | 224 |
| Important safety notes | 224 |
| Declarations of conformity | 225 |
| Information on copyright | 225 |
| Function restrictions | 225 |
| COMAND operating system | 226 |

Useful information

These Operating Instructions describe all the standard and optional equipment of your COMAND system, as available at the time of going to print. Country-specific differences are possible. Please note that your COMAND system may not be equipped with all the features described. This also applies to safety-relevant systems and functions.

These Operating Instructions describe all the standard and optional equipment for Audio 20, as available at the time of going to press. Country-specific differences are possible.

Please note that your Audio 20 system may not be equipped with all the features described. This also applies to safety-relevant systems and functions.

Please read the information on qualified specialist workshops: (▷ page 30).

General notes

The COMAND section in these operating instructions describes the basic principles for operating your COMAND. More information can be found in the Digital Operator's Manual.

Important safety notes

WARNING

Modifications to electronic components, their software as well as wiring can impair their function and/or the function of other networked components. In particular, systems relevant to safety could also be affected. As a result, these may no longer function as intended and/or jeopardize the operating safety of the vehicle. There is an increased risk of an accident and injury.

Never tamper with the wiring as well as electronic components or their software. You should have all work to electrical and elec-

tronic equipment carried out at a qualified specialist workshop.

If you make any changes to the vehicle electronics, the general operating permit is rendered invalid.

WARNING

If you operate information systems and communication equipment integrated in the vehicle while driving, you will be distracted from traffic conditions. You could also lose control of the vehicle. There is a risk of an accident.

Only operate the equipment when the traffic situation permits. If you are not sure that this is possible, park the vehicle paying attention to traffic conditions and operate the equipment when the vehicle is stationary.

You must observe the legal requirements for the country in which you are currently driving when operating COMAND.

COMAND calculates the route to the destination without taking account of the following, for example:

- traffic lights
- stop and yield signs
- merging lanes
- parking or stopping in a no parking/no stopping zone
- other road and traffic rules and regulations
- narrow bridges

COMAND can give incorrect navigation commands if the actual street/traffic situation does not correspond with the digital map's data. Digital maps do not cover all areas nor all routes in an area. For example, a route may have been diverted or the direction of a one-way street may have changed.

For this reason, you must always observe road and traffic rules and regulations during your journey. Road and traffic rules and regulations always have priority over the system's driving recommendations.

Navigation announcements are intended to direct you while driving without diverting your attention from the road and driving.

Please always use this feature instead of consulting the map display for directions. Looking at the icons or map display can distract you from traffic conditions and driving, and increase the risk of an accident.

Bear in mind that at a speed of only 30 mph (approximately 50 km/h) your vehicle covers a distance of 44 feet (approximately 14 m) per second.

This equipment complies with FCC radiation exposure limits set forth for uncontrolled equipment and meets the FCC radio frequency (RF) Exposure Guidelines in Supplement C to OET65.

This equipment has very low levels of RF energy that is deemed to comply without maximum permissive exposure evaluation (MPE). But it is desirable that it should be installed and operated with at least 8 inches (20 cm) and more between the radiator and a person's body (excluding extremities: hands, wrists, feet and legs.)

Declarations of conformity

Vehicle components which receive and/or transmit radio waves

USA only: The wireless devices of this vehicle comply with Part 15 of the FCC Rules. Operation is subject to the following two conditions:

- 1) These devices may not cause interference, and
- 2) These devices must accept any interference, including interference that may cause undesired operation of the device.

Changes or modifications not expressly approved by the party responsible for compliance could void the user's authority to operate the equipment.

Canada only: The wireless devices of this vehicle comply with Industry Canada license-

exempt RSS standard(s). Operation is subject to the following two conditions:

- 1) These devices may not cause interference, and
- 2) These devices must accept any interference, including interference that may cause undesired operation of the device.

Information on copyright

General information

Information on licenses for free and Open Source software used in your vehicle and in the electronic components can be found on this website: <http://www.mercedes-benz.com/opensource>.

Function restrictions

For safety reasons, some functions are restricted or unavailable while the vehicle is in motion. You will notice this, for example, because either you will not be able to select certain menu items or a message will appear to this effect.

COMAND operating system

Overview

Components

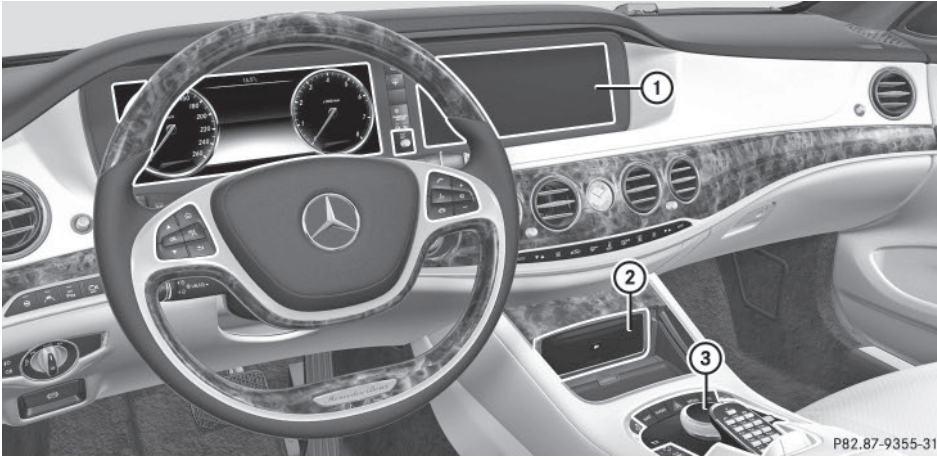

P82.87-9355-31

COMAND

- ① COMAND display
- ② DVD changer/single DVD drive
- ③ Controller and buttons

The image shows the equipment with telephone keypad.

COMAND consists of:

- the COMAND display
 - The COMAND display has 1440 x 540 pixels.
 - the DVD changer/single DVD drive
 - the controller
 - the touch-sensitive telephone keypad or the touchpad
 - the buttons
 - ports in the center console (2x USB, AUX)
 - An iPod® is connected via USB cable.
 - headphones for the front passenger (cordless or connected by means of a cable to the audio jack in the footwell)
- i** COMAND can be operated from the front-passenger side using the corresponding remote control if your vehicle is equipped with the front-passenger entertainment system. The COMAND display can show separate information for the driver and the front passenger. The front passenger views the display in SPLITVIEW.

Functions

- **HD FM radio/HD AM radio/satellite radio**

Internet radio (called up via communications functions)

- **Media**

Media support: audio CD, MP3 CD, DVD video, 2 x USB, SD card, iPod®, Bluetooth® audio, 10 GB Media Register on the hard drive

Music search using all media

- **Sound systems**

You can select from three sound systems:

Standard sound system

Burmester® surround sound system

Burmester high-end 3D surround sound system for ultimate listening pleasure

- **Navigation system**

Destination entry using keyword search

Realistic 3D map with textured city models

Navigation functions for passengers, such as Drive Information and Google Maps™

Dynamic route guidance via SIRIUS satellite radio

- **Communication**

Messaging functions (text messages, email)

Address book

Internet browser

Mercedes-Benz Apps with Google™ Local Search, Destination Download, Weather, Facebook, Google Street View™, Internet radio, stock prices, news and much more

WiFi interface for the connection of a smartphone to COMAND Online and the option of remote control for the front passenger (SPLITVIEW) and the Rear Seat Entertainment System

Mercedes-Benz Mobile Website

WiFi hotspot functionality to connect a tablet PC or laptop in order to enable access to the Internet using the customer's mobile phone

- **SIRIUS Weather**

Weather data as an information chart (current forecast, 5-day preview, detailed information)

Weather data on the weather map, e.g. rain radar data, storm characteristics and the track of tropical cyclones (hurricanes, typhoons)

- **Vehicle functions**

Setting the multicontour seat with new massage program

Climate control functions

Controlling ambient lighting: several color and brightness level options

360° camera

Rear view camera

- **Favorites functions**

Fast access to up to twelve favorites functions using the favorites button and number keys on the telephone keypad (if available) or the favorites button on the touchpad (if available).

- **Multi-Seat Entertainment System**

All passengers have access to entertainment options via COMAND

Business telephony in the rear compartment

Digital remote control operation and digital cordless headphones

COMAND display

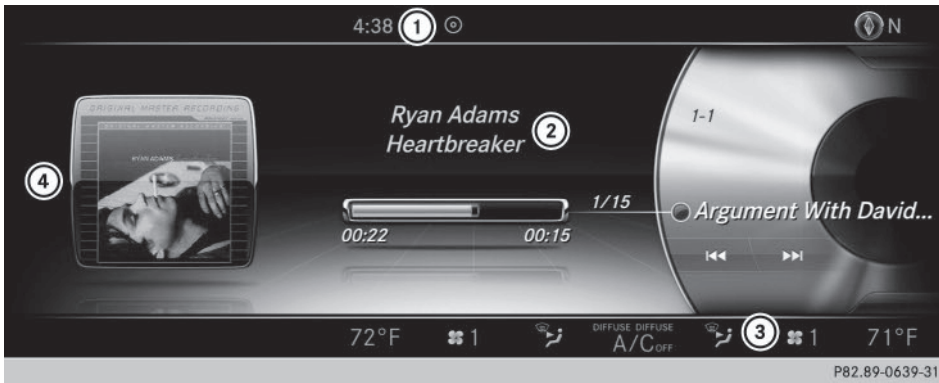

Example: audio CD mode basic display

- ① Status bar with time, can show other displays
- ② Main display field
- ③ Climate control status display
- ④ Context display in additional display area

COMAND

Controller and buttons

Overview



- ① Switches COMAND on/off
- ② Adjusts the volume or mutes
- ③ Telephone keypad
- ④ Back button
- ⑤ Seat adjustment button

- ⑥ Navigation button
- ⑦ Radio button
- ⑧ Media button
- ⑨ Telephone, address book and Internet button
- ⑩ Vehicle and system settings button
- ⑪ Controller
- ⑫  Favorites button

The image shows the equipment with telephone keypad.

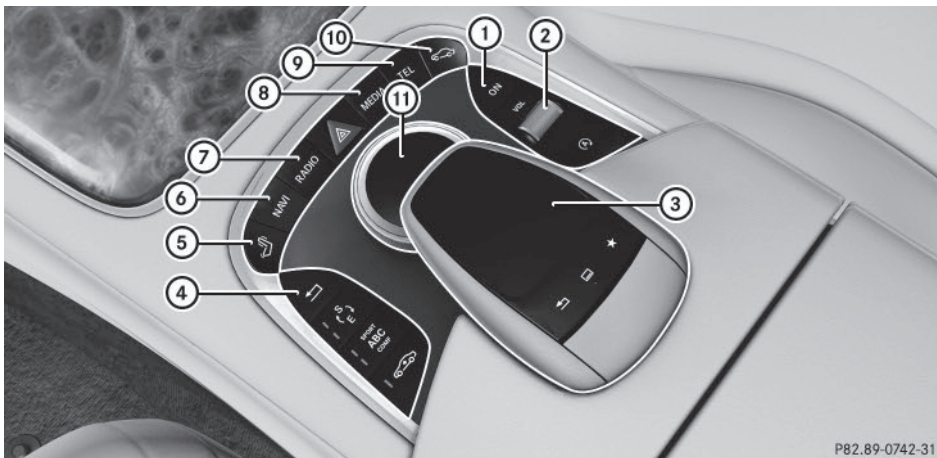



COMAND

- ① Switches COMAND on/off
- ② Adjusts the volume or mutes
- ③ Touchpad
- ④ Back button
- ⑤ Seat adjustment button
- ⑥ Navigation button
- ⑦ Radio button
- ⑧ Media button
- ⑨ Telephone, address book and Internet button
- ⑩ Vehicle and system settings button
- ⑪ Controller

The image shows the equipment with touchpad.

Back button

You can use the  button to exit a menu or to call up the basic display of the current operating mode.

- ▶ **To exit the menu:** briefly press the  button.
COMAND changes to the next higher menu level in the current operating mode.
- ▶ **To call up the basic display:** press the  button for longer than two seconds.
COMAND changes to the basic display of the current operating mode.

Telephone keypad

The telephone keypad is touch-sensitive: as soon as one or several of the keys are gently touched, the telephone keypad is shown in the COMAND display. The key being touched is highlighted.



Alternatively, COMAND may be equipped with a touchpad.

Controller

The controller in the center console lets you:

- select menu items on the display
- enter characters
- select a destination on the map
- save entries

The controller can be:

- turned
- slid left or right 
- slid forwards or back 
- slid diagonally 
- pressed briefly or pressed and held

Touchpad

Alternatively, COMAND may be equipped with a touchpad instead of a telephone keypad.

As an alternative to the controller, the touchpad enables menu items to be selected and character entry including handwriting recognition, for example.

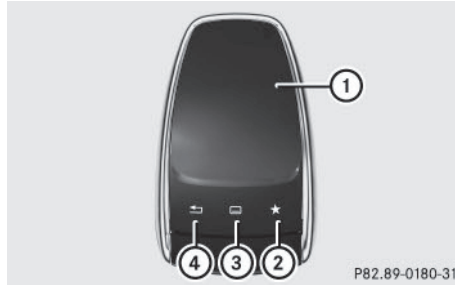

P82.89-0180-31

- ① Touch-sensitive surface
- ② Favorites button
- ③ Calls up quick access for audio and telephone
- ④ Back button

- ▶ **To activate the touchpad:** press the surface of the touchpad.

Do not press your fingers too hard on the touchpad. Do not use any sharp objects on the touchpad. This can lead to damage to the touchpad or to malfunctions.

| | |
|--------------------------|-----|
| Useful information | 232 |
| Stowage areas | 232 |
| Features | 235 |

Useful information

- i** This Operator's Manual describes all models and all standard and optional equipment of your vehicle available at the time of publication of the Operator's Manual. Country-specific differences are possible. Please note that your vehicle may not be equipped with all features described. This also applies to safety-related systems and functions.
- i** Read the information on qualified specialist workshops (▷ page 30).

Stowage areas

Loading guidelines

WARNING

Combustion engines emit poisonous exhaust gases such as carbon monoxide. Exhaust gases can enter the vehicle interior if the trunk lid is open when the engine is running, especially if the vehicle is in motion. There is a risk of poisoning.

Always switch off the engine before opening the trunk lid. Never drive with the trunk lid open.

WARNING

If objects, luggage or loads are not secured or not secured sufficiently, they could slip, tip over or be flung around and thereby hit vehicle occupants. There is a risk of injury, particularly in the event of sudden braking or a sudden change in direction.

Always store objects so that they cannot be flung around. Secure objects, luggage or loads against slipping or tipping before the journey.

WARNING

The exhaust tail pipe and tail pipe trim can become very hot. If you come into contact with these parts of the vehicle, you could burn yourself. There is a risk of injury.

Always be particularly careful around the exhaust tail pipe and the tail pipe trim. Allow these components to cool down before touching them.

The handling characteristics of a laden vehicle are dependent on the distribution of the load within the vehicle. For this reason, you should observe the following notes when transporting a load:

- Never exceed the maximum permissible gross vehicle weight or the gross axle weight rating of the vehicle (including occupants). The values are specified on the vehicle identification plate on the B-pillar of the driver's door.
- The trunk is the preferred place to carry objects.
- Position heavy loads as far forwards as possible and as low down in the trunk as possible.
- The load must not protrude above the upper edge of the seat backrests.
- Always place the load behind unoccupied seats if possible.
- Secure the load with sufficiently strong and wear-resistant tie-downs. Pad sharp edges for protection.

Stowage spaces

Important safety notes

WARNING

If you do not correctly store objects in the vehicle interior, they can slip or be flung around, thus striking vehicle occupants. There is a risk of injury, especially when braking or abruptly changing directions.

- Always store objects so that they cannot be flung around in these or in similar situations.
- Always make sure that objects do not protrude from stowage compartments, parcel nets or stowage nets.

- Close lockable stowage compartments while driving.
- Stow and secure objects that are heavy, hard, pointy, sharp-edged, fragile or too large in the trunk.

Observe the loading guidelines (▷ page 232).

Information in the Digital Operator's Manual

In the Digital Operator's Manual you will find information on the following topics:

- Glove box
- Eyeglasses compartment
- Stowage compartments in the center console
- Stowage compartment under the armrest
- Stowage compartment under the front seats
- Stowage compartments in the doors
- Folding table
- Stowage compartment in the rear seat armrest
- Stowage compartment in the rear-compartment center console
- Stowage box in the rear seat backrest

Stowage nets

Stowage nets are located:

- in the front-passenger footwell
- on the back of the driver's and the front-passenger seat
- on the left and right-hand side in the trunk

Observe the loading guidelines (▷ page 232) and the safety notes regarding stowage spaces (▷ page 232).

Securing loads using parcel net hooks

General notes

Observe the following notes on securing loads:

- Secure the load using the parcel net hooks.
- Do not use elastic straps or nets to secure a load, as these are only intended as an anti-slip protection for light loads.
- Do not route tie-downs across sharp edges or corners.
- Pad sharp edges for protection.

Trunk



Vehicles without PLUG-IN hybrid drive

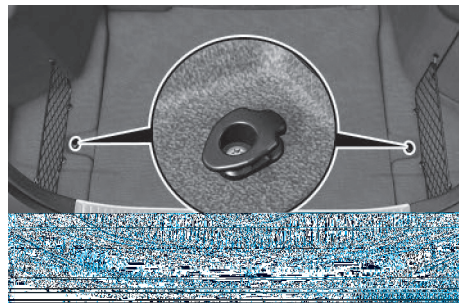

PLUG-IN HYBRID vehicles

There are four parcel net hooks or two parcel net hooks (PLUG-IN HYBRID vehicles) in the trunk.

Stowage well under the trunk floor

Under the trunk floor you can find a multi-purpose recess, e.g. for TIREFIT.

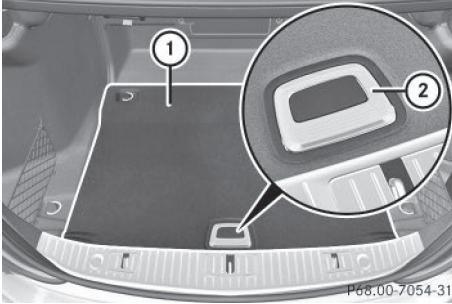

- ▶ **To open:** open the trunk lid.
- ▶ Holding the ribbing, press handle (2) downwards. Handle (2) folds upwards.
- ▶ Swing trunk floor (1) upwards using handle (2) until it rests against the trunk partition.

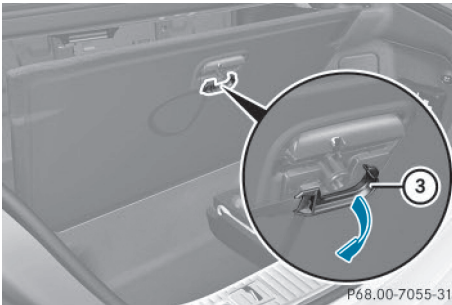

- ▶ Fold out hook (3) on the underside of the trunk floor.

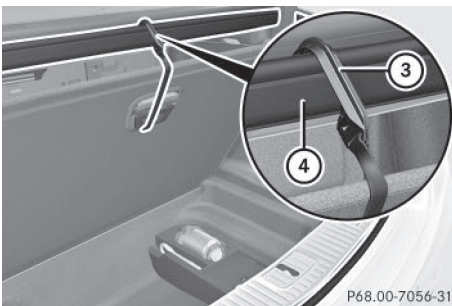

- ▶ Clip hook (3) into groove (4).
- ▶ **To close:** unclip hook (3) from groove (4).
- ▶ Fasten hook (3) to the bracket on the underside of the trunk floor.
- ▶ Fold the trunk floor down.

Roof carrier

Important safety notes

WARNING

When you load the roof, the center of gravity of the vehicle rises and the driving characteristics change. If you exceed the maximum roof load, the driving characteristics, as well as steering and braking, will be greatly impaired. There is a risk of an accident.

Never exceed the maximum roof load and adjust your driving style.

You will find information on the maximum roof load in the "Technical data" section (> page 327).

- ❗ Mercedes-Benz recommends that you only use roof carriers that have been tested and approved for Mercedes-Benz vehicles. This helps to avoid damage to the vehicle. Position the load on the roof carrier in such a way that the vehicle will not sustain damage even when it is in motion.

Ensure that, depending on the vehicle's equipment, you can raise the panorama roof with power tilt/sliding panel fully and open the trunk lid fully when the roof carrier is installed.

- ❗ To avoid damaging or scratching the covers, do not use metallic or hard objects to open them.

An incorrectly secured roof carrier or roof load may become detached from the vehicle. You must therefore ensure that you observe the roof carrier manufacturer's installation instructions.

Vehicles with a panorama roof with power tilt/sliding panel: the panorama roof with power tilt/sliding panel cannot be opened if a roof carrier is installed. The panorama roof with power tilt/sliding panel can still be raised to allow ventilation of the vehicle interior.

If the panorama roof with power tilt/sliding panel makes contact with a roof carrier approved by Mercedes-Benz, the sunroof will lower slightly but remain raised at the rear.

Attaching the roof carrier

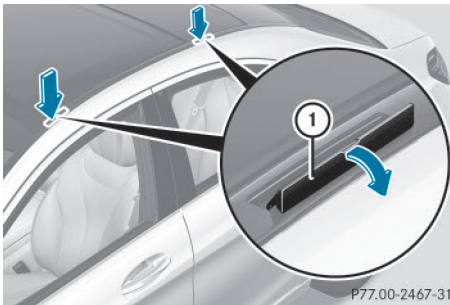

P77.00-2467-31

- ▶ Fold covers ① upwards in the direction of the arrow.
- ▶ Only secure the roof carrier to the anchorage points under covers ①.
- ▶ Observe the manufacturer's installation instructions.

Features

Information in the Digital Operator's Manual

In the Digital Operator's Manual you will find information on the following topics:

- Cup holder
- Rear window roller sunblind
- Rear side window roller sunblinds
- Ashtray
- Cigarette lighter
- 12 V sockets
- 115 V socket

- Coolbox in the rear compartment
- Infrared reflective windshield

Sun visors

Overview

WARNING

If the mirror cover of the vanity mirror is folded up when the vehicle is in motion, you could be blinded by incident light. There is a risk of an accident.

Always keep the mirror cover folded down while driving.

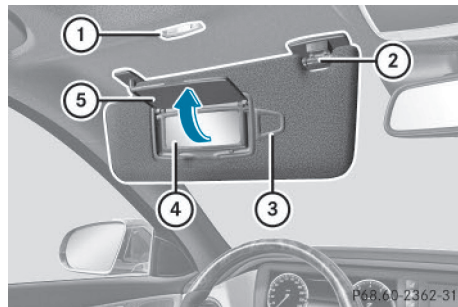

P68.60-2362-31

- ① Mirror light
- ② Bracket
- ③ Retaining clip, e.g. for a car park ticket
- ④ Vanity mirror
- ⑤ Mirror cover

Information in the Digital Operator's Manual

In the Digital Operator's Manual you will find information on the following topics:

- Vanity mirror in the sun visor
- Glare from the side

mbrace**Information in the Digital Operator's Manual**

In the Digital Operator's Manual you will find information on the following topics:

- Downloading destinations in COMAND
- Search & Send
- Vehicle remote opening
- Vehicle remote closing
- Stolen vehicle recovery service
- Vehicle remote malfunction diagnosis
- Downloading routes
- Speed alert
- Geo fencing
- Triggering the vehicle alarm

-  The mbrace system is only available in the USA.

General notes

The mbrace system is only available in the USA.

You must have a license agreement to activate the mbrace service. Make sure that your system is activated and operational. To log in, press the  MB Info call button. If any of the steps mentioned are not carried out, the system may not be activated.

If you have questions about the activation, contact one of the following telephone hot-lines:

Mercedes-Benz Customer Assistance Center at 1-800-FOR-MERcedes (1-800-367-6372) or 1-866-990-9007

Shortly after successfully registering with the mbrace service, a user ID and password will be sent to you by mail. You can use this password to log onto the mbrace area under "Owners Online" at <http://www.mbusa.com>.

The system is available if:



- it has been activated and is operational
- the corresponding mobile phone network is available for transmitting data to the Customer Center
- a service subscription is available
- the starter battery is sufficiently charged

Determining the location of the vehicle on a map is only possible if:

- GPS reception is available.
- the vehicle position can be forwarded to the Customer Assistance Center.

The mbrace system

To adjust the volume during a call, proceed as follows:

- ▶ Press the  or  button on the multifunction steering wheel.

or

- ▶ Use the COMAND volume control.

The system offers various services, e.g.:



- Automatic and manual emergency call
- Roadside Assistance call
- MB Info call



You can find information and a description of all available features under "Owners Online" at <http://www.mbusa.com>.

System self-test

After you have switched on the ignition, the system carries out a self-diagnosis.

A malfunction in the system has been detected if one of the following occurs:

- The indicator lamp in the SOS button does not come on during the system self-test.
- The indicator lamp in the  Roadside Assistance button does not light up during self-diagnosis of the system.
- The indicator lamp in the  MB Info call button does not light up during self-diagnosis of the system.

- The indicator lamp in one or more of the following buttons continues to light up red after the system self-diagnosis:
 - SOS button
 -  Roadside Assistance call button
 -  MB Info call button
- The **Inoperative** or the **Service Not Activated** message appears in the multifunction display after the system self-diagnosis.

If a malfunction is indicated as outlined above, the system may not operate as expected. In the event of an emergency, help will have to be summoned by other means.

Have the system checked at the nearest authorized Mercedes-Benz Center or contact the following service hotlines:

Mercedes-Benz Customer Assistance Center at 1-800-FOR-MERCEdes (1-800-367-6372) or 1-866-990-9007

Emergency call

Important safety notes

WARNING

It can be dangerous to remain in the vehicle, even if you have pressed the SOS button in an emergency if:

- you see smoke inside or outside of the vehicle, e.g. if there is a fire after an accident
- the vehicle is on a dangerous section of road
- the vehicle is not visible or cannot easily be seen by other road users, particularly when dark or in poor visibility conditions

There is a risk of an accident and injury.

Leave the vehicle immediately in this or similar situations as soon as it is safe to do so.

Move to a safe location along with other vehicle occupants. In such situations, secure the vehicle in accordance with national regulations, e.g. with a warning triangle.

General notes

Observe the notes on system activation (> page 236).

An emergency call is dialed automatically if an air bag or Emergency Tensioning Device is triggered. You cannot end an automatically triggered emergency call yourself.

An emergency call can also be initiated manually.

As soon as the emergency call has been initiated, the indicator lamp in the SOS button flashes. The **Connecting Call** message appears in the multifunction display.

The audio output is muted.

Once the connection has been made, the **Call Connected** message appears in the multifunction display.

All important information on the emergency is transmitted, for example:

- current location of the vehicle (as determined by the GPS system)
- vehicle identification number
- information on the severity of the accident

Shortly after the emergency call has been initiated, a voice connection is automatically established between the Customer Assistance Center and the vehicle occupants.

- If the vehicle occupants respond, the Mercedes-Benz Customer Assistance Center attempts to get more information on the emergency.
- If there is no response from the vehicle occupants, an ambulance is immediately sent to the vehicle.

If no voice connection can be established to the Mercedes-Benz Customer Assistance Center, the system has been unable to initiate an emergency call.

This can occur, for example, if the relevant mobile phone network is not available. The indicator lamp in the SOS button flashes continuously.

The **Call Failed** message appears in the multifunction display and must be confirmed.

In this case, summon assistance by other means.

Making an emergency call

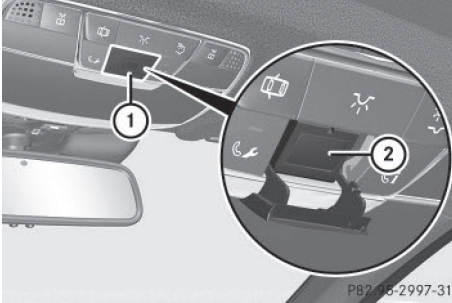

- ▶ **To initiate an emergency call manually:** press cover ① briefly to open.
- ▶ Press SOS button ② briefly. The indicator lamp in SOS button ② flashes until the emergency call is concluded.
- ▶ Wait for a voice connection to the Mercedes-Benz Customer Assistance Center.
- ▶ After the emergency call, close cover ①.

If the mobile phone network is unavailable, mbrace will not be able to make the emergency call. If you leave the vehicle immediately after pressing the SOS button, you will not know whether mbrace placed the emergency call. In this case, always summon assistance by other means.

Roadside Assistance button

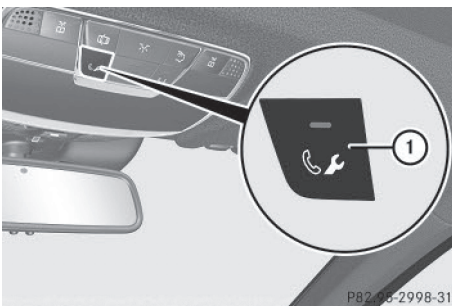

- ▶ **To call Roadside Assistance:** press Roadside Assistance button ①.

This initiates a call to the Mercedes-Benz Customer Assistance Center.

The indicator lamp in Roadside Assistance button ① flashes while the call is active.

The **Connecting Call** message appears in the multifunction display. The audio output is muted.

If a connection can be made, the **Call Connected** message appears in the multifunction display.

If a mobile phone network and GPS reception are available, the system transfers data to the Mercedes-Benz Customer Assistance Center, for example:

- current location of the vehicle
- vehicle identification number

The COMAND display indicates that a call is active. During the call, you can change to the navigation menu by pressing the NAVI button on COMAND, for example.

Voice output is not available in this case.

A voice connection is established between the Mercedes-Benz Customer Assistance Center and the vehicle occupants.

From the remote malfunction diagnosis, the Mercedes-Benz Customer Assistance Center can ascertain the nature of the problem. In the Digital Operator's Manual, you will find information on remote malfunction diagnosis.

The Mercedes-Benz Customer Assistance Center either sends a qualified Mercedes-Benz technician or makes arrangements for your vehicle to be transported to the nearest authorized Mercedes-Benz Center.

You may be charged for services such as repair work and/or towing.

You can find more information in the separate mbrace manual.

The system has not been able to initiate a Roadside Assistance call, if:

- the indicator lamp for Roadside Assistance call button  is flashing continuously.
- no voice connection to the Mercedes-Benz Customer Assistance Center was established.

This can occur if the relevant mobile phone network is not available, for example.

The **Call Failed** message appears in the multifunction display.

► **To end a call:** press the  button on the multifunction steering wheel.

or

► Press the corresponding COMAND button for ending a phone call.

MB Info call button

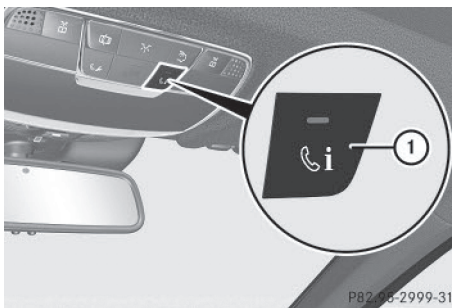

► **To call MB Info:** press MB Info call button ①.

This initiates a call to the Mercedes-Benz Customer Assistance Center.

The indicator lamp in MB Info call button ① flashes while the connection is being made.

The **Connecting Call** message appears in the multifunction display. The audio output is muted.

If a connection can be established, the **Call Connected** message appears in the multifunction display.

If a mobile phone network and GPS reception are available, the system transfers data to the Mercedes-Benz Customer Assistance Center, for example:

- current location of the vehicle
- vehicle identification number

The COMAND display indicates that a call is active. During the call, you can change to the navigation menu by pressing the NAVI button on COMAND, for example.

Voice output is not available in this case.

A voice connection is established between the Mercedes-Benz Customer Assistance Center and the vehicle occupants.

You receive information about operating your vehicle, about the nearest authorized Mercedes-Benz Center and about other products and services from Mercedes-Benz.

You can find further information on the mbrace system under "Owners Online" at <http://www.mbusa.com>.

The system has not been able to initiate an MB Info call, if:

- the indicator lamp in MB Info call button  is flashing continuously.
- no voice connection to the Mercedes-Benz Customer Assistance Center was established.

This can occur if the relevant mobile phone network is not available, for example.

The **Call Failed** message appears in the multifunction display.

► **To end a call:** press the  button on the multifunction steering wheel.

or

► Press the corresponding COMAND button for ending a phone call.

Call priority

When service calls are active, e.g. Roadside Assistance or MB Info calls, an emergency call can still be initiated. In this case, an emergency call will take priority and override all other active calls.

The indicator lamp of the respective button flashes until the call is ended.

An emergency call can only be terminated by the Mercedes-Benz Customer Assistance Center.

All other calls can be ended by pressing:

- the  button on the multifunction steering wheel
- the corresponding button in COMAND to end the voice call

When a call is initiated, the audio system is muted.

The mobile phone is no longer connected to COMAND.

However, if you want to use your mobile phone, do so only when the vehicle is stationary and in a safe location.

Garage door opener

General notes

The HomeLink® garage door opener integrated in the rear-view mirror allows you to operate up to three different door and gate systems.

Use the integrated garage door opener only on garage doors that:

- have safety stop and reverse features and
- meet current U.S. federal safety standards

Once programmed, the integrated garage door opener in the rear-view mirror will assume the function of the garage door system's remote control. Please also read the operating instructions for the garage door system.

When programming a garage door opener, park the vehicle outside the garage. Do not run the engine while programming.

Certain garage door drives are incompatible with the integrated garage door opener. If you have difficulty programming the integrated garage door opener, contact an authorized Mercedes-Benz Center.

Alternatively, you can call the following telephone assistance services:

- **USA:** Mercedes-Benz Customer Assistance Center at 1-800-FOR-MERCEdes
- **Canada:** Customer Service at 1-800-387-0100
- HomeLink® hotline 1-800-355-3515 (free of charge)

More information on HomeLink® and/or compatible products is also available online at <http://www.homelink.com>.

Notes on the declaration of conformity (▷ page 29).

USA: FCC ID: CB2HMIHL4

Canada: IC: 279B-HMIHL4

Important safety notes

WARNING

When you operate or program the garage door with the integrated garage door opener, persons in the range of movement of the garage door can become trapped or struck by the garage door. There is a risk of injury.

When using the integrated garage door opener, always make sure that nobody is within the range of movement of the garage door.

WARNING

Combustion engines emit poisonous exhaust gases such as carbon monoxide. Inhaling these exhaust gases leads to poisoning. There is a risk of fatal injury. Therefore never leave the engine running in enclosed spaces without sufficient ventilation.

Programming

Programming buttons

Pay attention to the "Important safety notes" (▷ page 240).

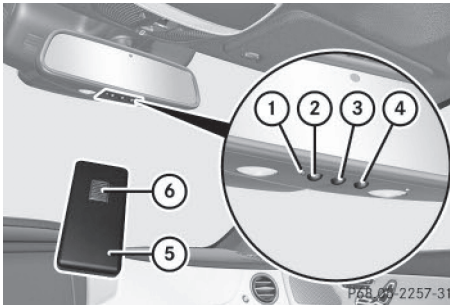

Garage door remote control ⑤ is not included with the integrated garage door opener.

- ▶ Turn the SmartKey to position **2** in the ignition lock (▷ page 133).
- ▶ Select one of buttons ② to ④ to use to control the garage door drive.

- ▶ **To start programming mode:** press and hold one of buttons ② to ④ on the integrated garage door opener.

The garage door opener is now in programming mode. After a short time, indicator lamp ① lights up yellow.

Indicator lamp ① lights up yellow as soon as button ②, ③ or ④ is programmed for the first time. If the selected button has already been programmed, indicator lamp ① will only light up yellow after ten seconds have elapsed.

- ▶ Release button ②, ③ or ④. Indicator lamp ① flashes yellow.
- ▶ **To program the remote control:** point garage door remote control ⑤ towards buttons ② to ④ on the rear-view mirror at a distance of 2 to 8 inches (5 to 20 cm).
- ▶ Press and hold button ⑥ on remote control ⑤ until indicator lamp ① lights up green. When indicator lamp ① lights up green: programming is finished.

When indicator lamp ① flashes green: programming was successful. The next step is

to synchronize the rolling code (▷ page 241).

- ▶ Release button ⑥ on remote control ⑤ for the garage door drive system.

If indicator lamp ① lights up red: repeat the programming procedure for the corresponding button on the rear-view mirror. When doing so, vary the distance between remote control ⑤ and the rear-view mirror.

The required distance between remote control ⑤ and the integrated garage door opener depends on the garage door drive system. Several attempts might be necessary. You should test every position for at least 25 seconds before trying another position.

Synchronizing the rolling code

Pay attention to the "Important safety notes" (▷ page 240).

If the garage door system uses a rolling code, you will also have to synchronize the garage door system with the integrated garage door opener in the rear-view mirror. To do this you will need to use the programming button on the door drive control panel. The programming button may be positioned at different locations depending on the manufacturer. It is usually located on the door drive unit on the garage ceiling.

Familiarize yourself with the garage door drive operating instructions, e.g. under "Programming of additional remote controls", before carrying out the following steps.

Your vehicle must be within reach of the garage door or gate opener drive. Make sure that neither your vehicle nor any persons/objects are present within the sweep of the door or gate.

- ▶ Turn the SmartKey to position **2** in the ignition lock (▷ page 133).
- ▶ Get out of the vehicle.
- ▶ Press the programming button on the door drive unit.

Usually, you now have 30 seconds to initiate the next step.

- ▶ Get into the vehicle.
- ▶ Press previously programmed button ②, ③ or ④ on the integrated garage door opener until the door closes. The rolling code synchronization is then complete.

Notes on programming the remote control

Canadian radio frequency laws require a "break" (or interruption) of the transmission signals after broadcasting for a few seconds. Therefore, these signals may not last long enough for the integrated garage door opener. The signal is not recognized during programming. Comparable with Canadian law, some U.S. garage door openers also feature a "break".

Proceed as follows:

- if you live in Canada
- if you have difficulties programming the garage door opener (regardless of where you live) when using the programming steps
- ▶ Press and hold one of buttons ② to ④ on the integrated garage door opener. After a short time, indicator lamp ① lights up yellow.
- ▶ Release the button. Indicator lamp ① flashes yellow.
- ▶ Press button ⑥ of garage door remote control ⑤ for two seconds, then release it for two seconds.
- ▶ Press button ⑥ again for two seconds.
- ▶ Repeat this sequence on button ⑥ of remote control ⑤ until indicator lamp ① lights up green. When indicator lamp ① lights up green: programming is finished.

When indicator lamp ① flashes green: programming was successful. The next step is to synchronize the rolling code.

- ▶ Release button ⑥ of remote control ⑤ of the garage door drive. If indicator lamp ① lights up red: repeat the programming process for the corresponding button on the rear-view mirror. When doing so, vary the distance between remote control ⑤ and the rear-view mirror. The required distance between remote control ⑤ and the integrated garage door opener depends on the garage door drive system. Several attempts might be necessary. You should test every position for at least 25 seconds before trying another position.

Problems when programming

If you are experiencing problems programming the integrated garage door opener on the rear-view mirror, take note of the following instructions:

- Check the transmitter frequency used by garage door drive remote control ⑤ and whether it is supported. The transmitter frequency can usually be found on the back of the garage door drive remote control. The integrated garage door opener is compatible with devices that have units which operate in the frequency range of 280 to 433 MHz.
- Replace the batteries in garage door remote control ⑤. This increases the likelihood that garage door remote control ⑤ will transmit a strong and precise signal to the integrated garage door opener.
- When programming, hold remote control ⑤ at varying distances and angles from the button which you are programming. Try various angles at a distance between 2 and 12 inches (5 to 30 cm) or at the same angle but at varying distances.
- If another remote control is available for the same garage door drive, repeat the same programming steps with this remote con-

- trol. Before performing these steps, make sure that new batteries have been installed in garage door drive remote control ⑤.
- Note that some remote controls only transmit for a limited amount of time (the indicator lamp on the remote control goes out). Press button ⑥ on remote control ⑤ again before transmission ends.
 - Align the antenna cable of the garage door opener unit. This can improve signal reception/transmission.

Opening/closing the garage door

After it has been programmed, the integrated garage door opener performs the function of the garage door system remote control. Please also read the operating instructions for the garage door system.

- ▶ Turn the SmartKey to position **2** in the ignition lock (▷ page 133).
- ▶ Press button ②, ③ or ④ which you have programmed to operate the garage door. Garage door system with a fixed code: indicator lamp ① lights up green.
Garage door system with a rolling code: indicator lamp ① flashes green.
The transmitter will transmit a signal as long as the button is pressed. The transmission is halted after a maximum of ten seconds and indicator lamp ① lights up yellow.
- ▶ Press button ②, ③ or ④ again if necessary.

Clearing the memory

Make sure that you clear the memory of the integrated garage door opener before selling the vehicle.

- ▶ Turn the SmartKey to position **2** in the ignition lock (▷ page 133).
- ▶ Press and hold buttons ② and ④. The indicator lamp initially lights up yellow and then green.
- ▶ Release buttons ② and ④. The memory of the integrated garage door opener in the rear-view mirror is cleared.

Floormats

WARNING

Objects in the driver's footwell can restrict the pedal travel or obstruct a depressed pedal. The operating and road safety of the vehicle is jeopardized. There is a risk of an accident.

Make sure that all objects in the vehicle are stowed correctly, and that they cannot enter the driver's footwell. Install the floormats securely and as specified in order to ensure sufficient clearance for the pedals. Do not use loose floormats and do not place floormats on top of one another.

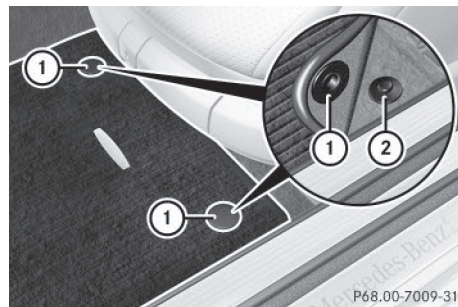

- ▶ **Driver's seat/front-passenger seat:** slide the respective seat back.
- ▶ **Rear seats:** slide the respective seat forwards.
- ▶ **To install:** place the floormat in the footwell.
- ▶ Press studs ① onto retainers ② until you hear them engage.

- ▶ **To remove:** pull the floormat from retainers ②.
- ▶ Remove the floormat.

| | |
|--------------------------|-----|
| Useful information | 246 |
| Engine compartment | 246 |
| ASSYST PLUS | 252 |
| Care | 252 |

Useful information

- i** This Operator's Manual describes all models and all standard and optional equipment of your vehicle available at the time of publication of the Operator's Manual. Country-specific differences are possible. Please note that your vehicle may not be equipped with all features described. This also applies to safety-related systems and functions.
- i** Read the information on qualified specialist workshops (▷ page 30).

Engine compartment

Hood

Important safety notes

WARNING

If the hood is unlatched, it may open up when the vehicle is in motion and block your view. There is a risk of an accident.
Never unlatch the hood while driving.

WARNING

When opening and closing the hood, it may suddenly fall into the closed position. There is a risk of injury to persons within range of movement of the hood.
Open and close the hood only when no one is within its range of movement.

WARNING

Opening the hood when the engine is overheated or when there is a fire in the engine compartment could expose you to hot gases or other service products. There is a risk of injury.

Let an overheated engine cool down before opening the hood. If there is a fire in the engine compartment, keep the hood closed and contact the fire department.

WARNING

The engine compartment contains moving components. Certain components, such as the radiator fan, may continue to run or start again suddenly when the ignition is off. There is a risk of injury.

If you need to do any work inside the engine compartment:

- switch off the ignition
- never reach into the area where there is a risk of danger from moving components, such as the fan rotation area
- remove jewelry and watches
- keep items of clothing and hair, for example, away from moving parts

WARNING

The ignition system and the fuel injection system work under high voltage. If you touch components which are under voltage, you could get an electric shock. There is a risk of injury.

Never touch components of the ignition system or fuel injection system when the ignition is switched on.

Opening the hood

WARNING

Certain components in the engine compartment, such as the engine, radiator and parts of the exhaust system, can become very hot. Working in the engine compartment poses a risk of injury.

Where possible, let the engine cool down and touch only the components described in the following.

WARNING

When the hood is open and the windshield wipers are set in motion, you can be injured by the wiper linkage. There is a risk of injury.

Always switch off the windshield wipers and the ignition before opening the hood.

! Make sure that the windshield wipers are not folded away from the windshield. You could otherwise damage the windshield wipers or the hood.

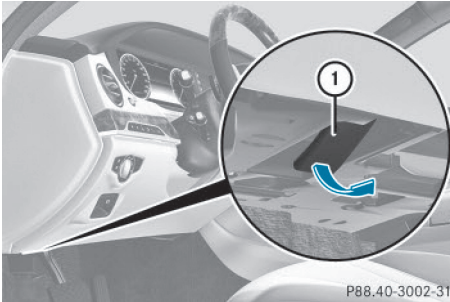

P88.40-3002-31

- ▶ Make sure that the windshield wipers are turned off.
- ▶ Pull release lever ① on the hood. The hood is released.



P88.40-3003-31

- ▶ Reach into the gap, pull hood catch handle ② up and lift the hood. Once you have lifted the hood about 15 inches (40 cm), it is automatically opened the rest of the way and held open by the gas-filled struts.

Closing the hood

- ▶ Lower the hood and let it fall from a height of approximately 8 in (20 cm).
- ▶ Check that the hood has engaged properly. If the hood can be raised slightly, it is not properly engaged. Open it again and close it with a little more force.

Engine oil

General notes

Depending on your driving style, the vehicle consumes up to 0.9 US qt (0.8 liters) of oil per 600 miles (1,000 km). The oil consumption may be higher than this when the vehicle is new or if you frequently drive at high engine speeds.

Depending on the engine, the oil dipstick may be in a different location.

When checking the oil level:

- park the vehicle on a level surface.
- the engine should be switched off for approximately five minutes if the engine is at normal operating temperature.
- if the engine is not at normal operating temperature, e.g. if the engine was only started briefly, wait about 30 minutes before carrying out the measurement.

Checking the oil level using the oil dipstick (except S 600 and S 65 AMG)

⚠ WARNING

Certain components in the engine compartment, such as the engine, radiator and parts of the exhaust system, can become very hot. Working in the engine compartment poses a risk of injury.

Where possible, let the engine cool down and touch only the components described in the following.

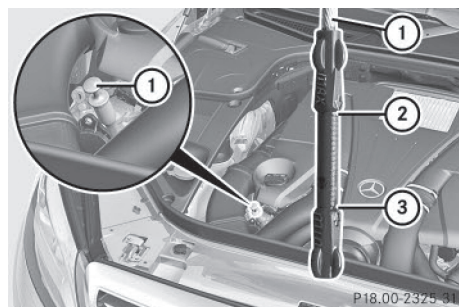







P18.00-2325-31

Example

- ▶ Pull oil dipstick ① out of the dipstick guide tube.
- ▶ Wipe off oil dipstick ①.
- ▶ Slowly slide oil dipstick ① into the guide tube to the stop, and take it out again. If the level is between MIN mark ③ and MAX mark ②, the oil level is correct.
- ▶ If the oil level has dropped to MIN mark ③ or below, add 1.1 US qt (1.0 liter) of engine oil.

Checking the oil level using the on-board computer (S 600 and S 65 AMG)

- ▶ Make sure that the SmartKey is in position **2** in the ignition lock.
- ▶ Use  on the steering wheel to call up the list of menus.
- ▶ Press the  or  button on the steering wheel to select the **Service** menu.
- ▶ Confirm by pressing  on the steering wheel.
- ▶ Use  or  to select the **Engine Oil Level** submenu.
- ▶ Press  to confirm the selection.
The **Measuring engine oil level accurate only when vehicle is level** message appears in the multifunction display.

The measurement takes a few seconds. You will see one of the following messages in the multifunction display:

| Display messages | Possible causes/consequences and ► Solutions |
|---|--|
| Engine Oil Level OK | The oil level is correct. |
| Check Engine Oil Level (Add 1 Liter) | The oil level is too low. ▶ Top up 1.1 US qt (1.0 liter) of engine oil. |
| Reduce Engine Oil Level | The engine oil level is too high. ▶ Have excess engine oil siphoned off. |
| For Engine Oil Level Ignition Must Be On | The ignition is switched off. ▶ Turn the SmartKey to position 2 in the ignition lock. |
| Need More Time to Check Engine Oil Level | The required waiting period was not observed. ▶ If the engine is at normal operating temperature: repeat the measurement after about five minutes. If the engine is not at normal operating temperature, e.g. if the engine was only started briefly: repeat the measurement after approximately 30 minutes. |
| Engine Oil Level Not Measurable with Engine Running | The engine is running; oil level measurement is not possible. ▶ Switch off the engine. ▶ If the engine is at normal operating temperature: wait about five minutes before carrying out the measurement. If the engine is not at normal operating temperature, e.g. if the engine was only started briefly: wait approximately 30 minutes before carrying out the measurement. |

Adding engine oil

 **WARNING**

Certain components in the engine compartment, such as the engine, radiator and parts

of the exhaust system, can become very hot. Working in the engine compartment poses a risk of injury.

Where possible, let the engine cool down and touch only the components described in the following.

WARNING

If engine oil comes into contact with hot components in the engine compartment, it may ignite. There is a risk of fire and injury.

Make sure that engine oil is not spilled next to the filler neck. Let the engine cool down and thoroughly clean the engine oil off the components before starting the engine.

Environmental note

When adding oil, take care not to spill any. If oil enters the soil or waterways, it is harmful to the environment.

- !** Only use engine oils and oil filters that have been approved for vehicles with a service system. You can obtain a list of the engine oils and oil filters tested and approved in accordance with the Mercedes-Benz Specifications for Service Products at any Mercedes-Benz Service center.

Damage to the engine or exhaust system is caused by the following:

- using engine oils and oil filters that have not been specifically approved for the service system
- replacing engine oil and oil filters after the interval for replacement specified by the service system has been exceeded
- using engine oil additives.

- !** Do not add too much oil. adding too much engine oil can result in damage to the engine or to the catalytic converter. Have excess engine oil siphoned off.

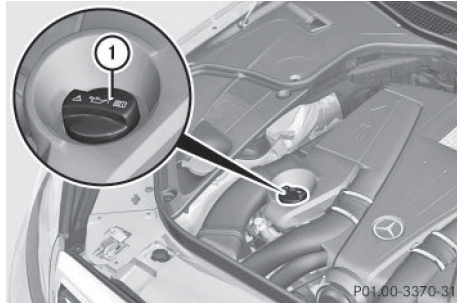

Example

- ▶ Turn cap ① counter-clockwise and remove it.
- ▶ Add engine oil.
If the oil level is at or below the MIN mark on the oil dipstick, add 1.1 US qt (1.0 l) of engine oil.
- ▶ Replace cap ① on the filler neck and turn clockwise.
Ensure that the cap locks into place securely.
- ▶ Check the oil level again with the oil dipstick (▷ page 247).

Further information on engine oil (▷ page 323).

Additional service products

Checking coolant level

WARNING

Certain components in the engine compartment, such as the engine, radiator and parts of the exhaust system, can become very hot. Working in the engine compartment poses a risk of injury.

Where possible, let the engine cool down and touch only the components described in the following.

WARNING

The engine cooling system is pressurized, particularly when the engine is warm. When

opening the cap, you could be scalded by hot coolant spraying out. There is a risk of injury. Let the engine cool down before opening the cap. Wear eye and hand protection when opening the cap. Open the cap slowly half a turn to allow pressure to escape.

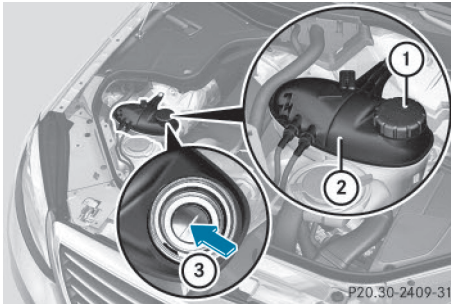

- ▶ Park the vehicle on a level surface. Only check the coolant level when the vehicle is on a level surface and the engine has cooled down.
 - ▶ Turn the SmartKey to position **2** in the ignition lock (▷ page 133).
- or
- ▶ Press Start/Stop button twice (▷ page 133).
 - ▶ Check the coolant temperature display in the instrument cluster. The coolant temperature must be below 158 °F (70 °C).
 - ▶ Turn the SmartKey to position **0** (▷ page 133) in the ignition lock.
- or
- ▶ Remove Start/Stop button from ignition lock (▷ page 133).
 - ▶ Slowly turn cap ① half a turn counter-clockwise to allow excess pressure to escape.
 - ▶ Turn cap ① further counter-clockwise and remove it. If the coolant is at the level of marker bar ③ in the filler neck when cold, there is enough coolant in coolant expansion tank ②.

If the coolant level is approximately 0.6 in (1.5 cm) above marker bar ③ in the filler neck when warm, there is enough coolant in expansion tank ②.

- ▶ If necessary, add coolant that has been tested and approved by Mercedes-Benz.
- ▶ Replace cap ① and turn it clockwise as far as it will go.

PLUG-IN HYBRID vehicles: the second coolant expansion tank must not be filled. For further information on coolant, see (▷ page 325).

Adding washer fluid to the windshield washer system

WARNING

Certain components in the engine compartment, such as the engine, radiator and parts of the exhaust system, can become very hot. Working in the engine compartment poses a risk of injury. Where possible, let the engine cool down and touch only the components described in the following.

WARNING

Windshield washer concentrate could ignite if it comes into contact with hot engine components or the exhaust system. There is a risk of fire and injury. Make sure that no windshield washer concentrate is spilled next to the filler neck.

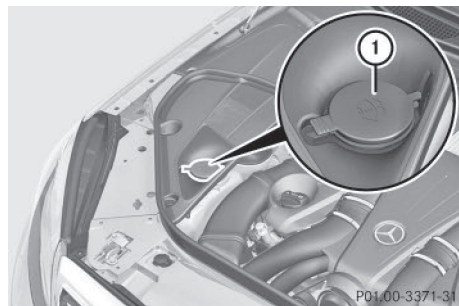

- ▶ **To open:** pull cap ① upwards by the tab.
- ▶ Place cap ① on the edge of the filler neck and engage in place.
- ▶ Add the premixed washer fluid.
- ▶ **To close:** press cap ① onto the filler neck until it engages.

If the washer fluid level drops below the recommended minimum of 1 liter, a message appears in the multifunction display prompting you to add washer fluid.

Further information on windshield washer fluid/antifreeze (> page 326).

ASSYST PLUS

The Digital Operator's Manual contains more information on the ASSYST PLUS service interval display.

Care

General notes

♻ Environmental note

Dispose of empty packaging and cleaning cloths in an environmentally responsible manner.

- ❗ For cleaning your vehicle, do not use any of the following:

- dry, rough or hard cloths
- abrasive cleaning agents
- solvents
- cleaning agents containing solvents

Do not scrub.

Do not touch the surfaces or protective films with hard objects, e.g. a ring or ice scraper. You could otherwise scratch or damage the surfaces and protective film.

- ❗ Do not park the vehicle for an extended period straight after cleaning it, particularly after having cleaned the wheels with wheel cleaner. Wheel cleaners could cause

increased corrosion of the brake discs and brake pads/linings. For this reason, you should drive for a few minutes after cleaning. Braking heats the brake discs and the brake pads/linings, thus drying them. The vehicle can then be parked.

Regular care of your vehicle is a condition for retaining the quality in the long term.

Use care products and cleaning agents recommended and approved by Mercedes-Benz.

Exterior care

Automatic car wash

⚠ WARNING

Braking efficiency is reduced after washing the vehicle. There is a risk of an accident.

After the vehicle has been washed, brake carefully while paying attention to the traffic conditions until full braking power is restored.

- ❗ If DISTRONIC PLUS or the HOLD function is activated, the vehicle brakes automatically in certain situations. To prevent damage to the vehicle, deactivate DISTRONIC PLUS and the HOLD function in the following or other similar situations:

- when towing the vehicle
- in the car wash

- ❗ Never clean your vehicle in a Touchless Automatic Car Wash as these use special cleaning agents. These cleaning agents can damage the paintwork or plastic parts.

- ❗ Make sure that:

- the side windows and the sliding sunroof are fully closed.
- the ventilation/heating is switched off (the OFF button has been pressed).
- the windshield wiper switch is at position 0.
- the 360° camera or rear view camera is switched off.

The vehicle may otherwise be damaged.

! If the SmartKey is within the rear detection range of KEYLESS-GO, the following situations, for example, could lead to the unintentional opening of the trunk:

- using a car wash
- using a power washer

Make sure that the SmartKey is at least 10 ft (3 m) away from the vehicle.

! Make sure that the automatic transmission is in neutral position **N** when washing your vehicle in a tow-through car wash. The vehicle may otherwise be damaged.

- Operating with the SmartKey:

Do not remove the SmartKey from the ignition lock. Do not open the driver's door when the engine is switched off or at very low speeds. Otherwise, when in transmission position **D** or **R** the automatic transmission will automatically switch to park position **P** and block the wheels.

- Operating with the Start/Stop button:

Do not open the driver's door when the engine is switched off or at very low speeds. Otherwise, when in transmission position **D** or **R** the automatic transmission will automatically switch to park position **P** and block the wheels.

Observe the following to make sure that the automatic transmission stays in position **N** neutral:

Operating with the SmartKey:

- ▶ Make sure that the ignition is switched on.
- ▶ Make sure that the vehicle is stationary.
- ▶ Depress and hold the brake pedal.
- ▶ Shift to neutral **N**.
- ▶ Release the brake pedal.
- ▶ Release the electric parking brake, if necessary.
- ▶ Switch off the ignition and leave the SmartKey in the ignition lock.

Operating with the Start/Stop button:

- ▶ Make sure that the ignition is switched on.
- ▶ Make sure that the vehicle is stationary.
- ▶ Depress and hold the brake pedal.
- ▶ Engage park position **P**.
- ▶ Release the brake pedal.
- ▶ Remove Start/Stop button from ignition lock (▷ page 133).
- ▶ Insert the SmartKey into the ignition lock.
- ▶ Switch on the ignition.
- ▶ Depress and hold the brake pedal.
- ▶ Shift to neutral **N**.
- ▶ Release the brake pedal.
- ▶ Release the electric parking brake, if necessary.
- ▶ Switch off the ignition and leave the SmartKey in the ignition lock.

You can wash the vehicle in an automatic car wash from the very start.

If the vehicle is very dirty, pre-wash it before cleaning it in an automatic car wash.

After using an automatic car wash, wipe off wax from the windshield and the wiper blades. This will prevent smears and reduce wiping noises caused by residue on the windshield.

Information in the Digital Operator's Manual

In the Digital Operator's Manual you will find information on the following topics:

- Washing by hand
- Power washers
- Cleaning the paintwork
- Matte finish care
- Cleaning the wheels
- Cleaning the windows
- Cleaning wiper blades
- Cleaning the exterior lighting
- Cleaning the mirror turn signals
- Cleaning the sensors
- Cleaning the rear view camera

- Cleaning the 360° camera
- Cleaning the exhaust pipe

Interior care

In the Digital Operator's Manual you will find information on the following topics:

- Cleaning the display
- Cleaning Night and Day View Assist
- Cleaning the plastic trim
- Cleaning the steering wheel and selector lever
- Cleaning genuine wood and trim strips
- Cleaning the seat covers
- Cleaning the seat belts
- Cleaning the headliner and carpets

| | |
|-------------------------------|-----|
| Useful information | 256 |
| Where will I find...? | 256 |
| Flat tire | 257 |
| Battery (vehicle) | 261 |
| Jump-starting | 266 |
| Towing and tow-starting | 269 |
| Fuses | 272 |

Useful information

- i** This Operator's Manual describes all models and all standard and optional equipment of your vehicle available at the time of publication of the Operator's Manual. Country-specific differences are possible. Please note that your vehicle may not be equipped with all features described. This also applies to safety-related systems and functions.
- i** Read the information on qualified specialist workshops (▷ page 30).

Where will I find...?

Vehicle tool kit

General notes

The towing eye is located in the stowage well under the trunk floor.

- i** Apart from certain country-specific variations, the vehicles are not equipped with a tire-change tool kit. Some tools for changing a wheel are specific to the vehicle. For more information on which tire changing tools are required and approved to perform a wheel change on your vehicle, consult a qualified specialist workshop.

Tools required for changing a wheel may include, for example:

- Jack
- Wheel chock
- Lug wrench
- Ratchet wrench
- Alignment bolt

Vehicles with a TIREFIT kit

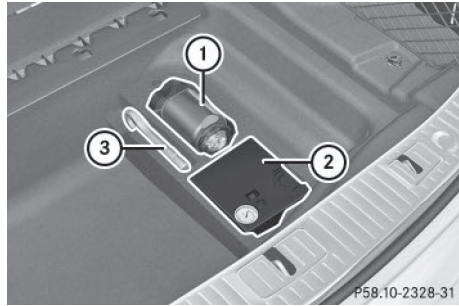

Example

- ① Tire sealant filler bottle
 - ② Tire inflation compressor
 - ③ Towing eye
- ▶ Open the trunk lid.
 - ▶ Lift the trunk floor upwards (▷ page 234).
 - ▶ Use the TIREFIT kit (▷ page 258).

AMG vehicles

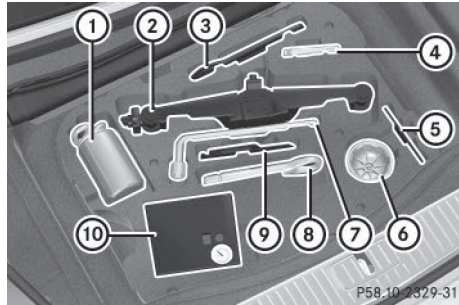

Example: equipment and country-specific variations possible

- ① Tire sealant filler bottle
- ② Jack
- ③ Ratchet
- ④ Alignment bolt
- ⑤ Jacking support
- ⑥ Socket
- ⑦ Lug wrench
- ⑧ Towing eye
- ⑨ Folding wheel chock
- ⑩ Tire inflation compressor

The tire-change tool kit is kept in a tray in the stowage well under the trunk floor.

- ▶ Open the trunk lid.
- ▶ Lift the trunk floor upwards (▷ page 234).

Flat tire

Preparing the vehicle

Your vehicle may be equipped with:

- tires with run-flat characteristics (MOExtended tires) (▷ page 257)
Vehicle preparation is not necessary on vehicles with MOExtended tires
- a TIREFIT kit (▷ page 256)

Information on changing/mounting a wheel (▷ page 298).

- ▶ Stop the vehicle on solid, non-slippery and level ground, as far away as possible from traffic.
- ▶ Switch on the hazard warning lamps.
- ▶ Secure the vehicle against rolling away (▷ page 154).
- ▶ If possible, bring the front wheels into the straight-ahead position.
- ▶ Switch off the engine.
- ▶ Open the driver's door.
The on-board electronics now have status **0**. This is the same as the SmartKey having been removed.
- ▶ Remove Start/Stop button from ignition lock (▷ page 133).

or, if the SmartKey is inserted in the ignition lock:

- ▶ Remove the SmartKey from the ignition lock.
- ▶ All occupants must get out of the vehicle. Make sure that they are not endangered as they do so.
- ▶ Make sure that no one is near the danger area while a wheel is being changed. Anyone who is not directly assisting in the wheel change should, for example, stand behind the barrier.

- ▶ Get out of the vehicle. Pay attention to traffic conditions when doing so.
- ▶ Close the driver's door.

MOExtended tires (tires with run-flat properties)

General notes

With MOExtended tires (tires with run flat characteristics), you can continue to drive your vehicle even if there is a total loss of pressure in one or more tires. The affected tire must not show any clearly visible damage. You can recognize MOExtended tires by the MOExtended marking which appears on the sidewall of the tire. You will find this marking next to the tire size designation, the load-bearing capacity and the speed index (▷ page 292).

MOExtended tires may only be used in conjunction with an active tire pressure loss warning system or with an active tire pressure monitor.

If the pressure loss warning message appears in the multifunction display:

- Observe the instructions in the display messages (▷ page 208).
- Check the tire for damage.
- If driving on, observe the following notes.

The maximum driving distance is approximately 50 miles (80 km) when the vehicle is partially laden and approximately 18 miles (30 km) when the vehicle is fully laden.

In addition to the vehicle load, the driving distance possible depends upon:

- Speed
- Road condition
- Outside temperature

The driving distance possible in run-flat mode may be reduced by extreme driving conditions/maneuvers, or it can be increased through a moderate style of driving.

The maximum permissible distance which can be driven in run-flat mode is counted from the moment the tire pressure loss warning appears in the multifunction display.

You must not exceed a maximum speed of 50 mph (80 km/h).

i When replacing one or all tires, make sure that you use only tires:

- of the size specified for the vehicle and
- marked "MOExtended"

If a tire has gone flat and cannot be replaced with a MOExtended tire, a standard tire may be used as a temporary measure. Make sure that you use the proper size and type (summer or winter tire).

i Vehicles equipped with MOExtended tires are not equipped with a TIREFIT kit at the factory. It is therefore recommended that you additionally equip your vehicle with a TIREFIT kit if you mount tires that do not feature run-flat properties, e.g. winter tires. A TIREFIT kit may be obtained from a qualified specialist workshop.

Important safety notes

WARNING

When driving in emergency mode, the driving characteristics deteriorate, e.g. when cornering, accelerating quickly and when braking. There is a risk of an accident.

Do not exceed the stated maximum speed. Avoid abrupt steering and driving maneuvers, and driving over obstacles (curbs, potholes, off-road). This applies in particular to a laden vehicle.

Stop driving in emergency mode if:

- you hear banging noises.
- the vehicle starts to shake.
- you see smoke and smell rubber.
- ESP® is intervening constantly.
- there are tears in the sidewalls of the tire.

After driving in emergency mode, have the wheel rims checked at a qualified specialist

workshop with regard to their further use. The defective tire must be replaced in every case.

TIREFIT kit

Important safety notes

TIREFIT is a tire sealant.

You can use TIREFIT to seal punctures of up to 0.16 in (4 mm), particularly those in the tire tread. You can use TIREFIT at outside temperatures down to -4 °F (-20 °C).

WARNING

In the following situations, the tire sealant is unable to provide sufficient breakdown assistance, as it is unable to seal the tire properly:

- there are cuts or punctures in the tire larger than those mentioned above.
- the wheel rim is damaged.
- you have driven at very low tire pressures or on a flat tire.

There is a risk of an accident.

Do not drive the vehicle. Contact a qualified specialist workshop.

WARNING

The tire sealant is harmful and causes irritation. It must not come into contact with your skin, eyes or clothing or be swallowed. Do not inhale TIREFIT fumes. Keep tire sealant away from children. There is a risk of injury.

If you come into contact with the tire sealant, observe the following:

- Rinse off the tire sealant from your skin immediately with water.
- If the tire sealant comes into contact with your eyes, immediately rinse them thoroughly with clean water.
- If tire sealant is swallowed, immediately rinse your mouth out thoroughly and drink plenty of water. Do not induce vomiting, and seek medical attention immediately.

- Immediately change out of clothing which has come into contact with tire sealant.
- If an allergic reaction occurs, seek medical attention immediately.

! Do not operate the tire inflation compressor for longer than eight minutes at a time without a break. It may otherwise overheat. The tire inflation compressor can be operated again once it has cooled down.

Comply with the manufacturer's safety instructions on the sticker on the tire inflation compressor.

Using the TIREFIT kit

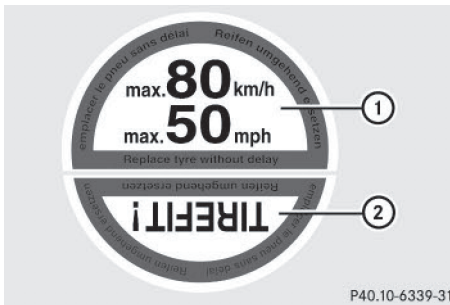

- ▶ Do not remove any foreign objects which have penetrated the tire, e.g. screws or nails.
- ▶ Remove the tire sealant bottle, the accompanying TIREFIT sticker and the tire inflation compressor from the stowage well underneath the trunk floor (▷ page 256).
- ▶ Affix part ① of the TIREFIT sticker within the driver's field of vision.
- ▶ Affix part ② of the TIREFIT sticker near the valve on the wheel with the defective tire.

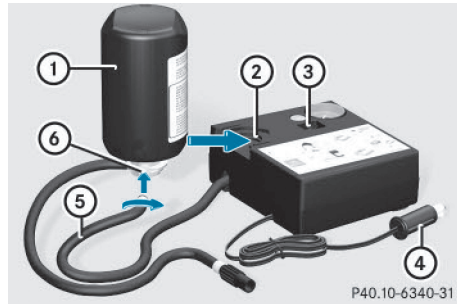

- ▶ Pull plug ④ with the cable and hose ⑤ out of the housing.
- ▶ Screw hose ⑤ onto flange ⑥ of tire sealant bottle ①.
- ▶ Place tire sealant bottle ① head downwards into recess ② of the tire inflation compressor.

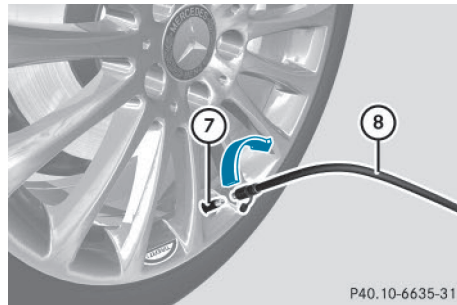

- ▶ Remove the cap from valve ⑦ on the faulty tire.
 - ▶ Screw filler hose ⑧ onto valve ⑦.
 - ▶ Insert connector ④ into a 12 V socket (▷ page 235) in your vehicle.
 - ▶ Turn the SmartKey to position 1 in the ignition lock (▷ page 133).
 - ▶ Press on/off switch ③ on the tire inflation compressor to I. The tire inflation compressor is switched on. The tire is inflated.
- i** First, tire sealant is pumped into the tire. The pressure can briefly rise to approximately 500 kPa (5 bar/73 psi).

Do not switch off the tire inflation compressor during this phase.

- ▶ Allow the tire inflation compressor to run for five minutes. The tire should then have attained a pressure of at least 180 kPa (1.8 bar/26 psi).

If a pressure of 180 kPa (1.8 bar/26 psi) has been attained after five minutes, see "Tire pressure reached" (▷ page 260).

If a tire pressure of 180 kPa (1.8 bar/26 psi) has not been attained after five minutes, see "Tire pressure not reached" (▷ page 260).

- ❗ If tire sealant leaks out, allow it to dry. It can then be removed like a layer of film.
If your clothes are soiled with tire sealant, have them cleaned with perchloroethylene at a dry cleaner as soon as possible.

Tire pressure not reached

If a pressure of 180 kPa (1.8 bar/26 psi) has not been attained after five minutes:

- ▶ Switch off the tire inflation compressor.
- ▶ Unscrew the filler hose from the valve of the faulty tire.
- ▶ Very slowly drive forwards or reverse approximately 30 ft (10 m).
- ▶ Pump up the tire again.
After a maximum of five minutes the tire pressure must be at least 180 kPa (1.8 bar/26 psi).

WARNING

If the required tire pressure is not reached after the specified time, the tire is too badly damaged. The tire sealant cannot repair the tire in this instance. Damaged tires and a tire pressure that is too low can significantly impair the vehicle's braking and driving characteristics. There is a risk of accident.

Do not continue driving. Contact a qualified specialist workshop.

Tire pressure reached

WARNING

A tire temporarily sealed with tire sealant impairs the driving characteristics and is not suitable for higher speeds. There is a risk of accident.

You should therefore adapt your driving style accordingly and drive carefully. Do not exceed the specified maximum speed with a tire that has been repaired using tire sealant.

The maximum speed for a tire sealed with tire sealant is 50 mph (80 km/h). The upper part of the TIREFIT sticker must be affixed to the instrument cluster in the driver's field of vision.

- ❗ Residue from the tire sealant may come out of the filler hose after use. This could cause stains.

Therefore, place the filler hose in the plastic bag which contained the TIREFIT kit.

Environmental note

Have the used tire sealant bottle disposed of professionally, e.g. at a qualified specialist workshop.

If a tire pressure of 180 kPa (1.8 bar/26 psi) has been attained after five minutes:

- ▶ Switch off the tire inflation compressor.
- ▶ Unscrew the filler hose from the valve of the faulty tire.
- ▶ Stow the tire sealant bottle and the tire inflation compressor.
- ▶ **Pull away immediately.**
- ▶ Stop after driving for approximately ten minutes and check the tire pressure with the tire inflation compressor.
The tire pressure must now be at least 130 kPa (1.3 bar/19 psi).

WARNING

If the required tire pressure is not reached after driving for a short period, the tire is too badly damaged. The tire sealant cannot repair

the tire in this instance. Damaged tires and a tire pressure that is too low can significantly impair the vehicle's braking and driving characteristics. There is a risk of accident. Do not continue driving. Contact a qualified specialist workshop.

i In cases such as the one mentioned above, contact an authorized Mercedes-Benz Center. Or call 1-800-FOR-MERCEdes (in the USA) or 1-800-387-0100 (in Canada).

- ▶ Correct the tire pressure if it is still at least 130 kPa (1.3 bar/ 19 psi). See the Tire and Loading Information placard on the driver's side B-pillar or the tire pressure table in the fuel filler flap for values.
- ▶ **To increase the tire pressure:** switch on the tire inflation compressor.

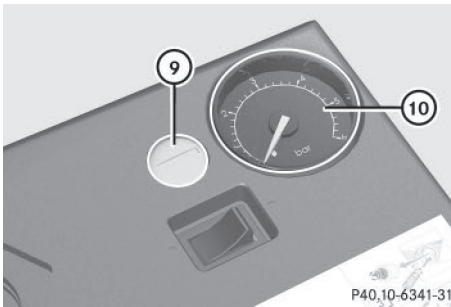

- ▶ **To reduce the tire pressure:** depress pressure release button (9) next to pressure gauge (10).
- ▶ When the tire pressure is correct, unscrew the filler hose from the valve of the sealed tire.
- ▶ Screw the valve cap onto the tire valve of the sealed tire.
- ▶ Pull the tire sealant bottle out of the tire inflation compressor. The filler hose remains attached to the tire sealant bottle.
- ▶ Stow the tire sealant bottle and the tire inflation compressor.

- ▶ Drive to the nearest qualified specialist workshop and have the tire changed there.
- ▶ Have the tire sealant bottle replaced as soon as possible at a qualified specialist workshop.
- ▶ Have the tire sealant bottle replaced every four years at a qualified specialist workshop.

Battery (vehicle)

12 V battery – important safety notes

Special tools and expert knowledge are required when working on the battery, e.g. removal and installation. You should therefore have all work involving the battery carried out at a qualified specialist workshop.

⚠ WARNING

Work carried out incorrectly on the battery can lead, for example, to a short circuit and thus damage the vehicle electronics. This can lead to function restrictions applying to safety-relevant systems, e.g. the lighting system, ABS (anti-lock braking system) or ESP® (Electronic Stability Program). The operating safety of your vehicle may be restricted. You could lose control of the vehicle, for example:

- braking
- in the event of abrupt steering maneuver and/or when the vehicle's speed is not adapted to the road conditions

There is a risk of an accident.

In the event of a short circuit or a similar incident, contact a qualified specialist workshop immediately. Do not drive any further. You should have all work involving the battery carried out at a qualified specialist workshop.

i For further information about ABS and ESP®, see (▶ page 74) and (▶ page 79).

All vehicles except AMG vehicles:

⚠ WARNING

Electrostatic build-up can lead to the creation of sparks, which could ignite the highly explosive gases of a battery. There is a risk of an explosion.

Before handling the battery, touch the vehicle body to remove any existing electrostatic build-up.

The highly flammable gas mixture forms when charging the battery as well as when jump-starting.

Always make sure that neither you nor the battery is electrostatically charged. A build-up of electrostatic charge can be caused, for example:

- by wearing clothing made from synthetic fibers
- due to friction between clothing and seats
- if you push or pull the battery across the carpet or other synthetic materials
- if you wipe the battery with a cloth

⚠ WARNING

During the charging process, a battery produces hydrogen gas. If a short circuit occurs or sparks are created, the hydrogen gas can ignite. There is a risk of an explosion.

- Make sure that the positive terminal of a connected battery does not come into contact with vehicle parts.
- Never place metal objects or tools on a battery.
- It is important that you observe the described order of the battery terminals when connecting and disconnecting a battery.
- When jump-starting, make sure that the battery poles with identical polarity are connected.
- It is particularly important to observe the described order when connecting and disconnecting the jumper cables.
- Never connect or disconnect the battery terminals while the engine is running.

⚠ WARNING

Battery acid is caustic. There is a risk of injury. Avoid contact with skin, eyes or clothing. Do not inhale any battery gases. Do not lean over the battery. Keep children away from batteries. Wash away battery acid immediately with plenty of clean water and seek medical attention.

All vehicles:**♻ Environmental note**

Batteries contain dangerous substances. It is against the law to dispose of them with the household rubbish. They must be collected separately and recycled to protect the environment.



Dispose of batteries in an environmentally friendly manner. Take discharged batteries to a qualified specialist workshop or a special collection point for used batteries.

- ❗ Have the battery checked regularly at a qualified specialist workshop.

Observe the service intervals in the Maintenance Booklet or contact a qualified specialist workshop for more information.

- ❗ Always have work on the batteries carried out at a qualified specialist workshop. Should it, in exceptional circumstances, be absolutely necessary to disconnect the 12-volt battery yourself, please observe the following:

- secure the vehicle to prevent it from rolling away.
- you switch off the engine and remove the SmartKey. Make sure the ignition is switched off. Check that all the indicator lamps in the instrument cluster are off. Otherwise, electronic components, such as the alternator, may be damaged.

- you first remove the negative terminal clamp and then the positive terminal clamp. Never swap the terminal clamps. Otherwise, the vehicle's electronic system may be damaged.
- the transmission is locked in position **P** after disconnecting the battery. The vehicle is secured against rolling away. You can then no longer move the vehicle.

The batteries and the covers of the positive terminal clamps must always be installed securely during operation.

Comply with safety precautions and take protective measures when handling batteries.



Risk of explosion.



Fire, open flames and smoking are prohibited when handling the battery. Avoid creating sparks.



Electrolyte or battery acid is corrosive. Avoid contact with skin, eyes or clothing.

Wear suitable protective clothing, especially gloves, apron and face-guard.

Immediately rinse electrolyte or acid splashes off with clean water. Contact a physician if necessary.

Wear eye protection.



Keep children away.



Observe this Operator's Manual.

For safety reasons, Mercedes-Benz recommends that you only use batteries which have been tested and approved for your vehicle by Mercedes-Benz. These batteries provide increased impact protection to prevent vehi-

cle occupants from suffering acid burns should the battery be damaged in the event of an accident.

In order for the battery to achieve the maximum possible service life, it must always be sufficiently charged.

Like other batteries, the vehicle battery may discharge over time if you do not use the vehicle. In this case, have the battery disconnected at a qualified specialist workshop. You can also charge the battery with a charger recommended by Mercedes-Benz. Contact a qualified specialist workshop for further information.

Have the battery condition of charge checked more frequently if you use the vehicle mainly for short trips or if you leave it standing idle for a lengthy period. Consult a qualified specialist workshop if you wish to leave your vehicle parked for a long period of time.

i Remove the SmartKey if you park the vehicle and do not require any electrical consumers. The vehicle will then use very little energy, thus conserving battery power.

i **Hybrid vehicles:** if the battery condition of charge is sufficient, the high-voltage battery can also supply the 12 V battery with energy. This only happens if the condition of charge of the 12 V battery requires this, e.g. after using electrical consumers for an extended period with the engine switched off. As the on-board voltage is continuously monitored this can also be performed when the engine is switched off. The condition of charge of the 12 V battery and the on-board voltage are thereby kept stable for a longer period.

High-voltage battery – important safety notes

Only hybrid vehicles are equipped with a high-voltage battery.

⚠ DANGER

The vehicle's high voltage electrical system is under high voltage. If you modify components in the vehicle's high-voltage electrical system or touch damaged components, you may be electrocuted. The components in the vehicle's high-voltage electrical system may be damaged in an accident, although the damage is not visible. There is a risk of fatal injury.

Following an accident, do not touch any high-voltage components and never modify the vehicle's high-voltage electrical system. Have the vehicle towed away after an accident and the vehicle's high-voltage electrical system checked by a qualified specialist workshop.

⚠ WARNING

In the event of a vehicle fire, the internal pressure of the high-voltage battery can exceed a critical value. In this case flammable gas escapes through a ventilation valve on the underbody. The gas can ignite. There is a risk of injury.

Leave the danger zone immediately. Secure the danger area at a suitable distance, whilst observing legal requirements.

⚠ WARNING

If the housing of the high-voltage battery has been damaged, electrolyte and gases may leak out. These are poisonous and caustic. There is a risk of injury.

Avoid contact with skin, eyes or clothing. Immediately rinse electrolyte splashes off with water and seek medical attention straight away.

- ❗ Exhaustive discharge caused by the vehicle standing idle for lengthy periods can damage the high-voltage battery. If the vehicle is idle for lengthy periods leave the high-voltage battery connected to a charging station.

Consult an authorized Mercedes-Benz Center if you wish to leave your vehicle parked for a long period of time.

Charging the 12 V battery**AMG vehicles:**

- ❗ Only use battery chargers with a maximum charging voltage of 14.4 V.

All other vehicles**⚠ WARNING**

During charging and jump-starting, explosive gases can escape from the battery. There is a risk of an explosion.

Particularly avoid fire, open flames, creating sparks and smoking. Ensure there is sufficient ventilation while charging and jump-starting. Do not lean over a battery.

⚠ WARNING

Battery acid is caustic. There is a risk of injury. Avoid contact with the skin, eyes or clothing. Do not inhale any battery gases. Do not lean over the battery. Keep children away from batteries. Wash battery acid immediately with water and seek medical attention.

⚠ WARNING

A discharged battery can freeze at temperatures below freezing point. When jump-starting the vehicle or charging the battery, gases can escape from the battery. There is a risk of an explosion.

Allow the frozen battery to thaw out before charging it or jump-starting.

- ❗ Only use battery chargers with a maximum charging voltage of 14.8 V.

All vehicles:

- ❗ Only charge the battery using the jump-starting connection point.

The jump-starting connection point is in the engine compartment (▷ page 266).

- ▶ Open the hood.
- ▶ Connect the battery charger to the positive terminal and ground point in the same order as when connecting the donor bat-

tery in the jump-starting procedure
(▷ page 266).

Keep away from fire and open flames. Do not lean over a battery. Never charge the battery if it is still installed in the vehicle, unless you use a battery charger which has been tested and approved by Mercedes-Benz. A battery charger unit specially adapted for Mercedes-Benz vehicles and tested and approved by Mercedes-Benz is available as an accessory. It permits the charging of the battery in its installed position. Contact an authorized Mercedes-Benz Center for further information and availability. Read the battery charger's operating instructions before charging the battery.

All vehicles except AMG vehicles: if the indicator/warning lamps in the instrument cluster do not light up at low temperatures, it is very likely that the discharged battery has frozen. In this case you may neither jump-start the vehicle nor charge the battery. The service life of a thawed-out battery may be shorter. The starting characteristics can be impaired, particularly at low temperatures. Have the thawed-out battery checked at a qualified specialist workshop.

AMG vehicles: at low temperatures, do not charge a battery which has been removed using a battery charger. Allow the battery to warm up gently first, if necessary. Otherwise, the service life can be shortened and the starting characteristics impaired, especially at low temperatures.



Jump-starting

For the jump-starting procedure, use only the jump-starting connection point, consisting of a positive terminal and a ground point, in the engine compartment.

All vehicles except AMG vehicles:

WARNING

Battery acid is caustic. There is a risk of injury.

Avoid contact with skin, eyes or clothing. Do not inhale any battery gases. Do not lean over the battery. Keep children away from batteries. Wash away battery acid immediately with plenty of clean water and seek medical attention.

WARNING

During charging and jump-starting, explosive gases can escape from the battery. There is a risk of an explosion.

Particularly avoid fire, open flames, creating sparks and smoking. Ensure there is sufficient ventilation while charging and jump-starting. Do not lean over a battery.

WARNING

During the charging process, a battery produces hydrogen gas. If a short circuit occurs or sparks are created, the hydrogen gas can ignite. There is a risk of an explosion.

- Make sure that the positive terminal of a connected battery does not come into contact with vehicle parts.
- Never place metal objects or tools on a battery.
- It is important that you observe the described order of the battery terminals when connecting and disconnecting a battery.
- When jump-starting, make sure that the battery poles with identical polarity are connected.
- It is particularly important to observe the described order when connecting and disconnecting the jumper cables.
- Never connect or disconnect the battery terminals while the engine is running.

WARNING

A discharged battery can freeze at temperatures below freezing point. When jump-starting the vehicle or charging the battery, gases can escape from the battery. There is a risk of an explosion.

Allow the frozen battery to thaw out before charging it or jump-starting.

- ❗ Avoid repeated and lengthy starting attempts. Otherwise, the catalytic converter could be damaged by the non-combusted fuel.

If, at low temperatures, the indicator lamps/warning lamps in the instrument cluster do not light up, it is highly likely that the discharged battery has frozen. In this case, you may neither charge the battery nor jump-start the vehicle. The service life of a thawed-out battery may be shorter. The starting characteristics can be impaired, particularly at low temperatures. Have the thawed-out battery checked at a qualified specialist workshop.

All vehicles:

Do not start the vehicle using a rapid charging device. If your vehicle's battery is discharged, the engine can be jump-started from another vehicle or from a second battery using jumper cables. Observe the following points:

- The battery is not accessible in all vehicles. If the other vehicle's battery is not accessible, jump-start the vehicle using a second battery or a jump-starting device.
- You may only jump-start the vehicle when the engine and exhaust system are cold.
- Keep away from fire and open flames.
- Do not start the engine if the battery is frozen. Let the battery thaw first.
- **All vehicles except AMG vehicles:** do not start the engine if the battery is frozen. Let the battery thaw first.
- Only jump-start from batteries with a 12 V voltage rating.
- Only use jumper cables which have a sufficient cross-section and insulated terminal clamps.
- Do not lean over the battery.
- If the battery is fully discharged, leave the battery that is being used to jump-start connected for a few minutes before attempting to start. This charges the battery slightly.
- Make sure that the two vehicles do not touch.

Make sure that:

- the jumper cables are not damaged.
- when the jumper cables are connected to the battery, uninsulated sections of the terminal clamp do not come into contact with other metal sections.
- the jumper cables cannot come into contact with parts which can move when the engine is running, such as the V-belt pulley or the fan.
- ▶ Secure the vehicle by applying the electric parking brake.
- ▶ Shift the transmission to position **P**.
- ▶ Make sure that the ignition is switched off (▷ page 133). All indicator lamps in the instrument cluster must be off. When using the SmartKey, turn the SmartKey to position **O** in the ignition lock and remove it (▷ page 133).
- ▶ Switch off all electrical consumers, e.g. rear window defroster, lighting, etc.
- ▶ Open the hood.

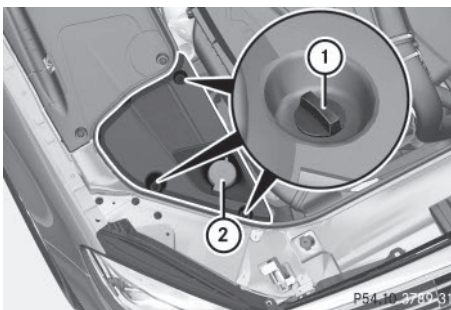

Example: ground point cover

- ▶ Turn fasteners ① one ¼ turn and remove.
- ▶ Remove the cover whilst pressing down on cap ② of the washer fluid reservoir.

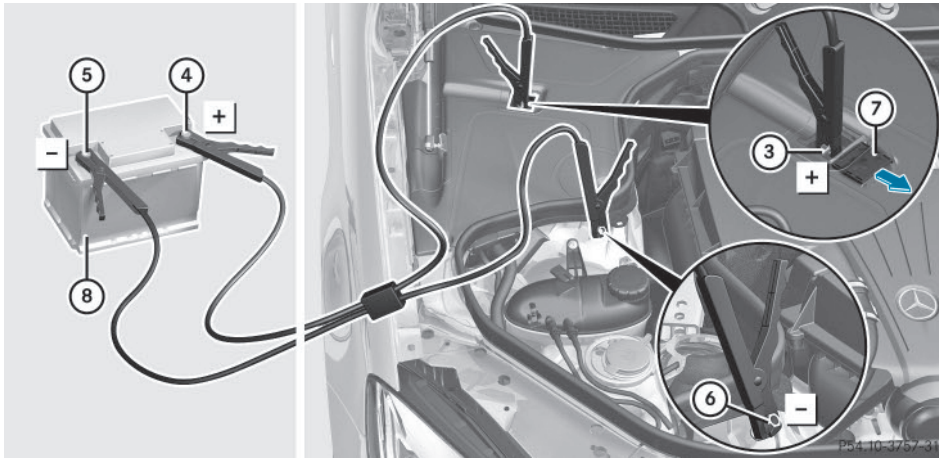

Position number ⑧ identifies the charged battery of the other vehicle or an equivalent jump-starting device.

- ▶ Slide cover ⑦ of positive terminal ③ in the direction of the arrow.
- ▶ Connect positive terminal ③ on your vehicle to positive terminal ④ of donor battery ⑧ using the jumper cable. Always begin with positive terminal ③ on your own vehicle first.
- ▶ Start the engine of the donor vehicle and run it at idling speed.
- ▶ Connect negative terminal ⑤ of donor battery ⑧ to ground point ⑥ of your vehicle using the jumper cable, connecting the jumper cable to donor battery ⑧ first.
- ▶ Start the engine.
- ▶ Before disconnecting the jumper cables, let the engine run for several minutes.
- ▶ First, remove the jumper cables from ground point ⑥ and negative terminal ⑤, then from positive clamp ③ and positive terminal ④. Begin each time at the contacts on your own vehicle first.
- ▶ Close cover ⑦ of positive clamp ③ after removing the jumper cables.
- ▶ Replace the ground point cover. Make sure all mountings for the fasteners are positioned precisely beneath the corresponding recesses in the cover.
- ▶ Press fasteners ① into the mountings until they engage.
- ▶ Have the battery checked at a qualified specialist workshop.

i Hybrid vehicles: if your vehicle has been jump-started, it may not be possible to use the electric drive for approximately 30 minutes.

i Jump-starting is not considered to be a normal operating condition.

i Jumper cables and further information regarding jump-starting can be obtained at any qualified specialist workshop.

Towing and tow-starting

Important safety notes

WARNING

Functions relevant to safety are restricted or no longer available if:

- the engine is not running.
- the brake system or the power steering is malfunctioning.
- there is a malfunction in the voltage supply or the vehicle's electrical system.

If your vehicle is being towed, much more force may be necessary to steer or brake. There is a risk of an accident.

In such cases, use a tow bar. Before towing, make sure that the steering moves freely.

WARNING

You can no longer steer the vehicle if the steering wheel lock has been engaged. There is a risk of an accident.

Always switch off the ignition when towing the vehicle with a tow cable or a tow bar.

WARNING

When towing or tow-starting another vehicle and its weight is greater than the permissible gross weight of your vehicle, the:

- the towing eye could detach itself
- the vehicle/trailer combination could roll-over.

There is a risk of an accident.

When towing or tow-starting another vehicle, its weight should not be greater than the permissible gross weight of your vehicle.

Information on your vehicle's gross vehicle weight rating can be found on the vehicle identification plate (▷ page 320).

 When COLLISION PREVENTION ASSIST PLUS, DISTRONIC PLUS or the HOLD function is activated, the vehicle brakes automatically in certain situations. To avoid damage to the vehicle, deactivate these systems in the following or similar situations:

- when towing the vehicle
- in the car wash

 Make sure that the electric parking brake is released. If the electric parking brake is faulty, visit a qualified specialist workshop.

 Secure the tow rope or tow bar to the towing eye only. Otherwise, the vehicle could become damaged.

 Do not use the towing eyes for recovery purposes as this could damage the vehicle. If in doubt, recover the vehicle with a crane.

 When towing, pull away slowly and smoothly. If the tractive power is too high, the vehicles could be damaged.

 Shift the automatic transmission to **N** and do not open the driver's or front passenger's door during towing. The automatic transmission may otherwise shift to position **P**, which could damage the transmission.

 Do not tow with sling-type equipment. This could damage the vehicle.

 The vehicle can be towed a maximum of 30 miles (50km). The towing speed of 30 mph (50 km/h) must not be exceeded. If the vehicle has to be towed more than 30 miles (50km), the entire vehicle must be raised and transported.

It is better to have the vehicle transported than to have it towed away.

If the vehicle has suffered transmission damage, have it transported on a transporter or trailer.

The automatic transmission must be in position **N** when the vehicle is being towed.

If the automatic transmission cannot be shifted to position **N**, have the vehicle transported on a transporter or trailer.

The battery must be connected and charged. Otherwise, you:

- cannot turn the SmartKey to position **2** in the ignition lock
- cannot release the electric parking brake
- cannot shift the automatic transmission to position **N**

i Deactivate the automatic locking feature (▷ page 92). You could otherwise be locked out when pushing or towing the vehicle.

Hybrid vehicles:

Hybrid vehicles may not be towed away but only transported if:

- the multifunction display is not working or
- the  **Malfunction** display message appears in the multifunction display

If the vehicle is in a dangerous area, it can be towed out of that area with both axles on the ground. In this case, the towing distance may not be greater than 50 m and must not exceed a towing speed of 10 km/h. For longer distances, have the vehicle loaded and transported.

Installing/removing the towing eye

Installing the towing eye

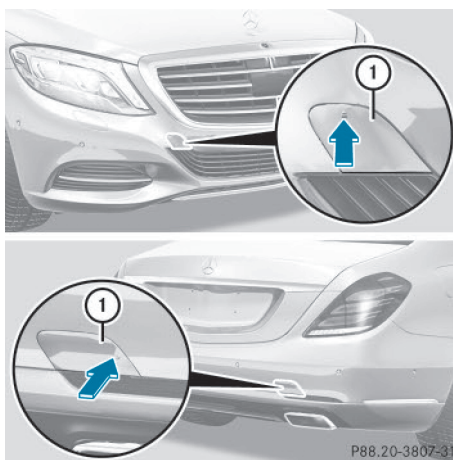

The brackets for the screw-in towing eyes are located in the bumpers. They are at the rear and at the front, under covers ①.

- ▶ Remove the towing eye from the vehicle tool kit/stowage tray (▷ page 256).
- ▶ Press the mark on cover ① inwards in the direction of the arrow.
- ▶ Remove cover ① from the opening.
- ▶ Screw in the towing eye clockwise as far as it will go and tighten it.

Removing the towing eye

- ▶ Unscrew and remove the towing eye.
- ▶ Attach cover ① to the bumper and press until it engages.
- ▶ Place the towing eye in the vehicle tool kit/stowage tray.

Towing a vehicle with both axles on the ground

It is important that you observe the safety instructions when towing away your vehicle (▷ page 269).

The automatic transmission automatically shifts to position **P** when you open the driver's or front-passenger door or when you remove the SmartKey from the ignition lock.

In order to ensure that the automatic transmission stays in position **N** when towing the vehicle, you must observe the following points:

- ▶ You must use the SmartKey instead of the Start/Stop button (▷ page 133).
- ▶ Make sure that the vehicle is stationary and the SmartKey in the ignition lock is in position **0**.
- ▶ Turn the SmartKey to position **2** in the ignition lock.
- ▶ Depress and hold the brake pedal.
- ▶ Shift the automatic transmission to position **N**.
- ▶ Release the brake pedal.
- ▶ Release the electric parking brake.
- ▶ Leave the SmartKey in position **2** in the ignition lock.
- ▶ Switch on the hazard warning lamps (▷ page 116).

i In order to signal a change of direction when towing the vehicle with the hazard warning lamps switched on, use the combination switch as usual. In this case, only the indicator lamps for the direction of travel flash. After resetting the combination switch, the hazard warning lamp starts flashing again.

Towing the vehicle with the rear axle raised

Only vehicles without 4MATIC can be towed with the rear axle raised.

! The ignition must be switched off if you are towing the vehicle with the rear axle raised. Intervention by ESP® could otherwise damage the brake system.

! Vehicles with 4MATIC must not be towed with either the front or the rear axle raised, as doing so will damage the transmission.

Vehicles with 4MATIC may either be towed away with both axles on the ground or be loaded up and transported.

- ▶ Switch on the hazard warning lamps (▷ page 116).
- ▶ Bring the front wheels into the straight-ahead position.
- ▶ If necessary, turn the SmartKey in the ignition lock to position **0** and remove the SmartKey from the ignition lock.
- ▶ Take the SmartKey with you when you leave the vehicle.

When towing your vehicle with the rear axle raised, it is important that you observe the safety instructions (▷ page 269).

Transporting the vehicle

Hybrid vehicles: transportation of the vehicle should only be carried out by professional recovery companies.

! You may only secure the vehicle by the wheels, not by parts of the vehicle such as axle or steering components. Otherwise, the vehicle could be damaged.

The towing eye can be used to pull the vehicle onto a trailer or transporter for transporting purposes.

- ▶ Turn the SmartKey to position **2** in the ignition lock.
- ▶ Shift the automatic transmission to position **N**.

As soon as the vehicle has been loaded:

- ▶ Prevent the vehicle from rolling away by applying the electric parking brake.
- ▶ Shift the automatic transmission to position **P**.

- ▶ Turn the SmartKey to position **0** in the ignition lock and remove it.
- ▶ Secure the vehicle.

Notes on 4MATIC vehicles

! Vehicles with 4MATIC must not be towed with either the front or the rear axle raised, as doing so will damage the transmission.

Vehicles with 4MATIC may either be towed away with both axles on the ground or be loaded up and transported.

If the vehicle's transmission, front, or rear axle is damaged, have the vehicle transported on a truck or trailer.

In the event of damage to the electrical system: if the battery is defective, the automatic transmission will be locked in position **P**. To shift the automatic transmission to position **N**, you must provide power to the vehicle's electrical system in the same way as when jump-starting (▷ page 266).

Have the vehicle transported on a transporter or trailer.

Tow-starting (emergency engine starting)

! Vehicles with automatic transmission must not be tow-started. You could otherwise damage the automatic transmission.

i Information on "Jump-starting" (▷ page 266).

Fuses

Important safety notes

WARNING

If you manipulate or bridge a faulty fuse or if you replace it with a fuse with a higher amperage, the electric cables could be overloaded. This could result in a fire. There is a risk of an accident and injury.

Always replace faulty fuses with the specified new fuses having the correct amperage.

Blown fuses must be replaced with fuses of the same rating, which you can recognize by the color and value. The fuse ratings are listed in the fuse allocation chart.

The fuse allocation chart is on the fuse box in the trunk (▷ page 274).

If a newly inserted fuse also blows, have the cause traced and rectified at a qualified specialist workshop, e.g. an authorized Mercedes-Benz Center.

! Only use fuses that have been approved for Mercedes-Benz vehicles and which have the correct fuse rating for the system concerned. Otherwise, components or systems could be damaged.

The fuses in your vehicle serve to close down faulty circuits. If a fuse blows, all the components on the circuit and their functions stop operating.

Before changing a fuse

- ▶ Secure the vehicle against rolling away (▷ page 154).
 - ▶ Switch off all electrical consumers.
 - ▶ Make sure that the ignition is switched off (▷ page 133).
- or
- ▶ When using the SmartKey, turn the SmartKey to position **0** in the ignition lock and remove it (▷ page 133).

All indicator lamps in the instrument cluster must be off.

The fuses are located in various fuse boxes:

- Fuse box on the driver's side of the dashboard
- Fuse box in the front-passenger footwell

- Fuse box in the engine compartment on the left-hand side of the vehicle, when viewed in the direction of travel
- Fuse box in the trunk on the right-hand side of the vehicle, when viewed in the direction of travel

Dashboard fuse box

! Do not use a pointed object such as a screwdriver to open the cover in the dashboard. You could damage the dashboard or the cover.

! Make sure that no moisture can enter the fuse box when the cover is open.

! When closing the cover, make sure that it is lying correctly on the fuse box. Moisture seeping in or dirt could otherwise impair the operation of the fuses.

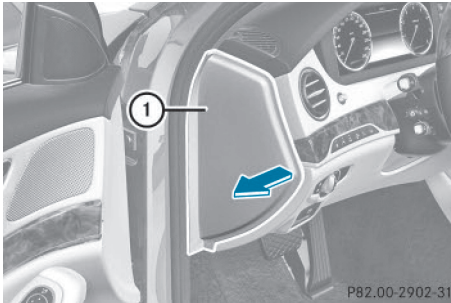

- ▶ Open the driver's door.
- ▶ **To open:** pull cover ① outwards in the direction of the arrow and remove it.
- ▶ **To close:** clip in cover ① on the front of the dashboard.
- ▶ Fold cover ① inwards until it engages.

Fuse box in the front-passenger footwell

! Make sure that no moisture can enter the fuse box when the cover is open.

! When closing the cover, make sure that it is lying correctly on the fuse box. Moisture

seeping in or dirt could otherwise impair the operation of the fuses.

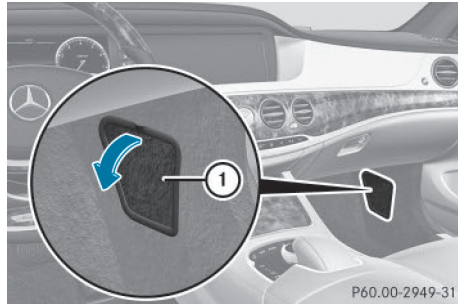

- ▶ Open the front-passenger door.
- ▶ Fold cover ① down and remove it.

Fuse box in the engine compartment

! WARNING

When the hood is open and the windshield wipers are set in motion, you can be injured by the wiper linkage. There is a risk of injury.

Always switch off the windshield wipers and the ignition before opening the hood.

! Make sure that no moisture can enter the fuse box when the cover is open.

! When closing the cover, make sure that it is lying correctly on the fuse box. Moisture seeping in or dirt could otherwise impair the operation of the fuses.

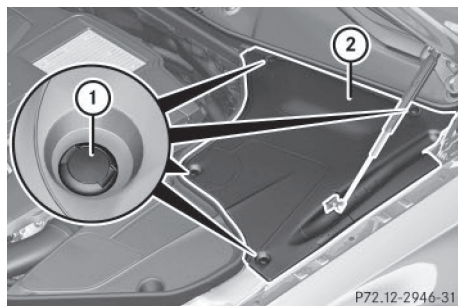

- ▶ Open the hood.
- ▶ **To open:** release retaining clamps ① and remove cover ②.

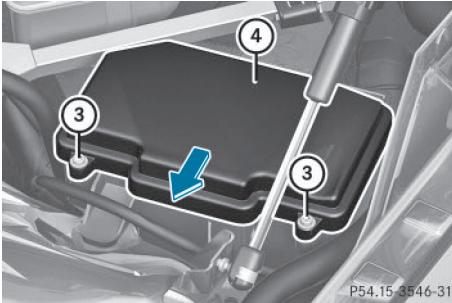

- ▶ Use a dry cloth to remove any moisture from the fuse box.
- ▶ Undo screws (3) on the fuse box.
- ▶ Remove fuse box cover (4) forwards.
- ▶ **To close:** check whether the seal is lying correctly in cover (4).
- ▶ Insert cover (4) at the rear of the fuse box into the retainer.
- ▶ Fold down cover (4) of the fuse box and tighten screws (3).
- ▶ Insert cover (2) and secure with retaining clamps (1).
- ▶ Close the hood.

Fuse box in the trunk

- ❗ Make sure that no moisture can enter the fuse box when the cover is open.
- ❗ When closing the cover, make sure that it is lying correctly on the fuse box. Moisture seeping in or dirt could otherwise impair the operation of the fuses.

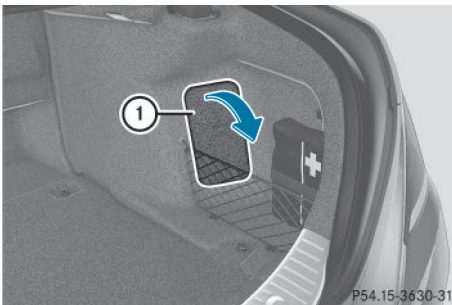

Example: S-Class MAYBACH

- ▶ Open the trunk lid.
- ▶ **To open:** release cover (1) at the top right and left-hand sides with a flat object.
- ▶ Open cover (1) downwards in the direction of the arrow.

i The fuse allocation chart is located in a recess at the side of the fuse box. You can find the corresponding fuse rating and fuse type on the fuse allocation chart.

Engine emergency off

If the engine cannot be switched off as described, observe the following procedure:

- ▶ Take the fuse allocation chart from the fuse box in the trunk (> page 274).
- ▶ Search for "Emergency engine shutdown" in the fuse allocation chart.
- ▶ Remove the fuses listed under "Emergency engine shutdown".

| | |
|-----------------------------------|-----|
| Useful information | 276 |
| Important safety notes | 276 |
| Operation | 276 |
| Winter operation | 278 |
| Tire pressure | 279 |
| Loading the vehicle | 286 |
| All about wheels and tires | 291 |
| Changing a wheel | 298 |
| Wheel and tire combinations | 304 |

Useful information

- i** This Operator's Manual describes all models and all standard and optional equipment of your vehicle available at the time of publication of the Operator's Manual. Country-specific differences are possible. Please note that your vehicle may not be equipped with all features described. This also applies to safety-related systems and functions.
- i** Read the information on qualified specialist workshops (▷ page 30).

Important safety notes

WARNING

If wheels and tires of the wrong size are used, the wheel brakes or suspension components may be damaged. There is a risk of an accident.

Always replace wheels and tires with those that fulfill the specifications of the original part.

When replacing wheels, make sure to use the correct:

- designation
- model

When replacing tires, make sure to use the correct:

- designation
- manufacturer
- model

WARNING

A flat tire severely impairs the driving, steering and braking characteristics of the vehicle. There is a risk of accident.

Tires without run-flat characteristics:

- do not drive with a flat tire.
- immediately replace the flat tire with your emergency spare wheel or spare wheel, or consult a qualified specialist workshop.

Tires with run-flat characteristics:

- pay attention to the information and warning notices on MOExtended tires (tires with run-flat characteristics).

Accessories that are not approved for your vehicle by Mercedes-Benz or that are not being used correctly can impair operating safety.

Before purchasing and using non-approved accessories, visit a qualified specialist workshop and inquire about:

- suitability
- legal stipulations
- factory recommendations

Information on the dimensions and types of wheels and tires for your vehicle can be found in the "Wheel/tire combinations" section (▷ page 304).

Information on air pressure for the tires on your vehicle can be found:

- on the vehicle's Tire and Loading Information placard on the B-pillar (▷ page 286)
- on the tire pressure label on the fuel filler flap (▷ page 142)
- under "Tire pressure" (▷ page 279)

Operation

Information on driving

If the vehicle is heavily loaded, check the tire pressures and correct them if necessary.

While driving, pay attention to vibrations, noises and unusual handling characteristics, e.g. pulling to one side. This may indicate that the wheels or tires are damaged. If you suspect that a tire is defective, reduce your speed immediately. Stop the vehicle as soon as possible to check the wheels and tires for damage. Hidden tire damage could also be causing the unusual handling characteristics. If you find no signs of damage, have the tires and wheels checked at a qualified specialist workshop.

When parking your vehicle, make sure that the tires do not get deformed by the curb or other obstacles. If it is necessary to drive over curbs, speed humps or similar elevations, try to do so slowly and at an obtuse angle. Otherwise, the tires, particularly the sidewalls, may be damaged.

Regular checking of wheels and tires

WARNING

Damaged tires can cause tire inflation pressure loss. As a result, you could lose control of your vehicle. There is a risk of accident.

Check the tires regularly for signs of damage and replace any damaged tires immediately.

Regularly check the wheels and tires of your vehicle for damage at least once a month, as well as after driving off-road or on rough roads. Damaged wheels can cause a loss of tire pressure. Pay particular attention to damage such as:

- cuts in the tires
- punctures
- tears in the tires
- bulges on tires
- deformation or severe corrosion on wheels

Regularly check the tire tread depth and the condition of the tread across the whole width of the tire (> page 277). If necessary, turn the front wheels to full lock in order to inspect the inner side of the tire surface.

All wheels must have a valve cap to protect the valve against dirt and moisture. Do not mount anything onto the valve other than the standard valve cap or other valve caps approved by Mercedes-Benz for your vehicle. Do not use any other valve caps or systems, e.g. tire pressure monitoring systems.

Regularly check the pressure of all the tires particularly prior to long trips. Adjust the tire pressure as necessary (> page 279).

The service life of tires depends, among other things, on the following factors:

- Driving style
- Tire pressure
- Distance covered

Notes on tire tread

WARNING

Insufficient tire tread will reduce tire traction. The tire is no longer able to dissipate water. This means that on wet road surfaces, the risk of hydroplaning increases, in particular where speed is not adapted to suit the driving conditions. There is a risk of accident.

If the tire pressure is too high or too low, tires may exhibit different levels of wear at different locations on the tire tread. Thus, you should regularly check the tread depth and the condition of the tread across the entire width of all tires.

Minimum tire tread depth for:

- Summer tires: $\frac{1}{8}$ in (3 mm)
- M+S tires: $\frac{1}{6}$ in (4 mm)

For safety reasons, replace the tires before the legally prescribed limit for the minimum tire tread depth is reached.

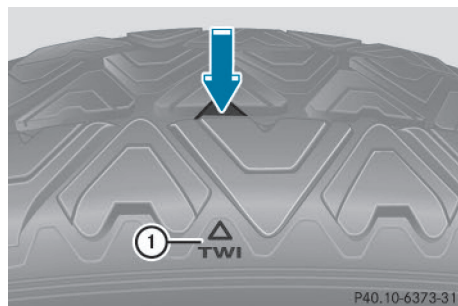

Bar indicator ① for tread wear is integrated into the tire tread.

Treadwear indicators (TWI) are required by law. Six indicators are positioned on the tire tread. They are visible once a tread depth of approximately $\frac{1}{16}$ in (1.6 mm) has been

reached. If this is the case, the tire is so worn that it must be replaced.

A TIREFIT kit can be obtained from a qualified specialist workshop.

Selecting, mounting and replacing tires

- Only mount tires and wheels of the same type and make.
Exception: it is permissible to install a different type or make in the event of a flat tire. Observe the "MOExtended tires (tires with run-flat characteristics)" section (> page 257).
- Only mount tires of the correct size onto the wheels.
- Break in new tires at moderate speeds for the first 60 miles (100 km). They only reach their full performance after this distance.
- Do not drive with tires which have too little tread depth, as this significantly reduces the traction on wet roads (hydroplaning).
- Replace the tires after six years at the latest, regardless of wear.

MOExtended tires (tires with run-flat properties)

With MOExtended tires (tires with run flat characteristics), you can continue to drive your vehicle even if there is a total loss of pressure in one or more tires.

MOExtended tires may only be used in conjunction with an active tire pressure loss warning system or with an active tire pressure monitor and on wheels specifically tested by Mercedes-Benz.

Notes on driving with MOExtended tires with a flat tire (> page 257).

- ❗ Vehicles equipped with MOExtended tires are not equipped with a TIREFIT kit at the factory. It is therefore recommended that you additionally equip your vehicle with a TIREFIT kit if you mount tires that do not feature run-flat properties, e.g. winter tires.

Winter operation

General notes

You can find information about this in the Digital Operator's Manual.

Driving with summer tires

At temperatures below 45 °F (+7 °C), summer tires lose elasticity and therefore traction and braking power. Change the tires on your vehicle to M+S tires. Using summer tires at very cold temperatures could cause cracks to form, thereby damaging the tires permanently. Mercedes-Benz cannot accept responsibility for this type of damage.

WARNING

Damaged tires can cause tire inflation pressure loss. As a result, you could lose control of your vehicle. There is a risk of accident.

Check the tires regularly for signs of damage and replace any damaged tires immediately.

M+S tires

WARNING

M+S tires with a tire tread depth of less than 1/8 in (4 mm) are not suitable for use in winter and do not provide sufficient traction. There is a risk of an accident.

M+S tires with a tread depth of less than 1/8 in (4 mm) must be replaced immediately.

Further information can be found in the Digital Operator's Manual.

Snow chains

⚠ WARNING

If snow chains are installed to the front wheels, they may drag against the vehicle body or chassis components. This could cause damage to the vehicle or the tires. There is a risk of an accident.

To avoid hazardous situations:

- never install snow chains to the front wheels
- always install snow chains in pairs to the rear wheels.

Further information can be found in the Digital Operator's Manual.

Tire pressure

Tire pressure specifications

Important safety notes

⚠ WARNING

Underinflated or overinflated tires pose the following risks:

- the tires may burst, especially as the load and vehicle speed increase.
- the tires may wear excessively and/or unevenly, which may greatly impair tire traction.
- the driving characteristics, as well as steering and braking, may be greatly impaired.

There is a risk of an accident.

Follow recommended tire inflation pressures and check the pressure of all the tires including the spare wheel:

- monthly, at least
- if the load changes
- before beginning a long journey
- under different operating conditions, e.g. off-road driving

If necessary, correct the tire pressure.

i The specifications on the sample Tire and Loading Information placard and tire pressure tables are examples. Tire pressure specifications are vehicle-specific and may deviate from the data shown here. The tire pressure specifications that are valid for your vehicle can be found on the Tire and Loading Information placard and tire pressure table on the vehicle.

General notes

The recommended tire pressures for the tires mounted at the factory can be found on the labels described here.

Further information on tire pressures can be obtained at a qualified specialist workshop.

Tire and Loading Information placard

1 TIRE LOADING INFORMATION
RENSEIGNEMENTS SUR LES PNEUS ET LE CHARGEMENT

SEATING CAPACITY / TO
NOMBRE DE PLACES 1 TO 7 FRONT 2 MIDDLE 3 REAR 2

The combined weight of occupants and cargo should never exceed XXX kg or XXX lbs. Le poids total des occupants et du chargement ne doit jamais dépasser XXX kg ou XXX lbs.

| TIRE / PNEU | SIZE / DIMENSIONS | COLD TIRE PRESSURE / PRESSION DES PNEUS A FROID |
|--------------------|---------------------|---|
| FRONT / AVANT | 255/40 ZR18 99Y XL | 200 KPA, 29 PSI |
| REAR / ARRIERE | 285/35 ZR18 101Y XL | 200 KPA, 29 PSI |
| SPARE / DE RECOURS | 175/55-18 95P | 420 KPA, 60 PSI |

SEE OWNER'S MANUAL FOR ADDITIONAL INFORMATION
VOIR LE MANUEL DE L'USAGER POUR PLUS DE RENSEIGNEMENTS

P40.00-2223-31

1 Recommended tire pressures

The Tire and Loading Information placard is on the B-pillar on the driver's side (▷ page 286).

The Tire and Loading Information placard contains the recommended tire pressures for cold tires. The recommended tire pressures are valid for the maximum permissible load and up to the maximum permissible vehicle speed.

Tire pressure table

The tire pressure table is on the inside of the fuel filler flap.

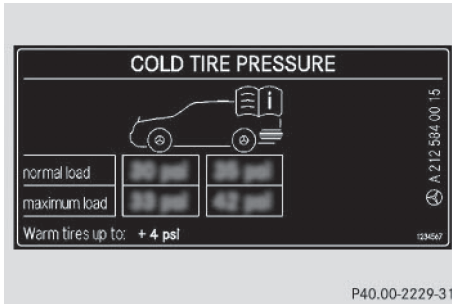

Example: tire pressure table for all tires permitted for this vehicle by the factory

The tire pressure table contains the recommended pressures for cold tires for various operating conditions, i.e. differing load and speed conditions.

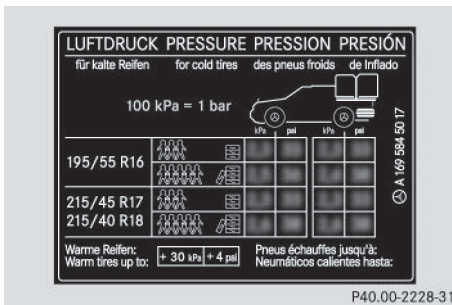

Example: tire pressure table with tire dimensions

If a tire size precedes a tire pressure, the tire pressure information following is only valid for that tire size. The load conditions "partially laden" and "fully laden" are defined in the table for different numbers of occupants and amounts of luggage. The actual number of seats may differ.

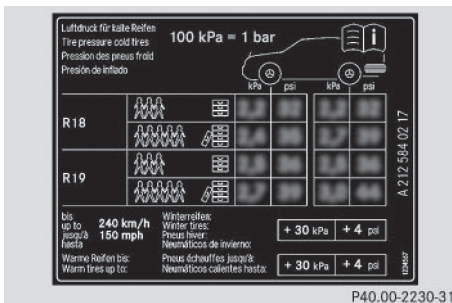

Some tire pressure tables show only the rim diameters instead of the full tire size, e.g. **R18**. The rim diameter is part of the tire size and can be found on the tire sidewall (▷ page 292).

If the tire pressures have been set to the lower values for lighter loads and/or lower road speeds, the pressures should be reset to the higher values:

- if you want to drive with an increased load and/or
- if you want to drive at higher road speeds

i The tire pressures for increased loads and/or higher road speeds, shown in the tire pressure table, may have a negative effect on driving comfort.

If the tire pressure is not set correctly, this can lead to an excessive build up of heat and a sudden loss of pressure.

For more information, contact a qualified specialist workshop.

Important notes on tire pressure

⚠ WARNING

If the tire pressure drops repeatedly, the wheel, valve or tire may be damaged. Tire pressure that is too low may result in a tire blow-out. There is a risk of an accident.

- Check the tire for foreign objects.
- Check whether the wheel is losing air or the valve is leaking.

If you are unable to rectify the damage, contact a qualified specialist workshop.

⚠ WARNING

If you fit unsuitable accessories onto tire valves, the tire valves may be overloaded and malfunction, which can cause tire pressure loss. Due to their design, retrofitted tire pressure monitors keep the tire valve open. This can also result in tire pressure loss. There is a risk of an accident.

Only screw the standard valve cap or other valve caps approved by Mercedes-Benz for your vehicle onto the tire valve.

Use a suitable pressure gauge to check the tire pressure. The outer appearance of a tire does not permit any reliable conclusion about the tire pressure. On vehicles equipped with the electronic tire pressure monitor, the tire pressure can be checked in the on-board computer.

The tire temperature and pressure increase when the vehicle is in motion. This is dependent on the driving speed and the load.

Therefore, you should only correct tire pressures when the tires are cold.

The tires are cold:

- if the vehicle has been parked without direct sunlight on the tires for at least three hours and
- if the vehicle has not been driven further than 1 mile (1.6 km)

The tire temperature changes depending on the outside temperature, the vehicle speed and the tire load. If the tire temperature changes by 18 °F (10 °C), the tire pressure changes by approximately 10 kPa (0.1 bar/ 1.5 psi). Take this into account when checking the pressure of warm tires. Only correct the tire pressure if it is too low for the current operating conditions. If you check the tire pressure when the tires are warm, the resulting value will be higher than if the tires were cold. This is normal. Do not reduce the tire pressure to the value specified for cold tires. The tire pressure would otherwise be too low. Observe the recommended tire pressures for cold tires:

- on the Tire and Loading Information placard on the B-pillar on the driver's side
- in the tire pressure table on the inside of the fuel filler flap

Underinflated or overinflated tires

Underinflated tires

WARNING

Tires with pressure that is too low can overheat and burst as a consequence. In addition, they also suffer from excessive and/or irregular wear, which can severely impair the braking properties and the driving characteristics. There is a risk of an accident.

Avoid tire pressures that are too low in all the tires, including the spare wheel.

Underinflated tires may:

- overheat, leading to tire defects
- adversely affect handling
- wear excessively and/or unevenly
- have an adverse effect on fuel consumption

Overinflated tires

WARNING

Tires with excessively high pressure can burst because they are damaged more easily by road debris, potholes etc. In addition, they also suffer from irregular wear, which can severely impair the braking properties and the driving characteristics. There is a risk of an accident.

Avoid tire pressures that are too high in all the tires, including the spare wheel.

Overinflated tires may:

- increase the braking distance
- adversely affect handling
- wear excessively and/or unevenly
- have an adverse effect on ride comfort
- be more susceptible to damage

Maximum tire pressures

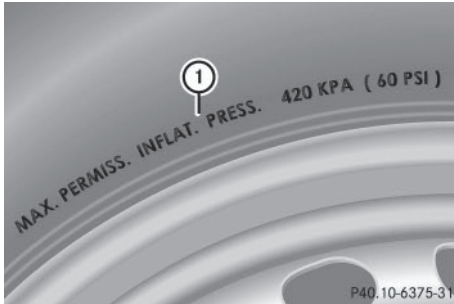

- ① Example: maximum permissible tire pressure

Never exceed the maximum permissible tire inflation pressure. Always observe the recommended tire pressure for your vehicle when adjusting the tire pressure (▷ page 279).

- i** The actual values for tires are vehicle-specific and may deviate from the values in the illustration.

Checking the tire pressures

Important safety notes

Observe the notes on tire pressure (▷ page 279).

Information on air pressure for the tires on your vehicle can be found:

- on the vehicle's Tire and Loading Information placard on the B-pillar
- on the tire pressure label on the fuel filler flap
- in the "Tire pressure" section

Checking tire pressures manually

To determine and set the correct tire pressure, proceed as follows:

- ▶ Remove the valve cap of the tire that is to be checked.
- ▶ Press the tire pressure gauge securely onto the valve.

- ▶ Read the tire pressure and compare it with the recommended value on the Tire and Loading Information placard (▷ page 279).
- ▶ If the tire pressure is too low, increase it to the recommended value.
- ▶ If the tire pressure is too high, release air by pressing down the metal pin in the valve. Use the tip of a pen, for example. Then, check the tire pressure again using the tire pressure gauge.
- ▶ Screw the valve cap onto the valve.
- ▶ Repeat these steps for the other tires.

Tire pressure monitor

General notes

If a tire pressure monitor is installed, the vehicle's wheels have sensors that monitor the tire pressures in all four tires. The tire pressure monitor warns you if the pressure drops in one or more of the tires. The tire pressure monitor only functions if the corresponding sensors are installed in all wheels.

Information on tire pressures is displayed in the multifunction display. After a few minutes of driving, the current tire pressure of each tire is shown in the **Service** menu of the multifunction display; see illustration (example).



For information on the message display, refer to the "Checking the tire pressure electronically" section (▷ page 284).

Important safety notes

⚠ WARNING

Each tire, including the spare (if provided), should be checked at least once every two weeks when cold and inflated to the pressure

recommended by the vehicle manufacturer on the Tire and Loading Information placard on the driver's door B-pillar or the tire pressure label on the inside of the fuel filler flap. If your vehicle has tires of a different size than the size indicated on the Tire and Loading Information placard or, if available, the tire pressure label, you should determine the proper tire pressure for those tires.

As an added safety feature, your vehicle has been equipped with a tire pressure monitoring system (TPMS) that illuminates a low tire pressure telltale when one or more of your tires are significantly underinflated. Accordingly, when the low tire pressure telltale lights up, you should stop and check your tires as soon as possible, and inflate them to the proper pressure. Driving on a significantly underinflated tire causes the tire to overheat and can lead to tire failure.

Underinflation also reduces fuel efficiency and tire tread life, and may affect the vehicle's handling and stopping ability. Please note that the TPMS is not a substitute for proper tire maintenance, and it is the driver's responsibility to maintain correct tire pressure, even if underinflation has not reached the level to trigger illumination of the TPMS low tire pressure telltale.

Your vehicle has also been equipped with a TPMS malfunction indicator to indicate when the system is not operating properly. The TPMS malfunction indicator is combined with the low tire pressure telltale. When the system detects a malfunction, the warning lamp will flash for approximately a minute and then remain continuously illuminated. This sequence will be repeated every time the vehicle is started as long as the malfunction exists. When the malfunction indicator is illuminated, the system may not be able to detect or signal low tire pressure as intended.

TPMS malfunctions may occur for a variety of reasons, including the installation of incompatible replacement or alternate tires or wheels on the vehicle that prevent the TPMS from functioning properly. Always check the

TPMS malfunction telltale after replacing one or more tires or wheels on your vehicle to ensure that the replacement or alternate Tires and wheels allow the TPMS to continue to function properly.

It is the driver's responsibility to set the tire pressure to that recommended for cold tires which is suitable for the operating situation (▷ page 279). Note that the correct tire pressure for the current operating situation must first be taught-in to the tire pressure monitor. If there is a substantial loss of pressure, the warning threshold for the warning message is aligned to the reference values taught-in. Restart the tire pressure monitor after adjusting the pressure of the cold tires (▷ page 284). The current pressures are saved as new reference values. As a result, a warning message will appear if the tire pressure drops significantly.

The tire pressure monitor does not warn you of an incorrectly set tire pressure. Observe the notes on the recommended tire pressure (▷ page 279).

The tire pressure monitor is not able to warn you of a sudden loss of pressure, e.g. if the tire is penetrated by a foreign object. In the event of a sudden loss of pressure, bring the vehicle to a halt by braking carefully. Avoid abrupt steering maneuvers.

The tire pressure monitor has a yellow warning lamp in the instrument cluster for indicating a pressure loss or malfunction. Whether the warning lamp flashes or lights up indicates whether a tire pressure is too low or the tire pressure monitor is malfunctioning:

- if the warning lamp is lit continuously, the tire pressure on one or more tires is significantly too low. The tire pressure monitor is not malfunctioning.
- if the warning lamp flashes for around a minute and then remains lit constantly, the tire pressure monitor is malfunctioning.

i In addition to the warning lamp, a message appears in the multifunction display.







You can find further information under:
(▷ page 208).

If the tire pressure monitor is malfunctioning, it may take up to ten minutes for the tire pressure warning lamp to inform you of the malfunction by flashing for approximately one minute and then remaining lit. When the malfunction has been rectified, the tire pressure warning lamp goes out after a few minutes of driving.

The tire pressure values indicated by the on-board computer may differ from those measured at a gas station with a pressure gauge. The tire pressures shown by the on-board computer refer to those measured at sea level. At high altitudes, the tire pressure values indicated by a pressure gauge are higher than those shown by the on-board computer. In this case, do not reduce the tire pressures.

The operation of the tire pressure monitor can be affected by interference from radio transmitting equipment (e.g. radio headphones, two-way radios) that may be being operated in or near the vehicle.

Checking the tire pressure electronically

- ▶ Make sure that the SmartKey is in position 2 in the ignition lock (▷ page 133).
- ▶ Use  on the steering wheel to call up the list of menus.
- ▶ Press the  or  button on the steering wheel to select the **Service** menu.
- ▶ Press the  button.
- ▶ Press the  or  button to select **Tire Pressure**.
- ▶ Press the  button.

The current tire pressure of each tire is shown in the multifunction display.

If the vehicle has been parked for over 20 minutes, the **Tire pressure will be displayed after driving a few minutes** message appears.

After a teach-in process, the tire pressure monitor automatically detects new wheels or

new sensors. As long as a clear allocation of the tire pressure value to the individual wheels is not possible, the **Tire Pressure Monitor Active** display message is shown instead of the tire pressure display. The tire pressures are already being monitored.

Tire pressure monitor warning messages

If the tire pressure monitor detects a pressure loss in one or more tires, a warning message is shown in the multifunction display and the yellow tire pressure monitor warning lamp comes on.

- If the **Please Correct Tire Pressure** message appears in the multifunction display, the tire pressure in at least one tire is too low and must be corrected at the next opportunity.
- If the **Check Tires** message appears in the multifunction display, the tire pressure in one or more tires has dropped significantly and the tires must be checked.
- If the **Warning Tire Malfunction** appears in the multifunction display, the tire pressure in one or more tires has dropped suddenly and the tires must be checked.

Observe the instructions and safety notes in the display messages in the "Tires" section (▷ page 208).

- ❗ If the wheel positions on the vehicle are rotated, the tire pressures may be displayed for the wrong positions for a short time. This is rectified after a few minutes of driving, and the tire pressures are displayed for the correct positions.









Restarting the tire pressure monitor

When you restart the tire pressure monitor, all existing warning messages are deleted and the warning lamps go out. The monitor uses the currently set tire pressures as the reference values for monitoring. In most cases, the tire pressure monitor will automatically

detect the new reference values after you have changed the tire pressure. However, you can also define reference values manually as described here. The tire pressure monitor then monitors the new tire pressure values.

- ▶ Set the tire pressure to the value recommended for the corresponding driving situation on the Tire and Loading Information placard on the driver's side B-pillar (▷ page 279).

Additional tire pressure values for different loads can also be found on the tire pressure table on the inside of the fuel filler flap (▷ page 279).

- ▶ Make sure that the tire pressure is correct on all four wheels.
- ▶ Make sure that the SmartKey is in position 2 in the ignition lock.
- ▶ Use  on the steering wheel to call up the list of menus.
- ▶ Press the  or  button on the steering wheel to select the **Service** menu.
- ▶ Press the  button.
- ▶ Press the  or  button to select **Tire Pressure**.
- ▶ Press the  button.
The multifunction display shows the current tire pressure for the individual tires or the **Tire pressure will be displayed after driving a few minutes** message.
- ▶ Press the  button.
The **Use Current Pressures as New Reference Values** message appears in the multifunction display.

If you wish to confirm the restart:

- ▶ Press the  button.
The **Tire Press. Monitor Restarted** message appears in the multifunction display.
After driving for a few minutes, the system checks whether the current tire pressures are within the specified range. The new tire pressures are then accepted as reference values and monitored.

If you wish to cancel the restart:

- ▶ Press the  button.
The tire pressure values stored at the last restart will continue to be monitored.

Radio type approval for the tire pressure monitor

In certain countries, a radio type approval for the tire pressure monitor may be required. The radio type approval number for the tire pressure monitor can be found in the "Wheels and tires" section of the Digital Operator's Manual.

Tire pressure loss warning system (Canada only)

General notes

While the vehicle is in motion, the tire pressure loss warning system monitors the set tire pressure using the rotational speed of the wheels. This enables the system to detect significant pressure loss in a tire. If the speed of rotation of a wheel changes as a result of a loss of pressure, a corresponding warning message will appear in the multifunction display.

You can recognize the tire pressure loss warning by the **Run Flat Indicator Active Press 'OK' to Restart** message which appears in the **Service** menu of the multifunction display. Information on the message display can be found in the "Restarting the tire pressure loss warning system" section (▷ page 286).

Important safety notes

The tire pressure warning system does not warn you of an incorrectly set tire pressure. Observe the notes on the recommended tire pressure (▷ page 279).

The tire pressure loss warning does not replace the need to regularly check the tire pressure. An even loss of pressure on several

tires at the same time cannot be detected by the tire pressure loss warning system.

The tire pressure monitor is not able to warn you of a sudden loss of pressure, e.g. if the tire is penetrated by a foreign object. In the event of a sudden loss of pressure, bring the vehicle to a halt by braking carefully. Avoid abrupt steering maneuvers.

The function of the tire pressure loss warning system is limited or delayed if:







- snow chains are mounted on your vehicle's tires.
- road conditions are wintry.
- you are driving on sand or gravel.
- you adopt a very sporty driving style (cornering at high speeds or driving with high rates of acceleration).
- you are driving with a heavy load (in the vehicle or on the roof).

Wheels and tires





Restarting the tire pressure loss warning system

Restart the tire pressure loss warning system if you have:

- changed the tire pressure
 - changed the wheels or tires
 - mounted new wheels or tires
- ▶ Before restarting, make sure that the tire pressures are set properly on all four tires for the respective operating conditions.
- The recommended tire pressure can be found on the Tire and Loading Information placard on the B-pillar on the driver's side. Additionally, a tire pressure table is attached to the fuel filler flap. The tire pressure loss warning system can only give reliable warnings if you have set the correct tire pressure. If an incorrect tire pressure is set, these incorrect values will be monitored.
- ▶ Also observe the notes in the section on tire pressures (▷ page 279).
- ▶ Make sure that the SmartKey is in position 2 in the ignition lock (▷ page 133).





- ▶ Use  on the steering wheel to call up the list of menus.
- ▶ Press the  or  button on the steering wheel to select the **Service** menu.
- ▶ Press the  button.
- ▶ Press the  or  button to select **Tire Pressure**.
- ▶ Press the  button.
The **Run Flat Indicator Active Press 'OK' to Restart** message appears in the multifunction display.

If you wish to confirm the restart:

- ▶ Press the  button.
The **Tire Pressure Now OK?** message appears in the multifunction display.
- ▶ Press the  or  button to select **Yes**.
- ▶ Press the  button.
The **Run Flat Indicator Restarted** message appears in the multifunction display.

After a teach-in period, the tire pressure loss warning system will monitor the set tire pressures of all four tires.

If you wish to cancel the restart:

- ▶ Press the  button.
- or
- ▶ If the **Tire Pressure Now OK?** message appears, use the  or  button to select **Cancel**.
 - ▶ Press the  button.
The tire pressure values stored at the last restart will continue to be monitored.

Loading the vehicle

Instruction labels for tires and loads

WARNING

Overloaded tires can overheat, causing a blowout. Overloaded tires can also impair the steering and driving characteristics and lead to brake failure. There is a risk of accident.

Observe the load rating of the tires. The load rating must be at least half of the GAWR of your vehicle. Never overload the tires by exceeding the maximum load.

Two instruction labels on your vehicle show the maximum possible load.

- (1) The Tire and Loading Information placard is on the B-pillar on the driver's side. The Tire and Loading Information placard shows the maximum permissible number of occupants and the maximum permissible vehicle load. It also contains details of the tire sizes and corresponding pressures for tires mounted at the factory.
- (2) The vehicle identification plate is on the B-pillar on the driver's side. The vehicle identification plate informs you of the gross vehicle weight rating. It is made up of the vehicle weight, all vehicle occupants, the fuel and the cargo. You can also find information about the maximum gross axle weight rating on the front and rear axle.

The maximum gross axle weight rating is the maximum weight that can be carried by one axle (front or rear axle). Never exceed the maximum load or the maximum gross axle weight rating for the front or rear axle.

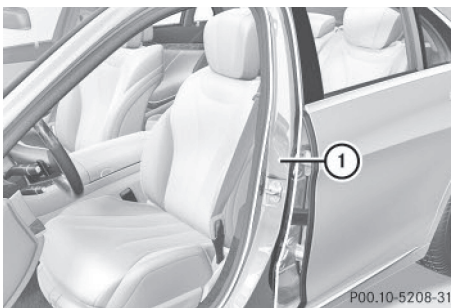

① B-pillar, driver's side

Maximum permissible gross vehicle weight rating

| TIRE RENSEIGNEMENTS SUR LES PNEUS ET LE CHARGEMENT | | | |
|--|---------------------|---|--|
| SEATING CAPACITY / NOMBRE DE PLACES | | TOTAL 7 | |
| | | FRONT AVANT 2 | MIDDLE MILIEU 3 |
| | | REAR ARRIERE 2 | |
| The combined weight of occupants and cargo should never exceed XXX kg or XXX lbs. / Le poids total des occupants et du chargement ne doit jamais dépasser XXX kg ou XXX lbs. | | | |
| TIRE PNEU | SIZE DIMENSIONS | COLD TIRE PRESSURE / PRESSION DES PNEUS A FROID | SEE OWNER'S MANUAL FOR ADDITIONAL INFORMATION / VOIR LE MANUEL DE L'USAGER POUR PLUS DE RENSEIGNEMENTS |
| FRONT AVANT | 255/40 ZR18 99Y XL | 200 KPA, 29 PSI | |
| REAR ARRIERE | 285/35 ZR18 101Y XL | 200 KPA, 29 PSI | |
| SPARE DE SECOURS | 175/55-18 95P | 420 KPA, 60 PSI | |

P40.00-2224-31

- Specification for maximum gross vehicle weight ① is listed in the Tire and Loading Information placard: "The combined weight of occupants and cargo should never exceed XXX kilograms or XXX lbs."

The gross weight of all vehicle occupants, load and luggage must not exceed the specified value.

- ❗ The specifications shown on the Tire and Loading Information placard in the illustration are examples. The maximum permissible gross vehicle weight rating is vehicle-specific and may differ from that in the illustration. You can find the valid maximum permissible gross vehicle weight rating for your vehicle on the Tire and Loading Information placard.

Number of seats

| TIRE RENSEIGNEMENTS SUR LES PNEUS ET LE CHARGEMENT | | | |
|--|---------------------|---|--|
| SEATING CAPACITY / NOMBRE DE PLACES | | TOTAL 7 | |
| | | FRONT AVANT 2 | MIDDLE MILIEU 3 |
| | | REAR ARRIERE 2 | |
| The combined weight of occupants and cargo should never exceed XXX kg or XXX lbs. / Le poids total des occupants et du chargement ne doit jamais dépasser XXX kg ou XXX lbs. | | | |
| TIRE PNEU | SIZE DIMENSIONS | COLD TIRE PRESSURE / PRESSION DES PNEUS A FROID | SEE OWNER'S MANUAL FOR ADDITIONAL INFORMATION / VOIR LE MANUEL DE L'USAGER POUR PLUS DE RENSEIGNEMENTS |
| FRONT AVANT | 255/40 ZR18 99Y XL | 200 KPA, 29 PSI | |
| REAR ARRIERE | 285/35 ZR18 101Y XL | 200 KPA, 29 PSI | |
| SPARE DE SECOURS | 175/55-18 95P | 420 KPA, 60 PSI | |

P40.00-2225-31

Maximum number of seats ① indicates the maximum number of occupants allowed to

travel in the vehicle. This information can be found on the Tire and Loading Information placard.

- i** The specifications shown on the Tire and Loading Information placard in the illustration are examples. The number of seats is vehicle-specific and can differ from the details shown. The number of seats in your vehicle can be found on the Tire and Loading Information placard.

Determining the correct load limit

Step-by-step instructions

The following steps have been developed as required of all manufacturers under Title 49, Code of U.S. Federal Regulations, Part 575 pursuant to the "National Traffic and Motor Vehicle Safety Act of 1966".

- ▶ **Step 1:** Locate the statement "The combined weight of occupants and cargo should never exceed XXX kg or XXX lbs." on your vehicle's Tire and Loading Information placard.
- ▶ **Step 2:** Determine the combined weight of the driver and passengers that will be riding in your vehicle.
- ▶ **Step 3:** Subtract the combined weight of the driver and passengers from XXX kilograms or XXX lbs.
- ▶ **Step 4:** The resulting figure equals the available amount of cargo and luggage load capacity. For example, if the "XXX" amount equals 1400 lbs and there will be five 150-lb passengers in your vehicle, the amount of available cargo and luggage load capacity is 650 lbs ($1400 - 750 (5 \times 150) = 650$ lbs).
- ▶ **Step 5:** Determine the combined weight of luggage and cargo being loaded on the vehicle. That weight may not safely exceed the available cargo and luggage load capacity calculated in step 4.

Example: steps 1 to 3

The following table shows examples on how to calculate total and cargo load capacities with varying seating configurations and number and size of occupants. The following examples use a load limit of 1500 lbs (680 kg). **This is for illustration purposes only.** Make sure you are using the actual load limit for your vehicle stated on your vehicle's Tire and Loading Information placard (▷ page 286).

The greater the combined weight of the occupants, the lower the maximum luggage load.

Example 1

Step 1

- Combined maximum weight of occupants and load (data from the Tire and Loading Information placard): 1500 lbs (680 kg)

Step 2

- Number of people in the vehicle (driver and occupants): 5
- Distribution of the occupants
 - Front: 2
 - Rear: 3
- Weight of the occupants
 - Occupant 1: 150 lbs (68 kg)
 - Occupant 2: 180 lbs (82 kg)
 - Occupant 3: 160 lbs (73 kg)
 - Occupant 4: 140 lbs (63 kg)
 - Occupant 5: 120 lbs (54 kg)
- Total weight of all occupants: 750 lbs (340 kg)

Step 3

- Permissible load (maximum gross vehicle weight rating from the Tire and Loading Information placard minus the gross weight of all occupants):
 $1500 \text{ lbs (680 kg)} - 750 \text{ lbs (340 kg)} = 750 \text{ lbs (340 kg)}$

Example 2

Step 1

- Combined maximum weight of occupants and load (data from the Tire and Loading Information placard): 1500 lbs (680 kg)

Step 2

- Number of people in the vehicle (driver and occupants): 3
- Distribution of the occupants
 - Front: 1
 - Rear: 2

- Weight of the occupants
 - Occupant 1: 200 lbs (91 kg)
 - Occupant 2: 190 lbs (86 kg)
 - Occupant 3: 150 lbs (68 kg)
- Total weight of all occupants: 540 lbs (245 kg)

Step 3

- Permissible load (maximum gross vehicle weight rating from the Tire and Loading Information placard minus the gross weight of all occupants):
 $1500 \text{ lbs (680 kg)} - 540 \text{ lbs (245 kg)} = 960 \text{ lbs (435 kg)}$

Example 3

Step 1

- Combined maximum weight of occupants and load (data from the Tire and Loading Information placard): 1500 lbs (680 kg)

Step 2

- Number of people in the vehicle (driver and occupants): 2
- Distribution of the occupants:
 - Front: 1
- Weight of the occupants
 - Occupant 1: 150 lbs (68 kg)
- Total weight of all occupants: 150 lbs (68 kg)

Step 3

- Permissible load (maximum gross vehicle weight rating from the Tire and Loading Information placard minus the gross weight of all occupants):
 $1500 \text{ lbs (680 kg)} - 150 \text{ lbs (68 kg)} = 1350 \text{ lbs (612 kg)}$

Vehicle identification plate

Even if you have calculated the total cargo carefully, you should still make sure that the gross vehicle weight rating and the gross axle weight rating are not exceeded. Details can be found on the vehicle identification plate on the B-pillar on the driver's side of the vehicle (> page 286).

Permissible Gross Vehicle Weight Rating

(GVWR): the gross weight of the vehicle, all passengers, load and trailer load/noseweight (if applicable) must not exceed the permissible gross vehicle weight.

Gross Axle Weight Rating (GAWR): the maximum permissible weight that can be carried by one axle (front or rear axle).

To ensure that your vehicle does not exceed the maximum permissible values (gross vehicle weight and maximum gross axle weight rating), have your loaded vehicle (including driver, occupants, cargo, and full trailer load if applicable) weighed on a suitable vehicle weighbridge.

All about wheels and tires

Uniform Tire Quality Grading Standards

Overview of Tire Quality Grading Standards

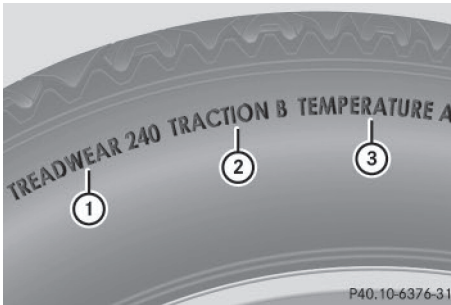

Uniform Tire Quality Grading Standards are U.S. government specifications. Their purpose is to provide drivers with uniform reliable information on tire performance data. Tire manufacturers have to grade tires using three performance factors: ① tread wear grade, ② traction grade and ③ temperature grade. These regulations do not apply to Canada. Nevertheless, all tires sold in North America are provided with the corresponding quality grading markings on the sidewall of the tire. Quality grades can be found, where applicable, on the tire sidewall between the tread shoulder and maximum tire width.

Example:

- **Treadwear grade:** 200
- **Traction grade:** AA
- **Temperature grade:** A

All passenger car tires must conform to the statutory safety requirements in addition to these grades.

- ❗ The actual values for tires are vehicle-specific and may deviate from the values in the illustration.

Treadwear

The treadwear grade is a comparative rating based on the wear rate of the tire when tested under controlled conditions on a specified U.S. government course. For example, a tire graded 150 would wear one and one-half times as well on the government course as a tire graded 100.

The relative performance of tires depends upon the actual conditions of their use, however, and may depart significantly from the norm due to variations in driving habits, service practices and differences in road characteristics and climate conditions.

Traction

WARNING

The traction grade assigned to this tire is based on straight-ahead braking traction tests, and does not include acceleration, cornering, hydroplaning, or peak traction characteristics.

- ❗ Avoid wheelspin. This can lead to damage to the drive train.

The traction grades – from highest to lowest – are AA, A, B and C. Those grades represent the tire's ability to stop on wet pavement as measured under controlled conditions on specified government test surfaces of asphalt and concrete. A tire marked C may have poor traction performance.

The safe speed on a wet, snow covered or icy road is always lower than on dry road surfaces.

You should pay special attention to road conditions when temperatures are around freezing point.

Mercedes-Benz recommends a minimum tread depth of $\frac{1}{8}$ in (4 mm) on all four winter tires. Observe the legally required minimum tire tread depth (> page 277). Winter tires can reduce the braking distance on snow-covered surfaces in comparison with summer tires. The braking distance is still much further than

on surfaces that are not icy or covered with snow. Take appropriate care when driving. Further information on winter tires (M+S tires) can be found in the Digital Operator's Manual.

Temperature

WARNING

The temperature grade for this tire is established for a tire that is properly inflated and not overloaded. Excessive speed, underinflation, or excessive loading, either separately or in combination, can cause excessive heat build-up and possible tire failure.

The temperature grades are A (the highest), B, and C. They represent the tire's resistance to the generation of heat and its ability to dissipate heat when tested under controlled conditions on a specified indoor laboratory test wheel. Sustained high temperature can cause the material of the tire to degenerate and reduce tire life, and excessive temperature can lead to sudden tire failure. The grade C corresponds to a level of performance which all passenger car tires must meet under the Federal Motor Vehicle Safety Standard No. 109. Grades B and A represent higher levels of performance on the laboratory test wheel than the minimum required by law.

Tire labeling

Overview

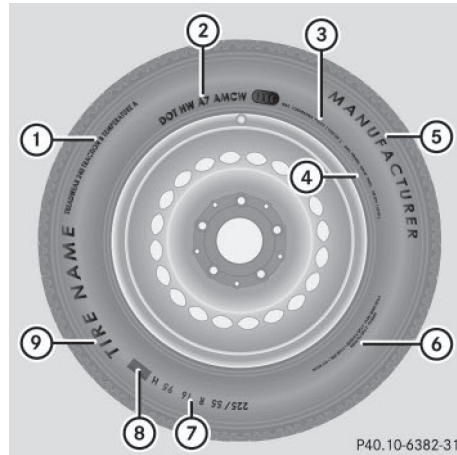

- ① Uniform Tire Quality Grading Standard (▷ page 296)
- ② DOT, Tire Identification Number (▷ page 295)
- ③ Maximum tire load (▷ page 295)
- ④ Maximum tire pressure (▷ page 282)
- ⑤ Manufacturer
- ⑥ Tire material (▷ page 296)
- ⑦ Tire size designation, load-bearing capacity and speed rating (▷ page 292)
- ⑧ Load index (▷ page 295)
- ⑨ Tire name

The markings described above are on the tire in addition to the tire name (sales designation) and the manufacturer's name.

-  Tire data is vehicle-specific and may deviate from the data in the example.

Tire size designation, load-bearing capacity and speed rating

WARNING

Exceeding the stated tire load-bearing capacity and the approved maximum speed could lead to tire damage or the tire bursting. There is a risk of accident.

Therefore, only use tire types and sizes approved for your vehicle model. Observe the tire load rating and speed rating required for your vehicle.

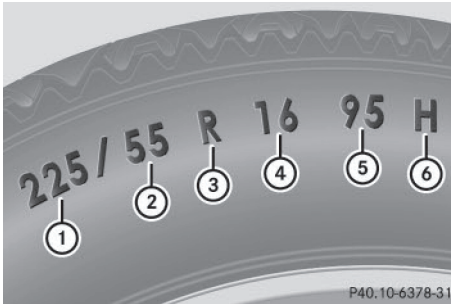

- ① Tire width
- ② Nominal aspect ratio in %
- ③ Tire code
- ④ Rim diameter
- ⑤ Load bearing index
- ⑥ Speed rating

General: depending on the manufacturer's standards, the size imprinted in the tire wall may not contain any letters or may contain one letter that precedes the size description. If there is no letter preceding the size description (as shown above): these are passenger vehicle tires according to European manufacturing standards.

If "P" precedes the size description: these are passenger vehicle tires according to U.S. manufacturing standards.

If "LT" precedes the size description: these are light truck tires according to U.S. manufacturing standards.

If "T" precedes the size description: these are compact emergency spare wheels at high tire pressure, to be used only temporarily in an emergency.

Tire width: tire width ① shows the nominal tire width in millimeters.

Aspect ratio: aspect ratio ② is the size ratio between the tire height and tire width and is shown in percent. The aspect ratio is calcu-

lated by dividing the tire width by the tire height.

Tire code: tire code ③ specifies the tire type. "R" represents radial tires; "D" represents diagonal tires; "B" represents diagonal radial tires.

Optionally, tires with a maximum speed of over 149 mph (240 km/h) may have "ZR" in the size description, depending on the manufacturer (e.g. 245/40 ZR 18).

Rim diameter: rim diameter ④ is the diameter of the bead seat, not the diameter of the rim flange. The rim diameter is specified in inches (in).

Load-bearing index: load-bearing index ⑤ is a numerical code that specifies the maximum load-bearing capacity of a tire.

Do not overload the tires by exceeding the specified load limit. The maximum permissible load can be found on the vehicle's Tire and Loading Information placard on the B-pillar on the driver's side (▷ page 286).

Example:

Load-bearing index 91 indicates a maximum load of 1,356 lb (615 kg) that the tires can bear. For further information on the maximum tire load in kilograms and lbs, see (▷ page 295).

For further information on the load bearing index, see "Load index" (▷ page 295).

Speed rating: speed rating ⑥ specifies the approved maximum speed of the tire.

i Tire data is vehicle-specific and may deviate from the data in the example.

Regardless of the speed rating, always observe the speed limits. Drive carefully and adapt your driving style to the traffic conditions.

Summer tires

| Index | Speed rating |
|-------|--------------------------|
| Q | up to 100 mph (160 km/h) |
| R | up to 106 mph (170 km/h) |

| Index | Speed rating |
|------------|--------------------------|
| S | up to 112 mph (180 km/h) |
| T | up to 118 mph (190 km/h) |
| H | up to 130 mph (210 km/h) |
| V | up to 149 mph (240 km/h) |
| W | up to 168 mph (270 km/h) |
| Y | up to 186 mph (300 km/h) |
| ZR...Y | up to 186 mph (300 km/h) |
| ZR...(..Y) | over 186 mph (300 km/h) |
| ZR | over 149 mph (240 km/h) |

- Optionally, tires with a maximum speed of over 149 mph (240 km/h) may have "ZR" in the size description, depending on the manufacturer (e.g. 245/40 ZR18).

The service specification is made up of load-bearing index ⑤ and speed rating ⑥.

- If the size description of your tire includes "ZR" and there are no service specifications, ask the tire manufacturer in order to find out the maximum speed.

If a service specification is available, the maximum speed is limited according to the speed rating in the service specification.

Example: 245/40 ZR18 97 Y. In this example, "97 Y" is the service specification. The letter "Y" represents the speed rating. The maximum speed of the tire is limited to 186 mph (300 km/h).

- The size description for all tires with maximum speeds of over 186 mph (300 km/h) must include "ZR", **and** the service specification must be given in parentheses. Example: 275/40 ZR 18 (99 Y). Speed rating "(Y)" indicates that the maximum speed of the tire is over 186 mph (300 km/h). Ask the tire manufacturer about the maximum speed.

All-weather tires and winter tires

| Index | Speed rating |
|--------------------|--------------------------|
| Q M+S ¹ | up to 100 mph (160 km/h) |
| T M+S ¹ | up to 118 mph (190 km/h) |
| H M+S ¹ | up to 130 mph (210 km/h) |
| V M+S ¹ | up to 149 mph (240 km/h) |

- i** Not all tires with the M+S marking provide the driving characteristics of winter tires. In addition to the M+S marking, winter tires also have the  snowflake symbol on the tire wall. Tires with this marking fulfill the requirements of the Rubber Manufacturers Association (RMA) and the Rubber Association of Canada (RAC) regarding the tire traction on snow. They have been especially developed for driving on snow.

An electronic speed limiter prevents your vehicle from exceeding a speed of 130mph (210km/h).

The speed rating of tires mounted at the factory may be higher than the maximum speed that the electronic speed limiter permits.

Make sure that your tires have the required speed rating, e.g. when buying new tires. The required speed rating for your vehicle can be found in the "Tires" section (▷ page 304).

Further information about reading tire data can be obtained from any qualified specialist workshop.

¹ Or M+S  for winter tires.

Load index



In addition to the load-bearing index, load index ① may also be imprinted on the sidewall of the tire. You will find this after the letter that identifies the speed rating (▷ page 292).

- If no specification is given: no text (as in the example above), represents a standard load (SL) tire
- XL or Extra Load: represents a reinforced tire
- Light Load: represents a light load tire
- C, D, E: represents a load range that depends on the maximum load that the tire can carry at a certain pressure

i Tire data is vehicle-specific and may deviate from the data in the example.

Maximum load rating

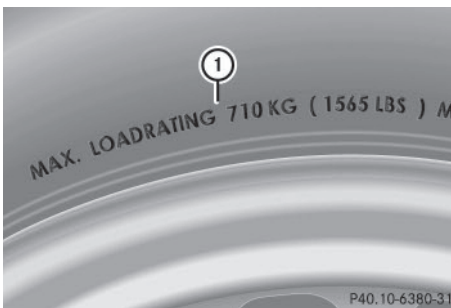

Maximum tire load ① is the maximum permissible weight for which the tire is approved. Do not overload the tires by exceeding the specified load limit. The maximum permissi-

ble load can be found on the vehicle's Tire and Loading Information placard on the B-pillar on the driver's side (▷ page 286).

i The actual values for tires are vehicle-specific and may deviate from the values in the illustration.

DOT, Tire Identification Number (TIN)

US tire regulations stipulate that every tire manufacturer or retreader must imprint a TIN in or on the sidewall of each tire produced.

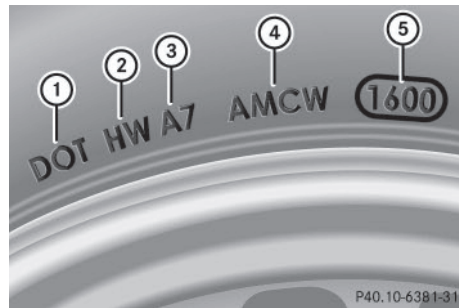

The TIN is a unique identification number. The TIN enables the tire manufacturers or retreaders to inform purchasers of recalls and other safety-relevant matters. It makes it possible for the purchaser to easily identify the affected tires.

The TIN is made up of manufacturer identification code ②, tire size ③, tire type code ④ and manufacturing date ⑤.

DOT (Department of Transportation): tire symbol ① marks that the tire complies with the requirements of the U.S. Department of Transportation.

Manufacturer identification code: manufacturer identification code ② provides details on the tire manufacturer. New tires have a code with two symbols. Retreaded tires have a code with four symbols.

Tire size: identifier ③ describes the tire size.

Tire type code: tire type code ④ can be used by the manufacturer as a code to describe specific characteristics of the tire.

Date of manufacture: date of manufacture ⑤ provides information about the age of a tire. The first and second positions represent the week of manufacture, starting with "01" for the first calendar week. Positions three and four represent the year of manufacture. For example, a tire that is marked with "3208", was manufactured in week 32 in 2008.

- ① Tire data is vehicle-specific and may deviate from the data in the example.

Tire characteristics

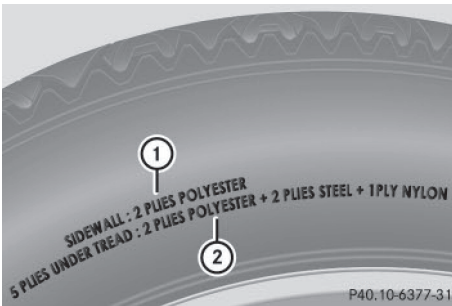

This information describes the type of tire cord and the number of layers in sidewall ① and under tire tread ②.

- ① Tire data is vehicle-specific and may deviate from the data in the example.

Definition of terms for tires and loading

Tire ply composition and material used

Describes the number of plies or the number of layers of rubber-coated fabric in the tire tread and sidewall. These are made of steel, nylon, polyester and other materials.

Bar

Metric unit for tire pressure. 14.5038 pounds per square inch (psi) and 100 kilopascals (kPa) are the equivalent of 1 bar.

DOT (Department of Transportation)

DOT-marked tires fulfill the requirements of the U S Department of Transportation.

Normal occupant weight

The number of occupants for which the vehicle is designed multiplied by 68 kilograms (150 lbs).

Uniform Tire Quality Grading Standards

A uniform standard to grade the quality of tires with regards to tread quality, tire traction and temperature characteristics. The quality grading assessment is made by the manufacturer following specifications from the U.S. government. The ratings are molded into the sidewall of the tire.

Recommended tire pressures

The recommended tire pressure applies to the tires mounted at the factory.

The Tire and Loading Information placard contains the recommended tire pressures for cold tires on a fully loaded vehicle and for the maximum permissible vehicle speed.

The tire pressure table contains the recommended pressures for cold tires for various operating conditions, i.e. differing load and speed conditions.

Increased vehicle weight due to optional equipment

The combined weight of all standard and optional equipment available for the vehicle, regardless of whether it is actually installed on the vehicle or not.

Rim

This is the part of the wheel on which the tire is mounted.

GAWR (Gross Axle Weight Rating)

The GAWR is the maximum gross axle weight rating. The actual load on an axle must never exceed the gross axle weight rating. The gross axle weight rating can be found on the vehicle identification plate on the B-pillar on the driver's side.

Speed rating

The speed rating is part of the tire identification. It specifies the speed range for which the tire is approved.

GVW (Gross Vehicle Weight)

The gross vehicle weight includes the weight of the vehicle including fuel, tools, the spare wheel, accessories installed, occupants, luggage and the drawbar noseweight, if applicable. The gross vehicle weight must not exceed the gross vehicle weight rating GVWR as specified on the vehicle identification plate on the B-pillar on the driver's side.

GVWR (Gross Vehicle Weight Rating)

The GVWR is the maximum permissible gross weight of a fully loaded vehicle (the weight of the vehicle including all accessories, occupants, fuel, luggage and the drawbar noseweight, if applicable). The gross vehicle weight rating is specified on the vehicle identification plate on the B-pillar on the driver's side.

Maximum loaded vehicle weight

The maximum weight is the sum of:

- the curb weight of the vehicle
- the weight of the accessories
- the load limit
- the weight of the factory installed optional equipment

Kilopascal (kPa)

Metric unit for tire pressure. 6.9 kPa corresponds to 1 psi. Another unit for tire pressure is bar. 100 kilopascals (kPa) are the equivalent of 1 bar.

Load index

In addition to the load-bearing index, the load index may also be imprinted on the sidewall of the tire. This specifies the load-bearing capacity more precisely.

Curb weight

The weight of a vehicle with standard equipment including the maximum capacity of fuel, oil and coolant. It also includes the air-conditioning system and optional equipment if these are installed in the vehicle, but does not include passengers or luggage.

Maximum load rating

The maximum load rating is the maximum permissible weight in kilograms or lbs for which a tire is approved.

Maximum permissible tire pressure

Maximum permissible tire pressure for one tire.

Maximum load on one tire

Maximum load on one tire. This is calculated by dividing the maximum axle load of one axle by two.

PSI (pounds per square inch)

A standard unit of measure for tire pressure.

Aspect ratio

Relationship between tire height and tire width in percent.

Tire pressure

This is pressure inside the tire applying an outward force to each square inch of the tire's surface. The tire pressure is specified in pounds per square inch (psi), in kilopascal (kPa) or in bar. The tire pressure should only be corrected when the tires are cold.

Cold tire pressure

The tires are cold:

- if the vehicle has been parked without direct sunlight on the tires for at least three hours and
- if the vehicle has not been driven further than 1 mile (1.6 km)

Tread

The part of the tire that comes into contact with the road.

Bead

The tire bead ensures that the tire sits securely on the wheel. There are several steel wires in the bead to prevent the tire from coming loose from the wheel rim.

Sidewall

The part of the tire between the tread and the bead.

Weight of optional extras

The combined weight of those optional extras that weigh more than the replaced standard parts and more than 5 lbs (2.3 kg). These optional extras, such as high-performance brakes, level control, a roof rack or a high-performance battery, are not included in the curb weight and the weight of the accessories.

TIN (Tire Identification Number)

This is a unique identifier which can be used by a tire manufacturer to identify tires, for example for a product recall, and thus identify the purchasers. The TIN is made up of the manufacturer's identity code, tire size, tire type code and the manufacturing date.

Load bearing index

The load bearing index (also load index) is a code that contains the maximum load bearing capacity of a tire.

Traction

Traction is the result of friction between the tires and the road surface.

Treadwear indicators

Narrow bars (tread wear bars) that are distributed over the tire tread. If the tire tread is level with the bars, the wear limit of $\frac{1}{16}$ in (1.6 mm) has been reached.

Occupant distribution

The distribution of occupants in a vehicle at their designated seating positions.

Total load limit

Nominal load and luggage load plus 68 kg (150 lbs) multiplied by the number of seats in the vehicle.

Changing a wheel

Flat tire

The "Breakdown assistance" section (> page 257) contains information and notes on how to deal with a flat tire. Information on driving with MOExtended tires in the event of a flat tire can be found under "MOExtended tires (tires with run-flat characteristics)" (> page 257).

Rotating the wheels

 **WARNING**

Interchanging the front and rear wheels may severely impair the driving characteristics if the wheels or tires have different dimensions. The wheel brakes or suspension components may also be damaged. There is a risk of accident.

Rotate front and rear wheels only if the wheels and tires are of the same dimensions.

I On vehicles equipped with a tire pressure monitor, electronic components are located in the wheel.

Tire-mounting tools should not be used near the valve. This could damage the electronic components.

Only have tires changed at a qualified specialist workshop.

Always observe the instructions and safety notes in the "Mounting a wheel" section (> page 299).

The wear patterns on the front and rear tires differ, depending on the operating conditions.

Rotate the wheels before a clear wear pattern has formed on the tires. Front tires typically wear more on the shoulders and the rear tires in the center.

If your vehicle's tire configuration allows, you can rotate the wheels according to the intervals in the tire manufacturer's warranty book in your vehicle documents. If no warranty book is available, the tires should be rotated every 3,000 to 6,000 miles (5,000 to 10,000 km), or earlier if tire wear requires. Ensure the direction of rotation is maintained. Clean the contact surfaces of the wheel and the brake disc thoroughly every time a wheel is rotated. Check the tire pressure and, if necessary, restart the tire pressure loss warning system (▷ page 286) or the tire pressure monitor (▷ page 284).

Direction of rotation

Tires with a specified direction of rotation have additional benefits, e.g. if there is a risk of hydroplaning. These advantages can only be gained if the tires are installed corresponding to the direction of rotation. An arrow on the sidewall of the tire indicates its correct direction of rotation.

Storing wheels

Store wheels that are not being used in a cool, dry and preferably dark place. Protect the tires from oil, grease, gasoline and diesel.

Mounting a wheel

Preparing the vehicle

- ▶ Stop the vehicle on solid, non-slippery and level ground.
- ▶ Apply the electric parking brake manually.
- ▶ Bring the front wheels into the straight-ahead position.
- ▶ Shift the transmission to position **P**.

- ▶ Make sure that "normal" level is selected for AIRMATIC (▷ page 169).
 - ▶ Switch off the engine.
 - ▶ Open the driver's door. The on-board electronics now have status **0**. This is the same as the SmartKey having been removed.
 - ▶ Remove Start/Stop button from ignition lock (▷ page 133).
- or, if the SmartKey is inserted in the ignition lock:
- ▶ Remove the SmartKey from the ignition lock.
 - ▶ If included in the vehicle equipment, remove the tire-change tool kit from the vehicle.
 - ▶ Secure the vehicle to prevent it from rolling away.

Securing the vehicle to prevent it from rolling away

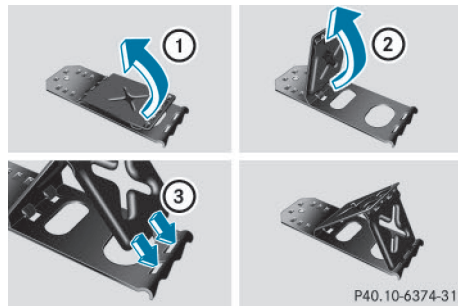

If your vehicle is equipped with a wheel chock, it can be found in the tire-change tool kit (▷ page 256).

The folding wheel chock is an additional safety measure to prevent the vehicle from rolling away, for example when changing a wheel.

- ▶ Fold both plates upwards ①.
- ▶ Fold out lower plate ②.
- ▶ Guide the lugs on the lower plate fully into the openings in base plate ③.



P40.10-6320-31

- ▶ **On level ground:** place chocks or other suitable items under the front and rear of the wheel that is diagonally opposite the wheel you wish to change.

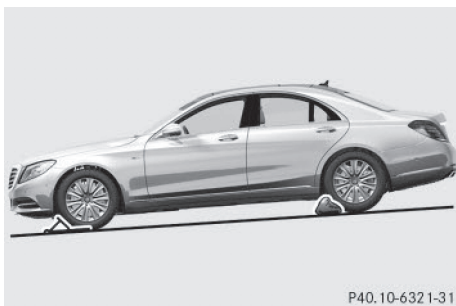

P40.10-6321-31

- ▶ **On light downhill gradients:** place chocks or other suitable items in front of the wheels of the front and rear axle.

Raising the vehicle

WARNING

If you do not position the jack correctly at the appropriate jacking point of the vehicle, the jack could tip over with the vehicle raised. There is a risk of injury.

Only position the jack at the appropriate jacking point of the vehicle. The base of the jack must be positioned vertically, directly under the jacking point of the vehicle.

- ❗ The jack is designed exclusively for jacking up the vehicle at the jacking points. Otherwise, your vehicle could be damaged.

Observe the following when raising the vehicle:

- To raise the vehicle, only use the vehicle-specific jack that has been tested and approved by Mercedes-Benz. If used incorrectly, the jack could tip over with the vehicle raised.
- The jack is designed only to raise and hold the vehicle for a short time while a wheel is being changed. It is not suited for performing maintenance work under the vehicle.
- Avoid changing the wheel on uphill and downhill slopes.
- Before raising the vehicle, secure it from rolling away by applying the parking brake and inserting wheel chocks. Do not disengage the parking brake while the vehicle is raised.
- The jack must be placed on a firm, flat and non-slip surface. On a loose surface, a large, flat, load-bearing underlay must be used. On a slippery surface, a non-slip underlay must be used, e.g. rubber mats.
- Do not use wooden blocks or similar objects as a jack underlay. Otherwise, the jack will not be able to achieve its load-bearing capacity due to the restricted height.
- Make sure that the distance between the underside of the tires and the ground does not exceed 1.2 in (3 cm).
- Never place your hands and feet under the raised vehicle.
- Do not lie under the vehicle.
- Do not start the engine when the vehicle is raised.
- Do not open or close a door or the trunk lid when the vehicle is raised.
- Make sure that no persons are present in the vehicle when the vehicle is raised.

Vehicles with AMG wheels and hub caps: the hub cap covers the wheel bolts. Before you can unscrew the wheel bolts, you must

remove the hub cap. Two different variants can be installed.



P40.10-6437-31

Vehicles with AMG wheels and plastic hub caps:

- ▶ **To remove:** turn the center cover of hub cap ① counter-clockwise and remove.
- ▶ **To install:** before installing, ensure that hub cap ① is in the open position. To do so, turn the center cover counter-clockwise.
- ▶ Put hub cap ① in position and turn the center cover clockwise until you feel and hear hub cap ① engage.
- ▶ Make sure that hub cap ① is installed securely.



P40.10-6456-31

Vehicles with AMG wheels and aluminum hub caps:

- ▶ **To remove:** take socket ② and lug wrench ③ from the vehicle tool kit (▶ page 256).
- ▶ Position socket ② on hub cap ①.
- ▶ Attach lug wrench ③ to socket ② and loosen hub cap ① counter-clockwise.
- ▶ Remove hub cap ①.

- ▶ **To install:** before installing, check hub cap ① and the wheel area for soiling and clean if necessary.
- ▶ Put hub cap ① in position and turn until it is in the right position.
- ▶ Position socket ② on hub cap ①.
- ▶ Attach lug wrench ③ to socket ② and tighten hub cap ①.
The tightening torque must be **18 lb-ft (25 Nm)**.

i Note that the hub cap should be tightened to the specified torque of **18 lb-ft (25 Nm)**. Mercedes-Benz recommends that you have the hub cap installed at a qualified specialist workshop.

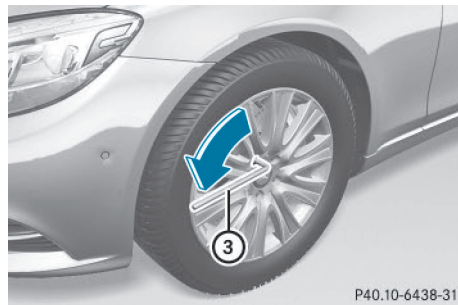

P40.10-6438-31

- ▶ Using lug wrench ③, loosen the bolts on the wheel you wish to change by about one full turn. Do not unscrew the bolts completely.

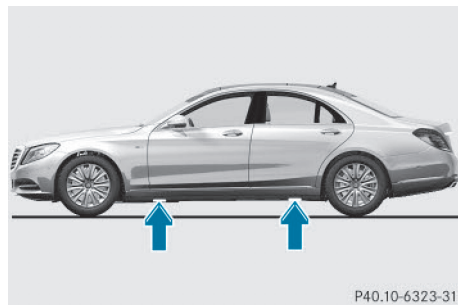

P40.10-6323-31

The jacking points are located just behind the front wheel housings and just in front of the rear wheel housings (arrows).

- ▶ Take the ratchet wrench out of the vehicle tool kit and place it on the hexagon nut of the jack so that the letters **AUF** are visible.

AMG vehicles and vehicles with AMG equipment: to protect the vehicle body, the vehicle has covers next to the jacking points on the outer sills.

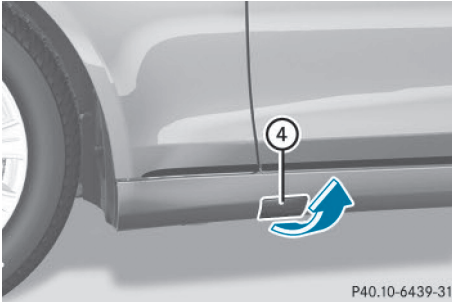

P40.10-6439-31

- ▶ **AMG vehicles and vehicles with AMG equipment:** fold cover ④ upwards.

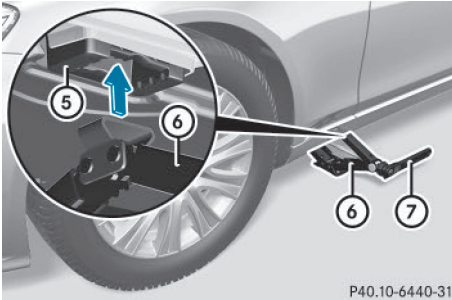

P40.10-6440-31

- ▶ Position jack ⑥ at jacking point ⑤.

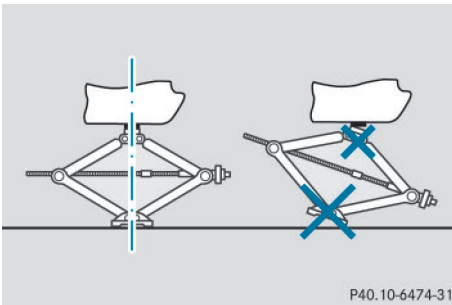

P40.10-6474-31

- ▶ Make sure the foot of the jack is directly beneath the jacking point.

- ▶ Turn ratchet wrench ⑦ until jack ⑥ sits completely on jacking point ⑤ and the base of the jack lies evenly on the ground.
- ▶ Turn ratchet wrench ⑦ until the tire is raised a maximum of 1.2 in (3 cm) from the ground.

Removing a wheel

AMG vehicles: during removal and repositioning of the wheel, the wheel rim can strike the ceramic-brake disc and damage it. Therefore, you should proceed carefully and get a second person assist to you. Alternatively, you can use a second alignment bolt.

Do not place wheel bolts in sand or on a dirty surface. The bolt and wheel hub threads could otherwise be damaged when you screw them in.

When mounting/removing wheels, and for as long as the wheels are removed, avoid applying any external force on the brake disks. This could impair the level of comfort when braking.

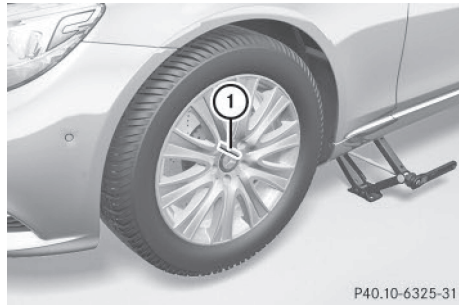

P40.10-6325-31

- ▶ Unscrew the uppermost wheel bolt completely.
- ▶ Screw alignment bolt ① into the thread instead of the wheel bolt.
- ▶ Unscrew the remaining wheel bolts fully.
- ▶ Remove the wheel.

Mounting a new wheel

WARNING

Oiled or greased wheel bolts or damaged wheel bolts/hub threads can cause the wheel bolts to come loose. As a result, you could lose a wheel while driving. There is a risk of accident.

Never oil or grease wheel bolts. In the event of damage to the threads, contact a qualified specialist workshop immediately. Have the damaged wheel bolts or hub threads replaced/renewed. Do not continue driving.

WARNING

If you tighten the wheel bolts or wheel nuts when the vehicle is raised, the jack could tip over. There is a risk of injury.

Only tighten the wheel bolts or wheel nuts when the vehicle is on the ground.

Always pay attention to the instructions and safety notes in the "Changing a wheel" section (▷ page 298).

Only use wheel bolts that have been designed for the wheel and the vehicle. For safety reasons, Mercedes-Benz recommends that you only use wheel bolts which have been approved for Mercedes-Benz vehicles and the respective wheel.

! **AMG vehicles:** during removal and repositioning of the wheel, the wheel rim can strike the ceramic-brake disc and damage it. Therefore, you should proceed carefully and get a second person assist to you. Alternatively, you can use a second alignment bolt.

! To prevent damage to the paintwork, hold the wheel securely against the wheel hub while screwing in the first wheel bolt.

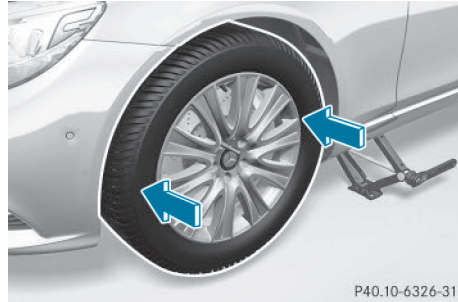

P40.10-6326-31

- ▶ Clean the wheel and wheel hub contact surfaces.
- ▶ Slide the wheel to be mounted onto the alignment bolt and push it on.
- ▶ Tighten the wheel bolts until they are finger-tight.
- ▶ Unscrew the alignment bolt.
- ▶ Tighten the last wheel bolt until it is finger-tight.

Lowering the vehicle

WARNING

The wheels could work loose if the wheel nuts and bolts are not tightened to the specified tightening torque. There is a risk of accident. Have the tightening torque immediately checked at a qualified specialist workshop after a wheel is changed.

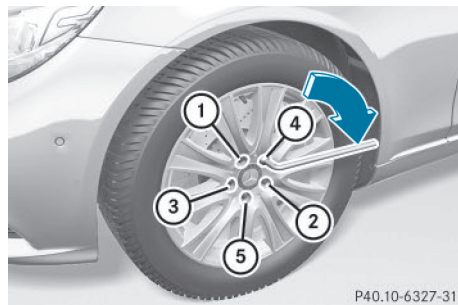

P40.10-6327-31

- ▶ Place the ratchet wrench onto the hexagon nut of the jack so that the letters **AB** are visible.
- ▶ Turn the ratchet wrench until the vehicle is once again standing firmly on the ground.
- ▶ Place the jack to one side.
- ▶ Tighten the wheel bolts evenly in a cross-wise pattern in the sequence indicated (① to ⑤). The tightening torque must be **110 lb-ft (150 Nm)**.
- ▶ Turn the jack back to its initial position.
- ▶ Stow the jack and the rest of the vehicle tools in the trunk again.
- ▶ **AMG vehicles and vehicles with AMG equipment:** insert the cover into the outer sill.
- ▶ Check the tire pressure of the newly mounted wheel and adjust it if necessary. Observe the recommended tire pressure (▷ page 279).

i Vehicles with a tire pressure control system: all mounted wheels must be equipped with functioning tire pressure control sensors.

Wheel and tire combinations

General notes

! For safety reasons, Mercedes-Benz recommends that you only use tires and wheels which have been approved by Mercedes-Benz specifically for your vehicle.

These tires have been specially adapted for use with the control systems, such as ABS or ESP®, and are marked as follows:

- MO = Mercedes-Benz Original
- MOE = Mercedes-Benz Original Extended (tires featuring run-flat characteristics)
- MO1 = Mercedes-Benz Original (only certain AMG tires)

Mercedes-Benz Original Extended tires may only be used on wheels that have been specifically approved by Mercedes-Benz.

Only use tires, wheels or accessories tested and approved by Mercedes-Benz. Certain characteristics, e.g. handling, vehicle noise emissions or fuel consumption, may otherwise be adversely affected. In addition, when driving with a load, tire dimension variations could cause the tires to come into contact with the bodywork and axle components. This could result in damage to the tires or the vehicle.

Mercedes-Benz accepts no liability for damage resulting from the use of tires, wheels or accessories other than those tested and approved.

Information on tires, wheels and approved combinations can be obtained from any qualified specialist workshop.

Overview of abbreviations used in the following tire tables:

- BA: both axles
- FA: front axle
- RA: rear axle

The recommended pressures for various operating conditions can be found:

- on the Tire and Loading Information placard with the recommended tire pressures on the B-pillar on the driver's side
- in the tire pressure table on the inside of the fuel filler flap

Observe the notes on recommended tire pressures under various operating conditions (▷ page 279).

Check tire pressures regularly, and only when the tires are cold. Comply with the maintenance recommendations of the tire manufacturer in the vehicle document wallet.

Notes on the vehicle equipment – always equip the vehicle with:

- tires of the same size on a given axle (left/right)
- the same type of tires at a given time (summer tires, winter tires, MOExtended tires)

Exception: it is permissible to install a different type or make in the event of a flat tire. Observe the "MOExtended tires (tires with run-flat characteristics)" section (▷ page 257).

Vehicles equipped with MOExtended tires are not equipped with a TIREFIT kit at the factory. It is therefore recommended that you additionally equip your vehicle with a TIREFIT kit if you mount tires that do not feature run-flat properties, e.g. winter tires. A TIREFIT kit may be obtained from a qualified specialist workshop.

- i** Not all wheel and tire combinations are available at the factory for all countries.
- i** On the following pages, you can find information on approved wheel rims and tire sizes for equipping your vehicle with winter tires. Winter tires are not available at the factory as standard equipment or optional extras.

If you would like to equip your vehicle with approved winter tires, you may also, in certain circumstances, require rims of the appropriate size. The size of the approved winter tires may deviate from that of the standard tires. This is dependent on the model and the equipment installed at the factory.

The tires and wheel rims, as well as further information, can be obtained at a qualified specialist workshop.

Tires**S 400 4MATIC****Summer tires****R 18**

| Tires | Alloy wheels |
|----------------------|--|
| BA: 245/50 R18 100 W | BA: 8.0 J x 18 H2 Wheel offset: 1.61 in (41 mm) |

R 19

| Tires | Alloy wheels |
|--|--|
| FA: 245/45 R19 102 Y XL RA: 275/40 R19 (101 Y) XL ² | FA: 8.5 J x 19 H2 Wheel offset: 1.42 in (36 mm) RA: 9.5 J x 19 H2 Wheel offset: 1.71 in (43.5 mm) |
| FA: 245/45 R19 102 Y XL ⁵ RA: 275/40 R19 101 Y ^{2, 5} | FA: 8.5 J x 19 H2 Wheel offset: 1.50 in (38 mm) RA: 9.5 J x 19 H2 Wheel offset: 1.50 in (38 mm) |

² Use of snow chains not permitted. Observe the notes in the "Snow chains" section.

⁵ Only in conjunction with AMG Sports package code 951.

R 20

| Tires | Alloy wheels |
|---|--|
| FA: 245/40 R20 99 Y XL ^{3,4} RA: 275/35 R20 102 Y XL ^{2,3,4} | FA: 8.5 J x 20 H2 Wheel offset: 1.42 in (36 mm) RA: 9.5 J x 20 H2 Wheel offset: 1.71 in (43.5 mm) |
| FA: 245/40 R20 99 Y XL ^{3,4} RA: 275/35 R20 102 Y XL ^{2,3,4} | FA: 8.5 J x 20 H2 Wheel offset: 1.44 in (36.5 mm) RA: 9.5 J x 20 H2 Wheel offset: 1.73 in (44 mm) |
| FA: 245/40 R20 99 Y XL ^{3,5} RA: 275/35 R20 102 Y XL ^{2,3,5} | FA: 8.5 J x 20 H2 Wheel offset: 1.50 in (38 mm) RA: 9.5 J x 20 H2 Wheel offset: 1.50 in (38 mm) |

All-weather tires**R 18**

| Tires | Alloy wheels |
|---|--|
| BA: 245/50 R18 100 H M+S ^{3,4} | BA: 8.0 J x 18 H2 Wheel offset: 1.61 in (41 mm) |

R 19

| Tires | Alloy wheels |
|---|--|
| FA: 245/45 R19 102 H XL M+S ^{3,4} RA: 275/40 R19 101 H M+S ^{2,3,4} | FA: 8.5 J x 19 H2 Wheel offset: 1.42 in (36 mm) RA: 9.5 J x 19 H2 Wheel offset: 1.71 in (43.5 mm) |
| FA: 245/45 R19 102 H XL M+S ^{3,5} RA: 275/40 R19 101 H M+S ^{2,3,5} | FA: 8.5 J x 19 H2 Wheel offset: 1.50 in (38 mm) RA: 9.5 J x 19 H2 Wheel offset: 1.50 in (38 mm) |

³ Available as MOExtended tires

⁴ Not in conjunction with AMG Sports package code 951.

² Use of snow chains not permitted. Observe the notes in the "Snow chains" section.

⁵ Only in conjunction with AMG Sports package code 951.

Winter tires

R 18

| Tires | Alloy wheels |
|--|---|
| BA: 245/50 R18 104 V XL M+S  ³ | BA: 8.0J x 18 H2 Wheel offset: 1.61 in (41 mm) |

R 19

| Tires | Alloy wheels |
|--|--|
| BA: 245/45 R19 102 V XL M+S  ³ | BA: 8.5 J x 19 H2 Wheel offset: 1.42 in (36 mm) |
| BA: 245/45 R19 102 V XL M+S  ³ | BA: 8.5 J x 19 H2 Wheel offset: 1.50 in (38 mm) |

S 550

Summer tires

R 18

| Tires | Alloy wheels |
|----------------------|--|
| BA: 245/50 R18 100 W | BA: 8.0 J x 18 H2 Wheel offset: 1.61 in (41 mm) |

R 19

| Tires | Alloy wheels |
|--|--|
| FA: 245/45 R19 102 Y XL RA: 275/40 R19 101 Y ² | FA: 8.5 J x 19 H2 Wheel offset: 1.42 in (36 mm) RA: 9.5 J x 19 H2 Wheel offset: 1.71 in (43.5 mm) |

³ Available as MOExtended tires

² Use of snow chains not permitted. Observe the notes in the "Snow chains" section.

R 20

| Tires | Alloy wheels |
|---|--|
| FA: 245/40 R20 99 Y XL ^{3,4} RA: 275/35 R20 102 Y XL ^{2,3,4} | FA: 8.5 J x 20 H2 Wheel offset: 1.42 in (36 mm) RA: 9.5 J x 20 H2 Wheel offset: 1.71 in (43.5 mm) |
| FA: 245/40 R20 99 Y XL ^{3,4} RA: 275/35 R20 102 Y XL ^{2,3,4} | FA: 8.5 J x 20 H2 Wheel offset: 1.44 in (36.5 mm) RA: 9.5 J x 20 H2 Wheel offset: 1.73 in (44 mm) |
| FA: 245/40 R20 99 Y XL ^{3,5} RA: 275/35 R20 102 Y XL ^{2,3,5} | FA: 8.5 J x 20 H2 Wheel offset: 1.50 in (38 mm) RA: 9.5 J x 20 H2 Wheel offset: 1.50 in (38 mm) |

All-weather tires**R 18**

| Tires | Alloy wheels |
|---|--|
| BA: 245/50 R18 100 H M+S ^{3,4} | BA: 8.0 J x 18 H2 Wheel offset: 1.61 in (41 mm) |

R 19

| Tires | Alloy wheels |
|---|--|
| FA: 245/45 R19 102 H XL M+S ^{3,4} RA: 275/40 R19 101 H M+S ^{2,3,4} | FA: 8.5 J x 19 H2 Wheel offset: 1.42 in (36 mm) RA: 9.5 J x 19 H2 Wheel offset: 1.71 in (43.5 mm) |
| FA: 245/45 R19 102 H XL M+S ^{3,5} RA: 275/40 R19 101 H M+S ^{2,3,5} | FA: 8.5 J x 19 H2 Wheel offset: 1.50 in (38 mm) RA: 9.5 J x 19 H2 Wheel offset: 1.50 in (38 mm) |

³ Available as MOExtended tires

⁴ Not in conjunction with AMG Sports package code 951.

² Use of snow chains not permitted. Observe the notes in the "Snow chains" section.

⁵ Only in conjunction with AMG Sports package code 951.

Winter tires

R 18

| Tires | Alloy wheels |
|--|---|
| BA: 245/50 R18 104 V XL M+S  ³ | BA: 8.0J x 18 H2 Wheel offset: 1.61 in (41 mm) |

R 19

| Tires | Alloy wheels |
|--|--|
| BA: 245/45 R19 102 V XL M+S  ³ | BA: 8.5 J x 19 H2 Wheel offset: 1.42 in (36 mm) |
| BA: 245/45 R19 102 V XL M+S  ³ | BA: 8.5 J x 19 H2 Wheel offset: 1.50 in (38 mm) |

S 550 4MATIC

Summer tires

R 18

| Tires | Alloy wheels |
|----------------------|--|
| BA: 245/50 R18 100 W | BA: 8.0 J x 18 H2 Wheel offset: 1.61 in (41 mm) |

R 19

| Tires | Alloy wheels |
|--|--|
| FA: 245/45 R19 102 Y XL RA: 275/40 R19 101 Y ² | FA: 8.5 J x 19 H2 Wheel offset: 1.42 in (36 mm) RA: 9.5 J x 19 H2 Wheel offset: 1.71 in (43.5 mm) |
| FA: 245/45 R19 102 Y XL ⁵ RA: 275/40 R19 101 Y ^{2, 5} | FA: 8.5 J x 19 H2 Wheel offset: 1.50 in (38 mm) RA: 9.5 J x 19 H2 Wheel offset: 1.50 in (38 mm) |

³ Available as MOExtended tires

² Use of snow chains not permitted. Observe the notes in the "Snow chains" section.

⁵ Only in conjunction with AMG Sports package code 95 1.

R 20

| Tires | Alloy wheels |
|---|--|
| FA: 245/40 R20 99 Y XL ^{3,4} RA: 275/35 R20 102 Y XL ^{2,3,4} | FA: 8.5 J x 20 H2 Wheel offset: 1.42 in (36 mm) RA: 9.5 J x 20 H2 Wheel offset: 1.71 in (43.5 mm) |
| FA: 245/40 R20 99 Y XL ^{3,4} RA: 275/35 R20 102 Y XL ^{2,3,4} | FA: 8.5 J x 20 H2 Wheel offset: 1.44 in (36.5 mm) RA: 9.5 J x 20 H2 Wheel offset: 1.73 in (44 mm) |
| FA: 245/40 R20 99 Y XL ^{3,5} RA: 275/35 R20 102 Y XL ^{2,3,5} | FA: 8.5 J x 20 H2 Wheel offset: 1.50 in (38 mm) RA: 9.5 J x 20 H2 Wheel offset: 1.50 in (38 mm) |

All-weather tires

R 18

| Tires | Alloy wheels |
|---|--|
| BA: 245/50 R18 100 H M+S ^{3,4} | BA: 8.0 J x 18 H2 Wheel offset: 1.61 in (41 mm) |

R 19

| Tires | Alloy wheels |
|---|--|
| FA: 245/45 R19 102 H XL M+S ^{3,4} RA: 275/40 R19 101 H M+S ^{2,3,4} | FA: 8.5 J x 19 H2 Wheel offset: 1.42 in (36 mm) RA: 9.5 J x 19 H2 Wheel offset: 1.71 in (43.5 mm) |
| FA: 245/45 R19 102 H XL M+S ^{3,5} RA: 275/40 R19 101 H M+S ^{2,3,5} | FA: 8.5 J x 19 H2 Wheel offset: 1.50 in (38 mm) RA: 9.5 J x 19 H2 Wheel offset: 1.50 in (38 mm) |

³ Available as MOExtended tires

⁴ Not in conjunction with AMG Sports package code 951.

² Use of snow chains not permitted. Observe the notes in the "Snow chains" section.

⁵ Only in conjunction with AMG Sports package code 951.

Winter tires**R 18**

| Tires | Alloy wheels |
|--|---|
| BA: 245/50 R18 104 V XL M+S  ³ | BA: 8.0J x 18 H2 Wheel offset: 1.61 in (41 mm) |

R 19

| Tires | Alloy wheels |
|--|--|
| BA: 245/45 R19 102 V XL M+S  ³ | BA: 8.5 J x 19 H2 Wheel offset: 1.42 in (36 mm) |
| BA: 245/45 R19 102 V XL M+S  ³ | BA: 8.5 J x 19 H2 Wheel offset: 1.50 in (38 mm) |

S 550 PLUG-IN HYBRID**Summer tires****R 18**

| Tires | Alloy wheels |
|---|--|
| FA: 245/50 R18 100 W ³ RA: 275/45 R18 103 W ^{2, 3} | FA: 8.0 J x 18 H2 Wheel offset: 1.61 in (41 mm) RA: 9.5 J x 18 H2 Wheel offset: 1.71 in (43.5 mm) |

R 19

| Tires | Alloy wheels |
|--|--|
| FA: 245/45 R19 102 Y XL ³ RA: 275/40 R19 101 Y ^{2, 3} | FA: 8.5 J x 19 H2 Wheel offset: 1.42 in (36 mm) RA: 9.5 J x 19 H2 Wheel offset: 1.71 in (43.5 mm) |
| FA: 245/45 R19 102 Y XL ^{3, 5} RA: 275/40 R19 101 Y ^{2, 3, 5} | FA: 8.5 J x 19 H2 Wheel offset: 1.50 in (38 mm) RA: 9.5 J x 19 H2 Wheel offset: 1.50 in (38 mm) |

³ Available as MOExtended tires² Use of snow chains not permitted. Observe the notes in the "Snow chains" section.⁵ Only in conjunction with AMG Sports package code 95 1.

R 20

| Tires | Alloy wheels |
|---|--|
| FA: 245/40 R20 99 Y XL ³ RA: 275/35 R20 102 Y XL ^{2,3} | FA: 8.5 J x 20 H2 Wheel offset: 1.42 in (36 mm) RA: 9.5 J x 20 H2 Wheel offset: 1.71 in (43.5 mm) |
| FA: 245/40 R20 99 Y XL ³ RA: 275/35 R20 102 Y XL ^{2,3} | FA: 8.5 J x 20 H2 Wheel offset: 1.44 in (36.5 mm) RA: 9.5 J x 20 H2 Wheel offset: 1.73 in (44 mm) |
| FA: 245/40 R20 99 Y XL ^{3,5} RA: 275/35 R20 102 Y XL ^{2,3,5} | FA: 8.5 J x 20 H2 Wheel offset: 1.50 in (38 mm) RA: 9.5 J x 20 H2 Wheel offset: 1.50 in (38 mm) |

All-weather tires

R 19

| Tires | Alloy wheels |
|---|--|
| FA: 245/45 R19 102 H XL M+S ^{3,4} RA: 275/40 R19 101 H M+S ^{2,3,4} | FA: 8.5 J x 19 H2 Wheel offset: 1.42 in (36 mm) RA: 9.5 J x 19 H2 Wheel offset: 1.71 in (43.5 mm) |
| FA: 245/45 R19 102 H XL M+S ^{3,5} RA: 275/40 R19 101 H M+S ^{2,3,5} | FA: 8.5 J x 19 H2 Wheel offset: 1.50 in (38 mm) RA: 9.5 J x 19 H2 Wheel offset: 1.50 in (38 mm) |

Winter tires

R 18

| Tires | Alloy wheels |
|--|---|
| BA: 245/50 R18 104 V XL M+S  ³ | BA: 8.0J x 18 H2 Wheel offset: 1.61 in (41 mm) |

³ Available as MOExtended tires

² Use of snow chains not permitted. Observe the notes in the "Snow chains" section.

⁵ Only in conjunction with AMG Sports package code 951.

⁴ Not in conjunction with AMG Sports package code 951.

R 19

| Tires | Alloy wheels |
|--|--|
| BA: 245/45 R19 102 V XL M+S  ³ | BA: 8.5 J x 19 H2 Wheel offset: 1.42 in (36 mm) |
| BA: 245/45 R19 102 V XL M+S  ³ | BA: 8.5 J x 19 H2 Wheel offset: 1.50 in (38 mm) |

S 600**Summer tires****R 20**

| Tires | Alloy wheels |
|---|--|
| FA: 245/40 R20 99 Y XL ^{3,4} RA: 275/35 R20 102 Y XL ^{2,3,4} | FA: 8.5 J x 20 H2 Wheel offset: 1.42 in (36 mm) RA: 9.5 J x 20 H2 Wheel offset: 1.71 in (43.5 mm) |
| FA: 245/40 R20 99 Y XL ^{3,4} RA: 275/35 R20 102 Y XL ^{2,3,4} | FA: 8.5 J x 20 H2 Wheel offset: 1.44 in (36.5 mm) RA: 9.5 J x 20 H2 Wheel offset: 1.73 in (44 mm) |
| FA: 245/40 R20 99 Y XL ^{3,5} RA: 275/35 R20 102 Y XL ^{2,3,5} | FA: 8.5 J x 20 H2 Wheel offset: 1.50 in (38 mm) RA: 9.5 J x 20 H2 Wheel offset: 1.50 in (38 mm) |

³ Available as MOExtended tires⁴ Not in conjunction with AMG Sports package code 951.² Use of snow chains not permitted. Observe the notes in the "Snow chains" section.⁵ Only in conjunction with AMG Sports package code 951.

All-weather tires**R 19**

| Tires | Alloy wheels |
|--|--|
| FA: 245/45 R19 102 H XL M+S ^{3, 4} RA: 275/40 R19 101 H M+S ^{2, 3, 4} | FA: 8.5 J x 19 H2 Wheel offset: 1.42 in (36 mm) RA: 9.5 J x 19 H2 Wheel offset: 1.71 in (43.5 mm) |
| FA: 245/45 R19 102 H XL M+S ^{3, 5} RA: 275/40 R19 101 H M+S ^{2, 3, 5} | FA: 8.5 J x 19 H2 Wheel offset: 1.50 in (38 mm) RA: 9.5 J x 19 H2 Wheel offset: 1.50 in (38 mm) |

Winter tires**R 19**

| Tires | Alloy wheels |
|--|--|
| BA: 245/45 R19 102 V XL M+S  ³ | BA: 8.5 J x 19 H2 Wheel offset: 1.42 in (36 mm) |
| BA: 245/45 R19 102 V XL M+S  ³ | BA: 8.5 J x 19 H2 Wheel offset: 1.50 in (38 mm) |

S 600 MAYBACH**Summer tires****R 20**

| Tires | Alloy wheels |
|--|--|
| FA: 245/40 R20 99 Y XL ^{3, 4} RA: 275/35 R20 102 Y XL ^{2, 3, 4} | FA: 8.5 J x 20 H2 Wheel offset: 1.42 in (36 mm) RA: 9.5 J x 20 H2 Wheel offset: 1.71 in (43.5 mm) |
| FA: 245/40 R20 99 Y XL ^{3, 4} RA: 275/35 R20 102 Y XL ^{2, 3, 4} | FA: 8.5 J x 20 H2 Wheel offset: 1.44 in (36.5 mm) RA: 9.5 J x 20 H2 Wheel offset: 1.73 in (44 mm) |

³ Available as MOExtended tires⁴ Not in conjunction with AMG Sports package code 951.² Use of snow chains not permitted. Observe the notes in the "Snow chains" section.⁵ Only in conjunction with AMG Sports package code 951.

All-weather tires**R 19**

| Tires | Alloy wheels |
|---|--|
| FA: 245/45 R19 102 H XL M+S ^{3,4} RA: 275/40 R19 101 H M+S ^{2,3,4} | FA: 8.5 J x 19 H2 Wheel offset: 1.42 in (36 mm) RA: 9.5 J x 19 H2 Wheel offset: 1.71 in (43.5 mm) |

Winter tires**R 19**

| Tires | Alloy wheels |
|--|--|
| BA: 245/45 R19 102 V XL M+S  ³ | BA: 8.5 J x 19 H2 Wheel offset: 1.42 in (36 mm) |
| BA: 245/45 R19 102 V XL M+S  ³ | BA: 8.5 J x 19 H2 Wheel offset: 1.50 in (38 mm) |

S 63 AMG 4MATIC**Summer tires****R 19**

| Tires | Alloy wheels |
|--|--|
| FA: 255/45 ZR19 (104 Y) XL ⁶ RA: 285/40 ZR19 (107 Y) XL ^{2,6} | FA: 8.5 J x 19 H2 Wheel offset: 1.50 in (38 mm) RA: 9.5 J x 19 H2 Wheel offset: 1.50 in (38 mm) |
| FA: 255/45 ZR19 (104 Y) XL ⁶ RA: 285/40 ZR19 (107 Y) XL ^{2,6} | FA: 8.5 J x 19 H2 Wheel offset: 1.54 in (39 mm) RA: 9.5 J x 19 H2 Wheel offset: 1.54 in (39 mm) |

³ Available as MOExtended tires⁴ Not in conjunction with AMG Sports package code 951.² Use of snow chains not permitted. Observe the notes in the "Snow chains" section.⁶ Not in combination with a ceramic brake system.

R 20







| Tires | Alloy wheels |
|--|--|
| FA: 255/40 ZR20 (101 Y) XL ⁷ RA: 285/35 ZR20 (104 Y) XL ^{2,7} | FA: 8.5 J x 20 H2 Wheel offset: 1.50 in (38 mm) RA: 9.5 J x 20 H2 Wheel offset: 1.50 in (38 mm) |
| FA: 255/40 ZR20 (101 Y) XL ⁷ RA: 285/35 ZR20 (104 Y) XL ^{2,7} | FA: 8.5 J x 20 H2 Wheel offset: 1.54 in (39 mm) RA: 9.5 J x 20 H2 Wheel offset: 1.54 in (39 mm) |

Winter tires

R 19

| Tires | Alloy wheels |
|--|--|
| BA: 255/45 R19 104 V XL M+S  ⁶ | BA: 8.5 J x 19 H2 Wheel offset: 1.50 in (38 mm) |
| BA: 255/45 R19 104 V XL M+S  ⁶ | BA: 8.5 J x 19 H2 Wheel offset: 1.54 in (39 mm) |

R 20

| Tires | Alloy wheels |
|--|--|
| BA: 255/40 R20 101 V XL M+S  ⁷ | BA: 8.5 J x 20 H2 Wheel offset: 1.50 in (38 mm) |
| BA: 255/40 R20 101 V XL M+S  ⁷ | BA: 8.5 J x 20 H2 Wheel offset: 1.54 in (39 mm) |
| FA: 255/40 R20 101 V XL M+S  ⁷ RA: 285/35 R20 104 V XL M+S  ^{2,7} | FA: 8.5 J x 20 H2 Wheel offset: 1.50 in (38 mm) RA: 9.5 J x 20 H2 Wheel offset: 1.50 in (38 mm) |
| FA: 255/40 R20 101 V XL M+S  ⁷ RA: 285/35 R20 104 V XL M+S  ^{2,7} | FA: 8.5 J x 20 H2 Wheel offset: 1.54 in (39 mm) RA: 9.5 J x 20 H2 Wheel offset: 1.54 in (39 mm) |

⁷ Observe the notes on "Large wheels" under "General notes" in "Wheel/tire combinations".







² Use of snow chains not permitted. Observe the notes in the "Snow chains" section.

⁶ Not in combination with a ceramic brake system.

S 65 AMG**Summer tires****R 20**

| Tires | Alloy wheels |
|--|--|
| FA: 255/40 ZR20 (101 Y) XL ⁷ RA: 285/35 ZR20 (104 Y) XL ^{2,7} | FA: 8.5 J x 20 H2 Wheel offset: 1.50 in (38 mm) RA: 9.5 J x 20 H2 Wheel offset: 1.50 in (38 mm) |
| FA: 255/40 ZR20 (101 Y) XL ⁷ RA: 285/35 ZR20 (104 Y) XL ^{2,7} | FA: 8.5 J x 20 H2 Wheel offset: 1.54 in (39 mm) RA: 9.5 J x 20 H2 Wheel offset: 1.54 in (39 mm) |

Winter tires**R 20**

| Tires | Alloy wheels |
|--|--|
| BA: 255/40 R20 101 V XL M+S  ⁷ | BA: 8.5 J x 20 H2 Wheel offset: 1.50 in (38 mm) |
| BA: 255/40 R20 101 V XL M+S  ⁷ | BA: 8.5 J x 20 H2 Wheel offset: 1.54 in (39 mm) |
| FA: 255/40 R20 101 V XL M+S  ⁷ RA: 285/35 R20 104 V XL M+S  ^{2,7} | FA: 8.5 J x 20 H2 Wheel offset: 1.50 in (38 mm) RA: 9.5 J x 20 H2 Wheel offset: 1.50 in (38 mm) |
| FA: 255/40 R20 101 V XL M+S  ⁷ RA: 285/35 R20 104 V XL M+S  ^{2,7} | FA: 8.5 J x 20 H2 Wheel offset: 1.54 in (39 mm) RA: 9.5 J x 20 H2 Wheel offset: 1.54 in (39 mm) |

⁷ Observe the notes on "Large wheels" under "General notes" in "Wheel/tire combinations".

² Use of snow chains not permitted. Observe the notes in the "Snow chains" section.

| | |
|--|------------|
| Useful information | 320 |
| Information regarding technical data | 320 |
| Identification plates | 320 |
| Service products and filling capacities | 321 |
| Vehicle data | 327 |

Useful information

- i** This Operator's Manual describes all models and all standard and optional equipment of your vehicle available at the time of publication of the Operator's Manual. Country-specific differences are possible. Please note that your vehicle may not be equipped with all features described. This also applies to safety-related systems and functions.
- i** Read the information on qualified specialist workshops (► page 30).

Information regarding technical data

- i** The data stated here specifically refers to a vehicle with standard equipment. Consult an authorized Mercedes-Benz Center for the data for all vehicle variants and trim levels.

Technical data

Identification plates

Vehicle identification plate with vehicle identification number (VIN)



P00.10-5212-31

- Open the driver's door.
You will see vehicle identification plate ①.

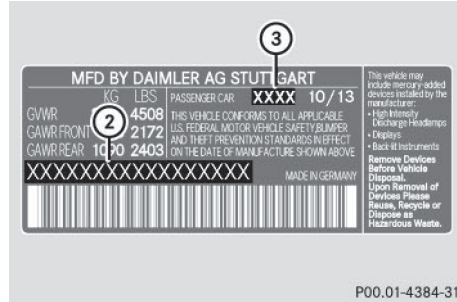

P00.01-4384-31

Example: vehicle identification plate (USA only)

- ② VIN
③ Vehicle model

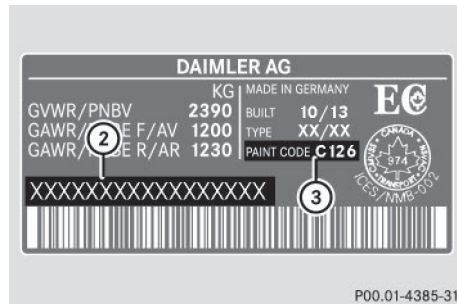

P00.01-4385-31

Example: vehicle identification plate (Canada only)

- ② VIN
③ Paint code

- i** The data shown on the vehicle identification plate is used only as an example. This data is different for every vehicle and can deviate from the data shown here. You can find the data applicable to your vehicle on the vehicle identification plate.

Vehicle identification plate with vehicle identification number (VIN)

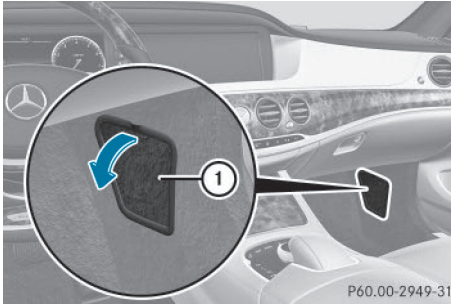

- ▶ Open the front right-hand door.
- ▶ Fold cover ① down and remove it. You will see the VIN.

The VIN can also be found in the following locations:

- on the lower edge of the windshield (▷ page 321)
- on the vehicle identification plate (▷ page 320)

Engine number

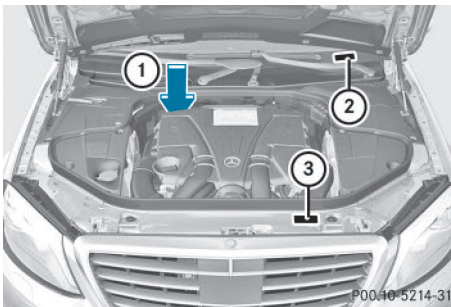

- ① Engine number (stamped into the crankcase)
- ② VIN (on the lower edge of the windshield)
- ③ Emission control information plate, including the certification of both federal and Californian emissions standards

Service products and filling capacities

Important safety notes

⚠ WARNING

Service products may be poisonous and hazardous to health. There is a risk of injury.

Comply with instructions on the use, storage and disposal of service products on the labels of the respective original containers. Always store service products sealed in their original containers. Always keep service products out of the reach of children.

♻ Environmental note

Dispose of service products in an environmentally responsible manner.

Service products include the following:

- Fuels
- Lubricants (e.g. engine oil, transmission oil)
- Coolant
- Brake fluid
- Windshield washer fluid
- Climate control system refrigerant

Components and service products must be matched. Only use products recommended by Mercedes-Benz. Damage which is caused by the use of products which have not been recommended is not covered by the Mercedes-Benz warranty or goodwill gestures. They are listed in this Mercedes-Benz Operator's Manual in the appropriate section. Information on tested and approved products can be obtained at an authorized Mercedes-Benz Center or on the Internet at <http://bevo.mercedes-benz.com>.

You can recognize service products approved by Mercedes-Benz by the following inscription on the containers:

- MB-Freigabe (e.g. MB-Freigabe 229.51)
- MB Approval (e.g. MB Approval 229.51)

Other designations or recommendations indicate a level of quality or a specification in

accordance with an MB Sheet Number (e.g. MB 229.5). They have not necessarily been approved by Mercedes-Benz.

Other identifications, for example:

- 0 W-30
- 5 W-30
- 5 W-40

Fuel

Important safety notes

WARNING

Fuel is highly flammable. If you handle fuel incorrectly, there is a risk of fire and explosion.

You must avoid fire, open flames, creating sparks and smoking. Switch off the engine and, if applicable, the auxiliary heating before refueling.

WARNING

Fuel is poisonous and hazardous to health. There is a risk of injury.

You must make sure that fuel does not come into contact with your skin, eyes or clothing and that it is not swallowed. Do not inhale fuel vapors. Keep fuel away from children.

If you or others come into contact with fuel, observe the following:

- Wash away fuel from skin immediately using soap and water.
- If fuel comes into contact with your eyes, immediately rinse them thoroughly with clean water. Seek medical assistance without delay.
- If fuel is swallowed, seek medical assistance without delay. Do not induce vomiting.
- Immediately change out of clothing which has come into contact with fuel.

Tank capacity

| Model | Total capacity |
|--------------------------------|-------------------------|
| Plug-in hybrid vehicles | 16.6 US gal (63.0 l) |
| All other models | 21.1 US gal (80.0 l) |

| Model | Of which reserve |
|-------------------------|-----------------------------------|
| AMG vehicles | Approx. 3.2 US gal (12.0 l) |
| All other models | Approx. 2.1 US gal (8.0 l) |

Gasoline

Fuel grade

 Do not use diesel to refuel vehicles with a gasoline engine. Do not switch on the ignition if you accidentally refuel with the wrong fuel. Otherwise, the fuel will enter the fuel system. Even small amounts of the wrong fuel could result in damage to the fuel system and the engine. Notify a qualified specialist workshop and have the fuel tank and fuel lines drained completely.

 Only refuel using unleaded premium grade gasoline with at least 91 AKI/95 RON.

 Only use the fuel recommended. Operating the vehicle with other fuels can lead to engine failure.

 Do not use the following:

- E85 (gasoline with 85% ethanol)
- E100 (100% ethanol)
- M15 (gasoline with 15% methanol)
- M30 (gasoline with 30% methanol)
- M85 (gasoline with 85% methanol)
- M100 (100% methanol)

- Gasoline with metalliferous additives
- Diesel

Do not mix such fuels with the fuel recommended for your vehicle. Do not use additives. Otherwise, engine damage may occur. This does not include cleaning additives for the removal and prevention of residue build-up. Gasoline may only be mixed with cleaning additives recommended by Mercedes-Benz; see "Additives". You can obtain further information from any authorized Mercedes-Benz Center.

! To ensure the longevity and full performance of the engine, only premium-grade unleaded gasoline must be used.

If standard unleaded gasoline is unavailable and you have to refuel with unleaded gasoline of a lower grade, observe the following precautions:

- Only fill the fuel tank to half full with regular unleaded gasoline and fill the rest with premium-grade unleaded gasoline as soon as possible.
- Do not drive at the maximum speed.
- Avoid sudden acceleration and engine speeds over 3,000 rpm.

You will usually find information about the fuel grade on the pump. If you cannot find the label on the pump, ask the staff for assistance.

- i** For further information, consult a qualified specialist workshop or visit <http://www.mbusa.com> (USA only).
- i** E10 fuel contains up to 10% bioethanol. Your vehicle is E10-compatible. You can refuel your vehicle using E10 fuel.

As a temporary measure, if the recommended fuel is not available, you may also use regular unleaded gasoline with an octane rating of 87 AKI/91 RON. This may reduce engine performance and increase fuel consumption. Avoid driving at full throttle and sudden acceleration. Never refuel using fuel with a lower AKI.

Information on refueling (▷ page 141).

Additives

! Operating the engine with fuel additives added later can lead to engine failure. Do not mix fuel additives with fuel. This does not include additives for the removal and prevention of residue buildup. Gasoline must only be mixed with additives recommended by Mercedes-Benz. Comply with the instructions for use on the product label. More information about recommended additives can be obtained from any authorized Mercedes-Benz Center.

Mercedes-Benz recommends that you use branded fuels that have additives.

The quality of the fuel available in some countries may not be sufficient. Residue could build up in the injection system as a result. In such cases, and in consultation with an authorized Mercedes-Benz Center, the gasoline may be mixed with the cleaning additive recommended by Mercedes-Benz. You must observe the notes and mixing ratios specified on the container.

Engine oil

General notes

! Never use engine oil or an oil filter of a specification other than is necessary to fulfill the prescribed service intervals. Do not change the engine oil or oil filter in order to achieve longer replacement intervals than those prescribed. You could otherwise cause engine damage or damage to the exhaust gas aftertreatment.

Follow the instructions in the service interval display regarding the oil change. Otherwise, you may damage the engine and the exhaust gas aftertreatment.

When handling engine oil, observe the important safety notes on service products (▷ page 321).

The engine oils are matched to the performance of Mercedes-Benz engines and service intervals. You should therefore only use engine oils and oil filters that are approved for vehicles with maintenance systems.

For a list of approved engine oils and oil filters, consult an authorized Mercedes-Benz Center. Or visit the website <http://bevo.mercedes-benz.com>.

The table shows which engine oils have been approved for your vehicle.

| Model | Engine model | MB Approval |
|--|--------------|-------------|
| S 400 4MATIC S 550 PLUG-IN HYBRID | 276 | 229.5 |
| AMG vehicles | 157 279 | 229.5 |
| All other models | 277 278 | 229.5 |

i MB approval is indicated on the oil containers.

Filling capacities

The following values refer to an oil change including the oil filter.

| Model | Capacity |
|--|---------------------|
| S 400 4MATIC S 550 PLUG-IN HYBRID | 6.9 US qt (6.5 l) |
| S 600 S 600 MAYBACH | 11.1 US qt (10.5 l) |
| S 65 AMG | 11.1 US qt (10.5 l) |
| All other AMG vehicles | 9.0 US qt (8.5 l) |
| All other models | 8.5 US qt (8.0 l) |

Additives

! Do not use any additives in the engine oil. This could damage the engine.

Engine oil viscosity

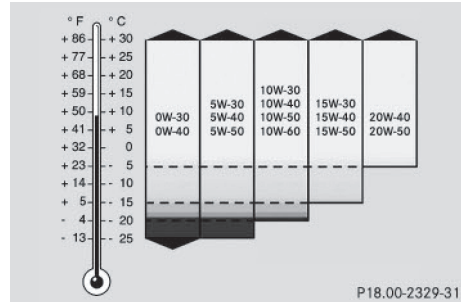

Viscosity describes the flow characteristics of a fluid. If an engine oil has a high viscosity, this means that it is thick; a low viscosity means that it is thin.

Select an engine oil with an SAE classification (viscosity) suitable for the prevailing outside temperatures. The table shows you which SAE classifications are to be used. The low-temperature characteristics of engine oils can deteriorate significantly, e.g. as a result of aging, soot and fuel deposits. It is therefore strongly recommended that you carry out regular oil changes using an approved engine oil with the appropriate SAE classification.

Brake fluid

! WARNING

The brake fluid constantly absorbs moisture from the air. This lowers the boiling point of the brake fluid. If the boiling point of the brake fluid is too low, vapor pockets may form in the brake system when the brakes are applied hard. This would impair braking efficiency. There is a risk of an accident.

You should have the brake fluid renewed at the specified intervals.

Comply with the important safety notes for service products when handling brake fluid (▷ page 321).

The brake fluid change intervals can be found in the Maintenance Booklet.

Only use brake fluid approved by Mercedes-Benz according to MB Approval 33 1.0.

Information about approved brake fluid can be obtained at any qualified specialist workshop or on the Internet at <http://bevo.mercedes-benz.com>.

- i** Have the brake fluid regularly replaced at a qualified specialist workshop and the replacement confirmed in the Maintenance Booklet.

Coolant

Important safety notes

WARNING

If antifreeze comes into contact with hot components in the engine compartment, it may ignite. There is a risk of fire and injury.

Let the engine cool down before you add antifreeze. Make sure that antifreeze is not spilled next to the filler neck. Thoroughly clean the antifreeze from components before starting the engine.

- !** Only add coolant that has been premixed with the desired antifreeze protection. You could otherwise damage the engine. Further information on coolants can be found in the Mercedes-Benz Specifications for Service Products, MB BeVo 310.1, e.g. on the Internet at <http://bevo.mercedes-benz.com>. Or contact a qualified specialist workshop.
- !** Always use a suitable coolant mixture, even in countries where high temperatures prevail. Otherwise, the engine cooling system is not sufficiently protected from corrosion and overheating.

- i** Have the coolant regularly replaced at a qualified specialist workshop and the replacement confirmed in the Maintenance Booklet.

The coolant is a mixture of water and anti-freeze/corrosion inhibitor. It performs the following tasks:

- corrosion protection
- antifreeze protection
- raising the boiling point

If the coolant has antifreeze protection down to -35 °F (-37 °C), the boiling point of the coolant during operation is approximately 266 °F (130 °C).

The antifreeze/corrosion inhibitor concentration in the engine cooling system should:

- be at least 50%. This will protect the engine cooling system against freezing down to approximately -35 °F (-37 °C).
- not exceed 55% (antifreeze protection down to -49 °F [-45 °C]). Otherwise, heat will not be dissipated as effectively.

Mercedes-Benz recommends an antifreeze/corrosion inhibitor concentrate in accordance with

MB Specifications for Service Products 310.1

- i** When the vehicle is first delivered, it is filled with a coolant mixture that ensures adequate antifreeze and corrosion protection.
- i** The coolant is checked with every maintenance interval at a qualified specialist workshop.

Filling capacities

Missing values were not available at time of going to print.

| Model | Capacity |
|---------------|---------------------|
| S 400 4MATIC | 13.0 US qt (12.3 l) |
| S 600 | 15.7 US qt (14.9 l) |
| S 600 MAYBACH | |

| Model | Capacity |
|-----------------------------|---------------------|
| S 63 AMG 4MATIC | 8.5 US qt (8.0 l) |
| S 65 AMG | 11.3 US qt (10.7 l) |
| S 550 PLUG-IN HYBRID | 13.3 US qt (12.6 l) |
| All other models | 12.8 US qt (12.1 l) |

Windshield washer system

Important safety notes

WARNING

Windshield washer concentrate could ignite if it comes into contact with hot engine components or the exhaust system. There is a risk of fire and injury.

Make sure that no windshield washer concentrate is spilled next to the filler neck.

! Do not add distilled or de-ionized water to the washer fluid container. Otherwise, the level sensor may be damaged.

! Only MB SummerFit and MB WinterFit washer fluid should be mixed together. The spray nozzles may otherwise become blocked.

At temperatures above freezing:

► Fill the washer fluid reservoir with a mixture of water and windshield washer fluid, e.g. MB SummerFit.

Add 1 part MB SummerFit to 100 parts water.

At temperatures below freezing:

► Fill the washer fluid reservoir with a mixture of water and washer fluid, e.g. MB WinterFit.

For the correct mixing ratio refer to the information on the antifreeze reservoir.

i Add windshield washer fluid, e.g. MB SummerFit or MB WinterFit, to the washer fluid all year round.

Climate control system refrigerant

Important safety notes

The climate control system of your vehicle is filled with refrigerant R-134a.

The instruction label regarding the refrigerant type used can be found on the radiator cross member.

! Only the refrigerant R-134a and the PAG oil approved by Mercedes-Benz may be used. The approved PAG oil may not be mixed with any other PAG oil that is not approved for R-134a refrigerant. Otherwise, the climate control system may be damaged.

Service work, such as topping up refrigerant or replacing components, may only be carried out by a qualified specialist workshop. All applicable regulations must be adhered to, SAE standard J639 included.

Always have work on the climate control system carried out at a qualified specialist workshop.

Refrigerant instruction label

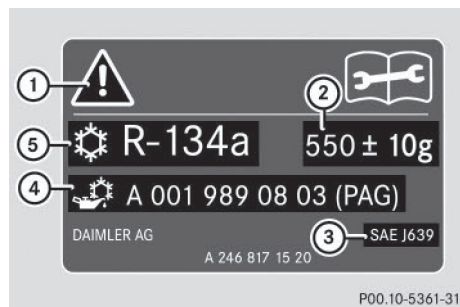

Example: refrigerant instruction label

- ① Warning symbol
- ② Refrigerant filling capacity
- ③ Applicable SAE standards
- ④ PAG oil part number
- ⑤ Type of refrigerant

Warning symbols ① indicate:

- possible dangers
- having service work carried out at a qualified specialist workshop

Filling capacities

Missing values were not available at time of going to print.

| Model | Refrigerant |
|----------------------|-------------------------------|
| S 550 PLUG-IN HYBRID | 25.0 ± 0.4 oz (710 ± 10 g) |
| S 63 AMG 4MATIC | |

| Model | PAG oil |
|----------------------|-------------------|
| S 550 PLUG-IN HYBRID | 4.3 oz (120 g) |
| S 63 AMG 4MATIC | |

| Vehicles without rear-compartment air-conditioning system | Capacity |
|---|-------------------------------|
| Refrigerant | 23.3 ± 0.4 oz (660 ± 10 g) |
| PAG oil | 3.9 oz (110 g) |

| Vehicles with rear-compartment air-conditioning system | Capacity |
|--|-------------------------------|
| Refrigerant | 27.1 ± 0.4 oz (770 ± 10 g) |
| PAG oil | 4.2 oz (120 g) |

Vehicle data

General notes

Please note that for the specified vehicle data:

- the heights specified may vary as a result of:
 - tires
 - load
 - condition of the suspension
 - optional equipment
- optional equipment reduces the maximum payload.

Dimensions and weights

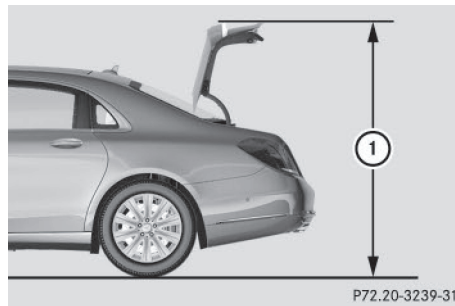

Trunk lid opening dimensions (example: S-Class MAYBACH)

Missing values were not available at time of going to print.

| Model | ① Opening height |
|----------------------|----------------------|
| S 550 PLUG-IN HYBRID | |
| S 600 | 71.1 in (1806 mm) |
| S 600 MAYBACH | |
| AMG vehicles | 71.2 in (1808 mm) |
| All other models | 71.0 in (1803 mm) |

S-Class with a short wheelbase**All models**

| | |
|-----------------------|--------------------|
| Vehicle length | 201.4 in (5116 mm) |
|-----------------------|--------------------|

| | |
|---|-------------------|
| Vehicle width including exterior mirrors | 83.9 in (2130 mm) |
|---|-------------------|

| | |
|-----------------------|-------------------|
| Vehicle height | 58.9 in (1496 mm) |
|-----------------------|-------------------|

| | |
|------------------|--------------------|
| Wheelbase | 119.5 in (3035 mm) |
|------------------|--------------------|

| | |
|-----------------------|-------------------|
| Turning radius | 39.0 ft (11.90 m) |
|-----------------------|-------------------|

| | |
|--------------------------|-----------------|
| Maximum roof load | 220 lb (100 kg) |
|--------------------------|-----------------|

| | |
|---------------------------|-----------------|
| Maximum trunk load | 220 lb (100 kg) |
|---------------------------|-----------------|

S-Class with a long wheelbase

Missing values were not available at time of going to print.

AMG vehicles

| | |
|-----------------------|--------------------|
| Vehicle length | 208.1 in (5287 mm) |
|-----------------------|--------------------|

| | |
|-----------------------|-------------------|
| Vehicle height | 59.0 in (1499 mm) |
|-----------------------|-------------------|

| | |
|---|-------------------|
| Vehicle width including exterior mirrors | 83.9 in (2130 mm) |
|---|-------------------|

| | |
|------------------|--------------------|
| Wheelbase | 124.6 in (3165 mm) |
|------------------|--------------------|

| | |
|--------------------------|-----------------|
| Maximum roof load | 220 lb (100 kg) |
|--------------------------|-----------------|

| Model (AMG vehicles) | Maximum trunk load |
|----------------------|--------------------|
|----------------------|--------------------|

| | |
|-----------------|--|
| S 65 AMG | |
|-----------------|--|

| | |
|-------------------------|--------|
| All other models | 100 kg |
|-------------------------|--------|

| Model (AMG vehicles) | Turning radius |
|----------------------|----------------|
|----------------------|----------------|

| | |
|------------------------|-------------------|
| S 63 AMG 4MATIC | 41.0 ft (12.50 m) |
|------------------------|-------------------|

| | |
|-----------------|-------------------|
| S 65 AMG | 40.4 ft (12.30 m) |
|-----------------|-------------------|

All other models

| | |
|-----------------------|--------------------|
| Vehicle length | 206.5 in (5246 mm) |
|-----------------------|--------------------|

| | |
|---|-------------------|
| Vehicle width including exterior mirrors | 83.9 in (2130 mm) |
|---|-------------------|

| | |
|------------------|--------------------|
| Wheelbase | 124.6 in (3165 mm) |
|------------------|--------------------|

| | |
|-----------------------|-------------------|
| Turning radius | 40.4 ft (12.30 m) |
|-----------------------|-------------------|

| | |
|--------------------------|-----------------|
| Maximum roof load | 220 lb (100 kg) |
|--------------------------|-----------------|

| | |
|---------------------------|-----------------|
| Maximum trunk load | 220 lb (100 kg) |
|---------------------------|-----------------|

| Model | Vehicle height |
|-------|----------------|
|-------|----------------|

| | |
|-----------------------------|--|
| S 550 PLUG-IN HYBRID | |
|-----------------------------|--|

| | |
|-------------------------------|-------------------|
| S 550 S 550 4MATIC | 58.8 in (1494 mm) |
|-------------------------------|-------------------|

| | |
|--------------|-------------------|
| S 600 | 58.9 in (1497 mm) |
|--------------|-------------------|

High-voltage battery (S 550 L PLUG-IN HYBRID)

| | |
|--------------|-------------|
| Model | Lithium-ion |
|--------------|-------------|

| | |
|-----------------------|---------|
| Energy content | 8.7 kWh |
|-----------------------|---------|

| | |
|-------------------------|-------|
| Nominal capacity | 22 Ah |
|-------------------------|-------|

| | |
|--|--|
| Range in electric-only mode (according to NEDC) | |
|--|--|

**High-voltage battery
(S 550 L PLUG-IN HYBRID)**

| | |
|--|-------------|
| Charging time at 16 A (using a charging station or wallbox) | Approx. 2 h |
| Charging time at 8 A (using a mains socket) | |

S-Class MAYBACH**All models**

| | |
|---|--------------------|
| Vehicle length | 214.7 in (5453 mm) |
| Vehicle height | 59.0 in (1498 mm) |
| Vehicle width including exterior mirrors | 83.9 in (2130 mm) |
| Wheelbase | 132.5 in (3365 mm) |
| Turning radius | 42.3 ft (12.90 m) |
| Maximum roof load | 220 lb (100 kg) |
| Maximum trunk load | 220 lb (100 kg) |

