



SL

Operator's Manual



Mercedes-Benz

Symbols



Registered trademarks:





- Bluetooth® is a registered trademark of Bluetooth SIG Inc.
- DTS is a registered trademark of DTS, Inc.
- Dolby and MLP are registered trademarks of DOLBY Laboratories.
- BabySmart™, ESP® and PRE-SAFE® are registered trademarks of Daimler AG.
- HomeLink® is a registered trademark of Prince.
- iPod® and iTunes® are registered trademarks of Apple Inc.
- Logic 7® is a registered trademark of Harman International Industries.
- Microsoft® and Windows media® are registered trademarks of Microsoft Corporation.
- SIRIUS is a registered trademark of Sirius XM radio Inc.
- HD Radio is a registered trademark of iBiquity Digital Corporation.
- Gracenote® is a registered trademark of Gracenote, Inc.
- ZAGATSurvey® and related brands are registered trademarks of ZagatSurvey, LLC.

In this Operator's Manual, you will find the following symbols:

WARNING

Warning notes draw your attention to hazards that endanger your health or life, or the health or life of others.

-  Notes on material damage alert you to dangers that could lead to damage to your vehicle.
-  This symbol indicates useful instructions or further information that could be helpful to you.

-  This symbol designates an instruction you must follow.
-  Several consecutive symbols indicate an instruction with several steps.
-  This symbol tells you where you can find further information on a topic.
-  This symbol indicates a warning or an instruction that is continued on the next page.
- Display** This font indicates a display message in the multifunction display/COMAND display.

Welcome to the world of Mercedes-Benz

Before you first drive off, read this Operator's Manual carefully and familiarize yourself with your vehicle. For your own safety and a longer vehicle life, follow the instructions and warning notices in this manual. Disregarding them may lead to damage to the vehicle or personal injury.

Vehicle damage resulting from the disregard of the instructions is not covered by the Mercedes-Benz Limited Warranty.

The equipment or model designation of your vehicle may differ according to:

- model
- order
- country variant
- availability

Mercedes-Benz therefore reserves the right to introduce changes in the following areas:

- design
- equipment
- technical features

Therefore, descriptions may vary from those of your own vehicle.

The following are integral components of the vehicle:

- Operator's Manual
- Maintenance Booklet
- Equipment-dependent supplements

Keep printed copies of the documents in the vehicle at all times. If you sell the vehicle, always pass the documents on to the new owner.

The technical documentation team at Daimler AG wishes you safe and pleasant motoring.

Mercedes-Benz USA, LLC

Mercedes-Benz Canada, Inc.

A Daimler Company

Index	4	Safety	35
Introduction	28	Opening/closing	67
		Seats, steering wheel and mirrors	95
		Lights and windshield wipers	107
		Climate control	121
		Driving and parking	133
		On-board computer and displays	203
		COMAND	267
		Stowage and features	473
		Maintenance and care	495
		Roadside Assistance	507
		Wheels and tires	525
		Technical data	557

- 1, 2, 3 ...
- 12 V socket**
see Sockets
- 911 emergency call** 358
- A**
- ABS (Anti-lock Braking System)**
Display message 224
Function/notes 57
Important safety notes 57
Warning lamp 257
- Activating/deactivating cooling with air dehumidification** 125
- Active Blind Spot Assist**
Activating/deactivating (on-board computer) 215
Display message 243
Function/information 196
- Active Body Control (AMG vehicles)**
Display message 241
Driving conditions menu in the COMAND display (AMG vehicles) ... 183
Function/notes 181
- Active Body Control (except AMG vehicles)**
Display message 241
Driving conditions menu in the COMAND display 180
Function/notes 179
- Active Driving Assistance package** . 195
- Active Lane Keeping Assist**
Activating/deactivating (on-board computer) 215
Display message 243
Function/information 199
- Active light function** 113
- Active multicontour seat** 286
- Active Parking Assist**
Display message 244
Important safety notes 186
- Active partition (USB devices only)**
Selecting 430
- ADAPTIVE BRAKE** 63
- Adaptive Damping System**
Function/notes 178
- Adaptive Highbeam Assist**
Display message 238
Function/notes 114
Switching on/off (on-board computer) 217
- Additives (engine oil)** 563
- Address book**
Browsing 378
Calling up 378
Changing an entry 380
Connecting a call 381
Creating an entry 379
Deleting an entry 379
Deleting contacts 384
Details about an entry 380
Entering characters 281
Entry as a home address 338
Importing contacts 383
Introduction 378
Receiving vCards 384
Searching for an entry 379
Starting route guidance 381
Voice tag 382
- Address entry menu** 299
- Adjusting the sound settings**
Balance 278
- Adjusting the vehicle height**
Active Body Control (AMG vehicles) 181
Active Body Control (except AMG vehicles) 179
- Air bags**
Display message 234
Front air bag (driver, front passenger) 40
Head bag 42
Important safety notes 38
Knee bag 41
PASSENGER AIR BAG OFF indicator lamp 43
Safety guidelines 38
Side impact air bag 41
- Air-conditioning system**
see Climate control
- AIR FLOW** 126
- Air pressure**
see Tire pressure

- AIRSCARF**
 - Setting the vents 132
 - Switching on/off 101
- Air vents**
 - Glove box 131
 - Important safety notes 131
 - Setting 131
 - Setting the AIRSCARF vents 132
 - Setting the center air vents 131
 - Setting the side air vents 131
 - Switching AIRSCARF on/off 101
- Alarm system**
 - see ATA (Anti-Theft Alarm system)
- Alternative route** 327
- Ambient lighting**
 - Setting the brightness (on-board computer) 216
 - Setting the color (on-board computer) 217
- AMG**
 - Button for AMG menu 148
 - SETUP 148
- AMG menu (on-board computer)** 220
- Anti-lock Braking System**
 - see ABS (Anti-lock Braking System)
- Anti-Theft Alarm system**
 - see ATA (Anti-Theft Alarm system)
- Ashtray** 480
- Assistance menu (on-board computer)** 214
- ASSYST PLUS**
 - Notes 500
- ATA (Anti-Theft Alarm system)**
 - Activating/deactivating 65
 - Function 65
 - Switching off the alarm 65
- ATTENTION ASSIST**
 - Activating/deactivating 214
 - Display message 242
 - Function/notes 194
- Audio**
 - Radio mode 411
- Audio DVD**
 - Mode, switching to 424
 - Pause function 426
 - Playback options 430
 - Safety notes 421
 - Setting the audio format 430
 - Stop function 426
- Audio format, setting**
 - Audio DVD 430
 - Video DVD 458
- Audio menu (on-board computer)** 211
- Authorized Mercedes-Benz Center**
 - see Qualified specialist workshop
- Authorized workshop**
 - see Qualified specialist workshop
- AUTO lights**
 - Display message 238
 - see Lights
- Automatic engine start (ECO start/stop function)** 140
- Automatic engine switch-off (ECO start/stop function)** 140
- Automatic headlamp mode** 110
- Automatic transmission**
 - Accelerator pedal position 146
 - Automatic drive program 149
 - Changing gear 146
 - Display message 250
 - Driving tips 146
 - Emergency running mode 152
 - Engaging the park position 144
 - Kickdown 147
 - Manual drive program 150
 - Overview 143
 - Problem (malfunction) 152
 - Program selector button 147
 - Pulling away 138
 - Selector lever 143
 - Shift ranges 149
 - Starting the engine 137
 - Steering wheel paddle shifters 148
 - Transmission position display 145
 - Transmission positions 146
- Automatic transmission emergency mode** 152
- Autostore** 414
- AUX (audio)**
 - Notes/socket 451
 - Switching to 451
- AUX (video)**
 - Setting the volume and sound 459
 - Showing/hiding the menu 459
 - Switching to 459

- Avoiding an area** 349
- B**
- Back button** 274
- Back support**
see Lumbar support
- Balance, adjusting** 278
- BAS (Brake Assist System)** 58
- Basic settings**
see Settings
- BAS PLUS (Brake Assist System PLUS)** 58
- Bass, setting** 278
- Battery (SmartKey)**
Checking 71
Important safety notes 71
Replacing 71
- Battery (vehicle)**
Charging 515
Display message 240
Important safety notes 513
Jump starting 516
Overview 513
- Belt**
see Seat belts
- Bird's-eye view (navigation)** 344
- Blind Spot Assist**
see Active Blind Spot Assist
- Bluetooth®**
Activating/deactivating 292
Activating audio mode 443
Conditions (telephone) 358
Connecting another mobile phone 362
Connecting audio devices 440
Device list 440
Entering the passcode 360
External authorization 361
General information 292
Interface 357
Introduction 357
Reconnecting an audio device 442
Searching for a mobile phone 359
Settings 292
Telephone basic menu 363
Telephony 358
Telephony notes 357
- Bluetooth® audio basic display** 443
- Bottle holder** 479
- Brake Assist System**
see BAS (Brake Assist System)
- Brake fluid**
Display message 230
Notes 563
- Brake lamps**
Display message 236
- Brakes**
ABS 57
BAS 58
BAS PLUS 58
Brake fluid (notes) 563
Display message 224
Driving tips 158
High-performance brake system 159
Important safety notes 158
Maintenance 159
Parking brake 155
Warning lamp 257
- Breakdown**
see Flat tire
see Towing away
- Brightness, setting (TV, video)** 453
- Bulbs**
see Changing bulbs
- Buttons on the COMAND controller** 274
- C**
- California**
Important notice for retail customers and lessees 29
- Call**
Accepting/ending/rejecting 364
Connecting 365
see Telephone
- Calling up a malfunction**
see Display messages
- Call lists**
Displaying details 372
Opening and selecting an entry 372
Saving an entry in the address book 372
- Car**
see Vehicle

- Care**
- Carpets 506
- Car wash 500
- Display 504
- Exterior lights 503
- Gear or selector lever 505
- Interior 504
- Matte finish 502
- Notes 500
- Paint 501
- Plastic trim 505
- Power washer 501
- Rear view camera 504
- Roof lining 506
- Seat belt 506
- Seat cover 505
- Sensors 504
- Steering wheel 505
- Tail pipes 504
- Trim pieces 505
- Washing by hand 501
- Wheels 502
- Windows 503
- Wiper blades 503
- Wooden trim 505
- Car pool lanes** 297
- Car wash (care)** 500
- Category list (music search)** 433
- CD**
- Copy protection 432
- Fast forward/fast rewind 428
- General information 432
- Inserting 421
- Mode, switching to 424
- Multisession 431
- Notes on discs 432
- Pause function 426
- Player/changer operation
 (COMAND) 421
- Safety notes 421
- Selecting a media type 426
- Selecting a track 427
- Sound settings (balance, bass,
 treble) 278
- CD/DVD**
- Ejecting (DVD drive) 423
- Inserting (DVD changer) 421
- Inserting (single DVD drive) 421
- Removing (single DVD drive) 421
- CD mode**
- Playback options 430
- CD player/CD changer (on-board
computer)** 212
- Central locking**
- Automatic locking (on-board
 computer) 218
- Locking/unlocking (SmartKey) 68
- Changing bulbs**
- Important safety notes 116
- Overview of bulb types 117
- Changing direction**
- Announcement phase 322
- Change of direction phase 322
- Preparation phase 322
- Changing the character set** 284
- Channel presets** 413
- Characters**
- Changing the character set 282
- Changing the language 282
- Deleting 283
- Entering 283
- Entering (address book, phone
 book) 281
- Entering (navigation) 283
- Moving the cursor 283
- Switching to letters 282
- Children**
- In the vehicle 54
- Restraint systems 54
- Special seat belt retractor 56
- Child seat**
- LATCH-type (ISOFIX) child seat
 anchors 56
- Cigarette lighter** 480
- Cleaning**
- Mirror turn signal 503
- Clear button** 274
- Climate control**
- Automatic climate control (dual-
 zone) 123
- Controlling automatically 126
- Cooling with air dehumidification . . 125
- Defrosting the windows 129
- Defrosting the windshield 128
- Important safety notes 122

- Indicator lamp 126
- Maximum cooling 128
- Notes on using automatic climate control 124
- Overview of systems 122
- Problems with cooling with air dehumidification 126
- Problem with the rear window defroster 129
- Setting the air distribution 127
- Setting the airflow 127
- Setting the air vents 131
- Setting the climate mode (AIR FLOW) 126
- Setting the temperature 127
- Switching air-recirculation mode on/off 130
- Switching on/off 125
- Switching residual heat on/off 130
- Switching the rear window defroster on/off 129
- Switching the ZONE function on/off 128
- Cockpit**
see Instrument cluster
- Color, setting (TV, video)** 453
- COMAND**
 - Active multicontour seat 287
 - Basic functions 275
 - Calling up drive status regulator (ABC) 291
 - Display 271
 - Examples of operation 273
 - Importing POIs 392
 - Multicontour seat 286
 - Seat functions 286
 - Settings 410
 - Switching on/off 275
 - System settings 289
- COMAND controller** 273
- COMAND display**
 - Cleaning 504
 - Cleaning instructions 272
 - Driving conditions menu (AMG vehicles) 183
 - Driving conditions menu (except AMG vehicles) 180
 - Setting 289
 - Switching on/off 272
- Combination switch** 112
- Compass function** 352
- Connecting a USB device** 424
- Consumption statistics (on-board computer)** 209
- Contacts**
 - Deleting 384
 - Importing 383
- Contrast, setting (TV, video)** 453
- Convenience closing feature** 85
- Convenience opening feature**
see Side windows
- Coolant (engine)**
 - Checking the level 498
 - Display message 238
 - Filling capacity 564
 - Notes 563
 - Temperature (on-board computer) . 220
 - Temperature gauge 205
 - Warning lamp 263
- Cooling**
see Climate control
- Copy protection (CD/DVD)** 432
- Cornering light function**
 - Display message 235
 - Function/notes 113
- Crash-responsive emergency lighting** 116
- Cruise control**
 - Cruise control lever 162
 - Deactivating 164
 - Display message 246
 - Driving system 162
 - Function/notes 162
 - Important safety notes 162
 - Setting a speed 163
 - Storing and maintaining current speed 163
- Cup holder**
 - Center console 478
 - Important safety notes 478
- Customer Assistance Center (CAC)** ... 32
- Customer Relations Department** 32

D

Dashboard

see Cockpit

Data medium

Audio DVD	431
CD/DVD	432
MP3	431
MUSIC REGISTER	436

Date format, setting 290**Day design, setting** 289**Daytime running lamps**

Display message	237
Switching on/off (on-board computer)	216
Switching on/off (switch)	109

Dealership

see Qualified specialist workshop

Delayed switch-off

Exterior lighting (on-board computer)	217
Interior lighting	218

Deleting

Call lists	374
------------------	-----

Destination

Assigning a destination to an address book entry	340
Search & Send	320

Destination (navigation)

Displaying information	328
Entering a destination by address ..	298
Entering a destination using the map	306
Entering an intermediate stop	307
Entering a point of interest	310
Entering using geo-coordinates	306
Saving	339
Selecting from the destination memory	304
Selecting from the list of last destinations	305
Selecting storage options	340
Storing after destination entry	339
Storing during route guidance	339

Destination memory (navigation)

Deleting an entry	341
Entering/saving your home address	304
Previous destinations	341

Diagnostics connection 31**Dialing a number (telephone)** 365**Digital speedometer** 209**DISC button**

Activating audio CD/DVD or MP3 mode	424
Activating Bluetooth® Audio	444
Switching on the Media Interface ..	447
Switching to the MUSIC REGISTER	436

Display

Selecting the design	289
----------------------------	-----

Displaying the arrival time 328**Displaying the distance to the****destination** 328**Displaying the track and album** 430**Display messages**

Calling up (on-board computer)	223
Driving systems	241
Engine	238
General notes	223
Hiding (on-board computer)	223
KEYLESS-GO	253
Lights	235
Safety systems	224
SmartKey	253
Tires	247
Vehicle	250

Distance display (on-board computer) 214**Distance recorder**

see Trip odometer

Distance warning (warning lamp) 265**DISTRONIC PLUS**

Cruise control lever	167
Deactivating	173
Display message	244
Displays in the multifunction display	172
Driving tips	174
Function/notes	166
Important safety notes	164

- Setting the specified minimum distance 172
- Warning lamp 265
- Dolby® Digital** 278
- Doors**
 - Automatic locking (on-board computer) 218
 - Automatic locking (switch) 76
 - Central locking/unlocking (SmartKey) 68
 - Display message 251
 - Emergency locking 77
 - Emergency unlocking 76
 - Important safety notes 74
 - Opening (from inside) 75
 - Overview 74
 - Power closing feature 76
- Drinking and driving** 157
- Drinks holder**
 - see Cup holder
- Drive program**
 - Automatic 149
 - Display 145
 - Manual 150
 - SETUP (on-board computer) 220
- Drive program selector** 147
- Driver's door**
 - see Doors
- Driver's seat**
 - see Seats
- Driving abroad**
 - Symmetrical low beam 108
- Driving on flooded roads** 161
- Driving safety systems**
 - ABS (Anti-lock Braking System) 57
 - ADAPTIVE BRAKE 63
 - BAS (Brake Assist System) 58
 - BAS PLUS (Brake Assist System PLUS) 58
 - Electronic brake force distribution ... 62
 - ESP® (Electronic Stability Program) 59
 - ETS (Electronic Traction System) 60
 - Important safety information 57
 - Overview 57
 - PRE-SAFE® Brake 63
 - STEER CONTROL 65
- Driving systems**
 - Active Blind Spot Assist 195
 - Active Body Control (AMG vehicles) 181
 - Active Body Control (except AMG vehicles) 179
 - Active Driving Assistance package 195
 - Active Lane Keeping Assist 199
 - Active Parking Assist 186
 - Adaptive Damping System 178
 - ATTENTION ASSIST 194
 - Cruise control 162
 - Display message 241
 - DISTRONIC PLUS 164
 - HOLD function 175
 - PARKTRONIC 183
 - RACE START (AMG vehicles) 177
 - Rear view camera 190
- Driving tips**
 - AMG ceramic brakes 159
 - Automatic transmission 146
 - Brakes 158
 - Break-in period 134
 - Checking brake lining thickness ... 160
 - DISTRONIC PLUS 174
 - Downhill gradient 158
 - Drinking and driving 157
 - Driving abroad 108
 - Driving in winter 161
 - Driving on flooded roads 161
 - Driving on wet roads 161
 - Exhaust check 158
 - Fuel 157
 - General 156
 - Hydroplaning 161
 - Icy road surfaces 161
 - Limited braking efficiency on salted roads 159
 - Pedals 157
 - Snow chains 529
 - Symmetrical low beam 108
 - Wet road surface 158
- DVD**
 - Copy protection 432
 - Fast forward/fast rewind 428
 - Inserting 421
 - Notes on discs 432

- Selecting a media type 426
 - Selecting a track 427
 - Sound settings (balance, bass, treble) 278
 - DVD audio**
 - Operating (on-board computer) 212
 - DVD video**
 - Operating (on-board computer) 212
- E**
- EASY-ENTRY feature**
 - Activating/deactivating 219
 - Function/notes 102
 - EASY-EXIT feature**
 - Crash-responsive 102
 - Function/notes 102
 - Switching on/off 219
 - EBD (electronic brake force distribution)**
 - Display message 226
 - Function/notes 62
 - ECO start/stop function**
 - Deactivating/activating 139
 - General information 139
 - Electrical fuses**
 - see Fuses
 - Electronic Stability Program**
 - see ESP® (Electronic Stability Program)
 - Emergency release**
 - Driver's door 76
 - Trunk 83
 - Vehicle 76
 - Emergency Tensioning Devices**
 - Function 53
 - Safety guidelines 38
 - Emissions control**
 - Service and warranty information 28
 - Engine**
 - Check Engine warning lamp 263
 - Display message 238
 - ECO start/stop function 138
 - Engine number 560
 - Irregular running 142
 - Jump-starting 516
 - Starting problems 142
 - Starting the engine with the SmartKey 137
 - Starting with KEYLESS-GO 137
 - Switching off 154
 - Tow-starting (vehicle) 520
 - Engine electronics**
 - Problem (malfunction) 142
 - Engine oil**
 - Adding 498
 - Additives 563
 - Checking the oil level 497
 - Checking the oil level using the dipstick 497
 - Display message 240
 - Filling capacity 563
 - Notes about oil grades 562
 - Notes on oil level/consumption ... 497
 - Temperature (on-board computer) . 220
 - Viscosity 563
 - Entering an intersection name** 301
 - Entering a street name** 299
 - Entering the address (example)** 298
 - Entering the city** 299
 - Entering the house number** 299
 - Entry**
 - Deleting 284
 - Saving 282
 - ESP® (Electronic Stability Program)**
 - AMG menu (on-board computer) ... 220
 - Deactivating/activating (AMG vehicles) 61
 - Deactivating/activating (notes; except AMG vehicles) 60
 - Display message 224
 - ETS 60
 - Function/notes 59
 - Important safety information 59
 - Warning lamp 259
 - ETS (Electronic Traction System)** 60
 - Example display**
 - Audio CD mode 425
 - MUSIC REGISTER 436
 - Exhaust check** 158
 - Exhaust tail pipe (cleaning instructions)** 504
 - Exterior lighting**
 - see Lights

- Exterior mirrors**
 Adjusting 103
 Dipping (automatic) 103
 Out of position (troubleshooting) ... 103
 Storing settings (memory function) 105
 Storing the parking position 104
- Eyeglasses compartment** 475
- F**
- Factory setting (reset function)** 294
- Fast forward**
 Audio mode (CD, DVD, MP3) 428
 Video DVD 455
- Fast rewind**
 Audio mode (CD, DVD, MP3) 428
 Video DVD 455
- Favorites (Internet)** 408
- Favorites button** 293
- Filling capacities (Technical data)** ... 560
- First-aid kit** 508
- Flat tire**
 MOExtended tires 510
 Preparing the vehicle 509
 TIREFIT kit 510
- Floormat** 481
- Fog lamps**
 Switching on/off 111
- Freeway information** 347
- Frequencies**
 Adjusting for radio stations 413
- Front fog lamps**
 Changing the bulbs 117
 Display message 237
 Switching on/off 111
- Front-passenger seat**
 Adjusting from the driver's seat 98
- Front windshield**
 see Windshield
- Fuel**
 Additives 562
 Consumption statistics 209
 Displaying consumption 290
 Displaying the current consumption 209
 Displaying the range 209
 Driving tips 157
- Fuel gauge 205
 Grade (gasoline) 561
 Important safety notes 561
 Premium-grade unleaded gasoline . 561
 Problem (malfunction) 154
 Refueling 152
 Tank content/reserve fuel 560
- Fuel filler flap, opening/closing** 153
- Fuel level**
 Calling up the range (on-board computer) 209
- Fuel tank**
 Capacity 560
 Problem (malfunction) 154
- Fuse allocation chart (vehicle tool kit)** 508
- Fuses**
 Allocation chart 521
 Before changing 521
 Dashboard fuse box 522
 Fuse box in the engine compartment 521
 Fuse box in the rear compartment . 522
 Important safety notes 521
- G**
- Garage door opener**
 Clearing the memory 485
 Notes 481
 Opening/closing the garage door .. 485
 Programming (button in the rear-view mirror) 482
- Gear indicator (on-board computer)** 220
- Genuine Mercedes-Benz parts** 558
- Glass roof (sunblind)** 92
- Glove box** 474
- Google Maps®** 320
- Google™ local search**
 Importing a destination/route 388
 Popular Searches 389
 Search 386
 Search history 389
 Selecting a search position 387
 Using as the destination 388
- GPS reception** 295
- Gracenote® Media Database** 428

H

Handbrake	
see Parking brake	
HANDS-FREE ACCESS	80
Harman/kardon® Logic 7®	
surround sound system	
see Surround sound (harman/ kardon® surround sound system)	
Hazard warning lamps	113
Head bags	
Display message	232
Operation	42
Heading up (navigation)	344
Headlamps	
Adding fluid to cleaning system	499
Cleaning system (function)	113
Cleaning system (notes)	564
Fogging up	115
see Automatic headlamp mode	
Head level heating (AIRSCARF)	101
Head restraints	
see NECK-PRO head restraints	
Heating	
see Climate control	
High-beam headlamps	
Display message	236
Switching Adaptive Highbeam	
Assist on/off	115
Switching on/off	112
Hill start assist	138
HOLD function	
Display message	242
Function/notes	176
Home address	
Entering and saving	304
Selecting from the destination memory	304
Hood	
Closing	497
Display message	251
Opening	496
Hydroplaning	161

I

Ignition lock	
see Key positions	
Immobilizer	65
Incident (traffic report)	333
Indicator lamps	
see Warning and indicator lamps	
Indicators	
see Turn signals	
Inspection	
see ASSYST PLUS	
Instrument cluster	
Overview	205
Warning and indicator lamps	255
Instrument cluster lighting	205
Instrument lighting	
see Instrument cluster lighting	
Interface (USB, iPod®)	
see Media Interface	
Interior lighting	
Automatic control	116
Delayed switch-off (on-board computer)	218
Emergency lighting	116
Manual control	116
Overview	115
Reading lamp	115
Setting the brightness of the ambient lighting (on-board computer)	216
Setting the color of the ambient lighting (on-board computer)	217
Intermediate stop	
Deleting	308
Entering	307
Internet	
Calling up the carousel view	402
Conditions for access	385
Entering the URL	402
Favorites manager	408
Favorites menu	408
Menu functions	405
Opening favorites	407
Selecting favourites	403

- iPod®**
 Alphabetical track selection 450
 Connecting to the Media
 Interface 446
 Selecting a category/playlist 448
- iTunes®** 450
- J**
- Jack**
 Storage location 508
 Using 549
- Jump start (engine)** 33
- Jump starting (engine)** 516
- K**
- Key**
 see SmartKey
- KEYLESS-GO**
 Convenience closing feature 85
 Display message 253
 Locking 69
 Start/Stop button 135
 Starting the engine 137
 Unlocking 69
- Key positions**
 KEYLESS-GO 135
 SmartKey 135
- Kickdown**
 Driving tips 147
 Manual drive program 151
- Knee bag** 41
- L**
- Lamps**
 see Warning and indicator lamps
- Lane Keeping Assist**
 see Active Lane Keeping Assist
- Lane recommendations**
 Explanation 323
 Presentation 323
- Lap time (RACETIMER)** 220
- LATCH-type (ISOFIX) child seat anchors** 56
- License plate lamp (display message)** 237
- Light function, active**
 Display message 237
- Lighting**
 see Lights
- Lights**
 Activating/deactivating the interior lighting delayed switch-off . 218
 Active light function 113
 Automatic headlamp mode 110
 Cornering light function 113
 Driving abroad 108
 Fog lamps 111
 Hazard warning lamps 113
 High beam flasher 112
 High-beam headlamps 112
 Light switch 108
 Low-beam headlamps 109
 Parking lamps 109
 Setting the brightness of the ambient lighting (on-board computer) 216
 Setting the color of the ambient lighting (on-board computer) 217
 Standing lamps 111
 Switching Adaptive Highbeam Assist on/off 217
 Switching the daytime running lamps on/off (on-board computer) 216
 Switching the daytime running lamps on/off (switch) 109
 Switching the exterior lighting delayed switch-off on/off (on-board computer) 217
 Switching the surround lighting on/off (on-board computer) 217
 Turn signals 112
 see Changing bulbs
 see Interior lighting
- Light sensor (display message)** 238
- Load/eject button** 421
- Loading aid (trunk)**
 Raising/lowering the roof 477
- Locking**
 see Central locking

- Locking (doors)**
 Automatic 76
 Emergency locking 77
 From inside (central locking button) 75
- Locking centrally**
 see Central locking
- Locking verification signal (on-board computer)** 218
- Low-beam headlamps**
 Display message 235
 Setting for driving abroad (symmetrical) 108
 Switching on/off 109
- Luggage cover**
 see Trunk partition
- Lumbar support** 287
- M**
- M+S tires** 528
- MAGIC SKY CONTROL** 92
- Maintenance**
 see ASSYST PLUS
- Malfunction message**
 see Display messages
- Map (navigation)**
 Adjusting the scale 342
 Arrival time/distance to the destination 345
 City model 347
 Geo-coordinate display 345
 Heading 344
 Information in the display 345
 Map settings 343
 Moving 343
 North orientation 344
 Notes 342
 Point of interest symbols 344
 Road display 345
 Saving the crosshair position 343
 Showing the map data version 352
 Topographical map 347
 Updating 353
 Updating process 353
- Matte finish (cleaning instructions)** 502
- mbrace**
 Call priority 489
 Display message 230
 Downloading destinations (COMAND) 489
 Downloading routes 492
 Emergency call 487
 Geo fencing 493
 Important safety notes 485
 Locating a stolen vehicle 491
 MB info call button 488
 Remote vehicle locking 491
 Roadside Assistance button 488
 Search & Send 490
 Self-test 486
 Speed alert 493
 System 486
 Triggering the vehicle alarm 493
 Vehicle remote malfunction diagnosis 492
 Vehicle remote unlocking 490
- Mechanical key**
 Function/notes 70
 Locking vehicle 77
 Unlocking the driver's door 76
- Media Interface**
 Alphabetical track selection 450
 Basic menu 447
 Connecting an external audio source 446
 Connection options 445
 iPod® 445
 Mode 445
 MP3 player 446
 Notes for the MP3 player 451
 Playback options 450
 Selecting categories 448
 Selecting folders 448
 Selecting music files 448
 Selecting playlists 448
 Switching to 447
 USB mass storage device 445
- Media list** 426
- Memory card (audio)** 212
- Memory function** 105
- Message memory (on-board computer)** 223

- Messages**
 see Display messages
- Microphone, switching on/off** 366
- Mirrors**
 see Exterior mirrors
 see Rear-view mirror
 see Vanity mirror (in the sun visor)
- Mobile phone**
 Authorizing 360
 Connecting (Bluetooth® interface) . 359
 De-authorizing 362
 External authorization 361
 Menu (on-board computer) 212
 Registering (authorizing) 360
- Modifying the programming (SmartKey)** 70
- MOExtended tires** 510
- Mounting wheels**
 Lowering the vehicle 552
 Mounting a new wheel 551
 Preparing the vehicle 548
 Raising the vehicle 549
 Removing a wheel 551
 Securing the vehicle against rolling away 549
- MP3**
 Bit/sampling rates 432
 Copyright 432
 Data medium 431
 Fast forward/fast rewind 428
 File systems 431
 Formats 432
 Mode, switching to 424
 Notes 431
 Operation 212
 Pause function 426
 Playback options 430
 Safety notes 421
 Selecting a media type 426
 Selecting a track 427
 Sound settings (balance, bass, treble) 278
- Multicontour seat** 286
- Multifunction display**
 Function/notes 208
 Permanent display 216
- Multifunction steering wheel**
 Adjusting the volume 277
 Operating the on-board computer . 206
- Multisession CD** 431
- Music files**
 Recording 437
- MUSIC REGISTER**
 Deleting all music files 438
 Deleting individual music files 439
 Disk space information 438
 General notes 436
 Playback options 439
 Switching to 436
- Music search** 433
- My address**
 see Home address

N

Navigation

- Adjusting the volume of the navigation announcements 277
- Alternative route 327
- Avoiding an area 349
- Basic settings 297
- Blocking a route section affected by a traffic jam 326
- Compass function 352
- Destination memory 337
- Displaying destination information (arrival time, distance to destination) 328
- Entering/saving your home address 304
- Entering a destination 298
- Entering a destination by address .. 298
- Entering a destination using the map 306
- Entering an intermediate stop 307
- Entering a point of interest 310
- Entering characters (character bar) 283
- Freeway information 347
- General notes 295
- GPS reception 295
- Lane recommendation 323
- List of areas 350
- Map settings 342

- Menu (on-board computer) 210
 - Off-road/off-map (off-road destination) 331
 - Overview 295
 - Previous destinations 341
 - Reading out traffic reports 336
 - Repeating announcements 325
 - Route guidance 321
 - Safety notes 295
 - Selecting a destination from the destination memory 304
 - Selecting a destination from the list of last destinations 305
 - Selecting your home address 304
 - Setting options for destination/route download 400
 - Setting route options (avoiding: highways, toll roads, tunnels, ferries) 297
 - Setting the route type (short route, fast route, dynamic route or economic route) 297
 - Showing/hiding the menu 296
 - Starting route calculation 303
 - Switching announcements on/off 325
 - Switching to 296
 - Navigation announcements**
 - Switching off 277
 - NECK-PRO head restraints**
 - Operation 48
 - Resetting after being triggered 49
 - North orientation (navigation)** 344
 - Notes on breaking-in a new vehicle** 134
- O
- Occupant Classification System (OCS)**
 - Faults 47
 - Operation 43
 - System self-test 46
 - Occupant safety**
 - Children in the vehicle 54
 - Important safety notes 36
 - OCS**
 - Faults 47
 - Operation 43
 - System self-test 46
 - Odometer**
 - see Trip odometer
 - Off-map** 332
 - Off-road** 331
 - Oil**
 - see Engine oil
 - On-board computer**
 - AMG menu 220
 - Assistance menu 214
 - Audio menu 211
 - Convenience submenu 219
 - Display messages 223
 - DISTRONIC PLUS 172
 - Factory settings submenu 219
 - Important safety notes 204
 - Instrument cluster submenu 215
 - Lighting submenu 216
 - Menu overview 208
 - Message memory 223
 - Navigation menu 210
 - Operation 206
 - RACETIMER 220
 - Service menu 215
 - Settings menu 215
 - Standard display 208
 - Telephone menu 212
 - Trip menu 208
 - Vehicle submenu 218
 - Video DVD operation 212
 - Online and Internet functions**
 - Ending the connection 386
 - Establishing/ending the connection 385
 - Further Mercedes-Benz Apps 402
 - Mercedes-Benz Mobile Website 401
 - Options menu 397
 - Resetting settings 401
 - Selecting options for the local search 397
 - Selecting options for the weather display 398
 - Setting options for destination/route download 400

Operating safety	
Diagnostics connection	31
Operating system	
see On-board computer	
Outside temperature display	206

P

Paint code number	559
Paintwork (cleaning instructions) ...	501
Panic alarm	36
Parking	
Engaging park position	144
Important safety notes	154
Parking brake	155
Position of exterior mirror, front- passenger side	104
Rear view camera	190
see PARKTRONIC	
Parking aid	
see PARKTRONIC	
Parking brake	
Display message	226
Electric parking brake	155
PARKTRONIC	
Deactivating/activating	185
Driving system	183
Function/notes	183
Important safety notes	183
Problem (malfunction)	186
Range of the sensors	184
Warning display	185
PASSENGER AIR BAG OFF indicator lamp	43
Pause function	
Audio mode (CD, DVD, MP3)	426
Video DVD	456
Pedals	157
Personal POIs	
Acoustic notification	317
Calling up the menu	316
Displaying on the map	316
Managing categories	317
Saving	318
Selecting as the destination	319
Settings	316
Visual information	317

Phone book	
Adding a number to an address	
book entry	371
Calling up	368
Creating a new entry	370
Deleting an entry	370
Entering characters	281
Icon overview	369
Searching for an entry	369
Picture settings (TV, video)	453
Picture viewer	
Displaying pictures	460
Introduction	459
Plastic trim (cleaning instructions) .	505
Playback options	
Audio mode (CD, DVD, MP3)	430
POI (navigation)	
Category	313
Defining the position for the POI	
search	312
Entering	310
Entering a point of interest using	
the map	315
List	313
ZAGAT® survey service	315
see Personal POIs	
Point of interest icon	
Setting	344
Point of interest list	
With character bar	314
Power closing feature	76
Power washers	501
Power windows	
see Side windows	
PRE-SAFE® (anticipatory occupant protection)	
Display message	230
Operation	48
PRE-SAFE® Brake	
Activating/deactivating	214
Display message	231
Function/notes	63
Warning lamp	265
Previous destinations (navigation) ..	341
Product information	28
Program selector button	147

- Pulling away (automatic transmission)** 138
- Q**
- Qualified specialist workshop** 31
- R**
- RACE START**
 Important safety notes 177
- RACETIMER (on-board computer)** 220
- Radar sensor system**
 Activating/deactivating 218
 Display message 242
- Radio**
 Overview 411
 Selecting a station 211
 Setting a station 413
 Sound settings (balance, bass, treble) 278
 Storing stations 414
 Switching on 411
 Switching wavebands 413
- Read-aloud function** 336
- Reading lamp** 115
- Real-time traffic reports** 333
- Rear lamps**
 see Lights
- Rear view camera**
 Cleaning instructions 504
 Displaying the image 276
 Function/notes 190
 Switching on/off 191
- Rear-view mirror**
 Anti-glare (manual) 103
 Dipping (automatic) 103
- Rear window defroster**
 Problem (malfunction) 129
 Switching on/off 129
- Receiving vCards** 384
- Redialing (telephone)** 365
- Refueling**
 Fuel gauge 205
 Important safety notes 152
 Refueling process 153
 see Fuel
- Remote control**
 Programming (garage door opener) 482
- Reporting safety defects** 32
- Reserve (fuel tank)**
 see Fuel
- Reserve fuel**
 Display message 240
 Warning lamp 263
 see Fuel
- Reset function** 294
- Resetting (factory settings)** 294
- Residual heat (climate control)** 130
- Restraint system**
 see SRS (Supplemental Restraint System)
- Reverse gear (selector lever)** 143
- Reversing lamps (display message)** 237
- Roadside Assistance (breakdown)** 29
- Roll bar**
 Display message 231
 Operation 43
- Roller sunblind** 92
- Roof**
 Display message 252
 Important safety notes 86
 Opening/closing (with roof switch) 87
 Opening/closing (with SmartKey) ... 88
 Overview 86
 Problem (malfunction) 94
 Relocking 88
- Roof lining and carpets (cleaning guidelines)** 506
- Roof switch** 87
- Route**
 Estimated time of arrival 328
- Route (navigation)**
 Calling up the "Routes" menu 330
 Displaying the distance to the destination 328
 Recording 329
 Route overview 328
 Selecting an alternative route 327

Setting route options (avoiding: highways, toll roads, tunnels, ferries)	297
Setting the route type (short route, fast route, dynamic route or economic route)	297
Starting calculation	303
Route demonstration	329
Route guidance	
Canceling	326
Continuing	326
Destination reached	326
General notes	321
Lane recommendations	323
Off-road	331
Traffic reports	333

S

Safety

Children in the vehicle	54
Child restraint systems	54
Occupant Classification System (OCS)	43

Safety notes

Audio CD/DVD and MP3 mode	421
Using the telephone	357
Video DVD mode	453

Safety systems

see Driving safety systems

SatRadio

Displaying information	420
Notes	416
Registering	416
Selecting a category	418
Switching to	417

Saving the crosshair position

.....	343
-------	-----

SD memory card

Ejecting	424
Inserting	424

Search & Send

.....	320
-------	-----

Seat belts

Adjusting the driver's and front-passenger seat belt	52
Belt force limiters	53
Cleaning	506
Correct usage	50
Emergency Tensioning Devices	53

Fastening	51
Important safety guidelines	49
Releasing	52
Safety guidelines	38
Seat belt guide	99
Switching belt adjustment on/off (on-board computer)	219
Warning lamp	256
Warning lamp (function)	52

Seats

Active multicontour seat	287
Adjusting (electrically)	98
Adjusting the 4-way lumbar support	287
Balance (seat heating)	288
Belt guide	99
Cleaning the cover	505
Correct driver's seat position	96
Important safety notes	97
Massage function	288
Multicontour seat	286
Overview	97
Resetting settings	288
Seat functions (COMAND)	286
Seat heating problem	100
Seat ventilation problem	101
Selecting for adjustment (COMAND)	286
Sliding forward/back	99
Storing settings (memory function)	105
Switching AIRSCARF on/off	101
Switching seat heating on/off	100
Switching seat ventilation on/off	100

Selecting a province

Selecting a state

Selecting stations

Radio	413
-------------	-----

Selector lever

Cleaning	505
Positions	143

Sending DTMF tones

Sensors (cleaning instructions)

Service

see ASSYST PLUS

Service Center

see Qualified specialist workshop

Service menu (on-board computer)

215

- Service products**
 - Brake fluid 563
 - Coolant (engine) 563
 - Engine oil 562
 - Fuel 561
 - Important safety notes 560
 - Washer fluid 564
- Settings**
 - Factory (on-board computer) 219
 - On-board computer 215
 - Picture (COMAND) 453
 - Sound settings 278
 - System settings 289
- Setting the air distribution** 127
- Setting the airflow** 127
- Setting the language**
 - COMAND 292
- Setting the night design** 289
- Setting the text reader speed** 291
- Setting the volume**
 - Telephone calls 277
 - Video AUX 459
- SETUP (on-board computer)** 220
- Side impact air bag** 41
- Side windows**
 - Cleaning 503
 - Convenience closing feature 85
 - Important safety information 83
 - Opening/closing (all) 84
 - Opening/closing (front) 83
 - Opening/closing (rear) 84
 - Overview 83
 - Problem (malfunction) 86
 - Resetting 85
- SIRIUS weather display**
 - 5-day forecast 462
 - Daily forecast 462
 - Detail information 462
 - Information chart 462
 - Selecting the area for the weather forecast 463
 - Switching on/off 462
 - Weather map 465
- SmartKey**
 - Changing the battery 71
 - Changing the programming 70
 - Checking the battery 71
 - Convenience opening feature 84
 - Display message 253
 - Door central locking/unlocking 68
 - Important safety notes 68
 - Loss 73
 - Mechanical key 70
 - Opening/closing the roof 88
 - Overview 68
 - Positions (ignition lock) 135
 - Problem (malfunction) 73
 - Starting the engine 137
- Snow chains** 529
- Sockets**
 - Front-passenger footwell 481
 - General notes 480
 - Trunk 481
 - Under the armrest 481
- Sound**
 - Switching on/off 277
- Sound menu** 278
- Sound Mode** 280
- Sound settings**
 - Calling up the sound menu 278
 - Surround sound 278
 - Treble and bass 278
- Spare wheel**
 - see Emergency spare wheel
- Specialist workshop** 31
- Special seat belt retractor** 56
- Speed, controlling**
 - see Cruise control
- Speed dial list**
 - Storing a phone book entry in the speed dial list 374
- Speedometer**
 - Digital 209
 - In the Instrument cluster 205
 - Segments 206
 - Selecting the unit of measurement 215
 - see Instrument cluster
- SPORT handling mode**
 - Activating/deactivating (AMG vehicles) 61
 - Warning lamp 260

- SRS (Supplemental Restraint System)**
 Introduction 37
 Warning lamp 262
 Warning lamp (function) 37
- Standing lamps**
 Display message 237
 Switching on/off 111
- Starting (engine)** 137
- Station search** 413
- STEER CONTROL** 65
- Steering (display message)** 252
- Steering wheel**
 Adjusting (electrically) 101
 Buttons (on-board computer) 206
 Cleaning 505
 Important safety notes 101
 Paddle shifters 148
 Storing settings (memory function) 105
- Steering wheel paddle shifters** 148
- Stop function**
 Audio DVD 426
 Video DVD 455
- Stopwatch (RACETIMER)** 220
- Storing stations**
 Radio 414
- Stowage areas** 474
- Stowage compartments**
 Armrest (under) 475
 Center console 475
 Cup holders 478
 Display message) 252
 Eyeglasses compartment 475
 Glove box 474
 Important safety information 474
 Rear 476
 Stowage net 476
- Stowage net** 476
- Stowage space**
 Center console (rear) 476
 Umbrella holder 475
- Stowage well beneath the trunk floor** 478
- Summer tires** 528
- Sun visor** 479
- Supplemental Restraint System**
 see SRS (Supplemental Restraint System)
- Surround lighting (on-board computer)** 217
- Surround sound** 278
- Surround sound (harman/kardon® surround sound system)**
 Notes 278
 Switching on/off 279
- Suspension tuning**
 Active Body Control (AMG vehicles) 182
 Active Body Control (except AMG vehicles) 180
 SETUP (on-board computer) 220
- Switching air-recirculation mode on/off** 130
- Switching between picture formats (TV, video)** 453
- Switching between summer time and standard time** 290
- Switching off the alarm (ATA)** 65
- Switching the hands-free microphone on/off** 366
- Switching wavebands (radio)** 413
- System settings**
 Bluetooth® 292
 Date 289
 Language 292
 Text reader speed 291
 Time 289
 Time zone 290
 Voice Control System 291
- T**
- Tachometer** 206
- Tail lamps**
 Display message 236
 see Lights
- Tank**
 see Fuel tank
- Tank content**
 Fuel gauge 205
- Technical data**
 Capacities 560
 Notes 558

- Tires/wheels 552
- Vehicle data 565
- TELEAID**
- Call priority 489
- Downloading destinations
 (COMAND) 489
- Downloading routes 492
- Emergency call 487
- Geo fencing 493
- Important safety notes 485
- Locating a stolen vehicle 491
- MB info call button 488
- Remote vehicle locking 491
- Roadside Assistance button 488
- Search & Send 490
- Self-test 486
- Speed alert 493
- System 486
- Triggering the vehicle alarm 493
- Vehicle remote malfunction
 diagnosis 492
- Vehicle remote unlocking 490
- Telephone**
- Accepting/ending a call 364
- Accepting a call 213
- Adjusting the volume for calls 277
- Calling (outgoing call) 365
- Connecting a mobile phone
 (general information) 359
- De-authorizing a mobile phone 362
- Display message 252
- Ending an active call 368
- Entering a number 365
- Entering phone numbers 365
- External authorization
 (Bluetooth®) 361
- Function restrictions 358
- General notes 357
- Incoming call 364
- Making a call 367
- Making a call via speed dial 365
- Menu (on-board computer) 212
- Number from the phone book 213
- Operating options 357
- Overview 357
- Overview of functions 366
- Reception and transmission
 volume 364
- Redialing 213
- Rejecting/accepting a waiting
 call 367
- Rejecting/ending a call 213
- Rejecting a call 364
- Safety notes 357
- Sending DTMF tones 366
- Single call 366
- Switching hands-free microphone
 on/off 366
- Text messages (SMS) 375
- Toggling 368
- Using the telephone 364
 see Bluetooth®
- Telephone basic menu**
- Bluetooth® interface 363
- Telephone mode**
- Redialing 365
- Telephone number**
- Entering 365
- Temperature**
- Coolant 205
- Coolant (on-board computer) 220
- Engine oil (on-board computer) 220
- Outside temperature 206
- Setting (climate control) 127
- Text messages (SMS)**
- Calling the sender 377
- Deleting 377
- Inbox 376
- Information and requirements 375
- Reading 376
- Reading aloud 376
- Storing sender in address book 377
- Storing the sender as a new
 address book entry 377
- Theft deterrent systems**
- ATA (Anti-Theft Alarm system) 65
- Immobilizer 65
- Time**
- Setting 290
- Setting summer/standard time 290
- Setting the format 290
- Setting the time 289
- Setting the time/date format 290
- Setting the time zone 290
- Timing (RACETIMER)** 220

- TIREFIT kit** 510
- Tire pressure**
 - Calling up (on-board computer) 534
 - Checking manually 533
 - Display message 247
 - Maximum 532
 - Notes 531
 - Not reached (TIREFIT) 512
 - Reached (TIREFIT) 512
 - Recommended 529
- Tire pressure loss warning system**
 - Important safety notes 533
 - Restarting 533
- Tire pressure monitoring system**
 - Function/notes 534
 - Restarting 536
 - Warning lamp 266
- Tires**
 - Aspect ratio (definition) 547
 - Average weight of the vehicle occupants (definition) 545
 - Bar (definition) 545
 - Changing a wheel 547
 - Characteristics 545
 - Checking 527
 - Definition of terms 545
 - Direction of rotation 548
 - Display message 247
 - Distribution of the vehicle occupants (definition) 547
 - DOT, Tire Identification Number (TIN) 544
 - DOT (Department of Transportation) (definition) 545
 - GAWR (Gross Axle Weight Rating) (definition) 546
 - GVW (Gross Vehicle Weight) (definition) 546
 - GVWR (Gross Vehicle Weight Rating) (definition) 546
 - Important safety notes 526
 - Increased vehicle weight due to optional equipment (definition) 546
 - Kilopascal (kPa) (definition) 546
 - Labeling (overview) 541
 - Load bearing index (definition) 547
 - Load index 544
 - Load index (definition) 546
 - Maximum loaded vehicle weight (definition) 546
 - Maximum load on a tire (definition) 546
 - Maximum permissible tire pressure (definition) 546
 - Maximum tire load 544
 - Maximum tire load (definition) 546
 - MOExtended tires 528
 - Optional equipment weight (definition) 547
 - Overview 526
 - PSI (pounds per square inch) (definition) 546
 - Replacing 547
 - Service life 528
 - Sidewall (definition) 547
 - Speed rating (definition) 546
 - Storing 548
 - Structure and characteristics (definition) 545
 - Temperature 541
 - TIN (Tire Identification Number) (definition) 547
 - Tire bead (definition) 547
 - Tire pressure (definition) 547
 - Tire pressures (recommended) 545
 - Tire size (data) 552
 - Tire size designation, load-bearing capacity, speed rating 541
 - Tire tread 527
 - Tire tread (definition) 547
 - Total load limit (definition) 547
 - Traction 540
 - Traction (definition) 547
 - Tread wear 540
 - Uniform Tire Quality Grading Standards 540
 - Uniform Tire Quality Grading Standards (definition) 545
 - Unladen weight (definition) 546
 - Wear indicator (definition) 547
 - Wheel rim (definition) 546
 - see Flat tire
- Towing**
 - Important safety guidelines 518
 - Installing the towing eye 518

- Removing the towing eye 519
 - With the rear axle raised 519
 - Towing away**
 - With both axles on the ground 520
 - Tow-starting**
 - Emergency engine starting 520
 - Important safety notes 518
 - Track**
 - Selecting (CD, DVD, MP3) 427
 - Selecting using the number keypad 427
 - Traffic jam function** 326
 - Traffic reports**
 - Calling up a list 335
 - Reading out on route 336
 - Real-time traffic report 336
 - Transmission**
 - Selector lever 143
 - see Automatic transmission
 - Transporting the vehicle** 520
 - Treble, adjusting (sound)** 278
 - Trim pieces (cleaning instructions)** . 505
 - Trip computer (on-board computer)** 209
 - Trip meter**
 - see Trip odometer
 - Trip odometer**
 - Calling up 208
 - Resetting (on-board computer) 210
 - True Image™** 280
 - Trunk**
 - Emergency release 83
 - Important safety notes 77
 - Locking separately 82
 - Opening/closing (automatically from inside) 81
 - Opening/closing (automatically from outside) 79
 - Opening/closing (from outside, HANDS-FREE ACCESS) 80
 - Opening/closing (manually from outside) 78
 - Overview 77
 - Trunk lid**
 - Display message 251
 - Opening/closing 77
 - Opening dimensions 565
 - Power closing feature 76
 - Trunk load (maximum)** 565
 - Trunk partition**
 - Display message 252
 - General notes 89
 - Installing 89
 - Opening/closing 89
 - Removing 89
 - Turn signals**
 - Display message 235
 - Switching on/off 112
 - TV**
 - Automatic picture shutoff 452
 - Picture settings 453
 - Sound settings (balance, bass, treble) 278
 - Type identification plate**
 - see Vehicle identification plate
- U**
- Umbrella holder** 475
 - Unlocking**
 - Emergency unlocking 76
 - From inside the vehicle (central unlocking button) 75
 - Updating the digital map** 353
 - USB**
 - see Media Interface
- V**
- Vanity mirror (in the sun visor)** 479
 - Vehicle**
 - Correct use 31
 - Data acquisition 32
 - Display message 250
 - Equipment 28
 - Individual settings 215
 - Limited Warranty 32
 - Loading 537
 - Locking (in an emergency) 77
 - Locking (SmartKey) 68
 - Lowering 552
 - Maintenance 29
 - Parking for a long period 156
 - Pulling away 138

- Raising 549
 - Reporting problems 32
 - Securing from rolling away 549
 - Towing away 518
 - Tow-starting 518
 - Transporting 520
 - Unlocking (in an emergency) 76
 - Unlocking (SmartKey) 68
 - Vehicle data 565
 - Vehicle battery**
 - see Battery (vehicle)
 - Vehicle data** 565
 - Vehicle dimensions** 565
 - Vehicle emergency locking** 77
 - Vehicle identification number**
 - see VIN
 - Vehicle identification plate** 559
 - Vehicle level**
 - Active Body Control (AMG vehicles) 181
 - Active Body Control (except AMG vehicles) 179
 - Display message 241
 - Vehicle maintenance**
 - see ASSYST PLUS
 - Vehicle tool kit** 508
 - Video**
 - Operating the DVD 212
 - Overview 452
 - see Video DVD
 - Video AUX**
 - Setting the picture 453
 - Video DVD**
 - Automatic picture shutoff 452
 - DVD menu 457
 - Fast forward/rewind 455
 - Function restrictions 454
 - Interactive content 458
 - Notes on discs 453
 - Operation 453
 - Pause function 456
 - Playing conditions 453
 - Safety notes 453
 - Selecting 456
 - Selecting a film/title 456
 - Selecting a scene/chapter 456
 - Setting the audio format 458
 - Setting the language 458
 - Setting the picture 453
 - Showing/hiding the control menu . 454
 - Showing/hiding the menu 455
 - Stop function 455
 - Subtitles 458
 - Switching to 454
 - VIN** 559
 - Voice Control System**
 - Settings 291
 - Volume, adjusting**
 - COMAND 277
 - Navigation messages 277
- W
- Warning and indicator lamps**
 - ABS 257
 - Brakes 257
 - Check Engine 263
 - Coolant 263
 - Distance warning 265
 - DISTRONIC PLUS 265
 - ESP® 259
 - ESP® OFF 260
 - Fuel tank 263
 - Overview 255
 - PASSENGER AIR BAG OFF indicator lamp 43
 - Reserve fuel 263
 - Seat belt 256
 - SPORT handling mode 260
 - SRS 262
 - Tire pressure monitor 266
 - Warranty** 558
 - Washer fluid**
 - Display message 253
 - Waypoints**
 - Accepting waypoints for the route . 310
 - Editing 310
 - Entering 308
 - Weather Band**
 - Searching for a channel 415
 - Switching on 414
 - Weather display (COMAND)**
 - Calling up the weather map 395
 - Information chart 393
 - Selecting locations in the information chart 394

- Selecting the location 394
- Selecting the location in the weather map 395
- Switching off 393
- Switching on 393
- Weather map (COMAND)**
 - Legend 396
 - Showing/hiding the menu 396
 - Switching to the weather information display 396
- Weather map (SIRIUS)**
 - Calling up 465
 - Legend 470
 - Moving 465
 - Showing/hiding layers 466
 - Showing/hiding the menu 465
 - Time stamp 470
- Weather memory (SIRIUS)**
 - Selecting an area 465
 - Storing an area 464
- Website**
 - Add to favourites 407
- Wheel bolt tightening torque** 552
- Wheel chock** 549
- Wheels**
 - Changing a wheel 547
 - Checking 527
 - Cleaning 502
 - Cleaning (warning) 548
 - Important safety notes 526
 - Interchanging/changing 547
 - Mounting a new wheel 551
 - Mounting a wheel 548
 - Overview 526
 - Removing a wheel 551
 - Storing 548
 - Tightening torque 552
 - Wheel size/tire size 552
- Windows**
 - see Side windows
- Wind screen**
 - Electrical wind screen 92
 - Manual wind screen 90
- Windshield**
 - Defrosting 128
- Windshield washer fluid**
 - see Windshield washer system
- Windshield washer system**
 - Adding washer fluid 499
 - Notes 564
- Windshield wipers**
 - Problem (malfunction) 120
 - Replacing the wiper blades 119
 - Switching on/off 118
- Winter driving**
 - Important safety notes 528
 - Slippery road surfaces 161
 - Snow chains 529
- Winter operation**
 - Overview 528
- Winter tires**
 - M+S tires 528
- Wiper blades**
 - Cleaning 503
 - Important safety notes 119
 - Replacing 119
- Wooden trim (cleaning instructions)** 505
- Workshop**
 - see Qualified specialist workshop

Z

- ZAGAT® rating service** 315

Product information

Mercedes-Benz recommends that you use genuine Mercedes-Benz parts, conversion parts and accessories that have been approved for your vehicle.

Mercedes-Benz tests genuine parts as well as conversion parts and accessories that have been specifically approved for your vehicle for their reliability, safety and suitability. Despite ongoing market research, Mercedes-Benz is unable to assess other parts. Therefore, Mercedes-Benz accepts no responsibility for the use of such parts in Mercedes-Benz vehicles. This is also the case, even if they have been independently or officially approved. The use of non-approved parts could affect your vehicle's operating safety.

Genuine Mercedes-Benz parts, approved conversion parts and accessories are available from any authorized Mercedes-Benz Center. Here, you will receive advice about permissible technical modifications, and the parts will be professionally installed.

Printed Operator's Manual

The printed Operator's Manual (including any Supplements) must be observed.

There is no electronic update to the Digital Operator's Manual. Amendments are only made to the printed Operator's Manual.

Operator's Manual

General notes

Before you first drive off, read this Operator's Manual carefully and familiarize yourself with your vehicle.

For your own safety and a longer vehicle life, follow the instructions and warning notices in this manual. Disregarding them may lead to damage to the vehicle or personal injury.

Vehicle damage resulting from the disregard of the instructions is not covered by the Mercedes-Benz Limited Warranty.

Vehicle equipment

This Operator's Manual describes all models and all standard and optional equipment of your vehicle available at the time of going to print. Country-specific differences are possible. Please note that your vehicle may not be equipped with all features described. This also applies to safety-related systems and functions. The equipment in your vehicle may therefore differ from some of the descriptions or illustrations.

The original purchase agreement lists all systems installed in your vehicle.

Contact an authorized Mercedes-Benz Center if you have any questions about equipment or operation.

The Operator's Manual and the Maintenance Booklet are important documents and should be kept in the vehicle.

Service and vehicle operation

Service and literature

Your vehicle is covered under the terms of the warranties printed in the Service and Warranty Information booklet. Your authorized Mercedes-Benz Center will exchange or repair any defective parts originally installed in the vehicle in accordance with the terms of the following warranties:

- New Vehicle Limited Warranty
- Emission Systems Warranty
- Emission Performance Warranty
- California, Connecticut, Maine, Massachusetts, New York, Pennsylvania, Rhode Island and Vermont Emission Control Systems Warranty
- State warranty enforcement laws (lemon laws)

Information for customers in California

In California, you have the right to exchange a vehicle or receive a refund of the purchase or leasing price if Mercedes-Benz USA, LLC and/or an authorized workshop or maintenance facility cannot, after several authorized repairs, rectify considerable damage to or malfunctions of the vehicle that are covered by the contractual warranty. During the period of 18 months from original delivery of the vehicle or the accumulation of 18,000 miles (approximately 29,000 km) on the odometer of the vehicle, whichever occurs first, a reasonable number of repair attempts is presumed for a retail buyer or lessee if one or more of the following occurs:

- (1) the serious defect or damage can result in deadly or serious injury to the vehicle occupants while driving AND this defect has already been repaired at least twice AND Mercedes-Benz, LLC has been informed in writing of the necessity of a repair.
- (2) the defect or damage, though less serious than (1) above, has already been repaired at least four times AND Mercedes-Benz has been informed in writing of the necessity of a repair.
- (3) the vehicle cannot be used for longer than 30 calendar days because of repair work resulting from this or other serious defects or damage.

Please send your written notice to:

Mercedes-Benz USA, LLC
Customer Assistance Center
One Mercedes Drive
Montvale, NJ 07645-0350

Maintenance

The Service and Warranty Booklet describes all the necessary maintenance work which should be done at regular intervals.

Always have the Service and Warranty Booklet with you when you bring the vehicle to an authorized Mercedes-Benz Center. The service advisor will record every service for you in the Service and Warranty Booklet.

Roadside Assistance

The Mercedes-Benz Roadside Assistance Program offers technical help in the event of a breakdown. Calls to the toll-free Roadside Assistance Hotline are answered by our agents 24 hours a day, 365 days a year.

**1-800-FOR-MERCEdes(1-800-367-6372)
(USA)**

1-800-387-0100 (Canada)

For additional information, refer to the Mercedes-Benz Roadside Assistance Program brochure (USA) or the "Roadside Assistance" section in the Service and Warranty booklet (Canada). You will find both in your vehicle literature portfolio.

Change of address or change of ownership

In the event of a change of address, please send us the "Notification of Address Change" in the Service and Guarantee booklet or simply call the Mercedes-Benz Customer Assistance Center (USA) at the hotline number

1-800-FOR-MERCEdes(1-800-367-6372) or Customer Service Center (Canada) at 1-800-387-0100. This will assist us in contacting you in a timely manner should the need arise.

If you sell your Mercedes, please leave the entire literature in the vehicle so that it is available to the next owner.

If you have purchased a used car, please send us the "Notification of Used Car Purchase" in the Service and Guarantee booklet or simply call the Mercedes-Benz Customer Assistance Center (USA) at the hotline number 1-800-FOR-MERCEdes(1-800-367-6372) or

Customer Service (Canada) at
1-800-387-0100.

Vehicle operation outside the USA and Canada

If you plan to operate your vehicle in foreign countries, please be aware that:

- service facilities or replacement parts may not be readily available.
- unleaded fuel for vehicles with a catalytic converter may not be available. Leaded fuel may cause damage to the catalytic converter.
- the fuel may have a considerably lower octane rating. Unsuitable fuel can cause engine damage.

Some Mercedes-Benz models are available for delivery in Europe through our European Delivery Program. For details, consult an authorized Mercedes-Benz Center or write to one of the following addresses.

In the USA

Mercedes-Benz USA, LLC
European Delivery Department
One Mercedes Drive
Montvale, NJ 07645-0350

In Canada

Mercedes-Benz Canada, Inc.
European Delivery Department
98 Vanderhoof Avenue
Toronto, Ontario M4G 4C9

systems. Electronic malfunctions could seriously impair the operating safety of your vehicle.

Contact an authorized Mercedes-Benz Center for repairs or modifications to electronic components.

Other improper work or modifications on the vehicle could also have a negative impact on the operating safety of the vehicle.

Some safety systems only function when the engine is running. You should therefore never turn off the engine while driving.

WARNING

Heavy blows against the vehicle underbody or tires/wheels may cause serious damage and impair the operating safety of your vehicle. Such blows can be caused, for example, by running over an obstacle, road debris or a pothole.

If you feel a sudden significant vibration or ride disturbance, or you suspect that damage to your vehicle has occurred:

- turn on your hazard warning flashers.
- slow down carefully.
- drive with caution to an area which is a safe distance from the road.

Inspect the vehicle underbody and tires/wheels for possible damage. If the vehicle appears unsafe, have it towed to the nearest authorized Mercedes-Benz Center or other qualified maintenance or repair facility for further inspection or repairs.

Operating safety

Important safety notes

WARNING

Work improperly carried out on electronic components and associated software could cause them to cease functioning. Because the vehicle's electronic components are interconnected, any modifications made may produce an undesired effect on other

Declarations of conformity

Vehicle components which receive and/or transmit radio waves

USA: "The wireless devices of this vehicle comply with Part 15 of the FCC Rules. Operation is subject to the following two conditions: 1) These devices may not cause harmful interference, and 2) These devices must accept any interference received,

including interference that may cause undesired operation. Changes or modifications not expressly approved by the party responsible for compliance could void the user's authority to operate the equipment."

Canada: "The wireless devices of this vehicle comply with Industry Canada license-exempt RSS standard(s). Operation is subject to the following two conditions: (1) These devices may not cause interference, and (2) These devices must accept any interference, including interference that may cause undesired operation of the device."

Diagnostics connection

WARNING

If you connect equipment to the on-board diagnostics connection, it can affect the operation of the vehicle systems. This can impair the operating safety of your vehicle while driving. There is a risk of an accident.

Do not connect any equipment to the on-board diagnostics connection.

WARNING

Loose equipment or equipment cables which are connected to the on-board diagnostics connection can obstruct the area around the pedals. The equipment or the cables could come between the pedals in the event of sudden braking or acceleration. This may affect the function of the pedals. There is a risk of an accident.

Do not attach any equipment or cables in the driver's footwell.

! If the engine is switched off and equipment on the diagnostics connection is used, the starter battery may discharge.

The diagnostics connection is only intended for the connection of diagnostic equipment at a qualified specialist workshop.

Connecting equipment to the diagnostics connection can, for example, lead to

emissions monitoring information being reset. This may lead to the vehicle failing to meet the requirements of the next emissions test during the main inspection.

Qualified specialist workshop

An authorized Mercedes-Benz Center is a qualified specialist workshop. It has the necessary specialist knowledge, tools and qualifications to correctly carry out the work required on your vehicle. This is especially the case for work relevant to safety.

Observe the notes in the Maintenance Booklet.

Always have the following work carried out at an authorized Mercedes-Benz Center:

- work relevant to safety
- service and maintenance work
- repair work
- alterations, installation work and modifications
- work on electronic components

Correct use

WARNING

There are various warning stickers affixed to your vehicle. Their purpose is to alert you and others to various dangers. Therefore, do not remove any warning stickers unless the sticker clearly states that you may do so.

If you remove any warning stickers, you or others could fail to recognize certain dangers and be injured.

Observe the following information when driving your vehicle:

- the safety notes in this manual
- the "Technical data" section in this manual
- traffic rules and regulations
- laws and safety standards pertaining to motor vehicles

Problems with your vehicle

If you should experience a problem with your vehicle, particularly one that you believe may affect its safe operation, we urge you to contact an authorized Mercedes-Benz Center immediately to have the problem diagnosed and rectified. If the problem is not resolved to your satisfaction, please discuss the problem again with a Mercedes-Benz Center or contact us at one of the following addresses.

In the USA

Customer Assistance Center
Mercedes-Benz USA, LLC
One Mercedes Drive
Montvale, NJ 07645-0350

In Canada

Customer Relations Department
Mercedes-Benz Canada, Inc.
98 Vanderhoof Avenue
Toronto, Ontario M4G 4C9

Reporting safety defects

USA only:

The following text is reproduced as required of all manufacturers according to Title 49, Code of U.S. Federal Regulations, Part 575 pursuant to the National Traffic and Motor Vehicle Safety Act of 1966.

If you believe that your vehicle has a defect which could cause a crash or could cause injury or death, you should immediately inform the National Highway Traffic Safety Administration (NHTSA) in addition to notifying Mercedes-Benz USA, LLC.

If NHTSA receives similar complaints, it may open an investigation, and if it finds that a safety defect exists in a group of vehicles, it may order a recall and remedy campaign. However, NHTSA cannot become involved in individual problems between you, your dealer, or Mercedes-Benz USA, LLC.

To contact NHTSA, you may call the Vehicle Safety Hotline toll-free at

1-888-327-4236(TTY: 1-800-424-9153); go to <http://www.safercar.gov>; or write to: Administrator, NHTSA Headquarters, 1200 New Jersey Avenue, SE, West Building, Washington, DC 20590.

You can obtain additional information about vehicle safety from:

<http://www.safercar.gov>

Limited Warranty

! Follow the instructions in this manual about the proper operation of your vehicle as well as about possible vehicle damage. Damage to your vehicle that arises from culpable contraventions against these instructions is not covered either by the Mercedes-Benz Limited Warranty or by the New or Used-Vehicle Warranty.

Data stored in the vehicle

Information about electronic data acquisition in the vehicle

(Including notice pursuant to California Code § 9951)

Your vehicle records electronic data. If your vehicle is equipped with mbrace (Canada: TELE AID), data is transmitted in the event of an accident.

This information helps, for example, to test vehicle systems after an accident and to continually improve vehicle safety. Daimler AG can access this data and submit it:

- for safety research or vehicle diagnosis purposes
- with the consent of the vehicle owner
- on the instruction of prosecuting authorities
- for use in arbitration of disputes that involve Daimler AG, its affiliates or its sales and service organizations
- as otherwise required or permitted by law.

Please check your mbrace (Canada: TELE AID) purchase agreement to find out more about data that can be recorded and transmitted by this system.

Information on copyright

Registered trademarks

Registered trademarks:

- Bluetooth® is a registered trademark of Bluetooth SIG Inc.
- DTS is a registered trademark of DTS, Inc.
- Dolby and MLP are registered trademarks of DOLBY Laboratories.
- BabySmart™, ESP® and PRE-SAFE® are registered trademarks of Daimler AG.
- HomeLink® is a registered trademark of Prince.
- iPod® and iTunes® are registered trademarks of Apple Inc.
- Logic7® is a registered trademark of Harman International Industries.
- Microsoft® and Windows media® are registered trademarks of Microsoft Corporation.
- SIRIUS is a registered trademark of Sirius XM Radio Inc.
- HD Radio is a registered trademark of iBiquity Digital Corporation.
- Gracenote® is a registered trademark of Gracenote, Inc.
- ZAGATSurvey® and related brands are registered trademarks of ZagatSurvey, LLC.

FreeType

Portions of this software are copyright © 2005 The FreeType Project (www.freetype.org). All rights reserved. © 1996-2000 by David Turner, Robert Wilhelm, and Werner Lemberg.

Gnu compiler

Copyright © 1982, 1986 Regents of the University of California. All rights reserved.

The Berkeley software License Agreement specifies the terms and conditions for redistribution. Redistributions and use in source and binary forms, with or without modification, are permitted provided that the following conditions are met:

1. Redistribution of source code must retain the above copyright notice, this list of conditions and the following disclaimer.
2. Redistribution in binary form must reproduce the above copyright notice, this list of conditions and the following disclaimer in the documentation and/or other materials provided with the distribution.
3. All advertising materials mentioning features or use of this software must display the following acknowledgment: This product includes software developed by the University of California, Berkeley and its contributors.
4. Neither the name of the University nor the names of its contributors may be used to endorse or promote products derived from this software without specific prior written permission.

THIS SOFTWARE IS PROVIDED BY THE REGENTS AND CONTRIBUTORS "AS IS" AND ANY EXPRESS OR IMPLIED WARRANTIES, INCLUDING, BUT NOT LIMITED TO, THE IMPLIED WARRANTIES OF MERCHANTABILITY AND FITNESS FOR A PARTICULAR PURPOSE ARE DISCLAIMED. IN NO EVENT SHALL THE REGENTS OR CONTRIBUTORS BE LIABLE FOR ANY DIRECT, INDIRECT, INCIDENTAL, SPECIAL, EXEMPLARY, OR CONSEQUENTIAL DAMAGES (INCLUDING, BUT NOT LIMITED TO, PROCUREMENT OF SUBSTITUTE GOODS OR SERVICES; LOSS OF USE, DATA, OR PROFITS; OR BUSINESS INTERRUPTION) HOWEVER CAUSED AND ON ANY THEORY OF LIABILITY, WHETHER IN CONTRACT, STRICT

LIABILITY, OR TORT (INCLUDING NEGLIGENCE OR OTHERWISE) ARISING IN ANY WAY OUT OF THE USE OF THIS SOFTWARE, EVEN IF ADVISED OF THE POSSIBILITY OF SUCH DAMAGE.

Useful information	36
Panic alarm	36
Occupant safety	36
Child restraint systems	54
Driving safety systems	57
Theft deterrent locking system	65

Useful information

- i** This Operator's Manual describes all models and all standard and optional equipment of your vehicle available at the time of publication of the Operator's Manual. Country-specific differences are possible. Please note that your vehicle may not be equipped with all features described. This also applies to safety-related systems and functions.
- i** Read the information on qualified specialist workshops: (> page 31).

Panic alarm



- 1** **PANIC** button

- ▶ **To activate:** press **PANIC** button **1** for at least one second.
An alarm sounds and the exterior lighting flashes.
- ▶ To deactivate: **press** **PANIC** button **1** again.
- or
- ▶ Insert the SmartKey into the ignition lock.
- or
- ▶ Press the KEYLESS-GO Start/Stop button.
The KEYLESS-GO key must be in the vehicle.

- i** USA only:

This device complies with Part 15 of the FCC Rules. Operation is subject to the following two conditions:

1. This device may not cause interference, and
2. this device must accept any interference received, including interference that may cause undesired operation.

Any unauthorized modification to this device could void the user's authority to operate the equipment.

The product label with FCC ID and IC certification number can be found in the battery case of the SmartKey.

- i** Canada only:

This device complies with RSS-Gen of Industry Canada. Operation is subject to the following two conditions:

1. This device may not cause interference, and
2. this device must accept any interference received, including interference that may cause undesired operation.

Any unauthorized modification to this device could void the user's authority to operate the equipment.

The product label with FCC ID and IC certification number can be found in the battery case of the SmartKey.

Occupant safety

Important safety notes

⚠ WARNING

Modifications to or work improperly conducted on restraint system components or their wiring, as well as tampering with interconnected electronic systems, can lead to the restraint systems no longer functioning as intended.

Air bags or Emergency Tensioning Devices (ETDs), for example, could deploy inadvertently or fail to deploy in accidents although the deceleration threshold for air bag deployment is exceeded. Therefore, never modify the restraint systems. Do not

tamper with electronic components or their software.

In this section, you will learn the most important facts about the restraint system components of the vehicle.

The restraint system consists of:

- seat belts
- child restraint systems
- LATCH-type (ISOFIX) child seat anchors

Additional protection is provided by:

- SRS (Supplemental Restraint System)
- NECK-PRO head restraints
- PRE-SAFE®
- roll bar
- air bag system components with:
 -  indicator lamp
 - front-passenger seat with Occupant Classification System (OCS)

The different air bag systems work independently of each other. The protective functions of the system work in conjunction with each other. Not all air bags are always deployed in an accident.

- i** See "Children in the vehicle" for information on infants and children traveling with you in the vehicle restraint systems for infants and children (▷ page 54).

SRS (Supplemental Restraint System)

Introduction

SRS consists of:

- the  SRS warning lamp
- air bags
- the air bag control unit with crash sensors
- Emergency Tensioning Devices
- belt force limiters

SRS reduces the risk of occupants coming into contact with the vehicle's interior in the event of an accident. It can also reduce the

effect of the forces to which occupants are subjected during an accident.

SRS warning lamp

WARNING

The SRS self-check has detected a malfunction if the  SRS indicator lamp:

- does not light up at all
- does not go out after approximately four seconds after the engine is started
- lights up after the engine is started or while the vehicle is in motion

For your safety, Mercedes-Benz strongly recommends that you have the system checked as soon as possible at a qualified specialist workshop. SRS may otherwise fail to activate when it is needed in the event of an accident, which could lead to serious or fatal injuries. SRS might also be activated unexpectedly and unnecessarily, which could also result in injury.

In addition, work carried out improperly on SRS may render SRS inoperative or cause unintended air bag deployment. Work on the SRS system should only be carried out by qualified specialist personnel. Consult a qualified specialist workshop.

If it is necessary to modify an air bag system to accommodate a person with disabilities, contact an authorized Mercedes-Benz Center for details. USA only: for further information, contact our Customer Assistance Center at 1-800-FOR-MERcedes (1-800-367-6372).

The  SRS warning lamp in the instrument cluster lights up when the ignition is switched on. It goes out no later than a few seconds after the engine is started.

SRS functions are checked regularly when the engine is running. Therefore, malfunctions can be detected in good time.

The SRS components are in operational readiness when the SRS  indicator lamp goes out while the engine is running.

Safety guidelines for seat belts, Emergency Tensioning Devices (ETDs) and air bags

WARNING

- Damaged seat belts or seat belts that have been subjected to stress in an accident must be replaced. Their anchoring points must also be checked. Only use seat belts installed or supplied by an authorized Mercedes-Benz Center.
- Air bags and pyrotechnic Emergency Tensioning Devices (ETDs) contain perchlorate material, which may require special handling and regard for the environment. Check your national disposal guidelines. California residents, see www.dtsc.ca.gov/HazardousWaste/Perchlorate/index.cfm.
- Air bags and ETDs are designed to function on a one-time-only basis. An air bag or ETD that has deployed must be replaced.
- Do not pass seat belts over sharp edges. They could tear.
- Do not make any modification that could change the effectiveness of the seat belts.
- Do not bleach or dye seat belts as this may severely weaken them. In a crash they may not be able to provide adequate protection.
- No modifications of any kind may be made to any components or wiring of the SRS.
- Do not change or remove any component or part of the SRS.
- Do not install additional trim material, seat covers, badges, etc. over the steering wheel hub, front-passenger front air bag cover, outer sides of the seat backrests, door trim panels, or door frame trims.
- Do not install additional electrical/electronic equipment on or near SRS components and wiring.
- Keep area between air bags and occupants free of objects (e.g. packages, purses, umbrellas, etc.).

- Air bag system components will be hot after an air bag has inflated. Do not touch them.
- Never place your feet on the instrument panel, dashboard, or on the seat. Always keep both feet on the floor in front of the seat.
- Improper repair work on the SRS creates a risk of rendering the SRS inoperative or causing unintended air bag deployment. Work on the SRS must therefore only be performed by qualified technicians. Contact an authorized Mercedes-Benz Center.
- For your protection and the protection of others, when scrapping the air bag unit or ETD, our safety instructions must be followed. These instructions are available from any authorized Mercedes-Benz Center.
- Given the considerable deployment speed, required inflation volume, and the material of the air bags, there is the possibility of abrasions or other, potentially more serious injuries resulting from air bag deployment.

If you sell your vehicle, Mercedes-Benz strongly recommends that you inform the subsequent owner that the vehicle is equipped with SRS. Also, refer them to the applicable section in the Operator's Manual.

Air bags

Important safety notes

WARNING

Air bags are designed to reduce the incidence of injuries and fatalities in certain situations:

- frontal impacts (driver's and front-passenger front air bags and knee bags)
- side impacts (side impact air bags and head bags)
- rollover (head bags)

However, no system available today can completely eliminate injuries and fatalities.

When the air bags are deployed, a small amount of powder is released. The powder generally does not constitute a health hazard and does not indicate that there is a fire in the vehicle. In order to prevent potential breathing difficulties, you should leave the vehicle as soon as it is safe to do so. If you have any breathing difficulty but cannot get out of the vehicle after the air bag inflates, then get fresh air by opening a window or door.

WARNING

In order to reduce the potential danger of injuries caused during the deployment of the front air bags, the driver and front passenger must always be correctly seated and wear their seat belts.

For maximum protection in the event of a collision, you must always be in the normal seat position with your back against the backrest. Fasten your seat belt and make sure that it is correctly positioned on your body.

As the air bag inflates with considerable speed and force, a proper seating position and correct positioning of the hands on the steering wheel will help to keep you at a safe distance from the air bag. Occupants who are not wearing their seat belt, are not seated properly or are too close to the air bag can be seriously injured or killed by an air bag, as it inflates with great force instantaneously:

- sit with the seat belt fastened correctly and in a position that is as upright as possible with your back against the backrest.
- move the driver's seat as far back as possible, still permitting proper operation of vehicle controls. The distance from the center of the driver's chest to the middle of the air bag cover on the steering wheel must be at least 10 inches (25 cm). You should be able to accomplish this by adjusting the seat and steering wheel. If you have any difficulties, please contact a qualified specialist workshop.

- do not lean your head or chest close to the steering wheel or dashboard.
- only hold the steering wheel on the outside. Placing hands and arms inside the rim of the steering wheel can increase the risk and potential severity of hand/arm injuries if the air bag inflates.
- adjust the front-passenger seat as far back as possible from the dashboard when the seat is occupied.
- occupants, especially children, should never place their bodies or lean their heads in the area of the door where the side impact air bag and/or head bag inflates. This could result in serious injuries or death should the side impact air bag/head bag be deployed. Always sit as upright as possible, wear the seat belt properly and use an appropriately sized infant restraint, toddler restraint or booster seat recommended for the size and weight of the child.

Failure to follow these instructions can result in severe injuries to you or other occupants.

If you sell your vehicle, it is important that you make the buyer aware of this safety information. Be sure to give the buyer this Operator's Manual.

WARNING

If the side impact air bag and/or head bag is deployed in the event of a side impact and the front passenger, especially a child, is not properly seated or restrained when next to a side impact air bag/head bag, injuries are possible due to the rapid inflation of the side impact air bag/head bag.

To help avoid the possibility of injury, please follow these guidelines:

- (1) Always sit as upright as possible, and use the seat belts properly. Make sure that children 12 years old and under use an appropriately sized child restraint, infant restraint or booster seat

recommended for the size and weight of the child.

(2) Always wear seat belts properly.

If the air bags are deployed, you will hear a bang, and a small amount of powder may also be released. Only in rare cases will the bang affect your hearing. The powder that is released generally does not constitute a health hazard. The  SRS warning lamp lights up.

The air bags are deployed if the air bag control unit detects the need for deployment. Only in the event of such a situation will the air bags provide their supplemental protection.

If the driver and front passenger do not wear their seat belts, it is not possible for the air bags to provide their supplemental protection.

In the event of other types of impacts and impacts below air bag deployment thresholds, the air bags will not deploy. The driver and passengers will then be protected to the extent possible by a properly fastened seat belt. A properly fastened seat belt is also needed to provide the best possible protection in a rollover.

Air bags provide additional protection; they are not, however, a substitute for seat belts. All vehicle occupants must fasten their seat belts.

It is important for your safety and that of your passengers to have deployed air bags replaced and to have any malfunctioning air bags repaired. This will help to make sure the air bags continue to perform their protective function for the vehicle occupants in the event of a crash.

Front air bags



Driver's air bag ① deploys in front of the steering wheel; front-passenger front air bag ② deploys in front of and above the glove box.

The front air bags increase protection against head and chest injuries.

They are deployed:

- in the event of certain frontal impacts
- if the system determines that air bag deployment can offer additional protection to that provided by the seat belt
- depending on whether the seat belt is being used
- independently of other air bags in the vehicle

If the vehicle rolls over, the front air bags are generally not deployed. If the system detects high vehicle deceleration in a longitudinal direction, the front air bags are deployed.

Your vehicle has adaptive, two-stage front air bags. In the event of a collision, the air bag control unit evaluates the vehicle deceleration. In the first deployment stage, the front air bag is filled with enough propellant gas to reduce the risk of injuries. The front air bag is fully deployed if a second deployment threshold is exceeded within a few milliseconds.

The deployment of front-passenger front air bag ② is also influenced by the weight category of the front passenger, which is determined by the Occupant Classification System (OCS) (> page 43).

The lighter the passenger side occupant, the higher the vehicle deceleration rate required (predicted at the start of the impact) for second-stage inflation of the front-passenger front air bag. In the second stage, the front air bags are inflated with the maximum amount of propellant gas available.

The front air bags are not deployed in situations where a low impact severity is predicted. You will then be protected by the fastened seat belt.

Front-passenger front air bag ② will only deploy if:

- the system, based on the OCS weight sensor readings, has detected that the front-passenger seat is occupied.
- the  indicator lamp on the center console is not lit, (> page 43)
- the air bag control unit predicts a high impact severity.

Knee bags

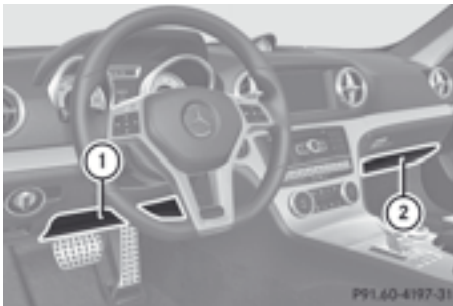

The driver's knee bag ① deploys underneath the steering column and front-passenger knee bag ② underneath the glove box. They deploy together with the front air bags. They are designed to operate together with the front air bags in frontal impacts if certain thresholds are exceeded. The knee bags operate at best in conjunction with correctly positioned and fastened seat belts.

Knee bags provide increased protection for the driver and front passenger against the risk of:

- knee injuries
- thigh injuries
- lower leg injuries

Side impact air bags

WARNING

The pressure sensors for side impact air bag control are located in the doors. Do not modify any components of the doors or door trim panels including, for example, the addition of door speakers.

Improper repair work on the doors or the modification or addition of components to the doors create a risk of rendering the side impact air bags inoperative or causing unintended air bag deployment. Work on the doors must therefore only be performed by qualified technicians. Contact an authorized Mercedes-Benz Center.

WARNING

Only use seat covers which have been tested and approved by Mercedes-Benz for your vehicle model. Using other seat covers may interfere with or prevent the deployment of the side impact air bags. Contact an authorized Mercedes-Benz Center for availability.



Example: side impact air bag on the driver's side side impact air bags ① deploy next to the outer side bolsters of the seat backrest.

When deployed, side impact air bags ① offer additional protection for the thorax of the vehicle occupants on the side of the vehicle on which the impact occurs. However, they do not protect the:

- head
- neck
- arms

side impact air bags ① are deployed:

- on the side on which an impact occurs
- at the start of an accident with a high rate of lateral vehicle deceleration or acceleration, e.g. in a side impact
- depending on whether the seat belt is being used
- independently of the front air bags
- independently of the ETDs

If the vehicle rolls over, side impact air bags ① are generally not deployed. side impact air bags ① are deployed if the system detects high vehicle deceleration or acceleration in a lateral direction and determines that side impact air bag deployment can offer additional protection to that provided by the seat belt.

side impact air bags ① will not deploy in side impacts which do not exceed the system's preset deployment thresholds for lateral acceleration/deceleration. You will then be protected by the fastened seat belt.

If OCS detects that the front-passenger seat is not occupied and the front-passenger seat belt is not fastened, side impact air bag ① on the front-passenger side will not deploy. side impact air bag ① on the front-passenger side will deploy if the front-passenger seat belt is fastened, regardless of whether the front-passenger seat is occupied or not.

Head bags

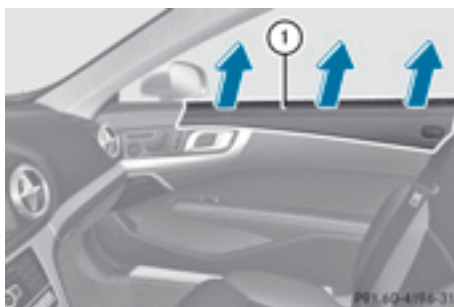

Example: head bag on the front-passenger side

Head bags ① enhance the level of protection for the head, but not chest or arms, of the vehicle occupants on the side of the vehicle on which the impact occurs.

Head bags ① deploy in the area of the side windows at the front. They are deployed:

- at the start of an accident with a high rate of lateral vehicle deceleration or acceleration, e.g. in a side impact
- on the side on which an impact occurs
- on the driver's side and passenger side, in the event of a vehicle rollover and if the system determines that air bag deployment can offer the vehicle occupants additional protection to that provided by the seat belt
- independently of the use of the seat belt
- independently of the front air bags

Head bags ① will not deploy in side impacts which do not exceed the system's preset deployment thresholds for lateral acceleration/deceleration. You will then be protected by the fastened seat belt.

If OCS detects that the front-passenger seat is not occupied and the front-passenger seat belt is not fastened, head bag ① on the front-passenger side will not deploy. Head bag ① on the front-passenger side will deploy if the front-passenger seat belt is fastened, regardless of whether the front-passenger seat is occupied or not.

Roll bar

DANGER

If the roll bar is malfunctioning, the  Malfunction Service Required message appears in the multifunction display. The roll bars will then possibly not be extended in the event of an accident. This could result in severe or even fatal injuries to you and other occupants. In this case, visit a qualified specialist workshop immediately and have the roll bar checked.

WARNING

If you place objects or clothing on the roll bar covers, these could impair roll bar extension. You and others could be injured by objects being thrown around when the roll bars are triggered. Ensure that the area above the roll bar covers is kept clear. Stow objects or clothing in a secure place.

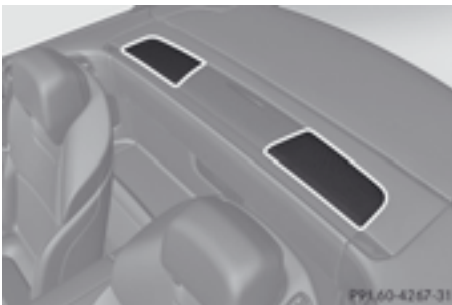

The roll bars are located in the rear area of the vehicle under the two outer rear compartment trim covers.



The roll bars are extended automatically if systems detect that the vehicle is in danger of rolling over. The two rear compartment trim covers are opened and the roll bars are extended within fractions of a second.

Once the roll bars are extended, you can no longer lower them. An open roof can no longer be closed. In this case, visit the nearest qualified specialist workshop.

Occupant Classification System (OCS)

Method of operation

WARNING



If the  PASSENGER AIR BAG OFF indicator lamp illuminates when an adult or someone larger than a small individual is in the front-passenger seat, have the front passenger reposition himself or herself in the seat until the  PASSENGER AIR BAG OFF indicator lamp goes out.

In the event of a collision, the air bag control unit will not allow front-passenger front air bag and front-passenger knee bag deployment when the OCS has classified the front-passenger occupant as weighing as much as or less than a typical 12 month old child in a standard child restraint or if the front-passenger seat is classified as being unoccupied.

When the OCS senses that the front-passenger seat occupant is classified as being up to or less than the weight of a typical 12-month-old child in a standard child restraint, the  PASSENGER AIR BAG OFF indicator lamp will illuminate when the engine is started and remain illuminated. This indicates that the front-passenger front air bag and the front-passenger knee bag are deactivated.

When the OCS senses that the front-passenger seat is classified as being empty, the  PASSENGER AIR BAG OFF indicator lamp will illuminate when the engine is started and remain illuminated. This indicates that the front-passenger front air bag and the front-passenger knee bag are deactivated.

When the OCS senses that the front-passenger seat occupant is classified as being heavier than the weight of a typical 12-month-old child seated in a standard child restraint or as being a small individual (such as a young teenager or a small adult), the  PASSENGER AIR BAG OFF indicator lamp will illuminate for approximately 6

seconds when the engine is started. Depending on occupant weight sensor readings from the seat, it will then remain illuminated or go out. If the  PASSENGER AIR BAG OFF indicator lamp is illuminated, the front-passenger front air bag and the front-passenger knee bag are deactivated. If the  PASSENGER AIR BAG OFF indicator lamp is not illuminated, the front-passenger front air bag and the front-passenger knee bag are activated.

When the OCS senses that the front-passenger seat occupant is classified as an adult or someone larger than a small individual, the  PASSENGER AIR BAG OFF indicator lamp will illuminate for approximately six seconds when the engine is started and then go out. This indicates that the front-passenger front air bag and the front-passenger knee bag are activated.

If the  PASSENGER AIR BAG OFF indicator lamp is illuminated, the front-passenger front air bag and the front-passenger knee bag are deactivated and are not deployed.

If the  PASSENGER AIR BAG OFF indicator lamp is not illuminated, the front-passenger front air bag and the front-passenger knee bag are activated and are deployed:

- in certain front impacts
- independently of the side impact air bag and head bag
- if the impact has exceeded a predetermined threshold value for deployment

If the front-passenger front air bag is deployed, the rate of inflation will be influenced by:

- the rate of vehicle deceleration as assessed by the air bag control unit
- the front passenger's weight category as determined by the OCS

WARNING





Children under 12 years must be secured correctly in a suitable infant or child restraint system or booster seat suitable for the size and weight of the child.

The infant or child restraint must be properly secured with the vehicle's seat belt fully in accordance with the child seat manufacturer's instructions.

Occupants, in particular children, must sit as upright as possible, fasten the seat belt correctly and use a suitable infant restraint system, child restraint system or booster seat suitable for the size and weight of the child.

Children can be seriously or even fatally injured by an air bag deploying.



Observe the following information:

- Your vehicle is equipped with air bag technology designed to deactivate the front-passenger front air bag and the front-passenger knee bag in your vehicle when the system senses the weight of a typical 12-month-old child or less along with the weight of a standard appropriate child restraint on the front-passenger seat.
- A child in a rear-facing child restraint system on the front-passenger seat will be seriously injured or even killed if the front-passenger front air bag inflates in a collision despite the air bag technology installed in your vehicle, which could occur under some circumstances.
- If you must install a rearward-facing child restraint on the front-passenger seat, make sure the  PASSENGER AIR BAG OFF indicator lamp is illuminated, indicating that the front-passenger front air bag and front-passenger knee bag are deactivated. If the  PASSENGER AIR BAG OFF indicator lamp does not light up or goes out when a rearward-facing child restraint system is installed, please check installation. Periodically check the  PASSENGER AIR BAG OFF indicator lamp while driving to make sure the 

PASSENGER AIR BAG OFF indicator lamp is illuminated. If the  PASSENGER AIR BAG OFF indicator lamp goes out or remains out do not carry a child on the front-passenger seat.

- A child in a rearward-facing child restraint system on the front-passenger seat will be seriously injured or even killed if the front-passenger air bag is deployed.
- When securing a child in a child restraint system on the front-passenger seat, you must:
 - move the front-passenger seat as far back as possible
 - use a child restraint system that is suitable for the age, size and weight of the child
 - observe the manufacturer's installation instructions in order to install and secure the child restraint system correctly.
- For children larger than the typical 12-month-old child, the front-passenger air bag may or may not be activated.

WARNING

If the red  SRS warning lamp in the instrument cluster and the  PASSENGER AIR BAG OFF indicator lamp light up simultaneously, the OCS is malfunctioning. The front-passenger front air bag and the front-passenger knee bag will be deactivated in this case. Have the system checked as soon as possible by qualified technicians. Consult an authorized Mercedes-Benz Center.

Only have the seat repaired at an authorized Mercedes-Benz Center.

In order to ensure correct operation of the air bag system and OCS:

- sit with the seat belt fastened correctly and in a position that is as upright as possible with your back against the backrest.
- while seated, an occupant should not position themselves in such a way as to cause their weight to be lifted from the seat cushion as this may result in OCS being

unable to correctly assess the occupant's weight category.



- read and observe all warnings in this section.



If the key has been removed from the ignition lock or is in position **0**, the  indicator lamp **①** does not light up.

The  indicator lamp **②** is inoperative. It lights up briefly when the ignition is switched on and then goes out again.

The Occupant Classification System (OCS) categorizes the occupant on the front-passenger seat using a weight sensor. The front-passenger front air bag and the front-passenger knee bag are deactivated automatically for certain weight categories.

The  indicator lamp **①** shows you the current status. If the  indicator lamp **①** lights up, the front-passenger air bag and the front-passenger knee bag are disabled.

The system does not deactivate:

- the side impact air bag
 - the front-passenger head bag
 - the Emergency Tensioning Devices
- To be classified correctly, the front passenger must sit:

- with the seat belt fastened correctly
- in a position that is as upright as possible with their back against the seat backrest
- with their feet on the floor

The OCS weight sensor reading is affected if the occupant's weight is transferred, e.g. by leaning on the armrest.

If the front-passenger seat, the seat cover or the seat cushion are damaged, have the necessary repair work carried out at a qualified specialist workshop.

Mercedes-Benz recommends that you only use seat accessories which have been approved by Mercedes-Benz.

Both the driver and the front passenger should observe the  indicator lamp ① to determine whether or not the front passenger is positioned correctly.

If the driver's air bag deploys, this does not mean that the front-passenger front air bag will also deploy.

The OCS may have detected that the seat:

- is empty or occupied by the weight of a typical child up to twelve months old, seated in a child restraint system
- is occupied by a small individual, such as a young teenager or a small adult
- is occupied by a child in a child restraint system whose weight is greater than that of a typical twelve month old child.

These are examples of when the OCS deactivates the front-passenger front air bag and front-passenger knee bag. Deactivation takes place although the collision fulfills the criteria for deploying the driver's air bag.

System self-test

WARNING

If the  PASSENGER AIR BAG OFF indicator lamp does not illuminate, the system is not functioning. Consult an authorized Mercedes-Benz Center before seating a child on the front-passenger seat.

WARNING

Never place anything between seat cushion and child seat (e.g. a pillow), since it reduces the effectiveness of the OCS. The underside

and rear side child restraint system must be placed entirely on the seat cushion and the backrest of the front-passenger seat backrest.

If necessary, adjust the tilt of the passenger seat backrest.



An incorrectly mounted child seat could cause injuries to the child in case of an accident, instead of increasing protection for the child.

Follow the manufacturer's instructions for installation of child restraint systems.

The  indicator lamp lights up:

- if you turn the SmartKey in the ignition lock to position **1** or **2**
- if you press the KEYLESS-GO Start/Stop button once or twice on vehicles with KEYLESS-GO
- if an adult is seated properly on the front-passenger seat and the OCS classifies the occupant as an adult

The  indicator lamp goes out after approximately 6 seconds.

If the seat is not occupied and the OCS detects that the front-passenger seat is empty, the  indicator lamp will continue to light up. The  front-passenger front air bag warning lamp then stays lit continuously.

For more information about the OCS, see "Problems with the Occupant Classification System" (▷ page 47).

Problems with the occupant classification system



WARNING

If the  PASSENGER AIR BAG OFF indicator lamp illuminates and remains illuminated when the weight of a typical adult or an individual that is the size of a typical adult has been detected on the front-passenger seat, do not allow any occupant to use the front-passenger seat until the system has been repaired.

WARNING

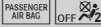
If the  PASSENGER AIR BAG OFF indicator lamp does not illuminate or remains out with the weight of a typical 12-month-old child in a standard child restraint or less, or is unoccupied, on the front-passenger seat, do not transport a child on the front-passenger seat until the system has been repaired.

Problem	Possible causes/consequences and ► Solutions
<p>The  indicator lamp lights up and stays on.</p> <p>The person on the front-passenger seat:</p> <ul style="list-style-type: none"> • has the weight of a typical adult • has been determined by the system not to be a child 	<p>The OCS is malfunctioning.</p> <ul style="list-style-type: none"> ► Have the OCS checked as soon as possible at a qualified specialist workshop. ► Observe the additional messages in the multifunction display (▷ page 234).

Problem	Possible causes/consequences and ► Solutions
<p>The  indicator lamp does not light up and/or does not stay on.</p> <p>The front-passenger seat is:</p> <ul style="list-style-type: none"> • unoccupied • occupied with a weight up to that of a typical twelve-month-old child in a standard child restraint system 	<p>The OCS is malfunctioning.</p> <ul style="list-style-type: none"> ► Make sure there is nothing between the seat cushion and the child seat. ► Check the installation of the child restraint system. ► Make sure that no objects are applying additional weight onto the seat. ► If the  indicator lamp remains off, have the OCS checked as soon as possible at a qualified specialist workshop. Do not transport a child on the front-passenger seat as long as the OCS is not functioning. ► Observe the additional messages in the multifunction display (▷ page 234).

PRE-SAFE® (preventative occupant protection)

WARNING

Make sure that nobody can become trapped as you adjust the seat.

WARNING

The PRE-SAFE® system reduces the impact of an accident on vehicle occupants, as long as their seat belts have been fastened correctly. Although your vehicle is equipped with a PRE-SAFE® system, the possibility of injury in the event of an accident cannot be ruled out. You should therefore always drive carefully and adapt your driving style to the prevailing road, weather and traffic conditions.

-  Make sure that there are no objects in the footwell or behind the seats when resetting the seats. There is a risk that the seats and/or the objects could be damaged.

PRE-SAFE® takes preemptive measures to protect occupants in certain hazardous situations.

PRE-SAFE® intervenes:

- if BAS intervenes, e.g. in emergency braking situations
- when BAS PLUS intervenes powerfully on vehicles with DISTRONIC PLUS.
- when the radar sensor system detects an imminent danger of collision in certain situations on vehicles with DISTRONIC PLUS.
- in critical driving situations, e.g. when physical limits are exceeded and the vehicle understeers or oversteers severely

PRE-SAFE® takes the following measures depending on the hazardous situation detected:

- the seat belts are pre-tensioned.
- the front-passenger seat is adjusted if it is in an unfavorable position.
- vehicles with a multicontour seat or active multicontour seat: the air pressure in the

side bolsters of the seat cushion and backrest is increased.

- if the vehicle skids, the side windows are closed almost completely.

If the hazardous situation passes without resulting in an accident, PRE-SAFE® slackens the belt pretensioning. All settings made by PRE-SAFE® can then be reversed.

If the seat belts are not released:

- ▶ Move the backrest or seat back slightly, but only when the vehicle is stationary. The belt pretensioning is reduced and the locking mechanism is released.

More information about seat belt adjustment, a convenience function integrated into PRE-SAFE (▷ page 52).

NECK-PRO head restraints

Introduction

WARNING

Do not secure any objects (e.g. coat hangers) on the NECK-PRO head restraints. Otherwise, the NECK-PRO head restraints may not function properly, or in the event of a rear-end collision may not be able offer the level of protection they are designed to provide.

WARNING

Seat or head restraint covers can cause a malfunction when the NECK-PRO head restraints are activated or when the side impact air bags are deployed, or they can prevent this completely. The NECK-PRO head restraints or side impact air bags can therefore not provide the intended protection. Do not use any seat or head restraint covers.

WARNING

For your protection, drive only with properly positioned head restraints. Adjust the head restraint so that it is as close to the head as possible and the center of the head restraint supports the back of the head

at eye level. This will reduce the potential for injury to the head and neck in the event of an accident or similar situation.

The NECK-PRO head restraints reduce the likelihood of head and chest injuries. The NECK-PRO head restraints on the driver's and front-passenger seats are moved forwards and upwards in the event of a rear-end collision of a certain severity. This provides better head support.

If the NECK-PRO head restraints have been triggered in an accident, reset the NECK-PRO head restraints on the driver's and front-passenger seat (▷ page 49). Otherwise, the additional protection will not be available in the event of another rear-end collision. You can recognize when NECK-PRO head restraints have been triggered by the fact that they have moved forwards and can no longer be adjusted.

Resetting triggered NECK-PRO head restraints

WARNING

For safety reasons, have the NECK-PRO head restraints checked at a qualified specialist workshop after a rear-end collision.

WARNING

When pushing back the NECK-PRO head restraint cushion, make sure your fingers do not become caught between the head restraint cushion and the cover. Failure to observe this could result in injuries.



- ▶ Tilt the top of the NECK-PRO head restraint cushion forwards in the direction of arrow ①.
- ▶ Push the NECK-PRO head restraint cushion down in the direction of arrow ② as far as it will go.
- ▶ Firmly push the NECK-PRO head restraint cushion back in the direction of arrow ③ until the cushion engages.
- ▶ Repeat this procedure for the second NECK-PRO head restraint.

i Resetting the NECK-PRO head restraints requires a lot of strength. If you have difficulty resetting the NECK-PRO head restraints, have this work carried out at a qualified specialist workshop.

Seat belts

Important safety notes

WARNING

Always fasten your seat belt before driving off. Always make sure your passenger is properly restrained. You and your passenger should always wear seat belts.

Failure to wear and properly fasten and position your seat belt considerably increases your risk of injuries and their likely severity in an accident.

If you are ever in an accident, your injuries could be considerably more severe if you have not fastened your seat belt correctly. If you do not fasten your seat belt, you are much more likely to collide with parts of the vehicle interior or be ejected from it. This may result in serious or fatal injury.

In the same crash, the possibility of serious or fatal injury is considerably reduced if you wear your seat belt properly. The air bags can only offer the intended protection if the occupants are wearing their seat belts properly.

⚠ WARNING

Never ride in a moving vehicle with the seat backrest in an excessively reclined position as this can be dangerous. You could slide under the seat belt in a collision. If you slide under it, the seat belt would apply force at the abdomen or neck. That could cause serious or even fatal injuries. The seat backrest and seat belt provide the best restraint when the wearer is in a position that is as upright as possible and the seat belt is properly positioned on the body.

⚠ WARNING

Never let more people ride in the vehicle than there are seat belts available. Make sure everyone riding in the vehicle is correctly restrained with a separate seat belt. Never use a seat belt for more than one person at a time.

⚠ WARNING

Always have damaged seat belts or seat belts that have been subjected to a load in an accident replaced and the anchorages checked.

Only use seat belts that have been approved by Mercedes-Benz.

Never tamper with seat belts. This can result in the unintended deployment of the Emergency Tensioning Devices or the failure to deploy when necessary.

Do not bleach or dye seat belts, as this may severely weaken them. In the event of a collision, they may be unable to provide adequate protection.

Have all work carried out only by qualified technicians. Consult a qualified specialist workshop.

The use of seat belts and infant and child restraint systems is required by law in:

- all 50 states
- U.S. territories
- the District of Columbia
- all Canadian provinces

Even where this is not required by law, all vehicle occupants should correctly fasten their seat belts before starting the journey.

- **i** See "Children in the vehicle" (> page 54) for further information on infants and children traveling in the vehicle as well as on child restraint systems.

Proper use of the seat belts**⚠ WARNING****USE SEAT BELTS PROPERLY**

- Seat belts can only work when used properly. Never wear seat belts in any other way than as described in this section, as that could result in serious injuries in the event of an accident.
- Each occupant should wear their seat belt at all times, because seat belts help reduce the likelihood of and potential severity of injuries in accidents, including rollovers. The integrated restraint system includes SRS (driver front air bag, knee bags, front-passenger front air bag, side impact air bags, head air bags), Emergency Tensioning Devices (ETDs) and seat belt force limiters. The system is designed to enhance the protection offered to properly belted occupants in certain frontal (front air bags, knee bags and ETDs) and side (side impact air bags, head air bags and ETDs) impacts which exceed preset deployment thresholds.
- Never wear the shoulder belt under your arm, across your neck or off your shoulder. In a frontal crash, your body would move too far forward. That would increase the chance of head and neck injuries. The seat belt would also apply too much force to the ribs or abdomen, which could severely injure internal organs such as your liver or spleen.

Adjust the seat belt so that the shoulder section is located as close as possible to the middle of the shoulder (it should not touch the neck).

- Position the lap belt as low as possible on your hips and not across the abdomen. If the lap belt is positioned across your abdomen, it could cause serious injuries in a crash.
- Never wear seat belts over rigid or breakable objects in or on your clothing, such as eyeglasses, pens, keys etc., as these might cause injuries.
- Make sure the seat belt is always fitted snugly. Take special care of this when wearing loose clothing.
- Never use a seat belt for more than one person at a time. Do not fasten a seat belt around a person and another person or other objects at the same time.
- Seat belts should not be worn twisted. In a crash, you would not have the full width of the seat belt to distribute impact forces. The twisted seat belt against your body could cause injuries.
- Pregnant women should also always use a lap-shoulder belt. The lap belt portion should be positioned as low as possible on the hips to avoid any possible pressure on the abdomen.
- Place the seat backrest in a position that is as upright as possible.
- Check your seat belt during travel to make sure it is properly positioned.
- Never place your feet on the instrument panel, dashboard, or on the seat. Always keep both feet on the floor in front of the seat.
- When using a seat belt to secure infant restraints, toddler restraints, or children in booster seats, always follow the child seat manufacturer's instructions.

WARNING

Do not pass seat belts over sharp edges. They could tear.

Do not allow the seat belt to get caught in the door or in the seat adjustment mechanism. This could damage the seat belt.

Never attempt to make modifications to seat belts. This could impair the effectiveness of the seat belts.

Fastening seat belts

WARNING

Children 12 years old and under must be seated and properly secured in an appropriately sized infant restraint, child restraint system, or booster seat recommended for the size and weight of the child. For additional information, see the "Children in the vehicle" section.

A child's risk of serious or fatal injuries is significantly increased if the child restraints are not properly secured in the vehicle and/or the child is not properly secured in the child restraint.

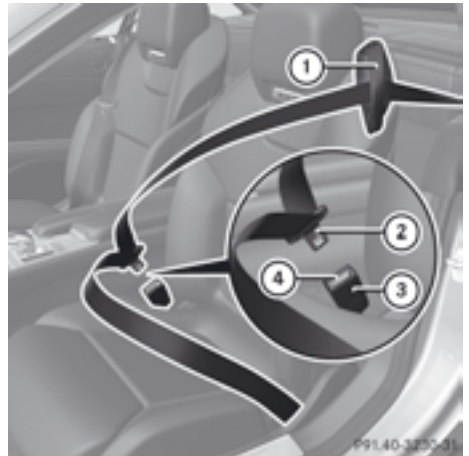

- ▶ Adjust the seat and move the backrest to an almost vertical position (▷ page 96).
- ▶ Pull the seat belt smoothly through seat belt guide ①.
- ▶ Without twisting it, guide the shoulder section of the seat belt across the middle of your shoulder and the lap section across your hips.

- ▶ Engage belt tongue ② in buckle ③.
Seat-belt adjustment: if necessary, the driver's and front-passenger seat belts automatically adjust to the upper body (▷ page 52).
- ▶ If necessary, pull upwards on the shoulder section of the seat belt to tighten the belt across your body.

The seat belt on the front-passenger side is equipped with a special seat belt retractor to secure a child restraint system properly to the front-passenger seat. Further information on the "special seat belt retractor" (▷ page 56).

For more information about releasing the seat belt with release button ④, see "Releasing seat belts" (▷ page 52).

Seat belt adjustment

The seat-belt adjustment function adjusts the driver's and front-passenger seat belt to the upper body of the occupants.

The belt strap is tightened slightly when:

- you engage the belt tongue in the belt buckle and you then turn the SmartKey to position 2 in the ignition lock.
- the SmartKey is in position 2 in the ignition lock and you then engage the belt tongue in the buckle.

The seat-belt adjustment will apply a retraction force if any slack is detected between the occupant and the seat belt. Do not hold on to the seat belt tightly while it is adjusting. You can switch the seat-belt adjustment on and off in the on-board computer (▷ page 219).

The seat-belt adjustment is an integral part of the PRE-SAFE® convenience function. Further information on PRE-SAFE® (Pre-Crash Safety System) (▷ page 48).

Releasing seat belts

- ❗ Make sure that the seat belt is fully rolled up. Otherwise, the seat belt or belt tongue

will be trapped in the door or in the seat mechanism. This could damage the door, the door trim panel and the seat belt. Damaged seat belts can no longer fulfill their protective function and must be replaced. Visit a qualified specialist workshop.

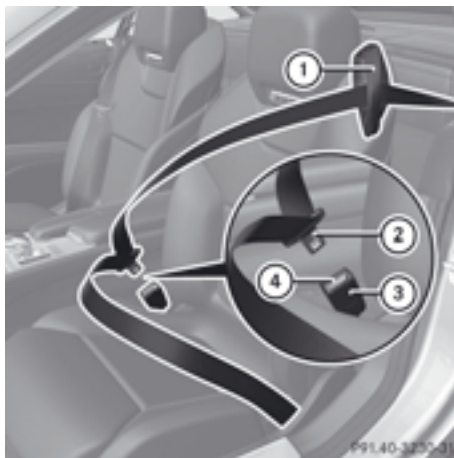

- ▶ Press release button ④ on belt buckle ③.
- ▶ Guide belt tongue ② back to seat belt guide ①.

Belt warning for the driver and front passenger

Regardless of whether the driver's and front-passenger seat belts have already been fastened, the  seat belt warning lamp lights up for six seconds each time the engine is started. It then goes out if the driver and the front passenger have fastened their seat belts.

If the driver's seat belt is not fastened when the engine is started, an additional warning tone will sound. The warning tone goes out after approximately six seconds or once the driver's seat belt is fastened.

If after six seconds the driver or front passenger have not fastened their seat belts and the doors are closed, the  seat belt warning lamp lights up:

- until the driver's or front passenger's seat belt is fastened
- if a vehicle speed of 15 mph (25 km/h) is exceeded, a warning tone also sounds with increasing intensity for a maximum of 60 seconds or until the driver or front passenger have fastened their seat belts.

If the driver/front passenger unfasten their seat belt while the vehicle is in motion, the  seat belt warning lamp lights up and a warning tone sounds again.

The warning tone ceases even if the driver or front passenger have still not fastened their seat belt after 60 seconds. The  seat belt warning lamp stops flashing but remains illuminated.

After the vehicle comes to a standstill, the warning tone is reactivated and the  seat belt warning lamp flashes again if the vehicle speed again exceeds 15 mph (25 km/h).

The  seat belt warning lamp only goes out if:

- both the driver and the front passenger have fastened their seat belts.
or
- the vehicle is stationary and a door is open.

i For more information on the  seat belt warning lamp, see "Warning and indicator lamps in the instrument cluster, seat belt" (▷ page 256).

Emergency Tensioning Devices, belt force limiters

WARNING

Pyrotechnic ETDs that were activated must be replaced.

For your safety, when disposing of the pyrotechnic ETDs always follow our safety instructions. These are available at any authorized Mercedes-Benz Center.

! If the front-passenger seat is not occupied, do not engage the seat belt tongue in the buckle on the front-passenger seat. Otherwise, the Emergency Tensioning Device could be triggered in the event of an accident.

The seat belts are equipped with Emergency Tensioning Devices and belt force limiters.

The ETDs tighten the seat belts in an accident, pulling them close against the body.

The ETDs do not correct incorrect seat positions or incorrectly fastened seat belts.

The ETDs do not pull vehicle occupants back towards the backrest.

When triggered, seat belt force limiters help to reduce the peak force exerted by the seat belt on the vehicle occupant.

The seat belt force limiters are synchronized with the front air bags, which take on a part of the deceleration force. Thus, the force exerted on the occupant is distributed over a greater area.

The ETDs can only be activated when:

- the ignition is switched on.
- the restraint systems are operational; see "SRS warning lamp" (▷ page 37).
- the belt tongue is engaged in the buckle on each of the three-point seat belts.

The ETDs are triggered depending on the type and severity of an accident:

- if, in the event of a head-on or rear-end collision, the vehicle decelerates or accelerates rapidly in a longitudinal direction during the initial stages of the impact
- if, in the event of a side impact, on the side opposite the impact the vehicle decelerates or accelerates rapidly in a lateral direction
- if, in certain situations where the vehicle overturns, the system determines that it can provide additional protection

If the ETDs are deployed, you will hear a bang, and a small amount of powder may also be

released. Only in rare cases will the bang affect your hearing. The powder that is released generally does not constitute a health hazard. The  SRS warning lamp lights up.

Child restraint systems

Important safety notes

WARNING



Children 12 years old and under must be seated and properly secured in an appropriate infant restraint, toddler restraint, or booster seat recommended for the size and weight of the child.

The infant or child restraint system must be correctly secured using the vehicle's seat belt in complete accordance with the child seat manufacturer's instructions.

Occupants, in particular children, must sit as upright as possible, fasten the seat belt correctly and use a suitable infant restraint system, child restraint system or booster seat suitable for the size and weight of the child.

Children can be seriously or even fatally injured by an air bag deploying. Observe the following information:

- Your vehicle is equipped with air bag technology designed to deactivate the front-passenger front air bag in your vehicle when the system senses the weight of a typical 12-month-old child or less along with the weight of a standard appropriate child restraint on the passenger seat.
- A child in a rearward-facing child restraint system on the front-passenger seat could be seriously injured or even killed if the front-passenger air bag inflates in a collision despite the air bag technology installed in your vehicle, which could occur under some circumstances.
- If you install a rearward-facing child restraint on the front-passenger seat, make sure that the  PASSENGER AIR BAG OFF indicator lamp is illuminated,

indicating that the front-passenger front air bag is deactivated. Should the  PASSENGER AIR BAG OFF indicator lamp not illuminate or go out while a rearward-facing child restraint system is installed, please check installation. Periodically check the  PASSENGER AIR BAG OFF indicator lamp while driving to make sure it is illuminated. If the  PASSENGER AIR BAG OFF indicator lamp goes out or remains out, do not transport a child on the front-passenger seat.

- A child in a rearward-facing child restraint system on the front-passenger seat can be seriously injured or even killed if the front-passenger air bag is deployed.
- When securing a child in a child restraint system on the front-passenger seat, you must:
 - move the front-passenger seat as far back as possible
 - use a child restraint system that is suitable for the age, size and weight of the child
 - observe the manufacturer's installation instructions in order to install and secure the child restraint system correctly.
- For children larger than the typical 12-month-old child, the front-passenger front air bag may or may not be activated.

WARNING

Infants and small children should never share a seat belt with another occupant. In the event of an accident, they could be crushed between the occupant and seat belt.

A child's risk of serious or fatal injuries is significantly increased if the child restraints are not properly secured in the vehicle and/or the child is not properly secured in the child restraint.

Children that are too large for a child restraint must travel in seats using normal seat belts. Position the shoulder belt across the chest and shoulder, not face or neck. A booster seat may be necessary to achieve proper seat belt

positioning for children over 41 lb (18 kg) until they reach a height where a lap-shoulder belt fits properly without a booster.

When the child restraint is not in use, remove it from the vehicle or secure it with the seat belt to prevent the child restraint from becoming a projectile in the event of an accident.

WARNING

When leaving the vehicle, always remove the SmartKey from the ignition lock. Always take the SmartKey with you and lock the vehicle. Do not leave children unattended in the vehicle, even if they are secured in a child restraint system, or with access to an unlocked vehicle. A child's unsupervised access to a vehicle could result in an accident and/or serious personal injury. The children could:

- injure themselves on parts of the vehicle
- be seriously or fatally injured through excessive exposure to extreme heat or cold
- injure themselves or cause an accident with vehicle equipment that can be operated even if the SmartKey is removed from the ignition lock or removed from the vehicle, such as seat adjustment, steering wheel adjustment, or the memory function

If children open a door, they could injure other persons or get out of the vehicle and injure themselves or be injured by following traffic.

Do not expose the child restraint system to direct sunlight. The child restraint system's metal parts, for example, could become very hot, and the child could be burned on these parts.

WARNING

Do not carry heavy or hard objects in the passenger compartment unless they are firmly secured in place.

Unsecured or improperly positioned cargo increases a child's risk of injury in the event of:

- strong braking maneuvers
- sudden changes of direction
- an accident

If an infant or child is traveling in the vehicle:

- ▶ Secure the child with a child or infant seat restraint system appropriate to the age and weight of the child.
- ▶ Make sure that the infant or child is properly secured at all times while the vehicle is in motion.

Mercedes-Benz recommends that you always properly secure all infants and children with a child or infant seat restraint system for the trip.

The use of seat belts and infant and child restraint systems is required by law in:

- all 50 states
- U.S. territories
- the District of Columbia
- all Canadian provinces

Infants and children must always be seated in an appropriate infant or child restraint system recommended for the size and weight of the child. The infant or child restraint system must be properly secured with a three-point seat belt in accordance with the manufacturer's instructions.

All infant or child restraint systems must meet the following standards:

- U.S. Federal Motor Vehicle Safety Standards 213 and 225
- Canadian Motor Vehicle Safety Standards 213 and 210.2

An information label on the child restraint system indicates whether it meets these standards. This information is also provided in the installation instructions supplied with the child restraint system.

Always read and follow the manufacturer's instructions when using an infant or child restraint system or booster seat.

Observe the warning labels in the vehicle interior or on the infant or child restraint.

- Further information on secure stowage of loads can be found in the "Stowage areas" section (▷ page 474).

LATCH-type (ISOFIX) child seat securing system

WARNING

Children that are too large for a child restraint must travel in seats using normal seat belts. Position the shoulder belt across the chest and shoulder, not face or neck.

A booster seat may be necessary to achieve proper seat belt positioning for children over 41 lb (18 kg) until they reach a height where a lap/shoulder belt fits properly without a booster.

Install the child restraint system in accordance with the manufacturer's instructions.

Attach the child restraint system to both securing rings.

An incorrectly installed child restraint system could come loose during an accident and seriously or even fatally injure the child.

Child restraint systems or child seat securing rings that are malfunctioning or damaged as the result of a collision must be replaced.



ISOFIX is a standardized securing system for specially designed child restraint systems. Securing rings ① for a LATCH-type (ISOFIX) child restraint system are installed to the front-passenger seat.

Secure child restraint systems without a LATCH-type (ISOFIX) child seat securing system using the seat belts in the vehicle. When installing child restraint systems, you must observe the manufacturer's installation instructions.

- ▶ Install the LATCH-type (ISOFIX) child seat securing system. Comply with the manufacturer's instructions when installing.

Special seat belt retractor

WARNING

If you release the seat belt when driving, the special seat belt retractor is deactivated.

The released seat belt cannot be engaged again while driving, because the inertia reel pulls in the seat belt a small distance. The child restraint system is no longer properly secured. There is an increased risk of serious injury or even fatal injury.

Always keep the seat belt of the activated special seat belt retractor engaged when driving.

The seat belt on the front-passenger side is equipped with a special seat belt retractor. When activated, the special seat belt retractor ensures that the seat belt will not slacken once the child restraint system has been secured.

Installing a child restraint system:

- ▶ Always comply with the manufacturer's installation instructions.
- ▶ Pull the seat belt smoothly from the seat belt retractor.
- ▶ Engage the seat belt tongue in the belt buckle.

Activating the special seat belt retractor:

- ▶ Pull the seat belt out fully and let the seat belt retractor retract it again. While the seat belt is retracting, you should hear a ratcheting sound. The special seat belt retractor is activated.
- ▶ Push down on the child restraint system to take up any slack.

Removing a child restraint system/
deactivating the special seat belt retractor:

- ▶ Always comply with the manufacturer's installation instructions.
- ▶ Press the seat belt release button and guide the belt tongue to the belt outlet. The special seat belt retractor is deactivated.

If necessary:

- ▶ Additionally move the seat backwards. The special seat belt retractor is deactivated.

If necessary:

- ▶ Additionally remove the seat belt from the seat belt guide on the seat backrest and guide the seat belt back to the belt sash guide. The special seat belt retractor is deactivated.

- PRE-SAFE® Brake (▷ page 63)
- STEER CONTROL (▷ page 65)

Important safety notes

If you fail to adapt your driving style or become distracted, the driving safety systems can neither reduce the risk of accident nor override the laws of physics. Driving safety systems are merely aids designed to assist driving. You are responsible for the distance to the vehicle in front, for vehicle speed and for braking in good time. Always adapt your driving style to suit the prevailing road and weather conditions and maintain a safe distance from the vehicle in front. Drive carefully.

- i** The driving safety systems described only work as effectively as possible when there is adequate contact between the tires and the road surface. Please pay special attention to the notes on tires, recommended minimum tire tread depths, etc. (▷ page 526).

In wintry driving conditions, always use winter tires (M+S tires) and if necessary, snow chains. Only in this way will the driving safety systems described in this section work as effectively as possible.

Driving safety systems

Driving safety systems overview

In this section, you will find information about the following driving safety systems:

- **ABS (Anti-lock Braking System)** (▷ page 57)
- **BAS (Brake Assist System)** (▷ page 58)
- **BAS PLUS (Brake Assist System PLUS)** (▷ page 58)
- **ESP® (Electronic Stability Program)** (▷ page 59)
- **EBD (electronic brake force distribution)** (▷ page 62)
- **ADAPTIVE BRAKE** (▷ page 63)

ABS (Anti-lock Braking System)

Important safety notes

WARNING

If ABS is faulty, the wheels could lock when braking. The steerability and braking characteristics may be severely impaired. Additionally, further driving safety systems are deactivated. There is an increased danger of skidding and accidents.

Drive on carefully. Have ABS checked immediately at a qualified specialist workshop.

When ABS is malfunctioning, other systems, including driving safety systems, will also become inoperative. Observe the information on the ABS warning lamp (▷ page 257) and display messages which may be shown in the instrument cluster (▷ page 224).

ABS regulates brake pressure in such a way that the wheels do not lock when you brake. This allows you to continue steering the vehicle when braking.

ABS works from a speed of about 5 mph (8 km/h) upwards, regardless of road-surface conditions. ABS works on slippery surfaces, even if you only brake gently.

The yellow  ABS warning lamp in the instrument cluster lights up when the ignition is switched on. It goes out when the engine is running.

Brakes

► **If ABS intervenes:** continue to depress the brake pedal vigorously until the braking situation is over.

► **To make a full brake application:** depress the brake pedal with full force.

If ABS intervenes when braking, you will feel a pulsing in the brake pedal.

The pulsating brake pedal can be an indication of hazardous road conditions, and functions as a reminder to take extra care while driving.

BAS (Brake Assist System)

WARNING

If BAS is malfunctioning, the braking distance in an emergency braking situation is increased. There is a risk of an accident.

In an emergency braking situation, depress the brake pedal with full force. ABS prevents the wheels from locking.

BAS operates in emergency braking situations. If you depress the brake pedal

quickly, BAS automatically boosts the braking force, thus shortening the stopping distance. The brakes will function as usual once you release the brake pedal. BAS is deactivated.

BAS PLUS (Brake Assist System Plus)

BAS PLUS is only available in vehicles equipped with DISTRONIC PLUS.

BAS PLUS provides braking assistance in hazardous situations at speeds greater than 4 mph (7 km/h) and uses radar sensor technology to assess the traffic situation.

With the help of the radar sensor system, BAS PLUS can detect obstacles that are in the path of your vehicle for an extended period of time.

At speeds up to 40 mph (70 km/h), BAS PLUS may also detect stationary obstacles, for example, stopped or parked vehicles.

To prevent a front-end collision, BAS PLUS calculates the brake force necessary if:

- you approach an obstacle, and
- BAS PLUS has detected a risk of collision

At a speed greater than 20 mph

(30 km/h): if you depress the brake sharply, BAS PLUS automatically raises the brake pressure to a value adapted to the traffic situation.

At a speed less than 20 mph (30 km/h): if you depress the brake, BAS PLUS is activated. The increase in brake pressure will be carried out at the last possible moment.

If BAS PLUS demands particularly high braking force, preventative passenger protection measures (PRE-SAFE®) are activated simultaneously.

► Keep the brake pedal depressed until the emergency braking situation is over. ABS prevents the wheels from locking.

BAS PLUS is deactivated and the brakes function as usual, if:

- you release the brake pedal.
- there is no longer any danger of a rear-end collision.
- no obstacle is detected in front of your vehicle.

For BAS PLUS to assist you when driving, the radar sensor system must be switched on and operational. You will find further information under the keyword "Radar sensor system".

If the radar sensor system is malfunctioning, BAS PLUS will not be available. The brake system is still available with complete brake boosting effect and BAS.

WARNING

BAS PLUS cannot always clearly identify objects and complex traffic situations. BAS PLUS cannot intervene in these cases. There is a risk of an accident.

Always pay careful attention to the traffic situation and be ready to brake.

In particular, the detection of obstacles can be impaired if there is:

- dirt on the sensors or anything else covering the sensors
- snow or heavy rain
- interference by other radar sources
- the possibility of strong radar reflections, for example in parking garages
- a narrow vehicle traveling in front, e.g. a motorbike
- a vehicle traveling in front on a different line relative to the center of your vehicle

WARNING

BAS PLUS does not react:

- to people or animals
- to oncoming vehicles
- to crossing traffic
- when cornering

As a result, BAS PLUS may not intervene in all critical situations. There is a risk of an accident.

Always pay careful attention to the traffic situation and be ready to brake.

Following damage to the front end of the vehicle, have the configuration and operation of the radar sensors checked at a qualified specialist workshop. This also applies to collisions at low speeds where there is no visible damage to the front of the vehicle.

i This device has been approved by the FCC as a "Vehicular Radar System". The radar sensor is intended for use in an automotive radar system only. Removing, altering or tampering with the device will void any warranties, and is not permitted by the FCC. Do not tamper with, alter, or use the device in any non-approved way.

Any unauthorized modification to this device could void the user's authority to operate the equipment.

ESP® (Electronic Stability Program)



Important safety notes

! Switch the ignition off when:

- the electric parking brake is being tested using a brake dynamometer.
- the vehicle is being towed with the rear axle raised.

Application of the brakes by ESP® may otherwise destroy the brake system.

ESP® is deactivated if the  warning lamp in the instrument cluster lights up continuously when the engine is running.

If the  warning lamp and the  warning lamp are lit continuously, ESP® is not available due to a malfunction.

Observe the information on warning lamps (▷ page 259) and display messages which may be shown in the instrument cluster (▷ page 224).

If ESP® detects that the vehicle is deviating from the direction desired by the driver, one or more wheels are braked to stabilize the vehicle. The engine output is also modified to keep the vehicle on the desired course within physical limits. ESP® assists the driver when pulling away on wet or slippery roads. ESP® can also stabilize the vehicle during braking. If ESP® intervenes, the  ESP® warning lamp flashes in the instrument cluster.

If ESP® intervenes:

- ▶ Do not deactivate ESP® under any circumstances.
 - ▶ only depress the accelerator pedal as far as necessary when pulling away.
 - ▶ adapt your driving style to suit the prevailing road and weather conditions.
- i** Only use wheels with the recommended tire sizes. Only then will ESP® function properly.

ETS (Electronic Traction System)

Traction control is part of ESP®.

Traction control brakes the drive wheels individually if they spin. This enables you to pull away and accelerate on slippery surfaces, for example if the road surface is slippery on one side.

Traction control remains active if you deactivate ESP®.

Deactivating/activating ESP® (except AMG vehicles)

WARNING

If you deactivate ESP®, ESP® no longer stabilizes the vehicle. There is an increased risk of skidding and an accident.

Only deactivate ESP® in the situations described in the following.

- !** Avoid spinning the driven wheels for an extended period with ESP® deactivated. You could otherwise damage the drivetrain.



- ▶ **To deactivate:** press button ①.

The  ESP® OFF warning lamp in the instrument cluster lights up.

- ▶ **To activate:** press button ①.

The  ESP® OFF warning lamp in the instrument cluster goes out.

ESP® is activated automatically when the engine is started.

The ECO start/stop function switches the engine off automatically when the vehicle stops moving. The engine starts automatically when the driver wants to pull away again. ESP® remains in its previously selected status. Example: if ESP® was deactivated before the engine was switched off, ESP® remains deactivated when the engine is switched on again.

If ESP® is deactivated and one or more wheels start to spin, the  ESP® warning lamp in the instrument cluster flashes. In such situations, ESP® will not stabilize the vehicle.

It may be best to deactivate ESP® in the following situations:

- when using snow chains
 - in deep snow
 - on sand or gravel
- If you deactivate ESP®:
- ESP® no longer improves driving stability.
 - traction control is still activated.

- ESP® still provides support when you brake.
- engine torque is not limited and the drive wheels are able to spin. The spinning wheels produce a cutting effect for better traction.

Deactivating/activating ESP® (AMG vehicles)

Activating/deactivating SPORT handling mode

WARNING

When SPORT handling mode is activated, there is a greater risk of skidding and accidents.

Only activate SPORT handling mode in the situations described in the following.



- ▶ **To activate:** briefly press button ①. The **SPORT** SPORT handling mode warning lamp in the instrument cluster lights up. The **SPORT handling mode** message appears in the multifunction display. SPORT handling mode is designed for driving on designated roads when the vehicle's own oversteering and understeering characteristics are desired. Driving in SPORT handling mode requires an extremely qualified and experienced driver who is able to cope with these critical driving conditions.
- ▶ **To deactivate:** briefly press button ①. The **SPORT** SPORT handling mode warning lamp in the instrument cluster goes out.

ESP® is activated automatically when the engine is started.

It may be best to activate SPORT handling mode in the following situations:

- when using snow chains
- in deep snow
- on sand or gravel

If SPORT handling mode is activated and one or more wheels start to spin, the  ESP® warning lamp in the instrument cluster flashes. ESP® only stabilizes the vehicle to a limited degree.

When SPORT handling mode is activated:

- ESP® only improves driving stability to a limited degree.
- traction control is still activated.
- ESP® still provides support when you brake firmly.
- engine torque is only restricted to a limited degree, and the drive wheels are able to spin. The spinning wheels produce a cutting effect for better traction.

Vehicles with ECO start/stop function: the ECO start/stop function switches the engine off automatically when the vehicle comes to a stop. The engine starts automatically when the driver wants to pull away again. ESP® remains in its previously selected status.

Example: if ESP® was deactivated before the engine was switched off, ESP® remains deactivated when the engine is switched on again.

Deactivating/activating ESP®

WARNING

If you deactivate ESP®, ESP® no longer stabilizes the vehicle. There is an increased risk of skidding and an accident.

Only deactivate ESP® in the situations described in the following.

- ▶ **!** Avoid spinning the driven wheels for an extended period with ESP® deactivated. You could otherwise damage the drivetrain.





► **To deactivate:** press button ① until the  ESP® OFF warning lamp lights up in the instrument cluster.

The  OFF message appears in the multifunction display.

Deactivate ESP® when driving on designated roads when the vehicle's own oversteering and understeering characteristics are desired. Driving without ESP® requires an extremely qualified and experienced driver who is able to cope with these critical driving conditions.

► **To activate:** briefly press button ①.

The  ESP® OFF warning lamp in the instrument cluster goes out. The  ON message appears in the multifunction display.

ESP® is activated automatically when the engine is started.

If ESP® is deactivated and one or more wheels start to spin, the  ESP® warning lamp in the instrument cluster does not flash. In such situations, ESP® will not stabilize the vehicle.

It may be best to deactivate ESP® in the following situations:

- when using snow chains
- in deep snow
- on sand or gravel

If you deactivate ESP®:

- ESP® no longer improves driving stability.
- traction control is still activated.

- PRE-SAFE® is no longer available, nor is it activated if you brake firmly and ESP® intervenes.
- PRE-SAFE® Brake is no longer available, it is also not activated if you brake firmly and ESP® intervenes.
- ESP® still provides support when you brake firmly.
- engine torque is no longer limited and the drive wheels are able to spin. The spinning wheels produce a cutting effect for better traction.

Vehicles with ECO start/stop function: the ECO start/stop function switches the engine off automatically when the vehicle comes to a stop. The engine starts automatically when the driver wants to pull away again. ESP® remains in its previously selected status. Example: if ESP® was deactivated before the engine was switched off, ESP® remains deactivated when the engine is switched on again.

EBD (Electronic Brake-force Distribution)

WARNING

If EBD has malfunctioned, the rear wheels can still lock, e.g. under full braking. This increases the risk of skidding and an accident. You should therefore adapt your driving style to the different handling characteristics. Have the brake system checked at a qualified specialist workshop.

Observe information regarding indicator and warning lamps (▷ page 257) as well as display messages (▷ page 226).

EBD monitors and controls the brake pressure on the rear wheels to improve driving stability while braking.

ADAPTIVE BRAKE

ADAPTIVE BRAKE enhances braking safety and offers increased braking comfort. In addition to the braking function, ADAPTIVE BRAKE also has the HOLD function (▷ page 176) and hill start assist (▷ page 138).

PRE-SAFE® Brake

PRE-SAFE® Brake is only available in vehicles with DISTRONIC PLUS.

PRE-SAFE® Brake can help you to minimize the risk of a collision with a vehicle ahead or reduce the effects of such a collision. If PRE-SAFE® Brake has detected a risk of collision, you will be warned visually and acoustically as well as by automatic braking. PRE-SAFE® Brake cannot prevent a collision without your intervention.

Starting at a speed of around 4 mph (7 km/h), this function warns you if you very quickly approach a vehicle in front. An intermittent warning tone will then sound and the  distance warning lamp will light up in the instrument cluster.

► Brake immediately in order to increase the distance from the vehicle in front.

or

► Take evasive action provided it is safe to do so.

From a speed of approximately 4 mph (7 km/h), if the driver and passengers have fastened their seat belts, PRE-SAFE® Brake can brake the vehicle automatically at speeds up to approximately 124 mph (200 km/h).

Due to the nature of the system, particularly complicated driving conditions may cause unnecessary warnings or the unnecessary intervention of PRE-SAFE® Brake.

You can end PRE-SAFE® Brake intervention in a non-critical driving situation at any time by:

- depressing the accelerator pedal further
- activating kickdown
- releasing the brake pedal.

The braking action of PRE-SAFE® Brake is ended automatically if:

- you maneuver to avoid the obstacle.
- there is no longer any danger of a rear-end collision.
- there is no longer an obstacle detected in front of your vehicle.

With the help of the radar sensor system, PRE-SAFE® Brake can detect obstacles that are in front of your vehicle for an extended period of time.

At speeds up to approximately 40 mph (70 km/h), PRE-SAFE® Brake can also detect stationary obstacles such as stopped or parked vehicles.

If you approach an obstacle and PRE-SAFE® Brake detects a risk of a collision, the system will alert you both visually and acoustically. If you do not brake or take evasive action, the system will warn you by automatically braking the vehicle gently. If there is an increased risk of collision, preventative passenger protection measures (PRE-SAFE®) are activated (▷ page 48).

If, at speeds over 20 mph (30 km/h), a risk of collision remains and you do not brake, take evasive action or significantly accelerate, automatic braking may be performed up to a level of automatic emergency braking. Automatic emergency braking is not performed until immediately prior to an accident that can no longer be avoided.

WARNING

PRE-SAFE® Brake will initially brake your vehicle by a partial application of the brakes if a danger of collision is detected. There may be a collision unless you also brake.

Automatic emergency braking cannot prevent a collision. There is a risk of an accident.

Always apply the brakes yourself and try to take evasive action.

WARNING

PRE-SAFE® Brake cannot always clearly identify objects and complex traffic conditions.

In these cases, PRE-SAFE® Brake may:

- give an unnecessary warning and then brake the vehicle
- not give a warning or intervene

There is a risk of an accident.

Always pay particular attention to the traffic situation and be ready to brake, especially if PRE-SAFE® Brake warns you. Terminate the intervention in a non-critical driving situation.

In particular, the detection of obstacles can be impaired if there is:

- dirt on the sensors or anything else covering the sensors
- snow or heavy rain
- interference by other radar sources
- the possibility of strong radar reflections, for example in parking garages
- a narrow vehicle traveling in front, e.g. a motorbike
- a vehicle traveling in front on a different line relative to the center of your vehicle

WARNING



PRE-SAFE® Brake does not react:

- to people or animals
- to oncoming vehicles
- to crossing traffic
- when cornering

As a result, PRE-SAFE® Brake may neither give warnings nor intervene in all critical situations. There is a risk of an accident.

Always pay careful attention to the traffic situation and be ready to brake.

In order to maintain the appropriate distance to the vehicle in front and thus prevent a collision, you must apply the brakes yourself.

► **To activate/deactivate:** activate or deactivate PRE-SAFE® Brake in the on-board computer (▷ page 214). When PRE-SAFE® Brake is activated, the  symbol appears in multifunction display, as long as the HOLD function is deactivated (▷ page 176). On vehicles with Active Parking Assist, the  symbol is displayed when **P** is engaged or you are driving faster than 22 mph (35 km/h).

For PRE-SAFE® Brake to assist you when driving, the radar sensor system must be switched on (▷ page 218) and be operational.

Following damage to the front end of the vehicle, have the configuration and operation of the radar sensors checked at a qualified specialist workshop. This also applies to collisions at low speeds where there is no visible damage to the front of the vehicle.

i USA only: This device has been approved by the FCC as a "Vehicular Radar System". The radar sensor is intended for use in an automotive radar system only. Removal, tampering, or altering of the device will void any warranties, and is not permitted by the FCC. Do not tamper with, alter, or use the device in any non-approved way.

Any unauthorized modification to this device could void the user's authority to operate the equipment.

i Canada only: This device complies with RSS-210 of Industry Canada. Operation is subject to the following two conditions:

1. This device may not cause interference, and
2. this device must accept any interference received, including interference that may cause undesired operation of the device.

Removal, tampering, or altering of the device will void any warranties and is not

permitted. Do not tamper with, alter, or use the device in any non-approved way.

Any unauthorized modification to this device could void the user's authority to operate the equipment.

STEER CONTROL

STEER CONTROL helps you by transmitting a noticeable steering force to the steering wheel in the direction required for vehicle stabilization.

This steering assistance is provided in particular if:

- both right wheels or both left wheels are on a wet or slippery road surface when you brake
- the vehicle starts to skid

If ESP® is malfunctioning, you will not receive steering support from STEER CONTROL. Power steering will, however, continue to function.

Theft deterrent locking system

Immobilizer

- ▶ **To activate with the SmartKey:** remove the SmartKey from the ignition lock.
- ▶ **To activate with KEYLESS-GO:** switch the ignition off and open the driver's door.
- ▶ **To deactivate:** switch on the ignition.

The immobilizer prevents your vehicle from being started without the correct SmartKey. When leaving the vehicle, always take the SmartKey with you and lock the vehicle. The engine can be started by anyone with a valid SmartKey that is left inside the vehicle.

i The immobilizer is always deactivated when you start the engine.

In the event that the engine cannot be started when the starter battery is fully charged, the immobilizer may be faulty. Contact an authorized Mercedes-Benz

Center or call 1-800-FOR-MERCEdes (in USA) or 1-800-387-0100 (in Canada).



ATA (anti-theft alarm system)



- ▶ **To arm:** lock the vehicle with the SmartKey or KEYLESS-GO. Indicator lamp **1** flashes. The alarm system is armed after approximately 15 seconds.
- ▶ **To disarm:** unlock the vehicle with the SmartKey or KEYLESS-GO.

A visual and audible alarm is triggered if the alarm system is armed and you open:

- a door
- the vehicle with the mechanical key
- the trunk
- the hood
- the glove box
- the stowage space under the armrest
- a stowage compartment in the rear

- ▶ **To turn the alarm off with the SmartKey:** press the  or  button on the SmartKey. The alarm is switched off.

or

- ▶ Insert the SmartKey into the ignition lock. The alarm is switched off.

- ▶ **To stop the alarm using KEYLESS-GO:**
grasp the outside door handle. The SmartKey must be outside the vehicle.
The alarm is switched off.

or

- ▶ Press the Start/Stop button on the dashboard. The SmartKey must be inside the vehicle.
The alarm is switched off.

The alarm is not switched off, even if you close the open door that has triggered it, for example.

- ❗ If the alarm stays on for more than 30 seconds, the Tele Aid system initiates a call to the Customer Assistance Center automatically. The emergency call system initiates the call provided that:
 - you have subscribed to the mbrace/TELE AID service.
 - the mbrace/TELE AID service has been activated properly.
 - the required mobile phone, power supply and GPS are available.

Useful information	68
SmartKey	68
Doors	74
Trunk	77
Side windows	83
Roof	86

Useful information

- i** This Operator's Manual describes all models and all standard and optional equipment of your vehicle available at the time of publication of the Operator's Manual. Country-specific differences are possible. Please note that your vehicle may not be equipped with all features described. This also applies to safety-related systems and functions.
- i** Read the information on qualified specialist workshops: (> page 31).

SmartKey

Important safety notes

⚠ WARNING

When leaving the vehicle, always remove the SmartKey from the ignition lock. Always take the SmartKey with you and lock the vehicle. Do not leave children unsupervised in the vehicle, even if they are secured in a child restraint system, and do not give them access to an unlocked vehicle. A child's unsupervised access to a vehicle could result in an accident and/or serious personal injury. They could:

- injure themselves on vehicle parts
- be seriously or fatally injured by extreme heat or cold
- injure themselves or have an accident with vehicle equipment that may still be in operation even after the SmartKey has been removed from the ignition, such as the seat adjustment, steering wheel adjustment or memory function.

If children open a door, they could cause severe or even fatal injury to other persons; if they get out of the vehicle, they could injure themselves when doing so or be seriously or even fatally injured by any passing traffic.

Do not expose the child restraint system to direct sunlight. The child restraint system's metal parts, for example, could become very

hot, and a child could be burned on these parts.

⚠ WARNING

If a key ring is too heavy or too large, the weight acting on the SmartKey could cause it to turn in the ignition lock or catch on the steering wheel. This could cause the engine to be switched off suddenly. You could lose control of the vehicle and cause an accident. Do not attach any heavy or large key rings to the SmartKey that is inserted in the ignition.

- Do not keep the SmartKey together with:
 - electronic devices, e.g. a mobile phone or another SmartKey
 - metallic objects, e.g. coins or metal foil.



This can affect the functionality of the SmartKey.

Keep the SmartKey away from strong magnetic fields. Otherwise, the remote control function could be affected.

SmartKey functions

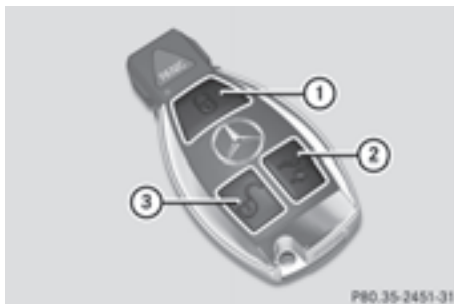
Locking and unlocking centrally



- ①  To lock the vehicle
- ②  To unlock the trunk lid
- ③  To unlock the vehicle

► **To unlock centrally:** press the  button.

If you do not open the vehicle within approximately 40 seconds of unlocking:

- the vehicle is locked again.
- the theft deterrent locking system is armed again.

► **To lock centrally:** press the  button.

The SmartKey centrally locks/unlocks:

- the doors
- the trunk lid
- the glove box
- the stowage compartment under the armrest
- the stowage compartment in the rear compartment
- the fuel filler flap

When unlocking, the turn signals flash once. When locking, they flash three times.

You can also set an audible signal to confirm that the vehicle has been locked. The audible signal can be activated and deactivated using the on-board computer (▷ page 218).

When it is dark, the surround lighting also comes on if it is activated in the on-board computer (▷ page 217).

KEYLESS-GO

General notes on the use of KEYLESS-GO



- Do not keep the KEYLESS-GO key together with:
 - electronic devices, e.g. a mobile phone or another key
 - metallic objects, e.g. coins or metal foil
 This can affect the functionality of KEYLESS-GO.
- Bear in mind that the engine can be started by any of the vehicle occupants if there is a KEYLESS-GO key in the vehicle.

Locking and unlocking centrally

You can start, lock or unlock the vehicle using KEYLESS-GO. To do this, you only need carry the SmartKey with you. You can combine the functions of KEYLESS-GO with those of a conventional key. Unlock the vehicle by using KEYLESS-GO, for instance, and lock it using the  button on the key.

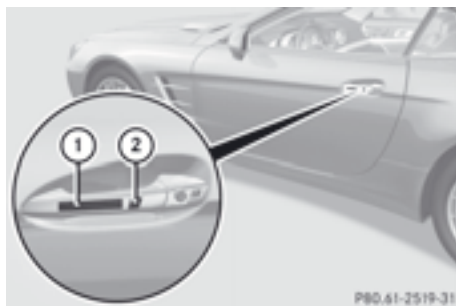
When locking or unlocking with KEYLESS-GO, the distance between the SmartKey and the door handle you wish to lock or unlock must not be greater than 3 ft (1 m).





- **To unlock the vehicle:** touch the inner surface of the door handle.
- **To lock the vehicle:** touch sensor surface .
- **Convenience closing feature:** touch recessed sensor surface  for an extended period (▷ page 85).



If you pull on the handle of the trunk lid, only the trunk of the vehicle is unlocked. KEYLESS-GO checks whether a valid SmartKey is in the vehicle by periodically establishing a radio connection between the vehicle and the SmartKey. This happens:

- when the external door handles are touched
- when starting the engine
- while the vehicle is in motion

Changing the settings of the locking system



You can change the settings of the locking system. This means only the driver's door, the lockable stowage compartments in the vehicle interior and the fuel filler flap are unlocked when the vehicle is unlocked. This is useful if you frequently travel on your own.

► **To change the setting:** press and hold down the  and  buttons simultaneously for approximately six seconds until the battery check lamp flashes twice (▷ page 71).



i If the setting of the locking system is changed within the signal range of the vehicle, pressing the  or  button:

- locks or
- unlocks the vehicle

The SmartKey now functions as follows:

- **To unlock the driver's door:** press the  button once.
- **To unlock centrally:** press the  button twice.
- **To lock centrally:** press the  button.

The KEYLESS-GO function is changed as follows:

- **To unlock the driver's door:** touch the inner surface of the door handle on the driver's door.
- **To unlock centrally:** touch the inner surface of the front-passenger door handle.
- **To lock centrally:** touch the outer sensor surface on one of the door handles.
- **To restore the factory settings:** press and hold down the  and  buttons simultaneously for approximately six seconds until the battery check lamp flashes twice (▷ page 71).



Mechanical key

General notes

If the vehicle can no longer be locked or unlocked with the SmartKey, use the mechanical key.

If you use the mechanical key to unlock and open the driver's door or the trunk lid, the anti-theft alarm system will be triggered (▷ page 65).

There are several ways to turn off the alarm:

► **To turn the alarm off with the SmartKey:** press the  or  button on the SmartKey.

or

► Insert the SmartKey into the ignition lock.

or

► **To deactivate the alarm with KEYLESS-GO:** press the Start/Stop button in the ignition lock. The SmartKey must be in the vehicle.

or

► Lock or unlock the vehicle using KEYLESS-GO. The SmartKey must be outside the vehicle.

If you unlock the vehicle using the mechanical key, the fuel filler flap will not be unlocked automatically.

► **To unlock the fuel filler flap:** insert the SmartKey into the ignition lock.

Removing the mechanical key



- ▶ Push release catch ① in the direction of the arrow and at the same time, remove mechanical key ② from the SmartKey.

SmartKey battery

Important safety notes

WARNING

Batteries contain toxic and caustic substances. For this reason, keep batteries out of the reach of children.

If a battery has been swallowed, seek medical help immediately.



WARNING

The SmartKey batteries contain perchlorate material, which may require special handling and regard for the environment. Observe government disposal guidelines. California residents, see www.dtsc.ca.gov/HazardousWaste/Perchlorate/index.cfm.

Mercedes-Benz recommends that you have the batteries replaced at a qualified specialist workshop.



Checking the battery



- ▶ Press the  or  button. The battery is working properly if battery check lamp ① lights up briefly.

The battery is discharged if battery check lamp ① does not light up briefly.

- ▶ Changing the battery (▷ page 71)

i If the SmartKey battery is checked within the signal reception range of the vehicle, pressing the  or  button:

- locks or
- unlocks the vehicle

i You can get a battery in any qualified specialist workshop.

Replacing the battery

You require a CR 2025 3 V cell battery.



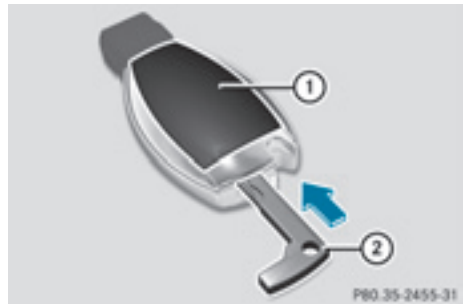

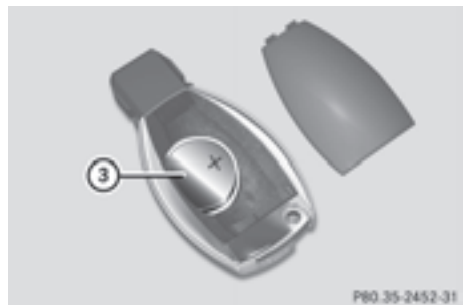

- ▶ Take the mechanical key out of the SmartKey (▷ page 70).



- ▶ Press mechanical key ② into the opening in the key in the direction of the arrow until battery compartment cover ① opens. When doing so, do not hold battery compartment cover ① shut.
- ▶ Remove battery compartment cover ①.



- ▶ Repeatedly tap the SmartKey against your palm until battery ③ falls out.
- ▶ Insert the new battery with the positive terminal facing upwards. Use a lint-free cloth to do so.
- ▶ Make sure that the surface of the battery is free from lint, grease and all other forms of contamination.
- ▶ Insert the front tabs of battery compartment cover ① into the housing and then press to close it.
- ▶ Insert mechanical key ② into the SmartKey.
- ▶ Check the function of all SmartKey buttons on the vehicle.

Problems with the SmartKey	
Problem	Possible causes/consequences and ► Solutions
You cannot lock or unlock the vehicle using the SmartKey.	<p>The SmartKey battery is discharged or nearly discharged.</p> <ul style="list-style-type: none"> ► Try again to lock/unlock the vehicle using the remote control function of the SmartKey. Point the tip of the SmartKey at the driver's door handle from close range and press the  or  button. <p>If this does not work:</p> <ul style="list-style-type: none"> ► Check the SmartKey battery (▷ page 71) and replace it if necessary (▷ page 71). ► Lock (▷ page 76) or unlock (▷ page 77) the vehicle using the mechanical key.
	<p>The SmartKey is faulty.</p> <ul style="list-style-type: none"> ► Unlock (▷ page 76) or lock (▷ page 77) the vehicle using the mechanical key. ► Have the SmartKey checked at a qualified specialist workshop.
You can no longer lock or unlock the vehicle using KEYLESS-GO.	<p>There is interference from a powerful source of radio waves.</p> <ul style="list-style-type: none"> ► Lock/unlock the vehicle using the remote control function of the SmartKey. Point the tip of the SmartKey at the driver's door handle from close range and press the  or  button.
	<p>There is a malfunction with KEYLESS-GO.</p> <ul style="list-style-type: none"> ► Lock/unlock the vehicle using the remote control function of the SmartKey. Point the tip of the SmartKey at the driver's door handle from close range and press the  or  button. ► Have KEYLESS-GO checked at a qualified specialist workshop. <p>If this does not work:</p> <ul style="list-style-type: none"> ► Check the SmartKey battery (▷ page 71) and replace it if necessary (▷ page 71). ► Lock (▷ page 76) or unlock (▷ page 77) the vehicle using the mechanical key.
You have lost a SmartKey.	<ul style="list-style-type: none"> ► Have the SmartKey deactivated at a qualified specialist workshop. ► Report the loss immediately to the vehicle insurers. ► If necessary, have the locks changed as well.
You have lost the mechanical key.	<ul style="list-style-type: none"> ► Report the loss immediately to the vehicle insurers. ► If necessary, have the locks changed as well.

Problem	Possible causes/consequences and ► Solutions
The engine cannot be started using the SmartKey.	<p>the on-board voltage is too low.</p> <ul style="list-style-type: none"> ► Switch off non-essential consumers, e.g. seat heating or interior lighting, and try to start the engine again. <p>If this does not work:</p> <ul style="list-style-type: none"> ► Check the starter battery and charge it if necessary (▷ page 515). <p>or</p> <ul style="list-style-type: none"> ► Jump-start the vehicle (▷ page 516). <p>or</p> <ul style="list-style-type: none"> ► Consult a qualified specialist workshop.
The engine cannot be started using KEYLESS-GO. The SmartKey is in the vehicle.	<p>A door is open. Therefore, the SmartKey cannot be detected as easily.</p> <ul style="list-style-type: none"> ► Close the door and try to start the vehicle again. <p>There is interference from a powerful source of radio waves.</p> <ul style="list-style-type: none"> ► Start your vehicle with the SmartKey in the ignition lock.

Doors

Important safety notes

WARNING

When leaving the vehicle, always remove the SmartKey from the ignition lock. Always take the SmartKey with you and lock the vehicle. Do not leave children unsupervised in the vehicle, even if they are secured in a child restraint system, and do not give them access to an unlocked vehicle. A child's unsupervised access to a vehicle could result in an accident and/or serious personal injury. They could:

- injure themselves on vehicle parts
- be seriously or fatally injured by extreme heat or cold
- injure themselves or have an accident with vehicle equipment that may still be in operation even after the SmartKey has been removed from the ignition, such as the seat adjustment, steering wheel adjustment or memory function.

If children open a door, they could cause severe or even fatal injury to other persons; if they get out of the vehicle, they could injure themselves when doing so or be seriously or even fatally injured by any passing traffic.

Do not expose the child restraint system to direct sunlight. The child restraint system's metal parts, for example, could become very hot, and a child could be burned on these parts.

WARNING

Do not carry heavy or hard objects in the passenger compartment unless they are firmly secured in place.

Unsecured or improperly positioned cargo increases a child's risk of injury in the event of:

- strong braking maneuvers
- sudden changes of direction
- an accident

Unlocking and opening doors from the inside

! The side windows will not open/close if the battery is discharged or if the side windows have iced up. It will then not be possible to close the door. Do not attempt to force the door closed. You could otherwise damage the door or the side window.

You can open a door from inside the vehicle even if it has been locked.

If the vehicle was previously locked with the SmartKey or with KEYLESS-GO, opening the vehicle from the inside will activate the anti-theft alarm system. Switch off the alarm (▷ page 65).



► Pull door handle ②.

If the door is locked, locking knob ① pops up. The door is unlocked and can be opened.

i When a door is opened, the side window on that side opens slightly. When the door is closed, the side window closes again.

Centrally locking and unlocking the vehicle from the inside

You can centrally lock or unlock the vehicle from the inside. For example, you can unlock the front-passenger door from the inside or lock the vehicle before you pull away.



► **To unlock:** press button ①.

► **To lock:** press button ②.

If the front-passenger door is closed, the vehicle locks.

The central locking/unlocking button does not lock or unlock the fuel filler flap or the stowage compartments, such as the glove box.

You cannot unlock the vehicle centrally from the inside if the vehicle has been locked with the key or KEYLESS-GO.

You can open a door from inside the vehicle even if it has been locked.

If the vehicle has been locked using the locking button for the central locking, or has been locked automatically, and a door is opened from the inside:

- the vehicle will be fully unlocked if it had previously been fully unlocked
- only the door which has been opened from the inside is unlocked if only the driver's door had been previously unlocked

Automatic locking feature



① To deactivate

② To activate

► **To deactivate:** press and hold button ① for about five seconds until a tone sounds.

► **To activate:** press and hold button ② for about five seconds until a tone sounds.

i If you press one of the two buttons and do not hear a tone, the relevant setting has already been selected.

The vehicle is locked automatically when the ignition is switched on and the wheels are turning.

You could therefore lock yourself out if:

- the vehicle is being pushed.
- the vehicle is being towed.
- the vehicle is on a roller dynamometer.

You can also switch the automatic locking function on and off using the on-board computer (▷ page 218).

Power closing feature

⚠ WARNING

To prevent possible personal injury, always keep hands and fingers away from the door or trunk opening when closing a door or the trunk lid. Be especially careful when small children are around.

If danger threatens, pull the inside or outside door handle, or pull the trunk lid handle.

To prevent personal injury, never activate the closing assist mechanism by tampering with the door or trunk lid latch.

⚠ WARNING

Only drive with the doors closed. Otherwise, one or more of the doors could open while the vehicle is in motion, putting you and/or others at risk.

⚠ WARNING

Make sure the trunk lid is closed when the engine is running and while driving. Among other dangers, deadly carbon monoxide (CO) gases may enter the vehicle interior resulting in unconsciousness and death.

The power closing feature pulls the doors and trunk lid into their locks automatically even if they are only partly closed.

► **Power closing feature (doors):** push the door past the first detent position of the lock.

The power closing feature will pull the door fully closed.

► **Power closing feature (trunk lid):** lightly push the trunk lid closed.

The power closing feature will pull the trunk lid fully closed.

Unlocking the driver's door (mechanical key)

If the vehicle can no longer be unlocked with the SmartKey, use the mechanical key.

► Take the mechanical key out of the SmartKey (▷ page 70).

► Insert the mechanical key into the lock of the driver's door as far as it will go.



- ▶ Turn the mechanical key counterclockwise to position **1**.
The door is unlocked.
- ▶ Turn the mechanical key back and remove it.
- ▶ Insert the mechanical key into the SmartKey.

If you use the mechanical key to unlock and open the driver's door, the anti-theft alarm system will be triggered (▷ page 65).

Locking the vehicle (mechanical key)

If the vehicle can no longer be locked with the SmartKey, use the mechanical key.

- ▶ Open the driver's door.
- ▶ Close the front-passenger door and the trunk lid.
- ▶ Press the locking button (▷ page 75).
- ▶ Check whether the locking knob on the front-passenger door is still visible. Press down the locking knob by hand, if necessary.
- ▶ Close the driver's door.
- ▶ Take the mechanical key out of the SmartKey (▷ page 70).
- ▶ Insert the mechanical key into the lock of the driver's door as far as it will go.



- 1** To lock
- ▶ Turn the mechanical key clockwise as far as it will go to position **1**.
- ▶ Turn the mechanical key back and remove it.
- ▶ Make sure that the doors and the trunk lid are locked.
- ▶ Insert the mechanical key into the SmartKey.

i If you lock the vehicle as described above, the fuel filler flap is not locked. The anti-theft alarm system is not armed.

Trunk

Important safety notes

WARNING

When leaving the vehicle, always remove the SmartKey from the ignition lock. Always take the SmartKey with you and lock the vehicle. Do not leave children unsupervised in the vehicle, even if they are secured in a child restraint system, and do not give them access to an unlocked vehicle. A child's unsupervised access to a vehicle could result in an accident and/or serious personal injury. They could:

- injure themselves on vehicle parts
- be seriously or fatally injured by extreme heat or cold
- injure themselves or have an accident with vehicle equipment that may still be in operation even after the SmartKey has been removed from the ignition, such as the

seat adjustment, steering wheel adjustment or memory function.

If children open a door, they could cause severe or even fatal injury to other persons; if they get out of the vehicle, they could injure themselves when doing so or be seriously or even fatally injured by any passing traffic.

Do not expose the child restraint system to direct sunlight. The child restraint system's metal parts, for example, could become very hot, and a child could be burned on these parts.

WARNING

Do not carry heavy or hard objects in the passenger compartment or trunk unless they are firmly secured in place.

Unsecured or improperly positioned cargo increases a child's risk of injury in the event of

- strong braking maneuvers
- sudden changes of direction
- an accident

WARNING

Make sure the trunk lid is closed when the engine is running and while driving. Among other dangers, deadly carbon monoxide (CO) gases may enter the vehicle interior resulting in unconsciousness and death.

! The trunk lid swings upwards when opened. Therefore, make sure that there is sufficient clearance above the trunk lid.

i The opening dimensions of the trunk lid can be found in the "Vehicle data" section (▷ page 565).

i To make loading easier, the stowed roof can be raised with the loading aid after the trunk lid has been opened. The trunk partition can also be detached. The trunk partition must be put back in position after loading. Otherwise, the roof cannot be lowered.

You can unlock the trunk lid if the vehicle is stationary and the roof is completely open or closed.

Do not leave the SmartKey in the trunk. You could otherwise lock yourself out.



The trunk lid can be:

- opened and closed manually from outside
- opened automatically from outside (vehicles without trunk lid remote closing feature)
- opened and closed automatically from outside (vehicles with trunk lid remote closing feature)
- opened and closed from outside (vehicles with KEYLESS-GO and HANDS-FREE ACCESS)
- opened and closed automatically from inside (vehicles with trunk lid remote closing feature)
- locked separately
- unlocked with the mechanical key
- opened with the emergency release button

Opening and closing manually from outside

Opening



- ▶ Press the  button on the SmartKey.
- ▶ Pull handle .
- ▶ Raise the trunk lid.

i With the roof open, you can use the loading aid (▷ page 477) to raise the folded-up roof in the trunk, enabling you to

load and unload more easily. For this purpose, you can also open the trunk partition.

Do not forget to close the trunk partition again afterwards. Otherwise, it will not be possible to close the roof.

Closing

WARNING

To prevent possible personal injury, always keep hands and fingers away from the trunk opening when closing the trunk lid. Be especially careful when small children are around.



- ▶ Pull the trunk lid down using recess ①.
- ▶ Lock the vehicle if necessary with the  button on the key or with KEYLESS-GO.
- ① If a KEYLESS-GO key is detected in the trunk, the trunk lid cannot be locked and then opens again.

Opening/closing automatically from outside

Important safety notes

WARNING

Make sure the trunk lid is closed when the engine is running and while driving. Among other dangers, deadly carbon monoxide (CO) gases may enter the vehicle interior resulting in unconsciousness and death.

❗ The trunk lid swings upwards when opened. Therefore, make sure that there is sufficient clearance above the trunk lid.

① The opening dimensions of the trunk lid can be found in the "Vehicle data" section (> page 565).

Opening

You can open the trunk lid automatically using the SmartKey or the handle in the trunk lid.

▶ Press and hold the  button on the SmartKey until the trunk lid opens.

or

▶ If the trunk lid is unlocked, pull the trunk lid handle and let it go again immediately.

Closing

WARNING

Monitor the closing procedure carefully to make sure no one is in danger of being injured. To prevent possible personal injury, always keep hands and fingers away from the trunk opening when closing the trunk lid. Be especially careful when small children are around. To stop the closing procedure, do one of the following:

- Press button  on the SmartKey.
- Press the remote trunk opening/closing switch (on the driver's door).
- Press the trunk closing switch.
- Press the KEYLESS-GO locking/closing switch.
- Pull the trunk lid handle.

Even with the SmartKey removed from the starter switch or the SmartKey with KEYLESS-GO removed from the vehicle, the remote trunk opening/closing switch can be operated. Therefore, do not leave children unattended in the vehicle, or with access to an unlocked vehicle. A child's unsupervised access to a vehicle could result in an accident and/or serious personal injury.

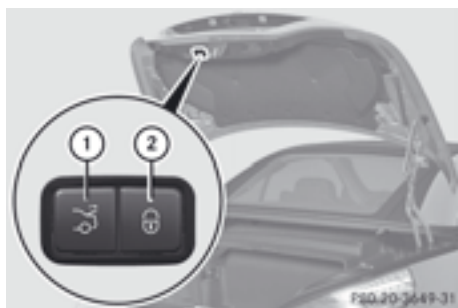

- ① Closing button
- ② Locking button

► **To close:** press closing button ① in the trunk lid.

Vehicles with trunk lid remote closing feature and KEYLESS-GO: you can simultaneously close and lock the trunk lid.

► Press locking button ② in the trunk lid. If a KEYLESS-GO key is detected outside the vehicle, the trunk lid closes and locks.

❗ If a KEYLESS-GO key is detected in the trunk, the trunk lid cannot be locked and then opens again.

HANDS-FREE ACCESS

Important safety notes

⚠ WARNING

When opening or closing the trunk lid using the HANDS-FREE ACCESS function, limbs could get trapped. There is a risk of injury. Keep your hands and other limbs at a safe distance from the trunk opening.

Keep the rear of the vehicle in view when opening and closing the trunk lid. Make sure that nobody can become trapped.

To stop the opening or closing procedure:

- make a kicking movement with your leg under the bumper in the detection range of the sensors
- pull the handle on the outside of the trunk lid

- press the closing button in the trunk lid, or
- press the  button on the SmartKey

If the trunk lid closing procedure has been stopped:

- make a kicking movement with your leg under the bumper once again and the trunk lid will open.

If the trunk lid opening procedure has been stopped:

- make a kicking movement with your leg under the bumper once again and the trunk lid will close.

⚠ WARNING

By making a kicking movement under the bumper with your leg, you could burn yourself on the hot exhaust system. Make sure that the kicking movement is only carried out in the detection range of the sensors.

❗ If the SmartKey is within the detection range of the vehicle, the following situations could lead to the unintentional opening of the trunk:

- using a car wash
- using a power washer

Make sure that the SmartKey is at least 6.5 ft (2 m) away from the vehicle.

Important notes on the use of HANDS-FREE ACCESS:

- With KEYLESS-GO and HANDS-FREE ACCESS, you can open or close the trunk lid or stop the procedure without using your hands. This is useful if you have your hands full. All you need to do is make a kicking movement with your leg under the bumper.
- Remove the SmartKey from the ignition lock.
- With KEYLESS-GO, make sure the ignition is switched off (▷ page 135).
- Carry your KEYLESS-GO key on your person. The SmartKey must be located near to the rear area of the vehicle.

- When making the kicking movement, make sure that you are standing firmly on the ground. You could otherwise lose your balance e.g. on ice.
- Stand at least 4 in (10 cm) away from the rear area while doing so.
- Do not come into contact with the bumper while making the kicking movement. Otherwise, the sensors may not function correctly and you risk dirtying your clothes.
- HANDS-FREE ACCESS does not work with a prosthetic leg.

Operation



- ▶ **To open/close:** kick into sensor detection range ① under the bumper with your leg. You do not need to touch the bumper. You will hear a warning tone while the trunk lid is opening or closing.
- ▶ **If the trunk lid does not open after several attempts:** wait at least ten seconds then kick under the bumper once again.

- ⓘ If you hold your leg under the bumper for too long, the trunk lid does not open or close. Repeat the leg movement more quickly if this occurs.

Opening/closing automatically from inside

Important safety notes

⚠ WARNING

Maintain sight of the area around the rear of the vehicle while operating the trunk lid with the door mounted switch. Monitor the closing procedure carefully to make sure no one is in danger of being injured.

To interrupt the closing procedure, release the door mounted remote trunk opening/closing switch again.

Even with the SmartKey removed from the starter switch or the SmartKey with KEYLESS-GO removed from the vehicle, the remote trunk opening/closing switch can be operated. Therefore, do not leave children unattended in the vehicle, or with access to an unlocked vehicle. A child's unsupervised access to a vehicle could result in an accident and/or serious personal injury.

⚠ WARNING

Make sure the trunk lid is closed when the engine is running and while driving. Among other dangers, deadly carbon monoxide (CO) gases may enter the vehicle interior resulting in unconsciousness and death.

- ⚠ The trunk lid swings upwards when opened. Therefore, make sure that there is sufficient clearance above the trunk lid.
- ⓘ The opening dimensions of the trunk lid can be found in the "Vehicle data" section (▷ page 565).

Opening/closing



- ▶ **To open:** pull remote operating switch for trunk lid ① until the trunk lid opens.
- ▶ **To close:** press remote operating switch for trunk lid ① until the trunk lid is closed.

You can open and close the trunk lid from the driver's seat when the vehicle is stationary and unlocked.

Locking the trunk separately

You can lock the trunk separately. If you then unlock the vehicle centrally, the trunk remains locked and cannot be opened.

- ▶ Close the trunk lid.
- ▶ Take the mechanical key out of the SmartKey (▷ page 70).



- ① Basic position
- ② Locking

- ▶ Insert the mechanical key into the trunk lid lock as far as the stop.
- ▶ Turn the mechanical key clockwise from position ① to position ②.
- ▶ Remove the mechanical key.
- ▶ Insert the mechanical key into the SmartKey.

Unlocking the trunk (mechanical key)

- ⚠ The trunk lid swings upwards when opened. Therefore, make sure that there is sufficient clearance above the trunk lid.

If the trunk cannot be unlocked with the SmartKey or KEYLESS-GO, use the mechanical key.

If you use the mechanical key to unlock and open the trunk lid, the anti-theft alarm system will be triggered (▷ page 65).

- ▶ Take the mechanical key out of the SmartKey (▷ page 70).
- ▶ Insert the mechanical key into the trunk lid lock as far as the stop.



- ① Basic position
- ② To unlock
- ▶ Turn the mechanical key counter-clockwise from position ① as far as it will go to position ②.
- ▶ Pull the trunk lid handle. The trunk is unlocked.

- ▶ Turn the mechanical key back to position **1** and remove it.
- ▶ Insert the mechanical key into the SmartKey.

Trunk emergency release

You can unlock the trunk lid from the inside with the emergency release button.

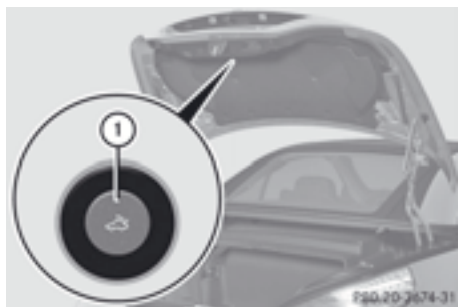

- ▶ Press emergency release button **1** briefly. The trunk lid unlocks and opens slightly.
- ▶ Push the trunk lid upwards to open it completely.

The trunk lid can be unlocked with the trunk lid emergency release when the vehicle is stationary or while driving.

The trunk lid emergency release does not unlock the trunk lid if the battery is disconnected or discharged.

Trunk lid emergency release light:

- emergency release button **1** flashes for 30 minutes after the trunk lid is opened.
- emergency release button **1** flashes for 60 minutes after the trunk lid is closed.

Side windows

Important safety notes

WARNING

When opening or closing the door windows, make sure that there is no danger of anyone

being harmed by the opening/closing procedure.

The front door windows are equipped with automatic operation and the anti-entrapment feature. If in automatic mode a front door window encounters an obstruction that blocks its path, the anti-entrapment feature will stop the door window and open it slightly.

The door windows operate differently when the switch is pulled. See the "Problems with door windows" section for more details.

The closing of the door windows can be immediately halted by releasing the switch or, if the switch was pulled past the resistance point and released, by pressing or pulling the respective switch.

If a door window encounters an obstruction that blocks its path in a circumstance where you are closing the windows by pressing and holding  button on the SmartKey or by pressing and holding the lock button (vehicles with KEYLESS-GO) on an outside door handle, the anti-entrapment feature will not operate.

Opening and closing the side windows

Opening and closing the side windows in the front

The switches for the side windows are located on the driver's door. There is also a switch for the front-passenger side window on the front-passenger door.

The switches on the driver's door take precedence.



- ① Left
- ② Right

- ▶ Turn the SmartKey to position **1** or **2** in the ignition lock.
- ▶ **To open:** press the corresponding switch.
- ▶ **To close:** pull the corresponding switch.
- ▶ **Automatic operation:** press or pull the corresponding switch beyond the point of resistance. The side window opens or closes fully.
- ▶ **To interrupt automatic operation:** press or pull the corresponding switch again.

i You can continue to operate the side windows after you switch off the engine. This function is available for up to five minutes or until the driver's or front-passenger door is opened.

Opening/closing the rear side windows

- ▶ **To open:** open the front side window on the corresponding side (▷ page 83).
- ▶ Press the corresponding switch again. The corresponding rear side window opens fully.
- ▶ **To stop the rear side windows:** briefly pull the corresponding switch up.
- ▶ **To close:** close the front side window on the corresponding side (▷ page 83).
- ▶ Pull the respective switch and hold it. The corresponding rear side window will continue to close until you release the switch.

Opening and closing all side windows

Using the switch on the center console

You can use the button on the center console to close all side windows simultaneously.

- ▶ Open the cover in the lower center console. The switch for all side windows is under the cover.



- ▶ **To open all side windows:** press switch ① to the point of resistance.
- ▶ **To open all side windows fully:** press switch ① beyond the point of resistance. All side windows open simultaneously.

i If, after opening the windows, you close one side window using the button in the door control panel:

- the front side window closes first and
- then the corresponding rear side window closes.



- ▶ **To close all side windows:** pull switch ①. All side windows close simultaneously.

Using the SmartKey





⚠ WARNING

Make sure that nobody can become trapped as you close the side windows.

Proceed as follows if there is a risk of entrapment:

- release the  key.
- press and hold the  key until the side windows open again.

You can use the key to open or close all side windows simultaneously.

- ▶ Close the roof (▷ page 87).
- ▶ Open the trunk partition (▷ page 89).
- ▶ **Vehicles without KEYLESS-GO:** point the tip of the SmartKey at the door handle on the driver's door.
- ▶ **Vehicles with KEYLESS-GO:** the SmartKey must be within 6 ft (2 m) of the vehicle.
- ▶ **To open all side windows:** press the  button on the key until the side windows are fully opened.
- ▶ **To interrupt the opening procedure:** release the  button.
- ▶ **To close all side windows:** press the  button on the key until the side windows are fully closed.
- ▶ **To interrupt the closing procedure:** release the  button.

Convenience closing with KEYLESS-GO

WARNING

When using the convenience closing feature, make sure that nobody can become trapped. Proceed as follows if there is a risk of entrapment:

- release the locking button on the door handle.
- pull the door handle immediately and hold it.

The side windows open.

With KEYLESS-GO you can close all side windows simultaneously. The KEYLESS-GO key must be outside the vehicle. All the doors must be closed.

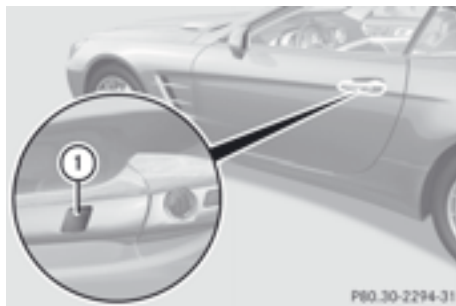

- ▶ Touch recessed sensor surface ① on the door handle until the side windows are fully closed.
- ▶ **i** Make sure you only touch recessed sensor surface ①.
- ▶ Make sure that all the side windows are closed.
- ▶ **To interrupt convenience closing:** release recessed sensor surface ① on the door handle.

Resetting the side windows

If a side window can no longer be closed fully, you must reset it.

- ▶ Close all the doors.
- ▶ Turn the SmartKey to position **1** or **2** in the ignition lock.
- ▶ Pull the corresponding switch on the door control panel until the side window is completely closed. (▷ page 83)
- ▶ Hold the switch for an additional second.

If the side window opens again slightly:

- ▶ Immediately pull the corresponding switch on the door control panel until the side window is completely closed (▷ page 83).
- ▶ Hold the switch for an additional second.
- ▶ If the corresponding side window remains closed after the button has been released, the side window has been reset correctly. If this is not the case, repeat the steps above again.

Problems with the side windows

WARNING

Closing the side windows with increased force or without the anti-entrapment feature could lead to serious or even fatal injury. Make sure that nobody can become trapped when closing the side windows.

WARNING

Pulling and holding the switch to close the door window immediately after it had been blocked two times will cause the door window to close without the anti-entrapment feature for as long as you hold the switch.

Problem	Possible causes/consequences and ► Solutions
A side window cannot be closed because it is blocked by objects, e.g. leaves in the window guide.	<ul style="list-style-type: none"> ► Remove the objects. ► Close the side window.
A side window cannot be closed and you cannot see the cause.	<p>If a side window is obstructed during closing and reopens again slightly:</p> <ul style="list-style-type: none"> ► Immediately after the window blocks, pull the corresponding switch again until the side window has closed. The side window is closed with increased force. <p>If a side window is obstructed again during closing and reopens again slightly:</p> <ul style="list-style-type: none"> ► Immediately after the window blocks, pull the corresponding switch again until the side window has closed. The side window is closed without the anti-entrapment feature.

Roof

Important safety notes

WARNING

Always open or close the roof fully before driving.

If the roof does not open or close fully, the roof hydraulic system is depressurized and the roof is lowered:

- after about seven minutes if the ignition is switched on
- after about 15 seconds if the ignition is switched off

A warning tone sounds shortly beforehand. The  symbol and **Vario-Roof Lowering** message appear in the multifunction display.

Lock the roof again before driving on. Otherwise, the unlocked roof could open during the journey and cause you to lose control of your vehicle. You and/or other persons could be injured as a result.

WARNING

Closing the roof manually is a complex, technically challenging procedure.

Attempting to manually close the roof may cause damage to the roof and/or injury.

For this reason, the manual closing process should only be carried out at a qualified specialist workshop.

- ❗ Never sit on the rear compartment trim or stow heavy objects there. You will otherwise damage the roof and rear compartment trim of the vehicle.
- ❗ Do not forget that the weather can change abruptly. Make certain that the roof is closed when you leave the vehicle. The vehicle electronics can be damaged if water enters the vehicle interior.
- ❗ When opening and closing the roof, make sure that:
 - there is sufficient clearance, as the roof swings upwards.
 - there is sufficient clearance behind the vehicle, as the trunk lid swings backwards beyond the bumper.
 - the trunk is only loaded to below the trunk partition.
 - the trunk partition is not pushed up by the load.
 - the trunk partition is closed.
 - the trunk lid is closed.
 - the outside temperature is above 5 °F (-15 °C).

You could otherwise damage the roof, trunk and other parts of the vehicle.

- ❗ Make sure that the roof and rear window are clean and dry before opening the roof. Otherwise, water or dirt could enter the vehicle interior or trunk.





Opening and closing using the roof switch

Important safety notes

WARNING

Before operating the retractable hardtop (vario-roof), make sure there is no danger of anyone being injured by the moving parts (retractable hardtop, roof frame, and trunk lid).



Hands must never be placed near the roof frame, upper windshield area, hardtop, shelf behind roll bars, or trunk lid while the retractable hardtop is being raised or lowered. Serious personal injury may occur.

If potential danger exists, release the retractable hardtop switch or the  or  button on the SmartKey. This immediately interrupts the raising or lowering procedure. You can then operate the retractable hardtop switch or press the  or  button on the SmartKey to raise or lower the retractable hardtop away from the danger zone.

Opening/closing



- ▶ Secure the vehicle against rolling away (> page 154).
- ▶ Close the trunk partition (> page 89).
- ▶ Close the trunk lid.
- ▶ Turn the SmartKey to position **2** in the ignition lock.
- ▶ Open the cover in the lower center console. Roof switch  is located under the cover.

- ▶ **To open:** pull roof switch  until the roof has been fully retracted into the trunk and the **Vario-Roof in Operation** message disappears from the multifunction display. All of the side windows open.
- ▶ **To close:** press roof switch  until the roof is fully closed and the **Vario-Roof in Operation** message disappears from the multifunction display. All of the side windows open.
- ▶ To close all side windows, pull the switch under the cover of the center console (▷ page 84).





Opening and closing using the SmartKey

Important safety notes

WARNING





Before operating the retractable hardtop (vario-roof), make sure there is no danger of anyone being injured by the moving parts (retractable hardtop, roof frame, and trunk lid).

Hands must never be placed near the roof frame, upper windshield area, hardtop, shelf behind roll bars, or trunk lid while the retractable hardtop is being raised or lowered. Serious personal injury may occur.

If potential danger exists, release the retractable hardtop switch or the  or  button on the SmartKey. This immediately interrupts the raising or lowering procedure. You can then operate the retractable hardtop switch or press the  or  button on the SmartKey to raise or lower the retractable hardtop away from the danger zone.

Opening/closing

- ▶ Close the trunk partition (▷ page 89).
- ▶ Close the trunk lid (▷ page 77).

- ▶ **Vehicles without KEYLESS-GO:** point the tip of the SmartKey at the door handle on the driver's door.
- ▶ **Vehicles with KEYLESS-GO:** the SmartKey must be within 6 ft (2 m) of the vehicle.
- ▶ **To open:** press and hold the  button on the key until the roof is fully opened. The roof and the rear side windows open. The front side windows close.
- ▶ **To interrupt the opening procedure:** release the  button.
- ▶ **To open the front side windows:** press and hold the  button on the key again.
- ▶ **To close:** press and hold the  button on the key until the roof is fully closed. The roof and the side windows close.
- ▶ **To interrupt the closing procedure:** release the  button.

- i** When the roof is closed and the trunk partition is open, the roof cannot be opened using the SmartKey functions. Instead, all of the side windows open or close simultaneously (▷ page 84).



Locking the roof again

Important safety notes

WARNING

Stop the vehicle in a safe location or as soon as it is safe to do so and lock the retractable hardtop before continuing to drive. You could otherwise endanger yourself and others.

The roof is not locked if:

- the  symbol and **Vario-Roof In Operation** message appear in the multifunction display
- the  symbol and **Open/Close Vario-Roof Completely** message appear and you hear a warning tone
- you hear a warning tone for up to 10 seconds when pulling away or while driving.

Locking

You can lock the roof again if it is not locked fully.

- ▶ Pull over and stop the vehicle safely as soon as possible, paying attention to road and traffic conditions.
- ▶ Make sure that the SmartKey is in position **2** in the ignition lock.
- ▶ Press the roof switch (▶ page 87).

Trunk partition

General notes

- ❗ To avoid damaging the roof or luggage when folding back the roof, you should:
 - only load the trunk to below the trunk partition
 - not place any objects on or in front of the trunk partition
 - not place any objects on the cover behind the roll bars
 - not allow the cargo to push the trunk partition upwards
- ❗ Make sure the trunk separator is completely closed. Otherwise, the roof can be blocked when it is opened or closed.

The trunk partition can be used to cover luggage and loads in the trunk.

Opening/closing

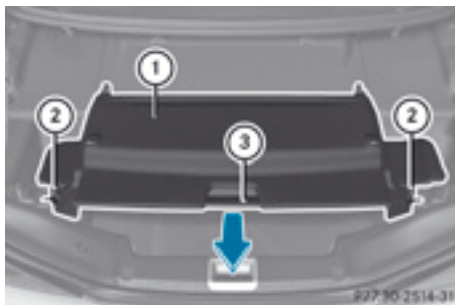

Closed trunk partition

- ① Trunk partition
- ② Eyelets
- ③ Handle

- ▶ **To close:** pull trunk partition ① in the direction of the arrow by handle ③.
- ▶ Hook trunk partition ① into fastening eyelets ② in the side panels.
- ▶ **To open:** remove trunk partition ① from fastening eyelets ② in the side panels.
- ▶ Push trunk partition ① against the direction of the arrow by handle ③.

Removing and installing

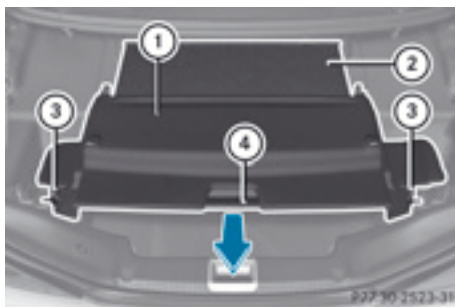

Closed trunk partition

- ① Trunk partition
- ② Net
- ③ Eyelets
- ④ Handle

- ▶ **To remove:** unhook net ② from the holder on the left and right-hand sides and guide it to the rear until it is completely rolled up.
- ▶ Remove trunk partition ① from fastening eyelets ③ in the side panels.
- ▶ Push trunk partition ① against the direction of the arrow by handle ④.

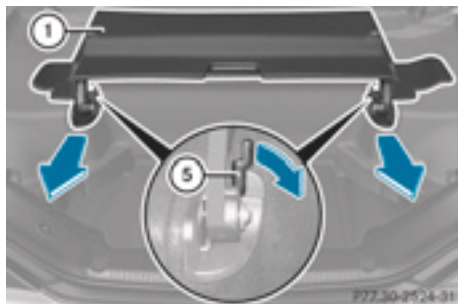

Opened trunk partition

- ① Trunk partition
- ⑤ Catch lever (example: driver's side)

- ▶ Turn driver's side catch lever ⑤ in the direction of the arrow.
- ▶ Repeat the same process on the catch lever on the passenger side. trunk partition ① is unlocked.
- ▶ Pull out trunk partition ① in the direction of the arrow.

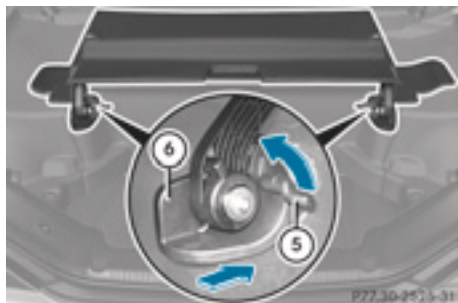

- ⑤ Catch lever (example: driver's side)
- ⑥ Guide

- ▶ **To install:** insert guides ⑥ of trunk partition ① into the brackets.
- ▶ Slide in trunk partition ① as far as it will go.
- ▶ Turn driver's side catch lever ⑤ in the direction of the arrow.
- ▶ Repeat the same process on the catch lever on the passenger side. trunk partition ① is unlocked.
- ▶ Pull trunk partition ① by handle ④ in the direction of the arrow.
- ▶ Hook trunk partition ① into fastening eyelets ③ in the side panels.
- ▶ Pull net ② forwards and hook the left and right-hand sides into the holder.

Wind screen

Manual wind screen

Important safety notes

⚠ WARNING

If you use the wind screen in darkness or in other conditions offering poor visibility, your view to the rear is further impaired. As a result of the visibility impairment, you could cause an accident and injure yourself or others. For this reason, fold back the wind screen as soon as it is dark or if your vision is otherwise restricted.

⚠ WARNING

You could lose control of the vehicle and injure yourself or others if you operate the wind screen while driving.

Install or remove the wind screen only when the vehicle is stationary.

⚠ WARNING

If the wind screen is not correctly engaged, it may break free and thus obstruct traffic behind you or lead to an accident.

Each time before driving with the roof down, check that the wind screen is properly engaged.

- ! Install or remove the wind screen only when the roof is open. You could otherwise damage the wind screen or the vehicle interior.

The wind screen offers protection from the wind when driving with the roof down.

The wind screen can be installed or removed from the driver's side or passenger side. We recommend that a second person assists you when doing this.

Perform operations involving the wind screen preferably on the side facing away from traffic, after you have stopped the vehicle, paying attention to road and traffic conditions.

Installing/removing



Rear brackets for wind screen

- ① Bracket cover, front-passenger side
 - ② Bracket cover, driver's side
- ▶ **To install:** open the roof (▶ page 87).
 - ▶ Press the mark on cover ① and push in the direction of the arrow.
 - ▶ Repeat the procedure with cover ②. The rear brackets for wind screen ③ are visible.

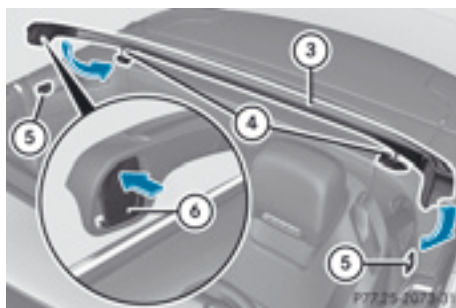

- ③ Wind screen
- ④ Pin
- ⑤ Front brackets for wind screen
- ⑥ Example: lock cover, front-passenger side

- ▶ Make sure that wind screen ③ is folded back.
- ▶ Push the upper half of cover ⑥ on wind screen ③.
- ▶ Repeat the procedure with the cover on the driver's side. Wind screen ③ is unlocked.
- ▶ Hold wind screen ③ at an angle and insert pins ④ into the rear brackets. Make sure that pins ④ sit correctly in the brackets.
- ▶ Insert wind screen ③ into front brackets ⑤.
- ▶ Check whether wind screen ③ is correctly seated in all four brackets.
- ▶ Push the lower half of cover ⑥ on wind screen ③. Wind screen ③ is locked.
- ▶ Fold wind screen ③ forward if necessary.
- ▶ **To remove:** make sure that wind screen ③ is folded back.
- ▶ Push the upper half of cover ⑥ on wind screen ③. Wind screen ③ is unlocked.
- ▶ First remove wind screen ③ from front brackets ⑤.

- ▶ Hold wind screen ③ at an angle and then remove from the rear brackets.
- ▶ Slide covers ① and ② of the rear brackets against the direction of the arrow until they are fully closed.

Electrical wind screen

Important safety notes

WARNING

If you use the wind screen in darkness or in other conditions offering poor visibility, your view to the rear is further impaired. As a result of the visibility impairment, you could cause an accident and injure yourself or others. For this reason, retract the wind screen as soon as it is dark or if your vision is otherwise restricted.

- ❗ When extending or retracting the wind screen, make sure there are no objects on the rear compartment trim. Otherwise, the objects could damage the wind screen.

The wind screen offers protection from the wind when driving with the roof down. The roof must be fully open before the wind screen can be extended.

Extending and retracting

- ▶ Open the roof (> page 86).
- ▶ Open the cover in the lower center console. The switch for the electrical wind screen is under the cover.

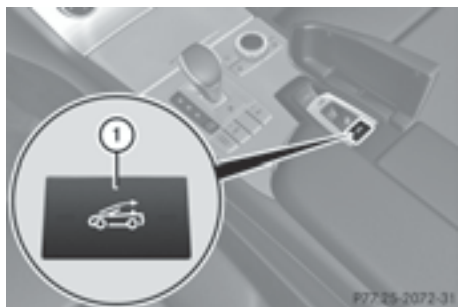

- ▶ **To extend:** press button ①.
- ▶ **To retract:** press button ① again.

Roller sunblind for the glass roof



The roller sunblind protects you from excessive glare and heat caused by the sun shining through the glass roof.

- ▶ **To close:** using handle ① slide the roller blind in the direction of the arrow.
- ▶ **To open:** using handle ① slide the roller blind in the opposite direction to the arrow.

MAGIC SKY CONTROL

General notes

MAGIC SKY CONTROL is a glass roof, the transparency of which can be changed by applying electrical voltage.

MAGIC SKY CONTROL can be switched between darkened and transparent states.

- ❗ MAGIC SKY CONTROL darkens automatically when you turn the SmartKey to position **0** in the ignition lock or remove the SmartKey.

Risk of electric shock

DANGER

The MAGIC SKY CONTROL electrical system works at high voltage.

If the cover behind the overhead control unit is damaged or is removed, electrical

components of MAGIC SKY CONTROL are exposed. These may be live. If you touch these components, you may get an electric shock and could be seriously or even fatally injured.

For this reason, never remove the cover behind the overhead control unit. Never touch parts of the electrical system (control unit, cables or cable connections).

Have all work on MAGIC SKY CONTROL carried out at a qualified specialist workshop.

The electrical components of MAGIC SKY CONTROL are protected by a paneling behind the overhead control panel.

The MAGIC SKY CONTROL control unit is marked with a yellow warning sticker that warns you of high voltage. The high-voltage cables are orange in color.

Operating MAGIC SKY CONTROL



- ▶ Turn the SmartKey to position **1** or **2** in the ignition lock.
MAGIC SKY CONTROL switches to the status it was set to before the engine was switched off.

- ▶ **To change the degree of transparency:**
press button ①.

i At sub-zero temperatures, the change is slower and uneven. The entire process may take some time.

Problems with the roof

Problem	Possible causes/consequences and ► Solutions
The roof will not open or close.	<p>The trunk partition is not in place.</p> <p>► Close the trunk partition (▷ page 89).</p>
	<p>The trunk lid is open.</p> <p>► Close the trunk lid (▷ page 78).</p>
	<p>The on-board voltage is too low.</p> <p>► Leave the engine running.</p>
	<p>The roof has been opened and closed several times in a row. The roof drive has been automatically deactivated. You can open and close the roof again after approximately ten minutes.</p> <p>► Switch off the ignition and turn it back on.</p> <p>► Repeat the opening or closing procedure.</p>
	<p>The automatic roof mechanism is faulty.</p> <p>► Consult a qualified specialist workshop.</p>

Useful information	96
Correcting the driver's seat position	96
Seats	97
Steering wheel	101
Mirrors	103
Memory function	105

Useful information

i This Operator's Manual describes all models and all standard and optional equipment of your vehicle available at the time of publication of the Operator's Manual. Country-specific differences are possible. Please note that your vehicle may not be equipped with all features described. This also applies to safety-related systems and functions.

i Read the information on qualified specialist workshops: (▷ page 31).

Correcting the driver's seat position



- ▶ Observe the safety guidelines on seat adjustment (▷ page 97).
- ▶ Check whether you have adjusted seat ③ properly.
Electrical seat adjustment (▷ page 98)

When adjusting the seat, make sure:

- you are as far away from the driver's air bag as possible.
- you are sitting in a normal upright position.
- you can fasten the seat belt properly.
- you have moved the backrest to an almost vertical position.

- you have set the seat cushion angle so that your thighs are gently supported.

- you can depress the pedals properly.

- ▶ Check whether the head restraint is adjusted properly.

When doing so, make sure that you have adjusted the head restraint so that the back of your head is supported at eye level by the center of the head restraint.

- ▶ Observe the safety guidelines on steering wheel adjustment (▷ page 101).

- ▶ Check whether steering wheel ① is adjusted properly.

Adjusting the steering wheel

(▷ page 101)

When adjusting the steering wheel, make sure:

- you can hold the steering wheel with your arms slightly bent.

- you can move your legs freely.

- you can see all the displays in the instrument cluster clearly.

- ▶ Observe the safety guidelines for seat belts (▷ page 49).

- ▶ Check whether you have fastened seat belt ② properly (▷ page 51).

The seat belt should:

- fit snugly across your body

- be routed across the middle of your shoulder

- be routed in your pelvic area across the hip joints

- ▶ Before starting off, adjust the rear-view mirror and the exterior mirrors in such a way that you have a good view of road and traffic conditions (▷ page 103).

- ▶ Store the seat, steering wheel and exterior mirror settings using the memory function (▷ page 105).

Seats

Important safety notes

WARNING

The seats can still be adjusted when there is no key in the ignition lock. For this reason, children should never be left unsupervised in the vehicle. They could otherwise become trapped when adjusting the seat.

WARNING

Make sure that the back of your head is supported at eye level by the central area of the head restraint. If your head is not supported correctly by the head restraint, you could suffer a severe neck injury in the event of an accident. Never drive if the head restraints are not engaged and set correctly.

WARNING

In order to avoid possible loss of vehicle control, all seat, head restraint, steering wheel and rear view mirror adjustments, as well as fastening of seat belts, must be done before setting the vehicle in motion.

WARNING

Do not adjust the driver's seat while driving. Adjusting the seat while driving could cause the driver to lose control of the vehicle. Never travel in a moving vehicle with the seat backrest in an excessively reclined position as this can be dangerous. You could slide under the seat belt in a collision. If you slide under it, the seat belt would apply force at the abdomen or neck. This could cause serious or fatal injuries. The seat backrest and seat belts provide the best restraint when the wearer is in a position that is as upright as possible and seat belts are properly positioned on the body.

WARNING

Your seat belt must be adjusted so that you can correctly fasten your seat belt.

Observe the following points:

- adjust the seat backrest until your arms are slightly angled when holding the steering wheel.
- adjust the seat to a comfortable seating position that still allows you to reach the accelerator/brake pedal safely. The position should be as far back as possible with the driver still able to operate the controls properly.
- adjust the head restraint so that it is as close to the head as possible and the center of the head restraint supports the back of the head at eye level.
- never place hands under the seat or near any moving parts while a seat is being adjusted.

Failure to do so could result in an accident and/or serious personal injury.

WARNING

Children 12 years old and under must be seated and properly secured in an appropriate infant restraint, toddler restraint, or booster seat recommended for the size and weight of the child. Additional information can be found under "Children in the vehicle".

A child's risk of serious or fatal injuries is significantly increased if the child restraints are not properly secured in the vehicle and/or the child is not properly secured in the child restraint.

 To avoid damage to the seats and the seat heating, observe the following information:

- keep liquids from spilling on the seats. If liquid is spilled on the seats, dry them as soon as possible.
- if the seat covers are damp or wet, do not switch on the seat heating. The seat heating should also not be used to dry the seats.
- clean the seat covers as recommended; see "Interior care".

- do not transport heavy loads on the seats. Do not place sharp objects on the seat cushions, e.g. knives, nails or tools. The seats should only be occupied by passengers, if possible.
- when the seat heating is in operation, do not cover the seats with insulating materials, e.g. blankets, coats, bags, seat covers, child seats or booster seats.

! Make sure that there are no objects in the footwell or behind the seats when resetting the seats. There is a risk that the seats and/or the objects could be damaged.

i The head restraints cannot be removed. For more information, contact a qualified specialist workshop.

Adjusting the seats electrically

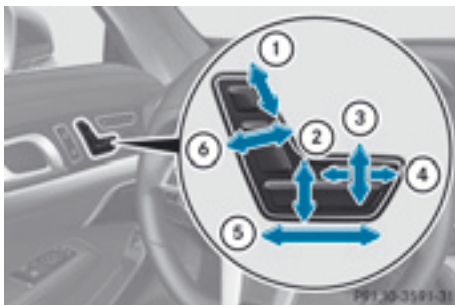

- ① Head restraint height
- ② Seat height
- ③ Seat cushion angle
- ④ Seat cushion length
- ⑤ Seat fore-and-aft adjustment
- ⑥ Backrest angle

i Further related subjects:

- You can store the seat settings using the memory function (▷ page 105).
- If PRE-SAFE® is triggered, the front-passenger seat will be moved to a better position if it was previously in an unfavorable position (▷ page 48).

Adjusting the front-passenger seat from the driver's seat

! WARNING

When adjusting the front passenger seat, make sure the seat, if occupied, is as far from the front passenger front air bag as possible. Otherwise, the passenger could be seriously or even fatally injured in the event of an accident or braking maneuver.

Make sure no one is caught or injured while the seat is being adjusted.

Even with the SmartKey or SmartKey with KEYLESS-GO removed from the starter switch or the SmartKey with KEYLESS-GO removed from the vehicle, the power seats can be operated. Therefore, do not leave children unattended in the vehicle, or with access to an unlocked vehicle. A child's unsupervised access to a vehicle could result in an accident and/or serious personal injury.

! Do not move the front-passenger seat fully forwards if there are objects in the parcel net in the front-passenger footwell. The objects could otherwise be damaged.



You can use the seat switches on the driver's side to adjust the front-passenger seat.

► **To activate/deactivate:** press button ①. If the indicator lamp in button ① is lit, you can access the following functions for the front-passenger seat:

- seat adjustment
- memory function

Removing the seat belt from the belt guide

⚠ WARNING

If the seat belt is not in the seat belt guide, it no longer offers the intended level of protection in the event of an accident. This increases the risk of injury.

When driving, always route the seat belt through the seat belt guide.

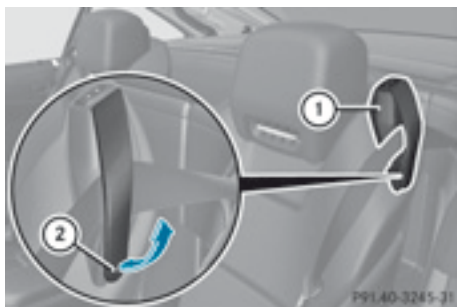

Both the driver's seat belt and the front-passenger seat belt can be removed from the seat belt guide. This makes it easier to move the seats forward.

Before you drive off, the seat belt must be inserted into the seat belt guide.

Observe the safety guidelines for seat belts (▷ page 49).

- ▶ **To remove:** open up magnetic head ② and fold the tab up in the direction of the arrow.
- ▶ Take the seat belt out of seat belt guide ①.
- ▶ **To insert:** fold the tab up in the direction of the arrow.
- ▶ Insert the seat belt back into the seat belt guide and fold the tab back down.

Moving the seats forward/back

⚠ WARNING

Make sure that nobody can become trapped when moving the seat. If there is a risk of someone becoming trapped, press the button

again or press the seat adjustment switch on the door.

Never place hands under the seat or near any moving parts while a seat is being adjusted.

- ▶ **!** Make sure that there are no containers in the cup holder and no objects in the footwell or behind the seats when adjusting the seats. Otherwise, you could damage the seats and the objects.

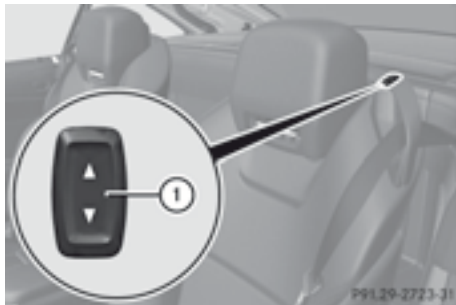

You can move the seat forwards in order to gain better access to the rear compartment, e.g. to reach the stowage compartment in the rear (▷ page 476).

- ▶ Remove the seat belt from the seat belt guide (▷ page 99).
- ▶ **To move the seat forwards:** press the button on switch ①. The seat moves automatically to the foremost position.
- ▶ **To move the seat backwards:** press the button on switch ①. The seat moves back to the previous position.
- ▶ **To stop seat movement:** press the or button in the opposite direction.

Adjusting the multicontour seat

You can set the multicontour seat using COMAND (▷ page 286).

Adjusting the active multicontour seat

You can set the active the active multicontour seat using COMAND (▷ page 287).

Adjusting the 4-way lumbar support

You can adjust the 4-way lumbar support using COMAND (▷ page 287).

Switching the seat heating on/off

Activating/deactivating



The three red indicator lamps in the button indicate the heating level you have selected.

The system automatically switches down from level **3** to level **2** after approximately eight minutes.

The system automatically switches down from level **2** to level **1** after approximately ten minutes.

The system automatically switches off approximately 20 minutes after it is set to level **1**.

You can set the distribution of the heated sections of the seat cushion and backrest using COMAND (▷ page 288).

- ▶ Make sure that the SmartKey is in position **1** or **2** in the ignition lock.
- ▶ **To switch on:** press button ① repeatedly until the desired heating level is set.
- ▶ **To switch off:** press button ① repeatedly until all the indicator lamps go out.

- ❗ If the battery voltage is too low, the seat heating may switch off.

Problems with the seat heating

The seat heating has switched off prematurely or cannot be switched on. The vehicle's electrical system voltage is too low because too many electrical consumers are switched on.

- ▶ Switch off electrical consumers that you do not need, such as the rear window defroster or interior lighting.

Switching the seat ventilation on/off

Activating/deactivating



The three blue indicator lamps in the buttons indicate the ventilation level you have selected.

- ▶ Make sure that the SmartKey is in position **2** in the ignition lock.
- ▶ **To switch on:** press button ① repeatedly until the desired ventilation level is set.
- ▶ **To switch off:** press button ① repeatedly until all the indicator lamps go out.

- ❗ If the battery voltage is too low, the seat ventilation may switch off.

- ❗ If you open the roof with the SmartKey (▷ page 88), the seat ventilation of the driver's seat switches on automatically and the side windows open.

Problems with the seat ventilation

The seat ventilation has switched off prematurely or cannot be switched on. The vehicle's electrical system voltage is too low because too many electrical consumers are switched on.

- ▶ Switch off electrical consumers which you do not need, such as the rear window defroster or interior lighting.

AIRSCARF

Activating/deactivating

WARNING

Very hot air can flow out of the AIRSCARF vents in the head restraints when AIRSCARF is in operation. This can cause burns on unprotected skin near the AIRSCARF vents. Lower the heating output in good time, when necessary.



The AIRSCARF function warms the head and neck area of vehicle occupants with warm air. The warm air flows out of the holes in the head restraints.

The three red indicator lamps in the button indicate the heating level you have selected.

- ▶ Make sure that the SmartKey is in position **2** in the ignition lock.
- ▶ **To activate:** press button **①**. Three red indicator lamps in the button light up. The blower starts up after a preheating phase of seven seconds.

- ▶ Press button **①** repeatedly until the desired heating level is set.
- ▶ **To switch off:** press button **①** repeatedly until all the indicator lamps go out.

- i** The blower continues running for seven seconds to cool down the heating elements.
- i** If the battery voltage is too low, AIRSCARF may switch off.

Steering wheel

Important safety notes

WARNING

Do not adjust the steering wheel while driving. Adjusting the steering wheel while driving could cause the driver to lose control of the vehicle.

The electrical steering wheel adjustment feature can be operated at any time. Therefore, do not leave children unattended in the vehicle, or with access to an unlocked vehicle. A child's unsupervised access to a vehicle could result in an accident and/or serious personal injury.

Adjusting the steering wheel electrically

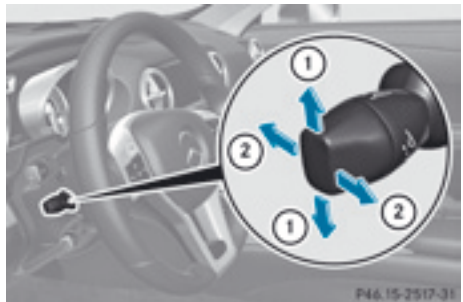

- ①** To adjust the steering wheel height
- ②** To adjust the steering wheel position (fore-and-aft adjustment)

- i** Further related subjects:
 - EASY-ENTRY/EXIT feature (▷ page 102)
 - storing settings (▷ page 105)

EASY-ENTRY/EXIT feature

Important safety notes

WARNING

Make sure that nobody can become trapped when you activate the EASY-ENTRY/EXIT feature.

If there is a risk of someone becoming trapped, stop the adjustment procedure. To halt the procedure:

- press the steering column adjustment button.
- press one of the memory function position buttons.

The steering column stops moving immediately.

Do not keep the memory function position button pressed as this will start the memory function and set the steering wheel and seat in motion.

Do not leave children unattended in the vehicle. They could open the driver's door and thereby unintentionally activate the EASY-ENTRY/EXIT feature and become trapped.

WARNING

Let the system complete the adjustment procedure before setting the vehicle in motion. All steering wheel adjustment must be completed before setting the vehicle in motion. Driving off with the steering wheel still adjusting could cause the driver to lose control of the vehicle.

The EASY-ENTRY/EXIT feature makes getting in and out of your vehicle easier.

You can activate and deactivate the EASY-ENTRY/EXIT feature in the on-board computer (▷ page 219).

Position of the steering wheel when the EASY-ENTRY/EXIT feature is active

The steering wheel swings upwards when you:

- remove the SmartKey from the ignition lock
- open the driver's door and KEYLESS-GO is in position **1**
- open the driver's door and the SmartKey is in position **0** or **1** in the ignition lock

i The steering wheel only moves upwards if it has not already reached the upper end stop.

Position of the steering wheel for driving

The steering wheel is moved to the last selected position when:

- the driver's door is closed.
- you insert the SmartKey into the ignition lock.
- or
- you press the Start/Stop button once on vehicles with KEYLESS-GO.

When you close the driver's door with the ignition switched on, the steering wheel is also automatically moved to the previously set position.

The last position of the steering wheel is stored when you switch off the ignition or when you store the setting with the memory function (▷ page 105).

Crash-responsive EASY-EXIT feature

If the crash-responsive EASY-EXIT feature is triggered in an accident, the steering column will move upwards when the driver's door is opened. This occurs irrespective of the position of the SmartKey in the ignition lock. This makes it easier to exit the vehicle and rescue the occupants.

The crash-responsive EASY-EXIT feature is only operational if the EASY-EXIT/ENTRY feature is activated in the on-board computer.

Mirrors

Rear-view mirror



- ▶ **Anti-glare mode:** flick anti-glare lever ① forwards or back.

Exterior mirrors

Adjusting the exterior mirrors

WARNING

The exterior mirrors reduce the size of the image. Objects are actually closer than they appear. You could misjudge the distance from vehicles driving behind and cause an accident, e.g. when changing lane. For this reason, make sure of the actual distance from the vehicle driving behind by glancing over your shoulder.



- ▶ Make sure that the SmartKey is in position 1 or 2 in the ignition lock.
- ▶ Press button ① for the left-hand exterior mirror or button ② for the right-hand exterior mirror.
The indicator lamp in the corresponding button lights up in red.
The indicator lamp goes out again after some time. You can adjust the selected mirror using adjustment button ③ as long as the indicator lamp is lit.
- ▶ Press adjustment button ③ up, down, to the right or to the left.
The exterior mirror must be set to a position that provides you with a good overview of traffic conditions.

The convex exterior mirrors provide a larger field of vision.

The exterior mirrors are automatically heated if the rear window defroster is switched on and the outside temperature is low.

Exterior mirror out of position

If an exterior mirror has been pushed out of position, proceed as follows:

- ▶ Move the exterior mirror into the correct position manually.
The mirror housing is engaged again and you can adjust the exterior mirrors as usual (▷ page 103).

Automatic anti-glare mirrors

WARNING

If incident light from headlamps is prevented from striking the sensor in the rear-view mirror, for instance, by luggage piled too high in the vehicle, the mirror's automatic anti-glare function will not operate.

Incident light could then blind you. This may distract you from the traffic conditions and, as a result, you may cause an accident.

The rear-view mirror and the exterior mirror on the driver's side automatically go into anti-glare mode if the following conditions are met simultaneously:

- the ignition is switched on and
- incident light from headlamps strikes the sensor in the rear-view mirror.

The mirrors do not go into anti-glare mode if reverse gear is engaged or if the interior lighting is switched on.

Parking position for the exterior mirror on the front-passenger side

Setting and storing the parking position

Using reverse gear

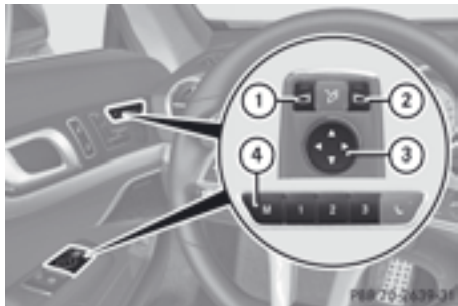

You can position the front-passenger side exterior mirror in such a way that you can see the rear wheel on that side as soon as you engage reverse gear. You can store this position.

- ▶ Make sure that the vehicle is stationary and that the SmartKey is in position **2** in the ignition lock.
- ▶ Press button **②** for the exterior mirror on the front-passenger side.
- ▶ Engage reverse gear. The exterior mirror on the front-passenger side moves to the preset parking position.
- ▶ Use adjustment button **③** to adjust the exterior mirror to a position that allows you to see the rear wheel and the curb. The parking position is stored.

i If you shift the transmission to another position, the exterior mirror on the front-passenger side returns to the driving position.

Using the memory button

You can position the front-passenger side exterior mirror in such a way that you can see the rear wheel on that side as soon as you engage reverse gear. This setting can be stored using memory button **M** **④**.

- ▶ Make sure that the SmartKey is in position **2** in the ignition lock.
- ▶ With the exterior mirror on the front-passenger side activated, use adjustment button **③** to adjust the exterior mirror. In the exterior mirror, the rear wheel and the curb should be visible.
- ▶ Press memory button **M** **④** and one of the arrows on adjustment button **③** within three seconds. The parking position is stored if the exterior mirror does not move.
- ▶ If the mirror moves out of position, repeat the steps.

Calling up a stored parking position setting

- ▶ Turn the SmartKey to position **2** in the ignition lock.
- ▶ Adjust the exterior mirror on the front-passenger side using button **②**.
- ▶ Engage reverse gear. The exterior mirror on the front-passenger side moves to the stored parking position.

The exterior mirror on the front-passenger side moves back to its original position:

- as soon as you exceed a speed of 9 mph (15 km/h)
- if you press button **①** for the exterior mirror on the driver's side

Memory function

Storing settings

WARNING

Only use the memory function on the driver's side when the vehicle is stationary. You could otherwise be distracted from the traffic conditions by the seat moving of its own accord, and as a result cause an accident.



- ▶ Adjust the seat electrically (▷ page 98).
- ▶ On the driver's side, adjust the steering wheel (▷ page 101) and the exterior mirrors (▷ page 103).
- ▶ Press memory button **M** and one of the storage position buttons **1**, **2** or **3** within three seconds.

The settings are stored in the selected preset position. A tone sounds when the settings have been completed.

Calling up a stored setting

- ▶ Press and hold the relevant storage position button **1**, **2** or **3** until the seat, steering wheel and exterior mirrors are in the stored position.
- i** The setting procedure is interrupted as soon as you release the storage position button.

Useful information	108
Exterior lighting	108
Interior lighting	115
Replacing bulbs	116
Windshield wipers	118

Useful information

- i** This Operator's Manual describes all models and all standard and optional equipment of your vehicle available at the time of publication of the Operator's Manual. Country-specific differences are possible. Please note that your vehicle may not be equipped with all features described. This also applies to safety-related systems and functions.
- i** Read the information on qualified specialist workshops: (> page 31).

Exterior lighting

Important safety notes

For reasons of safety, Mercedes-Benz recommends that you drive with the lights switched on even during the daytime. In some countries, operation of the headlamps varies due to legal requirements and self-imposed obligations.

Driving abroad

Conversion to symmetrical low beam

Switch the headlamps to symmetrical low beam in countries in which traffic drives on the opposite side of the road from the country where the vehicle is registered. This prevents glare to oncoming traffic. When using symmetrical lights, the edge of the road is not lit as widely and as far ahead as normal.



Have the headlamps converted at a qualified specialist workshop as close to the border as possible before driving in these countries.

Conversion to asymmetrical low beam after returning





Have the headlamps converted back to asymmetrical low-beam headlamps at a qualified specialist workshop as soon as possible after crossing the border again.

Light switch

Operation

- !** If the battery has been excessively discharged, the parking lamps or standing lamps are automatically switched off to enable the next engine start. Always park your vehicle safely and sufficiently lit according to legal standards. Avoid the continuous use of the  parking lamps for several hours. If possible, switch on the  right or the  left standing lamp.



- 1**  Left-hand standing lamps
- 2**  Right-hand standing lamps
- 3**  Parking lamps, license plate and instrument cluster lighting
- 4** **AUTO** Automatic headlamp mode/daytime running lamps
- 5**  Low-beam/high-beam headlamps
- 6**  Fog lamps (vehicles with front fog lamps)

If you hear a warning tone when you leave the vehicle, the lights may still be switched on.

- Turn the light switch to **AUTO**.

The turn signals, high-beam headlamps and the high-beam flasher are operated using the combination switch (> page 112).

The exterior lighting (except the parking/standing lamps) switches off automatically if you:

- remove the SmartKey from the ignition lock
- open the driver's door with the SmartKey in position **0**.

Low-beam headlamps

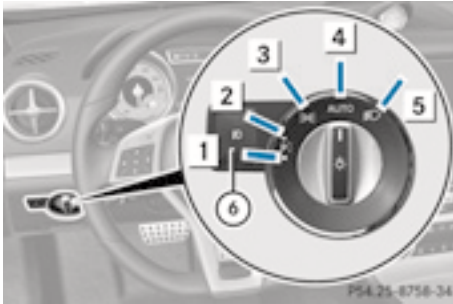

- 1 Left-hand standing lamps
- 2 Right-hand standing lamps
- 3 Parking lamps, license plate and instrument cluster lighting
- 4 **AUTO** Automatic headlamp mode/daytime running lamps
- 5 Low-beam/high-beam headlamps
- 6 Fog lamps (vehicles with front fog lamps)

- ▶ **To switch on the low-beam headlamps:** turn the SmartKey in the ignition lock to position **2** or start the engine.
- ▶ Turn the light switch to . The indicator lamp in the instrument cluster lights up.

Parking lamps



- 1 Left-hand standing lamps
- 2 Right-hand standing lamps
- 3 Parking lamps, license plate and instrument cluster lighting

- 4 **AUTO** Automatic headlamp mode/daytime running lamps
- 5 Low-beam/high-beam headlamps
- 6 Fog lamps (vehicles with front fog lamps)

- ▶ **To switch on:** turn the light switch to .

Daytime running lamps

Daytime running lamps in Canada

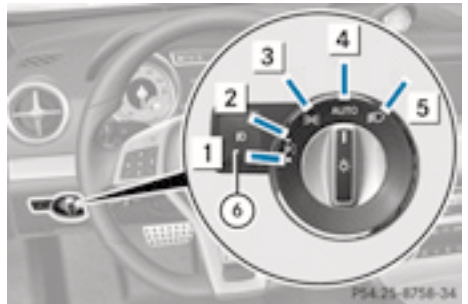

- 1 Left-hand standing lamps
- 2 Right-hand standing lamps
- 3 Parking lamps, license plate and instrument cluster lighting
- 4 **AUTO** Automatic headlamp mode/daytime running lamps
- 5 Low-beam/high-beam headlamps
- 6 Fog lamps (vehicles with front fog lamps)

The daytime running lamps function is required by law in Canada. It cannot therefore be deactivated.

- ▶ Turn the light switch to **AUTO**.
With the engine running: depending on the ambient light, the daytime running lamps or the low-beam headlamps are switched on. When the low-beam headlamps are switched on, the indicator lamp in the instrument cluster lights up.

When the engine is running and the vehicle is stationary: if you move the selector lever from a drive position to **P**, the daytime running





lamps/low-beam headlamps go out after three minutes.

When the engine is running, the vehicle is stationary and in high ambient light brightness: if you turn the light switch to , the daytime running lamps and the parking lamps are switched on.

If the engine is running and you turn the light switch to , the manual settings take precedence over the daytime running lamps.

Daytime running lamps in the USA





- 1  Left-hand standing lamps
- 2  Right-hand standing lamps
- 3  Parking lamps, license plate and instrument cluster lighting
- 4 **AUTO** Automatic headlamp mode/daytime running lamps
- 5  Low-beam/high-beam headlamps
- 6  Fog lamps (vehicles with front fog lamps)

In the USA, the daytime running lamps are deactivated upon delivery from the factory.

- ▶ **To activate:** activate the daytime running lamps function in the on-board computer (▷ page 216).
- ▶ Turn the light switch to **AUTO**.

With the engine running: depending on the ambient light, the daytime running lamps or the low-beam headlamps are switched on.

When the low-beam headlamps are switched on, the  indicator lamp in the instrument cluster lights up.

If the engine is running and you turn the light switch to , the manual settings take precedence over the daytime running lamps.





Automatic headlamp mode

WARNING

If the light switch is set to **AUTO**, the low-beam headlamps will not come on automatically if it is foggy. This could endanger you and others. Therefore, turn the light switch to  in fog.

The automatic headlamp feature is only an aid. The driver is responsible for the vehicle's lighting at all times.



- 1  Left-hand standing lamps
- 2  Right-hand standing lamps
- 3  Parking lamps, license plate and instrument cluster lighting
- 4 **AUTO** Automatic headlamp mode/daytime running lamps
- 5  Low-beam/high-beam headlamps
- 6  Fog lamps (vehicles with front fog lamps)

- ▶ **To switch on automatic headlamp mode:** turn the light switch to **AUTO**.

SmartKey in position 1 in the ignition lock: the parking lamps are switched on or off automatically depending on the brightness of the ambient light.

With the engine running: if you have activated the daytime running lamps function in the on-board computer, the daytime running lamps or the low-beam

headlamps are switched on or off automatically depending on the brightness of the ambient light.





When the low-beam headlamps are switched on, the  indicator lamp in the instrument cluster lights up.

Front fog lamps

WARNING

If you suspect that driving conditions will be foggy, turn the light switch to  before you start your journey. Your vehicle may otherwise not be visible and you could endanger yourself and others.



- 1  Left-hand standing lamps
- 2  Right-hand standing lamps
- 3  Parking lamps, license plate and instrument cluster lighting
- 4 **AUTO** Automatic headlamp mode/daytime running lamps
- 5  Low-beam/high-beam headlamps
- 6  Fog lamps (vehicles with front fog lamps)

► **To switch on the front fog lamps:** turn the SmartKey in the ignition lock to position **2** or start the engine.

► Turn the light switch to  or **AUTO**.

► Press the  button.

The green  indicator lamp in the instrument cluster lights up.





► **To switch off the front fog lamps:** press the  button.

The green  indicator lamp in the instrument cluster goes out.

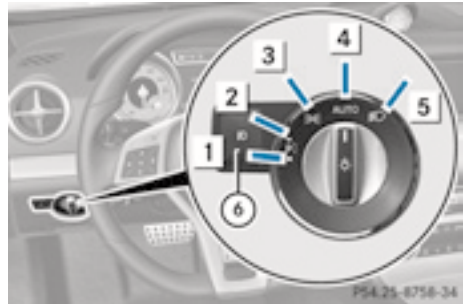
Only vehicles with front fog lamps have the fog lamps function.



Standing lamps



- 1  Left-hand standing lamps
- 2  Right-hand standing lamps
- 3  Parking lamps, license plate and instrument cluster lighting
- 4 **AUTO** Automatic headlamp mode/daytime running lamps
- 5  Low-beam/high-beam headlamps
- 6  Fog lamps (vehicles with front fog lamps)

If you switch on the standing lamps, the parking lamps on one side of the vehicle are lit dimly.

► **To switch on the standing lamps:** the SmartKey is not in the ignition lock or it is in position **0**.

► Turn the light switch to  (left-hand side of the vehicle) or  (right-hand side of the vehicle).

Combination switch

Turn signals

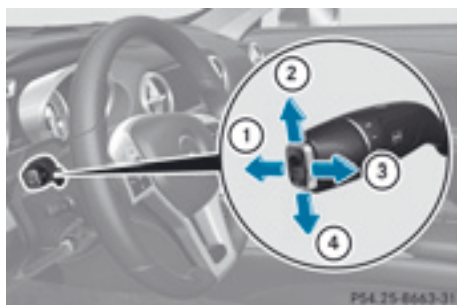

- ① High-beam headlamps
- ② Turn signal, right
- ③ High-beam flasher
- ④ Turn signal, left

► **To indicate briefly:** press the combination switch briefly to the pressure point in the direction of arrow ② or ④.

The corresponding turn signal flashes three times.

► **To indicate:** press the combination switch beyond the pressure point in the direction of arrow ② or ④.

High-beam headlamps

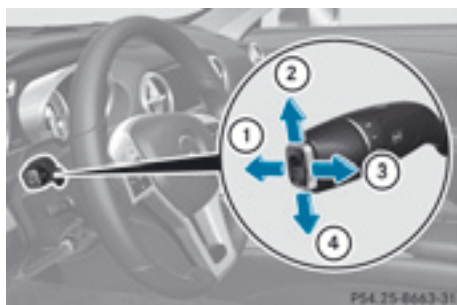

- ① High-beam headlamps
- ② Turn signal, right
- ③ High-beam flasher
- ④ Turn signal, left

► **To switch on the high-beam headlamps:** turn the SmartKey in the ignition lock to position 2 or start the engine.

► Turn the light switch to  or **AUTO**.

► Press the combination switch beyond the pressure point in the direction of arrow ①.

In the **AUTO** position, the high-beam headlamps are only switched on when it is dark and the engine is running.

The  indicator lamp in the instrument cluster lights up when the high-beam headlamps are switched on.

► **To switch off the high-beam headlamps:** move the combination switch back to its normal position.

The  indicator lamp in the instrument cluster goes out.

High-beam flasher

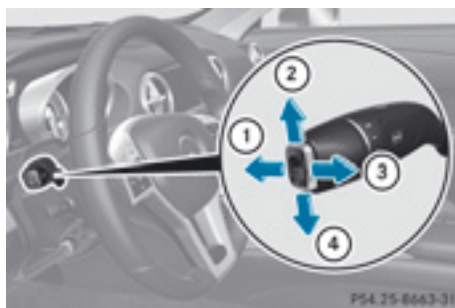

- ① High-beam headlamps
- ② Turn signal, right
- ③ High-beam flasher
- ④ Turn signal, left

► **To switch on:** turn the SmartKey in the ignition lock to position 1 or 2 or start the engine.

► Pull the combination switch in the direction of arrow ③.

Hazard warning lamps



► **To switch on the hazard warning lamps:** press button ①.

All turn signals flash. If you now switch on a turn signal using the combination switch, only the turn signal lamp on the corresponding side of the vehicle will flash.

► **To switch off the hazard warning lamps:** press button ①.

The hazard warning lamps automatically switch on if:

- an air bag is deployed.
- the vehicle decelerates rapidly from a speed of more than 45mph (70 km/h) and comes to a standstill.

The hazard warning lamps switch off automatically if the vehicle reaches a speed of over 6mph (10km/h) again after a full brake application.

① The hazard warning lamps still operate if the ignition is switched off.

Headlamp cleaning system

The headlamps are cleaned automatically if the "Wipe with washer fluid" function is operated five times while the lights are on and the engine is running (► page 118). When you switch off the ignition, the automatic headlamp cleaning system is reset and counting is resumed from 0.

Cornering light function



The cornering light function improves the illumination of the road over a wide angle in the direction you are turning, enabling better visibility in tight bends, for example. The cornering light function can only be activated when the low-beam headlamps are switched on.

Active:

- if you are driving at speeds below 25mph (40 km/h) and switch on the turn signal or turn the steering wheel
- if you are driving at speeds between 25mph (40 km/h) and 45mph (70 km/h) and turn the steering wheel

Not active: if your speed exceeds 25mph (40 km/h) or if you switch off the turn signal or turn the steering wheel to the straight-ahead position.

The cornering light function may remain lit for a short time, but is automatically switched off after no more than three minutes.

Active light function

The active light function is a system that moves the headlamps according to the steering movements of the front wheels. In this way, relevant areas remain illuminated while driving. This allows you to recognize pedestrians, cyclists and animals.

Active: when the lights are switched on.

Adaptive Highbeam Assist

Important safety notes

WARNING

The Adaptive Highbeam Assist is only an aid intended to support you while driving. The driver is and remains responsible for proper vehicle lighting in accordance with the prevailing light, sight and traffic conditions.

The system may be impaired or unavailable when

- visibility is poor, e.g. due to snow, rain, fog, or heavy spray
- the optical sensor area of the windshield is dirty, fogged up, or covered by a sticker for example

The system cannot recognize the following road users:

- Road users without a lighting system of their own, e.g. pedestrians
- Road users with dim lighting of their own, e.g. cyclists
- Road users whose lighting is obstructed, e.g. road users behind a guardrail
- In some seldom cases, even road users with a lighting system of their own may be recognized too late or not at all.

The automatic high-beam headlamps will then not be deactivated or it will be activated in spite of preceding or oncoming road users.

This could endanger you and/or others and cause an accident. Always pay close attention to the traffic situation and switch off the high beam manually if necessary.



You can use this function to set the headlamps to change between low beam and high beam automatically. The system recognizes vehicles with their lights on, either approaching from the opposite direction or traveling in front of your vehicle, and consequently switches the headlamps from high beam to low beam.

The system automatically adapts the low-beam headlamp range depending on the distance to the other vehicle. Once the system no longer detects any other vehicles, it reactivates the high-beam headlamps.

The system's optical sensor is located behind the windshield near the overhead control panel.

Switching Adaptive Highbeam Assist on/off

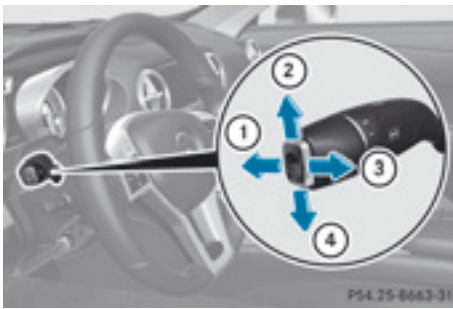

- ① High-beam headlamps
- ② Turn signal, right
- ③ High-beam flasher
- ④ Turn signal, left

- ▶ **To activate:** activate the Adaptive Highbeam Assist function using the on-board computer (▶ page 217).
- ▶ Turn the light switch to **AUTO**.
- ▶ Press the combination switch beyond the pressure point in the direction of arrow ① (▶ page 112).

The  indicator lamp in the multifunction display lights up if it is dark and the light sensor activates the low-beam headlamps.

If you are driving at speeds above approximately 28 mph (45km/h): the headlamp range is set automatically depending on the distance between the vehicle and other road users.

If you are driving at speeds above approximately 35 mph (55km/h) and no other road users have been detected: the high-beam headlamps are switched on automatically. The  indicator lamp in the instrument cluster also lights up.

If you are driving at speeds below approximately 30 mph (45km/h) or other road users have been detected or the roads are adequately lit:

The high-beam headlamps are switched off automatically. The  indicator lamp in

the instrument cluster goes out. The  indicator lamp in the multifunction display remains lit.

- ▶ **To deactivate:** move the combination switch back to its normal position. The  indicator lamp in the instrument cluster goes out.

Headlamps fogged up on the inside

The headlamps may fog up on the inside if there is high atmospheric humidity.

- ▶ Switch on the lights and drive off. The level of fogging diminishes, depending on the length of the journey and the weather conditions (humidity and temperature).

If the level of fogging does not diminish:



- ▶ Have the headlamps checked at a qualified specialist workshop.

Interior lighting

Overview of interior lighting



Example

- ①  Switches the left-hand reading lamp on/off
- ②  Switches the interior lighting on
- ③  Switches the interior lighting/automatic interior lighting control off

- ④  Switches the right-hand reading lamp on/off
- ⑤ Switches the automatic interior lighting control on

Interior lighting control

General notes

In order to prevent the vehicle's battery from discharging, the interior lighting functions are automatically deactivated after some time unless the SmartKey is in position **2** in the ignition lock.

Automatic interior lighting control



- ▶ **To switch on:** set the switch to center position ⑤.
- ▶ **To switch off:** set the switch to the  position.

The interior lighting automatically switches on if you:

- unlock the vehicle
- open a door
- remove the SmartKey from the ignition lock

The interior light is activated for a short while when the SmartKey is removed from the ignition lock. You can activate this delayed switch-off using the on-board computer (▷ page 218).

Manual interior lighting control

- ▶ **To switch the interior lighting on:** set the switch to the  position.
- ▶ **To switch the interior lighting off:** set the switch to the  or (if the door is closed) to the center position.
- ▶ **To switch the reading lamps on/off:** press the  button.

Crash-responsive emergency lighting

The interior lighting is activated automatically if the vehicle is involved in an accident.

- ▶ **To switch off the crash-responsive emergency lighting:** press the hazard warning lamp button.

or

- ▶ Lock and then unlock the vehicle using the SmartKey.

Replacing bulbs

Important safety notes

Xenon bulbs

DANGER

Xenon bulbs carry a high voltage. You could get an electric shock and be seriously or even fatally injured if you touch the electric contacts on Xenon bulbs. Therefore, never remove the cover from Xenon bulbs.

Do not change the Xenon bulbs yourself, but have them replaced at a qualified workshop.

If your vehicle is equipped with Xenon bulbs, you can recognize this by the following: the cone of light from the Xenon bulbs moves from the top to the bottom and back again when you start the engine. For this to be observed, the lights must be switched on before starting the engine.

Bulbs and lamps are an important aspect of vehicle safety. You must therefore make sure that these function correctly at all times. Have the headlamp setting checked regularly.

Other bulbs

WARNING

Bulbs and lamps can become very hot. For this reason, allow them to cool down before changing them. Otherwise, you could burn yourself when you touch them.

Keep bulbs out of the reach of children. Otherwise, they could, for example, damage the bulbs and injure themselves.

Never use a bulb which has been dropped. Such a bulb may explode and injure you.

Halogen bulbs are pressurized and could explode when you change them, especially if they are very hot. You should therefore wear eye protection and gloves when you are changing them.

There are bulbs other than the Xenon bulbs that you cannot replace. Replace only the bulbs listed (▷ page 117). Have the bulbs that you cannot replace yourself changed at a qualified specialist workshop.

If you require assistance changing bulbs, consult a qualified specialist workshop.

Do not touch the glass tube of new bulbs with your bare hands. Even minor contamination can burn into the glass surface and reduce the service life of the bulbs. Always use a lint-free cloth or only touch the base of the bulb when installing.

Only use bulbs of the correct type.

If the new bulb still does not light up, consult a qualified specialist workshop.

Bulbs and lamps are an important aspect of vehicle safety. You must therefore make sure that these function correctly at all times. Have the headlamp setting checked regularly.

Overview: changing bulbs/bulb types

You can change the following bulbs. The bulb type can be found in the legend.

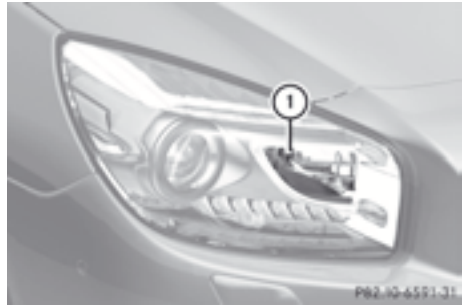

Vehicles without Intelligent Light System

① Fog lamp: H7 55 W

Changing the front bulbs

Front fog lamps (without Intelligent Light System)

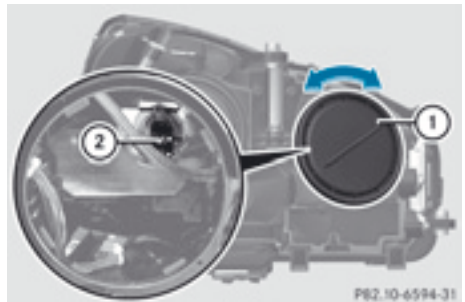

- ▶ Switch off the lights.
- ▶ Open the hood.
- ▶ Turn housing cover ① counter-clockwise and pull it out.
- ▶ Push the bulb upwards by the holder, disconnect it and pull it out of bulb holder ②.
- ▶ Insert the new bulb into bulb holder ②, push it down and secure it in place.
- ▶ Attach housing cover ① and turn it clockwise until it engages.

Windshield wipers

Switching the windshield wipers on/off

WARNING

The windshield will no longer be wiped properly if the wiper blades are worn. This could prevent you from observing the traffic conditions, thereby causing an accident. Replace the wiper blades twice a year, ideally in spring and fall.

-  Do not operate the windshield wipers when the windshield is dry, as this could damage the wiper blades. Moreover, dust that has collected on the windshield can scratch the glass if wiping takes place when the windshield is dry.

If it is necessary to switch on the windshield wipers in dry weather conditions, always use washer fluid when operating the windshield wipers.





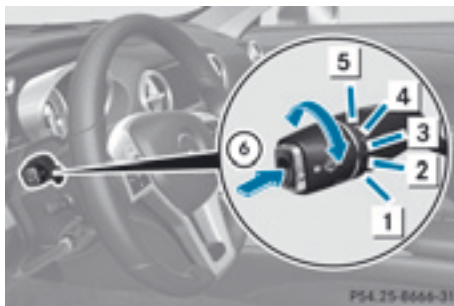

-  If the windshield wipers leave smears on the windshield after the vehicle has been washed in an automatic car wash, wax or other residues may be the reason for this. Clean the windshield using washer fluid after washing the vehicle in an automatic car wash.

-  Intermittent wiping with rain sensor: due to optical influences and the windshield becoming dirty in dry weather conditions, the windshield wipers may be activated inadvertently. This could then damage the windshield wiper blades or scratch the windshield.





For this reason, you should always switch off the windshield wipers in dry weather.





Combination switch

- 1  Windshield wipers off
- 2  Intermittent wipe, low (rain sensor set to low sensitivity)
- 3  Intermittent wipe, high (rain sensor set to high sensitivity)
- 4  Continuous wipe, slow
- 5  Continuous wipe, fast
- 6  Single wipe/  To wipe the windshield using washer fluid

- Switch on the ignition.
- Turn the combination switch to the corresponding position.

In the  or  position, the appropriate wiping frequency is set automatically according to the intensity of the rain. In the  position, the rain sensor is more sensitive than in the  position, causing the windshield wipers to wipe more frequently.

-  The vehicle is equipped with an adaptive wiper system with Aquablades. The washer fluid is fed through the wiper blades and when wiping the screen with washer fluid,  the water is emitted directly from the blades.

Replacing the wiper blades

Important safety notes

WARNING

For safety reasons, switch off the windshield wipers and remove the SmartKey from the ignition lock before changing the wiper blades (vehicles with KEYLESS-GO: make sure that the on-board electronics are in state **0**). Otherwise, the wiper motor could be switched on suddenly and cause injury.

- !** To avoid damaging the wiper blades, make sure that you touch only the wiper arm of the wiper.
- !** Never open the hood if a windshield wiper arm has been folded away from the windshield.

Never fold a windshield wiper arm without a wiper blade back onto the windshield.

Hold the windshield wiper arm firmly when you change the wiper blade. If you release the windshield wiper arm without a wiper blade and it falls onto the windshield, the windshield may be damaged by the force of the impact.

Mercedes-Benz recommends that you have the wiper blades changed at a qualified specialist workshop.

- !** Always position the windshield wiper arms vertically before folding them away from the windshield. By doing so, you will avoid damage to the hood.

Changing the windshield wiper blades

Moving the wiper arm to a vertical position

On vehicles without KEYLESS-GO:

- ▶ Turn the SmartKey to position **1** or **2** in the ignition lock.
- ▶ Set the windshield wipers to position .
- ▶ When the wiper arms have reached a vertical position, turn the SmartKey to

position **0** and remove it from the ignition lock.

- ▶ Fold the wiper arm away from the windshield until it engages.

On vehicles with KEYLESS-GO:

- ▶ Switch off the engine.
- ▶ Remove your foot from the brake pedal.
- ▶ Set the windshield wipers to position .
- ▶ Press the Start/Stop button repeatedly until the windshield wipers start.
- ▶ When the wiper arms have reached a vertical position, press the Start/Stop button.
- ▶ Fold the wiper arm away from the windshield until it engages.

Removing the wiper blades

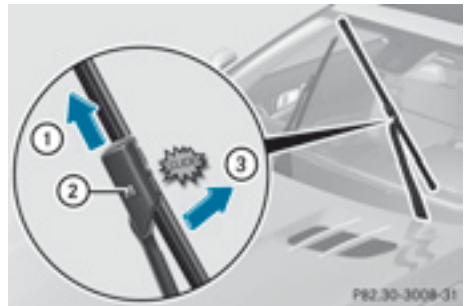

- ▶ **To bring the wiper blade into position to be removed:** hold the wiper arm with one hand and push the wiper blade in the direction of arrow **③** with the other hand. The wiper blade engages with an audible click.
- ▶ **To remove a wiper blade:** firmly press release knob **②** and pull the wiper blade upwards **①**.

Installing the wiper blades



- ▶ Position the new wiper blade with tab ② in the retainer on the wiper arm and slide it into place in the direction of arrow ①. The wiper blade audibly engages.
- ▶ Push the wiper blade back into position in the direction of arrow ③. The wiper blade is freely movable again.
- ▶ Make sure that wiper blade is seated correctly.
- ▶ Fold the wiper arm back onto the windshield.

Problems with the windshield wipers

The windshield wipers are obstructed

- ▶ For safety reasons, you should remove the SmartKey from the ignition lock.

or

- ▶ Switch off the engine using the Start/Stop button and open the driver's door.
- ▶ Remove the cause of the obstruction.
- ▶ Switch the windshield wipers back on.

The windshield wipers are inoperative

The windshield wiper drive is malfunctioning.

- ▶ Select another wiper speed on the combination switch.
- ▶ Have the windshield wipers checked at a qualified specialist workshop.

Useful information	122
Overview of climate control systems	122
Operating the climate control systems	125
Setting the air vents	131

Useful information

- i** This Operator's Manual describes all models and all standard and optional equipment of your vehicle available at the time of publication of the Operator's Manual. Country-specific differences are possible. Please note that your vehicle may not be equipped with all features described. This also applies to safety-related systems and functions.
- i** Read the information on qualified specialist workshops: (> page 31).

Overview of climate control systems

Important safety notes

WARNING

Observe the settings recommended on the following pages. The windows could otherwise fog up. This could prevent you from observing the traffic conditions, thereby causing an accident.

WARNING

Severe conditions (e.g. strong air pollution) may require replacement of the filter before its scheduled replacement interval. A clogged filter will reduce the air volume to the interior and the windows could fog up, impairing visibility and endangering you and others. Have a clogged filter replaced as soon as possible at a qualified specialist workshop.

- i** Ventilate the vehicle for a brief period during warm weather. This will speed up the cooling process and the desired vehicle interior temperature will be reached more quickly.
- i** It is possible that the residual heat function may be activated automatically an hour after the SmartKey is removed. The vehicle is then ventilated for 30 minutes to dry the air-conditioning system.

Climate control regulates the temperature and the humidity in the vehicle interior and filters undesirable substances out of the air. Climate control is only operational when the engine is running. The system only works optimally when the side windows and the roof are closed.

The residual heat function can only be activated or deactivated with the ignition switched off (> page 130).

Control panel for 2-zone automatic climate control

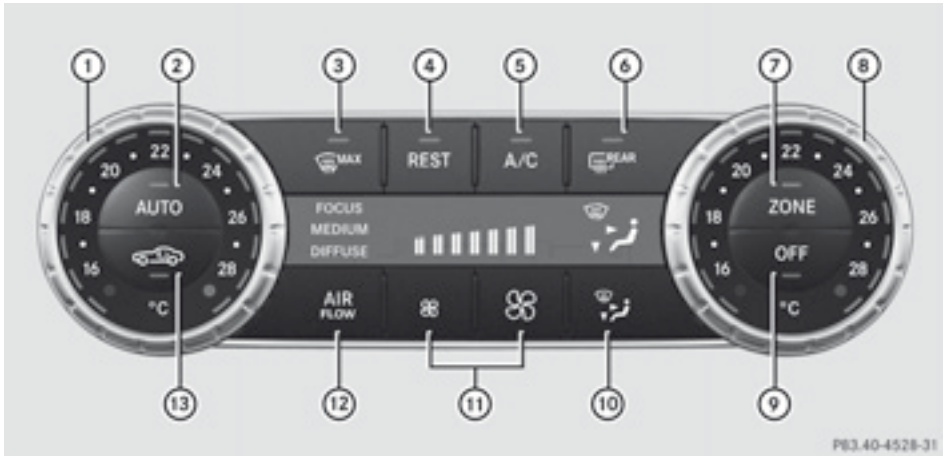

Canada only

- ① Sets the temperature, left (▷ page 127)
- ② Sets climate control to automatic (▷ page 126)
- ③ Defrosts the windshield (▷ page 128)
- ④ Activates/deactivates the residual heat function (▷ page 130)
- ⑤ Activates/deactivates cooling with air dehumidification (▷ page 125)
- ⑥ Switches the rear window defroster on/off (▷ page 129)
- ⑦ Switches the ZONE function on/off (▷ page 128)
- ⑧ Sets the temperature, right (▷ page 127)
- ⑨ Switches climate control on/off (▷ page 125)
- ⑩ Sets the air distribution (▷ page 127)
- ⑪ Sets the airflow (▷ page 127)
- ⑫ Sets the climate mode (▷ page 126)
- ⑬ Activates/deactivates air-recirculation mode (▷ page 130)

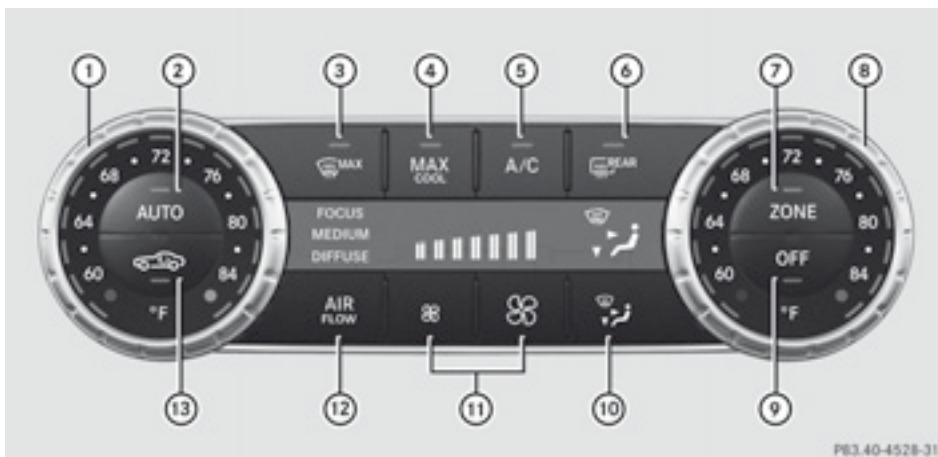

USA only

- ① Sets the temperature, left (▷ page 127)
- ② Sets climate control to automatic (▷ page 126)
- ③ Defrosts the windshield (▷ page 128)
- ④ Switches the maximum cooling MAX COOL on/off (▷ page 128)
- ⑤ Activates/deactivates cooling with air dehumidification (▷ page 125)
- ⑥ Switches the rear window defroster on/off (▷ page 129)
- ⑦ Switches the ZONE function on/off (▷ page 128)
- ⑧ Sets the temperature, right (▷ page 127)
- ⑨ Switches climate control on/off (▷ page 125)
- ⑩ Sets the air distribution (▷ page 127)
- ⑪ Sets the airflow (▷ page 127)
- ⑫ Sets the climate mode (▷ page 126)
- ⑬ Activates/deactivates air-recirculation mode (▷ page 130)

Information regarding the use of automatic climate control

The following contains instructions and recommendations to enable you to get the most out of your automatic climate control.

- Activate climate control using the **AUTO** and **A/C** buttons. The indicator lamps in the **AUTO** and **A/C** buttons light up.
- In automatic mode, you can also use the **AIR FLOW** button to set a climate mode (FOCUS/MEDIUM/DIFFUSE). The MEDIUM level is recommended.
- Set the temperature to 72 °F (22 °C).
- Only use the "defrosting" function briefly until the windshield is clear again.
- Only use "air-recirculation" mode briefly, e.g. if there are unpleasant outside odors or when in a tunnel. The windows could otherwise fog up as in air-recirculation mode no fresh air is drawn into the vehicle.
- Use the ZONE function to adopt the temperature settings on the driver's side

for the front-passenger side as well. The indicator lamp in the **ZONE** button goes out.

- Use the residual heat function if you want to heat or ventilate the vehicle interior when the ignition is switched off. The "residual heat" function can only be activated or deactivated with the ignition switched off.

Operating the climate control systems

Activating/deactivating climate control

General notes

WARNING

When the climate control system is switched off, the outside air supply and circulation are also switched off. Only choose this setting for a short time when the retractable hardtop (vario-roof) is closed. Otherwise, the windows could fog up, impairing visibility and endangering you and others.

-  Switch on climate control primarily using the **AUTO** button (▷ page 126).

Activating/deactivating

- ▶ Turn the SmartKey to position **2** in the ignition lock.
 - ▶ **To switch on:** press button **AUTO**.
The indicator lamp in the **AUTO** button lights up. Airflow and air distribution are set to automatic mode.
- or
- ▶ Press the **OFF** button.
The indicator lamp in the **OFF** button goes out. The previously selected settings come into effect again.
 - ▶ **To switch off:** press the **OFF** button.
The indicator lamp in the **OFF** button lights up.

Activating/deactivating cooling with air dehumidification

General notes

WARNING

If you switch off the cooling function, the vehicle will not be cooled when weather conditions are warm. The windows can fog up more quickly. This may prevent you from observing the traffic conditions, thereby causing an accident.

The cooling with air dehumidification function is only available when the engine is running. The air inside the vehicle is cooled and dehumidified according to the temperature selected.





Condensation may drip from the underside of the vehicle when it is in cooling mode. This is normal and not a sign that there is a malfunction.

-  The cooling with air dehumidification function uses refrigerant R1234yF. This coolant does not contain chlorofluorocarbons, and therefore does not damage the ozone layer.

Activating/deactivating



Example: **A/C** button

- ▶ **To activate:** press the  button. The indicator lamp in the  button lights up.
- ▶ **To deactivate:** press the  button. The indicator lamp in the  button goes out. The cooling with air dehumidification function has a delayed switch-off feature.

Problems with the cooling with air dehumidification function

When you press the  button, the indicator lamp in the button flashes three times or remains off. You can no longer switch on the cooling with air dehumidification function.

- ▶ Visit a qualified specialist workshop.

Setting climate control to automatic

WARNING



If you switch off the cooling function, the vehicle will not be cooled when weather conditions are warm. The windows can fog up more quickly. Window fogging may impair visibility and endanger you and others.



In automatic mode, the set temperature is maintained automatically at a constant level. The system automatically regulates the temperature of the dispensed air, the airflow and the air distribution.

Automatic mode will achieve optimal operation if cooling with air dehumidification



is also activated. If desired, cooling with air dehumidification can be deactivated.

- ▶ Turn the SmartKey to position **2** in the ignition lock.
- ▶ Set the desired temperature.
- ▶ **To activate:** press the  button. The indicator lamp in the  button lights up. Automatic air distribution and airflow are activated.

i Dual-zone automatic climate control: when automatic mode is activated, you can select a climate mode (▶ page 126).

- ▶ **To switch off:** press the  button.

or

- ▶ Press the  or  button. The indicator lamp in the  button goes out.

Adjusting the climate mode settings (AIR FLOW)

You can select the following climate mode settings in automatic mode:

- FOCUS** high airflow that is set slightly cooler
- MEDIUM** medium airflow, standard setting
- DIFFUSE** low airflow that is set slightly warmer and with less draft

The climate mode settings are especially effective at high outside temperatures.



Example:  button

- ▶ Turn the SmartKey to position **2** in the ignition lock.
- ▶ Press the **AUTO** button.
- ▶ Press the **AIR FLOW** button repeatedly until the desired climate mode appears in the display.

Setting the temperature



Different temperatures can be set for the driver's and front-passenger sides.

- ▶ Turn the SmartKey to position **2** in the ignition lock.
- ▶ Turn controls ① or ② clockwise or counter-clockwise.
Only change the temperature setting in small increments. Start at 72 °F (22 °C).

Setting the air distribution



- ▶ Turn the SmartKey to position **2** in the ignition lock.
- ▶ Press the **AIR FLOW** button repeatedly until the desired symbol appears in the display.

- Directs air through the center and side air vents
- Directs air through the footwell air vents
- Directs air through the center, side and footwell vents
- Directs air through the defroster vents
- Directs air through the defroster, center and side air vents¹
- Directs air through the defroster and footwell vents
- Directs air through the defroster, center and side air vents as well as the footwell air vents¹.

i Regardless of the air distribution setting, airflow is always directed through the side air vents. The side air vents can only be closed when the controls on the side air vents are turned downwards.

Setting the airflow







- ▶ Turn the SmartKey to position **2** in the ignition lock.
- ▶ **To increase:** press the button.
- ▶ **To reduce:** press the button.

¹ Canada only.

Switching the ZONE function on/off



- ▶ **To switch on:** press the  button. The indicator lamp in the  button lights up. The temperature setting for the driver's side is not adopted for the front-passenger side.
- ▶ **To switch off:** press the  button. The indicator lamp in the  button goes out. The temperature setting for the driver's side is adopted for the front-passenger side.





Defrosting the windshield





Example:  button

You can use this function to defrost the windshield or to demist the inside of the windshield and the side windows.



Switch off the defrosting function as soon as the windshield is clear again.

- ▶ Turn the SmartKey to position **2** in the ignition lock.
- ▶ **To activate:** press the  button. The indicator lamp in the  button lights up. The climate control system switches to the following functions:
 - cooling with air dehumidification on
 - high airflow (depending on the outside temperature)
 - high temperature (depending on the outside temperature)
 - air distribution to the windshield and front side windows
 - air-recirculation mode off
- ▶ **To switch off:** press the  button. The indicator lamp in the  button goes out. The previously selected settings come into effect again. The cooling with air dehumidification function remains on. Air-recirculation mode remains deactivated.

or

- ▶ Press the  button. The indicator lamp in the  button goes out. Airflow and air distribution are set to automatic mode.

or

- ▶ Turn temperature control  or  clockwise or counter-clockwise.

or



- ▶ Press the  or  button.

MAX COOL maximum cooling

The MAX COOL function is only available in vehicles for the USA.



MAX COOL is only operational when the engine is running.



- ▶ **To activate:** press the  button. The indicator lamp in the button lights up.
- ▶ **To deactivate:** press the  button again. The indicator lamp goes out. The previously selected settings come into effect again.

When you activate MAX COOL, climate control switches to the following functions:



- maximum cooling
- maximum airflow
- air-recirculation mode on

Defrosting the windows

Windows fogged up on the inside

- ▶ Activate the  cooling with air dehumidification function.
- ▶ Activate automatic mode .
- ▶ If the windows continue to fog up, activate the defrosting function (▷ page 128).
- i** You should only select this setting until the windshield is clear again.

Windows fogged up on the outside

- ▶ Activate the windshield wipers.
- ▶ Press the  button repeatedly until the  or  symbol appears in the display.
- i** You should only select this setting until the windshield is clear again.

Rear window defroster

Activating/deactivating



WARNING

Clear all windows of ice or snow before setting off. Otherwise, impaired visibility could endanger you and others.



The rear window defroster has a high current draw. You should therefore switch it off as soon as the window is clear. It otherwise switches off automatically after several minutes.

If the battery voltage is too low, the rear window defroster may switch off.

- ▶ Turn the SmartKey to position **2** in the ignition lock.
- ▶ Press the  button. The indicator lamp in the  button lights up or goes out.

Problems with the rear window defroster

The rear window defroster has deactivated prematurely or cannot be activated.





- ▶ Switch off any consumers that are not required, e.g. reading lamps or interior lighting. When the battery is sufficiently charged, the rear window defroster is activated again automatically.

Activating/deactivating air-recirculation mode

WARNING

At low outside temperatures, only switch over to air-recirculation mode for brief periods. Otherwise, the windows could fog up, thus impairing visibility and endangering yourself and others. This may prevent you from observing the traffic conditions and thereby cause an accident.



- ▶ Turn the SmartKey to position **2** in the ignition lock.
- ▶ **To activate:** press the  button. The indicator lamp in the  button lights up.
- i** Air-recirculation mode is automatically activated at high levels of pollution or at high outside temperatures. When air-recirculation mode is activated automatically, the indicator lamp in the  button is not lit. Outside air is added after about 30 minutes.
- ▶ **To switch off:** press the  button. The indicator lamp in the  button goes out.

i Air-recirculation mode deactivates automatically:



- after approximately five minutes at outside temperatures below approximately 41 °F (5 °C)
- after approximately five minutes if cooling with air dehumidification is deactivated
- after approximately 30 minutes at outside temperatures above approximately 41 °F (5 °C)

Activating/deactivating the residual heat function

The residual heat function is only available on vehicles for Canada.



It is possible to make use of the residual heat of the engine to continue heating the stationary vehicle for up to 30 minutes after the engine has been switched off. The heating time depends on the temperature that has been set.

- ▶ Turn the SmartKey to position **0** in the ignition lock or remove it.
- ▶ **To activate:** press the  button. The indicator lamp in the  button lights up.
- i** The blower will run at a low speed regardless of the airflow setting.
- i** If you activate the residual heat function at high temperatures, only the ventilation

will be activated. The blower runs at medium speed.

- ▶ **To switch off:** press the **REST** button. The indicator lamp in the **REST** button goes out.

Residual heat is deactivated automatically:

- after approximately 30 minutes
- when the ignition is switched on
- if the battery voltage drops
- if the coolant temperature is too low

Setting the air vents

Important safety notes

WARNING

Very hot or very cold air can flow from the air vents. This could cause burns or frostbite to bare skin in the immediate vicinity of the vents. Keep bare skin away from these air vents. If necessary, direct the airflow away to a different area of the vehicle interior.

In order to ensure the direct flow of fresh air through the air vents into the vehicle interior, please observe the following notes:

- keep the air inlet grille on the hood and in the engine compartment on the front-passenger side free of blockages, such as ice, snow or leaves.
 - never cover the air vents or air intake grilles in the vehicle interior.
- i** You can move the adjusters for the air vents vertically or horizontally to set the direction of the airflow.
 - i** For optimal climate control in the vehicle, open the air vents completely and set the adjusters to the central position.

Setting the center air vents

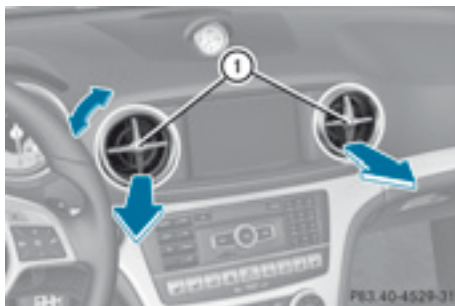

- ▶ **To open a center air vent:** turn the adjuster in one of center air vents ① counterclockwise.
- ▶ **To close a center air vent:** turn the adjuster in one of center air vents ① clockwise until it engages.

Setting the side air vents

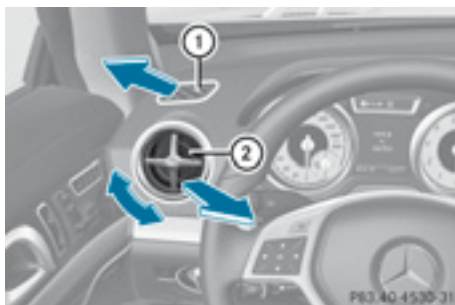

- ① Side window defroster vent
- ② Side air vent

- ▶ **To open a side air vent:** turn the adjuster in side air vent ② counterclockwise.
- ▶ **To close a side air vent:** turn the adjuster in side air vent ② clockwise until it engages.

Setting the glove box air vent

- ▶ **!** Close the air vent when heating the vehicle.

At high outside temperatures, open the air vent and activate the "cooling with air dehumidification" function. Otherwise, temperature-sensitive items stored in the glove box could be damaged.

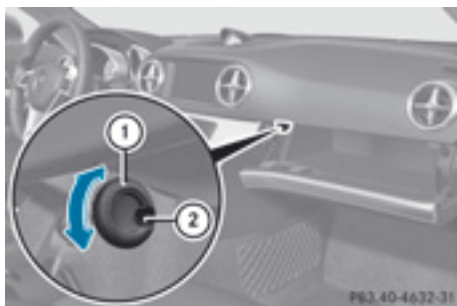

- ① Air vent thumbwheel
- ② Air vent

When automatic climate control is activated, the glove box can be ventilated, for instance to cool its contents. The level of airflow depends on the airflow and air distribution settings.

- ▶ **To open/close:** turn thumbwheel ① clockwise or counterclockwise.

AIRSCARF, setting the vents

WARNING

When operating the climate control, the air that enters the passenger compartment through the air vents can be very hot or very cold (depending on the set temperature). This could cause burns or frostbite to unprotected skin in the immediate area of the air vents.

Always keep sufficient distance between unprotected parts of the body and the air vents. If necessary, use the air distribution adjustment to direct the air to air vents in the vehicle interior that are not in the immediate area of unprotected skin.



You can adjust the blower output of AIRSCARF vents ① using the AIRSCARF button (▶ page 101).

Useful information	134
Breaking-in notes	134
Driving	134
Automatic transmission	143
Refueling	152
Parking	154
Driving tips	156
Driving systems	162

Useful information

- i** This Operator's Manual describes all models and all standard and optional equipment of your vehicle available at the time of publication of the Operator's Manual. Country-specific differences are possible. Please note that your vehicle may not be equipped with all features described. This also applies to safety-related systems and functions.
- i** Read the information on qualified specialist workshops: (> page 31).

Breaking-in notes

The first 1,000 miles (1,500 km)

The more you look after the engine when it is new, the more satisfied you will be with its performance in the future.

- You should therefore drive at varying vehicle and engine speeds for the first 1,000 miles (1,500 km).
- Avoid heavy loads, e.g. driving at full throttle, during this period.
- Change gear in good time, before the tachometer needle is $\frac{2}{3}$ of the way to the red area of the tachometer.
- Do not manually shift to a lower gear to brake the vehicle.
- If possible, do not depress the accelerator pedal past the point of resistance (kickdown).
- Only select shift ranges **3**, **2** or **1** when driving slowly, e.g. in mountainous terrain.
- Ideally, drive for the first 1,000 miles (1,500 km) in drive program **C**.

After 1,000 miles (1,500 km), you can increase the engine speed gradually and bring the vehicle up to full speed.

Additional breaking-in notes for AMG vehicles:

- do not drive faster than 85 mph (140 km/h) for the first 1,000 miles (1,500 km).
- only allow the engine to reach a maximum engine speed of 4,500 rpm briefly.
- change gear in good time.
- i** You should also observe these notes on running in if the engine or parts of the drive train on your vehicle have been replaced.

AMG vehicles with rear axle locking differential

Your vehicle is equipped with a self-locking differential on the rear axle. To improve the protection of the differential on the rear axle, change the oil after a break-in distance of 2,000 miles (3,000 km). This oil change extends the service life of the differential. Have the oil change carried out at a qualified specialist workshop. Mercedes-Benz recommends that you use an authorized Mercedes-Benz Center for this purpose.

Driving

Important safety notes

WARNING

Make sure absolutely no objects are obstructing the pedals' range of movement. Keep the driver's footwell clear of all obstacles. If there are any floor mats or carpets in the footwell, make sure the pedals still have sufficient clearance.

During sudden driving or braking maneuvers the objects could get caught between the pedals. You could then no longer brake or accelerate. This could lead to accidents and injury.

⚠ WARNING

On slippery road surfaces, never downshift in order to obtain braking action. This could result in drive wheel slip and reduced vehicle control. Your vehicle's ABS will not prevent this type of loss of control.

⚠ WARNING

It is dangerous to shift the automatic transmission out of parking position **P** or neutral position **N** if the engine speed is higher than idle speed. If your foot is not firmly on the brake pedal, the vehicle could accelerate quickly forward or in reverse. You could lose control of the vehicle and hit someone or something. Only shift into gear when the engine is idling normally and when your right foot is firmly on the brake pedal.

! Warm up the engine quickly. Do not use the engine's full performance until it has reached operating temperature.

Only shift the automatic transmission to the desired drive position when the vehicle is stationary.

Where possible, avoid spinning the drive wheels when pulling away on slippery roads. You could otherwise damage the drive train.

! **AMG vehicles:** at low engine oil temperatures below 68 °F (+20 °C), the maximum engine speed is restricted in order to protect the engine. To protect the engine and maintain smooth engine operation, avoid driving at full throttle when the engine is cold.

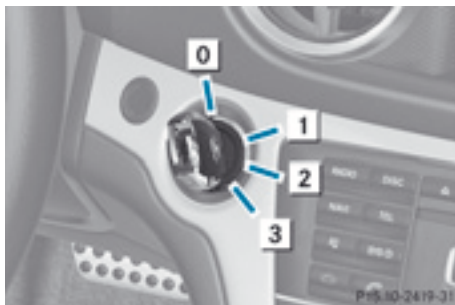
SmartKey positions**SmartKey**

- 0** To remove the SmartKey
 - 1** Power supply for some consumers, such as the windshield wipers
 - 2** Ignition (power supply for all consumers) and drive position
 - 3** To start the engine
- i** The SmartKey can be turned in the ignition lock even if it is not the correct SmartKey for the vehicle. The ignition is not switched on. The engine cannot be started.

KEYLESS-GO**General notes**

Vehicles with KEYLESS-GO are equipped with a SmartKey featuring an integrated KEYLESS-GO start function and a detachable Start/Stop button.

You can switch the engine on and off with the Start/Stop button. The Start/Stop button must be inserted into the ignition lock and the SmartKey must be in the vehicle.

Pressing the Start/Stop button several times in succession corresponds to the different SmartKey positions in the ignition lock. This is only the case if you are not depressing the brake pedal.

If you depress the brake pedal and press the Start/Stop button, the engine starts immediately.

The Start/Stop button can be removed from the ignition lock. Then, you can insert the SmartKey into the ignition lock.

i You do not have to remove the Start/Stop button from the ignition lock when you leave the vehicle. You should, however, always take the SmartKey with you when leaving the vehicle. As long as the SmartKey is in the vehicle:

- the vehicle can be started using the Start/Stop button and
- electrically powered equipment can be operated.

i The engine can be turned off while the vehicle is in motion by pressing and holding the Start/Stop button for three seconds. This function operates independently from the ECO start/stop automatic engine switch-off function.

Key positions with KEYLESS-GO



① Start/Stop button

② Ignition lock

► Insert Start/Stop button ① into ignition lock ②.

i When you insert Start/Stop button ① into ignition lock ②, the system needs approximately two seconds recognition time. You can then use Start/Stop button ①.



Start/Stop button

③ USA only

④ Canada only

Activating power supply

► If Start/Stop button ① has not yet been pressed, this corresponds to the SmartKey being removed from the ignition.

► Press Start/Stop button ① once.

The power supply is switched on. You can now activate the windshield wipers, for example.

i The power supply is switched off:

- when the driver's door is open and
- you press Start/Stop button ① twice when in this position

Switching on the ignition

► Press Start/Stop button ① twice.

The ignition is switched on.

i The ignition is switched off:

- when the driver's door is open and
- you press Start/Stop button ① once when in this position

As soon as the ignition is switched on, all the indicator lamps in the instrument cluster light up. If an indicator lamp does not go out after starting the engine or lights up while driving, there may be a technical problem (► page 257).

Removing the Start/Stop button



You can remove the Start/Stop button from the ignition lock and start the vehicle as normal using the SmartKey.

- ▶ Remove Start/Stop button ① from ignition lock ②.
- ❗ You do not have to remove the Start/Stop button from the ignition lock when you leave the vehicle.

Starting the engine

Important safety notes

⚠ WARNING

Inhalation of exhaust gas is hazardous to your health. All exhaust gas contains carbon monoxide (CO), and inhaling it can cause unconsciousness and possible death.

Do not run the engine in confined areas (such as a garage) which are not properly ventilated. If you think that exhaust gas fumes are entering the vehicle while driving, have the cause determined and corrected immediately. If you must drive under these conditions, drive only with at least one window fully open at all times.

- ❗ Do not depress the accelerator pedal when starting the engine.
- ❗ The catalytic converter is preheated for up to 30seconds after a cold start. During this time, the engine sound may be different.

Starting procedure with the SmartKey

- ▶ Depress the brake pedal and keep it depressed.
- ▶ Shift the transmission to position **P**. The transmission position display in the multifunction display shows **P**.
- ❗ You can also start the engine when the transmission is in position **N**.
- ▶ Turn the SmartKey to position **3** in the ignition lock (▶ page 135) and release it as soon as the engine is running.

Using KEYLESS-GO to start the engine

⚠ WARNING

As long as the SmartKey is in your vehicle, the vehicle can be started. Therefore, never leave children unattended in the vehicle, as they could otherwise accidentally start the engine. When leaving the vehicle, always take the SmartKey with you and lock the vehicle. Do not leave children unattended in the vehicle, or with access to an unlocked vehicle. A child's unsupervised access to a vehicle could result in an accident and/or serious personal injury.

- ❗ The Start/Stop button can be used to start the vehicle without inserting the SmartKey into the ignition lock. The Start/Stop button must be inserted into the ignition lock and the SmartKey must be in the vehicle.
- ▶ Depress the brake pedal and keep it depressed.
- ▶ Shift the transmission to position **P**. The transmission position display in the multifunction display shows **P**.
- ❗ You can also start the engine when the transmission is in position **N**.
- ▶ Press the Start/Stop button once (▶ page 135). The engine starts.

Pulling away

Automatic transmission

WARNING

It is dangerous to shift the automatic transmission out of parking position **P** or neutral position **N** if the engine speed is higher than idle speed. If your foot is not firmly on the brake pedal, the vehicle could accelerate quickly forward or in reverse. You could lose control of the vehicle and hit someone or something. Only shift into gear when the engine is idling normally and when your right foot is firmly on the brake pedal.

i It is only possible to shift the transmission from position **P** to the desired position if you depress the brake pedal. Only then is the shift lock released.

- ▶ Depress the brake pedal and keep it depressed.
- ▶ Shift the transmission to position **D** or **R**.
- ▶ Release the electric parking brake (▷ page 155).
- ▶ Release the brake pedal.
- ▶ Carefully depress the accelerator pedal.

! If a warning tone sounds and the **Release Park. Brake** message appears in the multifunction display, the parking brake is still applied. Release the parking brake.

i The vehicle locks centrally once you have pulled away. The locking knobs in the doors drop down.

You can open the doors from the inside at any time.

You can also deactivate the automatic locking feature (▷ page 218).

i Upshifts take place at higher engine speeds after a cold start. This helps the catalytic converter to reach its operating temperature more quickly.

Hill start assist

WARNING

Never leave the vehicle when it is being held by hill start assist. After approximately one second, hill start assist will no longer brake your vehicle and it could roll away.

Hill start assist helps you when pulling away forwards or in reverse on an uphill gradient. It holds the vehicle for a short time after you have removed your foot from the brake pedal. This gives you enough time to move your foot from the brake pedal to the accelerator pedal and to depress it before the vehicle begins to roll.

- ▶ Remove your foot from the brake pedal. The vehicle is then held for about a second.
- ▶ Pull away.

Hill start assist will not function if:

- you are pulling away on a level road or on a downhill gradient.
- the transmission is in position **N**.
- the parking brake is applied.
- ESP® is malfunctioning.

ECO start/stop function

Important safety notes

WARNING

If the engine is switched off and the ECO symbol is shown in green in the multifunction display, the engine has been switched off automatically. All of the vehicle's systems remain active. If you open the door, unfasten your seat belt or remove your foot from the brake pedal, the engine will automatically start. The vehicle may begin moving. You could suffer serious or even fatal injury or cause an accident resulting in injury or death.

Never leave the vehicle while the ECO symbol in the multifunction display is shown in green or yellow. Always secure the vehicle against rolling away before leaving it.

! Always switch the ignition off and take the key with you when leaving the vehicle.

General notes

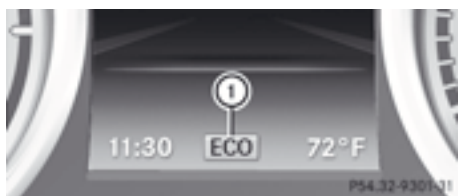

ECO start/stop display

AMG vehicles: the ECO start/stop function is only available in drive program **C**.

The ECO start/stop function switches the engine off automatically when the vehicle stops moving.

The engine starts automatically when the driver wants to pull away again. The ECO start/stop function thereby helps you to reduce the fuel consumption and emissions of your vehicle.

Every time you switch on the engine using the SmartKey or the Start/Stop button, the ECO start/stop function is activated. The system is operational when ECO symbol ① is shown in green in the multifunction display.

AMG vehicles: the AMG menu in the multifunction display additionally shows the **Stop/Start Active** message.

Deactivating/activating the ECO start/stop function



ECO button

Deactivating (except for AMG vehicles)

- ▶ Press button ①.
Indicator lamp ② and the **ECO** symbol in the multifunction display go out.

Activating (except for AMG vehicles)

- ▶ Press button ①.
Indicator lamp ② lights up and the **ECO** symbol is shown in green in the multifunction display.
If not all conditions are fulfilled, the **ECO** symbol is shown in yellow in the multifunction display. If this is the case, the ECO start/stop function is not available.

If indicator lamp ② is off, the ECO start/stop function has been deactivated manually or as the result of a malfunction. The engine will then not be switched off automatically when the vehicle stops.



ECO button in AMG vehicles

Deactivating (AMG vehicles)

- ▶ Press button ① in drive program **C**.
- or
- ▶ Switch to one of the drive programs **S**, **S+** or **M**(> page 147).
Indicator lamp ② on button ① and the **ECO** symbol in the multifunction display go out.

The **Stop/Start Active** or **Stop/Start Inactive** message in the AMG menu in the multifunction display goes out.

Activating (AMG vehicles)

► Press button ①.

If one of the drive programs **S**, **S+** or **M** is active, the automatic transmission switches to drive program **C**.

Indicator lamp ② lights up and the **ECO** symbol is shown in green in the multifunction display. The **Stop/Start Active** message is shown in the AMG menu in the multifunction display.

If not all conditions are fulfilled, the **ECO** symbol is shown in yellow in the multifunction display. If this is the case, the ECO start/stop function is not available. The **Stop/Start Inactive** message is shown in the AMG menu in the multifunction display.

Automatic engine switch-off

If the vehicle is braked to a standstill in **D** or **N**, the ECO start/stop function switches off the engine automatically.

The engine is only switched off if:

- the vehicle is stationary.
- the outside temperature is within the range which is suitable for the system.
- the engine is at normal operating temperature.
- the battery is sufficiently charged.
- the system detects that the windshield is not fogged up when automatic climate control is switched on.
- the hood is closed.
- the driver's door is closed and the driver's side belt buckle is engaged.

i If not all conditions are fulfilled, the **ECO** symbol is shown in yellow in the multifunction display.

i The HOLD function can be activated if the engine has been switched off automatically. It is then not necessary to continue applying the brakes during the automatic stop phase. When you depress

the accelerator pedal, the engine starts automatically and the braking effect of the HOLD function is deactivated. Depress the accelerator pedal carefully, as the engine must be started first.

If you shift the transmission from **R** to **D**, the ECO start/stop function is available again once the **ECO** symbol reappears in green in the multifunction display.

The engine can be switched off automatically a maximum of four times (first stop and three subsequent stops, except AMG vehicles) in succession. The **ECO** symbol is shown in yellow in the multifunction display after the engine has been started automatically for the fourth time. The engine can only be switched off automatically again when the **ECO** symbol is shown in green in the multifunction display.

AMG vehicles: times which the engine can be automatically switched off is unlimited.

Automatic engine start

The engine starts automatically if:

- you switch off the ECO start/stop function by pressing the ECO button.
- you switch to one of the drive programs **S**, **S+** or **M** (AMG vehicles).
- the vehicle starts to roll.
- the brake system requires this.
- the system detects that the windshield is fogged up when automatic climate control is switched on.
- the condition of charge of the battery is too low.
- the driver's seat belt is removed or the driver's door is opened.
- you shift out of **P**.
- in transmission position **D** or **N** the brake pedal is released and the HOLD function is not active.
- you engage reverse gear **R**.
- you depress the accelerator pedal.

Shifting the transmission to position **P** does not start the engine.

Problems with the engine

Problem	Possible causes/consequences and ► Solutions
The engine does not start.	<p>The HOLD function is activated.</p> <ul style="list-style-type: none"> ► Deactivate the HOLD function (▷ page 175). ► Try to start the engine again.
The engine does not start. The starter motor can be heard.	<ul style="list-style-type: none"> • There is a malfunction in the engine electronics. • There is a malfunction in the fuel supply. <p>► Turn the SmartKey back to position 0 in the ignition lock before attempting to start the engine again.</p> <p>or</p> <ul style="list-style-type: none"> ► Press the Start/Stop button repeatedly until all indicator lamps in the instrument cluster go out. ► Try to start the engine again (▷ page 137). Avoid excessively long and frequent attempts to start the engine, as this will drain the battery. <p>If the engine does not start after several attempts:</p> <ul style="list-style-type: none"> ► Consult a qualified specialist workshop.
The engine does not start. You cannot hear the starter motor.	<p>The on-board voltage is too low because the battery is too weak or discharged.</p> <ul style="list-style-type: none"> ► Jump-start the vehicle (▷ page 5 16). <p>If the engine does not start despite attempts to jump-start it:</p> <ul style="list-style-type: none"> ► Consult a qualified specialist workshop. <p>The starter motor was exposed to a thermal load that was too high.</p> <ul style="list-style-type: none"> ► Allow the starter motor to cool down for approximately two minutes. ► Try to start the engine again. <p>If the engine still does not start:</p> <ul style="list-style-type: none"> ► Consult a qualified specialist workshop.
The engine is not running smoothly and is misfiring.	<p>There is a malfunction in the engine electronics or in a mechanical component of the engine management system.</p> <ul style="list-style-type: none"> ► Only depress the accelerator pedal slightly. ► Have the cause rectified immediately at a qualified specialist workshop. <p>Otherwise, non-combusted fuel may get into the catalytic converter and damage it.</p>

Problem	Possible causes/consequences and ► Solutions
<p>The coolant temperature display is showing more than 248 °F (120 °C). The coolant warning lamp may also be lit and a warning tone may sound.</p>	<p>The coolant level is too low. The coolant is too hot and the engine is no longer being cooled sufficiently.</p> <ul style="list-style-type: none"> ► Stop as soon as possible and allow the engine and the coolant to cool down. ► Check the coolant level (► page 498). Observe the warning notes as you do so and add coolant if necessary. <p>If the coolant level is correct, the engine radiator fan may be faulty. The coolant is too hot and the engine is no longer being cooled sufficiently.</p> <ul style="list-style-type: none"> ► At coolant temperatures under 248 °F(120 °C), drive to the next qualified specialist workshop. ► Avoid heavy loads on the engine as you do so, e.g. driving in mountainous terrain and stop-and-go traffic.

Automatic transmission

Important safety notes

WARNING

It is dangerous to shift the automatic transmission out of parking position **P** or neutral position **N** if the engine speed is higher than idle speed. If your foot is not firmly on the brake pedal, the vehicle could accelerate quickly forward or in reverse. You could lose control of the vehicle and hit someone or something. Only shift into gear when the engine is idling normally and when your right foot is firmly on the brake pedal.

WARNING

Keep in mind that turning off the engine alone only will shift the automatic transmission into neutral position **N** automatically.

Always shift the automatic transmission into park position **P** before turning off the engine. Otherwise the vehicle could roll away which could result in an accident and/or serious personal injury.

Selector lever

Overview of transmission positions

 If the engine speed is too high or if the vehicle is rolling, do not shift the transmission directly from **D** to **R**, from **R** to **D** or directly to **P**.

Do not open the driver's door while the vehicle is in motion. At low speeds in transmission position **D** or **R**, park position **P** is otherwise engaged automatically.

The transmission could be damaged.



Selector lever

 Park position

 Reverse gear

- N** Neutral
- D** Drive

When you select a transmission position, the selector lever subsequently returns to its original position.

The current transmission position **P**, **R**, **N** or **D** appears in the transmission position display in the multifunction display.

Engaging park position P

- ▶ When the vehicle is stationary, depress the brake pedal.
- ▶ Press the **P** button in the center console.

i If you depress the brake pedal and push the selector lever forwards or back to the first point of resistance, park position **P** is disengaged. The transmission shifts to neutral **N**.

Park position **P** is engaged automatically and the electric parking brake applied:

- if you remove the SmartKey from the ignition lock
- if you switch off the engine using the Start/Stop button and open the driver's or front-passenger door
- if you open the driver's door while traveling at low speed in transmission position **D** or **R**
- when HOLD (▷ page 175) or DISTRONIC PLUS (▷ page 164) brakes your vehicle until it is stationary and at least one of the following conditions is fulfilled:
 - the engine is switched off.
 - the driver's door is open and the seat belt is not fastened.
 - there is a system malfunction.
 - the power supply is insufficient.

Engaging reverse gear R

- !** Only shift the automatic transmission to **R** when the vehicle is stationary.

- ▶ When the vehicle is stationary, depress the brake pedal.
- ▶ Push the selector lever forwards past the first point of resistance.

i When reverse gear is engaged and the ECO start/stop function is switched on, the engine starts up automatically (▷ page 138).

Shifting to neutral N

- ▶ When the vehicle is stationary, depress the brake pedal.
- ▶ Push the selector lever forwards or back to the first point of resistance.

i If the vehicle is braked to a standstill when in neutral **N** and the brake pedal continues to be depressed, the ECO start/stop function switches the engine off automatically (▷ page 138).

Remaining in neutral N

WARNING

When leaving the SmartKey in the starter switch, do not leave children unattended in the vehicle. It is possible for children to switch on the ignition which could result in unsupervised use of vehicle equipment. Unsupervised use of vehicle equipment could result in an accident and/or serious personal injury.

Using the SmartKey:

- make sure that the ignition is switched on.
- when the vehicle is stationary, depress the brake pedal and keep it depressed.
- shift to neutral **N**.
- release the brake pedal.
- if the electric parking brake is applied, release it.
- switch off the ignition and leave the SmartKey in the ignition lock.

Using KEYLESS-GO:

- make sure that the ignition is switched on.
- when the vehicle is stationary, depress the brake pedal and keep it depressed.
- engage park position **P**.
- release the brake pedal.
- remove the Start/Stop button from the ignition lock.
- insert the SmartKey into the ignition lock.
- switch on the ignition.
- depress the brake pedal and keep it depressed.
- shift to neutral **N**.
- release the brake pedal.
- if the electric parking brake is applied, release it.
- switch off the ignition and leave the SmartKey in the ignition lock.

Shifting to transmission position D

- ▶ When the vehicle is stationary, depress the brake pedal.
 - ▶ Push the selector lever back past the first point of resistance.
- i** If the vehicle is braked to a standstill when in transmission position **D** (> page 138) and the brake pedal continues to be depressed, the ECO start/stop function switches the engine off automatically.

Transmission position and drive program display

Display in transmission positions P, R and N



- ① Transmission position: currently selected transmission position will be highlighted
- ② Drive program (**E/S/M**)

In addition to drive program ② being shown in the multifunction display, the currently selected drive program is indicated in red on the program selector button.

Display when in transmission position D



- ① Transmission position
- ② Gear
- ③ Drive program (**E/S**)

If you have restricted the shift range, the selected shift range and gear, e.g. D4, are shown at position ①.

Display when in transmission position D and drive program M



- ① Gear
- ② Drive program (M)

Transmission positions

P Park position

Do not shift the transmission into position **P** (▷ page 143) unless the vehicle is stationary. The parking lock should not be used as a brake when parking. Always apply the parking brake in addition to the parking lock in order to secure the vehicle.

If the SmartKey is removed from the ignition lock, the transmission is locked.

The automatic transmission shifts into **P** automatically:

- when the SmartKey is removed from the ignition lock
- when the engine is switched off with the transmission in position **R** or **D** and one of the doors is opened

If the vehicle electronics are malfunctioning, the transmission may be locked in position **P**.

Have the vehicle electronics checked immediately at a qualified specialist workshop, e.g. an authorized Mercedes-Benz Center.

R Reverse gear

Only shift the transmission to **R** when the vehicle is stationary.

N Neutral

Do not shift the transmission to **N** while driving. Otherwise, the automatic transmission could be damaged.

No power is transmitted from the engine to the drive wheels.

Releasing the brakes will allow you to move the vehicle freely, e.g. to push it or tow it.

If ESP® is deactivated or faulty: only shift the transmission to position **N** if the vehicle is in danger of skidding, e.g. on icy roads.

! Rolling in neutral **N** can damage the drive train.

D Drive

The automatic transmission changes gear automatically. All forward gears are available.

Changing gear

The automatic transmission shifts to the individual gears automatically when it is in transmission position **D**. This automatic gearshifting behavior is determined by:

- a shift range restriction, if selected
- the selected drive program **E**, **S** or **M** (▷ page 147)
- the position of the accelerator pedal
- the road speed

Driving tips

Accelerator pedal position

Your style of driving influences how the automatic transmission shifts gear:

- little throttle: early upshifts
- more throttle: late upshifts

Double-clutch function

When shifting down, the double-clutch function is active regardless of the currently selected drive program. The double-clutch function reduces load change reactions and is conducive to a sporty driving style. The sound generated by the double-clutch function depends on the drive program selected.

Kickdown

Use kickdown for maximum acceleration.

- ▶ **Vehicles for USA except AMG vehicles:** fully depress the accelerator pedal. The transmission shifts to a lower gear depending on the engine speed.
- ▶ **Vehicles for Canada except AMG vehicles:** depress the accelerator pedal beyond the pressure point. The transmission shifts to a lower gear depending on the engine speed.

Working on the vehicle

WARNING

When working on the vehicle, engage the parking brake and shift the automatic transmission into park position **P**. Otherwise the vehicle could roll away which could result in an accident and/or serious personal injury.

Program selector button

Selecting drive program



Program selector button

Program selector button ① allows you to choose between different driving characteristics.

- ▶ Press program selector button ① repeatedly until the letter for the desired gearshift program appears in the multifunction display in the speedometer.
 - **E** Economy: comfortable, economical driving
 - **S** Sport: sporty driving style
 - **M** Manual: manual gearshifting

i The automatic transmission shifts to automatic drive program **E** each time the engine is started.

i For further information on the "Automatic drive program", see (> page 149).

Drive program for AMG vehicles



With the drive program selector switch, you can choose from a range of different transmission configurations or select the RACE START drive mode.

- ▶ Turn drive program selector ① until the desired drive program appears in the multifunction display.
 - **C** Controlled Efficiency: comfortable engine and transmission design that provides for optimum fuel consumption
 - **S** Sport: sporty engine and transmission settings
 - **S+** SportPlus: extremely sporty engine and transmission settings
 - **M** Manual: manual gearshifting
 - **RS driving mode** RACE START: optimum acceleration dynamics from a standstill (SL 63 AMG only)

- ▶ Turn drive program selector switch ① until the desired drive program is shown in the multifunction display. The drive program indicator on the drive program selector lights up red.

- ❗ The automatic transmission shifts to automatic drive program **C** each time the engine is started.
- ❗ **RS** cannot be selected during normal driving. For further information on RACE START, see (▷ page 177).

AMG button (SETUP)

You can save and call up the following presettings with the AMG button:

- Drive program (▷ page 147)
- Suspension tuning



- ▶ **To store:** press and hold AMG button ① until you hear a tone.
- ▶ **To call up:** press AMG button ①. The stored drive program is selected.
- ▶ **To display:** briefly press AMG button ①. The multifunction display shows the SETUP in the AMG menu (▷ page 220).

Steering wheel paddle shifters



In the automatic drive program, you can restrict or derestrict the shift range by using the steering wheel paddle shifters (▷ page 149).

In the manual drive program, you can change gear yourself by using the steering wheel paddle shifters (▷ page 150).

- ❗ The full range of functions for the steering wheel paddle shifters is available only once operating temperature has been reached.
- ❗ You can only change gear with the steering wheel paddle shifters when the transmission is in position **D**.

Automatic drive program

Drive program **E** is characterized by the following:

- comfort-oriented engine and transmission settings
- optimal fuel consumption resulting from the automatic transmission shifting up sooner
- the vehicle pulling away more gently in forward and reverse gears, unless the accelerator pedal is depressed fully
- increased sensitivity. This improves driving stability on slippery road surfaces, for example
- the automatic transmission shifting up sooner. This results in the vehicle being driven at lower engine speeds and the wheels being less likely to spin

Drive program **S** is characterized by the following:

- sporty engine and transmission settings
- the vehicle pulling away in first gear
- the automatic transmission shifting up later
- the fuel consumption possibly being higher as a result of the later automatic transmission shift points

Shift ranges

Introduction

When the automatic transmission is in position **D**, it is possible to restrict or derestrict the shift range.

The set shift range appears in the multifunction display. The automatic transmission shifts only as far as the selected gear.

Driving situations

- | | |
|----------|--|
| 3 | You can use the engine's braking effect. |
| 2 | The braking effect of the engine can be utilized on downhill gradients or when driving: <ul style="list-style-type: none"> • on steep mountain roads • in mountainous terrain • in arduous conditions |
| 1 | The braking effect of the engine can be utilized on extremely steep downhill gradients and long downhill stretches. |

Restricting the shift range



- ▶ Pull the left-hand steering wheel paddle shifter ①.
The automatic transmission shifts down one gear and restricts the shift range to the relevant gear.
- ❗ If the engine exceeds the maximum engine speed when shifting down, the automatic transmission protects against engine damage by not shifting down.
- ❗ If the maximum engine speed for the shift range is reached and you continue to accelerate, the automatic transmission shifts up, even if the shift range is restricted. This is to prevent the engine from overrevving.

Derestricting the shift range

- ▶ Pull the right-hand steering wheel paddle shifter ②.
- The shift range is derestricted.

Clearing the shift range restriction

- ▶ Pull and hold right-hand steering wheel paddle shifter ② until **D** is shown again in the multifunction display.

or

- ▶ Use the selector lever to shift the transmission to transmission position **D**. The automatic transmission shifts from the current shift range directly to **D**.

Selecting the ideal shift range

- ▶ Pull and hold left-hand steering wheel paddle shifter ① until the function is activated.
- Depending on the selected drive program, the automatic transmission shifts to a gear which allows ideal acceleration and deceleration. To do this, the automatic transmission shifts down one or more gears.

Manual drive program

Switching on the manual drive program

Manual drive program **M** is different from drive program **S** with regard to spontaneity, responsiveness and smoothness of gear changes.

You can select manual drive program **M** with the program selector button or the drive program selector (**AMG vehicles**). In manual drive program **M**, you can change gear using the steering wheel paddle shifters if the transmission is in position **D**. The selected gear appears in the multifunction display.

- ▶ Press the program selector button until **M** (▷ page 147) appears in the multifunction display.

- ▶ **AMG vehicles:** turn the drive program selector until **M** (▷ page 147) appears in the multifunction display.

Upshifting

- ▶ Pull the right-hand steering wheel paddle shifter (▷ page 148). The automatic transmission shifts up to the next gear.
- Before the engine speed reaches the red area, an upshift indicator will be shown in the multifunction display.



- ① Upshift indicator
 - ② Gear indicator
- ▶ Shift up a gear if upshift symbol ① appears in the multifunction display.

AMG vehicles

- ! In manual drive program **M**, the automatic transmission does not shift up automatically even when the engine limiting speed for the current gear is reached. When the engine limiting speed is reached, the fuel supply is cut to prevent the engine from overrevving. Always make sure that the engine speed does not reach the red area of the tachometer. There is otherwise a risk of engine damage.
- ▶ If the display color of the multifunction display changes to red and upshift symbol ① appears, shift up a gear.

Downshifting

- ▶ Pull the left-hand steering wheel paddle shifter (▷ page 148).
The automatic transmission shifts down to the next gear.

Maximum acceleration

- ▶ Pull the left-hand steering wheel paddle shifter until the transmission selects the optimum gear according to the speed.
- i** If you brake the vehicle or stop without shifting down, the automatic transmission will shift down to a gear that will allow the vehicle to accelerate or pull away again.

Kickdown

You can also use kickdown for maximum acceleration in manual drive program **M**.

- ▶ Depress the accelerator pedal beyond the pressure point.
The transmission shifts to a lower gear depending on the engine speed.
- i** **AMG vehicles:** it is not possible to use kickdown in manual drive program **M**.

Switching off the manual drive program

- ▶ Press the program selector button (▷ page 147) repeatedly until **E** or **S** appears in the multifunction display.
- ▶ **AMG vehicles:** turn the drive program selector until **C**, **S** or **S+** (▷ page 147) appears in the multifunction display.

Problems with the transmission

Problem	Possible causes/consequences and ► Solutions
The transmission has problems shifting gear.	The transmission is losing oil. ► Have the transmission checked at a qualified specialist workshop immediately.
The acceleration ability is deteriorating. The transmission no longer changes gear.	The transmission is in emergency mode. It is only possible to shift into second gear and reverse gear. ► Stop the vehicle. ► Shift the transmission to position P . ► Switch off the engine. ► Wait at least ten seconds before restarting the engine. ► Shift the transmission to position D or R . If D is selected, the transmission shifts into second gear; if R is selected, the transmission shifts into reverse gear. ► Have the transmission checked at a qualified specialist workshop, e.g. an authorized Mercedes-Benz Center, immediately.

Refueling

Important safety notes

 **WARNING**

Gasoline is highly flammable and poisonous. It burns violently and can cause serious personal injury.

Never allow sparks, flames or smoking materials near gasoline.

Turn off the engine before refueling.

Whenever you are around gasoline, avoid inhaling fumes and any skin or clothing contact.

Direct skin contact with fuels and the inhalation of fuel vapors are damaging to your health.

 **WARNING**

Overfilling of the fuel tank may create pressure in the system which could cause a gas discharge. This could cause the gasoline to spray back out when removing the fuel

pump nozzle, which could cause personal injury.

 Do not use diesel to refuel vehicles with a gasoline engine. Even small amounts of the wrong fuel result in damage to the fuel system and engine.

 Do not switch on the ignition if you accidentally refuel with the wrong fuel. Otherwise, the fuel will enter the fuel lines. Notify a qualified specialist workshop and have the fuel tank and fuel lines drained completely.

 Overfilling the fuel tank could damage the fuel system.

 Take care not to spill any fuel on painted surfaces. You could otherwise damage the paintwork.

 Use a filter when refueling from a fuel can. Otherwise, the fuel lines and/or injection system could be blocked by particles from the fuel can.

For further information on fuel and fuel quality (▷ page 561).

Refueling

Fuel filler flap

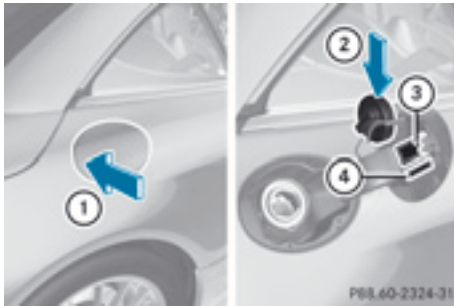

- ① To open the fuel filler flap
- ② To insert the fuel filler cap
- ③ Tire pressure table
- ④ Fuel type to be used

The fuel filler flap is unlocked or locked automatically when you open or close the vehicle with the SmartKey or using KEYLESS-GO.

The position of the fuel filler cap is displayed  in the instrument cluster. The arrow next to the filling pump indicates the side of the vehicle.

Opening

- ▶ Switch off the engine.
- ▶ Remove the SmartKey from the ignition lock.
- ▶ KEYLESS-GO: open the driver's door. This corresponds to SmartKey position **0**, "key removed".
The driver's door can be closed again.
- ▶ Press the fuel filler flap in the direction of arrow ①.
The fuel filler flap opens slightly.
- ▶ Open the fuel filler flap fully.
- ▶ Turn the fuel filler flap counter-clockwise and remove it.

- ▶ Insert the fuel filler cap into the holder bracket on the inside of filler flap ②.
- ▶ Completely insert the filler neck of the fuel pump nozzle into the tank and refuel.
- ▶ Only fill the tank until the pump nozzle switches off.

i Do not add any more fuel after the pump stops filling for the first time. Otherwise, fuel could leak out.

Closing

- ▶ Place fuel filler cap on the fuel filler neck and turn clockwise until it engages.
- ▶ Close the fuel filler flap.

i Close the fuel filler flap before locking the vehicle.

i If you drive with the fuel filler cap open, the reserve fuel warning lamp flashes. In addition, the  engine diagnostics warning lamp may light up. A message appears in the multifunction display (▷ page 240).

For further information on warning and indicator lamps in the instrument cluster, see (▷ page 263).

Problems with fuel and the fuel tank

Problem	Possible causes/consequences and ► Solutions
Fuel is leaking from the vehicle.	<p> Risk of explosion or fire</p> <p>The fuel line or the fuel tank is faulty.</p> <ul style="list-style-type: none"> ► Turn the SmartKey to position 0 in the ignition lock immediately and remove it (▷ page 135). ► Do not restart the engine under any circumstances. ► Consult a qualified specialist workshop.
The fuel filler flap cannot be opened.	<p>The fuel filler flap is not unlocked. or The SmartKey battery is discharged.</p> <ul style="list-style-type: none"> ► Unlock the vehicle (▷ page 68). or ► Unlock the vehicle using the mechanical key (▷ page 70). <p>The fuel filler flap is unlocked, but the opening mechanism is jammed.</p> <ul style="list-style-type: none"> ► Consult a qualified specialist workshop.

Parking

Important safety notes

WARNING

Do not park this vehicle in areas where combustible materials can come into contact with the hot exhaust system. Do not park the vehicle on dry grassland or harvested grain fields. Combustible materials, such as grass, hay or leaves could be ignited by the hot exhaust system and cause a vehicle fire.

Unintended vehicle movement can cause serious personal injury or damage to the vehicle or the vehicle drivetrain. To reduce such risks, always do the following before turning off the engine and leaving the vehicle:

- keep your right foot on the brake pedal.
- engage the parking brake.
- shift the automatic transmission to park position **P**.
- slowly release the brake pedal.

- when parked on an incline, always turn the front wheels towards the road curb.
- turn the SmartKey in the ignition lock to position **0** and remove the SmartKey from the ignition lock, or press the KEYLESS-GO Start/Stop button.
- take the SmartKey with you and lock the vehicle when leaving.

Switching off the engine

Important safety notes

WARNING

Do not turn off the engine before the vehicle has come to a complete stop. With the engine not running, there is no power assistance for the brake and steering systems. In this case, it is important to keep in mind that a considerably higher degree of effort is necessary to brake and steer the vehicle.

Vehicles with automatic transmission

- ▶ **Vehicles with a SmartKey:** move the transmission to position **P**.
- ▶ Turn the SmartKey to position **0** in the ignition lock and remove it. The immobilizer is activated.
- ▶ **Vehicles with KEYLESS-GO:** press the Start/Stop button (▷ page 135). The engine stops and all the indicator lamps in the instrument cluster go out. When the driver's door is closed, this corresponds to key position **1**. When the driver's door is open, this corresponds to key position **0**(▷ page 135).

If you try to switch off the engine when the transmission is not in position **P**, a message appears in the multifunction display. A signal sounds.

- ❗ The engine can be turned off while the vehicle is in motion by pressing and holding the Start/Stop button for three seconds. This function operates independently from the ECO start/stop automatic engine switch-off function.

Electric parking brake

General notes

WARNING

When leaving the vehicle, always remove the SmartKey from the starter switch, take it with you, and lock the vehicle. Do not leave children unattended in the vehicle, or with access to an unlocked vehicle. Children could release the parking brake and/or shift the automatic transmission out of park position **P**, either of which could result in an accident and/or serious personal injury.

- ❗ The electric parking brake performs a function test at regular intervals while the engine is switched off. The sounds that can be heard while this is occurring are normal.

Engaging and releasing manually



- ▶ **To engage:** push handle ①. The red **PARK** (USA only) or **(P)** (Canada only) indicator lamp in the instrument cluster lights up.
 - ❗ The electric parking brake can also be applied when the SmartKey is removed.
- ▶ **To release:** switch on the ignition.
- ▶ Pull handle ①. The red **PARK** (USA only) or **(P)** (Canada only) indicator lamp in the instrument cluster goes out.
 - ❗ The electric parking brake can only be released:
 - if the SmartKey is in position **1** in the ignition lock or
 - if the ignition was switched on using the Start/Stop button.



Applying automatically

The electric parking brake is applied automatically:

- if DISTRONIC PLUS brings the vehicle to a standstill or
- if the HOLD function is keeping the vehicle stationary

In addition, at least one of the following conditions must be fulfilled:

- the engine is switched off, unless it is automatically switched off by the ECO start/stop function.
- the driver's seat belt is not inserted in the belt buckle and the driver's door is open.
- the vehicle is stationary for a lengthy period.

The red  (USA only) or  (Canada only) indicator lamp in the instrument cluster lights up.

Releasing automatically

The electric parking brake is released automatically when all of the following conditions are fulfilled:

- the engine is running.
- the transmission is in position **D** or **R**.
- the driver's seat belt is fastened.
- you depress the accelerator pedal.

If the transmission is in position **R**, the trunk lid must be closed.

For the parking brake to be released automatically if your seat belt is not fastened, the following conditions must be fulfilled:



- the driver's door is closed.
- you have shifted out of **P** or you have previously driven faster than 2 mph (3 km/h).

Emergency braking

The vehicle can also be braked during an emergency by using the electric parking brake.

- ▶ While driving, push handle ① of the electric parking brake.
- ① The vehicle is braked for as long as the handle of the electric parking brake is pressed. The longer the electric parking brake handle is depressed, the greater the braking force.

During braking:

- a warning tone sounds.
- the **Please Release Parking Brake** message appears.
- the red  (USA only) or  (Canada only) indicator lamp in the instrument cluster flashes.

When the vehicle has been braked to a standstill, the electric parking brake is engaged.

Parking the vehicle for a long period

- ▶ Connect a trickle charger.

If you leave the vehicle parked up for longer than four weeks, the battery may be damaged by exhaustive discharging.

- ① You can obtain information about trickle chargers from a qualified specialist workshop.

If you leave the vehicle parked for longer than six weeks, the vehicle may suffer damage as a result of lack of use. Consult a qualified specialist workshop.

Driving tips

General notes

Important safety notes

WARNING

Always remember that you must concentrate primarily on driving the vehicle. The driver's concentration must always be directed primarily at road traffic. For your own safety and that of others, we recommend that you stop the vehicle at a safe place and in accordance with the traffic conditions before making or accepting a phone call.

Comply with all legal requirements if you use the telephone while driving. Use the hands-free system and only use the telephone when road, weather and traffic conditions permit. In

some jurisdictions, it is forbidden for drivers to use mobile phones while driving.

Only operate COMAND (Cockpit Management and Data System) in compliance with all legal requirements and when the road, weather and traffic conditions permit. You may otherwise not be able to observe the traffic conditions, endangering yourself and others.

Remember that your vehicle covers a distance of 44 ft (approximately 14 m) a second when it is traveling at only 30 mph (approximately 50 km/h).

Drive sensibly – save fuel

Observe the following tips to save fuel:

- The tires should always be inflated to the recommended tire pressure.
- Remove unnecessary loads.
- Warm up the engine at low engine speeds.
- Avoid frequent acceleration or braking.
- Observe the service intervals in the Maintenance Booklet or in the service interval display. Have all the maintenance work carried in accordance with Daimler AG regulations.

Fuel consumption also increases when driving in cold weather, in stop-and-go traffic and in mountainous terrain.

Drinking and driving

WARNING

Drinking and driving and/or taking drugs and driving are very dangerous combinations. Even a small amount of alcohol or drugs can affect your reflexes, perceptions and judgment.

The possibility of a serious or even fatal accident are greatly increased when you drink or take drugs and drive.

Do not drink or take drugs and drive or allow anyone to drive who has been drinking or taking drugs.

Pedals

WARNING

Make sure absolutely no objects are obstructing the pedals' range of movement. Keep the driver's footwell clear of all obstacles. If there are any floor mats or carpets in the footwell, make sure that the pedals still have sufficient clearance.

During sudden driving or braking maneuvers, the objects could get caught between the pedals. You could then no longer brake or accelerate. This could lead to accidents and injury.

Rolling with the engine switched off

WARNING

There is no power assistance for the steering and the brake when the engine is not running. Steering and braking requires significantly more effort and you could lose control of the vehicle and cause an accident as a result.

Do not turn off the engine while the vehicle is in motion.

WARNING

Electric power is required to operate the brake system.

A malfunction in the power supply or in the vehicle's electrical system can impair the operation of the brake system and result in the brake system switching to emergency mode. In this situation, the red brake system warning lamp and warning messages may appear in the instrument cluster while the vehicle is moving. When braking, the driver must depress the brake pedal considerably more firmly and much further in order to obtain the expected braking effect. If necessary, apply full pressure to the brake pedal. Brakes are only applied to the front wheels. Stopping distance is increased.

Exhaust check

WARNING

Inhalation of exhaust gas is hazardous to your health. All exhaust gas contains carbon monoxide (CO), and inhaling it can cause unconsciousness and possible death.

Do not run the engine in confined areas (such as a garage) which are not properly ventilated. If you think that exhaust gas fumes are entering the vehicle while driving, have the cause determined and corrected immediately. If you must drive under these conditions, drive only with at least one window fully open at all times.

Certain engine systems are designed to keep the level of poisonous components in exhaust fumes within legal limits.

These systems only work at peak efficiency if they are serviced exactly in accordance with the manufacturer's specifications. All work on the engine must be carried out by qualified and authorized Mercedes-Benz technicians.

The engine settings must not be changed under any circumstances. Furthermore, all specific service work must be carried out at regular intervals and in accordance with the Mercedes-Benz service requirements. Details can be found in the Maintenance Booklet.

Brakes

Important safety notes

WARNING

On slippery road surfaces, never downshift in order to obtain braking action. This could result in drive wheel slip and reduced vehicle control. Your vehicle's ABS will not prevent this type of loss of control.

WARNING

Make sure that you do not endanger other road users when you apply the brakes.

Downhill gradients

 On long, steep gradients, you must reduce the load on the brakes. In order to use engine braking effect, restrict the shift range in good time. This helps you to avoid overheating the brakes and wearing them out excessively.

When making use of the engine braking effect, it is possible that a drive wheel may not turn for some time, e.g. in the case of suddenly changing or slippery road surface conditions. This could cause damage to the drive train. This type of damage is not covered by the Mercedes-Benz warranty.

Heavy and light loads

WARNING

Depressing the brake pedal constantly results in excessive and premature wear to the brake pads.

It may also cause the brakes to overheat, seriously impairing their effectiveness. It may then not be possible to stop the vehicle in sufficient time to avoid an accident.

If the brakes have been subjected to a heavy load, do not stop the vehicle immediately, but drive on for a short while. This allows the airflow to cool the brakes more quickly.

Wet roads

WARNING

After driving in heavy rain for some time without applying the brakes or through water deep enough to wet brake components, the first braking action may be somewhat reduced. You have to depress the brake pedal more firmly. Maintain a safe distance from vehicles in front.

After driving on a wet road or having the vehicle washed, brake firmly while paying attention to the traffic conditions. This will warm up the brake discs, thereby drying them

more quickly and protecting them against corrosion.

Limited braking performance on salt-treated roads

WARNING

The layer of salt on the brake discs and the brake pads/linings may cause a delay in the braking effect, resulting in a significantly longer braking distance, which could lead to an accident.

To avoid this danger, you should:

- occasionally brake carefully, without putting other road users at risk, when you are driving on salted roads. This helps to remove any salt that may have started to build up on the brake discs and the brake pads/linings.
- maintain a greater distance to the vehicle ahead and drive with particular care.
- carefully apply the brakes at the end of a trip and immediately after commencing a new trip, so that salt residues are removed from the brake discs.

High-performance brake system for AMG vehicles

WARNING

New vehicle brake pads and discs, and replacement brake pads and discs may take several hundred miles of driving until they provide optimum braking efficiency. Until that time, you may need to use increased brake pedal pressure while braking. Please be aware of this and adjust your driving and braking accordingly during this break-in period.

Excessive high-demand braking will cause correspondingly high brake wear. Please be attentive to the brake warning lamp in the instrument cluster and brake condition messages in the multifunction display.

Especially for high performance driving, it is important to maintain and have the brake system checked regularly.

The AMG brake systems are designed for heavy loads. This may lead to noise when braking. This will depend on:

- speed
- braking force
- ambient conditions, e.g. temperature and humidity

The wear of individual components of the brake system, such as the brake pads/linings or brake discs, depends on the individual driving style and operating conditions.

For this reason, it is impossible to state a mileage that will be valid under all circumstances. An aggressive driving style will lead to high wear. You can obtain more information on this from a qualified specialist workshop.

Servicing the brakes

WARNING

If brake pads or brake fluid other than those recommended are used, the braking properties of the vehicle can be degraded to an extent that safe braking is substantially impaired. This could result in an accident.

WARNING

Make sure that you do not endanger other road users when you apply the brakes.

! If the brake warning lamp lights up in the instrument cluster and you hear a warning tone even though the parking brake has been released, the brake fluid level may be too low. Observe additional warning messages in the multifunction display.

The brake fluid level may be too low due to brake pad wear or leaking brake lines.

Have the brake system checked immediately. This work should be carried out at a qualified specialist workshop.

! As the ESP® system operates automatically, the engine and the ignition system must be switched off (SmartKey in position **0** or **1** in the ignition lock or Start/Stop button in position **0** or **1**) when:

- testing the parking brake on a brake dynamometer.
- you intend to have the vehicle towed with the front axle raised.

Braking maneuvers triggered automatically by ESP® may seriously damage the brake system.

All checks and maintenance work on the brake system must be carried out at a qualified specialist workshop. Have this work carried out at an authorized Mercedes-Benz Center.

Have the brake pads and brake fluid installed or replaced at a qualified specialist workshop, e.g. an authorized Mercedes-Benz Center.

If the brake system has only been subject to moderate loads, you should test the functionality of your brakes at regular intervals. To do so, press firmly on the brake pedal when driving at a high speed. This improves the grip of the brake pads.

A description of Brake Assist (BAS):
(▷ page 58)

Checking brake lining thickness

You can measure the brake pad/lining thickness using a test gauge. Color-coding (green or red) on the test gauge allows you to determine whether the brake pad/lining thickness is still sufficient. The test gauge is in the vehicle document wallet in the glove box.

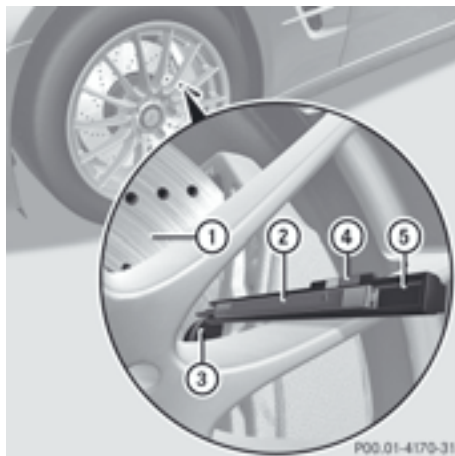

Front wheel



Rear wheel

- ▶ Bring the vehicle and wheels into a suitable position so that you can attach test gauge ⑤.
- ▶ Secure the vehicle against rolling away (▷ page 154).
- ▶ Move the selector lever to position **P**.
- ▶ Switch off the engine.
- ▶ Place test gauge ⑤ between the wheel's spokes on brake pad/lining ③.

- ▶ Hold test gauge ⑤ vertically on brake disc ① and slide measuring pin ② onto brake disc ①.
- ▶ Check which color field ④ the arrow on measuring pin ② is pointing to.

Green: the brake pad/lining thickness is sufficient.

Red: the brake pad/lining thickness is not sufficient. Have the brake pads/lining checked at a qualified specialist workshop.
- ❗ To avoid an inaccurate measurement:
 - make sure you position the wheels suitably
 - do not put the measuring pin on a recess in the brake disc

Driving on wet roads

Hydroplaning

If water has accumulated to a certain depth on the road surface, there is a danger of hydroplaning occurring, even if:

- you drive at low speeds.
- the tires have adequate tread depth.

For this reason, in the event of heavy rain or in conditions in which hydroplaning can occur, you must drive in the following manner:

- lower your speed.
- avoid ruts.
- brake carefully.

Driving on flooded roads

- ❗ Do not drive through flooded areas. Check the depth of any water before driving through it. Drive slowly through standing water. Otherwise, water may enter the vehicle interior or the engine compartment. This can damage the electronic components in the engine or the automatic transmission. Water can also be drawn in by the engine's air suction nozzles and this can cause engine damage.

Winter driving

Important safety notes

WARNING

If the vehicle becomes trapped in snow, ensure that snow is kept away from the exhaust pipe and from around the vehicle as long as the engine is running. Otherwise, poisonous carbon monoxide (CO) may enter the vehicle, resulting in loss of consciousness and even death.

To assure sufficient fresh air ventilation, open a window slightly on the side of the vehicle not facing the wind.

Have your vehicle winterproofed at a qualified specialist workshop at the onset of winter. Observe the notes in the "Winter operation" section (▷ page 528).

Driving with summer tires

Observe the notes in the "Winter operation" section (▷ page 528).

Slippery road surfaces

WARNING

The outside temperature indicator is not designed to serve as an ice-warning device and is therefore unsuitable for that purpose.

Indicated temperatures just above the freezing point do not guarantee that the road surface is free of ice. The road may still be icy, especially in wooded areas or on bridges.

WARNING

On slippery road surfaces, never downshift in order to obtain braking action. This could result in drive wheel slip and reduced vehicle control. Your vehicle's ABS will not prevent this type of loss of control.

WARNING

Make sure that you do not endanger other road users when you apply the brakes.

If the vehicle threatens to skid or cannot be stopped when moving at low speed:

- ▶ Shift the transmission to position **N**.

Drive particularly carefully on slippery road surfaces. Avoid sudden acceleration, steering and braking maneuvers. Do not use cruise control.

- ❗ For more information on driving with snow chains, see (▷ page 529).

Driving systems

Cruise control

Important safety notes

⚠ WARNING

The cruise control is a convenience system designed to assist the driver during vehicle operation. The driver is and must always remain responsible for the vehicle's speed and for safe brake operation.

Only use the cruise control if the road, traffic, and weather conditions make it advisable to travel at a constant speed.

- The use of the cruise control can be dangerous on winding roads or in heavy traffic because conditions do not allow safe driving at a constant speed.
- The use of the cruise control can be dangerous on slippery roads. Rapid changes in tire traction can result in wheel spin and loss of control.
- Deactivate the cruise control when driving in fog.

The "Resume" function should only be operated if the driver is fully aware of the previously set speed and wishes to resume this particular preset speed.

⚠ WARNING

The cruise control brakes automatically so that the set speed is not exceeded.

General notes

Cruise control maintains a constant road speed for you. It brakes automatically in order to avoid exceeding the set speed. On long and steep downhill gradients, especially if the vehicle is laden, you must select shift range **1, 2 or 3** in good time (▷ page 149). By doing so, you will make use of the braking effect of the engine, which relieves the load on the brake system and prevents the brakes from overheating and wearing too quickly.

Use cruise control only if road and traffic conditions make it appropriate to maintain a steady speed for a prolonged period. You can store any road speed above 20 mph (30 km/h).

Cruise control lever



Cruise control lever

- ① To store the current speed or a higher speed
- ② To store the current speed or call up the last stored speed
- ③ To store the current speed or a lower speed
- ④ To deactivate cruise control

When you activate cruise control, the stored speed is shown in the status indicator of the multifunction display:

- USA only: e.g. **CRUISE 55 Miles**
- Canada only: e.g.  **90 Km/h**

Storing, maintaining and calling up a speed

Storing and maintaining the speed



Cruise control lever

- ▶ Accelerate the vehicle to the desired speed.
- ▶ Briefly press the cruise control lever up ① or down ②.
- ▶ Remove your foot from the accelerator pedal.
Cruise control is activated. The vehicle automatically maintains the stored speed.

You can store the current speed if you are driving faster than 20 mph (30km/h).

- ❗ Cruise control may be unable to maintain the stored speed on uphill gradients. The stored speed is resumed when the gradient evens out. Cruise control maintains the stored speed on downhill gradients by automatically applying the brakes.

Storing or calling up the speed

WARNING

The set speed stored in memory should only be set again if prevailing road conditions and legal speed limits permit. Possible acceleration or deceleration differences arising from returning to the preset speed could cause an accident and/or serious injury to you and others.



Cruise control lever

- ▶ Briefly pull the cruise control lever towards you ①.
- ▶ Remove your foot from the accelerator pedal.
The first time cruise control is activated, it stores the current speed or regulates the speed of the vehicle to the previously stored speed.

Setting a speed

WARNING

Keep in mind that it may take a brief moment until the vehicle has made the necessary adjustments.

Increase or decrease the set vehicle speed to a value that the prevailing road conditions and legal speed limits permit. Otherwise, sudden and unexpected acceleration or deceleration of the vehicle could cause an accident and/or serious injury to you and others.



Cruise control lever

- **To adjust the set speed in 1 mph increments (1 km/h increments):** briefly press the cruise control lever up ① to the pressure point for a higher speed, or down ② for a lower speed.

Every time the cruise control lever is pressed up or down, the last speed stored is increased or reduced.

- **To adjust the set speed in 5 mph increments (10 km/h increments):** briefly press the cruise control lever up ① past the pressure point for a higher speed, or down ② for a lower speed. Every time the cruise control lever is pressed up or down, the last speed stored is increased or reduced.

- ❗ Cruise control is not deactivated if you depress the accelerator pedal. For example, if you accelerate briefly to overtake, cruise control adjusts the vehicle's speed to the last speed stored after you have finished overtaking.

Deactivating cruise control



Cruise control lever

There are several ways to deactivate cruise control:

- Briefly press the cruise control lever forwards ①.

or

- Brake.

Cruise control is automatically deactivated if:

- you engage the electric parking brake.
- you are driving at less than 20 mph (30 km/h).
- ESP® intervenes or you deactivate ESP®.
- you shift the transmission to position **N** while driving.

If cruise control is deactivated, you will hear a warning tone. You will see the **Cruise control off** message in the multifunction display for approximately five seconds.

- ❗ When you switch off the engine, the last speed stored is cleared.

DISTRONIC PLUS

Important safety notes

⚠ WARNING

The DISTRONIC PLUS requires familiarity with its operational characteristics. We strongly recommend that you review the following information carefully before operating the system.

⚠ WARNING

The DISTRONIC PLUS is a convenience system. Its speed adjustment reduction capability is intended to make cruise control more effective and usable when traffic speeds vary. It is not however, intended to, nor does it, replace the need for extreme care.

The responsibility for the vehicle's speed, distance to the preceding vehicle and, most importantly, brake operation to ensure a safe stopping distance, always remains with the driver.

The DISTRONIC PLUS cannot take street and traffic conditions into account.

Complex driving situations are not always fully recognized by the DISTRONIC PLUS. This could result in wrong or missing distance warnings.

 **WARNING**

DISTRONIC PLUS distance is not a substitute for the active intervention of the driver. It does not detect pedestrians or stationary objects, nor can it detect, recognize or predict the road's course or the movements of vehicles in front. DISTRONIC PLUS can only brake the vehicle using 40% of the vehicle's maximum available brake force.

DISTRONIC PLUS may not detect narrow vehicles driving in front, e.g. motorcycles, or vehicles driving in the lane beyond the lane next to your vehicle, especially if the vehicles are not driving on the middle of their lane.

The driver must always pay careful attention to the road, weather and traffic conditions. The driver must drive, steer and brake in a manner which will allow him to always have control of the vehicle.

Sources of high-frequency radio waves, such as toll stations, speed-measuring radar, etc., can cause DISTRONIC PLUS to fail temporarily.

 **WARNING**

The DISTRONIC PLUS cannot take road and traffic conditions into account. Only use the DISTRONIC PLUS if the road, weather and traffic conditions make it advisable to travel at a constant speed.

 **WARNING**

Use of the DISTRONIC PLUS can be dangerous on slippery roads. Rapid changes in tire traction can result in wheel spin and loss of control.

The DISTRONIC PLUS does not function in adverse sight and distance conditions. Do not use the DISTRONIC PLUS during conditions of fog, heavy rain, snow or sleet.

 **WARNING**

The DISTRONIC PLUS cannot take weather conditions into account. Switch off the DISTRONIC PLUS or do not switch it on if:

- roads are slippery or covered with snow or ice. The wheels could lose traction while braking or accelerating, and the vehicle could skid.
- the DISTRONIC PLUS system sensor covers are dirty or visibility is diminished due to snow, rain or fog, for example. The distance control system functionality could be impaired.

Always pay attention to surrounding traffic conditions even while the DISTRONIC PLUS is switched on. Otherwise, you may not be able to recognize dangerous situations until it is too late. This could cause an accident in which you and/or others could be injured.

 **WARNING**

The "Resume" function should only be operated if the driver is fully aware of the previously set speed and wishes to resume this particular preset speed.

 **WARNING**

Your undivided attention to street and traffic conditions is necessary at all times whether DISTRONIC PLUS is active or not.

The use of DISTRONIC PLUS can be dangerous on winding roads or in heavy traffic because conditions do not allow safe driving at a constant speed.

DISTRONIC PLUS does not react to stationary objects on the road (for example, a vehicle stopped in traffic or an abandoned vehicle). DISTRONIC PLUS likewise does not react to oncoming vehicles.

Deactivate DISTRONIC PLUS:

- when changing to the right lane, if the vehicles in the left lane are driving slower
- when driving into a filter lane or an expressway exit
- in complex driving situations, for example in construction sites on an expressway

In these situations DISTRONIC PLUS will maintain the set speed if it is not deactivated.

DISTRONIC PLUS is intended only for maintaining a set speed and a set distance from the objects moving in front of the vehicle.

WARNING

An intermittent warning sounds and the distance warning lamp  in the instrument cluster is illuminated if the DISTRONIC PLUS system calculates that the distance to the vehicle ahead and your vehicle's current speed indicate that the DISTRONIC PLUS will not be capable of slowing the vehicle sufficiently to maintain the preset following distance, which creates a danger of a collision.

Immediately brake the vehicle to increase your distance to the preceding vehicle. The warning sound is intended as a final caution in which you should intercede with your own braking inputs to avoid a potentially dangerous situation. Do not wait for the operation of the warning signal to intercede with your own braking. This will result in potentially dangerous emergency braking which will not always result in an impact being avoided.

Tailgating increases the risk of an accident.

WARNING

DISTRONIC PLUS brakes your vehicle with a maximum deceleration of 13 ft/s² (4 m/s²). This corresponds to approximately 40% of your vehicle's maximum braking force.

To avoid a collision, you must apply the brakes yourself. DISTRONIC PLUS brakes the vehicle

just enough to restore the preset speed or the preset distance to the vehicle in front.

WARNING

If you do not receive visual or acoustic warning signals during a critical traffic situation, DISTRONIC PLUS has either not recognized the collision risk, has been deactivated or is malfunctioning.

Remember, whether or not DISTRONIC PLUS is operating, it is ultimately always the drivers responsibility to apply the brakes in order to control the vehicle and avoid a collision.

General notes

DISTRONIC PLUS regulates the speed and automatically helps you maintain the distance to the vehicle detected in front. DISTRONIC PLUS brakes automatically so that the set speed is not exceeded.

On long and steep downhill gradients, especially if the vehicle is laden, you must select shift range **1**, **2** or **3** in good time (> page 149). By doing so, you will make use of the braking effect of the engine, which relieves the load on the brake system and prevents the brakes from overheating and wearing too quickly.

If a slower-moving vehicle is detected in front, DISTRONIC PLUS brakes your vehicle. It maintains the preset distance to the vehicle in front.

If you want DISTRONIC PLUS to assist you, the radar sensor system must be activated (> page 218) and operational.

If there is no vehicle in front, DISTRONIC PLUS operates in the same way as cruise control in the speed range between 20 mph (Canada: 30 km/h) and 120 mph (Canada: 200 km/h). If a vehicle is driving in front of you, it operates in the speed range between 0 mph and (0 km/h) 120 mph (Canada: 200 km/h).

Do not use DISTRONIC PLUS while driving on roads with steep gradients.

As DISTRONIC PLUS transmits radar waves, it can resemble the radar detectors of the responsible authorities. You can refer to the relevant chapter in the Operator's Manual if questions are asked about this.

i USA only: This device has been approved by the FCC as a "Vehicular Radar System". The radar sensor is intended for use in an automotive radar system only. Removing, altering or tampering with the device will void any warranties, and is not permitted by the FCC. Do not tamper with, alter, or use the device in any non-approved way.

Any unauthorized modification to this device could void the user's authority to operate the equipment.

i Canada only: This device complies with RSS-210 of Industry Canada. Operation is subject to the following two conditions:

1. This device may not cause interference, and

2. this device must accept any interference received, including interference that may cause undesired operation of the device.

Removal, tampering, or altering of the device will void any warranties and is not permitted. Do not tamper with, alter, or use the device in any non-approved way.

Any unauthorized modification to this device could void the user's authority to operate the equipment.

Cruise control lever

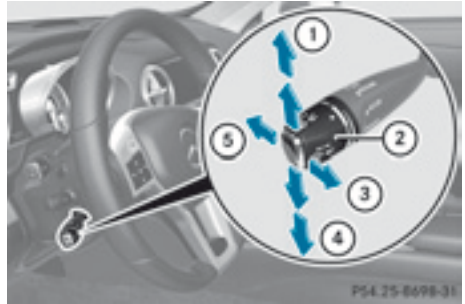

Cruise control lever

- ① To store the current speed or a higher speed
- ② To set the specified minimum distance
- ③ To store the current speed or call up the last stored speed
- ④ To store the current speed or a lower speed
- ⑤ To deactivate DISTRONIC PLUS

Activating DISTRONIC PLUS; storing, maintaining and calling up a speed

Important safety notes

WARNING

When the DISTRONIC PLUS is switched on, the vehicle can be braked. You should therefore switch off the DISTRONIC PLUS if the vehicle must be towed.

In order to activate DISTRONIC PLUS, the following conditions must be fulfilled:

- the engine must be started. It may take up to two minutes after pulling away before DISTRONIC PLUS is operational.
- your vehicle must not be secured by the electric parking brake.
- ESP[®] must be activated.
- the transmission must be in position **D**.
- the driver's door must be closed when you shift from **P** to **D** or your seat belt must be fastened.

- the front-passenger door must be closed.
- the vehicle must not skid.

Activating while driving



Cruise control lever

► Briefly pull the cruise control lever towards you ②, or press it up ① or down ③. DISTRONIC PLUS is selected.

► **To adjust the set speed in 1 mph increments (1 km/h increments):** briefly press the cruise control lever up ① to the pressure point for a higher speed, or down ③ for a lower speed.

Every time the cruise control lever is pressed up or down, the last speed stored is increased or reduced.

or

► **To adjust the set speed in 5 mph increments (10 km/h increments):** briefly press the cruise control lever up ① past the pressure point for a higher speed, or down ③ for a lower speed. Every time the cruise control lever is pressed up or down, the last speed stored is increased or reduced.

► Remove your foot from the accelerator pedal.

Your vehicle adapts its speed to that of the vehicle in front, but only up to the desired stored speed.

If the vehicle in front has been detected and is shown in the multifunction display, you can also activate DISTRONIC PLUS when driving at speeds below 20 mph (30km/h). If the vehicle in front is no longer detected and

displayed, for example because it has changed lanes, DISTRONIC PLUS is deactivated. You will hear a warning tone if this is the case.

i If you do not fully release the accelerator pedal, the **DISTRONIC PLUS Passive** message appears in the multifunction display. The set distance to a slower-moving vehicle in front will then not be maintained. You will be driving at the speed you determine by the position of the accelerator pedal.

Activating when driving towards a stationary vehicle



Cruise control lever

► Briefly pull the cruise control lever towards you ②, or press it up ① or down ③. DISTRONIC PLUS is selected.

► **To adjust the set speed in 1 mph increments (1 km/h increments):** briefly press the cruise control lever up ① to the pressure point for a higher speed, or down ③ for a lower speed.

Every time the cruise control lever is pressed up or down, the last speed stored is increased or reduced.

or

► **To adjust the set speed in 5 mph increments (10 km/h increments):** briefly press the cruise control lever

up ① past the pressure point for a higher speed, or down ③ for a lower speed.

Every time the cruise control lever is pressed up or down, the last speed stored is increased or reduced.

If the vehicle in front of you is stationary, you can only activate DISTRONIC PLUS once your vehicle is stationary as well.

- ❗ DISTRONIC PLUS can only be activated at under 20 mph (30km/h) if a vehicle in front has been detected. Therefore, the DISTRONIC PLUS distance display in the instrument cluster should be activated (▷ page 214).
- ❗ You can use the cruise control lever to set the stored speed and the control on the cruise control lever to set the specified minimum distance (▷ page 172).

Pulling away and driving

⚠ WARNING

When you step on the brake pedal, you switch off the DISTRONIC PLUS except when the vehicle is at a standstill. The DISTRONIC PLUS will no longer brake your vehicle. You are always responsible for maintaining a distance from other vehicles, observing road speeds and braking well in advance.



Cruise control lever

► **If the vehicle in front pulls away:** remove your foot from the brake pedal.

► Briefly pull the cruise control lever towards you ②, or press it up ① or down ③.

or

► Accelerate briefly.

Your vehicle pulls away and adapts its speed to that of the vehicle in front.

If there is no vehicle in front, DISTRONIC PLUS operates in the same way as cruise control.

If DISTRONIC PLUS detects that the vehicle in front has slowed down, it brakes your vehicle. It maintains the preset distance to the vehicle in front.

If DISTRONIC PLUS detects a faster-moving vehicle in front, it increases the driving speed. However, the vehicle is only accelerated up to the speed you have stored.

Changing lanes

⚠ WARNING

DISTRONIC PLUS and Active Blind Spot Assist are only aids designed to assist driving.

They do not relieve you of the responsibility of paying attention. The driver remains fully responsible for the vehicle's distance from other vehicles, the vehicle's speed and for braking in good time. Always pay attention to traffic conditions and your surroundings. Otherwise, you may fail to recognize dangers in time, cause an accident and injure yourself and others.

If you wish to change to the passing lane (in countries where traffic drives on the right, the passing lane is the left-hand lane), DISTRONIC PLUS supports you if:

- you are driving faster than 40mph (60 km/h).
- DISTRONIC PLUS is maintaining the distance to a vehicle in front.

- you have switched on the corresponding turn signal.
- DISTRONIC PLUS does not detect a danger of collision.

If these conditions are fulfilled, your vehicle is accelerated. Acceleration will be interrupted if changing lanes takes too long or if the distance between your vehicle and the vehicle in front becomes too small.

Vehicles with COMAND

- ❗ The following function is not operational in all countries.

DISTRONIC PLUS uses additional information from your navigation system so that it can react appropriately to certain traffic situations. This is the case if, while following a vehicle, DISTRONIC PLUS is active and you:

- approach or drive through a traffic circle
- approach a T intersection
- turn off at a freeway exit

Even if the vehicle in front leaves the detection range, DISTRONIC PLUS temporarily maintains the current driving speed and does not accelerate. This is based on the current map data in the navigation system.

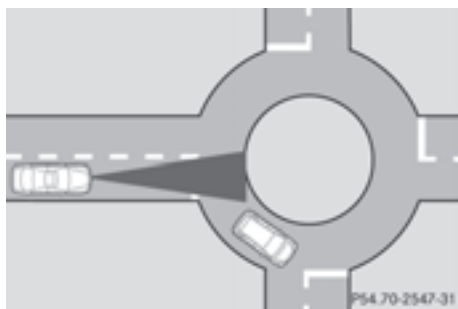

Example: traffic circle

The current speed is maintained:

- approximately ten seconds before the traffic circle/T intersection and for

approximately 1.5 seconds when driving on the traffic circle

- approximately twelve seconds before reaching a freeway exit and approximately four seconds after the freeway exit

Afterwards, the vehicle accelerates back to the set speed you specified.

Stopping

⚠ WARNING

Never get out of the vehicle when DISTRONIC PLUS is activated.

DISTRONIC PLUS must also never be operated, activated or deactivated by a passenger or from outside the vehicle.

DISTRONIC PLUS does not replace the electric parking brake and must not be used for parking.

The DISTRONIC PLUS braking effect is canceled and the vehicle can start moving if:

- DISTRONIC PLUS is deactivated using the cruise control lever.
- you accelerate.
- there is a malfunction in the system or an interruption in the power supply, e.g. battery failure.
- the electrical system in the engine compartment, the battery or the fuses are tampered with.
- the battery is disconnected.

If you wish to leave the vehicle or park it, deactivate DISTRONIC PLUS and secure the vehicle against rolling away.

If DISTRONIC PLUS detects that the vehicle in front is stopping, it brakes your vehicle until it is stationary.

Once your vehicle is stationary, it remains stationary and you do not need to depress the brake. After a time, the electric parking brake secures the vehicle and relieves the service brake.

Depending on the specified minimum distance, your vehicle will come to a standstill at a sufficient distance behind the vehicle in

front. The specified minimum distance is set using the control on the cruise control lever. The electric parking brake automatically secures the vehicle if DISTRONIC PLUS is activated and:

- the driver's door is open and the driver's seat belt is unfastened.
- the engine is switched off, unless it is automatically switched off by the ECO start/stop function.
- a system malfunction occurs.
- the power supply is not sufficient.

If a malfunction occurs, then the transmission may also be shifted into position **P** automatically.

Storing the current speed or calling up the last stored speed

WARNING

The set speed stored in memory should only be set again if prevailing road conditions and legal speed limits permit. Possible acceleration or deceleration differences arising from returning to the preset speed could cause an accident and/or serious injury to you and others.



Cruise control lever

- ▶ Briefly pull the cruise control lever towards you ①.
- ▶ Remove your foot from the accelerator pedal. DISTRONIC PLUS is activated. The first time it is activated, the current speed is

stored. Otherwise, it sets the vehicle cruise speed to the previously stored value.

Setting a speed

WARNING

Keep in mind that it may take a brief moment until the vehicle has made the necessary adjustments.

Increase or decrease the set vehicle speed to a value that the prevailing road conditions and legal speed limits permit. Otherwise, sudden and unexpected acceleration or deceleration of the vehicle could cause an accident and/or serious injury to you and others.



Cruise control lever

▶ To adjust the speed in 1 mph

increments (1 km/h increments):

briefly press the cruise control lever to the pressure point, up ① for a higher speed or down ② for a lower speed.

Every time the cruise control lever is pressed up or down, the last speed stored is increased or reduced.

▶ To adjust the speed in 5 mph

increments (10 km/h increments):

briefly press the cruise control lever beyond the pressure point, up ① for a higher speed or down ② for a lower speed. Every time the cruise control lever is pressed up or down, the last speed stored is increased or reduced.

Setting the specified minimum distance

WARNING

It is up to the driver to exercise discretion to select the appropriate setting given road conditions, traffic, driver's preferred driving style and applicable laws and driving recommendations for safe following distance.



Cruise control lever

▶ **To increase:** turn control ③ in direction ②.

DISTRONIC PLUS then maintains a greater distance between your vehicle and the vehicle in front.

▶ **To decrease:** turn control ③ in direction ①.

DISTRONIC PLUS then maintains a shorter distance between your vehicle and the vehicle in front.

You can set the specified minimum distance for DISTRONIC PLUS by varying the time span between one and two seconds. With this function, you can set the minimum distance that DISTRONIC PLUS keeps to the vehicle in front, dependent on vehicle speed. You can see this distance in the multifunction display (▷ page 172).

Make sure that you maintain a sufficiently safe distance from the vehicle in front. Adjust the distance to the vehicle in front if necessary.

DISTRONIC PLUS displays in the instrument cluster

Displays in the speedometer



When DISTRONIC PLUS is activated, one or two segments ② in the set speed range light up.

If DISTRONIC PLUS detects a vehicle in front, segments ② between speed of the vehicle in front ③ and stored speed ① light up.

i For design reasons, the speed displayed in the speedometer may differ slightly from the speed set for DISTRONIC PLUS.

Display when DISTRONIC PLUS is deactivated



- ① Vehicle in front, if detected
- ② Distance indicator, current distance to the vehicle in front
- ③ Specified minimum distance to the vehicle in front; adjustable
- ④ Own vehicle
- ⑤ Symbol for activated PRE-SAFE® Brake

- ▶ Select the **Distance Display** function using the on-board computer (▷ page 214).

In the Assistance menu of the on-board computer, you can also activate or deactivate PRE-SAFE® Brake (▷ page 214).

Display when DISTRONIC PLUS is activated



- ① DISTRONIC PLUS activated
 - ② Own vehicle
 - ③ Specified minimum distance to the vehicle in front; adjustable
 - ④ Vehicle in front, if detected
- ▶ Select the **Distance Display** function using the on-board computer (▷ page 214).

You will initially see the stored speed for about five seconds when you activate DISTRONIC PLUS.

Deactivating DISTRONIC PLUS

WARNING

DISTRONIC PLUS is deactivated and releases the brakes if the vehicle is slowed down to a speed below 20 mph (30km/h) by the system, provided that DISTRONIC PLUS does not detect a vehicle directly in front. At this point, the driver must apply the brakes in order to slow down further and bring the vehicle to a standstill.



Cruise control lever

There are several ways to deactivate DISTRONIC PLUS:

- ▶ Briefly press the cruise control lever forwards ①.

or

- ▶ Brake, unless the vehicle is stationary.

When you deactivate DISTRONIC PLUS, you will see the **DISTRONIC PLUS Off** message in the multifunction display for approximately five seconds.

- i** The last speed stored remains stored until you switch off the engine.
- i** DISTRONIC PLUS is not deactivated if you depress the accelerator pedal. If you accelerate to overtake, DISTRONIC PLUS adjusts the vehicle's speed to the last speed stored after you have finished overtaking.

DISTRONIC PLUS is automatically deactivated if:

- you engage the electric parking brake or if the vehicle is automatically secured with the electric parking brake.
- you are driving slower than 15 mph (25 km/h) and there is no vehicle in front, or if the vehicle in front is no longer detected.
- ESP® intervenes or you deactivate ESP®.
- the transmission is in the **P**, **R** or **N** position.
- you switch off the radar sensor system (▷ page 218).

- you pull the cruise control lever towards you in order to pull away and the front-passenger door is open.
- the vehicle has skidded.

If DISTRONIC PLUS is deactivated, you will hear a warning tone. You will see the **DISTRONIC PLUS Off** message in the multifunction display for approximately five seconds.

Tips for driving with DISTRONIC PLUS

Important safety notes

WARNING

The DISTRONIC PLUS works to maintain the speed selected by the driver unless a moving obstacle proceeding directly ahead of it in the same travel direction is detected (e.g. following another vehicle ahead of you at your set distance).

This means that:

- Your vehicle can pass another vehicle after you have changed lanes.
- While in a sharp turn or if the preceding vehicle is in a sharp turn, the DISTRONIC PLUS could lose sight of the preceding vehicle. Your vehicle could then accelerate to the previously selected speed.

The DISTRONIC PLUS regulates only the distance between your vehicle and those directly ahead of it. It may not register stationary objects in the road, e.g.:

- a stopped vehicle in a traffic jam
- a disabled vehicle
- an oncoming vehicle

The driver must always be alert, observe all traffic and intercede as required by means of steering or braking the vehicle.

WARNING

The DISTRONIC PLUS should not be used in snowy or icy road conditions.

The following contains descriptions of certain road and traffic conditions in which you must

be particularly attentive. In such situations, brake if necessary. DISTRONIC PLUS is then deactivated.

Cornering, going into and coming out of a bend

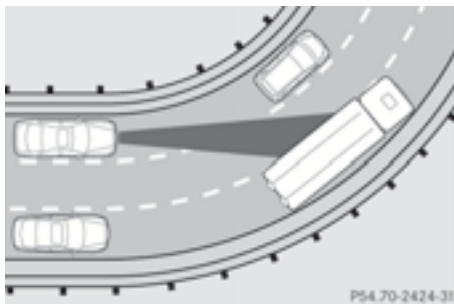

The ability of DISTRONIC PLUS to detect vehicles when cornering is limited. Your vehicle may brake unexpectedly or late.

Vehicles traveling on a different line

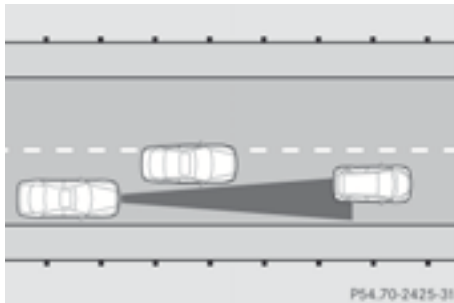

DISTRONIC PLUS may not detect vehicles traveling on a different line. The distance to the vehicle in front will be too short.

Other vehicles changing lanes

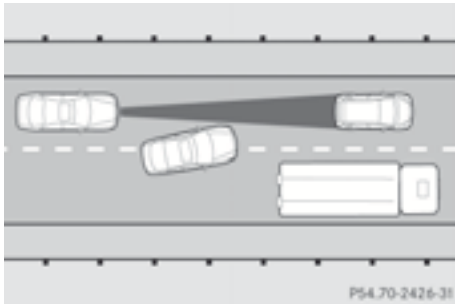

DISTRONIC PLUS has not detected the vehicle cutting in yet. The distance to this vehicle will be too short.

Narrow vehicles

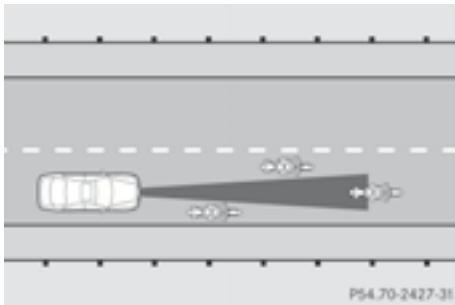

DISTRONIC PLUS has not yet detected the vehicle in front on the edge of the road, because of its narrow width. The distance to the vehicle in front will be too short.

Obstructions and stationary vehicles

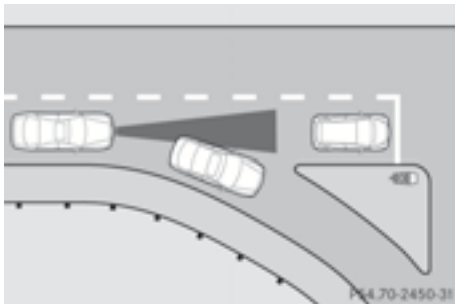

DISTRONIC PLUS does not brake for obstacles or stationary vehicles. If, for

example, the detected vehicle turns a corner and reveals an obstacle or stationary vehicle, DISTRONIC PLUS will not brake for these.

Crossing vehicles

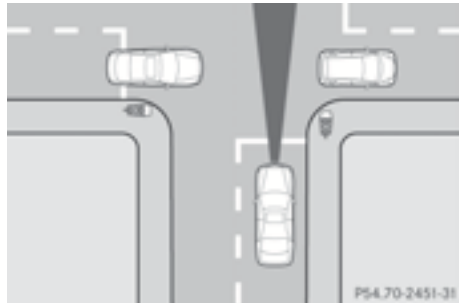

DISTRONIC PLUS may mistakenly detect vehicles that are crossing your lane. Activating DISTRONIC PLUS at traffic lights with crossing traffic, for example, could cause your vehicle to pull away unintentionally.

HOLD function

Important safety notes

WARNING

The vehicle's brakes are applied when the HOLD function is activated. For this reason, deactivate the HOLD function if the vehicle is to be set in motion by other means (e.g. in a car wash or by towing).

WARNING

Never get out of the vehicle when the HOLD function is activated.

The HOLD function must never be operated or deactivated by a passenger or from outside the vehicle.

The HOLD function does not replace the electric parking brake and must not be used for parking.

The braking effect of the HOLD function is canceled and the vehicle could roll away if:

- the HOLD function is deactivated by depressing the accelerator pedal or the brake pedal.
- there is a malfunction in the system or an interruption in the power supply, e.g. battery failure.
- the electrical system in the engine compartment, the battery or the fuses are tampered with.
- the battery is disconnected.

If you leave the vehicle or park it, deactivate the HOLD function and secure the vehicle against rolling away.

General notes

The HOLD function can assist the driver in the following situations:

- when pulling away, especially on steep slopes
- when maneuvering on steep slopes
- when waiting in traffic

The vehicle is kept stationary without the driver having to depress the brake pedal.

The braking effect is canceled and the HOLD function deactivated when you depress the accelerator pedal to pull away.

Activation conditions

You can activate the HOLD function if:

- the vehicle is stationary.
- the engine is running or if it has been automatically switched off by the ECO start/stop function.
- the driver's door is closed or your seat belt is fastened.
- the electric parking brake is released.
- the transmission is in position **D**, **R** or **N**.
- DISTRONIC PLUS is deactivated.

Activating the HOLD function



- ▶ Make sure that the activation conditions are met.
- ▶ Depress the brake pedal.
- ▶ Quickly depress the brake pedal further until **HOLD** display ① appears in the multifunction display. The HOLD function is activated. You can release the brake pedal.

i If depressing the brake pedal the first time does not activate the HOLD function, wait briefly and then try again.

Deactivating the HOLD function

The HOLD function is deactivated automatically if:

- you accelerate and the transmission is in position **D** or **R**.
- you shift the transmission to position **P**.
- you apply the brakes again with a certain amount of pressure until **HOLD** disappears from the multifunction display.
- you secure the vehicle using the electric parking brake.
- you activate DISTRONIC PLUS.

i After a time, the electric parking brake secures the vehicle and relieves the service brake.

The electric parking brake automatically secures the vehicle if the HOLD function is activated and:

- the driver's door is open and the driver's seat belt is unfastened.
- the engine is switched off, unless it is automatically switched off by the ECO start/stop function.

- a system malfunction occurs.
- the power supply is not sufficient.

If a malfunction occurs, then the transmission may also be shifted into position **P** automatically.

RACE START

Important safety notes

WARNING

RACE START is only available when SPORT handling mode is activated. SPORT handling mode only stabilizes the vehicle to a limited extent in the event of swerving or wheelspin. RACE START should only be used on specially designated roads. Always adapt your speed and driving style to the prevailing road and weather conditions.

RACE START enables optimal acceleration from a standing start. The precondition for this is a suitable high-grip road surface.

- i** RACE START is only available for the SL 63 AMG model.

Conditions for activation

You can activate RACE START if:

- the doors are closed.
- the engine is running and it has reached an operating temperature of approximately 176 °F (80 °C). This is the case when the engine oil temperature in the multifunction display stops flashing.
- SPORT handling mode is activated (▷ page 61).
- the steering wheel is in the straight-ahead position.
- the vehicle is stationary and the brake pedal is depressed (left foot).
- the transmission is in position **D**.

Activating RACE START

- ▶ Depress the brake pedal with your left foot and keep it depressed.
- ▶ Turn the drive program selector clockwise (▷ page 147) until the **RS** lamp lights up. The multifunction display shows the **RACE START Confirm: Paddle UP Cancel: Paddle DOWN** message.

- i** If the activation conditions are no longer fulfilled, RACE START is canceled. The multifunction display shows the **RACE START Canceled** message.

- ▶ To cancel: pull the left steering wheel paddle shifter (▷ page 148).

or

- ▶ To confirm: pull the right steering wheel paddle shifter (▷ page 148). The **RACE START Available Depress gas pedal** message appears in the multifunction display.

- i** If you do not depress the accelerator pedal fully within two seconds, RACE START is canceled. The multifunction display shows the **RACE START Not Possible See Operator's Manual** message.

- ▶ Fully depress the accelerator pedal. The engine speed increases to at least 3500 rpm. The **RACE START Release brake to start.** message appears in the multifunction display.

- i** If you do not release the brake pedal within five seconds, RACE START is canceled. The multifunction display shows the **RACE START Canceled** message.

- ▶ Take your foot off the brake, but keep the accelerator pedal depressed. The vehicle pulls away at maximum acceleration. The **RACE START Active** message appears in the multifunction display.

RACE START is deactivated when the vehicle reaches a speed of approximately 30 mph

(Canada: 50 km/h). Drive program **S+** is activated. SPORT handling mode remains activated.

RACE START is deactivated immediately if you release the accelerator pedal during RACE START or if any of the activation conditions are no longer fulfilled. The multifunction display shows the **RACE START Not Possible See Operator's Manual** message.

- ❶ If RACE START is used repeatedly within a short period of time, it is only available again after the vehicle has been driven a certain distance.

Adaptive Damping System

General notes

The adjustable damping system adapts to the current driving conditions. The adjustment depends on whether you have selected sport or comfort mode. Your selection remains stored even if you remove the SmartKey from the ignition lock.

Selecting sports tuning



- ▶ Make sure that the engine is running or that it has been switched off by the ECO start/stop function.
- ▶ **If indicator lamp ❷ is not lit:** press button ❶.
Indicator lamp ❷ lights up. You have selected the suspension for a sporty driving style.

The message **SPORT** appears in the multifunction display.

The firmer setting of the suspension tuning in sports mode ensures even better contact with the road. Select this mode if you want more direct contact with the road when employing a sporty driving style, e.g. on winding country roads.

Selecting comfort tuning

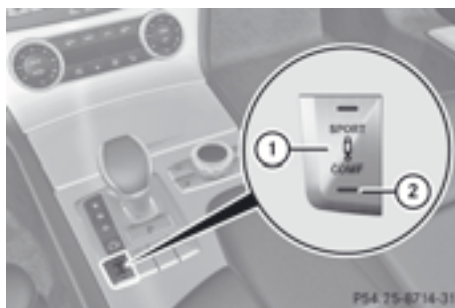

- ▶ Make sure that the engine is running or that it has been switched off by the ECO start/stop function.
- ▶ **If indicator lamp ❷ is not lit:** press button ❶.
Indicator lamp ❷ lights up. You have selected the suspension for a comfortable driving style.
The message **COMFORT** appears in the multifunction display.

In Comfort mode, the driving characteristics of your vehicle are more comfortable. Select this mode if you prefer a more comfortable driving style.

Active Body Control (except AMG vehicles)

Vehicle level

Important safety notes

WARNING

You can raise and lower the level of the stationary vehicle using the corresponding button.

Someone could become trapped if the vehicle is raised or lowered.

Therefore, make sure that nobody is in the vicinity of the wheel housing or under the vehicle. Otherwise limbs, e.g. hands and feet, could become trapped.

In order to reduce fuel consumption and improve the driving dynamics, the vehicle is lowered as its speed increases. With the SPORT suspension tuning, it is lowered by up to 0.5 in (13mm), with COMFORT by up to 0.2 in (5mm). As the speed is reduced, the vehicle is raised up to the set vehicle height. Select the "Normal" setting for normal road surfaces and "Raised" for driving with snow chains or on particularly poor road surfaces. Your selection remains stored even if you remove the SmartKey from the ignition lock.

Setting raised level



- ▶ Make sure that the engine is running or that it has been switched off by the ECO start/stop function.
- ▶ Make sure that a speed of 75 mph (120 km/h) is not exceeded.
- ▶ **If indicator lamp ② is not lit:** press button ①.
If the engine has been switched off by the ECO start/stop function, it is now restarted.
Indicator lamp ② lights up. The vehicle height is adjusted to raised level.

Setting the normal level



- ▶ Make sure that the engine is running or that it has been switched off by the ECO start/stop function.
- ▶ **If indicator lamp ② is lit:** press button ①.
Indicator lamp ② goes out. The vehicle is adjusted to normal level.

The "Raised level" setting is canceled if you:

- are driving faster than approximately 75 mph (120 km/h)
- drive for approximately three minutes at a speed over 50 mph (80km/h)

Suspension tuning

General notes

The electronically controlled ABC suspension system features improved driving dynamics and ride comfort.

The ABC suspension system is tuned individually to each wheel and depends on:

- the road surface condition, e.g. bumps
- the vehicle load
- your individual selection of the sporty or comfort button

Your selection remains stored even if you remove the SmartKey from the ignition lock.

Selecting sports tuning



- ▶ Make sure that the engine is running or that it has been switched off by the ECO start/stop function.

- ▶ **If indicator lamp ② is not lit:** press button ①. Indicator lamp ② lights up. You have selected the suspension for a sporty driving style.

The **ABC Active Body Control¹ SPORT** message appears in the multifunction display.

The firmer suspension tuning in Sport mode ensures even better contact with the road. Select this mode if you favor a firmer suspension tuning.

Selecting comfort tuning

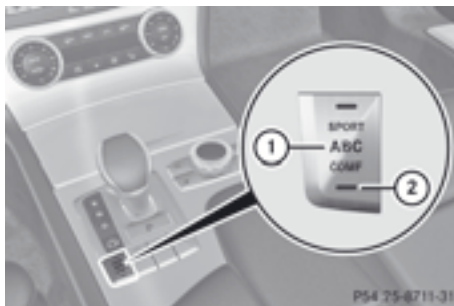

- ▶ Make sure that the engine is running or that it has been switched off by the ECO start/stop function.

- ▶ **If indicator lamp ② is not lit:** press button ①.

Indicator lamp ② lights up. You have selected the suspension for a comfortable driving style.

The **ABC Active Body Control¹ COMFORT** message appears in the multifunction display.

In Comfort mode, the driving characteristics of your vehicle are more comfortable. Select this mode if you favor a more comfortable driving style.

Driving conditions menu in the COMAND display



You can display some driving systems and additional information in the COMAND display.

- ▶ Make sure that the SmartKey is in position **2** in the ignition lock.
- ▶ Make sure COMAND is switched on (▷ page 275).
- ▶ Press button **1**.
The corresponding displays appear in the COMAND display.

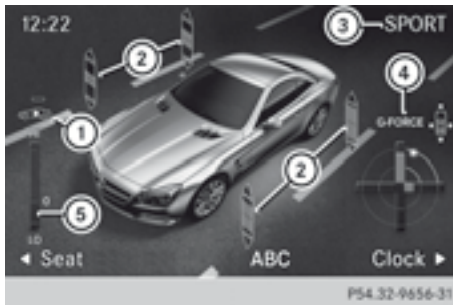

Example: displays in the COMAND display

- ① Selection of raised level (▷ page 179)
- ② Activity of ABC spring struts for roll and pitching support
- ③ Selected suspension tuning, i.e. sports or comfort (▷ page 180)
- ④ G-FORCE (longitudinal and lateral acceleration)
- ⑤ Current vehicle level

Active Body Control (AMG vehicles)

Vehicle level

Important safety notes

Warning

When the vehicle is stationary, you can raise and lower it from the on-board computer. Someone could become trapped if the vehicle is raised or lowered.

Therefore, make sure that nobody is in the vicinity of the wheel housing or under the







vehicle. Otherwise limbs, e.g. hands and feet, could become trapped.

Notes

In order to reduce fuel consumption and improve the driving dynamics, the vehicle is lowered as its speed increases. With the SPORT suspension tuning, it is lowered by up to 0.5 in (13mm), with COMFORT by up to 0.2 in (5mm). As the speed is reduced, the vehicle is raised up to the set vehicle height. Select the "Normal" setting for normal road surfaces and "Raised" for driving with snow chains or on particularly poor road surfaces.

Setting raised level



- ▶ Make sure that the engine is running or that it has been switched off by the ECO start/stop function.
- ▶ Make sure that a speed of 75 mph (120 km/h) is not exceeded.
- ▶ **If icon ② is not shown:** press  or  on the steering wheel to select the **DriveAssist** menu.
- ▶ Press the  or  button to select **Vehicle Level**.
- ▶ Press the  button.
The following message appears: **Press 'OK' to Raise**.
- ▶ Press the  button.
If the engine has been switched off by the ECO start/stop function, it is now restarted.
Icon ② appears. The vehicle height is adjusted to raised level.

Setting the normal level



- ▶ Make sure that the engine is running or that it has been switched off by the ECO start/stop function.
- ▶ **If icon ② is shown:** press ◀ or ▶ on the steering wheel to select the **DriveAssist.** menu.
- ▶ Press the ▲ or ▼ button to select **Vehicle Level.**
- ▶ Press the **OK** button.
The following message appears: **Press 'OK' to Lower.**
- ▶ Press the **OK** button.
Icon ② is faded out. The vehicle is adjusted to normal level.

The "Raised level" setting is canceled if you:

- are driving faster than approximately 75 mph (120 km/h)
- drive for approximately three minutes at a speed over 50 mph (80km/h)

Suspension tuning

General notes

The electronically controlled ABC suspension system features improved driving dynamics and ride comfort.

The ABC suspension system is tuned individually to each wheel and depends on:

- the road surface condition, e.g. bumps
- the vehicle load
- your individual selection of the sporty or comfort button

Selecting sports tuning



- ▶ Make sure that the engine is running or that it has been switched off by the ECO start/stop function.
- ▶ **If indicator lamp ② is not lit:** press button ①.
Indicator lamp ② lights up. You have selected the suspension for a sporty driving style.
The **AMG Suspension System SPORT** message appears in the multifunction display.

The firmer suspension tuning in Sport mode ensures even better contact with the road. Select this mode if you favor a firmer suspension tuning.

Selecting comfort tuning



- ▶ Make sure that the engine is running or that it has been switched off by the ECO start/stop function.

- ▶ **If indicator lamp ② is lit:** press button ①. Indicator lamp ② goes out. You have selected the suspension for a comfortable driving style.

The **AMG Suspension System COMFORT** message appears in the multifunction display.

In Comfort mode, the driving characteristics of your vehicle are more comfortable. Select this mode if you favor a more comfortable driving style.

Driving conditions menu in the COMAND display

You can display some driving systems and additional information in the COMAND display.

- ▶ Call up the driving conditions menu in the COMAND display (▷ page 291). The corresponding displays appear in the COMAND display.

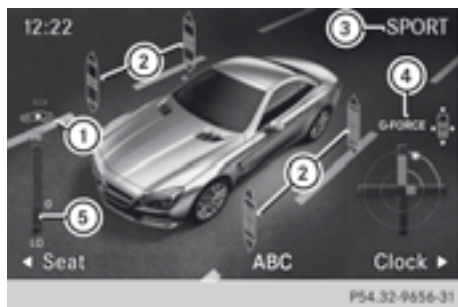

Example: displays in the COMAND display

- ① Selection of raised level (▷ page 181)
- ② Activity of ABC spring struts for roll and pitching support
- ③ Selected suspension tuning, i.e. sports or comfort (▷ page 182)
- ④ G-FORCE (longitudinal and lateral acceleration)
- ⑤ Current vehicle level

PARKTRONIC

Important safety notes

WARNING

The PARKTRONIC is a supplemental system. It is not intended to, nor does it replace, the need for extreme care. The responsibility during parking and other critical maneuvers always remains with the driver.

WARNING

Make sure no persons or animals are in or near the area in which you are parking/maneuvering. Otherwise, they could be injured.

- ❗ When parking, pay particular attention to objects above or below the sensors, such as flower pots or trailer drawbars. PARKTRONIC does not detect such objects when they are in the immediate vicinity of the vehicle. You could damage the vehicle or the objects.

The sensors may not detect snow and other objects that absorb ultrasonic waves.

Ultrasonic sources such as an automatic car wash, the compressed-air brakes on a truck or a pneumatic drill could cause PARKTRONIC to malfunction.

PARKTRONIC may not function correctly on uneven terrain.

PARKTRONIC is an electronic parking aid with ultrasonic sensors. It indicates visually and audibly the distance between your vehicle and an object.

PARKTRONIC is activated automatically when you:

- switch on the ignition
- shift the transmission to position **D**, **R** or **N**
- release the electric parking brake

PARKTRONIC is deactivated at speeds above 11 mph (18km/h). It is reactivated at lower speeds.

PARKTRONIC monitors the area around your vehicle using six sensors in the front bumper and four sensors in the rear bumper.

Range of the sensors

General notes

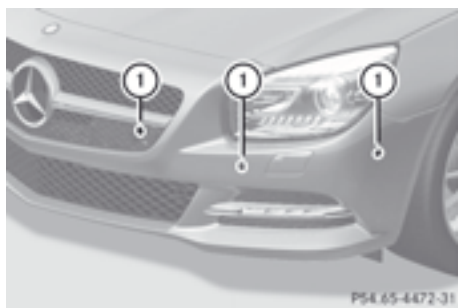

- ① Sensors in the front bumper, left-hand side (example)

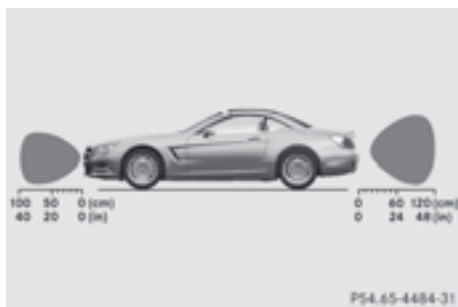

Side view

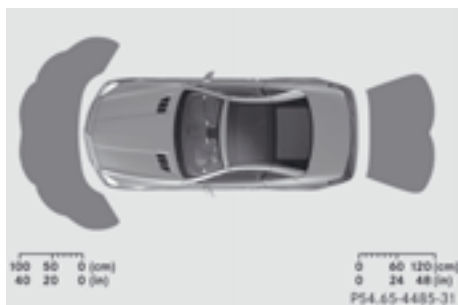

Top view

The sensors must be free of dirt, ice and slush. Otherwise, they may not function correctly. Clean the sensors regularly, taking

care not to scratch or damage them (▷ page 504).

Front sensors

Center	approximately 40in (approximately 100cm)
Corners	approximately 24in (approximately 60cm)

Rear sensors

Center	approximately 48in (approximately 120cm)
Corners	approximately 32in (approximately 80cm)

Minimum distance

Center	approximately 8in (approximately 20cm)
Corners	approximately 6in (approximately 15cm)

If there is an obstacle within this range, the relevant warning displays light up and a warning tone sounds. If the distance falls below the minimum, the distance may no longer be shown.

Warning displays



Warning display for the front area

- ① Segments on the left-hand side of the vehicle
- ② Segments on the right-hand side of the vehicle
- ③ Segments showing operational readiness

The warning displays show the distance between the sensors and the obstacle. The warning display for the front area is located on the dashboard above the center air vents. The warning display for the rear area is located on the cover behind the seats in the rear compartment.

The warning display for each side of the vehicle is divided into five yellow and two red segments. PARKTRONIC is operational if yellow segments showing operational readiness ③ light up.

The selected transmission position and the direction in which the vehicle is rolling determine which warning display is active when the engine is running.

Transmission position	Warning display
D	Front area activated
R, N or the vehicle is rolling backwards	Rear and front areas activated
P	No areas activated

One or more segments light up as the vehicle approaches an obstacle, depending on the vehicle's distance from the obstacle.

- **Front area:** following the sixth segment, you will hear an intermittent warning tone. From the seventh segment, you will hear a continuous warning tone for approximately two seconds. This indicates that you have now reached the minimum distance.
- **Rear area:** from the first segment onwards, you will hear an intermittent warning tone. The interval gets shorter after each segment. At the seventh segment, you will hear a continuous warning tone for approximately two seconds. This indicates that you have now reached the minimum distance.

Deactivating/activating PARKTRONIC



- ① Indicator lamp
- ② To deactivate/activate PARKTRONIC

If indicator lamp ① lights up, PARKTRONIC is deactivated. Active Park Assist is then also deactivated.

- **i** PARKTRONIC is automatically activated when you turn the key to position 2 in the ignition lock.

Problems with PARKTRONIC

Problem	Possible causes/consequences and ► Solutions
Only the red segments in the PARKTRONIC warning displays are lit. You also hear a warning tone for approximately two seconds. PARKTRONIC is deactivated after approximately five seconds, and the indicator lamp in the PARKTRONIC button lights up.	<p>PARKTRONIC has malfunctioned and has switched off.</p> <ul style="list-style-type: none"> ► If problems persist, have PARKTRONIC checked at a qualified specialist workshop.
Only the red segments in the PARKTRONIC warning displays are lit. PARKTRONIC is deactivated after approximately five seconds.	<p>The PARKTRONIC sensors are dirty or there is interference.</p> <ul style="list-style-type: none"> ► Clean the PARKTRONIC sensors (▷ page 504). ► Switch the ignition back on.
	<p>The problem may be caused by an external source of radio or ultrasound waves.</p> <ul style="list-style-type: none"> ► See if PARKTRONIC functions in a different location.

Active Parking Assist

Important safety notes

WARNING

PARKTRONIC and Active Parking Assist are merely parking aids and may not detect all obstacles. They do not relieve you of the responsibility of paying attention.

You are always responsible for safety and must continue to pay attention to your immediate surroundings when parking, exiting parking spaces and maneuvering. You could otherwise endanger yourself and others.

WARNING

When parking or exiting a parking space, you need to make sure that no obstacles are located in the vicinity of the vehicle during the

entire operation. Active Parking Assist does not relieve you of the responsibility of paying attention. It merely aids you by intervening actively in the steering.

To stop the vehicle or to avoid an accident, you need to apply the brakes yourself.

WARNING

Make sure no persons or animals are in or near the area in which you are parking/ maneuvering. Otherwise, they could be injured.

! If unavoidable, you should drive over obstacles such as curbs slowly and not at a sharp angle. Otherwise, you may damage the wheels or tires.

Active Parking Assist is an electronic parking aid with ultrasound. Active steering intervention can assist you when parking or

exiting a parking space. You may also use PARKTRONIC (▷ page 183). When PARKTRONIC is switched off, Active Parking Assist is also unavailable.

Parking tips:

- pay attention to the PARKTRONIC (▷ page 185) warning messages during the parking procedure.
- you can intervene in the steering procedure to correct it at any time. Active Parking Assist will then be canceled.
- when transporting a load which protrudes from your vehicle, you should not use Active Parking Assist.
- never use Active Parking Assist when snow chains or an emergency spare wheel are mounted.
- make sure that the tire pressures are always correct. This has a direct influence on the parking characteristics of the vehicle.

Parking

Detecting a parking space

WARNING

Objects located above the height range of Active Parking Assist will not be detected when the parking space is measured. These are not taken into account when the parking procedure is calculated, e.g. overhanging loads, tail sections or loading ramps of goods vehicles. In some circumstances, Active Parking Assist may therefore guide you into the parking space too early. This may lead to a collision. For this reason, you should avoid using Active Parking Assist in such situations.

WARNING

Active Parking Assist is merely an aid and may sometimes recommend parking spaces that are not suitable for parking. For example, these might be spaces where parking is prohibited, driveways, unsuitable surfaces, etc.

Active Parking Assist measures the parking space as you drive past it. Any later changes to the parking space are not taken into account. For instance, this may be the case when the vehicle parked in front of or behind the space changes its position or when an obstacle is moved into the parking space.

Active Parking Assist does not relieve you of the responsibility of paying attention. If you rely solely on Active Parking Assist, you could cause an accident and injure yourself and others.

You are always responsible for safety and must continue to pay attention to your immediate surroundings when parking and maneuvering.



Example: detected parking space

Active Parking Assist is switched on automatically when driving forwards. The system is operational at speeds of up to approximately 22 mph (35 km/h). While in operation, the system independently locates and measures parking spaces on both sides of the vehicle. At a speed below 19 mph (30 km/h), you will see parking symbol ② as the status indicator in the instrument cluster. If a parking space has been detected, an arrow pointing to the right ③ or left ① is also displayed.

By default, Active Parking Assist only displays parking spaces on the front-passenger side. Parking spaces on the driver's side are displayed as soon as the turn signal on the driver's side is activated. If you wish to park in a space on the driver's side, the indicator on the driver's side must remain on. The turn signal must remain switched on until you acknowledge the use of Active Parking Assist

by pressing the  button on the multifunction steering wheel.

Active Parking Assist will only detect parking spaces:

- that are parallel to the direction of travel
- that are at least 59 in (1.5 m) wide
- that are at least 40 in (1.0 m) longer than your vehicle

A parking space is displayed while you are driving past it, and until you are approximately 50 ft (15 m) away from it.

Use Active Parking Assist for parking spaces:

- that are parallel to the direction of travel
- that are on straight roads, not bends
- that are on the same level as the road, e.g. not on the pavement

Backing up into the parking space

WARNING

The front of the vehicle will veer out in the direction of the oncoming traffic during the parking operation. In some cases the vehicle will also take you onto sections of the oncoming lane during the parking procedure.

You are responsible for safety at all times and must pay attention to any road users approaching or passing. Stop the vehicle if necessary or cancel the Active Parking Assist parking procedure.

- ▶ Stop the vehicle when the parking space symbol shows the desired parking space in the instrument cluster.
- ▶ Shift the transmission to position **R**. The **Start Park Assist? Yes: OK No: ** message appears in the multifunction display.

- ▶ **To cancel the procedure:** press the  button on the multifunction steering wheel or pull away.

or

- ▶ **To park using Active Parking Assist:** press the  button on the multifunction steering wheel.

The **Park Assist Active Accelerate and Brake Observe Surroundings** message appears in the multifunction display.

- ▶ Let go of the multifunction steering wheel.
- ▶ Back up the vehicle, being ready to brake at all times. Do not exceed a maximum speed of approximately 6 mph (10 km/h) when backing up. Otherwise, Active Parking Assist will be deactivated.

- i** When parking in tight spaces, you will achieve the best results by backing up as far as possible. When doing so, also observe the PARKTRONIC messages.

- ▶ Stop as soon as PARKTRONIC sounds the continuous warning tone, if not before. Additional maneuvering may be required in tight parking spaces.

The **Park Assist Active Select D Observe Surroundings** message appears in the multifunction display.

- ▶ Shift the transmission to position **D** while the vehicle is stationary. Active Parking Assist immediately steers in the other direction.

The **Park Assist Active Accelerate and Brake Observe Surroundings** message appears in the multifunction display.

- i** You will achieve the best results by waiting for the steering procedure to complete before pulling away.
- ▶ Drive forwards and be ready to brake at all times.
- ▶ Stop as soon as PARKTRONIC sounds the continuous warning tone, if not before.

The **Park Assist Active Select R Observe Surroundings** message appears in the multifunction display.

- ▶ Drive forwards and back up according to the information shown in the multifunction display.

As soon as the parking procedure is complete, the **Park Assist Finished** message appears in the multifunction display. PARKTRONIC continues to be available.

- ▶ Maneuver if necessary.
- ▶ Always observe the warning messages displayed by PARKTRONIC (▷ page 185).

Parking tips:

- on narrow roads, drive past the parking space as close as possible.
- parking spaces that are littered, overgrown or partially occupied by trailer drawbars might be identified incorrectly or not at all.
- snowfall or heavy rain may lead to a parking space being measured inaccurately.
- the way your vehicle is positioned in the parking space after parking is dependent on various factors. These include the position and shape of the vehicles parked in front and behind it and the conditions of the location. In some cases, Active Parking Assist may guide you too far into a parking space, or not far enough into it. In some cases, it may also lead you across or onto the curb. If necessary, you should abort the parking procedure with Active Parking Assist.
- you can also engage forward gear prematurely. The vehicle redirects and does not drive as far into the parking space. Should a gear be changed too early, the parking procedure will be canceled. A sensible parking position can no longer be achieved from this position.



Exiting a parking space

WARNING

Active Parking Assist does not monitor street traffic. In some cases, the vehicle will also take you onto sections of the oncoming lane when exiting a parking space.

You are responsible for safety at all times and must pay attention to any road users approaching or passing. Stop the vehicle if necessary or cancel Active Parking Assist.

Active Parking Assist can only assist you with exiting a parking space if you have parked the vehicle using Active Parking Assist.

- ▶ Start the engine.
- ▶ Switch on the turn signal on the side facing the street.
- ▶ Shift the transmission to position **D** or **R**. The **Start Park Assist? Yes: OK No: ** message appears in the multifunction display.
- ▶ **To cancel the procedure:** press the  button on the multifunction steering wheel or pull away.

or

- ▶ **To exit a parking space using Active Parking Assist:** press the  button on the multifunction steering wheel. The **Park Assist Active Accelerate and Brake Observe Surroundings** message appears in the multifunction display.
- ▶ Let go of the multifunction steering wheel.
- ▶ Reverse the vehicle or drive forwards, being ready to brake at all times. Do not exceed a maximum speed of approximately 6 mph (10 km/h) when exiting a parking space. Otherwise, Active Parking Assist will be deactivated.
- ▶ Stop as soon as PARKTRONIC sounds the continuous warning tone, if not before.

- ▶ Shift the transmission to position **D** or **R** as required while the vehicle is stationary. Active Parking Assist immediately steers in the other direction.

i You will achieve the best results by waiting for the steering procedure to complete before pulling away. If you back up after activation, the steering wheel is moved to the straight-ahead position.

- ▶ Drive forwards or back up the vehicle, being ready to brake at all times.
- ▶ Stop as soon as PARKTRONIC sounds the continuous warning tone, if not before.
- ▶ Drive forwards and back up as instructed by the PARKTRONIC warning displays.

Once you have exited the parking space completely, the steering wheel is moved to the straight-ahead position. You hear a tone and the message **Park Assist Finished** appears in the multifunction display. You will then have to steer and merge into traffic on your own. PARKTRONIC is still available.

Canceling Active Parking Assist

You can cancel Active Parking Assist at any time.

- ▶ Stop the movement of the multifunction steering wheel or steer yourself. Active Parking Assist will be canceled at once. The **Park Assist canceled** message appears in the multifunction display.

or

- ▶ Press the PARKTRONIC button on the center console (▷ page 185). PARKTRONIC is switched off and Active Parking Assist is immediately canceled. The **Park Assist canceled** message appears in the multifunction display.

Active Parking Assist is canceled automatically if:

- parking using Active Parking Assist is no longer possible.
- you are driving faster than 6mph (10 km/h).
- a wheel spins, ESP[®] intervenes or fails. The  ESP warning lamp lights up in the instrument cluster.

A warning tone sounds. The parking space symbol disappears and the multifunction display shows the **Park Assist canceled** message.

When Active Parking Assist is canceled, you must steer again yourself.

Rear view camera

Important safety notes

WARNING

Make sure that no persons or animals are in the maneuvering range. Otherwise, they could be injured.

WARNING

The rear view camera is only an aid and may display obstacles

- from a distorted perspective
- inaccurately
- may not display obstacles at all

The rear view camera does not relieve you of the responsibility to be cautious. Take care and pay careful attention. The rear view camera may not show objects which are

- very close to the rear bumper
- under the rear bumper
- above the trunk handle

You are responsible for safety at all times and must continue to pay attention to the immediate surroundings when parking and maneuvering. This includes the area behind, in front of, and beside the vehicle. Otherwise you could endanger yourself and/or others.

⚠ WARNING

Under the following circumstances, the rear view camera will not function, or will function in a limited manner:

- if the trunk lid is open
- in heavy rain, snow or fog
- at night or in very dark places
- if the camera is exposed to very bright light
- if the area is lit by fluorescent light or LED lighting (the display may flicker)
- if there is a sudden change in temperature, e.g. when driving into a heated garage in winter
- if the camera lens is dirty or obstructed
- if the rear of your vehicle is damaged. In this event, have the camera position and setting checked at a qualified specialist workshop.

Do not use the rear view camera in these types of situation. You could otherwise injure others or damage objects and your vehicle while you are parking.

General notes

Rear view camera ① is in the trunk lid handle.

Rear view camera ① is an optical parking and maneuvering aid. It shows the area behind your vehicle with guide lines in the COMAND display.

The area behind the vehicle is displayed as a mirror image, as in the rear view mirror.

i The text of messages shown in the COMAND display depends on the language setting. The following are examples of rear

view camera messages in the COMAND display.

Activating/deactivating the rear view camera

- ▶ **To activate:** make sure that the SmartKey is in position **2** in the ignition lock.
- ▶ Make sure that the function "show rear view camera display" is selected in COMAND (▷ page 276).
- ▶ Engage reverse gear. The area behind the vehicle is shown in the COMAND display with guide lines.

To deactivate: the rear view camera is deactivated if you:

- shift the transmission to position **P**
- drive forwards 33 ft (10 m)
- shift the transmission from position **R** to another position (after 15 seconds)
- drive forwards at a speed of over 5 mph (10km/h)

Displays in the COMAND display**⚠ WARNING**

Using the rear view camera can be dangerous if you are color-blind or if your ability to distinguish colors is impaired.

Only use the rear view camera if you can see and distinguish between all the colored guide lines that are displayed by the rear view camera in the COMAND display.

⚠ WARNING

Please note that objects that do not touch the ground may appear to be further away than they actually are, for example:

- the bumper of a vehicle parked behind you
- the trailer drawbar
- the ball coupling of a trailer tow hitch
- the rear end of a truck
- a slanted post

In such cases, you should not use the guide lines to judge the distance. You may misjudge

the distance, which increases the risk of impacting the objects.

Even if the object you approach is directly on the ground, do not approach the object any closer than the red guide line.

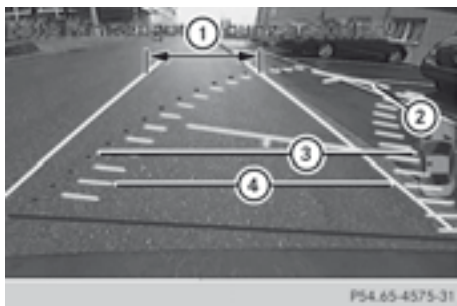

- ① White guide line without turning the steering wheel, vehicle width including the exterior mirrors (static)
- ② Yellow guide line at a distance of approximately 13 ft (4.0m) from the rear of the vehicle
- ③ Red guide line for the vehicle width including the exterior mirrors, for current steering wheel angle (dynamic)
- ④ Yellow lane marking tires at current steering wheel angle (dynamic)



- ⑤ Yellow guide line at a distance of approximately 3 ft (1.0m) from the rear of the vehicle
- ⑥ Vehicle center axle (marker assistance)
- ⑦ Bumper
- ⑧ Red guide line at a distance of approximately 10 in (0.25m) from the rear of the vehicle

The guide lines are shown when the transmission is in position **R**.

The distance specifications only apply to objects that are at ground level.

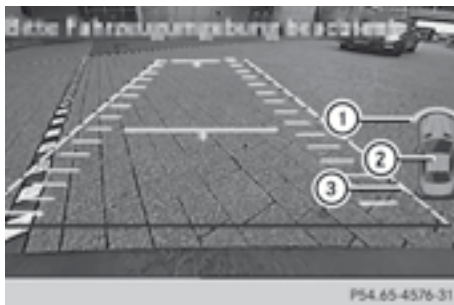

Additional messages for vehicles with PARKTRONIC

- ① Front warning display
- ② Additional PARKTRONIC measurement operational readiness indicator
- ③ Rear warning display

Vehicles with PARKTRONIC: When PARKTRONIC is operational (▷ page 185), the additional operational readiness indicator ② appears in the COMAND Display. If the PARKTRONIC warning displays are active or light up, then the ①③ warning displays are also active or light up correspondingly in the COMAND display.

"Reverse parking" function

Backing up straight into a parking space without turning the steering wheel



- ① White guide line without turning the steering wheel, vehicle width including the exterior mirrors (static)
 - ② Red guide line for the vehicle width including the exterior mirrors, for current steering wheel angle (dynamic)
 - ③ Yellow guide line at a distance of approximately 3 ft (1.0 m) from the rear of the vehicle
 - ④ Red guide line at a distance of approximately 10 in (0.25 m) from the rear of the vehicle
- ▶ Make sure that the rear view camera is switched on (▷ page 191). The lane and the guide lines are shown.
 - ▶ With the help of white guide line ①, check whether the vehicle will fit into the parking space.
 - ▶ Using white guide line ① as a guide, carefully back up until you reach the end position. Red guide line ④ is then at the end of the parking space. The vehicle is almost parallel in the parking space.

Reverse perpendicular parking with the steering wheel at an angle



Turning the steering wheel

- ① Red guide line for the vehicle width through the exterior mirror, for current steering wheel angle (dynamic)
 - ② Parking space marking
- ▶ Make sure that the rear view camera is switched on (▷ page 191). The lane and the guide lines are shown.
 - ▶ Drive past the parking space and bring the vehicle to a standstill.
 - ▶ While the vehicle is at a standstill, turn the steering wheel in the direction of the parking space until red guide line ① reaches parking space marking ②.
 - ▶ Keep the steering wheel in that position and back up carefully.



Backing up with the steering wheel turned

- ① Red guide line for the vehicle width through the exterior mirror, for current steering wheel angle (dynamic)

- ▶ Stop the vehicle when it is almost exactly in front of the parking space. The white lane should be as close to parallel with the parking space marking as possible.



Driving to the final position

- ① White guide line at current steering wheel angle
 - ② Parking space marking
- ▶ Turn the steering wheel to the center position while the vehicle is stationary.



- ① End of parking space
 - ② White guide line without turning the steering wheel
 - ③ Red guide line at a distance of approximately 10 in (0.25 m) from the rear of the vehicle
- ▶ Back up carefully until you have reached the end position. Red guide line ③ is then at the end of parking space ①. The vehicle is almost parallel in the parking space.

ATTENTION ASSIST

Important safety notes

WARNING

The ATTENTION ASSIST is only an aid to the driver. It might not recognize fatigue or increasing inattentiveness in time or fail to recognize them at all. The system cannot substitute a rested and attentive driver.

Fatigue can cause you to recognize dangers too late, to misjudge potential dangers, or to react slower. Therefore, make sure to be rested before and during your trip. Take rests early enough and regularly, especially during long trips. Failure to do so could cause you to recognize dangers too late which could result in an accident and serious injury to you and/others.

ATTENTION ASSIST helps you during long, monotonous journeys such as on freeways and interstate highways. It is active in the range between 50 mph (80 km/h) and 112 mph (180 km/h).

If ATTENTION ASSIST detects typical indicators of fatigue or increasing lapses in concentration on the part of the driver, it suggests you take a break.

ATTENTION ASSIST assesses your level of fatigue or lapses in concentration by taking the following criteria into account:

- your personal driving style, e.g. steering characteristics
- driving conditions, e.g. time, driving time

The functionality of ATTENTION ASSIST is restricted and warnings may be delayed or not occur at all:

- if the road condition is poor, e.g. if the surface is uneven or if there are potholes
- if there is a strong side wind
- if you have adopted a sporty driving style with high cornering speeds or high rates of acceleration

- if you are predominantly driving slower than 50 mph (80 km/h) or faster than 112 mph (180 km/h)
- if you are currently using COMAND or making a telephone call with it
- if the time has been set incorrectly
- in active driving situations, such as when you change lanes or change your speed

Warning and display messages in the multifunction display

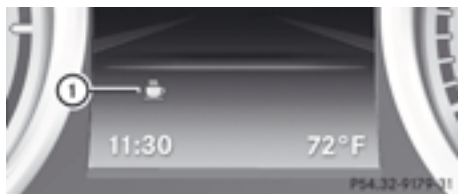

- ▶ Activate ATTENTION ASSIST using the on-board computer (▷ page 214). Symbol ① appears in the multifunction display.
- ▶ **The Attention Assist: Take a Break! message appears in the multifunction display.** If necessary, take a break.
- ▶ Press the or button to confirm the message.

If ATTENTION ASSIST is active, you will be warned no sooner than 20 minutes after your journey has begun. In addition to the message shown in the multifunction display, you will then hear an intermittent warning tone twice.

On long journeys, take regular breaks in good time to allow yourself to rest properly. If you do not take a break and ATTENTION ASSIST still detects increasing lapses in concentration, you will be warned again after 15 minutes at the earliest.

ATTENTION ASSIST is reset when you continue your journey and starts assessing your tiredness again if:

- you switch off the engine.
- you take off your seat belt and open the driver's door, e.g. for a change of drivers or to take a break.

Active Driving Assistance package

General notes

The Active Driving Assistance package consists of DISTRONIC PLUS (▷ page 164), Active Blind Spot Assist (▷ page 195) and Active Lane Keeping Assist (▷ page 199).

Active Blind Spot Assist

Important safety notes

WARNING

Active Blind Spot Assist is only an aid, and may detect vehicles/obstacles incorrectly or not at all.

The system may be impaired or may not function if:

- there is poor visibility, e.g. due to snow, rain, fog or spray.
- the rear and/or front sensors are dirty.

Active Blind Spot Assist may not detect narrow vehicles, such as motorcycles or bicycles, or may only detect them too late. It cannot detect vehicles that are overtaken at a small distance and then enter the blind spot area.

Active Blind Spot Assist cannot detect road and traffic conditions. It is not a substitute for attentive driving. You are responsible for the vehicle's speed, braking in good time, and steering correctly. Always adapt your driving style to suit the prevailing road and weather conditions. Always pay attention to traffic conditions and your surroundings. Otherwise, you may fail to recognize dangers in time,

cause an accident and injure yourself and others.

i USA only: This device has been approved by the FCC as a "Vehicular Radar System". The radar sensor is intended for use in an automotive radar system only. Removing, altering or tampering with the device will void any warranties, and is not permitted by the FCC. Do not tamper with, alter, or use the device in any non-approved way. Any unauthorized modification to this device could void the user's authority to operate the equipment.

i Canada only: This device complies with RSS-210 of Industry Canada. Operation is subject to the following two conditions:

1. This device may not cause interference, and
2. this device must accept any interference received, including interference that may cause undesired operation of the device. Removal, tampering, or altering of the device will void any warranties and is not permitted. Do not tamper with, alter, or use the device in any non-approved way.

Any unauthorized modification to this device could void the user's authority to operate the equipment.

For Active Blind Spot Assist to assist you when driving, the radar sensor system must be activated (▷ page 218) and operational.

General notes

Active Blind Spot Assist uses a radar sensor system to monitor the side areas of your vehicle which are in back of the driver. A warning display in the exterior mirrors draws your attention to vehicles detected in the monitored area. If you then switch on the corresponding turn signal to change lanes, you will also receive an optical and audible collision warning. If a risk of lateral collision is detected, corrective braking may help you avoid a collision. To support the course-correcting brake application, Active Blind

Spot Assist also uses the forward-facing radar sensor system.

Active Blind Spot Assist supports you from a speed of approximately 20 mph (30 km/h).

Monitoring area

WARNING

Active Blind Spot Assist monitors certain areas in the immediate vicinity of your vehicle. Vehicles that approach and drive past at high speeds are not detected. No visual nor audible warnings are emitted and the system does not brake the vehicle to correct your course.

If the lanes are very wide, it may not be possible to monitor the complete width of the neighboring lane. For this reason, vehicles in the next lane may not be detected, especially if they are driving in a staggered formation.

This may be the case if vehicles are driving at that edge of their lane which is furthest away from your vehicle.

Always pay attention to traffic conditions and your surroundings. Otherwise, you may fail to recognize dangers in time, cause an accident and injure yourself and others.

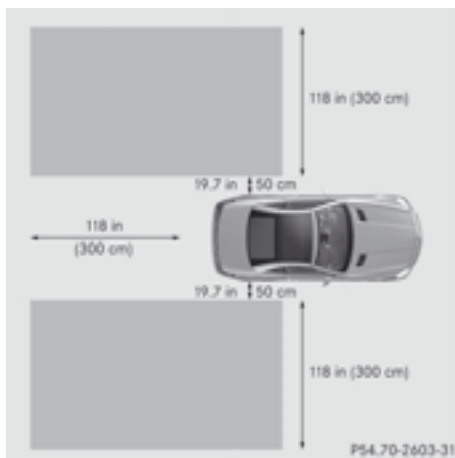

Active Blind Spot Assist monitors the area up to 10 ft (3.0m) behind your vehicle and directly next to your vehicle, as shown in the

diagram. For this purpose, Active Blind Spot Assist uses radar sensors in the rear bumper. If the lanes are narrow, vehicles driving in the lane beyond the lane next to your vehicle may be indicated, especially if the vehicles are not driving in the middle of their lane. This may be the case if there are vehicles driving at the inner edge of their lanes.

Due to the nature of the system:

- warnings may be issued in error when driving close to crash barriers or similar solid lane borders.
- warnings may be interrupted when driving alongside particularly long vehicles, for example trucks, for a prolonged time.

Two Active Blind Spot Assist radar sensors are integrated into the front and rear bumpers respectively. An additional radar sensor is located behind the cover in the radiator grill. Make sure that the bumpers and the cover in the radiator grill are free of dirt, ice or slush. The rear sensors must not be covered, for example by cycle racks or overhanging cargo. Following a severe impact or in the event of damage to the bumpers, have the function of the radar sensors checked at a qualified specialist workshop. Active Blind Spot Assist may otherwise no longer work properly.

Indicator and warning display

WARNING

Active Blind Spot Assist is not active at speeds below 20 mph (30km/h). The indicator lamps in the exterior mirrors are yellow. Vehicles in the monitoring range are then not indicated.

Always pay attention to traffic conditions and your surroundings. Otherwise, you may fail to recognize dangers in time, cause an accident and injure yourself and others.



① Yellow indicator lamp/red warning lamp

When Active Blind Spot Assist is activated, indicator lamp ① in the exterior mirrors lights up yellow at speeds of up to 20 mph (30km/h). At speeds above 20 mph (30km/h), the indicator lamp goes out and Active Blind Spot Assist is operational.

If a vehicle is detected within the monitoring range of Blind Spot Assist at speeds above 20 mph (30km/h), warning lamp ① on the corresponding side lights up red. This warning is always given when a vehicle enters the blind spot monitoring range from behind or from the side. When you overtake a vehicle, the warning only occurs if the difference in speed is less than 7 mph (12km/h).

The yellow indicator lamp goes out if reverse gear is engaged. In this event, Active Blind Spot Assist is no longer active.

The brightness of the indicator/warning lamps is adjusted automatically according to the ambient light.

Visual and audible collision warnings



When you switch on the turn signals to change lanes and a vehicle is detected in the side monitoring range, you receive a visual and acoustic collision warning. You then hear a double warning tone and red warning lamp ① flashes. If the turn signal remains on, detected vehicles are indicated by the flashing of red warning lamp ①. There are no further warning tones.



Course-correcting brake application

WARNING

Active Blind Spot Assist is only an aid designed to assist driving. It is not a substitute for attentive driving. In some cases, the course-correcting brake application is not sufficient to avoid a collision. In such a case, you must steer, brake or accelerate.

In very rare cases, the system may erroneously detect a danger of collision in the area of crash barriers or similar lane borders and apply the brakes. Active Blind Spot Assist does not detect all traffic situations and road users. Always make sure that there is sufficient distance on the side for other traffic or obstacles. An inappropriate brake application may be interrupted at any time if you steer slightly in the opposite direction or accelerate.

You are responsible for driving at appropriate speeds, braking in good time, and steering correctly. Always adapt your driving style to suit the prevailing road and weather conditions. Always pay attention to traffic conditions and your surroundings. Otherwise, you may fail to recognize dangers in time, cause an accident and injure yourself and others.



If a course-correcting brake application occurs, red warning lamp ① flashes in the exterior mirror and a dual warning tone sounds. In addition, display ② appears in the multifunction display.

If Active Blind Spot Assist detects a risk of a lateral collision in the monitoring range, a course-correcting brake application is carried out. This is meant to assist you in avoiding a collision.

The course-correcting brake application is available in the speed range between 20 mph (30 km/h) and 120 mph (200km/h).

There will be either no or only a weak course-correcting brake application if:

- there are vehicles or obstacles, e.g. crash barriers, located on both sides of your vehicle.
- a vehicle approaches you too closely at the side.
- you have adopted a sporty driving style with high cornering speeds.
- you clearly brake or accelerate.

- a driving safety system intervenes, e.g. ESP® or PRE-SAFE® Brake.
- ESP® is switched off.
- a loss of tire pressure or a defective tire is detected.

Switching on Active Blind Spot Assist



- ▶ Make sure that the radar sensor system (▷ page 218) and Active Blind Spot Assist (▷ page 215) are activated in the on-board computer.
- ▶ Turn the SmartKey to position **2** in the ignition lock. Warning lamps ① light up red in the exterior mirrors for approximately 1.5seconds and then turn yellow.

Active Lane Keeping Assist

Important safety notes

WARNING

Active Lane Keeping Assist does not keep your vehicle in its lane. It is only an aid and may detect the lane markings on the road incorrectly or not at all.

The system may be impaired or may not function if:

- several or no lane markings for a single lane are present.
- there is poor visibility, e.g. due to insufficient illumination of the road, or due to snow, rain, fog or spray.
- there is glare, e.g. from oncoming traffic, the sun, or reflection from other vehicles.

- the windshield is dirty, fogged up or covered, for instance by a sticker, in the vicinity of the camera.
- the lane markings are worn away, dark or covered up, e.g. by dirt or snow.
- the distance to the vehicle in front is too small and the lane markings thus cannot be detected.
- the lane markings on the road are unclear, e.g. near roadworks.
- the lane markings change quickly, e.g. lanes branch off, cross one another or merge.
- the road is narrow and winding.

Active Lane Keeping Assist cannot detect road and traffic conditions. It is not a substitute for attentive driving. You are responsible for the vehicle's speed, braking in good time, and steering correctly. Always adapt your driving style to suit the prevailing road and weather conditions. Always pay attention to traffic conditions and your surroundings. Otherwise, you may fail to recognize dangers in time, cause an accident and injure yourself and others.

General notes



Active Lane Keeping Assist monitors the area in front of your vehicle by means of a camera ① at the top of the windshield. Active Lane Keeping Assist detects lane markings on the road and warns you before you leave your lane unintentionally. If you do not react to the warning, a lane-correcting application of the

brakes can bring the vehicle back into the original lane.

If you select **km** on the on-board computer in the **Display Unit Speed-/Odometer** function (▷ page 215), Active Lane Keeping Assist is activated starting at a speed of 60 km/h. If the **miles** display unit is selected, the assistance range begins at 40 mph.

Warning vibration in the steering wheel

A warning may be given if a front wheel passes over a lane marking. It will warn you by means of intermittent vibration in the steering wheel for up to 1.5 seconds.

In order that you are warned only when necessary and in good time if you cross the lane marking, the system recognizes certain conditions and warns you accordingly.

The warning vibration occurs earlier if:

- you approach the outer lane marking on a bend.
- the road has very wide lanes, e.g. a freeway.
- the system recognizes solid lane markings.

The warning vibration occurs later if:

- the road has narrow lanes.
- you cut the corner on a bend.

Lane-correcting brake application

WARNING

Active Lane Keeping Assist does not keep your vehicle in its lane. It is only an aid designed to assist driving. It is not a substitute for attentive driving. In some cases, the lane-correcting brake application is not sufficient to bring your vehicle back to the original lane. In such cases, you must steer the vehicle yourself to ensure that it does not leave the lane.

Active Lane Keeping Assist does not detect road and traffic conditions. Always make sure that there is sufficient distance to the side for other traffic or obstacles. In rare cases, unclear markings or particular structures on the roadway can be recognized as solid lane

markings. An inappropriate brake application, e.g. after intentionally driving over a solid lane marking, may be interrupted at any time by steering slightly in the opposite direction.

Active Lane Keeping Assist cannot take weather conditions into account.

You are responsible for the driving at appropriate speeds, braking in good time, and steering correctly. Always adapt your driving style to suit the prevailing road and weather conditions. Always pay attention to traffic conditions and your surroundings. Otherwise, you may fail to recognize dangers in time, cause an accident and injure yourself and others.



If a lane-correcting brake application occurs, display ① appears in the multifunction display.

If you leave your lane under certain circumstances the vehicle will brake briefly on one side. This is meant to assist you in bringing the vehicle back to the original lane. This function is available in the range between 40 mph and 120 mph (60 km/h and 200 km/h).

A lane-correcting brake application can only be made after driving over a solid, recognizable lane marking. Before this, a warning must be given by means of intermittent vibration in the steering wheel. In addition, a lane with lane markings on both sides must be recognized. The brake application also slightly reduces vehicle speed.

- **i** A further lane-correcting brake application can only occur after your vehicle has returned to the original lane.

No lane-correcting brake application occurs if:

- you clearly and actively steer, brake or accelerate.
- you cut the corner on a sharp bend.
- you have switched on the turn signals.
- a driving safety system intervenes, e.g. ESP®, PRE-SAFE® Brake or Active Blind Spot Assist.
- you have adopted a sporty driving style with high cornering speeds or high rates of acceleration.
- ESP® is switched off.
- the transmission is not in position **D**.
- a loss of tire pressure or a defective tire has been detected and displayed.

Active Lane Keeping Assist does not detect traffic situations or road users. An inappropriate brake application may be interrupted at any time if you:

- steer slightly in the opposite direction.
- switch on the turn signal
- clearly brake or accelerate.

A lane-correcting brake application is interrupted automatically if:

- a driving safety system intervenes, e.g. ESP®, PRE-SAFE® Brake or Active Blind Spot Assist.
- lane markings can no longer be recognized.

Switching on Active Lane Keeping Assist



- ▶ Switch on Active Lane Keeping Assist using the on-board computer; to do so, select **Standard** or **Adaptive** (▷ page 215). Symbol **1** appears in the multifunction display.

If **Standard** is selected, no warning vibration occurs if:

- you have switched on the turn signals. In this event, the warnings are suppressed for a certain period of time.
- a driving safety system intervenes, such as ABS, BAS or ESP®.

If **Adaptive** is selected, no warning vibration occurs if:

- you have switched on the turn signals. In this event, the warnings are suppressed for a certain period of time.
- a driving safety system intervenes, e.g. ABS, BAS or ESP®.
- you accelerate hard, e.g. kickdown.
- you brake hard.
- you steer actively, e.g. swerve to avoid an obstacle or change lane quickly.
- you cut the corner on a sharp bend.

- Useful information 204
- Important safety notes 204
- Displays and operation 205
- Menus and submenus 208
- Display messages 223
- Warning and indicator lamps 255

Useful information

- i** This Operator's Manual describes all models and all standard and optional equipment of your vehicle available at the time of publication of the Operator's Manual. Country-specific differences are possible. Please note that your vehicle may not be equipped with all features described. This also applies to safety-related systems and functions.
- i** Read the information on qualified specialist workshops: (> page 31).

Important safety notes

WARNING

The driver's concentration must always be directed primarily at road traffic.

For your safety and the safety of others, selecting features through the multifunction steering wheel should only be done by the driver when traffic and road conditions permit it to be done safely.

Bear in mind that at a speed of only 30 mph (approximately 50 km/h), the vehicle covers a distance of 44 feet (approximately 14 m) per second.

WARNING

No messages will be displayed if either the instrument cluster or the multifunction display is inoperative.

As a result, you will not be able to see information about your driving conditions, such as

- speed
- outside temperature
- warning/indicator lamps
- malfunction/warning messages
- failure of any systems

Driving characteristics may be impaired.

If you must continue to drive, do so with added caution. Contact an authorized Mercedes-Benz Center as soon as possible.

WARNING

Malfunction and warning messages are only displayed for certain systems and are intentionally not very detailed. The malfunction and warning messages are simply a reminder with respect to the operation of certain systems. They do not replace the owner's and/or driver's responsibility to maintain the vehicle's operating safety. Have all required maintenance services and safety checks performed on the vehicle. Bring the vehicle to an authorized Mercedes-Benz Center to address the malfunction and warning messages.

WARNING

All categories of messages contain important information which should be taken note of and, where a malfunction is indicated, addressed as soon as possible at an authorized Mercedes-Benz Center.

Failure to repair the condition noted may cause damage not covered by the Mercedes-Benz Limited Warranty, or result in property damage or personal injury.

You will find an illustration of the instrument cluster in the "Displays and operation" section (> page 205).

Displays and operation

Instrument cluster



P54.32-9416-31

Instrument cluster: miles

- ① Speedometer with segments (▷ page 206)
- ② Fuel gauge
- ③ Tachometer (▷ page 206)
- ④ Coolant temperature (▷ page 205)
- ⑤ Multifunction display (▷ page 208)
- ⑥ Instrument cluster lighting (▷ page 205)

Instrument lighting

The lighting in the instrument cluster, in the displays and the controls in the vehicle interior can be adjusted using the brightness control knob.

The brightness control knob is on the bottom left of the instrument cluster (▷ page 205).

- ▶ Turn the brightness control knob counter-clockwise or clockwise.
If the light switch is set to **AUTO**, **☀** or **☾**, the brightness is dependent upon the brightness of the ambient light.

- i** The light sensor in the instrument cluster automatically controls the brightness of the multifunction display.

In daylight, the displays in the instrument cluster are not lit.

Coolant temperature display

⚠ WARNING

Driving when your engine is overheated can cause some fluids which may have leaked into the engine compartment to catch fire. You could be seriously burned.

Steam from an overheated engine can cause serious burns which can occur just by opening the engine hood. Stay away from the engine if you see or hear steam coming from it.

Stop the vehicle in a safe location away from other traffic. Turn off the engine, get out of the

vehicle and do not stand near the vehicle until the engine has cooled down.

! A display message is shown if the coolant temperature is too high.

If the coolant temperature is over 248 °F (120 °C), do not continue driving. The engine will otherwise be damaged.

The coolant temperature gauge is in the instrument cluster on the right-hand side (▷ page 205).

Under normal operating conditions and with the specified coolant level, the coolant temperature may rise to 248 °F (120 °C).

Tachometer

! Do not drive in the overrevving range, as this could damage the engine.

The red band in the tachometer indicates the engine's overrevving range.

The fuel supply is interrupted to protect the engine when the red band is reached.

Outside temperature display

⚠ WARNING

The outside temperature indicator is not designed to serve as an ice-warning device and is therefore unsuitable for that purpose.

Indicated temperatures just above the freezing point do not guarantee that the road surface is free of ice. The road may still be icy, especially in wooded areas or on bridges.

The outside temperature display is in the multifunction display (▷ page 208).

Changes in the outside temperature are displayed after a short delay.

Speedometer with segments

The segments in the speedometer indicate which speed range is available.

- Cruise control activated (▷ page 162): The segments light up from the stored speed to the maximum speed.
- DISTRONIC PLUS activated (▷ page 164): One or two segments in the set speed range light up.
- DISTRONIC PLUS detects a vehicle in front: The segments between the speed of the vehicle in front and the stored speed light up.

Operating the on-board computer

Overview









- ① Multifunction display
- ② To switch on the Voice Control System; see the separate operating instructions
- ③ Right control panel
- ④ Left control panel
- ⑤ Back button





► **To activate the on-board computer:** turn the SmartKey to position 1 in the ignition lock.

You can control the multifunction display and the settings in the on-board computer using the buttons on the multifunction steering wheel.



Left control panel

	<ul style="list-style-type: none"> • Calls up the menu and menu bar
	
	Press briefly:
	<ul style="list-style-type: none"> • Scrolls in lists • Selects a submenu or function • In the Audio menu: selects a stored station, an audio track or a video scene • In the Te1 (telephone) menu: switches to the phone book and selects a name or telephone number
	Press and hold:
	<ul style="list-style-type: none"> • In the Audio menu: selects the previous/next station or selects an audio track or a video scene using rapid scrolling • In the Te1 (Telephone) menu: starts rapid scrolling if the phone book is open
	<ul style="list-style-type: none"> • Confirms a selection/display message • In the Te1 (telephone) menu: switches to the telephone book and starts dialing the selected number • In the Audio menu: stops the station search function at the desired station

Right control panel

	<ul style="list-style-type: none"> • Rejects or ends a call • Exits phone book/redial memory
	<ul style="list-style-type: none"> • Makes or accepts a call • Switches to the redial memory
	• Adjusts the volume
	
	• Mute

Back button

	Press briefly:
	<ul style="list-style-type: none"> • Back • Switches off the Voice Control System; see the separate operating instructions • Hides display messages/calls up the last Trip menu function used • Exits the telephone book/redial memory
	Press and hold:
	<ul style="list-style-type: none"> • Calls up the standard display in the Trip menu

Multifunction display



- ① Transmission position (▷ page 145)
- ② Drive program (▷ page 145)
- ③ Description field
- ④ Menu bar
- ⑤ Outside temperature or speed (▷ page 216)
- ⑥ Time (▷ page 290)

► **To show menu bar** ④: press the ◀ or ▶ button on the steering wheel.

Menu bar ④ is hidden after a few seconds.

Text field ③ shows the selected menu or submenu as well as display messages.

The following messages may appear in the multifunction display:

- ↑ Upshift indicator (▷ page 150)
- ◀P▶ Active Parking Assist (▷ page 186)
- CRUISE** Cruise control (▷ page 162)
- ☰ Adaptive Highbeam Assist (▷ page 115)
- ☞ ATTENTION ASSIST (▷ page 194)
- ECO** ECO start/stop function (▷ page 138)
- ☰ Active Lane Keeping Assist (▷ page 199)
- HOLD** HOLD function (▷ page 175)
- ☰ PRE-SAFE® Brake (▷ page 63)

Menus and submenus

Menu overview

Press the ◀ or ▶ button on the steering wheel to call up the menu bar and select a menu.

Operating the on-board computer (▷ page 206).

Depending on the equipment installed in the vehicle, you can call up the following menus:

- **Trip** menu (▷ page 208)
- **Navi** menu (navigation instructions) (▷ page 210)
- **Audio** menu (▷ page 211)
- **Tel** menu (telephone) (▷ page 212)
- **DriveAssist** menu (assistance) (▷ page 214)
- **Service** menu (▷ page 215)
- **Settings** menu (▷ page 215)
- **AMG** menu in AMG vehicles (▷ page 220)

Trip menu

Standard display



► Press and hold the ☰ button on the steering wheel until the **Trip** menu with trip odometer ① and odometer ② is shown.

Trip computer "From start" or "From reset"



Example: trip computer "From start"

- ① Distance
 - ② Time
 - ③ Average speed
 - ④ Average fuel consumption
- ▶ Press the or button on the steering wheel to select the **Trip** menu.
 - ▶ Press or to select **From Start** or **From Reset**.

The values in the **From Start** submenu are calculated from the start of a journey whilst the values in the **From Reset** submenu are calculated from the last time the submenu was reset (▷ page 210).

The **From Start** trip computer is automatically reset when:

- The ignition has been switched off for more than four hours.
- 999 hours have been exceeded.
- 9,999 miles have been exceeded.

The **From Reset** trip computer is automatically reset if the value exceeds 9,999 hours or 99,999 miles.

Displaying the range and current fuel consumption

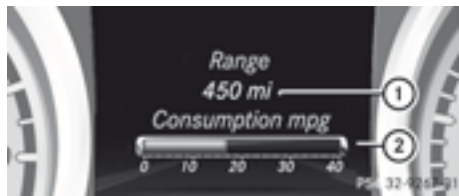

- ① Approximate range
 - ② Current fuel consumption (not for AMG vehicles)
- ▶ Press the or button on the steering wheel to select the **Trip** menu.
 - ▶ Press the or button to select the current fuel consumption (not for AMG vehicles) and the approximate range.

The approximate range that can be covered depends on the fuel level and your current driving style. If there is only a small amount of fuel left in the fuel tank, the display shows a vehicle being refueled instead of the range.

Digital speedometer

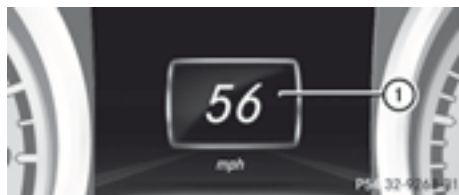

- ① Digital speedometer
- ▶ Press the or button on the steering wheel to select the **Trip** menu.
 - ▶ Press or to select the digital speedometer.

Resetting values



Example: resetting the trip computer "From start"

- ▶ Press the ◀ or ▶ button on the steering wheel to select the **Trip** menu.
- ▶ Press the ▲ or ▼ button to select the function that you wish to reset.
- ▶ Press **OK**.
- ▶ Press the ▼ button to select **Yes** and press the **OK** button to confirm.

You can reset the values of the following functions:

- trip odometer
- trip computer "From start"
- trip computer "From reset"

Navigation system menu

Displaying navigation instructions

In the **Navi** menu, the multifunction display shows navigation instructions. Further information (▷ page 295).

- ▶ Switch on COMAND (▷ page 275).
- ▶ Press the ◀ or ▶ button on the steering wheel to select the **Navi** menu.

Route guidance not active



- ① Direction of travel
- ② Current street

Route guidance active

No change of direction announced



- ① Distance to the destination
- ② Distance to the next change of direction
- ③ Current street
- ④ "Follow the road's course" symbol

Change of direction announced without a lane recommendation



- ① Road into which the change of direction leads
- ② Distance to change of direction and visual distance display
- ③ Change-of-direction icon

When a change of direction has been announced, you will see visual distance display ② next to the symbol for the change of direction ③. This decreases in size as you approach the announced change of direction.

Change of direction announced with a lane recommendation

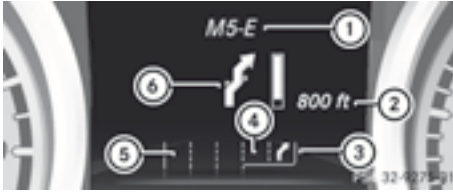

- ① Road into which the change of direction leads
- ② Distance to change of direction and visual distance display
- ③ Lane recommendation
- ④ New lane during a change of direction
- ⑤ Uninterrupted lane
- ⑥ Change-of-direction icon

On multilane roads, lane recommendation ③ may be shown for the next change of direction. During the change of direction, additional lanes may be displayed.

Lane recommendations are only displayed if the relevant data is available on the digital map.

Other status indicators of the navigation system







-  : you have reached the destination or an intermediate destination.
- **New Route...** or **Calculating Route:** a new route is being calculated.
- **Off Map** or **Off Mapped Road:** the vehicle position is outside the area of the digital map (off-map position).
- **No Route:** no route could be calculated to the selected destination.

Audio menu



Selecting a radio station



- ① Waveband
 - ② Station frequency with memory position
- i** Station ② is displayed with the station frequency and station name. The memory position is only displayed along with station ② if this has been stored.

- ▶ Switch on COMAND (▷ page 275).
- ▶ Select radio (▷ page 411).
- ▶ Press the  or  button on the steering wheel to select the **Audio** menu.
- ▶ **To select a stored station:** briefly press the  or  button.
- ▶ **To select a channel from the channel list:** press and briefly hold the  or  button.

If no station list is received:

- ▶ **To select a station using the station search:** press and briefly hold the  or  button.
- i** Switching the waveband (▷ page 413).
Saving the station (▷ page 414).
- i** SIRIUS XM satellite radio functions like a normal radio.
For more information on satellite radio mode (▷ page 416).

Operating audio player or data carrier



Example: CD/DVD changer display

- ① Current CD in the CD/DVD changer
- ② Current title

Audio data from various audio devices or media can be played, depending on the equipment installed in the vehicle.

- ▶ Switch on COMAND (▷ page 275).
- ▶ Select audio player or audio media (▷ page 424).
- ▶ Press the ◀ or ▶ button on the steering wheel to select the **Audio** menu.
- ▶ **To select the next/previous track:** briefly press the ▲ or ▼ button.
- ▶ **To select a track from the track list (rapid scrolling):** press and hold the ▲ or ▼ button until desired track ② has been reached.

If you press and hold the ▲ or ▼ button, the rapid scrolling speed is increased. Not all audio drives or data carriers support this function.

If track information is stored on the audio device or medium, the multifunction display will show the number and title of the track. The current track does not appear in audio AUX mode (**A**uxiliary audio mode: external audio source connected).

Video DVD operation



Example: CD/DVD changer display

- ① Current DVD in the CD/DVD changer
- ② Current scene

- ▶ Switch on COMAND (▷ page 275).
- ▶ Select DVD-V (▷ page 454).
- ▶ Press the ◀ or ▶ button on the steering wheel to select the **Audio** menu.
- ▶ **To select the next or previous scene:** briefly press the ▲ or ▼ button.
- ▶ **To select a scene from the scene list (rapid scrolling):** press and hold the ▲ or ▼ button until desired scene ② has been reached.

Telephone menu

Introduction

WARNING

The driver's attention to the road must always be his/her primary focus when driving. For your safety and the safety of others, we recommend that you pull over to a safe location and stop before placing or taking a telephone call. If you choose to use the telephone while driving, please use the hands-free device and only use the telephone when road, weather and traffic conditions permit. Some jurisdictions prohibit the driver from using a mobile phone while driving a vehicle. Bear in mind that at a speed of just 30 mph (approximately 50 km/h), your vehicle covers a distance of 44 feet (approximately 14 m) every second.

- ▶ Switch on the mobile phone (see the separate operating instructions).
- ▶ Switch on COMAND (▷ page 275).
- ▶ Establish a Bluetooth® connection to COMAND (▷ page 358).
- ▶ Press the ◀ or ▶ button on the steering wheel to select the **Te1** menu.

You will see one of the following display messages in the multifunction display:

- **Phone READY** or the name of the network provider: the mobile phone has found a network and is ready to receive.
- **Phone No Service**: there is no network available or the mobile phone is searching for a network.

Accepting a call



Example: incoming call

- ▶ Press the ☎ button on the steering wheel to accept an incoming call.

If someone calls you when you are in the **Te1** menu, a display message appears in the multifunction display.

You can accept a call even if you are not in the **Te1** menu.

Rejecting or ending a call

- ▶ Press the ☎ button on the steering wheel.

You can end or reject a call even if you are not in the **Te1** menu.

Dialing a number from the phone book

- ▶ Press the ◀ or ▶ button on the steering wheel to select the **Te1** menu.
- ▶ Press the ▲, ▼ or OK button to call up the phone book.
- ▶ Press the ▲ or ▼ button to select the desired name.

or

- ▶ **To begin rapid scrolling**: press and hold the ▲ or ▼ button for longer than one second. Rapid scrolling stops when you release the button or reach the end of the list.

- ▶ **If only one telephone number is stored for a name**: press the ☎ or OK button to start dialing.

or

- ▶ **If there is more than one number for a particular name**: press the ☎ or OK button to display the numbers.

- ▶ Press the ▲ or ▼ button to select the number you want to dial.

- ▶ Press the ☎ or OK button to start dialing.

or

- ▶ **To exit the telephone book**: press the ☎ or ↩ button.

Redialing

The on-board computer saves the last names or numbers dialed in the redial memory.

- ▶ Press the ◀ or ▶ button on the steering wheel to select the **Te1** menu.

- ▶ Press the ☎ button to switch to the redial memory.

- ▶ Press the ▲ or ▼ button to select the desired name or number.

- ▶ Press the ☎ or OK button to start dialing.

or

- ▶ **To exit the redial memory**: press the ☎ or ↩ button.

Assistance menu



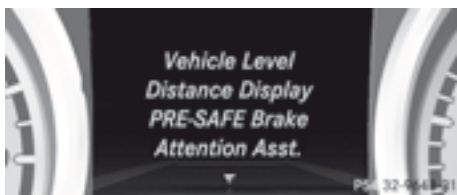

Introduction



In the **DriveAssist** menu, you have the following options:

- AMG vehicles only: set the vehicle level (▷ page 181)
- show the distance display (▷ page 214)
- activate/deactivate the PRE-SAFE® Brake (▷ page 214)
- activate/deactivate ATTENTION ASSIST (▷ page 214)
- activate/deactivate Active Blind Spot Assist (▷ page 215)
- activate/deactivate Active Lane Keeping Assist (▷ page 215)





Showing the distance display

- ▶ Press the  or  button on the steering wheel to select the **DriveAssist** menu.
- ▶ Press the  or  button to select **Distance Display**.
- ▶ Press .

The DISTRONIC PLUS distance display appears in the multifunction display (▷ page 172).



Activating/deactivating PRE-SAFE® Brake

PRE-SAFE® Brake is only available in vehicles with DISTRONIC PLUS.

- ▶ Press the  or  button on the steering wheel to select the **DriveAssist** menu.
- ▶ Press the  or  button to select **PRE-SAFE Brake**.
- ▶ Press .





The current selection is displayed.
- ▶ **To activate/deactivate:** press  again.

When PRE-SAFE® Brake is activated, the multifunction display shows the  symbol as long as the HOLD function is not activated (▷ page 175).

Vehicles with Active Parking Assist: if PARKTRONIC is activated and you are driving at a speed under 22 mph (35 km/h), the  Active Parking Assist symbol is shown instead of the  symbol (▷ page 186).

For more information on PRE-SAFE® Brake, see (▷ page 63).

Activating/deactivating ATTENTION ASSIST







- ▶ Press the  or  button on the steering wheel to select the **DriveAssist** menu.
- ▶ Press the  or  button to select **Attention Asst.**
- ▶ Press .

The current selection is displayed.
- ▶ **To activate/deactivate:** press  again.

When ATTENTION ASSIST is activated, the  symbol appears in the multifunction display when the ignition is on.









For further information about ATTENTION ASSIST, see (▷ page 194).

Activating/deactivating Active Blind Spot Assist

- ▶ Press the  or  button on the steering wheel to select the **DriveAssist** menu.
- ▶ Press the  or  button to select **Blind Spot Asst..**
- ▶ Press .
The current selection is displayed.
- ▶ **To activate/deactivate:** press  again.

For further information about Active Blind Spot Assist, see (▷ page 195).

Activating/deactivating Active Lane Keeping Assist

- ▶ Press the  or  button on the steering wheel to select the **DriveAssist** menu.
- ▶ Press the  or  button to select **Lane Keep. Asst.**
- ▶ Press .
The current selection is displayed.
- ▶ Press the  button to confirm.
- ▶ Press  or  to set **Off**, **Standard** or **Adaptive**.
- ▶ Press the  button to save the setting.

When Active Lane Keeping Assist is activated, the  symbol appears in the multifunction display when the ignition is on.

For further information about Active Lane Keeping Assist, see (▷ page 199).

Service menu



In the **Serv** menu, you have the following options:

- call up display messages (▷ page 223)
- restart the tire pressure loss warning system (▷ page 533)
- check the tire pressure electronically (▷ page 534)
- call up the service due date

Settings menu

Introduction



In the **Sett.** menu, you have the following options:









- change the instrument cluster settings (▷ page 215)
- change the light settings (▷ page 216)
- change the vehicle settings (▷ page 218)
- change the convenience settings (▷ page 219)
- restore the factory settings (▷ page 219)

Instrument cluster submenu

Selecting the unit of measurement for distance

The **Display Unit Speed-/Odometer:** function allows you to choose whether certain displays appear in kilometers or miles in the multifunction display.

You can determine whether the multifunction display shows some messages in miles or kilometers.









- ▶ Press the  or  button on the steering wheel to select the **Settings** menu.
- ▶ Press the  or  button to select the **Inst. Cluster** submenu.
- ▶ Press the  button to confirm.
- ▶ Press the  or  button to select the **Display Unit Speed-/Odometer:** function.
You will see the selected setting: **km** or **miles**.
- ▶ Press the  button to save the setting.

The selected unit of measurement for distance applies to:

- the digital speedometer in the **Trip** menu
- odometer and the trip odometer
- trip computer
- current consumption and the range
- the navigation instructions in the **Navi** menu
- cruise control
- DISTRONIC PLUS
- ASSYST PLUS service interval display

Selecting the permanent display function









You can determine whether the multifunction display permanently shows your speed or the outside temperature.

- ▶ Press the  or  button on the steering wheel to select the **Sett.** menu.
- ▶ Press the  or  button to select the **Instr. Cluster** submenu.
- ▶ Press the  button to confirm.
- ▶ Press the  or  button to select the **Permanent Display** function.
You will see the selected setting: **Outside Temperature** or **Speedometer**.
- ▶ Press the  button to save the setting.

i Speed is displayed in mph.

Light submenu

Setting the daytime running lamps













- i** This function is not available in Canada.
- ▶ Press the  or  button on the steering wheel to select the **Sett.** menu.
- ▶ Press the  or  button to select the **Lights** submenu.
- ▶ Press the  button to confirm.
- ▶ Press the  or  button to select the **Daytime Running Lights** function.
If the **Daytime Running Lights** have been switched on, the cone of light and the  symbol in the multifunction display are shown in red.
- ▶ Press the  button to save the setting.

If you have activated the **Daytime Running Lights** function and the light switch is in the **AUTO** position, the daytime running lamps or parking lamps and low-beam headlamps are switched on depending on the brightness of the ambient light.













When the low-beam headlamps are switched on, the  indicator lamp in the instrument cluster lights up.

Further information on daytime running lamps (▷ page 109).









Setting the brightness of the ambient lighting

- ▶ Press the  or  button on the steering wheel to select the **Sett.** menu.
- ▶ Press the  or  button to select the **Lights** submenu.
- ▶ Press the  button to confirm.
- ▶ Press the  or  button to select the **Amb. Light +/-** function.
You will see the selected setting.
- ▶ Press the  button to confirm.
- ▶ Press the  or  button to adjust the brightness to any level from **Off** to **Level 5** (bright).
- ▶ Press the  or  button to save the setting.

Setting the ambient lighting color

- ▶ Press the  or  button on the steering wheel to select the **Sett.** menu.
- ▶ Press the  or  button to select the **Lights** submenu.
- ▶ Press the  button to confirm.
- ▶ Press the  or  button to select the **Ambient Light Color** function.
- ▶ Press the  button to confirm.
- ▶ Press the  or  button to set the color to **SOLAR**, **SOLAR Orange** or **SOLAR Red**.
- ▶ Press the  or  button to save the setting.





Switching Adaptive Highbeam Assist on/off





- ▶ Press the  or  button on the steering wheel to select the **Settings** menu.
- ▶ Press the  or  button to select the **Lights** submenu.
- ▶ Press the  button to confirm.
- ▶ Press the  or  button to select the **Adaptive Highbeam** function.
If the **Adaptive Highbeam** function has been switched on, the cone of light and the  symbol in the upper multifunction display are shown in red.
- ▶ Press the  button to save the setting.

When Adaptive Highbeam Assist is activated, the  symbol appears in the lower multifunction display.

For further information about Adaptive Highbeam Assist, see (▷ page 114).

Surround lighting and exterior lighting delayed switch-off

- ▶ Press the  or  button on the steering wheel to select the **Settings** menu.
- ▶ Press the  or  button to select the **Lights** submenu.

- ▶ Press the  button to confirm.
- ▶ Press the  or  button to select the **Surround Lighting:** function.
When the **Surround Lighting** function is activated, the cone of light in the multifunction display is shown in red.
- ▶ Press the  button to save the setting.

Deactivating delayed switch-off of the exterior lighting temporarily:

- ▶ Before leaving the vehicle, turn the SmartKey to position **0** in the ignition lock.
- ▶ Turn the SmartKey to position **2** in the ignition lock.
The exterior lighting delayed switch-off is deactivated.

Delayed switch-off of the exterior lighting is reactivated the next time you start the engine.

If you have activated the **Surround Lighting** function and the light switch is set to **AUTO**, the following functions are activated when it is dark:

- **Surround lighting:** the exterior lighting remains lit for 40 seconds after unlocking with the SmartKey. If you start the engine, the surround lighting is switched off and the automatic headlamp mode is activated (▷ page 110).
- **Exterior lighting delayed switch-off:** the exterior lighting remains lit for 60 seconds after the engine is switched off. If you close all the doors and the trunk lid, the exterior lighting goes off after 15 seconds.









i Depending on your vehicle's equipment, when the surround lighting and delayed switch-off exterior lighting are on, the following light up:

- parking lamps
- front fog lamps
- low-beam headlamps
- daytime running lamps

- side marker lamps
- surround lighting in the exterior mirrors









Activating/deactivating the interior lighting delayed switch-off

If you activate the **Interior Lighting Delay** function, the interior lighting remains on for 20seconds after you remove the SmartKey from the ignition lock.

- ▶ Press the  or  button on the steering wheel to select the **Settings** menu.
- ▶ Press the  or  button to select the **Lights** submenu.
- ▶ Press the  button to confirm.
- ▶ Press  or  to select the **Interior Lighting Delay** function. When the **Interior Lighting Delay** function is activated, the vehicle interior is displayed in red in the multifunction display.
- ▶ Press the  button to save the setting.

Vehicle submenu

Activating/deactivating the automatic door locking mechanism









- ▶ Press the  or  button on the steering wheel to select the **Settings** menu.
- ▶ Press the  or  button to select the **Vehicle** submenu.
- ▶ Press the  button to confirm.
- ▶ Press  or  to select the **Automatic Door Lock** function. When the **Automatic Door Lock** function is activated, the vehicle doors are displayed in red in the multifunction display.
- ▶ Press the  button to save the setting.

If you activate the **Automatic Door Lock** function, the vehicle is centrally locked above a speed of around 9 mph (15 km/h).









For further information on the automatic locking feature, see (▷ page 76).

Activating/deactivating the acoustic locking verification signal

If you switch on the **Acoustic Lock** function, an acoustic signal sounds when you lock the vehicle.

- ▶ Press the  or  button on the steering wheel to select the **Settings** menu.
- ▶ Press the  or  button to select the **Vehicle** submenu.
- ▶ Press the  button to confirm.
- ▶ Press the  or  button to select the **Acoustic Lock** function. If the **Acoustic Lock** function is activated, the  symbol in the multifunction display lights up red.
- ▶ Press the  button to save the setting.

Activating/deactivating the radar sensor system

- ▶ Press the  or  button on the steering wheel to select the **Sett.** menu.
- ▶ Press the  or  button to select the **Vehicle** submenu.
- ▶ Press the  button to confirm.
- ▶ Press the  or  button to select **Radar Sensor (See Oper. Manual)**. You will see the selected setting: **On** or **Off**.
- ▶ Press the  button to save the setting.

The following systems are switched off when the radar sensor system is deactivated:

- DISTRONIC PLUS (▷ page 164)
- BAS PLUS (▷ page 58)
- PRE-SAFE® Brake (▷ page 63)
- Active Blind Spot Assist (▷ page 195)

i USA only: This device has been approved by the FCC as a "Vehicular Radar System". The radar sensor is intended for use in an automotive radar system only. Removal, tampering, or altering of the device will void any warranties, and is not permitted by the

FCC. Do not tamper with, alter, or use in any non-approved way.

Any unauthorized modification to this device could void the user's authority to operate the equipment.

i Canada only:

This device complies with the RSS-210 Rules of Industry Canada. Operation is subject to the following two conditions:

1. This device may not cause harmful interference, and
2. this device must accept any interference received, including interference that may cause undesired operation of the device.

Any unauthorized modification to this device could void the user's authority to operate the equipment.

Convenience submenu





Activating/deactivating the EASY-ENTRY/EXIT feature

⚠ WARNING

You must make sure no one can become trapped or injured by the moving steering wheel when the easy-entry/exit feature is activated.

To stop steering wheel movement, move steering wheel adjustment lever or press one of the memory position buttons.

Do not leave children unattended in the vehicle, or with access to an unlocked vehicle. Children could open the driver's door and unintentionally activate the easy-entry/exit feature, which could result in an accident and/or serious personal injury.

- ▶ Press the  or  button on the steering wheel to select the **Sett.** menu.
- ▶ Press the  or  button to select the **Convenience** submenu.
- ▶ Press the  button to confirm.





- ▶ Press  or  to select the **Easy Entry/Exit** function.

If the **Easy Entry/Exit** function is activated, the vehicle steering wheel is displayed in red in the multifunction display.

- ▶ Press the  button to save the setting.

Further information on the EASY-ENTRY/EXIT feature (▶ page 102).

Switching the belt adjustment on/off

- ▶ Press the  or  button on the steering wheel to select the **Sett.** menu.
- ▶ Press the  or  button to select the **Convenience** submenu.

- ▶ Press the  button to confirm.





- ▶ Press the  or  button to select the **Belt Adjustment** function.

When the **Belt Adjustment** function is activated, the vehicle seat belt is displayed in red in the multifunction display.

- ▶ Press the  button to save the setting.



For further information on belt adjustment, see (▶ page 52).

Restoring the factory settings

- ▶ Press the  or  button on the steering wheel to select the **Sett.** menu.
- ▶ Press the  or  button to select the **Factory Setting** submenu.

- ▶ Press the  button to confirm.

The **Reset All Settings?** message appears.

- ▶ Press the  or  button to select **No** or **Yes**.

- ▶ Press the  button to confirm the selection.

If you have selected **Yes**, the multifunction display shows a confirmation message.

For safety reasons, the **Daytime Running Lights** function in the **Lights** submenu is only reset if the vehicle is stationary.

AMG menu in AMG vehicles

AMG displays



- ① Digital speedometer
- ② Gear indicator
- ③ Upshift indicator
- ④ Engine oil temperature
- ⑤ Coolant temperature
- ⑥ ECO start/stop function status indicator (▷ page 139)

▶ Press or on the steering wheel to select the **AMG** menu.

Upshift indicator **UP** ③ indicates that the engine has reached the overrevving range when in the manual gearshift program. Upshift indicator **UP** ③ fades out other messages until you have shifted up.

When the engine oil temperature is below 80 °C, the oil temperature is shown in blue. Avoid driving at full engine output during this time.

SETUP

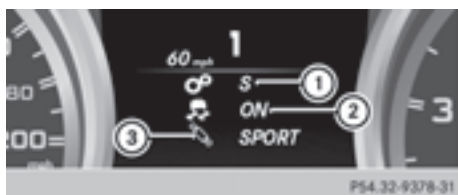

- ① Drive program (**C/S/S+/M**)
- ② ESP® mode (**ON/OFF**) or SPORT handling mode (**SPORT**)
- ③ Suspension tuning (**SPORT/COMFORT**)

SETUP shows the drive program, the ESP® (Electronic Stability Program) mode and the SPORT handling mode.

- ▶ Press the or button on the steering wheel to select the **AMG** menu.
- ▶ Press the button repeatedly until SETUP is displayed.

or

- ▶ Briefly press the AMG button on the center console (▷ page 148).

RACETIMER

Displaying and starting RACETIMER

WARNING

The RACETIMER feature is only for use on roads and in conditions where high speed driving is permitted. Racing on public roads is prohibited under all circumstances. The driver is and must always remain responsible for following posted speed limits.



- ① Lap
- ② RACETIMER

You can start the RACETIMER when the engine is running or if the SmartKey is in position **2** in the ignition lock.

- ▶ Press the or button on the steering wheel to select the **AMG** menu.
- ▶ Press the button repeatedly until the RACETIMER is shown.
- ▶ **To start:** press the button to start the RACETIMER.

Displaying the intermediate time



- ▶ Press or to select **Interm. Time**.
- ▶ Press the button to confirm. The intermediate time is displayed for five seconds.

Starting a new lap



- ① RACETIMER
 - ② Fastest lap time (best lap)
 - ③ Lap
- ▶ Press **New Lap** to confirm.

i It is possible to store a maximum of sixteen laps. Lap 16 can only be stopped with **Finish Lap**.

Stopping the RACETIMER

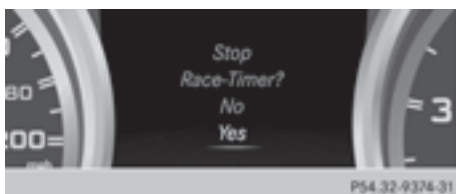

- ▶ Press the button on the steering wheel.
- ▶ Press to confirm **Yes**.

The RACETIMER interrupts timing when you stop the vehicle and turn the SmartKey to position **1** in the ignition lock. When you turn

the SmartKey to position **2** or **3** and then press to confirm **Start**, timing is continued.

Resetting the current lap

- ▶ Stop the RACETIMER.
- ▶ Press or to select **Reset Lap**.
- ▶ Press to reset the lap time to "0".

Deleting all laps

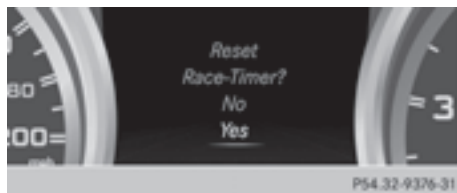

If you switch off the engine, the RACETIMER is reset to "0" after 30 seconds. All laps are deleted.

You cannot delete individual stored laps. If you have stopped 16 laps, the current lap does not have to be reset.

- ▶ Reset the current lap.
- ▶ Press to confirm **Reset Race Timer?** appears in the multifunction display.
- ▶ Press the button to select **Yes** and press the button to confirm. All laps are deleted.

Overall statistics



- ① RACETIMER overall evaluation
- ② Total time driven
- ③ Average speed
- ④ Distance covered
- ⑤ Maximum speed

This function is shown if you have stored at least one lap and stopped the RACETIMER.

- ▶ Press the ◀ or ▶ button on the steering wheel to select the AMG menu.
- ▶ Press the ▲ button repeatedly until the overall evaluation is shown.

Lap statistics

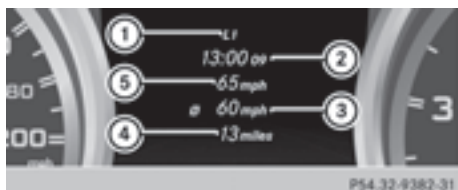

- ① Lap
- ② Lap time
- ③ Average lap speed
- ④ Lap length
- ⑤ Top speed during lap

This function is only available if you have stored at least two laps and have stopped the RACETIMER.

- ▶ Press the ◀ or ▶ button on the steering wheel to select the AMG menu.
- ▶ Press the ▲ button repeatedly until the lap evaluation is shown.
Each lap is shown in a separate submenu.
The fastest lap is indicated by flashing symbol ①.
- ▶ Press the ▲ or ▼ button to select a different lap evaluation.

Display messages

Introduction

General notes

Display messages appear in the multifunction display.

Display messages with graphic displays may be shown in simplified form in the Operator's Manual and may differ from the messages shown in the multifunction display.



Please respond in accordance with the display messages and follow the additional notes in this Operator's Manual.

Certain display messages are accompanied by an audible warning tone or a continuous tone.

When you stop and park the vehicle, please observe the notes on:

- HOLD function (▷ page 175)
- Parking (▷ page 154)

Hiding display messages







- ▶ Press the  or  button on the steering wheel to hide the display message. The display message is cleared.

Display messages with a high priority are shown in red.

You cannot hide display messages of the highest priority. The multifunction display shows these messages continuously until the causes for the messages have been remedied.

Message memory

The on-board computer saves certain display messages. You can call up the display messages in the **message memory**.

- ▶ Press the  or  button on the steering wheel to select the **Serv.** menu. If there are display messages, the multifunction display shows **2 messages**, for example.
- ▶ Press the  or  button to select the entry, e.g. **2 messages**.
- ▶ Confirm with .
- ▶ Press the  or  button to scroll through the display messages.

When the ignition is switched off, all display messages are deleted, apart from some high-priority display messages. Once the causes of the high-priority display messages have been rectified, the corresponding display messages are also deleted.

Safety systems

Display messages





Currently
Unavailable See
Operator's Manual

Possible causes/consequences and ► Solutions

ABS (Anti-lock Braking System), ESP[®] (Electronic Stability Program), BAS (Brake Assist), PRE-SAFE[®], the HOLD function and hill start assist are temporarily unavailable.

BAS PLUS and PRE-SAFE[®] Brake may also have failed.

In addition, the ,  and  warning lamps light up in the instrument cluster.

ATTENTION ASSIST is deactivated.

Possible causes are:

- self-diagnosis is not yet complete.
- the on-board voltage may be insufficient.

 **WARNING**

The brake system continues to function normally, but without the functions listed above. The wheels could therefore lock if you brake hard, for example.

The steerability and braking characteristics may be severely affected. The braking distance in an emergency braking situation can increase.

If ESP[®] is not operational, ESP[®] is unable to stabilize the vehicle. There is an increased risk of skidding and an accident.

- Carefully drive a suitable distance making slight steering movements at a speed above 12 mph (20 km/h).
If the display message disappears, the functions mentioned above are available again.

If the display message continues to be displayed:





- Drive on carefully.
- Visit a qualified specialist workshop.



Inoperative See
Operator's Manual

ABS, ESP[®], BAS, PRE-SAFE[®], the HOLD function and hill start assist are unavailable due to a malfunction.





BAS PLUS and PRE-SAFE[®] Brake may also have failed.













The  (USA only)/ (Canada only), ,  and  warning lamps in the instrument cluster also light up.









ATTENTION ASSIST is deactivated.









 **WARNING**











The brake system continues to function normally, but without the functions listed above. The wheels could therefore lock if you brake hard, for example.









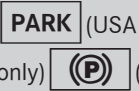

Display messages	Possible causes/consequences and ► Solutions
	<p>The steerability and braking characteristics may be severely affected. The braking distance in an emergency braking situation can increase.</p> <p>If ESP® is not operational, ESP® is unable to stabilize the vehicle. There is an increased risk of skidding and an accident.</p> <ul style="list-style-type: none"> ► Drive on carefully. ► Visit a qualified specialist workshop immediately.
 <p>Currently Unavailable See Operator's Manual</p>	<p>ESP®, BAS, PRE-SAFE®, the HOLD function and hill start assist are temporarily unavailable.</p> <p>BAS PLUS and PRE-SAFE® Brake may also have failed. In addition, the  and  warning lamps light up in the instrument cluster.</p> <p>ATTENTION ASSIST is deactivated.</p> <p>The self-diagnosis function might not be complete, for example.</p> <p> WARNING</p> <p>The brake system continues to function normally, but without the functions listed above.</p> <p>The braking distance in an emergency braking situation can thus increase.</p> <p>If ESP® is not operational, ESP® is unable to stabilize the vehicle. There is an increased risk of skidding and an accident.</p> <ul style="list-style-type: none"> ► Carefully drive a suitable distance making slight steering movements at a speed above 12 mph (20 km/h). If the display message disappears, the functions mentioned above are available again. <p>If the display message continues to be displayed:</p> <ul style="list-style-type: none"> ► Drive on carefully. ► Visit a qualified specialist workshop.

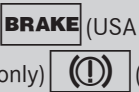

Display messages	Possible causes/consequences and ► Solutions
 <p>Inoperative See Operator's Manual</p>	<p>ESP®, BAS, PRE-SAFE®, the HOLD function and hill start assist are unavailable due to a malfunction.</p> <p>BAS PLUS and PRE-SAFE® Brake may also have failed.</p> <p>In addition, the  and  warning lamps light up in the instrument cluster.</p> <p>ATTENTION ASSIST is deactivated.</p> <p>⚠ WARNING</p> <p>The brake system continues to function normally, but without the functions listed above.</p> <p>The braking distance in an emergency braking situation can thus increase.</p> <p>If ESP® is not operational, ESP® is unable to stabilize the vehicle. There is an increased risk of skidding and an accident.</p> <ul style="list-style-type: none"> ► Drive on carefully. ► Visit a qualified specialist workshop.
   <p>Inoperative See Operator's Manual</p>	<p>EBD (electronic brake force distribution), ABS, ESP®, BAS, PRE-SAFE®, the HOLD function and hill start assist are unavailable due to a malfunction.</p> <p>BAS PLUS and PRE-SAFE® Brake may also have failed.</p> <p>In addition, the ,  and  warning lamps light up in the instrument cluster and a warning tone sounds.</p> <p>⚠ WARNING</p> <p>The brake system continues to function normally, but without the functions listed above. The front and rear wheels could therefore lock if you brake hard, for example.</p> <p>The steerability and braking characteristics may be severely affected. The braking distance in an emergency braking situation can increase.</p> <p>If ESP® is not operational, ESP® is unable to stabilize the vehicle. There is an increased risk of skidding and an accident.</p> <ul style="list-style-type: none"> ► Drive on carefully. ► Visit a qualified specialist workshop immediately.
 (USA only)  (Canada only) <p>Release Park. Brake</p>	<p>The red  (USA only)/ (Canada only) indicator lamp flashes and a warning tone sounds. A condition for automatic release of the electric parking brake is not fulfilled (► page 155). You are driving with the electric parking brake applied.</p> <ul style="list-style-type: none"> ► Release the electric parking brake manually.









Display messages	Possible causes/consequences and ► Solutions
	<p>The red  (USA only)/ (Canada only) indicator lamp flashes and a warning tone sounds.</p> <p>You are making an emergency stop using the electric parking brake (► page 155).</p>
<p> (USA only)  (Canada only)</p> <p>Parking Brake See Operator's Manual</p>	<p>The yellow  warning lamp lights up.</p> <p>The electric parking brake is malfunctioning.</p> <p>To apply:</p> <ul style="list-style-type: none"> ► Switch the ignition off. ► Press the electric parking brake handle for at least ten seconds. ► Shift the transmission to P. ► Consult a qualified specialist workshop. <p>The yellow  warning lamp and the red  (USA only)/ (Canada only) indicator lamp light up.</p> <p>The electric parking brake is malfunctioning.</p> <p>To release:</p> <ul style="list-style-type: none"> ► Switch off the ignition and turn it back on. ► Release the electric parking brake manually. <p>or</p> <ul style="list-style-type: none"> ► Release the electric parking brake automatically (► page 155). <p>If the yellow  warning lamp remains lit or continues to flash:</p> <ul style="list-style-type: none"> ► Do not drive on. ► Consult a qualified specialist workshop.



Display messages	Possible causes/consequences and ► Solutions
	<p>The red  (USA only)/ (Canada only) indicator lamp flashes and the yellow  warning lamp lights up. The electric parking brake is malfunctioning.</p> <p>To release:</p> <ul style="list-style-type: none"> ► Switch off the ignition and turn it back on. ► Release the electric parking brake manually. <p>To apply:</p> <ul style="list-style-type: none"> ► Switch off the ignition and turn it back on. ► Apply the electric parking brake manually. <p>If the red  (USA only)/ (Canada only) indicator lamp continues to flash:</p> <ul style="list-style-type: none"> ► Do not drive on. ► Secure the vehicle against rolling away (▷ page 549). ► Shift the transmission to P. ► Turn the front wheels towards the curb. ► Consult a qualified specialist workshop.
	<p>The yellow  warning lamp lights up. The red  (USA only)/ (Canada only) indicator lamp flashes for about ten seconds after the electric parking brake has been applied or released. It then goes out or remains lit. The electric parking brake is malfunctioning.</p> <ul style="list-style-type: none"> ► Switch off the ignition and turn it back on. ► Apply the electric parking brake. <p>If it is not possible to engage the electric parking brake:</p> <ul style="list-style-type: none"> ► Shift the transmission to P. ► Visit a qualified specialist workshop. <p>If it is not possible to release the electric parking brake:</p> <ul style="list-style-type: none"> ► Release the electric parking brake automatically (▷ page 155). <p>If the electric parking brake still cannot be released:</p> <ul style="list-style-type: none"> ► Consult a qualified specialist workshop.



Display messages	Possible causes/consequences and ► Solutions
	<p>The yellow  warning lamp lights up. If you manually apply or release the electric parking brake, the red  (USA only)/  (Canada only) indicator lamp flashes.</p> <p>The electric parking brake is malfunctioning. It is not possible to apply the electric parking brake manually.</p> <ul style="list-style-type: none"> ► Shift the transmission to P. ► Visit a qualified specialist workshop. <p>1 If you do not wish the electric parking brake to be applied, leave the ignition switched on, e.g. when washing the vehicle in an automatic car wash or when having the vehicle towed. Exception: when having the vehicle towed with the rear axle raised (► page 518).</p>
<p> (USA only)  (Canada only)</p> <p>Parking Brake Inoperative</p>	<p>The yellow  warning lamp lights up. The red  (USA only)/  (Canada only) indicator lamp flashes for about ten seconds after the electric parking brake has been applied or released. It then goes out or remains lit.</p> <p>The electric parking brake is malfunctioning, e.g. because of overvoltage or undervoltage.</p> <ul style="list-style-type: none"> ► Remove the cause for the overvoltage or undervoltage, e.g. by charging the battery or restarting the engine. ► Engage or release the electric parking brake. <p>If it remains impossible to apply or release the electric parking brake:</p> <ul style="list-style-type: none"> ► Switch off the ignition and turn it back on. ► Engage or release the electric parking brake. <p>If the electric parking brake still cannot be released:</p> <ul style="list-style-type: none"> ► Consult a qualified specialist workshop. <p>The display message is only shown while the vehicle is in motion. The yellow  warning lamp lights up and the red  (USA only)/  (Canada only) indicator lamp flashes.</p> <p>It is not possible to apply the electric parking brake manually.</p> <ul style="list-style-type: none"> ► Shift the transmission to P. ► Visit a qualified specialist workshop.

Display messages	Possible causes/consequences and ► Solutions
 <p>PARK (USA only)  (Canada only)</p> <p>Turn On the Ignition to Release the Parking Brake</p>	<p>The red  (USA only)/  (Canada only) indicator lamp lights up.</p> <p>You attempted to release the electric parking brake while the ignition was switched off.</p> <ul style="list-style-type: none"> ► SmartKey: turn the SmartKey to position 1 in the ignition lock. ► KEYLESS-GO: switch on the ignition.
 <p>BRAKE (USA only)  (Canada only)</p> <p>Check Brake Fluid Level</p>	<p>There is not enough brake fluid in the brake fluid reservoir. In addition, the  (USA only)/  (Canada only) warning lamp lights up in the instrument cluster and a warning tone sounds.</p> <p> WARNING</p> <p>The braking effect may be impaired. There is a risk of an accident.</p> <ul style="list-style-type: none"> ► Pull over and stop the vehicle safely as soon as possible, paying attention to road and traffic conditions. Do not continue driving under any circumstances. ► Secure the vehicle against rolling away (▷ page 154). ► Consult a qualified specialist workshop. ► Do not add brake fluid. This does not correct the malfunction.
 <p>Check Brake Pad Wear</p>	<p>The brake pads/linings have reached their wear limit.</p> <ul style="list-style-type: none"> ► Visit a qualified specialist workshop.
 <p>mbrace Inoperative</p>	<p>One or more main features of the mbrace system are malfunctioning.</p> <ul style="list-style-type: none"> ► Have the mbrace system checked immediately at a qualified specialist workshop.
<p>PRE-SAFE Inoperative See Operator's Manual</p>	<p>Important functions of PRE-SAFE® have failed. All other occupant safety systems, e.g. air bags, remain available.</p> <ul style="list-style-type: none"> ► Visit a qualified specialist workshop immediately.

Display messages	Possible causes/consequences and ► Solutions
<p>PRE-SAFE Functions Currently Limited See Operator's Manual</p>	<p>PRE-SAFE® Brake is deactivated or temporarily inoperative. Possible causes are:</p> <ul style="list-style-type: none"> • the DISTRONIC PLUS cover in the radiator grill is dirty. • function is impaired due to heavy rain or snow. • the sensors in the bumpers are dirty. • the radar sensor system is temporarily inoperative, e.g. due to electromagnetic radiation emitted by nearby TV or radio stations or other sources of electromagnetic radiation. • AMG vehicles: ESP® is deactivated. • the system is outside the operating temperature range. • the on-board voltage is too low. <p>► Pull over and stop the vehicle safely as soon as possible, paying attention to road and traffic conditions.</p> <p>► Secure the vehicle against rolling away (▷ page 154).</p> <p>► Clean the DISTRONIC PLUS cover in the radiator grill (▷ page 504).</p> <p>► Clean the bumpers (▷ page 504).</p> <p>► Restart the engine.</p> <p>► AMG vehicles: reactivate ESP®(▷ page 61).</p> <p>If the system detects that the sensors are fully operational, the display message disappears. PRE-SAFE® Brake is operational again.</p>
<p>PRE-SAFE Functions Limited See Operator's Manual</p>	<p>PRE-SAFE® Brake is inoperative due to a malfunction. BAS PLUS or the distance warning signal may also have failed.</p> <p>► Visit a qualified specialist workshop.</p>
<p> Malfunction Service Required</p>	<p>The roll bars are defective.</p> <p> WARNING</p> <p>The roll bars will then possibly not be extended in the event of an accident.</p> <p>There is an increased risk of injury.</p> <p>► Visit a qualified specialist workshop immediately.</p>

Display messages	Possible causes/consequences and ► Solutions
 <p>SRS Malfunction Service Required</p>	<p>There is a malfunction in the SRS (Supplemental Restraint System). The  warning lamp also lights up in the instrument cluster.</p> <p> WARNING</p> <p>The air bags or Emergency Tensioning Devices may either be triggered unintentionally or, in the event of an accident, may not be triggered.</p> <p>There is an increased risk of injury.</p> <p>► Visit a qualified specialist workshop.</p> <p>Further information on occupant safety (► page 37).</p>
 <p>Front Left Malfunction Service Required or Front Right Malfunction Service Required</p>	<p>SRS has malfunctioned at the front on the left or right. The  warning lamp also lights up in the instrument cluster.</p> <p> WARNING</p> <p>The air bags or Emergency Tensioning Devices may either be triggered unintentionally or, in the event of an accident, may not be triggered.</p> <p>There is an increased risk of injury.</p> <p>► Visit a qualified specialist workshop.</p>
 <p>Left Side Curtain Malfunction Service Required or Right Side Curtain Malfunction Service Required</p>	<p>There is a malfunction in the left-hand or right-hand head bag. The  warning lamp also lights up in the instrument cluster.</p> <p> WARNING</p> <p>The left or right headbag may either be triggered unintentionally or, in the event of an accident, may not be triggered.</p> <p>There is an increased risk of injury.</p> <p>► Visit a qualified specialist workshop.</p>

Display messages	Possible causes/consequences and ► Solutions
<p>Front Passenger Airbag Enabled See Operator's Manual</p>	<p>The front-passenger air bag and front-passenger knee bag are enabled during the journey, even though:</p> <ul style="list-style-type: none"> • a child, a small adult or an object weighing less than the system's weight threshold is located on the front-passenger seat. or • the front-passenger seat is unoccupied. <p>The system may detect objects or forces applying additional weight on the seat.</p> <p> WARNING</p> <p>The front-passenger front air bag and front passenger knee bag may be triggered unintentionally.</p> <p>There is an increased risk of injury.</p> <ul style="list-style-type: none"> ► Pull over and stop the vehicle safely as soon as possible, paying attention to road and traffic conditions. ► Secure the vehicle against rolling away (► page 154). ► Switch the ignition off. ► Open the front-passenger door. ► Remove the child and the child restraint system from the front-passenger seat. ► Make sure that there are no objects on the seat adding to the weight. <p>The system may otherwise detect the additional weight and interpret the seat occupant's weight as greater than it actually is.</p> <ul style="list-style-type: none"> ► Keep the seat unoccupied, close the front-passenger door and switch on the ignition. ► Observe the  indicator lamp in the center console and the multifunction display and check the following: <p>Seat unoccupied and ignition switched on:</p> <ul style="list-style-type: none"> • the  indicator lamp must light up and remain lit. When the indicator lamp is on, OCS (Occupant Classification System) has disabled the front-passenger air bag and front-passenger knee bag (► page 43). • the Front Passenger Airbag Enabled See Operator's Manual or Front Passenger Airbag Disabled See Operator's Manual display messages must not be shown in the multifunction display.



Display messages	Possible causes/consequences and ► Solutions
	<ul style="list-style-type: none"> ► Wait for a period of at least 60 seconds until the necessary system checks have been completed. ► Make sure that the display messages do not appear in the multifunction display. <p>If these conditions are fulfilled, the front-passenger seat can be occupied again. Whether the  indicator lamp remains lit or goes out depends on how OCS classifies the occupant. If the conditions are not fulfilled, the system is not operating correctly.</p> <ul style="list-style-type: none"> ► Visit a qualified specialist workshop immediately. <p>For further information about the Occupant Classification System, see (► page 43).</p>
<p>Front Passenger Airbag Disabled See Operator's Manual</p>	<p>The front-passenger air bag and front-passenger knee bag are deactivated during the journey, although:</p> <ul style="list-style-type: none"> • an adult or • a person larger than a certain size is occupying the front-passenger seat. <p>If additional forces are applied to the seat, the system may interpret the occupant's weight as lower than it actually is.</p> <p>⚠ WARNING</p> <p>The front-passenger front air bag and front passenger knee bag may not be triggered in the event of an accident. There is an increased risk of injury.</p> <ul style="list-style-type: none"> ► Pull over and stop the vehicle safely as soon as possible, paying attention to road and traffic conditions. ► Secure the vehicle against rolling away (► page 154). ► Switch the ignition off. ► Have the occupant get out of the vehicle. ► Keep the seat unoccupied, close the front-passenger door and switch on the ignition. ► Observe the  indicator lamp in the center console and the multifunction display and check the following: <p>Seat unoccupied and ignition switched on:</p> <ul style="list-style-type: none"> • the  indicator lamp must light up and remain lit. When the indicator lamp is on, OCS has disabled the front-passenger air bag and front-passenger knee bag (► page 43). • the Front Passenger Airbag Enabled See Operator's Manual or Front Passenger Airbag Disabled See







Display messages	Possible causes/consequences and ► Solutions
	<p>Operator's Manual display messages must not be shown in the multifunction display.</p> <ul style="list-style-type: none"> ▶ Wait for a period of at least 60 seconds until the necessary system checks have been completed. ▶ Make sure that the display messages do not appear in the multifunction display. <p>If these conditions are fulfilled, the front-passenger seat can be occupied again. Whether the  indicator lamp remains lit or goes out depends on how OCS classifies the occupant. If the conditions are not fulfilled, the system is not operating correctly.</p> <ul style="list-style-type: none"> ▶ Visit a qualified specialist workshop immediately. <p>For further information about the Occupant Classification System, see (► page 43).</p>







Lights



i Display messages about LEDs:

This display message will only appear if all LEDs have failed.



Display messages	Possible causes/consequences and ► Solutions
 <p>Check Left Cornering Light or Check Right Cornering Light</p>	<p>The left or right-hand cornering light is defective.</p> <ul style="list-style-type: none"> ▶ Check whether you are permitted to change the bulb yourself (► page 117). <p>or</p> <ul style="list-style-type: none"> ▶ Visit a qualified specialist workshop.
 <p>Check Left Low Beam or Check Right Low Beam</p>	<p>The left or right-hand low-beam headlamp is defective.</p> <ul style="list-style-type: none"> ▶ Check whether you are permitted to change the bulb yourself (► page 117). <p>or</p> <ul style="list-style-type: none"> ▶ Visit a qualified specialist workshop.
 <p>Check Rear Left Turn Signal or Check Rear Right Turn Signal</p>	<p>The rear left-hand or rear right-hand turn signal is defective.</p> <ul style="list-style-type: none"> ▶ Check whether you are permitted to change the bulb yourself (► page 117). <p>or</p> <ul style="list-style-type: none"> ▶ Visit a qualified specialist workshop.

Display messages	Possible causes/consequences and ► Solutions
 <p>Check Front Left Turn Signal or Check Front Right Turn Signal</p>	<p>The front left-hand or front right-hand turn signal is defective.</p> <ul style="list-style-type: none"> ► Check whether you are permitted to change the bulb yourself (▷ page 117). <p>or</p> <ul style="list-style-type: none"> ► Visit a qualified specialist workshop.
 <p>Check Left Mirror Turn Signal or Check Right Mirror Turn Signal</p>	<p>The turn signal in the left-hand or right-hand exterior mirror is defective.</p> <ul style="list-style-type: none"> ► Check whether you are permitted to change the bulb yourself (▷ page 117). <p>or</p> <ul style="list-style-type: none"> ► Visit a qualified specialist workshop.
 <p>Check Center Brake Lamp</p>	<p>The high-mounted brake lamp is faulty.</p> <ul style="list-style-type: none"> ► Check whether you are permitted to change the bulb yourself (▷ page 117). <p>or</p> <ul style="list-style-type: none"> ► Visit a qualified specialist workshop.
 <p>Check Left Brake Lamp or Check Right Brake Lamp</p>	<p>The left or right-hand brake lamp is defective.</p> <ul style="list-style-type: none"> ► Check whether you are permitted to change the bulb yourself (▷ page 117). <p>or</p> <ul style="list-style-type: none"> ► Visit a qualified specialist workshop.
 <p>Check Left Tail and Brake Lamps or Check Right Tail and Brake Lamps</p>	<p>The left or right-hand tail lamp/brake lamp is defective.</p> <ul style="list-style-type: none"> ► Check whether you are permitted to change the bulb yourself (▷ page 117). <p>or</p> <ul style="list-style-type: none"> ► Visit a qualified specialist workshop.
 <p>Check Left High Beam or Check Right High Beam</p>	<p>The left or right-hand high beam is defective.</p> <ul style="list-style-type: none"> ► Check whether you are permitted to change the bulb yourself (▷ page 117). <p>or</p> <ul style="list-style-type: none"> ► Visit a qualified specialist workshop.



Display messages	Possible causes/consequences and ► Solutions
 <p>License Plate Lamp</p>	<p>The left or right-hand license plate lamp is defective.</p> <ul style="list-style-type: none"> ► Check whether you are permitted to change the bulb yourself (▷ page 117). <p>or</p> <ul style="list-style-type: none"> ► Visit a qualified specialist workshop.
 <p>Check Left Fog Lamp or Check Right Fog Lamp</p>	<p>The left-hand or right-hand front fog lamp is defective.</p> <ul style="list-style-type: none"> ► Check whether you are permitted to change the bulb yourself (▷ page 117). <p>or</p> <ul style="list-style-type: none"> ► Visit a qualified specialist workshop.
 <p>Check Front Left Parking Lamp or Check Front Right Parking Lamp</p>	<p>The front left or front right parking or standing lamp is defective.</p> <ul style="list-style-type: none"> ► Check whether you are permitted to change the bulb yourself (▷ page 117). <p>or</p> <ul style="list-style-type: none"> ► Visit a qualified specialist workshop.
 <p>Backup Light</p>	<p>The backup lamp is defective.</p> <ul style="list-style-type: none"> ► Check whether you are permitted to change the bulb yourself (▷ page 117). <p>or</p> <ul style="list-style-type: none"> ► Visit a qualified specialist workshop.
 <p>Check Left Daytime Running Light or Check Right Daytime Running Light</p>	<p>The left or right-hand daytime running lamp is defective.</p> <ul style="list-style-type: none"> ► Check whether you are permitted to change the bulb yourself (▷ page 117). <p>or</p> <ul style="list-style-type: none"> ► Visit a qualified specialist workshop.
 <p>Active Headlamps Inoperative</p>	<p>The active light function is defective.</p> <ul style="list-style-type: none"> ► Visit a qualified specialist workshop.
 <p>Malfunction See Operator's Manual</p>	<p>The exterior lighting is defective.</p> <ul style="list-style-type: none"> ► Visit a qualified specialist workshop.



Display messages	Possible causes/consequences and ► Solutions
 <p>Auto Lamp Function Inoperative</p>	<p>The light sensor is defective.</p> <p>► Visit a qualified specialist workshop.</p>
 <p>Switch Off Lights</p>	<p>The lights are still switched on when you leave the vehicle. A warning tone also sounds.</p> <p>► Turn the light switch to AUTO.</p>
<p>Adaptive Highbeam Assist Inoperative</p>	<p>Adaptive Highbeam Assist is faulty.</p> <p>► Visit a qualified specialist workshop.</p>
<p>Adaptive Highbeam Assist Currently Unavailable See Operator's Manual</p>	<p>Adaptive Highbeam Assist is deactivated and temporarily inoperative. Possible causes are:</p> <ul style="list-style-type: none"> • the windshield in the camera's field of vision is dirty. • visibility is impaired due to heavy rain, snow or fog. <p>► Clean the windshield.</p> <p>If the system detects that the camera is fully operational again, the Adaptive Highbeam Assist Now Available message is displayed.</p> <p>Adaptive Highbeam Assist is operational again.</p>

Engine



Display messages	Possible causes/consequences and ► Solutions
 <p>Check Coolant Level See Operator's Manual</p>	<p>The coolant level is too low.</p> <p>! Avoid making long journeys with too little coolant in the engine cooling system. The engine will otherwise be damaged.</p> <p>► Add coolant, observing the warning notes before doing so (► page 498).</p> <p>► If coolant needs to be added more often than usual, have the engine coolant system checked at a qualified specialist workshop.</p>
	<p>The fan motor is faulty.</p> <p>► At coolant temperatures under 248 °F(120 °C), drive to the next qualified specialist workshop.</p> <p>► Avoid subjecting the engine to heavy loads, e.g. driving in mountainous terrain, and stop-and-go traffic.</p>



Display messages	Possible causes/consequences and ► Solutions
 <p data-bbox="112 229 331 316">Coolant Too Hot Stop Vehicle Turn Engine Off</p>	<p data-bbox="367 177 598 201">The coolant is too hot.</p> <p data-bbox="367 213 658 237">A warning tone also sounds.</p> <p data-bbox="378 256 533 284">⚠ WARNING</p> <p data-bbox="367 300 1034 381">Do not drive when your engine is overheated. This can cause some fluids which may have leaked into the engine compartment to catch fire.</p> <p data-bbox="367 394 1031 448">Steam from the overheated engine can also cause serious burns which can occur just by opening the hood.</p> <p data-bbox="367 459 609 483">There is a risk of injury.</p> <ul style="list-style-type: none"> <li data-bbox="367 496 1031 550">► Pull over and stop the vehicle safely and switch off the engine, paying attention to road and traffic conditions. <li data-bbox="367 561 936 585">► Secure the vehicle against rolling away (► page 154). <li data-bbox="367 596 1034 651">► Leave the vehicle and keep a safe distance from the vehicle until the engine has cooled down. <li data-bbox="367 662 986 716">► Make sure that the air supply to the engine radiator is not blocked, e.g. by snow, slush or ice. <li data-bbox="367 727 1034 809">► Do not start the engine again until the display message goes out and the coolant temperature is under 248 °F (120 °C). Otherwise, the engine could be damaged. <li data-bbox="367 820 894 844">► Pay attention to the coolant temperature display. <li data-bbox="367 855 1014 909">► If the temperature increases again, visit a qualified specialist workshop immediately. <p data-bbox="367 922 1034 976">Under normal operating conditions and with the specified coolant level, the coolant temperature may rise to 248 °F (120 °C).</p>

Display messages	Possible causes/consequences and ► Solutions
	<p>The battery is not being charged. A warning tone also sounds.</p> <p>Possible causes are:</p> <ul style="list-style-type: none"> • a defective alternator • a torn poly-V-belt • a malfunction in the electronics <ul style="list-style-type: none"> ► Pull over and stop the vehicle safely and switch off the engine, paying attention to road and traffic conditions. ► Secure the vehicle against rolling away (▷ page 154). ► Open the hood. ► Check whether the poly-V-belt is torn. <p>If the poly-V-belt is torn:</p> <p>! Do not continue driving. The engine could otherwise overheat.</p> <ul style="list-style-type: none"> ► Consult a qualified specialist workshop. <p>If the poly-V-belt is not damaged:</p> <ul style="list-style-type: none"> ► Visit a qualified specialist workshop.
 <p>Check Engine Oil At Next Refueling</p>	<p>The engine oil level has dropped to the minimum level. A warning tone also sounds.</p> <ul style="list-style-type: none"> ► Check the oil level when next refueling, at the latest (▷ page 497). ► If necessary, add engine oil (▷ page 498). ► Have the engine checked at a qualified specialist workshop if engine oil needs to be added more often than usual. <p>! Avoid long journeys with too little engine oil. The engine will otherwise be damaged.</p> <p>Information on approved engine oils can be obtained from any qualified specialist workshop or on the Internet at http://www.mbusa.com (USA only).</p>
 <p>Fuel Level Low</p>	<p>The fuel level has dropped into the reserve range.</p> <ul style="list-style-type: none"> ► Refuel at the nearest gas station.

Display messages	Possible causes/consequences and ► Solutions
	<p>There is only a very small amount of fuel in the fuel tank.</p> <ul style="list-style-type: none"> ► Refuel at the nearest gas station without fail.
 Gas Cap Loose	<p>The fuel system pressure is too low. The fuel filler cap is not closed correctly or the fuel system is leaking.</p> <ul style="list-style-type: none"> ► Check that the fuel filler cap is correctly closed. <p>If the fuel filler cap is not correctly closed:</p> <ul style="list-style-type: none"> ► Close the fuel filler cap. <p>If the fuel filler cap is correctly closed:</p> <ul style="list-style-type: none"> ► Visit a qualified specialist workshop.

Driving systems

Display messages	Possible causes/consequences and ► Solutions
ABC Malfunction	<p>The ABC function (Active Body Control) is restricted.</p> <p> WARNING</p> <p>The vehicle's suspension tuning characteristics may be affected. There is a risk of an accident.</p> <ul style="list-style-type: none"> ► Do not drive at speeds above 50 mph (80 km/h). ► Visit a qualified specialist workshop.
ABC Malfunction Stop Vehicle	<p>The vehicle level of the ABC is too low.</p> <ul style="list-style-type: none"> ► Pull over and stop the vehicle safely as soon as possible, paying attention to road and traffic conditions. After a few seconds, the vehicle level is adjusted and the display message disappears. <p>The vehicle is leaking oil. The display message is shown continuously.</p> <p> WARNING</p> <p>The vehicle's suspension tuning characteristics may be affected. There is a risk of an accident.</p> <ul style="list-style-type: none"> ► Pull over and stop the vehicle safely as soon as possible, paying attention to road and traffic conditions. Do not continue driving under any circumstances. ► Secure the vehicle against rolling away (▷ page 154). ► Notify a qualified specialist workshop or breakdown service.

Display messages	Possible causes/consequences and ► Solutions
	<p>ABC is malfunctioning. The display message is shown continuously.</p> <p> WARNING</p> <p>The suspension tuning characteristics are thus affected. There is a risk of an accident.</p> <ul style="list-style-type: none"> ► Do not drive faster than 50 mph (80 km/h). ► Make only slight steering movements. Otherwise, the front fender or the tires could be damaged if the steering movement is too large. ► Listen for scraping sounds. ► Visit a qualified specialist workshop.
<p></p> <p>Attention Assist: Take a Break!</p>	<p>Based on certain criteria, ATTENTION ASSIST has detected fatigue or a lack of concentration on the part of the driver. A warning tone also sounds.</p> <ul style="list-style-type: none"> ► If necessary, take a break. <p>During long journeys, take regular breaks in good time so you get enough rest.</p>
<p></p> <p>Attention Assist Inoperative</p>	<p>ATTENTION ASSIST is inoperative.</p> <ul style="list-style-type: none"> ► Visit a qualified specialist workshop.
<p>HOLD</p> <p>Off</p>	<p>The HOLD function is deactivated. The vehicle is skidding. A warning tone also sounds.</p> <ul style="list-style-type: none"> ► Reactivate the HOLD function later (► page 175).
<p>Radar Sensors Deactivated See Operator's Manual</p>	<p>The radar sensor system is deactivated.</p> <ul style="list-style-type: none"> ► Switch on the radar sensor system (► page 218).



Display messages	Possible causes/consequences and ► Solutions
<p>Act. Lane Keep. Assist Currently Unavailable See Operator's Manual</p>	<p>Active Lane Keeping Assist is deactivated and temporarily inoperative. Possible causes are:</p> <ul style="list-style-type: none"> • the windshield in the camera's field of vision is dirty. • visibility is impaired due to heavy rain, snow or fog. • there are no lane markings for a longer period. • the lane markings are worn, dark or covered, e.g. by dirt or snow. <p>If the display message does not disappear:</p> <ul style="list-style-type: none"> ► Pull over and stop the vehicle safely as soon as possible, paying attention to road and traffic conditions. ► Secure the vehicle against rolling away (▷ page 154). ► Clean the windshield. <p>If the system detects that the camera is fully operational, the display message disappears.</p> <p>Lane Keeping Assist or Active Lane Keeping Assist is operational again.</p>
<p>Act. Lane Keep. Assist Inoperative</p>	<p>Active Lane Keeping Assist is defective.</p> <ul style="list-style-type: none"> ► Visit a qualified specialist workshop.
<p>Active Blind Spot Assist Currently Unavailable See Operator's Manual</p>	<p>Active Blind Spot Assist is temporarily inoperative. Possible causes are:</p> <ul style="list-style-type: none"> • the sensors are dirty. • function is impaired due to heavy rain or snow. • the radar sensor system is outside the operating temperature range. • the radar sensor system is temporarily inoperative, e.g. due to electromagnetic radiation emitted by nearby TV or radio stations or other sources of electromagnetic radiation. <p>The yellow  indicator lamps also light up in the exterior mirrors.</p> <p>If the display message does not disappear:</p> <ul style="list-style-type: none"> ► Pull over and stop the vehicle safely as soon as possible, paying attention to road and traffic conditions. ► Secure the vehicle against rolling away (▷ page 154). ► Clean the sensors (▷ page 504). ► Restart the engine. <p>If the system detects that the sensors are fully operational, the display message disappears.</p> <p>Active Blind Spot Assist is operational again.</p>

Display messages	Possible causes/consequences and ► Solutions
Active Blind Spot Assist Inoperative	<p>Active Blind Spot Assist is defective.</p> <p>The yellow  indicator lamps also light up in the exterior mirrors.</p> <p>► Visit a qualified specialist workshop.</p>
Park Assist Canceled	<p>The driver's door is open and the driver's seat belt has not been fastened.</p> <p>► Repeat the parking process with the seat belt fastened and the driver's door closed.</p> <p>You have inadvertently touched the multifunction steering wheel while steering intervention was active.</p> <p>► While steering intervention is active, make sure that the multifunction steering wheel is not touched unintentionally.</p> <p>The vehicle has started to skid and ESP[®] has intervened.</p> <p>► Use Active Parking Assist again later (► page 186).</p>
Park Assist Inoperative	<p>You have just carried out a large number of turning or parking maneuvers.</p> <p>Active Parking Assist will become available again after approximately ten minutes (► page 186).</p> <p>► Pull over and stop the vehicle safely as soon as possible, paying attention to road and traffic conditions.</p> <p>► Switch off and restart the engine.</p> <p>If the display message continues to be displayed:</p> <p>► Visit a qualified specialist workshop.</p> <p>PARKTRONIC is defective.</p> <p>► Visit a qualified specialist workshop.</p>
Park Assist Finished	<p>The vehicle is parked. A warning tone also sounds.</p> <p>The display message disappears automatically.</p>
DISTRONIC PLUS Off	<p>DISTRONIC PLUS has been deactivated (► page 164).</p> <p>If it was deactivated automatically, a warning tone also sounds.</p>
DISTRONIC PLUS Now Available	<p>DISTRONIC PLUS is operational again after having been temporarily unavailable. You can now reactivate DISTRONIC PLUS (► page 164).</p>



Display messages	Possible causes/consequences and ► Solutions
<p>DISTRONIC PLUS Currently Unavailable See Operator's Manual</p>	<p>DISTRONIC is deactivated and temporarily inoperative. Possible causes are:</p> <ul style="list-style-type: none"> • the DISTRONIC PLUS cover in the radiator trim is dirty • function is impaired due to heavy rain or snow. • the sensors in the bumpers are dirty. • the radar sensor system is temporarily inoperative, e.g. due to electromagnetic radiation emitted by nearby TV or radio stations or other sources of electromagnetic radiation. • the system is outside the operating temperature range. • the on-board voltage is too low. <p>A warning tone also sounds.</p> <p>If the display message does not disappear:</p> <ul style="list-style-type: none"> ► Pull over and stop the vehicle safely as soon as possible, paying attention to road and traffic conditions. ► Secure the vehicle against rolling away (▷ page 154). ► Clean the DISTRONIC PLUS cover in the radiator trim and the bumper (▷ page 504). ► Restart the engine. <p>If the system detects that the sensors are fully operational, the display message disappears.</p> <p>DISTRONIC is operational again.</p>
<p>DISTRONIC PLUS Inoperative</p>	<p>DISTRONIC PLUS is defective.</p> <p>BAS PLUS (Brake Assist PLUS) and PRE-SAFE® Brake may be inoperative as well.</p> <p>A warning tone also sounds.</p> <ul style="list-style-type: none"> ► Visit a qualified specialist workshop.
<p>DISTRONIC PLUS Passive</p>	<p>You have depressed the accelerator pedal. DISTRONIC PLUS is no longer controlling the speed of the vehicle.</p> <ul style="list-style-type: none"> ► Remove your foot from the accelerator pedal.
<p>DISTRONIC PLUS --- mph</p>	<p>An activation condition for DISTRONIC PLUS is not fulfilled.</p> <ul style="list-style-type: none"> ► Check the activation conditions for DISTRONIC PLUS (▷ page 164).

Display messages	Possible causes/consequences and ► Solutions
Cruise Control Inoperative	<p>Cruise control is defective. A warning tone also sounds.</p> <ul style="list-style-type: none">► Visit a qualified specialist workshop.
Cruise Control --- mph	<p>A condition for activating cruise control has not been fulfilled. You have tried to store a speed below 20 mph (30 km/h), for example.</p> <ul style="list-style-type: none">► If conditions permit, drive faster than 20 mph (30 km/h) and store the speed.► Check the activation conditions for cruise control (► page 162).

Tires	
Display messages	Possible causes/consequences and ► Solutions
Check Tire Pressure	<p>The tire pressure loss warning system has detected a significant loss in pressure. A warning tone also sounds.</p> <p> WARNING</p> <p>With tire pressures which are too low, there is a risk of the following hazards:</p> <ul style="list-style-type: none"> • they may burst, especially as the load and vehicle speed increase. • they may wear excessively and/or unevenly, which may greatly impair tire traction. • the driving characteristics, as well as steering and braking, may be greatly impaired. <p>There is a risk of an accident.</p> <ul style="list-style-type: none"> ► Stop the vehicle without making any sudden steering or braking maneuvers. Pay attention to the traffic conditions as you do so. ► Secure the vehicle against rolling away (▷ page 154). ► If there is a flat tire, inspect the tires (▷ page 509). ► Check the tire pressures and, if necessary, correct the tire pressure. ► Restart the tire pressure loss warning system when the tire pressure is correct (▷ page 533).
Check Tire Pressure Then Restart Run Flat Indicator	<p>The tire pressure loss warning system generated a display message and has not been restarted since.</p> <ul style="list-style-type: none"> ► Set the correct tire pressure in all four tires. ► Restart the tire pressure loss warning system (▷ page 533).
Run Flat Indicator Inoperative	<p>The tire pressure loss warning system is faulty.</p> <ul style="list-style-type: none"> ► Visit a qualified specialist workshop.
Tire pressure will be displayed after driving a few minutes	<p>The tire pressure monitor is measuring the tire pressure.</p> <ul style="list-style-type: none"> ► Drive on. The tire pressures appear in the multifunction display after you have been driving for a few minutes.
Tire Press. Monitor Inoperative	<p>The tire pressure monitor is faulty.</p> <ul style="list-style-type: none"> ► Visit a qualified specialist workshop.





Display messages	Possible causes/consequences and ► Solutions
Tire Pressure Monitor Inoperative No Wheel Sensors	<p>The wheels mounted do not have a suitable tire pressure sensor. The tire pressure monitor is deactivated.</p> <ul style="list-style-type: none"> ► Mount wheels with suitable tire pressure sensors. The tire pressure monitor is activated automatically after driving for a few minutes.
Check Tire Press.	<p>The tire pressure in one or more tires has dropped significantly. The wheel position is displayed in the multifunction display. A warning tone also sounds.</p> <p> WARNING</p> <p>With tire pressures which are too low, there is a risk of the following hazards:</p> <ul style="list-style-type: none"> • they may burst, especially as the load and vehicle speed increase. • they may wear excessively and/or unevenly, which may greatly impair tire traction. • the driving characteristics, as well as steering and braking, may be greatly impaired. <p>There is a risk of an accident.</p> <ul style="list-style-type: none"> ► Stop the vehicle without making any sudden steering or braking maneuvers. Pay attention to the traffic conditions as you do so. ► Secure the vehicle against rolling away (▷ page 154). ► If there is a flat tire, inspect the tires (▷ page 509). ► Check the tire pressure (▷ page 534). ► If necessary, correct the tire pressure.
Warning Tire Malfunction	<p>The tire pressure in one or more tires has dropped suddenly. The wheel position is shown in the multifunction display.</p> <p> WARNING</p> <p>If you drive with a flat tire, there is a risk of the following hazards:</p> <ul style="list-style-type: none"> • A flat tire affects the ability to steer or brake the vehicle. • You could lose control of the vehicle. • Continued driving with a flat tire will cause excessive heat build-up and possibly a fire. <p>There is a risk of an accident.</p> <ul style="list-style-type: none"> ► Stop the vehicle without making any sudden steering or braking maneuvers. Pay attention to the traffic conditions as you do so. ► Secure the vehicle against rolling away (▷ page 154). ► If there is a flat tire, inspect the tires (▷ page 509).







Display messages	Possible causes/consequences and ► Solutions
<p>Correct Tire Pressure</p>	<p>The tire pressure is too low in at least one of the tires, or the tire pressure difference between the wheels is too great.</p> <ul style="list-style-type: none"> ► Check the tire pressures at the next opportunity (▷ page 534). ► If necessary, correct the tire pressure. ► Restart the tire pressure monitor (▷ page 536).
<p>TirePress. Sensor(s) Missing</p>	<p>There is no signal from the tire pressure sensor of one or several wheels. The pressure of the affected tire is not displayed in the multifunction display.</p> <ul style="list-style-type: none"> ► Have the faulty tire pressure sensor replaced at a qualified specialist workshop.
<p>Tire Press. Monitor Currently Unavailable</p>	<p>Due to a source of radio interference, no signals can be received from the wheel sensors. The tire pressure monitor is temporarily malfunctioning.</p> <ul style="list-style-type: none"> ► Drive on. The tire pressure monitor restarts automatically as soon as the problem has been solved.
<div data-bbox="116 754 197 798" style="border: 1px solid black; padding: 2px; display: inline-block;">  </div> <p>Tire Press. Warning Tire Malfunction</p>	<p>The tire pressure in one or more tires has dropped suddenly. A warning tone also sounds.</p> <p>⚠ WARNING</p> <p>If you drive with a flat tire, there is a risk of the following hazards:</p> <ul style="list-style-type: none"> • A flat tire affects the ability to steer or brake the vehicle. • You could lose control of the vehicle. • Continued driving with a flat tire will cause excessive heat build-up and possibly a fire. There is a risk of an accident. <ul style="list-style-type: none"> ► Stop the vehicle without making any sudden steering or braking maneuvers. Pay attention to the traffic conditions as you do so. ► Secure the vehicle against rolling away (▷ page 154). ► If there is a flat tire, inspect the tires (▷ page 509).

Display messages	Possible causes/consequences and ► Solutions
 <p>Tire Press. Check Tire Pressure</p>	<p>The tire pressure in one or more tires has dropped significantly.</p> <p> WARNING</p> <p>With tire pressures which are too low, there is a risk of the following hazards:</p> <ul style="list-style-type: none"> • they may burst, especially as the load and vehicle speed increase. • they may wear excessively and/or unevenly, which may greatly impair tire traction. • the driving characteristics, as well as steering and braking, may be greatly impaired. <p>There is a risk of an accident.</p> <ul style="list-style-type: none"> ► Stop the vehicle without making any sudden steering or braking maneuvers. Pay attention to the traffic conditions as you do so. ► Secure the vehicle against rolling away (▷ page 154). ► If there is a flat tire, inspect the tires (▷ page 509). ► Check the tire pressure (▷ page 534). ► If necessary, correct the tire pressure.
 <p>Correct Tire Pressure</p>	<p>The tire pressure is too low in at least one of the tires, or the tire pressure difference between the wheels is too great.</p> <ul style="list-style-type: none"> ► Check the tire pressures at the next opportunity (▷ page 534). ► If necessary, correct the tire pressure.





Vehicle





Display messages	Possible causes/consequences and ► Solutions
Shift to 'P' or 'N' to Start Engine	<p>You have attempted to start the engine with the transmission in position R or D.</p> <ul style="list-style-type: none"> ► Shift the transmission to position P or N.
Auxiliary Battery Malfunction	<p>The auxiliary battery for the automatic transmission is no longer being charged.</p> <ul style="list-style-type: none"> ► Visit a qualified specialist workshop at the next opportunity. ► Until then, set the automatic transmission to position P before you switch off the engine. ► Before leaving the vehicle, apply the electric parking brake. ► Secure the vehicle against rolling away (▷ page 154).

Display messages	Possible causes/consequences and ► Solutions
Apply Brake to Shift from 'P'	<p>You have attempted to move the transmission selector lever to position D, R or N without depressing the brake pedal.</p> <ul style="list-style-type: none"> ► Depress the brake pedal.
Vehicle Not in 'P'	<p>The driver's door is open and the transmission is in position R, N or D.</p> <p>A warning tone also sounds.</p> <ul style="list-style-type: none"> ► Shift the transmission to position P. ► Secure the vehicle against rolling away (▷ page 154).
Service Required Do Not Shift Gears	<p>You cannot change the transmission position due to a malfunction. A warning tone also sounds.</p> <p>If transmission position D is selected:</p> <ul style="list-style-type: none"> ► Drive to a qualified specialist workshop without shifting the transmission from position D. <p>If transmission position R, N or P is selected:</p> <ul style="list-style-type: none"> ► Notify a qualified specialist workshop or breakdown service.
Only Shift to 'P' when Vehicle is Stationary	<p>The vehicle is moving.</p> <ul style="list-style-type: none"> ► Pull over and stop the vehicle safely as soon as possible, paying attention to road and traffic conditions. ► Shift the transmission to position P.
	<p>The trunk lid is open.</p> <ul style="list-style-type: none"> ► Close the trunk lid.
	<p>The hood is open.</p> <p> WARNING</p> <p>The open hood may block your view when the vehicle is in motion. There is a risk of an accident.</p> <ul style="list-style-type: none"> ► Pull over and stop the vehicle safely as soon as possible, paying attention to road and traffic conditions. ► Secure the vehicle against rolling away (▷ page 154). ► Close the hood.
	<p>At least one door is open. A warning tone also sounds.</p> <ul style="list-style-type: none"> ► Close all the doors.

Display messages	Possible causes/consequences and ► Solutions
 <p>Trunk Partition Open</p>	<p>The trunk partition is open.</p> <ul style="list-style-type: none"> ► Close the trunk partition (▷ page 89).
 <p>Power Steering Malfunction See Operator's Manual</p>	<p>The power steering is malfunctioning. A warning tone also sounds.</p> <p>⚠ WARNING</p> <p>You will need to use more force to steer. There is a risk of an accident.</p> <ul style="list-style-type: none"> ► Check whether you are able to apply the extra force required. ► If you are able to steer safely: carefully drive on to a qualified specialist workshop. ► If you are unable to steer safely: do not drive on. Contact the nearest qualified specialist workshop.
 <p>Close Center Compartment</p>	<p>The stowage space under the armrest is open. The interior motion sensor is not armed.</p> <ul style="list-style-type: none"> ► Close the stowage space under the armrest (▷ page 475).
<p>Phone No Service</p>	<p>Your vehicle is outside the network provider's transmitter/receiver range.</p> <ul style="list-style-type: none"> ► Wait until the mobile phone operational readiness symbol appears in the multifunction display.
 <p>Decrease Speed</p>	<p>You wanted to open the roof while the vehicle was in motion.</p> <ul style="list-style-type: none"> ► Pull over and stop the vehicle safely as soon as possible, paying attention to road and traffic conditions. ► Open the roof (▷ page 87).
 <p>Vario-Roof Lowering</p>	<p>The roof is not fully opened or closed. The hydraulics are depressurized.</p> <ul style="list-style-type: none"> ► Fully open or close the roof (▷ page 87).
 <p>Open/Close Vario-Roof Completely</p>	<p>The roof is not locked.</p> <ul style="list-style-type: none"> ► Pull over and stop the vehicle safely as soon as possible, paying attention to road and traffic conditions. ► Push or pull the roof switch until the roof is fully open or closed (▷ page 87).
	<p>The on-board voltage is too low.</p> <ul style="list-style-type: none"> ► Start the engine.





















Display messages	Possible causes/consequences and ► Solutions
Start Engine See Operator's Manual	<p>The roof has been opened and closed several times in a row. The roof drive has been switched off automatically for safety reasons. You can open and close the roof again after approximately ten minutes.</p> <ul style="list-style-type: none"> ► Switch off the ignition and turn it back on. ► Repeat the opening or closing procedure (▷ page 87).
 <p>Check Washer Fluid</p>	<p>The washer fluid level in the washer fluid reservoir has dropped below the minimum.</p> <ul style="list-style-type: none"> ► Add washer fluid (▷ page 499).

SmartKey	
Display messages	Possible causes/consequences and ► Solutions
 <p>Key Does Not Belong to Vehicle</p>	<p>You have put the wrong SmartKey in the ignition lock.</p> <ul style="list-style-type: none"> ► Use the correct SmartKey.
 <p>Take Your Key from Ignition</p>	<p>The SmartKey is in the ignition lock.</p> <ul style="list-style-type: none"> ► Remove the SmartKey.
 <p>Obtain a New Key</p>	<p>The SmartKey needs to be replaced.</p> <ul style="list-style-type: none"> ► Visit a qualified specialist workshop.
 <p>Replace Key Battery</p>	<p>The batteries of the KEYLESS-GO key are discharged.</p> <ul style="list-style-type: none"> ► Change the batteries (▷ page 71).
 <p>Don't Forget Your Key</p>	<p>The display message is shown for a maximum of 60 seconds and is only a reminder.</p> <p>You have opened the driver's door with the engine switched off. The KEYLESS-GO key is not in the ignition lock.</p> <ul style="list-style-type: none"> ► Remember to take the KEYLESS-GO key with you when you leave the vehicle.

Display messages	Possible causes/consequences and ► Solutions
 <p>Key Not Detected (red display message)</p>	<p>The KEYLESS-GO key is not in the vehicle. A warning tone also sounds. If the engine is switched off, you can no longer lock the vehicle centrally or start the engine.</p> <ul style="list-style-type: none"> ► Pull over and stop the vehicle safely as soon as possible, paying attention to road and traffic conditions. ► Secure the vehicle against rolling away (▷ page 154). ► Locate the KEYLESS-GO key. <p>The KEYLESS-GO key is not detected while the engine is running because there is interference from a strong source of radio waves. A warning tone also sounds.</p> <ul style="list-style-type: none"> ► Pull over and stop the vehicle safely as soon as possible, paying attention to road and traffic conditions. ► Secure the vehicle against rolling away (▷ page 154). ► Operate the vehicle with the SmartKey in the ignition lock.
 <p>Key Not Detected (white display message)</p>	<p>The KEYLESS-GO key cannot be detected at present.</p> <ul style="list-style-type: none"> ► Change the location of the key with the KEYLESS-GO functions in the vehicle. <p>If the KEYLESS-GO key is still not detected:</p> <ul style="list-style-type: none"> ► Operate the vehicle with the SmartKey in the ignition lock.
 <p>Key Detected in Vehicle</p>	<p>The KEYLESS-GO key has been detected inside the vehicle during locking.</p> <ul style="list-style-type: none"> ► Remove the KEYLESS-GO key from the vehicle.
 <p>Remove 'Start' Button and Insert Key</p>	<p>The KEYLESS-GO key can continuously not be detected. KEYLESS-GO is temporarily malfunctioning or is defective. A warning tone also sounds.</p> <ul style="list-style-type: none"> ► Insert the SmartKey into the ignition lock and turn it to the desired position. ► Visit a qualified specialist workshop.
 <p>Close Doors to Lock Vehicle</p>	<p>At least one door is open. A warning tone also sounds.</p> <ul style="list-style-type: none"> ► Close all doors and lock the vehicle again.



Warning and indicator lamps

Warning and indicator lamps overview





	Low-beam headlamps (▷ page 109)
	Turn signals (▷ page 112)
	High-beam headlamps (▷ page 112)
	Front fog lamps (▷ page 111)
	Seat belts (▷ page 256)
	Brakes (▷ page 257)
	Brakes (▷ page 257)
	ABS (▷ page 257)
	ESP® (▷ page 259)
	ESP® OFF (▷ page 259)
	SPORT handling mode in AMG vehicles (▷ page 260)
	Electric parking brake (red) (▷ page 257)
	Electric parking brake (red) (▷ page 257)
	Electric parking brake (yellow) (▷ page 257)
	SRS (▷ page 262)
	Check Engine (▷ page 263)
	Reserve fuel (▷ page 263)
	Coolant (▷ page 263)
	Distance warning signal (▷ page 265)
	Tire pressure monitor (▷ page 266)



Safety







Seat belts





Problem	Possible causes/consequences and ► Solutions
 <p>The red seat belt warning lamp lights up after the engine starts, as soon as the driver's or the front-passenger door is closed.</p>	<p>The driver or front passenger has not fastened their seat belt.</p> <ul style="list-style-type: none"> ► Fasten your seat belt (▷ page 51). The warning lamp goes out. <p>There are objects on the front-passenger seat.</p> <ul style="list-style-type: none"> ► Remove the objects from the front-passenger seat and stow them in a secure place. The warning lamp goes out.
 <p>The red seat belt warning lamp flashes and an intermittent audible warning sounds.</p>	<p>The driver or front passenger has not fastened their seat belt. You are driving faster than 15 mph (25 km/h) or have briefly driven faster than 15 mph (25 km/h).</p> <ul style="list-style-type: none"> ► Fasten your seat belt (▷ page 51). The warning lamp goes out and the intermittent warning tone ceases. <p>There are objects on the front-passenger seat. You are driving faster than 15 mph (25 km/h) or have briefly driven faster than 15 mph (25 km/h).</p> <ul style="list-style-type: none"> ► Remove the objects from the front-passenger seat and stow them in a secure place. The warning lamp goes out and the intermittent warning tone ceases.



Safety systems





Problem	Possible causes/consequences and ► Solutions
<p> (USA only)</p> <p> (Canada only)</p> <p>The red brake system warning lamp comes on while the engine is running. A warning tone also sounds.</p>	<p>There is not enough brake fluid in the brake fluid reservoir.</p> <p> WARNING</p> <p>The braking effect may be impaired. There is a risk of an accident.</p> <ul style="list-style-type: none"> ► Pull over and stop the vehicle safely as soon as possible, paying attention to road and traffic conditions. Do not continue driving under any circumstances. ► Secure the vehicle against rolling away (► page 154). ► Do not add brake fluid. Topping up will not remedy the malfunction. ► Consult a qualified specialist workshop. ► Observe the additional display messages in the multifunction display.
<p></p> <p>The yellow ABS warning lamp is lit while the engine is running.</p>	<p>ABS (Anti-lock Brake System) is deactivated due to a malfunction. BAS (Brake Assist), BAS PLUS, ESP® (Electronic Stability Program), PRE-SAFE®, PRE-SAFE® Brake, the HOLD function and hill start assist are therefore also deactivated, for example. ATTENTION ASSIST is deactivated.</p> <p> WARNING</p> <p>The brake system continues to function normally, but without the functions listed above. The wheels could therefore lock if you brake hard, for example.</p> <p>The steerability and braking characteristics may be severely affected. The braking distance in an emergency braking situation can increase.</p> <p>If ESP® is not operational, ESP® is unable to stabilize the vehicle. There is an increased risk of skidding and an accident.</p> <ul style="list-style-type: none"> ► Observe the additional display messages in the multifunction display. ► Drive on carefully. ► Visit a qualified specialist workshop. <p>If the ABS control unit is faulty, there is also a possibility that other systems, such as the navigation system or the automatic transmission, will not be available.</p>





Problem	Possible causes/consequences and ► Solutions
 <p>The yellow ABS warning lamp is lit while the engine is running.</p>	<p>ABS is temporarily unavailable. BAS, BAS PLUS, ESP[®], EBD (electronic brake force distribution), PRE-SAFE[®], PRE-SAFE[®] Brake, the HOLD function, hill start assist are therefore also deactivated, for example.</p> <p>Possible causes are:</p> <ul style="list-style-type: none"> • Self-diagnosis is not yet complete. • The on-board voltage may be insufficient. <p>ATTENTION ASSIST is deactivated.</p> <p> WARNING</p> <p>The brake system continues to function normally, but without the functions listed above. The front and rear wheels could therefore lock if you brake hard, for example.</p> <p>The steerability and braking characteristics may be severely affected. The braking distance in an emergency braking situation can increase.</p> <p>If ESP[®] is not operational, ESP[®] is unable to stabilize the vehicle. There is a risk of an accident.</p> <p>► Carefully drive a suitable distance making slight steering movements at a speed above 12 mph (20 km/h). The functions mentioned above are available again when the warning lamp goes out.</p> <p>If the warning lamp is still on:</p> <ul style="list-style-type: none"> ► Observe the additional display messages in the multifunction display. ► Drive on carefully. ► Visit a qualified specialist workshop.



Problem	Possible causes/consequences and ► Solutions
 <p>The yellow ABS warning lamp is lit while the engine is running. A warning tone also sounds.</p>	<p>EBD is not available due to a malfunction. Therefore, ABS, BAS, BAS PLUS, ESP[®], PRE-SAFE[®], PRE-SAFE[®] Brake, the HOLD function and hill start assist are also unavailable, for example. ATTENTION ASSIST is deactivated.</p> <p> WARNING</p> <p>The brake system continues to function normally, but without the functions listed above. The front and rear wheels could therefore lock if you brake hard, for example.</p> <p>The steerability and braking characteristics may be severely affected. The braking distance in an emergency braking situation can increase.</p> <p>If ESP[®] is not operational, ESP[®] is unable to stabilize the vehicle. There is an increased risk of skidding and an accident.</p> <ul style="list-style-type: none"> ► Observe the additional display messages in the multifunction display. ► Drive on carefully. ► Visit a qualified specialist workshop.
<p>BRAKE (USA only)</p> <p> (Canada only)</p> <p>  </p> <p>The red brake warning lamp, the yellow ESP[®] and ESP[®] OFF warning lamps and the yellow ABS warning lamp are lit while the engine is running.</p>	<p>ABS and ESP[®] are not available due to a malfunction. Therefore, BAS, BAS PLUS, EBD, PRE-SAFE[®], PRE-SAFE[®] Brake, the HOLD function and hill start assist, for example, are not available either. ATTENTION ASSIST is deactivated.</p> <p> WARNING</p> <p>The brake system continues to function normally, but without the functions listed above. The front and rear wheels could therefore lock if you brake hard, for example.</p> <p>The steerability and braking characteristics may be severely affected. The braking distance in an emergency braking situation can increase.</p> <p>If ESP[®] is not operational, ESP[®] is unable to stabilize the vehicle. There is an increased risk of skidding and an accident.</p> <ul style="list-style-type: none"> ► Observe the additional display messages in the multifunction display. ► Drive on carefully. ► Visit a qualified specialist workshop.

Problem	Possible causes/consequences and ► Solutions
 <p>The yellow ESP® warning lamp flashes while the vehicle is in motion.</p>	<p>ESP® or traction control has intervened because there is a risk of skidding or at least one wheel has started to spin. Cruise control or DISTRONIC PLUS is deactivated.</p> <ul style="list-style-type: none"> ► When pulling away, only depress the accelerator pedal as far as necessary. ► Ease off the accelerator pedal while the vehicle is in motion. ► Adapt your driving style to suit the road and weather conditions. ► Do not deactivate ESP®. <p>For exceptions, see: (► page 59).</p>
 <p>The yellow ESP® OFF warning lamp is lit while the engine is running.</p>	<p>ESP® is deactivated.</p> <p> WARNING</p> <p>If ESP® is switched off, ESP® is unable to stabilize the vehicle. There is an increased risk of skidding and an accident.</p> <ul style="list-style-type: none"> ► Reactivate ESP®. For exceptions, see: (► page 59). ► Adapt your driving style to suit the road and weather conditions. <p>If ESP® cannot be activated:</p> <ul style="list-style-type: none"> ► Drive on carefully. ► Have ESP® checked at a qualified specialist workshop.
 <p>AMG vehicles only: The yellow SPORT handling mode warning lamp is lit while the engine is running.</p>	<p>SPORT handling mode is activated.</p> <p> WARNING</p> <p>When SPORT handling mode is switched on, ESP® is unable to stabilize the vehicle. There is an increased risk of skidding and an accident.</p> <ul style="list-style-type: none"> ► Only switch to SPORT handling mode in accordance with the conditions described in the "Activating/deactivating SPORT handling mode" section (► page 61).

Problem	Possible causes/consequences and ► Solutions
 <p>The yellow ESP[®] and ESP[®] OFF warning lamps are lit while the engine is running.</p>	<p>ESP[®], BAS, BAS PLUS, PRE-SAFE[®], PRE-SAFE[®] Brake, the HOLD function and hill start assist are not available due to a malfunction. ATTENTION ASSIST is deactivated.</p> <p>⚠ WARNING</p> <p>The brake system continues to function normally, but without the functions listed above.</p> <p>The braking distance in an emergency braking situation can thus increase.</p> <p>If ESP[®] is not operational, ESP[®] is unable to stabilize the vehicle. There is an increased risk of skidding and an accident.</p> <ul style="list-style-type: none"> ► Observe the additional display messages in the multifunction display. ► Drive on carefully. ► Visit a qualified specialist workshop.
 <p>The yellow ESP[®] and ESP[®] OFF warning lamps are lit while the engine is running.</p>	<p>ESP[®], BAS, PRE-SAFE[®], the HOLD function and hill start assist are temporarily unavailable.</p> <p>BAS PLUS and PRE-SAFE[®] Brake may also have failed. ATTENTION ASSIST is deactivated. Self-diagnosis is not yet complete.</p> <p>⚠ WARNING</p> <p>The brake system continues to function normally, but without the functions listed above.</p> <p>The braking distance in an emergency braking situation can thus increase.</p> <p>If ESP[®] is not operational, ESP[®] is unable to stabilize the vehicle. There is an increased risk of skidding and an accident.</p> <ul style="list-style-type: none"> ► Carefully drive a suitable distance making slight steering movements at a speed above 12 mph (20 km/h). The functions mentioned above are available again when the warning lamp goes out. <p>If the warning lamp is still on:</p> <ul style="list-style-type: none"> ► Observe the additional display messages in the multifunction display. ► Drive on carefully. ► Visit a qualified specialist workshop.

Problem	Possible causes/consequences and ► Solutions
<p> (USA only)</p> <p> (Canada only)</p> <p>The red indicator lamp for the electric parking brake flashes and/or the yellow</p> <p></p> <p>The warning lamp for the electric parking brake lights up.</p>	<p>The electric parking brake is temporarily malfunctioning or defective.</p> <ul style="list-style-type: none"> ► Pull over and stop the vehicle safely as soon as possible, paying attention to road and traffic conditions. ► Secure the vehicle against rolling away (▷ page 154). ► Observe the additional display messages in the multifunction display.
<p></p> <p>The red SRS warning lamp is lit while the engine is running.</p>	<p>There is a malfunction in the SRS (Supplemental Restraint System).</p> <p> WARNING</p> <p>The air bags or Emergency Tensioning Devices may either be triggered unintentionally or, in the event of an accident, may not be triggered.</p> <p>There is an increased risk of injury.</p> <ul style="list-style-type: none"> ► Drive on carefully. ► Have SRS checked at a qualified specialist workshop immediately. <p>Further information on occupant safety (▷ page 37).</p>





Engine	
Problem	Possible causes/consequences and ► Solutions
 <p>The yellow Check Engine warning lamp lights up while the engine is running.</p>	<p>There may be a malfunction, for example:</p> <ul style="list-style-type: none"> • in the engine management • in the fuel injection system • in the exhaust system • in the ignition system • in the fuel system <p>The emission limit values may be exceeded and the engine may be running in emergency mode.</p> <p>► Have the vehicle checked as soon as possible at a qualified specialist workshop.</p> <p>1 In some states, you must immediately visit a qualified specialist workshop as soon as the yellow Check Engine warning lamp lights up. This is due to the legal requirements in effect in these states. If in doubt, check whether such legal regulations apply in the state in which you are currently driving.</p>
 <p>The yellow reserve fuel warning lamp lights up while the engine is running.</p>	<p>The fuel level has dropped into the reserve range.</p> <p>► Refuel at the nearest gas station.</p>
 <p>The yellow reserve fuel warning lamp flashes while the vehicle is in motion.</p> <p>In addition, the  Engine Check warning lamp may light up.</p>	<p>The fuel system pressure is too low. The fuel filler cap is not closed correctly or the fuel system is leaking.</p> <p>► Check that the fuel filler cap is correctly closed.</p> <p>► If the fuel filler cap is not correctly closed: close the fuel filler cap.</p> <p>► If the fuel filler cap is closed: visit a qualified specialist workshop.</p>
 <p>The red coolant warning lamp lights up while the engine is running and the coolant temperature gauge is at the start of the scale.</p>	<p>The temperature sensor for the coolant temperature gauge is defective.</p> <p>The coolant temperature is no longer being monitored. There is a risk of engine damage if the coolant temperature is too high.</p> <p>► Pull over and stop the vehicle safely and switch off the engine, paying attention to road and traffic conditions. Do not continue driving under any circumstances.</p> <p>► Secure the vehicle against rolling away (► page 154).</p> <p>► Consult a qualified specialist workshop.</p>

Problem	Possible causes/consequences and ► Solutions
 <p>The red coolant warning lamp comes on while the engine is running.</p>	<p>The coolant level is too low.</p> <p>If the coolant level is correct, the airflow to the engine radiator may be blocked or the electric engine radiator fan may be malfunctioning.</p> <p>The coolant is too hot and the engine is no longer being cooled sufficiently.</p> <ul style="list-style-type: none"> ► Observe the additional display messages in the multifunction display. ► Pull over and stop the vehicle safely and switch off the engine, paying attention to road and traffic conditions. ► Secure the vehicle against rolling away (► page 154). ► Leave the vehicle and keep a safe distance from the vehicle until the engine has cooled down. ► Check the coolant level and add coolant, observing the warning notes (► page 498). ► If you need to add coolant more often than usual, have the engine coolant system checked. ► Make sure that the air supply to the engine radiator is not blocked, e.g. by snow, slush or ice. ► Do not start the engine again until the coolant temperature is under 248 °F (120 °C). Otherwise, the engine could be damaged. ► Drive to the nearest qualified specialist workshop. ► Avoid subjecting the engine to heavy loads, e.g. driving in mountainous terrain, and stop-and-go traffic.
 <p>The red coolant warning lamp comes on while the engine is running. A warning tone also sounds.</p>	<p>The coolant temperature has exceeded 248 °F (120 °C). The airflow to the engine radiator may be blocked or the coolant level may be too low.</p> <p> WARNING</p> <p>The engine is not being cooled sufficiently and may be damaged. Do not drive when your engine is overheated. This can cause some fluids which may have leaked into the engine compartment to catch fire.</p> <p>Steam from the overheated engine can also cause serious burns which can occur just by opening the hood.</p> <p>There is a risk of injury.</p> <ul style="list-style-type: none"> ► Observe the additional display messages in the multifunction display. ► Pull over and stop the vehicle safely and switch off the engine, paying attention to road and traffic conditions. ► Secure the vehicle against rolling away (► page 154).

Problem	Possible causes/consequences and ► Solutions
	<ul style="list-style-type: none"> ▶ Leave the vehicle and keep a safe distance from the vehicle until the engine has cooled down. ▶ Check the coolant level and add coolant, observing the warning notes (▷ page 498). ▶ If you need to add coolant more often than usual, have the engine coolant system checked. ▶ Make sure that the air supply to the engine radiator is not blocked, e.g. by snow, slush or ice. ▶ At coolant temperatures under 248 °F (120 °C), drive to the next qualified specialist workshop. ▶ Avoid subjecting the engine to heavy loads, e.g. driving in mountainous terrain, and stop-and-go traffic.

Driving systems

Problem	Possible causes/consequences and ► Solutions
 <p>The red distance warning lamp lights up while the vehicle is in motion. A warning tone also sounds.</p>	<p>You are approaching a vehicle or a stationary obstacle in your line of travel at too high a speed.</p> <ul style="list-style-type: none"> ▶ Be prepared to brake immediately. ▶ Pay careful attention to the traffic situation. You may have to brake or take evasive action. <p>Further information on DISTRONIC PLUS (▷ page 166). Further information on PRE-SAFE® Brake (▷ page 63).</p>

Tires	
Problem	Possible causes/consequences and ► Solutions
 <p>USA only: The yellow tire pressure monitor warning lamp (pressure loss/malfunction) is lit.</p> <p>Canada only: The yellow tire pressure monitor warning lamp (pressure loss) is lit.</p>	<p>The tire pressure monitor has detected a loss of pressure in at least one of the tires.</p> <p> WARNING</p> <p>With tire pressures which are too low, there is a risk of the following hazards:</p> <ul style="list-style-type: none"> • they may burst, especially as the load and vehicle speed increase. • they may wear excessively and/or unevenly, which may greatly impair tire traction. • the driving characteristics, as well as steering and braking, may be greatly impaired. <p>There is a risk of an accident.</p> <ul style="list-style-type: none"> ► Stop the vehicle without making any sudden steering or braking maneuvers. Pay attention to the traffic conditions as you do so. ► Secure the vehicle against rolling away (▷ page 154). ► Observe the additional display messages in the multifunction display. ► If there is a flat tire, inspect the tires (▷ page 509). ► Check the tire pressure (▷ page 534). ► If necessary, correct the tire pressure.
 <p>USA only: The yellow tire pressure monitor warning lamp (pressure loss/malfunction) flashes for approximately one minute and then remains lit.</p>	<p>The tire pressure monitor is faulty.</p> <p> WARNING</p> <p>The system is possibly unable to recognize or register low tire pressure.</p> <p>There is a risk of an accident.</p> <ul style="list-style-type: none"> ► Observe the additional display messages in the multifunction display. ► Visit a qualified specialist workshop.

Useful information	268
Operating safety	268
At a glance	271
System settings	289
Navigation	295
Telephone	357
Online and Internet functions	385
Audio	411
Video	452
SIRIUS Weather	461

Useful information

- i** These operating instructions describe all the standard and optional equipment of your COMAND system, as available at the time of going to print. Country-specific differences are possible. Please note that your COMAND system may not be equipped with all the features described. This also applies to safety-related systems and functions.
- i** Read the information on qualified specialist workshops: (> page 31).

Operating safety

Important safety notes

WARNING

Making alterations to electronic components can cause malfunctions.

Radio, satellite radio, amplifier, DVD changer, navigation module, phone and voice control are networked. If one component is not functional or if it has been incorrectly removed/replaced, this could impair the operation of other components.

This could seriously jeopardize the operational safety of your vehicle.

We recommend that you always have maintenance work on electronic components carried out at an authorized Mercedes-Benz Center.

WARNING

In order to avoid distraction which could lead to an accident, the driver should only enter system settings with the vehicle at a standstill and operate the system only when road, weather and traffic conditions permit.

Bear in mind that at a speed of only 30 mph (approximately 50 km/h), the vehicle covers a distance of 44 feet (approximately 14 m) per second.

COMAND delivers information to simplify your choice of route and guide you comfortably and safely to your destination. For safety reasons, we recommend that you bring your vehicle to a standstill, paying attention to road and traffic conditions, before making or accepting a telephone call or viewing navigation maps, instructions or downloaded information on the COMAND screen.

WARNING

While the navigation system provides directional assistance, the driver must remain focused on safe driving behavior, especially attention to traffic and street signs, and should utilize the system's audio cues while driving.

The navigation system does not supply any information on stop signs, yield signs, traffic regulations or traffic safety rules. Their observance always remains in the driver's personal responsibility. DVD maps do not cover all areas nor all routes within an area.

WARNING

This equipment complies with FCC radiation exposure limits set forth for uncontrolled equipment and meets the FCC radio frequency (RF) Exposure Guidelines in Supplement C to OET65.

This equipment has very low levels of RF energy that is deemed to comply without maximum permissive exposure evaluation (MPE). But it is desirable that it should be installed and operated with at least 8 inches (20 cm) and more between the radiator and a person's body (excluding extremities: hands, wrists, feet and legs.)

Declarations of conformity

Vehicle components which receive and/or transmit radio waves

i USA only: The wireless devices of this vehicle comply with Part 15 of the FCC Rules. Operation is subject to the following two conditions:

1. These devices may not cause harmful interference, and
2. These devices must accept any interference received, including interference that may cause undesired operation.

Changes or modifications not expressly approved by the party responsible for compliance could void the user's authority to operate the equipment.

i Canada only: The wireless devices of this vehicle comply with RSS-210 of Industry Canada. Operation is subject to the following two conditions:

1. These devices may not cause harmful interference, and
2. These devices must accept any interference received, including interference that may cause undesired operation.

Correct use

Observe the following information when using COMAND:

- the safety notes in this manual
 - traffic rules and regulations
 - laws and safety standards pertaining to motor vehicles
- i** Work improperly carried out on electronic components or systems (e.g. radio, DVD changer) and associated software could cause them to cease functioning. Even systems that have not been modified could be affected because the electronic systems are connected. Electronic

malfunctions can seriously jeopardize the operational safety of your vehicle.

i Roof antenna functionality (telephone, satellite radio, GPS) can be affected by the use of roof carrier systems.

Attaching metalized retrofit film to the windshield may affect radio reception and have a negative impact on all other antennas (e.g. emergency antenna) in the vehicle interior.

i Therefore, have all work on or modifications to electronic components carried out at a qualified specialist workshop. This workshop should have the necessary specialist knowledge and tools to carry out the work required. Mercedes-Benz recommends that you use an authorized Mercedes-Benz Center for this purpose. In particular, work relevant to safety or on safety-related systems must be carried out at a qualified specialist workshop.

i Protection against theft: this device is equipped with technical provisions to protect it against theft. Further information on protection against theft can be obtained from an authorized Mercedes-Benz Center.

Information on copyright

General information

You can find information on licenses for free and open-source software used in COMAND and its components here as soon as the website goes live: <http://www.mercedes-benz.com/opensource>.

Registered trademarks

Registered trademarks:

- Bluetooth® is a registered trademark of Bluetooth SIG Inc.
- DTS is a registered trademark of DTS, Inc.

- Dolby and MLP are registered trademarks of DOLBY Laboratories.
- BabySmart™, ESP® and PRE-SAFE® are registered trademarks of Daimler AG.
- HomeLink® is a registered trademark of Prince.
- iPod® and iTunes® are registered trademarks of Apple Inc.
- Logic7® is a registered trademark of Harman International Industries.
- Microsoft® and Windows media® are registered trademarks of Microsoft Corporation.
- SIRIUS is a registered trademark of Sirius XM radio Inc.
- HD Radio is a registered trademark of iBiquity Digital Corporation.
- Gracenote® is a registered trademark of Gracenote, Inc.
- ZAGATSurvey® and related brands are registered trademarks of ZagatSurvey, LLC.

Macrovision

This product incorporates copyright protection technology that is protected by U.S. patents and other intellectual property rights. Use of this copyright protection technology must be authorized by Rovi Corporation, and is intended for home and other limited viewing uses only unless otherwise authorized by Rovi Corporation. Reverse engineering or disassembly is prohibited.

libjpeg

This software is based in part on the work of the Independent JPEG Group.

Free Type

Portions of this software are copyright© 2005The FreeType Project (www.freetype.org). All rights reserved. ©

1996-2000 by David Turner, Robert Wilhelm, and Werner Lemberg.

NetFront™

This product contains NetFront Browser software of ACCESS Co., Ltd. Copyright © 1996-2010 ACCESS Co., Ltd. All rights reserved.

The NetFront Browser software is based in part on the work of the Independent JPEG Group.

Camellia

Copyright © 2006, 2007 NTT (Nippon Telegraph and Telephone Corporation). All rights reserved.

The conditions and disclaimers in connection with use of Camellia are available at <http://info.isl.ntt.co.jp/crypt/eng/index.html>.

Flash® Lite™

This product contains Flash® Lite™ technology by Adobe Systems Incorporated. This product contains Adobe® Flash® player software under license from Adobe Systems Incorporated, Copyright © 1995-2010 Adobe Macromedia Software LLC. All rights reserved. Adobe and Flash are registered trademarks of Adobe Systems Incorporated in the United States and/or other countries.

Your COMAND equipment

These operating instructions describe all standard and optional equipment available for your COMAND system at the time of purchase. Country-specific differences are possible. Please note that your COMAND system may not be equipped with all the features described. This also applies to safety-related systems and functions. Therefore, the equipment on your COMAND system may differ from that in the descriptions and illustrations. Contact an

authorized Mercedes-Benz Center if you have any questions about equipment or operation.

Function restrictions

For safety reasons, some COMAND functions are restricted or unavailable while the vehicle is in motion. You will notice this, for example, because either you will not be able to select certain menu items or COMAND will display a message to this effect.

At a glance

COMAND operating system

Overview



- ① COMAND display (▷ page 271)
- ② COMAND control panel with a single DVD drive or DVD changer
- ③ COMAND controller (▷ page 273)

You can use COMAND to operate the following main functions:

- the navigation system
- the audio function
- the telephone function

- the video function
- the system settings
- the online and Internet functions and the Digital Operator's Manual

You can call up the main functions:

- using the corresponding function buttons
- using the main function bar in the COMAND display

COMAND display

General notes

! Do not use the space in front of the display to stow anything. Objects placed here could damage the display or impair its function. Avoid touching the surface of the display. Pressure exerted on the surface of the display can have an irreversible, detrimental effect on the display.

Wearing polarized sunglasses may impair your ability to read the display.

The display has an automatic temperature-controlled switch-off feature. The brightness is automatically reduced if the temperature is too high. The display may temporarily switch off completely.

Display overview

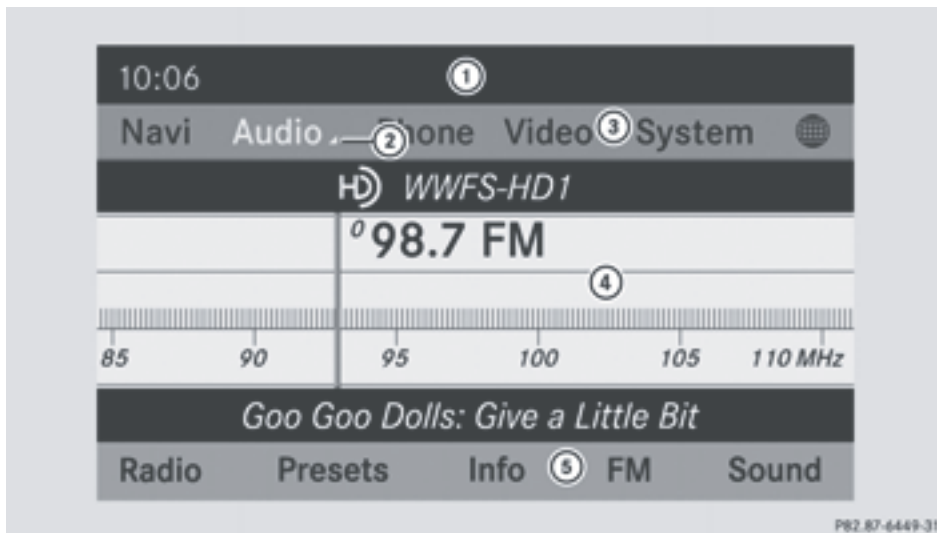

Example display for radio

- ① Status bar
- ② To call up the audio menu
- ③ Main function bar
- ④ Display/selection window
- ⑤ Radio menu bar

Status bar ① shows the time and the current settings for telephone operation.

The main functions – navigation, audio, telephone and video – feature additional menus. This is indicated by triangle ②. The following table lists the available menu items.

Main function bar ③ allows you to call up the desired main function. When the main function is activated, it is identifiable by the white lettering.

In the example, the audio main function is set to radio mode and display/selection window ④ is active.

Radio menu bar ⑤ allows you to operate the radio functions.

Switching the COMAND display on/off

▶ Press the **[sys]** function button.

or

▶ Select **System** in the main function bar by sliding **↑** and turning **⏪** the COMAND controller and press **⏩** to confirm.

In both cases, the system menu appears.

▶ **To switch off:** select **Display Off** and press **⏩** to confirm.

▶ **To switch on:** press one of the function buttons, e.g. **[sys]**, **[NAVI]** or the **[←]** back button.

Cleaning instructions

⚠ Do not touch the COMAND display. The display has a very sensitive high-gloss surface; there is a risk of scratching. If you

have to clean the screen, however, use a mild cleaning agent and a soft, lint-free cloth.

The display must be switched off and have cooled down before you start cleaning. Clean the display screen, when necessary, with a commercially available microfiber cloth and cleaning agent for TFT/LCD displays. Do not apply pressure to the display surface when cleaning it, as this could cause irreversible damage. Then, dry the surface with a dry microfiber cloth.

Avoid using alcoholic thinners, gasoline or abrasive cleaning agents. These could damage the display surface.

COMAND controller

Overview



① COMAND controller

You can use the COMAND controller to select the menu items in the COMAND display.

You can:

- call up menus or lists
- scroll within menus or lists and
- exit menus or lists

Operation

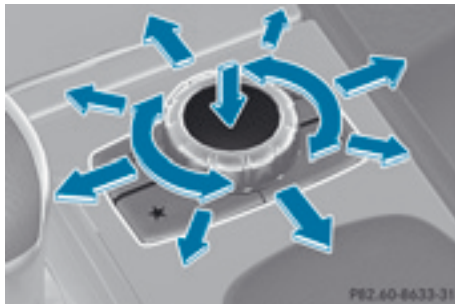

Operating the COMAND controller (example)

The COMAND controller can be:

- pressed briefly or pressed and held
- turned clockwise or counter-clockwise
- slid left or right
- slid forwards or back
- slid diagonally

Example of operation

In the instructions, operating sequences are described as follows:

- ▶ Press the **RADIO** button.
Radio mode is activated.
- ▶ Select **Radio** by sliding and turning the COMAND controller and press to confirm.
- ▶ Confirm **Station List** by pressing .
The station list appears.

Buttons on the COMAND controller

Overview



- ① Back button (▷ page 274)
- ② Delete button (▷ page 274)
- ③ Seat function button (▷ page 286)
- ④ Favorites button (▷ page 293)

Back button

You can use back button ① to exit a menu or to call up the basic display of the current operating mode.

- ▶ **To exit the menu:** press back button ① briefly.
COMAND changes to the next higher menu level in the current operating mode.
- ▶ Slide ←○→ or ↑○↓ the COMAND controller.
- ▶ **To call up the basic display:** press and hold back button ①.
COMAND changes to the basic display of the current operating mode.

Clear button

- ▶ **To delete individual characters:** briefly press CLR button ②.
- ▶ **To delete an entire entry:** press and hold CLR button ②.

Seat function button

You can use button ③ to call up the following seat functions:

- Multicontour seat (with 4-way lumbar support)
- Active multicontour seat (dynamic seat and massage function)
- Balance (seat heating distribution)

More information on the seat functions (▷ page 286).

Favorites button

You can assign predefined functions to favorites button ④ and call them up by pressing the button (▷ page 293).

Using COMAND





Selecting a main function



Address entry menu

Situation: switching from navigation mode (address entry menu) to the system settings.

- ▶ **To switch on navigation mode:** press the **NAVI** function button.
- ▶ **To show the menu:** press ④ the COMAND controller.
- ▶ Select **Destination** by sliding ○↓ and turning ④ the COMAND controller and press ④ to confirm.
- ▶ Select **Address entry** and press ④ to confirm.
The address entry menu appears.

- ▶ Slide  the COMAND controller and switch to main function bar .
- ▶ Select **System** in the main function bar by turning  the COMAND controller and press  to confirm.
The system menu appears.



Selecting the menu of a main function







Example display for audio CD mode and audio menu (below)

- ① To call up the audio menu

If one of the navigation, audio, telephone or video main functions is switched on,



triangle  appears next to the entry in the main function bar. You can now select an associated menu.

The example describes how to call up the audio menu from audio CD mode (an audio CD is playing).

- ▶ Select **Audio** in the main function bar by sliding  the COMAND controller and press  to confirm.
The Audio menu appears.
The  dot indicates the currently selected audio mode.
- ▶ Select another audio mode, e.g. **Radio**, by turning  the COMAND controller and press  to confirm.
Radio mode is activated.

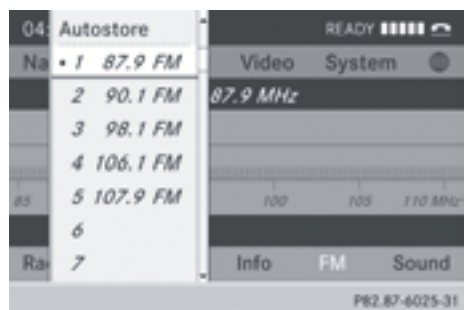

Selects a menu item



- ▶ Select the station by turning  the COMAND controller and press  to confirm.
The station is set.

Basic COMAND functions

Switching COMAND on/off

- ▶ Press the  control knob.
A warning message appears. COMAND calls up the previously selected menu.
-  If you switch off COMAND, playback of the current audio or video source will also be switched off.

Climate control status display



The climate status display in the COMAND display (example)

If you change the settings of the climate control system, the climate status display appears for three seconds at the bottom of the screen in the COMAND display. You will see the current settings of the various climate control functions.









Overview of climate control systems (▷ page 122).

The climate status display appears when:

- ▶ You turn one of the two temperature controls and set the temperature to the left or right.

or

- ▶ You press one of the following buttons:

-  Increases air flow
-  Decreases air flow
-  Switches climate control on/off
-  Switches the ZONE function on/off
-  Controls the air conditioning automatically
-  Sets the climate control style in automatic mode (FOCUS/MEDIUM/DIFFUSE)
-  Sets the air distribution
-  Turns on the defrost function
-  Turns on maximum cooling



Example settings for the defrost function (top) and for the climate mode in automatic mode

- ▶ **To hide the display:** turn or press the COMAND controller.

or

- ▶ Press one of the buttons on COMAND.

Displaying the image from the rear view camera

WARNING

The rear view camera is only an aid and may show a distorted view of obstacles, show them incorrectly or not at all.

Further information on the rear view camera (▷ page 190).



The image from the rear view camera is shown in the COMAND display when reverse gear is engaged if:



- your vehicle is equipped with a rear view camera.
- COMAND is switched on
- the **Activation by R gear** function is activated.

If the function is activated, the COMAND display will automatically switch back to the previously selected display as soon as you shift out of reverse gear.

-  Further information on the rear view camera (▷ page 190).



- ▶ Press the **sys** function button. The system menu appears.

- ▶ Select **Settings** by turning  the COMAND controller and press  to confirm.

- ▶ Select **Rear View Camera** and press  to confirm.
- ▶ Select **Activation by R gear** and press  to confirm.
The function is switched on or off , depending on the previous status.

Switching the sound on or off



Audio/video source sound

- ▶ Press the  button on COMAND or on the multifunction steering wheel.
The sound from the respective audio or video source is switched on or off.
- i** When the sound is off, the system displays the  icon in the status line.
When you change the audio or video source, or adjust the volume, sound automatically switches on again.
- i** Even if the sound is switched off, you will still hear navigation system announcements.

Switching off navigation announcements



- ▶ **Navigation announcements:** press the  button during the announcement.

Switching navigation announcements back on

- ▶ Press the  button again.
The navigation announcements are active again:
 - if COMAND is switched off/on with the  control knob.
 - or after starting route guidance

Adjusting the volume

Adjusting the volume for the audio or video source



- ▶ Turn the  control knob
or
- ▶ Press the  or  button on the multifunction steering wheel.
The volume of the currently selected audio or video source changes.

You can also adjust the volume for the following:

- navigation announcements
- phone calls
- voice output of the Voice Control System (see the separate operating instructions)



Adjusting the volume for navigation announcements

During a navigation announcement:

- ▶ Turn the  control knob
or
- ▶ Press the  or  button on the multifunction steering wheel.

Adjusting the volume for phone calls

You can adjust the volume for hands-free mode during a telephone call.

- ▶ Turn the  control knob
or
- ▶ Press the  or  button on the multifunction steering wheel.

Adjusting the sound settings

Calling up the sound menu



You can make various sound settings for the different audio and video sources. This means that it is possible to set more bass for radio mode than for audio CD mode, for example. You can call up the respective sound menu from the menu of the desired mode.

The example describes how to call up the sound menu in radio mode.

- ▶ Press the **RADIO** function button.
The radio display appears. You will hear the last station played on the last waveband.
- ▶ Select **Sound** by sliding $\odot \updownarrow$ and turning $\{\odot\}$ the COMAND controller and press \odot to confirm.
You can now set the treble, bass and balance for radio mode.

Adjusting treble and bass

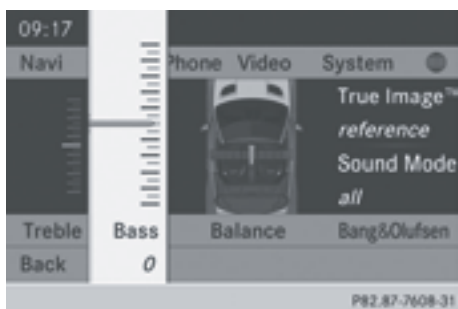

Setting the bass

- ▶ Select **Treble** or **Bass** in the sound menu by turning $\{\odot\}$ the COMAND controller and press \odot to confirm.
An adjustment scale appears.
- ▶ Select a setting by turning $\{\odot\}$ the COMAND controller and press \odot to confirm.
The setting is stored and you exit the menu.

Setting the balance

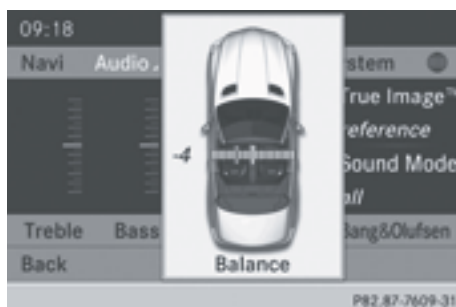

Adjusting the balance

With the balance function, you can control whether the sound is louder on the driver's or front-passenger side.

Equipped with Bang & Olufsen sound system: for the best sound focus, choose the setting **0**.

- ▶ Select **Balance** in the sound menu by turning $\{\odot\}$ the COMAND controller and press \odot to confirm.
- ▶ Select a balance setting by sliding $\leftrightarrow \odot$ the COMAND controller and press \odot to confirm.

Surround sound

General notes

Your vehicle is equipped with one of two sound systems:

- harman/kardon® Logic 7® Surround Sound system

The harman/kardon®Logic 7® Surround Sound system allows you to set the

optimum surround sound in the vehicle interior (▷ page 279).

- Bang & Olufsen sound system (▷ page 280)

Both sound systems are available for the following operating modes:

- radio (FM only)
- satellite radio
- audio CD
- audio DVD (MLP, dts, PCM and Dolby Digital audio formats)
- MP3 (including SD memory card and USB storage device)
- Media Interface
- Bluetooth® audio mode
- video DVD (PCM, dts and Dolby Digital audio formats)
- AUX

Because some DVDs contain both stereo and multichannel audio formats, it may be necessary to set the audio format (▷ page 430).

Discs which support the audio formats mentioned have the following logos:



Dolby Digital



dts



MLP

harman/kardon® Logic 7® Surround Sound system

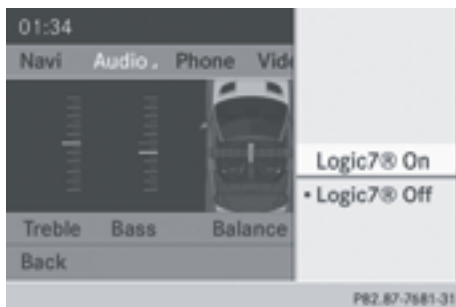



The example describes how to set the surround sound for radio mode.



- ▶ **To switch surround sound on/off:** press the **RADIO** function button.

The radio display appears. You will hear the last station played on the last waveband.

- ▶ Select **Sound** by sliding **⊙** and turning **⤴** the COMAND controller and press **⊙** to confirm.
- ▶ Select **surround** and press **⊙** to confirm.

- ▶ Select **Logic7® On** or **Logic7® Off** by turning  the COMAND controller and press  to confirm.

Depending on your selection, surround sound is switched on or off and the menu is exited.

- ▶ **To exit the menu without saving:** press the  back button or slide  the COMAND controller.

- i** Please note the following: for the optimum audio experience for all passengers when Logic7® is switched on, the balance should be set to the center of the vehicle interior.

You will achieve the best sound results by playing high-quality audio and video DVDs. MP3 tracks should have a bit rate of at least 128 kbit/s.

Surround sound playback does not function for mono signal sources, such as for AM radio mode.

If radio reception is poor, e.g. in a tunnel, you should switch off Logic7®, since it may otherwise switch dynamically between stereo and mono and cause temporary sound distortions.

On some stereo recordings, the sound characteristics may differ from conventional stereo playback.

- i** The **Logic7® On** function creates a surround sound experience for every passenger when playing stereo recordings, for example. It enables optimum playback of music and films on CD, audio DVD or video DVD with multichannel audio formats, such as MLP, dts or Dolby Digital. This results in sound characteristics like those intended by the sound engineer when the original was recorded.

- i** If you select **Logic7® Off**, all permissible formats are played as stored on the medium. Due to the design of the passenger compartment, an optimum audio experience cannot be guaranteed for all passengers.



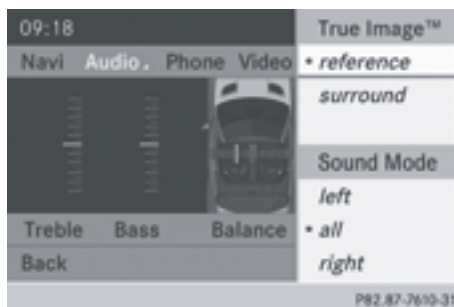



Bang & Olufsen sound system



You can optimize the sound in the vehicle with the Bang & Olufsen sound system and the **True Image™** sound technology. The **Sound Mode** function enables you to focus the selected sound setting within the vehicle.

The example describes how to set the optimum sound for radio mode.

Selecting the sound setting for True Image™

- ▶ Press the  function button.
- ▶ Select **Sound** by sliding  and turning  the COMAND controller and press  to confirm.
- ▶ Select **Bang&Olufsen** and press  to confirm.
 - A menu appears. A • dot marks the current setting for True Image™.
- ▶ Select **reference** or **surround** and press  to confirm.
 - **reference**

This setting provides a crisp, clear, luxury high-end sound setting for a studio atmosphere in your vehicle.
 - **surround**

This setting enables a wide-ranging sound experience for playing music and videos.

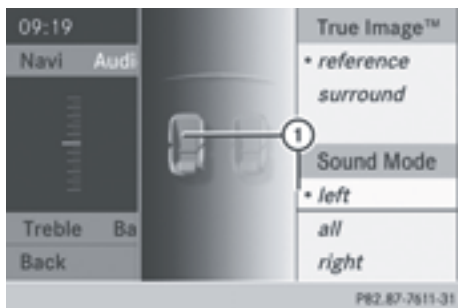

① Current position of the sound setting

For the optimum musical enjoyment, you can focus the sound image precisely on one seat. This means you are right at the center of the listening experience, with all system parameters being precisely calculated for the selected position. The result is authentic music reproduction inside the vehicle.

Focusing the sound setting

- ▶ Press the **RADIO** function button.
- ▶ Select **Sound** by sliding **⊙** and turning **⌂** the COMAND controller and press **⊙** to confirm.
- ▶ Select **Bang&Olufsen** and press **⊙** to confirm.
A menu appears. A **•** dot marks the current setting for Sound Mode.
- ▶ Select **left**, **all** or **right** and press **⊙** to confirm.
- ▶ **To exit the menu:** slide **←⊙→** the COMAND controller or press the **⏪** back button.

i Please note the following: you will achieve the best sound results on your Bang & Olufsen sound system by playing high-quality audio DVDs and CDs. MP3 tracks should have a bit rate of at least 224 kbit/s.

When playing using an iPod®, the bit rate should also be at least 224 kbit/s.

For optimum playback quality:

- ▶ Deactivate the “EQ” setting on the iPod®.

Surround-sound playback does not function for mono signal sources, such as the medium wave range (MW) in radio mode.

On some stereo recordings, the sound characteristics may differ from conventional stereo playback.

Character entry (telephony)

Example: entering characters

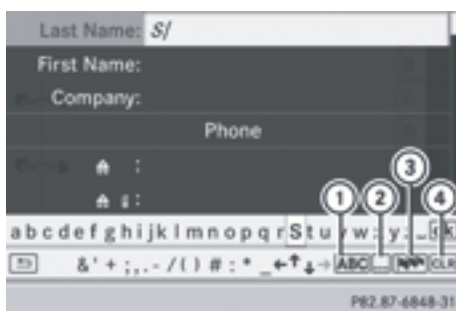

- ① **ABC** To switch the character bar to uppercase/lowercase letters
- ② **...** To switch the character bar from uppercase/lowercase letters to digits
- ③ **🌐** To change the language of the character bar
- ④ **CLR** To delete a character/an entry

The example describes how to enter the surname “Schulz”.

- ▶ Call up the input menu with data fields (▷ page 370).
- ▶ Select **S** and confirm by pressing **⊙** the COMAND controller.
S appears in the data field.
- ▶ Select **c** and confirm by pressing **⊙** the COMAND controller.
The letter **c** is added to **S** in the data field.
- ▶ Repeat the process until the name has been entered in full.

Other input menu functions:

- to delete a character/entry (▷ page 283)
 - to switch between upper/lower-case letters (▷ page 282)
 - to change the character set (▷ page 282)
 - to move the cursor in the data field (▷ page 283)
- **To enter a phone number:** select the digits one by one in the corresponding data field by turning **⏪** and sliding **↑**/**↓** the COMAND controller and press **⏩** to confirm.

Switching data fields

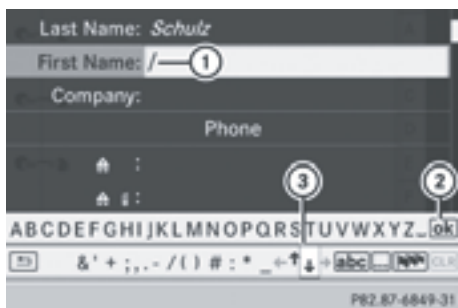

- ① Cursor in the next data field
- ② To store an entry
- ③ **↑** and **↓** symbols to select a data field

In the input menu, if you want to enter a first name after you have entered a surname, for example, proceed as follows to switch between the data fields:

Option 1

- Select **↑** or **↓** in the character bar and press **⏩** to confirm.
The input menu shows the data field selected.

Option 2

- Slide **⏪** the COMAND controller repeatedly until the character bar disappears.
- Select the data field by sliding **↑**/**↓** and press **⏩** to confirm.

Storing an entry

- **After making an entry in the input menu** (▷ page 370): select the **ok** symbol in the character bar by turning **⏪** the COMAND controller and press **⏩** to confirm.
The entry is stored in the address book.

Further functions available in the character bar

Changing the language of the character bar

While making an entry in the input menu (▷ page 370):

- Select **🌐** and press **⏩** to confirm.
- Select the language by turning **⏪** the COMAND controller and press **⏩** to confirm.

Switching the character bar to letters

While making an entry in the input menu (▷ page 370):

- Select the **ABC** (upper case) or **abc** (lower case) symbol and press **⏩** to confirm.

Changing the character set

While making an entry in the input menu (▷ page 370):

- Select the **...** symbol and press **⏩** to confirm.
- **ABC** (upper/lower case)
 - **123** (digits)
 - **Other** (special characters such as @, €, etc.)

Moving the cursor to the next data field



- ① Cursor (repositioned)
- ② ◀ and ▶ symbol to reposition the cursor

While making an entry in the input menu (▷ page 370):

- ▶ Select the ◀ or ▶ symbol and press to confirm.

Deleting a character/an entry

While making an entry in the input menu (▷ page 370):

- ▶ **To delete characters:** press the **CLEAR** button on the control panel.

or

- ▶ Select the **CLR** symbol by sliding and turning the COMAND controller and press to confirm.

or

- ▶ Press the **CLR** button next to the COMAND controller.

- ▶ **To delete an entry:** press and hold the **CLEAR** button on the control panel until the entire entry has been deleted.

or

- ▶ Select the **CLR** symbol and press and hold the COMAND controller until the entire entry has been deleted.

or

- ▶ Press and hold the **CLR** button next to the COMAND controller until the entire entry is deleted.

Character entry (navigation)

General information

Character entry is explained in the following sections using **NEW YORK** as an example for entering a city.

If you want to use the address entry menu to enter a city, a street or a house number, for example, COMAND offers you:

- a list with a character bar (option 1)
- a selection list (option 2)

Address entry menu (▷ page 299).

You can enter the characters using either the character bar or the number keypad. In the selection list, you select an entry to copy it to the address entry menu.

Option 1: city list/street list with character bar

- ▶ Call up the city list with character bar (▷ page 299).

The alphabetically sorted city list shows the first available entries.

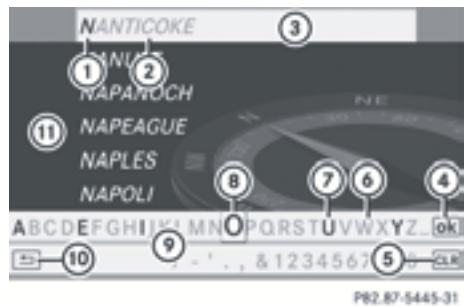

- ① N character entered by user
- ② Characters automatically added by COMAND **ANTICOKE**
- ③ List entry that most closely resembles the current entry by the user
- ④ To switch to the selection list
- ⑤ To delete an entry
- ⑥ Characters not currently available
- ⑦ Characters currently available
- ⑧ Currently selected character

- ⑨ Character bar
- ⑩ To cancel an entry
- ⑪ List

Entering characters using the character bar

- ▶ Select **N** by turning the COMAND controller and press to confirm. List ⑪ shows all available city names beginning with **N**. The list entry most closely resembling user's current entry ③ is always highlighted at the top of the list (**NANTICOKE** in the example).

All characters currently entered by the user are shown in black (letter **N**① in the example). Letters added by COMAND ② are shown in gray (letters **ANTICOKE** in the example).

Character bar ⑨ shows letters still available for selection ⑦ in black. These can be selected; in the example, the letter **O** is highlighted ⑧. Which characters remain available depends on the characters already entered by the user and on the data stored on the digital map. Characters that are no longer available ⑥ are shown in gray.



- ▶ Select **E**, **W**, space, **Y** in order and confirm each with .

Entering characters using the number keypad

- ▶ To enter the letter **N**: press the number button twice in quick succession. The character appears at the bottom of the display when the key is pressed. The first available letter is highlighted.

You see which characters you can enter with that key. Each time the key is pressed, the next character is selected.

Example: key :

- press once = M
- press twice = N
- press three times = O

- ▶ Wait until the character display goes out. The entries matching your input are shown in the list.

- ▶ Enter **E**, **W**, space, **Y** with the corresponding keys.

- ① The space is entered using number key ⑩.

Further functions in the list with character bar

- ▶ **To delete characters:** press the button on the control panel.

or

- ▶ Press the button next to the COMAND controller.

or



- ▶ Select the symbol by sliding and turning the COMAND controller and press to confirm.

- ▶ **To delete an entry:** press on the control panel.



or

- ▶ Press and hold the button next to the COMAND controller until the entire entry is deleted.

or

- ▶ Select the **CLR** symbol and press and hold  the COMAND controller until the entire entry has been deleted.
- ▶ **To cancel an entry:** select the  symbol in the bottom left of the character bar and press  to confirm.

or

- ▶ Press the  back button.
The address entry menu appears.
- ▶ **To accept the first list entry:** press and hold  the COMAND controller until the address entry menu appears.
The accepted list entry is shown there.

Calling up the list as a selection list

Select the desired city from the selection list.



If there are several entries for a city or if several cities of the same name are stored, then **ok** is highlighted in the character bar.

- ▶ Press  the COMAND controller.

It is also possible to switch the city list to the selection list at any time during character input.

- ▶ Slide  the COMAND controller repeatedly until the city list appears as a selection list.

or

- ▶ Select **ok** in the character bar by turning  the COMAND controller and press  to confirm.

Option 2: city list as selection list

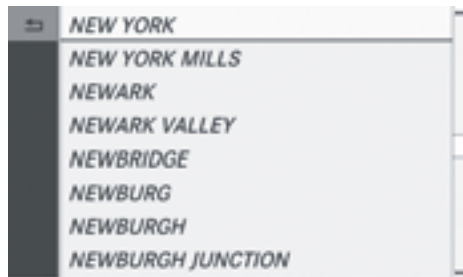

P82.87-6773-31

COMAND either shows the selection list automatically or you can call up the selection list from the list with the character bar.

The example shows the selection list after the city **NEW YORK** has been entered. The entry is highlighted automatically.

- ▶ Confirm **NEW YORK** by pressing  the COMAND controller.

The address entry menu appears. You can now enter a street, for example.



P82.87-6517-31

Information on destination entry (▷ page 298).

Seat functions

Overview

Using the  button next to the COMAND controller or the Seat menu item in the system menu, you can call up the following seat functions:







- multicontour seat (with 4-way lumbar support)
- active multicontour seat (dynamic seat and massage function)
- balance (seat heating distribution)

i You also can save and recall the current settings of a seat function using the memory button and the corresponding memory position switch (▷ page 105).

Selecting the seat



First select the seat which you wish to adjust.

- ▶ Option 1: press the  button.
- ▶ Option 2: press the  button.
- ▶ Select **Seat** and press  to confirm.
- ▶ To switch to the lower line, for both options slide  the COMAND controller.
- ▶ Select **Driver's Seat** or **Passenger Seat** by turning  the COMAND controller and press  to confirm.

Multicontour seat

Overview

The contour of the driver's seat and front-passenger seat backrests can be individually adjusted to provide optimum support for your back. This is done by controlling the pressure in the air chambers of the multicontour seat.

The adjustments are made using the COMAND display.

i When you adjust the multicontour seat, you may hear the air being pumped in or released.





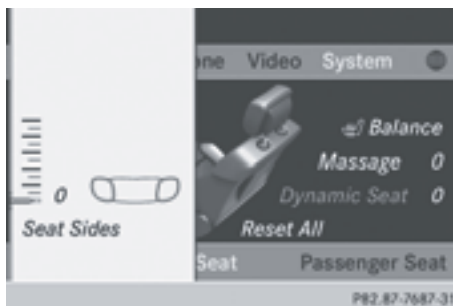

You can adjust the following air cushions:

- seat side bolsters
- seat backrest side bolsters
- contour of the seat backrest in the lumbar region

Adjusting the seat side bolsters



This function allows you to adjust the air cushions in the seat side bolsters.

- ▶ Select the seat (▷ page 286).
- ▶ Select **Seat Sides** by turning  the COMAND controller and press  to confirm. A scale appears.
- ▶ Turn  or slide  the COMAND controller and press  to confirm.
- ▶ **To exit the menu:** press the  back button.

Adjusting the seat backrest side bolsters



- ▶ Select the seat (▷ page 286).
- ▶ Select **Seatb. Sides** by turning $\left[\odot \right]$ the COMAND controller and press \odot to confirm. A scale appears.
- ▶ Turn $\left[\odot \right]$ or slide $\uparrow \odot \downarrow$ the COMAND controller and press \odot to confirm.
- ▶ **To exit the menu:** press the $\left[\leftarrow \right]$ back button.

Adjusting the backrest curvature in the lumbar region



This function allows you to adjust the air cushions in the lumbar region of the backrest (4-way lumbar support).

- ▶ Select the seat (▷ page 286).
- ▶ Select **Lumbar** by turning $\left[\odot \right]$ the COMAND controller and press \odot to confirm. A crosshair appears. You can make two settings:

- **Vertical:** to move the point of greatest lumbar support up or down
- **Horizontal:** to adjust the amount of support

- ▶ Slide $\uparrow \odot \downarrow$ or $\leftarrow \odot \rightarrow$ the COMAND controller and press \odot to confirm.
- ▶ **To exit the menu:** press the $\left[\leftarrow \right]$ back button.

Active multicontour seat

Dynamic seat



- ▶ Select the seat (▷ page 286).
- ▶ Select **Dynamic Seat** by turning $\left[\odot \right]$ the COMAND controller and press \odot to confirm. A scale appears. You can select:
 - 0: Off
 - 1: level 1 (medium setting)
 - 2: level 2 (high setting)
- ▶ Turn $\left[\odot \right]$ or slide $\uparrow \odot \downarrow$ the COMAND controller and press \odot to confirm.
- ▶ **To exit the menu:** press the $\left[\leftarrow \right]$ back button.

Message function

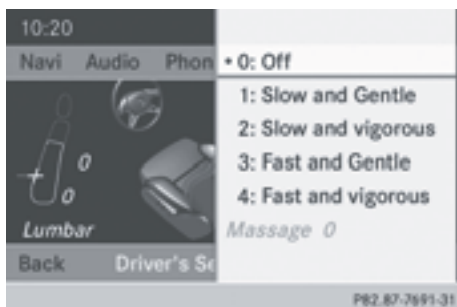

- ▶ Select the seat (▷ page 286).
- ▶ Select **Message** by turning the COMAND controller and press to confirm.

A list appears.

You can select different types of massage function:

- **0: Off**
 - **1: Slow and Gentle**
 - **2: Slow and Vigorous**
 - **3: Fast and Gentle**
 - **4: Fast and Vigorous**
- ▶ Turn or slide the COMAND controller and press to confirm. The massage function runs for approximately 15 to 25 minutes, depending on the setting.
 - ▶ **To exit the menu:** press the back button.

Balance



The Balance function controls the distribution of heat on the seat backrest and cushion.

The Balance function influences the currently set heating level of the seat heating (▷ page 100).

- ▶ Select the seat (▷ page 286).
- ▶ Select **Balance** by turning the COMAND controller and press to confirm.

A scale appears and shows the current setting. Positive values indicate the heat output for the seat backrest, negative values indicate the heat output for the seat cushion. The intensity is indicated by an orange bar in the stylized seat above the scale.

The values stand for:

- **0** - backrest and seat cushion are heated equally to the maximum level
 - **1 to 3** - the heat output to the seat cushion is reduced in one-third increments
 - **-1 to -3** - the heat output to the backrest is reduced in one-third increments
- ▶ Turn or slide the COMAND controller and press to confirm.
 - ▶ **To exit the menu:** press the back button.

Resetting all adjustments



- ▶ Select the seat (> page 286).
- ▶ Select **Reset All** by turning **⏻** the COMAND controller and press **⏻** to confirm.
A query appears.
- ▶ Select **Yes** or **No** and press **⏻** to confirm.
If you select **No**, the process will be canceled.
After you select **Yes**, all seat adjustments are reset to the default values (factory setting).

System settings

Display settings

Setting the brightness

The brightness detected by the display light sensor affects the setting options for this function.



- ▶ Press **sys**.
- ▶ Select **Settings** by turning **⏻** the COMAND controller and press **⏻** to confirm.
- ▶ Select **Display** and press **⏻** to confirm.
- ▶ Select **Brightness** and press **⏻** to confirm.
- ▶ Adjust the brightness by turning **⏻** the COMAND controller and press **⏻** to confirm.

Display design

Your COMAND display features optimized designs for operation during daytime and night-time hours. You can set the design by manually selecting day or night design or opt for an automatic setting.

- ▶ Press **sys**.
- ▶ Select **Settings** by turning **⏻** the COMAND controller and press **⏻** to confirm.
- ▶ Select **Display** and press **⏻** to confirm.
- ▶ Select **Day Mode**, **Night Mode** or **Automatic** by turning **⏻** the COMAND controller and press **⏻** to confirm.
A dot indicates the current setting.

Design	Explanation
Day Mode	The display is set permanently to day design.
Night Mode	The display is set permanently to night design.
Automatic	If the Automatic setting is selected, COMAND evaluates the readings from the automatic vehicle light sensor and automatically switches between the display designs.

Time settings

General information

If COMAND is equipped with a navigation system and has GPS reception, COMAND automatically sets the time and date. You can also adjust the time yourself in 30-minute increments, but the date cannot be changed.

- i** If you set the time in 30-minute increments, any time zone settings and settings for changing between summer and

standard time are lost. Switching between summer and standard time (▷ page 290).

i The following navigation system functions require the time, time zone and summer/standard time to be set correctly in order to work properly:

- route guidance on routes with time-dependent traffic guidance
- calculation of expected time of arrival

Setting the time



- ▶ Press **sys**.
- ▶ Select **Time** by turning **⏪** the COMAND controller and press **⏩** to confirm.
- ▶ Select **Set Time** and press **⏩** to confirm.
- ▶ Set the time by turning **⏪** the COMAND controller and press **⏩** to confirm. The time is accepted.

Setting the time/date format

- ▶ Press **sys**.
- ▶ Select **Time** by turning **⏪** the COMAND controller and press **⏩** to confirm.
- ▶ Select **Format** and press **⏩** to confirm. The **•** symbols show the current settings.
- ▶ Set the format by turning **⏪** the COMAND controller and press **⏩** to confirm.

Abbreviation	Meaning
DD / MM / YY	Day/Month/Year (date format)
HH/MM	Hours/Minutes (time format)

You can set the 24-hour or the AM/PM format.

Adjusting the time zone and switching to Daylight Savings Time (Summer)

- ▶ Press **sys**.
- ▶ Select **Time** by turning **⏪** the COMAND controller and press **⏩** to confirm.
- ▶ Select **Time Zone** and press **⏩** to confirm. You will see a list of time zones. The **•** dot indicates the current setting.
- ▶ Select the time zone and press **⏩** to confirm.
- ▶ **To switch automatic changeover on/off:** select **Auto. Daylight Savings Time On** or **Auto. Daylight Savings Time Off** by turning **⏪** the COMAND controller and press **⏩** to confirm. The **•** dot indicates the current setting.

Fuel consumption indicator

Overview

Depending on the vehicle equipment, the COMAND display shows fuel consumption. If your vehicle is a hybrid vehicle and the installed engine variant supports it, you can call up other displays (see the separate operating instructions).

Calling up/exiting the display

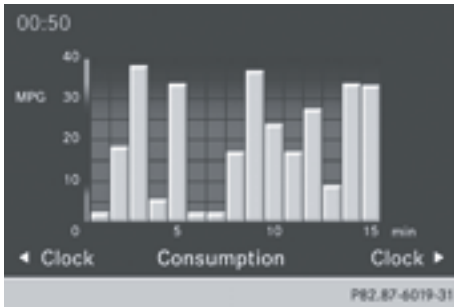

- ▶ **To call up the full screen display:** press the **[sys]** button.
- ▶ In the system menu, slide **↑** the COMAND controller up until the **Full Screen** option is selected.
- ▶ Press **[OK]** the COMAND controller. The system display is shown as full screen (without system menu).
- ▶ Slide **←** the COMAND controller repeatedly until the fuel consumption indicator appears. The COMAND display shows the fuel consumption for the last 15 minutes of the journey.
- ▶ **To exit the full screen display:** press **[OK]** the COMAND controller. The system menu appears.

Every bar of the graph displays the average value for one minute.

The fuel consumption indicator may differ from the indicator in the **FROM START** trip computer in the **Trip** menu (▷ page 209).

Driving conditions menu (Active Body Control)

General notes

On vehicles with Active Body Control (ABC), you can display some driving systems and additional information in the COMAND display.

Calling up drive status regulator (ABC)

- ▶ Press **[sys]**.
- ▶ In the system menu, slide **↑** the COMAND controller up until the display/selection window is selected.
- ▶ Slide **←** the COMAND controller repeatedly until the drive status regulator (ABC) appears. The corresponding displays appear in the COMAND display.

Details on the displays:

- for standard vehicles (▷ page 180)
- for AMG vehicles (▷ page 183)

Exiting the display

- ▶ Slide **←** the COMAND controller until the desired display (clock or fuel consumption) is shown.

Text reader settings

- ▶ Press the **[sys]** button.
- ▶ Select **Settings** by turning **↑** the COMAND controller and press **[OK]** to confirm.
- ▶ Select **Text Reader Speed** and press **[OK]** to confirm. A list appears. The **•** dot indicates the current setting.
- ▶ Select a setting by turning **↑** the COMAND controller and press **[OK]** to confirm.

Voice Control System settings

Opening/closing the help window

The help window provides information in addition to the audible instructions during individualization and during the subsequent voice control.

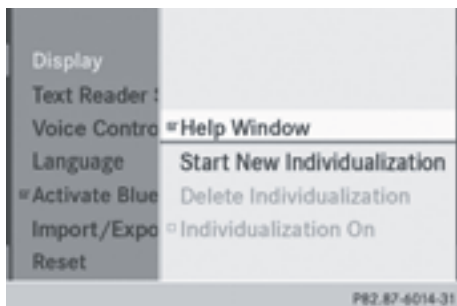

- ▶ Press **sys**.
- ▶ Select **Settings** by turning **⏻** the COMAND controller and press **⏻** to confirm.
- ▶ Select **Voice Control** and press **⏻** to confirm.
- ▶ Select **Help Window** and press **⏻** to confirm.
You have switched the help window on or off .

Individualization

Using individualization, you can fine-tune the Voice Control System to your own voice and thus improve voice recognition; see the separate operating instructions.

Bluetooth® settings

General information about Bluetooth®

Bluetooth®-capable devices, e.g. mobile phones, have to comply with a certain profile in order to be connected to COMAND. Every Bluetooth® device has its own specific Bluetooth® name.

Bluetooth® technology is the standard for short-range wireless data transmission of up to approximately 10 meters. Bluetooth® allows, for example, the exchange of vCards.



Bluetooth® is a registered trademark of Bluetooth Special Interest Group (SIG) Inc.

Activating/deactivating Bluetooth®

- ▶ Press **sys**.
The system menu appears.
- ▶ Select **Settings** by turning **⏻** the COMAND controller and press **⏻** to confirm.
- ▶ Select **Activate Bluetooth** and press **⏻** to confirm.
This switches Bluetooth® on or off .

Setting the system language

This function allows you to determine the language for the menu displays and the navigation announcements. The selected language affects the characters available for entry.

The navigation announcements are not available in all languages. If a language is not available, the navigation announcements will be in English.

When you set the system language, the language of the Voice Control System will change accordingly. If the selected language is not supported by the Voice Control System, English will be selected.

- ▶ Press the **sys** button.
- ▶ Select **Settings** by turning **⏻** the COMAND controller and press **⏻** to confirm.
- ▶ Select **Language** and press **⏻** to confirm.
The list of languages appears. The **•** dot indicates the current setting.

- ▶ Select the language by turning **[⏻]** the COMAND controller and press **[OK]** to confirm.
COMAND loads the selected language and sets it.

Assigning a favorites button

- ▶ **To assign a favorites button:** press the **[SYS]** button.
- ▶ Select **Settings** by sliding **[⏻]** and turning **[⏻]** the COMAND controller and press **[OK]** to confirm.
- ▶ Select **Assign as Favorite** and press **[OK]** to confirm.
The list of predefined functions appears.
The dot • indicates the currently selected function.
- ▶ Select the function by turning **[⏻]** the COMAND controller and press **[OK]** to confirm.
The favorites button is assigned the selected function.
- ▶ **Example: to call up a favorite:** press the **[★]** favorites button.
This calls up the predefined function.

You can select the following predefined functions in a menu:

- **Display On/Off:** you can switch the display off or on.
- **Full Screen: 'Clock':** you can call up the full screen with clock.
- **Full Screen: 'Map':** you can call up the full screen with map.
- **Spoken Driving Tip:** you can call up the current driving recommendation.
- **Display Traffic Messages:** you can call up traffic reports.
- **Navigate Home:** you can start route guidance to your home address if you have already entered and saved the address (▷ page 304).

- **Detour Menu:** you can call up the Detour menu and then avoid a section of the route and recalculate the route (▷ page 326).
- **Compass Screen:** you can call up the compass.
- **Driver's Seat Massage, Front-Passenger's Seat Massage or Massage: Both Front Seats:** you can start the massage function, depending on which seats are selected (▷ page 288).

Importing/exporting data

- ! Never remove the stick or card when writing data to the USB stick or the memory card. You may otherwise lose data.

Using this function, you can:

- transfer your personal COMAND data from one system/vehicle to another
- make a backup copy of your personal data (export data) and load it again (import data).

You can either use an SD memory card or a USB storage device (e.g. a USB stick) as temporary storage.

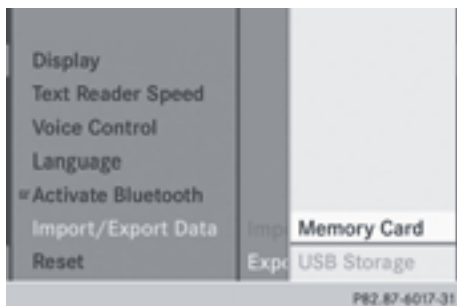

- ▶ Insert the SD memory card (▷ page 424).
- or
- ▶ Connect a USB device (e.g. a USB memory stick) (▷ page 424).
- ▶ Press **sys**.
The system menu appears.
- ▶ Select **Settings** by turning **⏪** the COMAND controller and press **⏩** to confirm.
- ▶ Select **Import/Export Data** and press **⏩** to confirm.
- ▶ Select **Import Data** or **Export Data** and press **⏩** to confirm.
- ▶ **To select a preset:** select **Memory Card** or **USB Storage** and press **⏩** to confirm.

- ▶ Select **All Data** and press **⏩** to confirm.
This function exports all the data to the selected disc.

or

- ▶ Select the data type and press **⏩** to confirm.
Depending on the previous entry, select the data type for the export or not .
- ▶ Select **Continue** and press **⏩** to confirm.

i Personal music files in the MUSIC REGISTER cannot be saved and imported again using this function.

Reset function

You can completely reset COMAND to the factory settings. Amongst other things, this will delete all personal COMAND data. This includes the station presets, entries in the destination memory and in the list of previous destinations in the navigation system and address book entries. Resetting is recommended before selling or transferring ownership of your vehicle, for example. Data on the internal hard drive, e.g. music files in the MUSIC REGISTER, will be deleted. You can also delete music files from the MUSIC REGISTER using the "Delete all music files" function (▷ page 438).

- ▶ Press the **sys** function button.
- ▶ Select **Settings** by turning **⏪** the COMAND controller and press **⏩** to confirm.
- ▶ Select **Reset** and press **⏩** to confirm.
A prompt appears asking whether you wish to reset.
- ▶ Select **Yes** or **No** and press **⏩** to confirm.
If you select **No**, the process will be canceled.

If you select **Yes**, a prompt will appear again asking whether you really wish to reset.

- ▶ Select **Yes** or **No** and press  to confirm. If you select **Yes**, a message will be shown. COMAND is reset and restarted.

If you select **No**, the process will be canceled.

- ❗ **Resetting personal COMAND data does not reset the Internet and online settings** (▶ page 401). Likewise, resetting the Internet and online settings does not reset personal COMAND data.

Navigation

Introduction

Safety notes

WARNING

For safety reasons, only enter a new destination when the vehicle is stationary.

When you are driving, another passenger should enter the destination. Read the Operator's Manual and select the route before driving.

Bear in mind that at a speed of only 30 mph (approximately 50 km/h), the vehicle covers a distance of 44 feet (approximately 14 m) per second.

COMAND calculates the route to the destination without taking account of the following, for example:

- traffic lights
- stop and give way signs
- merging lanes
- parking or stopping in a no parking/no stopping zone
- other road and traffic rules and regulations
- narrow bridges

WARNING

COMAND may give incorrect navigation commands if the actual road/traffic situation no longer corresponds to the data on the

digital map. Digital maps do not cover all areas nor all routes in an area. For example, a route may have been diverted or the direction of a one-way street may have changed.

For this reason, you must always observe road and traffic rules and regulations during your journey. Road and traffic rules and regulations always have priority over the system's driving recommendations.

WARNING

Navigation announcements are intended to direct you while driving without diverting your attention from the road and driving.

Please always use this feature instead of consulting the map display for directions. Looking at the icons or map display can distract you from traffic conditions and driving, and increase the risk of an accident.

General notes

Operational readiness of the navigation system

The navigation system must determine the position of the vehicle before first use or whenever operational status is restored. Therefore, you may have to drive for a while before precise route guidance is possible.

GPS reception

Correct functioning of the navigation system depends, amongst other things, on GPS reception. In certain situations, GPS reception may be impaired, there may be interference or there may be no reception at all, e.g. in tunnels or parking garages.

Entry restriction

On vehicles for certain countries, there is a restriction on entering data.

The restriction is active from a vehicle speed of above approximately 3 mph (5 km/h). As soon as the speed falls below approximately

2 mph (3 km/h), the restriction becomes inactive.

When the restriction is active, certain entries cannot be made. This will be indicated by the fact that certain menu items are grayed out and cannot be selected.

The following entries are not possible, for example:

- entering the destination city and street
- entering a destination via the map
- entering POIs in the vicinity of a city or via a name search
- editing entries
- using the number keypad for direct entry

Other entries are possible, such as entering points of interest in the vicinity of the destination or current position.

Switching to navigation mode



Map showing the menu; route guidance inactive

- ① Status bar
- ② Main function bar
- ③ Current vehicle position
- ④ Navigation menu bar

► Press the **NAVI** function button.
The map is displayed with the menu either shown or hidden.

► Select **Navi** in the main function bar by sliding and turning the COMAND controller and press to confirm.
The map is displayed with the menu shown.



Map without the menu; route guidance inactive

- ① Current vehicle position
- ② Map orientation selected
- ③ Map scale selected

i **Route guidance active** means that you have entered a destination and that COMAND has calculated the route. The display shows the route, changes of direction and lane recommendations. Navigation announcements guide you to your destination.

Route guidance inactive means that no destination has been entered yet and no route has been calculated yet.

Showing/hiding the menu

You can show or hide the menu at the lower edge of the map.

► **To hide the menu:** slide the COMAND controller and, when the **Full Screen** menu item is shown, press to confirm.

or

► Press the back button.
The map can be seen in the full-screen display.

► **To show the menu:** press the COMAND controller when the map is shown in full-screen display.

Basic settings

Setting route type and route options

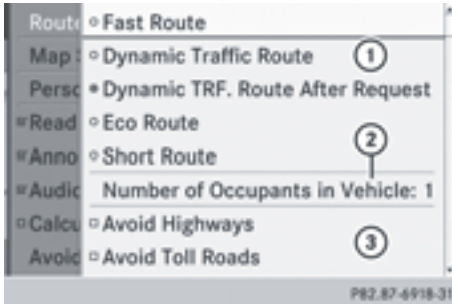

Route settings menu (start of menu)

- ① To select the route type
 - ② To set the number of persons in the vehicle for the use of carpool lanes
 - ③ To set route options
- ▶ Select **Navi** in the main function bar by sliding $\uparrow \odot$ and turning $\left[\odot \right]$ the COMAND controller and press \odot to confirm.
 - ▶ Select **Route Settings** and press \odot to confirm.
The route settings menu appears.
 - ▶ Select a route type and press \odot to confirm.
A filled circle indicates the current setting.
 - ▶ Select the route option(s) and press \odot to confirm.
The route options are switched on or off , depending on the previous status.
- i** If you change the route type and/or the route options while route guidance is active, COMAND will calculate a new route. If you change the route type and/or the route options while route guidance is inactive, COMAND uses the new setting for the next route guidance.

Route guidance active: a destination has been entered and the route has been calculated.

Route guidance inactive: no destination has been entered yet and no route has been calculated yet.

i RDS-TMC is not available in all countries.

You can select the following route types:

- **Fast Route:** COMAND calculates a route with the shortest (minimized) journey time.
- **Dynamic Traffic Route:** same route type as **Fast Route**. In addition, COMAND takes into account any relevant traffic reports received during route guidance. The navigation system can help you avoid a traffic jam, for example, by recalculating the route.
- **Dynamic TRF. Route After Request:** same route type as **Dynamic Traffic Route**. After recalculating the route, COMAND asks you whether you want to adopt the new route or whether you want to continue along the original route.
- **Eco Route:** the **Eco Route** is a variant of the **Fast Route** route type. COMAND will attempt to minimize the journey distance at the expense of a slightly increased journey time.
- **Short Route:** COMAND calculates a route with the shortest possible (minimized) route distance.

i The route calculated may, for example, include ferry connections, even if the **Avoid Ferries** route option is switched on.

In some cases, e.g. when calculating particularly long routes, COMAND may not be able to take all the selected route options into account.

- ▶ **To exit the menu:** slide $\leftarrow \odot \rightarrow$ the COMAND controller.

Setting the number of persons in the vehicle for the use of carpool lanes

For route calculation, you can take HOV or carpool lanes into account.

If you use HOV or carpool lanes, please observe the applicable laws as well as the local and time limitation conditions.

calculated yet.

Carpool lanes may only be used under certain conditions. Normally you can use these lanes when two or more occupants are traveling in the vehicle. However, there are lanes that can only be used when three or four occupants (e.g. in New York) travel in the vehicle. In California, lone drivers can use a carpool lane if their vehicle's emission level or fuel consumption is below a fixed threshold.

Carpool lanes may be reserved for specific times (e.g. during the peak period).

Carpool lanes are identified by HOV symbols on special road signs and by markings on the road. The road signs may also include the designation **CARPOOL**. The lanes are arranged as a separate lane next to the others or are built as a physically separate lane.

Depending on the setting under **Number of Occupants in Vehicle**, COMAND uses carpool lanes when calculating the route. COMAND then guides you in and out of carpool lanes using visual and acoustic driving directions.



- ▶ In the route settings menu, select **Number of Occupants in Vehicle** by turning **[Ⓢ]** the COMAND controller.

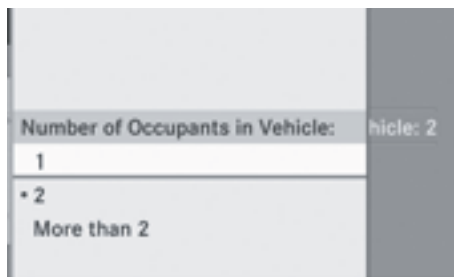

- ▶ Select **1**, **2** or **More than 2** by turning **[Ⓢ]** and press **[Ⓢ]** to confirm.
 - A • dot indicates the current setting.

Destination input

Important safety notes

WARNING

For safety reasons, only enter a new destination when the vehicle is stationary. You could otherwise be distracted from the traffic conditions, cause an accident and injure yourself and others.

Entering a destination by address

Introduction

When entering an address as the destination, you have the following options:

- entering the state/province, city/ZIP code and street
- entering the state/province, city and center
- entering the state/province, city/ZIP code, street and house number
- entering the state/province, city/ZIP code, street and intersection
- entering the state/province, street, city and house number
- entering the state/province, street and house number
- entering the state/province, street and intersection

- i** You can only enter those cities, streets, ZIP codes etc. that are stored on the digital map. This means that for some countries, you cannot enter ZIP codes, for example.

The step-by-step instructions for entering an address use the following example data:

New York (state)

New York (city)

40 Broadway

Of course, you can freely enter information such as state/province, city, street and house number, for example to enter your home address.

Address entry menu

Calling up the address entry menu

- ▶ **To switch to navigation mode:** press the **NAVI** function button.
- ▶ **To show the menu:** press **⏻** the COMAND controller.
- ▶ Select **Dest.** by turning **⏻** the COMAND controller and pressing **⏻** to confirm.



Address entry menu

- ▶ Select **Address Entry** and press **⏻** to confirm.
The address entry menu appears. If you have previously entered a destination, this will be shown in the display.

Depending on the sequence in which you enter the address and on the data status of the digital map, some menu items may not be available at all or may not yet be available.

Example: after you enter the state/province, the **Map**, **No.**, **Center**, **Intersection**, **Save** and **Start** menu items are not available. The **ZIP code** menu item is not available unless the digital map contains ZIP codes.

Entering the state/province, city, street and number

Selecting a state/province

- ▶ Call up the address entry menu (▷ page 299).
- ▶ Select **State/Prov** in the address entry menu by turning **⏻** the COMAND controller and press **⏻** to confirm. A menu with the available lists appears:
 - **Last States/Provinces**
 - **States (U.S.A.)**
 - **Provinces (Canada)**
- ▶ **To select a list:** turn **⏻** the COMAND controller and press **⏻** to confirm. The list of selected states/provinces appears.
- ▶ **To select a state/province:** turn **⏻** the COMAND controller and press **⏻** to confirm. The address entry menu appears again. The state/province selected has now been entered.

Entering a city

- ▶ Call up the address entry menu (▷ page 299).
- ▶ Select **City** in the address entry menu by turning **⏻** the COMAND controller and press **⏻** to confirm. You will see the city list either with the character bar (option 1) or as a selection list (option 2).



City list with character bar

Option 1: city list with the character bar

- ▶ Enter **NEW YORK**. Character entry, using city input as an example (▷ page 283).



List of cities as selection list

Option 2: city list as selection list

- ▶ Select an entry by turning **⏪** the COMAND controller.
- ▶ Irrespective of the option, press **⏩** to confirm your selection.
The address entry menu appears again. The city has now been entered.

Entering a street name

- ▶ Call up the address entry menu (▷ page 299).
- ▶ Select **Street** in the address entry menu by turning **⏪** and sliding **⏩** the COMAND controller and press **⏩** to confirm.
You will see the street list either with the character bar (option 1) or as a selection list (option 2).



Street list with character bar

Option 1: street list with character bar

- ▶ Enter **BROADWAY**. Character entry, using city input as an example (▷ page 283).

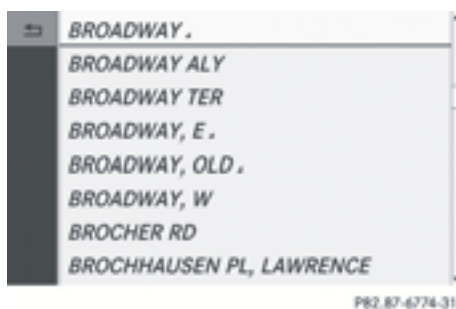

Street list as selection list

Option 2: street list as selection list

- ▶ Select a street by turning **⏪** the COMAND controller and press **⏩** to confirm.
If an entry has the **□** symbol, it is ambiguous. You can select the entry you want from an additional selection list.

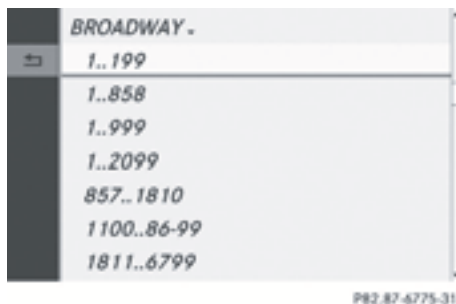

- ▶ Select an entry by turning **⏪** the COMAND controller.
- ▶ Irrespective of the option, press **⏩** to confirm your selection.
The address entry menu appears again. The street has now been entered.

Entering a house number

Entering a house number will delete a previously entered intersection.

- ▶ Call up the address entry menu (▷ page 299).
- ▶ Select **No.** in the address entry menu by turning **⏪** and sliding **↑** the COMAND controller and press **⏩** to confirm.
You will see the house number list either with the character bar (option 1) or as a selection list (option 2).



House number list with character bar

Option 1: house number list with character bar

- ▶ Enter **4** and **0**. Character entry, using city input as an example (▷ page 283).



House number list as selection list

Option 2: house number list as selection list

- ▶ Select an entry by turning **⏪** the COMAND controller.
- ▶ Irrespective of the option, press **⏩** to confirm your selection.
The address entry menu appears again. The house number has now been entered.

Entering the ZIP code, center and intersection

Entering a ZIP code

- ▶ Call up the address entry menu (▷ page 299).
- ▶ Select **ZIP** in the address entry menu by turning **⏪** and sliding **↑** the COMAND controller and press **⏩** to confirm.

You will see the ZIP code list either with the character bar (option 1) or as a selection list (option 2).



List of ZIP codes with character bar

Option 1: ZIP code list with character bar

- ▶ Enter a ZIP code. Character entry, using city input as an example (> page 283).

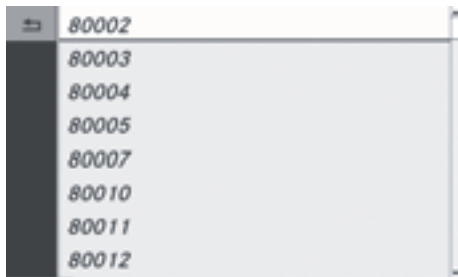

P82.87-6781-31

ZIP code list as selection list

Option 2: ZIP code list as selection list

- ▶ Select the desired ZIP code by turning the COMAND controller.
- ▶ Irrespective of the option, press to confirm your selection. If COMAND is able to assign the ZIP code unambiguously to a specific address, the address entry menu appears again. The ZIP code appears in place of the city's name. If COMAND cannot assign the ZIP code unambiguously to a specific address, the address entry menu also appears again. The ZIP code is automatically entered. You can now enter the street for a more precise location. Only streets in the area covered by the entered ZIP code are available.
- ▶ Start route calculation (> page 303).

Entering a center

Entering a center will, for example, delete a previously entered street.

- ▶ Call up the address entry menu (> page 299).
- ▶ Select **Center** in the address entry menu by turning the COMAND controller and press to confirm.

You will see the center list either with the character bar (option 1) or as a selection list (option 2).



P82.87-5460-31

City center list with character bar

Option 1: center list with character bar

- ▶ Enter a center. Character entry, using city input as an example (> page 283).



P82.87-6777-31

Center list as selection list

Option 2: center list as selection list

- ▶ Select a center by turning the COMAND controller.
- ▶ Irrespective of the option, press to confirm your selection. The address entry menu appears again. The center selected has been entered.
- ▶ Start route calculation (> page 303).

Entering an intersection

- ▶ Call up the address entry menu (> page 299).
- ▶ Select **Intersection** (intersection) in the address entry menu by turning and

sliding the COMAND controller and press to confirm. You will see the intersection list either with the character bar (option 1) or as a selection list (option 2).

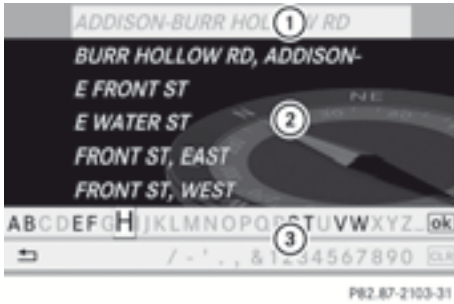

Intersection list with character bar

- ① List entry most closely resembling the characters entered so far
- ② List
- ③ Character bar

Option 1: intersection list with character bar

- ▶ Enter an intersection. Character entry, using city input as an example (▶ page 283).

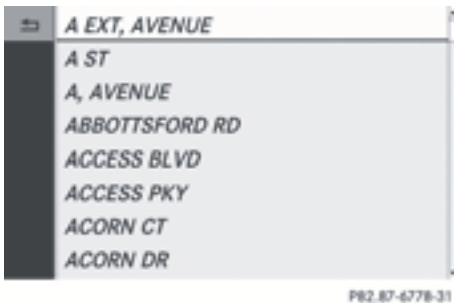

Intersection list as selection list

Option 2: intersection list as selection list

- ▶ Select an intersection by turning the COMAND controller.

- ▶ Irrespective of the option, press to confirm your selection. The address entry menu appears again. The intersection selected has been entered.
- ▶ Start route calculation (▶ page 303).

Starting route calculation



Address entry menu with destination address

- ① Destination address
- ② To start route calculation

You can now have COMAND calculate the route for the address specified or save the address first, e.g. as your home address (My Address) (▶ page 304).

- ▶ Call up the address entry menu (▶ page 299).
- ▶ In the address entry menu, confirm **Start** by pressing .

If no other route has been calculated, route calculation starts immediately (option 1). If another route has already been calculated (route guidance is active), a prompt appears (option 2).

- The **Continue** menu item is displayed instead of **Start** if **Calculate Alternative Routes** is activated in the navigation menu (option 2) (▶ page 327).

Option 1 – no route guidance active: route calculation starts. While route calculation is in progress, an arrow will indicate the direction to your destination. Below this, you will see a message, e.g. **Calculating Fast Route**.

Once the route has been calculated, route guidance begins.

If the vehicle is not on a digitized road, the following is displayed:

- the linear distance to the destination
- the direction to the destination
- the **Off Mapped Road** message

Option 2 – route guidance is already active:

if route guidance is already active, a prompt will appear asking whether you wish to terminate the currently active route guidance.

- ▶ Select **Yes** or **No** and press  to confirm. If you select **Yes**, COMAND will stop route guidance and start route calculation for the new destination.



If you select **No**, COMAND will continue with the active route guidance.

- i** Route calculation takes a certain amount of time. The time depends on the distance from the destination, for example. COMAND calculates the route using the digital map data.

The calculated route can differ from the ideal route, for example because of incomplete map data. Please also refer to the notes about the digital map (▷ page 353).

Entering and saving your home address

You can either enter your home address for the first time (option 1) or edit a previously stored home address (option 2).

- ▶ **Option 1:** enter the address, e.g. a city, street and house number (▷ page 299).
- ▶ Once you have entered the address, select **Save** in the address entry menu by turning  and sliding  the COMAND controller and press  to confirm.

- ▶ Select **Save as "My Address"** and press  to confirm. COMAND stores your home address under the **My Address** entry in the destination memory.

- ▶ **Option 2:** proceed as described under "Option 1".

A prompt appears asking whether the current home address should be overwritten.

- ▶ Select **Yes** and press  to confirm. After selecting **Yes**, the **Saving Procedure/Successful** message appears.



Selecting a destination from the destination memory (e.g. home address)

Introduction

The destination memory always contains an entry named "My Address". You may wish to assign your home address to this entry, for example (▷ page 304), and select it for route guidance. This entry is always located at the top of the list in the destination memory.

- ▶ **To switch to navigation mode:** press the  function button.

- ▶ **To show the menu:** press  the COMAND controller.

- ▶ Select **Destination** in the navigation system menu bar by turning  the COMAND controller and pressing  to confirm.

- ▶ Select **From Memory** and press  to confirm.

You will see the destination memory list either with the character bar (option 1) or as a selection list (option 2).

Option 1: destination memory list with character bar



- ① Character entered by the user
- ② Characters automatically added by the system
- ③ List entry most closely resembling the characters entered so far
- ④ To switch to the selection list
- ⑤ To delete an entry
- ⑥ Characters not currently available
- ⑦ Character bar
- ⑧ Currently selected character
- ⑨ To cancel an entry
- ⑩ Characters currently available

► Enter a destination, e.g. "My Address". Character entry, using city input as an example (▷ page 283).

Option 2: destination memory list as selection list

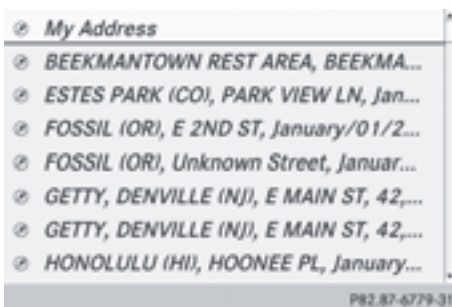

Destination memory list

► Select **My Address** by turning **Ⓜ** the COMAND controller.

► Irrespective of the option, press **Ⓜ** to confirm your selection. The address entry menu appears again. "My address" has been entered.

► **To start route calculation:** select **Start** and press **Ⓜ** to confirm.

Entering a destination from the list of last destinations

► **To switch to navigation mode:** press the **NAVI** function button.

► **To show the menu:** press **Ⓜ** the COMAND controller.

► Select **Destination** in the navigation system menu bar by turning **Ⓜ** the COMAND controller and pressing **Ⓜ** to confirm.



► Select **From Last Destinations** and press **Ⓜ** to confirm.

► Select the desired destination by turning **Ⓜ** the COMAND controller and press **Ⓜ** to confirm. The address entry menu appears again. The destination address selected has been entered.

► **To start route calculation:** select **Start** and press **Ⓜ** to confirm.

Once the route has been calculated, route guidance begins (▷ page 303).

i "Last Destinations" memory (▷ page 341).

Entering a destination using the map

Calling up the map

- ▶ **To switch to navigation mode:** press the **NAVI** function button.
- ▶ **To show the menu:** press **⊕** the COMAND controller.
- ▶ Select **Destination** in the navigation system menu bar by turning **⊕** the COMAND controller and pressing **⊕** to confirm.



- ① Current vehicle position
 - ② Crosshair
 - ③ Details of the crosshair position
 - ④ Map scale selected
- ▶ Select **Using Map** and press **⊕** to confirm. You see the map with the crosshair.

Display ③ depends on the settings selected in "Map information in the display" (▷ page 345). You can see the current street name if the digital map contains the necessary data, You can see the coordinates of the crosshair if the geo-coordinate display is switched on and the GPS signal is strong enough.

Moving the map and selecting the destination

- ▶ **To scroll the map:** slide **←** **→**, **↑** **↓** or **↶** **↷** the COMAND controller.

- ▶ **To set the map scale:** as soon as you turn **⊕** the COMAND controller, the scale bar appears.
- ▶ Turn **⊕** until the desired scale is set. Turning clockwise zooms out from the map; turning counter-clockwise zooms in.

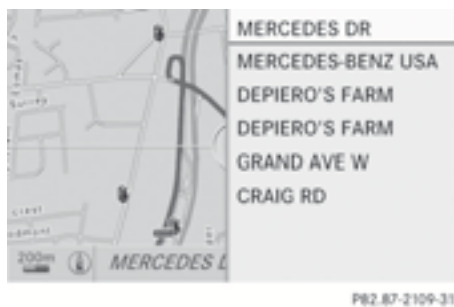

- ▶ **To select a destination:** press **⊕** the COMAND controller once or several times. If COMAND is unable to assign a unique address, you will see either the address entry menu with the destination address or a selection list.
- ▶ Select a destination by turning **⊕** the COMAND controller and press **⊕** to confirm. If the destination is within the limits of the digital map, COMAND attempts to assign the destination to the map. If the destination can be assigned, you will see the address entry menu with the address of the destination. If not, you will see the **Destination From Map** entry.
- ▶ **To start route calculation:** select **Start** and press **⊕** to confirm.

Entering a destination using geo-coordinates

- ▶ **To switch to navigation mode:** press the **NAVI** function button.
- ▶ **To show the menu:** press **⊕** the COMAND controller.
- ▶ Select **Destination** in the navigation system menu bar by turning **⊕** the







COMAND controller and pressing  to confirm.



P82.87-4371-31

- ▶ Select **Using Geo-Coordinates** and press  to confirm. An entry menu appears.

You can now enter the latitude and longitude coordinates.



- ▶ **To change a value:** turn  the COMAND controller.
- ▶ **To move the mark within the line:** slide   the COMAND controller.
- ▶ **To move the mark between the lines:** slide   the COMAND controller.
- ▶ **To confirm the value:** press  the COMAND controller.

- i** If the selected position is outside the digital map, COMAND uses the nearest digitized road for route calculation. You will see the **The coordinates are off the map** message. If the selected position is located over a body of water, you will see the message: **The destination is in a body of water. Please select another destination.**

Intermediate stop

Entering an intermediate stop

- ▶ **To switch to navigation mode:** press the **NAVI** function button.
- ▶ **To show the menu:** press  the COMAND controller.

- ▶ Select **Destination** in the navigation system menu bar by turning  the COMAND controller and pressing  to confirm.

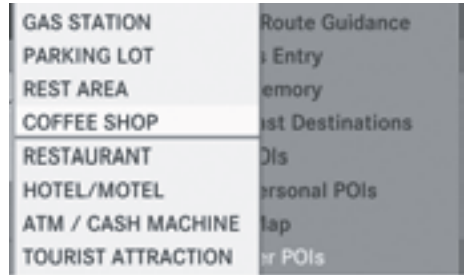

P82.87-4369-31

Intermediate stop categories

Option 1: the route does not have an intermediate stop.

- ▶ Select **Stopover** and press  to confirm.
- ▶ Select a category; see option 2.

Option 2: the route already has an intermediate stop.

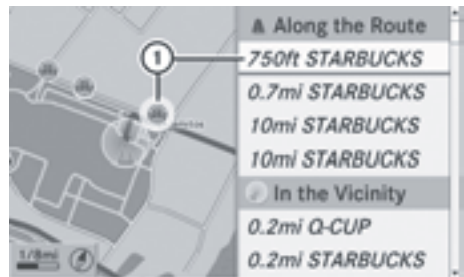

- ▶ Select **Change Stopover** and press  to confirm.



P82.87-4370-31

Example: search results for the chosen category COFFEE SHOP



- ① Highlighted stopover, current distance from vehicle position and name of stopover

- ▶ **To select a category:** select a category by turning  the COMAND controller and press  to confirm.

COMAND first searches in the selected category for destinations along the route. If there are no destinations available there, COMAND searches for destinations within a radius of 60 miles(100 km) of the vehicle position.

If COMAND finds destinations, a list appears on the right-hand side of the display.

The stopovers along the route are displayed at the top of the list, sorted by increasing distance from the vehicle's current position. Below this, you will see the stopovers that COMAND finds in the vicinity of the vehicle's current position.



- ▶ **i** For stopovers that are not located along the calculated route, the linear distance is shown.
- ▶ Select a stopover by turning  the COMAND controller and press  to confirm.
The address entry menu appears, showing the destination address.
- ▶ **To start route calculation:** select **Start** and press .

If COMAND does not find any destinations, you will see a message to this effect.



- ▶ Confirm **OK** by pressing .
- ▶ Select a different category.

Deleting a stopover

If a stopover has already been entered, you can delete it.

- ▶ **To switch to navigation mode:** press the  function button.
- ▶ **To show the menu:** press  the COMAND controller.
- ▶ Select **Destination** in the navigation system menu bar by turning  the

COMAND controller and pressing  to confirm.

- ▶ Select **Stopover** and press .
- ▶ Select **Delete Stopover** and press  to confirm.
COMAND deletes the intermediate stop and recalculates the route to the main destination.





Entering waypoints

Introduction

You can map the route yourself by entering up to two waypoints. The sequence of the waypoints can be changed at any time.

- ▶ **i** An intermediate stop is always between the current position of the vehicle and the first waypoint.

Creating waypoints

- ▶ **To switch to navigation mode:** press the  function button.
- ▶ **To show the menu:** press  the COMAND controller.
- ▶ Select **Destination** in the navigation system menu bar by turning  the COMAND controller and pressing  to confirm.



Waypoint menu without waypoints

- ▶ Select **Intermediate Destinations** and press  to confirm.
The destination is entered in the menu.

- ▶ Confirm the symbol for waypoint 1 by pressing  the COMAND controller.

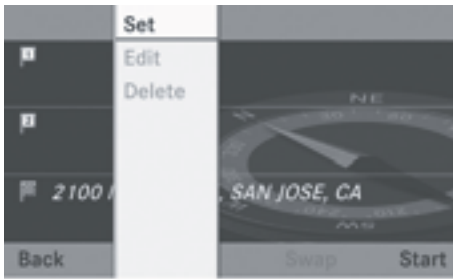

P82.87-4373-31

- ▶ Confirm **Set** with the COMAND controller .
- ▶ Enter the waypoint via one of the following options.



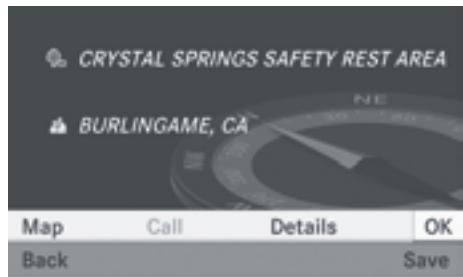

Selection	Action
Address Entry	▶ Enter a destination by address (▷ page 298).
From Memory	▶ Select a destination from the destination memory (▷ page 304).
From Last Destinations	▶ Select a destination from the list of last destinations (▷ page 305).
From POIs	▶ Select a point of interest (▷ page 310).
From Personal POIs	▶ Enter a destination from the personal POIs (▷ page 319).

Selection	Action
Using Map	▶ Enter a destination using the map (▷ page 306).
Using Geo-Coordinates	▶ Enter a destination using the geo-coordinates (▷ page 306).

When the entry is complete, the waypoint appears.



P82.87-4374-31

- ▶ **To accept the waypoint:** confirm **OK** by pressing .
- ▶ **To display the details:** select **Details** by turning  the COMAND controller and press  to confirm.
- ▶ **To make a call:** select **Call** with the COMAND controller and press  to confirm. COMAND switches to the telephone function (▷ page 365).
 - i** This menu item is available if the waypoint has a telephone number and if a mobile phone is connected to COMAND (▷ page 359).
- ▶ **To call up the map:** select **Map** with the COMAND controller and press  to confirm.
- ▶ You can move the map and select the destination.

► **To store the waypoint in the destination memory:** select **Presets** with the COMAND controller and press to confirm. Once you have accepted the waypoint, it is entered in the waypoint menu.



Waypoint menu with two waypoints

Editing waypoints

You can:

- change waypoints
- change the sequence in the waypoint menu
- delete waypoints

To change the sequence, both waypoints must be entered.

► **To change waypoints:** select the symbol for waypoint 1 or 2 in the waypoint menu by turning the COMAND controller and press to confirm.

► Select **Edit** and press to confirm.

► Use one of the destination entry options offered.

► **To change the sequence of the waypoints:** select **Swap** in the waypoint menu by turning the COMAND controller and press to confirm. The entries are swapped.

► **To delete waypoints:** select the symbol for waypoint 1 or 2 in the waypoint menu by turning the COMAND controller and press to confirm.

► Select **Delete** and press to confirm.

i You can use this menu item to delete a waypoint directly after entry.

Accepting waypoints for the route



► Select **Start** in the waypoint menu by turning the COMAND controller and press to confirm. The route is calculated with the entered waypoints.

i The **Continue** menu item is displayed instead of **Start** if **Calculate Alternative Routes** is activated in the navigation menu (option 2) (> page 327).

In the example, there are both waypoints **1** and **2**.





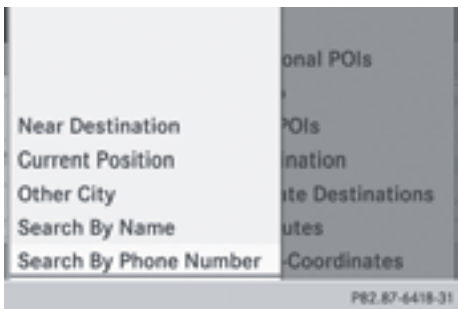

Entering a point of interest

Calling up the points of interest menu









Example: POI menu

POIs are predefined destinations within categories, e.g. a gas station in the **AUTOMOTIVE** category.

- ▶ **To switch on navigation mode:** press the  function button.
- ▶ **To show the menu:** press  the COMAND controller.
- ▶ Select **Destination** in the navigation system menu bar by turning  the COMAND controller and press  to confirm.
- ▶ Select **From POIs** and press  to confirm. A menu appears.
- ▶ Choose one of the options and press  to confirm. Further steps are arranged in a table according to the option selected (> page 312).

Defining the position for the point of interest search

Selection	Characteristic	Instructions
Near Destination	Entry is only possible when route guidance is active.	<ul style="list-style-type: none"> ▶ Select Near Destination from the POI menu and press  to confirm. ▶ Select a POI category (▷ page 313).
Current Position	The system looks for a point of interest in the vicinity of the current vehicle position.	<ul style="list-style-type: none"> ▶ Select Current Position in the POI menu and press  to confirm. ▶ Select a POI category (▷ page 313).
Other City	After entering a city, the system looks for the POI within the city.	<p>Option 1</p> <ul style="list-style-type: none"> ▶ Select Other City in the POI menu and press  to confirm. ▶ If desired, select the state/province (▷ page 299). ▶ Enter the city. Proceed as described in the "Entering a city" section (▷ page 299). ▶ Select a POI category (▷ page 313). <p>Option 2</p> <ul style="list-style-type: none"> ▶ Enter a city in the address entry menu (▷ page 299). ▶ Select POI and press  to confirm. ▶ Select a point of interest category.
Search By Name	You can call up all the points of interest in the digital map or focus your search on the three previously selected positions.	<ul style="list-style-type: none"> ▶ Select Search By Name in the POI menu and press  to confirm. ▶ Select All POIs or one of the three previously selected positions. The point of interest list with character bar appears. ▶ Proceed as described in the "POI list with character bar" section (▷ page 314).
Search By Phone Number	This function gives you access to all points of interest that have a phone number.	<ul style="list-style-type: none"> ▶ Select Search By Phone Number and press  to confirm. You will see a list of phone numbers. ▶ Proceed as described in the "POI list with character bar" section (▷ page 314).

Searching by point of interest category



POI category list

- ▶ Calling up the POI menu
After entering a city, the POI category list appears after choosing the menu item [Near Destination](#), [Current Position](#) or [Other City](#).
- ▶ Select a POI category by turning **⏪** the COMAND controller and press **⏩** to confirm. The **▶** arrow behind an entry shows that other categories are available.

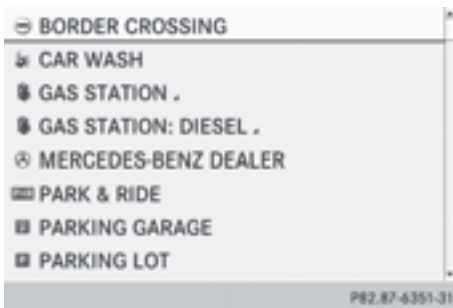

GAS STATION category selected

- ▶ Select an entry and press **⏩** to confirm. The search for points of interest begins in the vicinity of the selected position.



P82.87-6352-31

Point of interest search near the current position (example)

The example shows a search after selection of the [Rest Area](#) entry.

- i** The POI search is canceled when 50 POIs have been found.

COMAND performs a basic search in a surrounding area of approximately 60 mi (100 km).

Once the search is completed, the POI list is displayed.

If COMAND does not find any POIs within the area, the search radius expands to approximately 125 mi (200 km).

If COMAND finds one POI within this radius, it finishes the search.

Point of interest list

Introduction

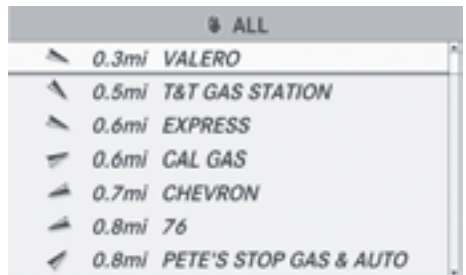

P82.87-6353-31

Point of interest list (example)

The POI list displays the search results for the category in the vicinity of the selected position.

The search results display the following information:

- an arrow that shows the linear direction to the point of interest
- the linear distance to the point of interest
- the name of the point of interest

i The arrow and linear distance to the destination are not visible if you have entered a POI after entering another city. The arrow is also not shown when searching for a POI in the vicinity of the destination.

Depending on the POI selected, COMAND uses different reference points in determining the linear distance to the destination:

- vicinity of current position: the linear distance is the distance of the point of interest from the current vehicle position.
- vicinity of destination: the linear distance is the distance from the destination entered to the point of interest.

Selecting a point of interest

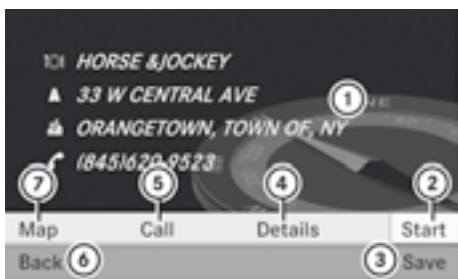

- ① Point of interest with address
- ② To start route calculation
- ③ To store an address in the destination memory
- ④ To display details
- ⑤ To make a call (when available)
- ⑥ To cancel selection
- ⑦ To display a point of interest's position on the map

The example has been selected in the **BAR & RESTAURANT** POI category. Further information on searching via POI categories (▷ page 313).

- ▶ Select the POI in the POI list by turning **⏪** the COMAND controller and press **⏩** to confirm.

The complete address of the point of interest selected is shown.

- ▶ **To start route calculation:** select **Start**② and press **⏩** to confirm.
- ▶ **To store an address in the destination memory:** select **Save**③ and press **⏩** to confirm. You can now select storing options (▷ page 340).
- ▶ **To show the detailed view:** select **Details**④ and press **⏩** to confirm.
- ▶ **To make a call:** select **Call**⑤ and press **⏩** to confirm. COMAND switches to telephone mode (▷ page 364).

i This menu item is available if the POI has a telephone number and a mobile phone is connected to COMAND (▷ page 359).

- ▶ **To call up the map:** select **Map**⑦ and press **⏩** to confirm.
- ▶ You can move the map and select the destination (▷ page 306).

Point of interest list with character bar



Search by name in the vicinity of the destination (example)

If you have selected **Search By Name** in the POI menu and then defined the position for

the search, the POI list with character bar appears (▷ page 312).

Depending on your selection, you can select all available points of interest on the digital map or the points of interest in the vicinity of the selected position.

- ▶ Proceed as described in "Searching for a phone book entry" (▷ page 369). If COMAND can assign the characters entered to one entry unambiguously, the address entry appears automatically.

- ▶ **To start route calculation:** select **Start** and press to confirm.

ZAGAT® survey service



P82.87-4830-31

The Z icon before a search result shows that a ZAGAT® rating is available for this entry.

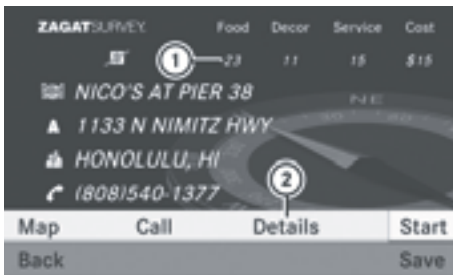

P82.87-4831-31

- ① ZAGAT ratings
- ② To display details
- ▶ Select an entry with the "Z" icon by turning the COMAND controller and press to confirm. The ZAGAT evaluations appear.

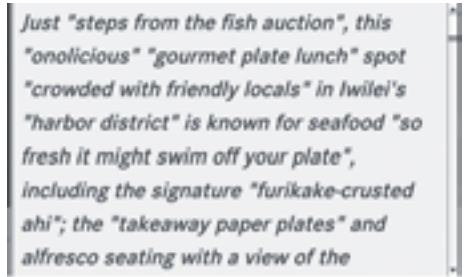

P82.87-4832-31

ZAGAT example description

- ▶ **To show the information:** select **Details** and press to confirm.

Selecting a point of interest using the map

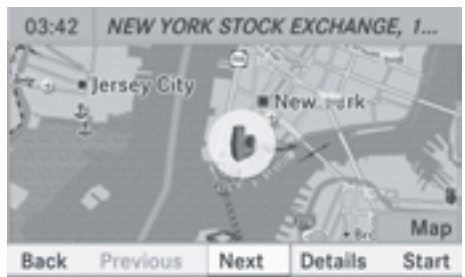

P82.87-4364-31

Point of interest on the map

You can select points of interest that are available in the selected (visible) section of the map. The POI is highlighted on the map, you will see further information on the upper edge of the display.







- ▶ **To switch on navigation mode:** press the **NAVI** function button.
- ▶ **To show the menu:** press the COMAND controller.

- ▶ Select **Guide** in the navigation system menu bar by turning the COMAND controller and press to confirm. If points of interest are available: Depending on the map scale selected, point of interest icons appear on the map. The scale at which the icons are displayed

on the map varies according to the icon. You can select the icons that you want COMAND to display (▷ page 344).

If no points of interest are available, you will see a message to this effect.

i You also see this message if you have selected the **No Symbols** menu item under "Map display" (▷ page 344).

- ▶ **To confirm the message:** press  the COMAND controller.
- ▶ **To select a POI:** select **Next** or **Previous** and press  to confirm.
- ▶ **To show details for the selection:** select **Details** and press  to confirm.
- ▶ **To change to the map:** slide  the COMAND controller. You can move the map and select the map section.
- ▶ **To start route calculation:** select **Start** and press  to confirm. A prompt appears asking whether the point of interest should be used as the destination.
- ▶ Select **Yes** or **No** and press  to confirm. If you select **Yes**, route guidance starts. If you select **No**, you can choose a new point of interest.

i **Continue** is displayed instead of **Start** when **Calculate Alternative Routes** is activated in the navigation menu (▷ page 327).



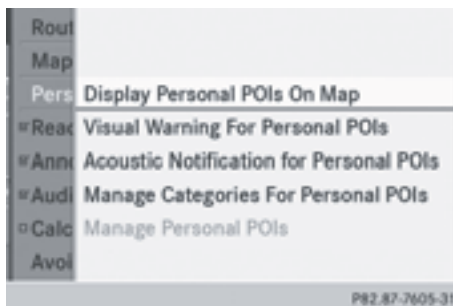

Personal points of interest

Settings

Calling up the "Personal POIs" menu



"Personal POIs" menu

- ▶ **To switch on navigation mode:** press the **NAVI** function button.
- ▶ **To show the menu:** press  the COMAND controller.
- ▶ Select **Navi** in the main function bar by sliding  and turning  the COMAND controller and press  to confirm.
- ▶ Select **Personal POIs** and press  to confirm.

Displaying personal POIs on the map

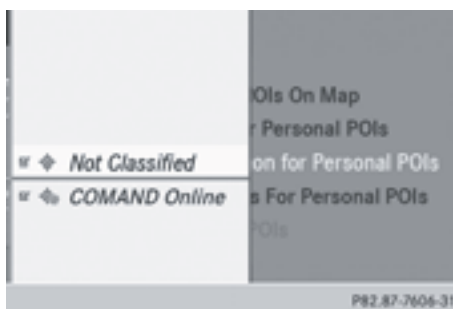

The personal POIs are shown on the map with an icon according to their category.

- ▶ Call up the "Personal POIs" menu (▷ page 316).
- ▶ Select **Display Personal POIs On Map** in the menu and press to confirm. You can select different categories.

Selection	Explanation
<input type="checkbox"/> Not Classified	Standard entry for personal POIs
<input type="checkbox"/> COMAND	Personal POIs (destinations, routes) that you have imported via the online function (▷ page 392).

If you have created your own categories (e.g. "Fishing", "Hotels"), they are also displayed (▷ page 317).

- ▶ Select a category and press to confirm. The icon display is switched on or off , depending on the previous status.
- i** The icons will be displayed in the following map scales:
 - 1/16 mile (50 m)
 - 1/8 mile (100 m)
 - 1/4 mile (200 m)
 - 1/2 mile (500 m)

Visual warning for personal POIs



Example: visual warning for a personal POI

If the vehicle is approaching a personal POI, this is highlighted on the map. The display for

the corresponding category must be activated for this.

- ▶ Call up the "Personal POIs" menu (▷ page 316).
- ▶ In the "Personal POIs" menu, select **Visual Warning For Personal POIs** and press to confirm. The menu displays the available categories.
- ▶ Select a category and press to confirm. This will switch the visual warning for all personal POIs of this category on or off , depending on the previous setting.

Acoustic notification for personal POIs

A gong sounds when the vehicle is approaching a personal POI. The function for the corresponding category must be activated for this.





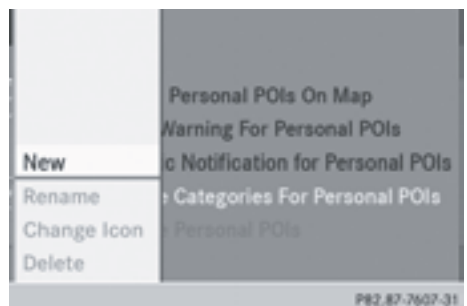



- ▶ Call up the "Personal POIs" menu (▷ page 316).
- ▶ In the "Personal POIs" menu, select **Acoustic Notification For Personal POIs** and press to confirm. The menu displays the available categories.
- ▶ Select a category and press to confirm. This will switch the acoustic notification for all personal POIs of this category on or off , depending on the previous setting.

Creating categories for personal POIs





- ▶ Call up the "Personal POIs" menu (▷ page 316).
- ▶ In the "Personal POIs" menu, select **Manage Categories For Personal POIs** and press  to confirm.



- ▶ **To create a new category:** select **New** and press  to confirm.
 - ▶ Enter the name of the category. Character entry (▷ page 281).
 - ▶ Select the  icon and press  to confirm.
A list with icons appears. You can assign an icon to the category.
 - ▶ Select an symbol by turning   the COMAND controller and press  to confirm.
You have created a new category with a name and icon. This category appears when selecting the display on the map or when selecting the destination.
 - ▶ **To rename a category, to change an icon:** select **Rename** or **Change Icon** and press  to confirm.
 - ▶ Proceed as described under "To create a new category".
 - ▶ **To delete a category:** select **Delete** and press  to confirm.
A prompt appears asking whether the category should be deleted.
- i** If you delete a category, all points of interest of this category are also deleted.

- ▶ Select **Yes** and press  to confirm.
If you select **Yes**, the category will be deleted.
- ▶ If you select **No**, the process will be canceled.

Managing personal POIs

- ▶ Call up the "Personal POIs" menu (▷ page 316).
- ▶ Select **Manage Personal POIs** in the menu and press  to confirm.
- ▶ Select **Not Classified**, **COMAND** or your own category and press  to confirm.
- ▶ Select a personal POI and press  to confirm.
The personal point of interest is displayed.

Other functions:



- renaming (▷ page 319)
- changing the category (▷ page 319)
- deleting (▷ page 319)

Saving personal POIs

There are three ways to save personal points of interest. You must insert an SD memory card to do so. The **No Memory Card** message otherwise appears.

Personal POIs and routes are saved on the memory card in the same data format in which the geographical data is stored. This format is based on the open GPX (GPS Exchange) format.

Option 1

- ▶ Insert the SD memory card (▷ page 424).
- ▶ **To switch on navigation mode:** press the  function button.
- ▶ Hide the menu to display the map in full screen mode (▷ page 296).
- ▶ Press  the COMAND controller for longer than two seconds.
The current position of the vehicle is saved as a personal POI on the SD memory card in the **Not Classified** category.

- i** The crosshair position is saved in the scrolling map function (▷ page 343).

Option 2

- ▶ Insert the SD memory card (▷ page 424).
- ▶ **To switch on navigation mode:** press the **NAVI** function button.
- ▶ **To show the menu:** press **☺** the COMAND controller.
- ▶ Select **Position** in the navigation system menu bar by turning **⏪** the COMAND controller and press **☺** to confirm.
- ▶ Select **Save Position As Personal POI** or **Save Crosshair Pos. As Personal POI** ("Move map" function active) and press **☺** to confirm. The list of personal categories appears.
- ▶ Select a category and press **☺** to confirm.
- ▶ Name for the personal point of interest. Character entry (▷ page 281).

Option 3

- ▶ Insert the SD memory card (▷ page 424).
- ▶ **To switch on navigation mode:** press the **NAVI** function button.
- ▶ Call up the address entry menu (▷ page 299).
- ▶ Select **Save** from the address entry menu and press **☺** to confirm.
- ▶ Select **Save As Personal POI** and press **☺** to confirm.
- ▶ Select a category.
- ▶ Enter the name. The current address is saved as a personal point of interest on the SD memory card.

Importing personal POIs via the online function

You can import personal POIs (destinations, routes) via the online function (▷ page 392). When importing, you can choose whether to write files to the SD memory card or to file them in the address book. The imported

personal POIs have their own icon and are filed in the **COMAND** category.

Selecting as the destination



- ▶ Insert the SD memory card (▷ page 424).
- ▶ **To switch on navigation mode:** press the **NAVI** function button.
- ▶ **To show the menu:** press **☺** the COMAND controller.
- ▶ Select **Destination** in the navigation system menu bar by turning **⏪** the COMAND controller and press **☺** to confirm.
- ▶ Select **From Personal POIs** and press **☺** to confirm. The categories of personal POIs appear.

Selection	Explanation
Not Classified	Standard entry for personal points of interest.
COMAND	This function is not available in the USA and Canada.
Coffee Shops	Icon and category that you have created yourself (▷ page 317).



In the example, the **Coffee Shops** category is selected.

The personal points of interest for this category are shown.



- ▶ Select a personal POI and press to confirm.
- ▶ **To rename a personal POI:** select **Rename** and press to confirm.
- ▶ **To change the category:** select **Change Category** and press to confirm.
- ▶ **To change to the map:** select **Map** and press to confirm.
The position of the personal point of interest is shown in the map.
- i** An icon is displayed according to the "Displaying personal POIs on the map" setting (▷ page 316).
- ▶ **To start route calculation:** select **Start** and press to confirm.
If route guidance has been activated, a prompt will appear asking whether you wish to accept the personal point of interest as the destination.

If route guidance has not been activated, route calculation for the personal point of interest will start immediately.

- ▶ Select **Yes** or **No** and press to confirm.
If you select **Yes**, the personal POI is accepted as the destination.
If you select **No**, the process will be canceled.
- ▶ **To make a call:** select **Call** and press to confirm. COMAND switches to telephone mode (▷ page 366).
- i** **Call** is available if the personal POI has a phone number and a mobile phone is connected to COMAND (▷ page 359).
- ▶ **To delete a personal POI:** select **Delete** and press to confirm.
A prompt appears asking whether you wish to delete the point of interest.
- ▶ Select **Yes** or **No** and press to confirm.
If you select **Yes**, the personal POI is deleted.
If you select **No**, the process will be canceled.

Search & Send

Notes

- i** To use Search & Send, your vehicle needs to be equipped with mbrace, a navigation system and a valid mbrace subscription.

Search & Send is a service assisting you in entering destinations for the navigation system. This mbrace service can send a destination address directly from the Google Maps® website to the navigation system of your vehicle.

Selecting and sending a destination address

Please also refer to the notes about address entry online: **maps.google.com**.

- ▶ Call up the **maps.google.com** website and destination address in the address entry field.
- ▶ Click the corresponding button to send the destination address to the e-mail address registered with mbrace.
- ▶ Enter the e-mail address you specified when setting up your mbrace account into the corresponding field in the "Send" dialog window.
- ▶ Click "Send".

Calling up destination addresses



- ▶ Press the  mbrace information button. Downloading of the destination address to the navigation system of your vehicle begins.
- i** If you have sent more than one destination address to your vehicle's navigation system, you will need to call up the information individually for every address to be downloaded.



- ▶ Select **Yes** when the prompt for starting the navigation system is shown. The window

for starting the navigation system appears (> page 303).

- ▶ Select **Start**.
- or
- ▶ Select **No** to store the downloaded destination in the destination memory for later use.
- i** The destination addresses are downloaded in the same order as they are sent.

If you own several Mercedes-Benz vehicles equipped with an mbrace subscriber account: each destination address can be downloaded by each vehicle associated with the e-mail address registered for your mbrace account.

Route guidance

General notes

⚠ WARNING

- COMAND calculates the route to the destination without taking account of the following, for example:
- traffic lights
 - stop and give way signs
 - merging lanes
 - parking or stopping in a no parking/no stopping zone
 - other road and traffic rules and regulations
 - narrow bridges

COMAND can give incorrect navigation commands if the actual street/traffic situation does not correspond with the digital map's data. For example, a route may have been diverted or the direction of a one-way street may have changed.

For this reason, you must always observe road and traffic rules and regulations during your journey. Road and traffic rules and regulations always have priority over the system's driving recommendations.

Route guidance begins once a route has been calculated (▷ page 303).

COMAND guides you to your destination by means of navigation announcements in the form of audible navigation announcements and route guidance displays.

The route guidance displays can only be seen if the display is switched to navigation mode.

If you do not follow the navigation announcements or if you leave the calculated route, COMAND automatically calculates a new route to the destination.

If the digital map contains the corresponding information, the following applies:

- when selecting a route, COMAND tries to avoid roads that only have limited access, e.g. roads closed to through traffic.
- roads that have time restrictions (e.g. closed on Sundays and public holidays) are considered for route guidance on days when they are open. For this purpose, the relevant times must be correctly stored in the database.

Displays during route guidance

Change of direction

Changes of direction have three phases:

- preparation phase
- announcement phase
- change-of-direction phase



Example: preparation phase

- ① Next road
- ② Point at which the change of direction takes place (light blue dot)
- ③ Current vehicle position (the tip of the triangle indicates the vehicle's direction of travel)
- ④ Current road

Display ④ depends on the setting selected for "Map information in the display" (▷ page 345).

COMAND prepares you for the upcoming change of direction. Based on the example display below, the change of direction is announced by the **Prepare to turn right** message. You see the full-screen map.

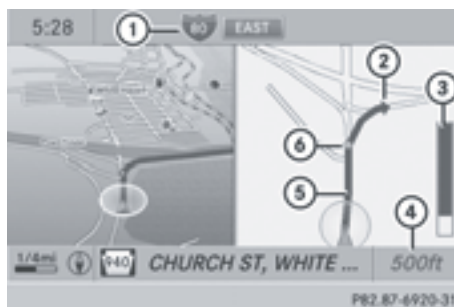

Example: announcement phase

- ① Next road
- ② Change of direction (turn right here)
- ③ Graphic representation of the distance to the next change of direction
- ④ Distance to the next change of direction

- ⑤ Route (highlighted in blue, shown in both the left and right displays)
- ⑥ Point at which the change of direction takes place (light blue dot, shown in both the left and right displays)
- ① The filled-in section of visual display for distance ③ gets shorter the nearer you get to the announced change of direction.

COMAND announces the imminent change of direction. Based on the example display below, the change of direction is announced beforehand by the message: **Please turn right in 500 ft. and follow the <road name>**.

The distance announced before the next change of direction depends on the type of road and its permissible maximum speed. The display is now split into two sectors. In the left half, you see the normal map view. The right half shows an enlarged section of the area around the intersection (Crossing Zoom) or a 3D image of the road's course with the route indicating the next maneuver.

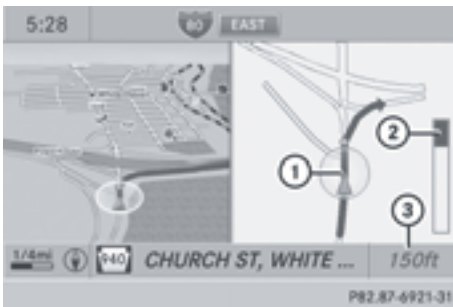

Example: change-of-direction phase

- ① Current vehicle position (the tip of the triangle indicates the vehicle's direction of travel)
- ② Graphic representation of the distance to the next change of direction
- ③ Distance to the next change of direction

COMAND announces the imminent change of direction.

In the example, the **Now turn right** announcement is made 150 ft. before the change of direction.

The display is split into two halves, as in the announcement phase.

Once the change of direction is completed, COMAND automatically switches back to full-screen display.

Example of a display without changes of direction



- ① Route (highlighted in blue)
- ② Current vehicle position
- ③ Current road
- ④ Map orientation selected
- ⑤ Map scale selected

Lane recommendations

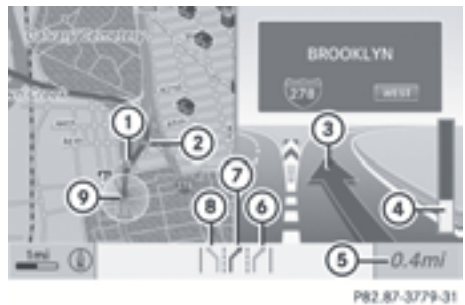

Example: lane recommendations

- ① Point of the next change of direction
- ② Point of the change of direction after next
- ③ Next change of direction (in this case, turn off to the right)

- ④ Graphic representation of the distance to the next change of direction
- ⑤ Distance to the next change of direction
- ⑥ Possible lane (light blue)
- ⑦ Recommended lane (dark blue)
- ⑧ Lane not recommended (gray)
- ⑨ Current vehicle position: the tip of the triangle indicates the vehicle's direction of travel

On multi-lane roads, COMAND can display lane recommendations for the next change of direction. The corresponding data must be available in the digital map.

COMAND displays lane recommendation ⑦, based on the next two changes of direction. The number of lanes applies to the point at which the next change of direction is required.

- i** The multifunction display also shows lane recommendations. Only the recommended lanes are displayed here (> page 210).

Display and description of lane recommendations

Lane	Day design	Night design
Recommended lane In this lane, you will be able to complete the next two changes of direction without changing lanes.	Dark blue	Light blue
Possible lane In this lane, you will only be able to complete the next change of direction without changing lanes.	Light blue	Dark blue
Lane not recommended In this lane, you will not be able to complete the next change of direction without changing lanes.	Gray	Gray

- i** The colors used in the lane recommendation display vary depending on whether day or night design is switched on.

HOV or carpool lanes

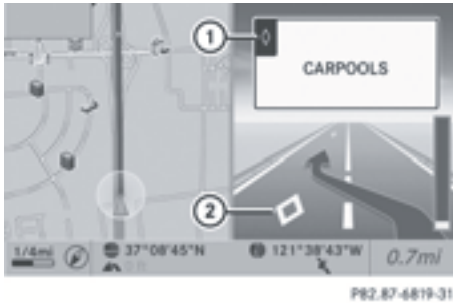

- ① HOV symbol on the road sign
- ② HOV symbol on the car pool lane

A route may be calculated taking the use of HOV or carpool lanes into account. You can use HOV or carpool lanes depending on the number of persons in the vehicle as well as the local and time limitation conditions.

- i** This information is stored in the map data.
- i** You can enter the number of people in the vehicle (▷ page 297). In this section, you can also find more information on HOV or carpool lanes.

If the system guides you to or from a carpool lane, COMAND provides you with visual and acoustic driving instructions.

Navigation announcements

Repeating navigation announcements

⚠ WARNING

Navigation announcements are intended to direct you while driving without diverting your attention from the road and driving.

Please always use this feature instead of consulting the map display for directions. Looking at the icons or map display can distract you from traffic conditions and driving, and increase the risk of an accident.

If you have missed an announcement, you can call up the current announcement at any time. However, no announcements are made during a phone call.

- ▶ **To show the menu:** press the COMAND controller.
- ▶ Select **RPT** in the navigation system menu bar by turning the COMAND controller and press to confirm.

Switching navigation announcements on/off

- ▶ **To switch off:** press the button during an announcement. You will briefly see the message: **The driving instructions have been muted.**
- ▶ **To switch on:** press the COMAND controller.
- ▶ Select **RPT** in the navigation system menu bar by turning the COMAND controller and press to confirm.
- i** COMAND automatically switches the navigation announcements back on when:
 - you have a new route calculated.
 - you switch COMAND on again or start the engine.

Reducing volume during a navigation announcement

The volume of an active audio or video source can be automatically reduced during a navigation announcement.

- ▶ Select **Navi** in the main function bar by sliding and turning the COMAND controller and press to confirm.
- ▶ Select **Audio Fadeout** and press to confirm. The function is switched on or off , depending on the previous status.





Setting the volume manually

- ▶ Adjust the volume using the control knob during a navigation announcement.
- or
- ▶ Select **RPT** in the map view with the menu shown and adjust the volume using the control knob.

Announcing street names





If the function is switched on, the name of the street which you are turning into is announced.

Announcements are not made in the chosen language in all countries. They are made when relevant street names for the selected language are available in the database.

- ▶ **To switch on navigation mode:** press the **NAVI** function button.
- ▶ **To show the menu:** press  the COMAND controller.
- ▶ Select **Navi** in the main function bar by sliding  the COMAND controller and press  to confirm.
- ▶ Select **Announce Street Names** and press  to confirm.
The function is switched on or off , depending on the previous status.

Ending route guidance

Canceling or continuing route guidance

- ▶ **To switch on navigation mode:** press the **NAVI** function button.
 - ▶ **To show the menu:** press  the COMAND controller.
 - ▶ Select **Destination** in the navigation system menu bar by turning  the COMAND controller and pressing  to confirm.
 - ▶ **To cancel route guidance:** select **Cancel Route Guidance** and press  to confirm.
- or
- ▶ **To continue route guidance:** select **Continue Route Guidance** and press  to confirm.
COMAND calculates the route.

Destination or area of destination reached









When you reach your destination, COMAND displays a checkered flag and route guidance is automatically ended.

If the destination is not in close proximity to a digitized street, the **Area of destination reached** message appears when the destination is reached.

Influencing route guidance

Avoiding a section of the route blocked by a traffic jam

This function blocks a section of the route ahead of you. You can set the length of the blocked route section. If possible, COMAND calculates a detour around the blocked section of the route.

- ▶ **To switch on navigation mode:** press the **NAVI** function button.
 - ▶ **To show the menu:** press  the COMAND controller.
 - ▶ Select **Route** in the navigation system menu bar by turning  the COMAND controller and press  to confirm.
 - ▶ Select **Detour** and press  to confirm.
 - ▶ **To block a section of the route:** select **Longer** or **Shorter** repeatedly and confirm using  until the desired section has been selected.
-  The total length of the section that can be blocked is defined by the digital map. The menu items are available accordingly.
- ▶ **To start route calculation:** select **Start** and press  to confirm.
 - ▶ **To delete the blocked section:** select **Delete** while the message is shown and press  to confirm.
COMAND calculates the route without the block.





Selecting an alternative route

With the "Alternative route" function, routes other than the original one can be calculated. Routes 1 to 3 are calculated with the current settings for the route type and route options and are shown with a dark blue line (▷ page 297).

Route 4 is the economic route (eco route) and is shown with a green line.

On the right-hand side, you will see information on the currently selected alternative route, e.g. distance, estimated remaining driving time and estimated time of arrival. Route sections used (e.g. freeways, tunnels) are displayed as symbols.



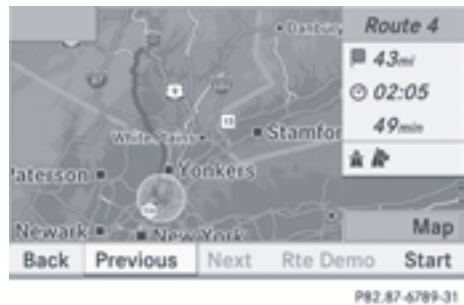

Option 1:

- ▶ **To switch on navigation mode:** press the **NAVI** function button.
- ▶ **To show the menu:** press  the COMAND controller.
- ▶ Select **Route** in the navigation system menu bar by turning  the COMAND controller and press  to confirm.
- ▶ Select **Alternative Route** and press  to confirm.



Examples for route 1 (above) and route 4 (eco route)

Option 2:

- ▶ **To switch on navigation mode:** press the **NAVI** function button.
- ▶ **To show the menu:** press  the COMAND controller.
- ▶ Select **Nav** in the main function bar by sliding  the COMAND controller and press  to confirm.
- ▶ Select **Calculate Alternative Routes** and press  to confirm.
The function is switched on or off , depending on the previous status.
Function is activated: alternative routes are calculated directly after the destination is entered.

Menu functions

- ▶ **To select the next or previous alternative route:** select **Next** or **Previous** and press  to confirm.

- ▶ **To start route guidance using the selected alternative route:** select **Start** and press to confirm. COMAND begins route guidance on the selected alternative route.

Route information

Displaying destination information

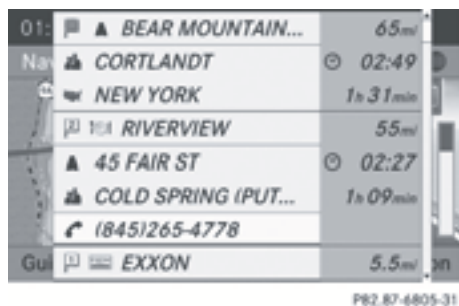

Example: destination information

The example shows information on distance, estimated time of arrival and estimated remaining driving time to the destination and two way points.

- ▶ **To switch on navigation mode:** press the **NAVI** function button.
- ▶ **To show the menu:** press the COMAND controller.
- ▶ Select **Route** in the navigation system menu bar by turning the COMAND controller and press to confirm.
- ▶ Select **Destination Information** and press to confirm. Destination information is displayed.
- ▶ **To call up further destination information:** turn the COMAND controller.
- ▶ **To close the destination information:** slide the COMAND controller or press the **BACK** back button.

i You can display destination information for the destination, for both waypoints and

for the intermediate stop, if they are part of the route.

If a mobile phone is connected to COMAND and a phone number is included in the destination information, you can call it (page 359).

Route overview

You can use the route overview to move along the active route section by section and view information and details about each section of the route.

At the top of the display, you will see information about the highlighted route section, for example the distance to be driven on the road and road designation. The highlighted route section is marked in white with a red border on the map.

- ▶ **To switch on navigation mode:** press the **NAVI** function button.
- ▶ **To show the menu:** press the COMAND controller.
- ▶ Select **Route** in the navigation system menu bar by turning the COMAND controller and press to confirm.
- ▶ Select **Route Browser** and press to confirm.
- ▶ **To view the next or previous route section:** select **Next** or **Previous** and press to confirm.
 - i** If the first or last route section is highlighted, you cannot select **Previous** or **Next**.
- ▶ **To zoom in or out of the map:** select or and press to confirm.
- ▶ **To close the route overview:** select **Back** and press to confirm.

Route demonstration



P82.87-6817-31

You can see the route before starting your journey. This function is only available when the vehicle is stationary.

- ▶ **To switch on navigation mode:** press the **NAVI** function button.
- ▶ **To show the menu:** press the COMAND controller.
- ▶ Select **Route** in the navigation system menu bar by turning the COMAND controller and press to confirm.
- ▶ Select **Route Demonstration** and press to confirm.
The map with the crosshair appears.
- ▶ **To get to the destination:** press to confirm the highlighted symbol.
- ▶ **To stop the route demonstration:** confirm the symbol by pressing .

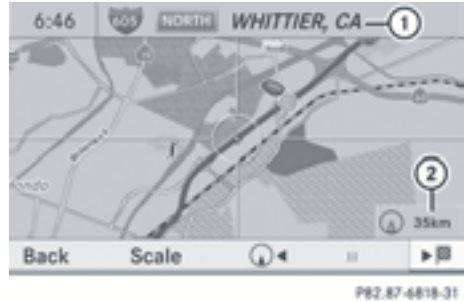

P82.87-6818-31

Example: route demonstration stopped

- ① Road name and city display when route demonstration has been stopped
 - ② Distance of the crosshair from current vehicle position
- ▶ **To get to the current vehicle position:** press to confirm the symbol for the current vehicle position.
 - ▶ **To change the map scale:** select **Scale** and press to confirm.
The scale bar appears.
 - ▶ Turn the COMAND controller and press to confirm.

Recording the route

Notes

If you have activated COMAND and the SD memory card has been inserted, you should not take it out of the slot.



When you record a route, COMAND uses so-called support points and displays the route as a series of lines. If the route is then calculated, COMAND attempts to align the recorded route with the digital map.

The support points of the route may not be on a digitized road.

This is often the case for routes that have been calculated using map data from other sources.

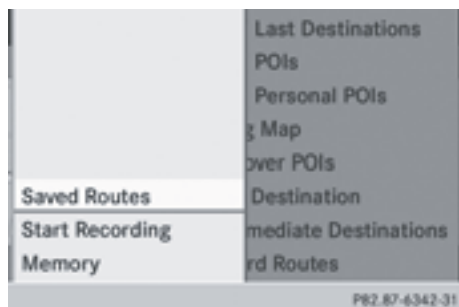

Calling up the Routes menu





- ▶ Insert the SD memory card (▷ page 424).
- ▶ **To switch on navigation mode:** press the **[NAVI]** function button.
- ▶ **To show the menu:** press  the COMAND controller.
- ▶ Select **Destination** in the navigation system menu bar by turning  the COMAND controller and pressing  to confirm.
- ▶ Select **Routes**.

Starting/ending recording





- ▶ Call up the "Routes" menu (▷ page 330).
- ▶ **To start recording:** select **Start Recording** in the "Routes" menu by turning  the COMAND controller and press  to confirm.
During the recording, the recorded route is shown behind the current vehicle position with gray strokes (symbol for tire tracks).
- ▶ **To end recording:** select **Stop Recording** in the "Routes" menu by turning



 the COMAND controller and press  to confirm.

Displaying and editing the recorded route



- ▶ Insert the SD memory card (▷ page 424).
- ▶ Call up the "Routes" menu (▷ page 330).
- ▶ Select **List** in the "Routes" menu by turning  the COMAND controller and press  to confirm.
Previously recorded routes are displayed.



- ▶ Select a route and press  to confirm.
The map appears with a menu. The recorded route is shown in the map with a blue dotted line.
- ▶ **Demonstration of the route on the map:** select **Demo** by turning  the COMAND controller and press  to confirm.
The map with the crosshair appears.
- ▶ Proceed as described in the "Route demonstration" section (▷ page 329).

- ▶ **To begin route calculation:** select **Start** in the menu by turning **[Ⓢ]** the COMAND controller and press **[Ⓢ]** to confirm. COMAND attempts to align the recorded route with the digital map.



Changing route names and icons

- ▶ Select **Edit** in the menu by turning **[Ⓢ]** the COMAND controller and press **[Ⓢ]** to confirm.
- ▶ **To change the route name:** select **Rename** and press **[Ⓢ]** to confirm.
 - ① The name cannot be changed while the vehicle is in motion.
- ▶ **To change the icon:** select **Change Icon** and press **[Ⓢ]** to confirm.
- ▶ Information for both entries can be found under "Managing categories for personal POIs" (▶ page 317).

To change direction for route calculation: you can set the icon for the route to the starting point or to the destination, thereby changing the direction for route calculation.

During route calculation, one-way streets or turn restrictions, for example, are taken into account. Therefore, the outward and return routes may differ from each other.

- ▶ Select **Swap** in the menu by turning **[Ⓢ]** the COMAND controller and press **[Ⓢ]** to confirm.

- ▶ **To delete a route:** select **Delete** in the menu by turning **[Ⓢ]** the COMAND controller and press **[Ⓢ]** to confirm. A prompt appears asking whether the route should be deleted.
 - ▶ Select **Yes** or **No** and press **[Ⓢ]** to confirm. If you select **Yes**, the route will be deleted. If you select **No**, the process will be canceled.

Scanning the memory

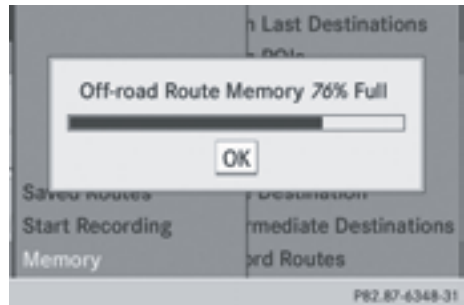

The SD memory card is inserted.

- ▶ Call up the "Routes" menu (▶ page 330).
- ▶ Select **Memory** in the "Routes" menu by turning **[Ⓢ]** the COMAND controller and press **[Ⓢ]** to confirm (▶ page 329). The route memory is displayed.

Off-road and off-map

Important safety note

⚠ WARNING

The COMAND navigation system may direct you to off-road routes that your vehicle may not be capable of traversing through without damaging your tires, wheels or vehicle. It is the driver's sole responsibility to determine the suitability of the route. Off-road routes may be of varying conditions and their appropriateness for use may be affected by various factors such as time of day, time of year and immediate weather conditions that cannot be judged or taken into consideration by the COMAND system.

Route guidance to a destination that is not on a digitized road



Example: route guidance to an off-road destination

- ① Off-road destination
- ② Off-road route section (dashed blue)
- ③ Current vehicle position (the tip of the triangle indicates the vehicle's direction of travel)
- ④ Off-road (if available)

COMAND can guide you to destinations which are within the area of the digital map, but which are not themselves recorded on the map.

These destinations are known as off-road destinations, which you can enter using the map, for example. In these cases, COMAND guides you for as long as possible with navigation announcements and displays on roads known to the system.

If the vehicle reaches an area which is not part of the digital map, the display appears as a split-screen view. On the right, an arrow appears that points to off-road destination ①. You will hear the announcement: "Please follow the arrow on the display". As the vehicle approaches the destination, the **Area of destination reached** message appears.

Route guidance from an off-road location to a destination

If the vehicle position is within the area covered by the digital map, but the map does not contain any information about that location, the vehicle is in an off-road location.

COMAND is also able to guide you to a destination even from an off-road location.

At the start of the route guidance, you will see the **Off Mapped Road** message, an arrow and the distance to the destination. The arrow shows the compass heading to the actual destination.

The route is highlighted blue, starting from the last recognized street the vehicle was on before it left the map.

As soon as the vehicle is back on a road known to the system, route guidance continues in the usual way.

Route guidance from an off-map location to a destination

If the vehicle position is outside the area covered by the digital map, then the vehicle is in an off-map location. COMAND is also able to guide you to a destination even from an off-map location.

At the start of the route guidance, you will see the **Off Mapped Road** message, an arrow and the distance to the destination. The direction arrow shows the compass heading to the destination.

The route is highlighted blue from the nearest road known to the system.

As soon as the vehicle is back on a road known to the system, route guidance continues in the usual way.

Off-road during route guidance

Due to roadworks, for example, there may be differences between the data on the digital map and the actual course of the road.

In such cases, the system will temporarily be unable to locate the vehicle position on the digital map. The vehicle is therefore in an off-road position.

In the display, you will see the **Off Mapped Road** message, an arrow and the distance to the destination. The direction arrow shows the compass heading to the destination.

As soon as the system can assign the vehicle position to the map again, route guidance continues in the usual way.

Traffic reports

Conditions

- ❗ This function is currently not available for Canada.

To receive real-time traffic reports via satellite radio, you require:

- optionally available satellite radio equipment
- a subscription to SIRIUS XM Satellite Radio Traffic Message Service

Further information on satellite radio (▷ page 416).

COMAND can receive traffic reports via satellite radio and take account of these for route guidance in the navigation system. Received traffic reports are displayed on the map either as text or as symbols.

Real-time traffic reports on the map



- ① Symbol delimiting the section of the route affected
- ② Symbol indicating an incident on the route (traffic flow)
- ③ Destination
- ④ Map scale

COMAND can show certain traffic incidents on the map. Traffic reports are shown on the map at scales of 0.05 mi to 20 mi.

- ▶ **To hide the menu:** slide ↑⊙ the COMAND controller and, when the **Full Screen** menu item is shown, press ⊙ to confirm. The map can be seen in the full-screen display.
- ▶ Turn ⊙ the COMAND controller until the desired map scale is set.

Symbol for real-time traffic reports

Warning (red)

On the map: symbol appears at the beginning of the affected route section if route guidance is active and the route leads through an affected area.

Traffic reports: symbol appears with the warning entry type

Traffic incident (yellow)

On the map: symbol appears at the beginning of the affected route section if route guidance is active and the route leads through an affected area.

Traffic reports: symbol appears with the caution entry type

Traffic jam on route (stop-and-go traffic)

On the map: symbol appears when approaching a traffic jam if route guidance is active and the route passes through the area affected by the traffic jam.

The symbol marks average speeds of 25 – 45 mph(40 – 72 km/h).

Yellow car symbols may appear in conjunction with this symbol.

Traffic reports: symbol appears with the traffic jam on route entry type (stop-and-go traffic)

Traffic jam on the route

On the map: symbol appears when approaching a traffic jam if route guidance is active and the route passes through the area affected by the traffic jam.

The symbol marks average speeds of 5 – 20 mph(8 – 32 km/h).

Red car symbols may appear in conjunction with this symbol.

Traffic reports: symbol appears with the traffic jam on route entry type

Blocked route section on the route

On the map: symbol appears at the beginning of a blocked section if route guidance is active and the route passes through the blocked section.

The XXXX symbols may appear in conjunction with this symbol.

Traffic reports: symbol appears with the blocked route section entry type

Yellow line
with arrows

Traffic incidents

On the map: possible delays (e.g. roadwork)

Appears on the side of the road affected (direction of travel)

Green line
with arrows

Unimpeded traffic flow

On the map: only appears on the side of the road (direction of travel) on which traffic flow is unimpeded

Red line
with arrows

Warning message

On the map: incident on road

Appears on the side of the road affected (direction of travel)

Displaying real-time traffic reports

Calling up a list

- ▶ **To switch to navigation mode:** press the **NAVI** function button.
- ▶ **To show the menu:** press **⊞** the COMAND controller.
- ▶ Select **Traffic** by turning **⊞** the COMAND controller and press **⊞** to confirm.

If the dialog field shows the “No Traffic Messages” message, this means that:

- no traffic reports have been received yet.
- no traffic reports are available.
- ▶ **To cancel the search:** select **Cancel** and press **⊞** to confirm.
- ▶ **To close the report window:** select **OK** and press **⊞** to confirm.

If traffic reports exist, a list is shown. The content of the list varies depending on whether route guidance is active or not.

List when route guidance is not active



The list shows all the roads, areas or regions for which reports are available.

A traffic report may refer to an area or a region, e.g. if visibility is impaired due to fog.

- ▶ Calling up a list(▷ page 335)
- ▶ **To read a traffic report:** select a road, area or region by turning **⊞** the COMAND controller and press **⊞** to confirm.

List when route guidance is active



The first list shows the roads, areas and regions that lie along the route and for which traffic reports are available.

- ▶ Call up a list (▷ page 335).
- ▶ **Show all messages:** select **All Messages** by turning **⊞** the COMAND controller and press **⊞** to confirm. You see a list of all roads, areas and regions for which traffic reports are available, even if the reports do not affect your route.

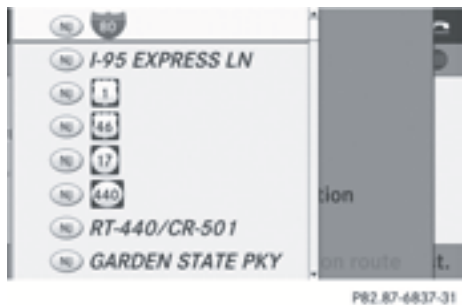

- ▶ **To show a traffic report:** select a road, area or region and press **⊞** to confirm.
- ▶ **To close the list:** slide **←** the COMAND controller.

Example: traffic report



P82.87-3780-31

① Depending on your selection: [Messages On Route](#) or [All Messages](#)

② Report 8 of 16 for the road affected

③ Report text

④ Road, area or region affected by traffic reports

⑤ Symbol for state/province

⑥ Symbol for report type, e.g. traffic flow message

▶ **To scroll within a report or to access the next report:** turn $\left[\odot \right]$ the COMAND controller.

▶ **To return to the report:** slide $\leftarrow \odot \rightarrow$ the COMAND controller.

Displaying traffic reports on the map



P82.87-3444-31

Example: traffic symbol information on the map

① Affected roads with indication of direction

② Symbol for report type, e.g. traffic flow message

▶ Select [Traffic Symbol Information](#) by turning $\left[\odot \right]$ the COMAND controller and press \odot to confirm.

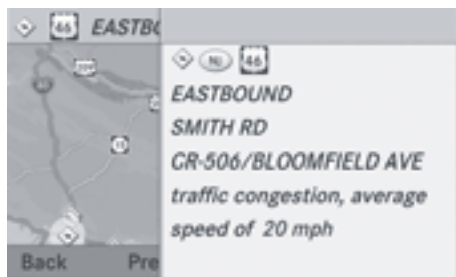

P82.87-3445-31

Example: details on traffic symbol information

▶ To continue highlighting traffic symbols, select [Next](#) or [Previous](#) by turning $\left[\odot \right]$ the COMAND controller and press \odot to confirm.

▶ **To change the map scale:** select [Map](#) by sliding $\uparrow \odot$ the COMAND controller and press \odot to confirm. You can now zoom in or out of the map.

▶ **To show the detailed view:** select [Details](#) and press \odot to confirm.

▶ **To close the detailed view:** slide $\leftarrow \odot \rightarrow$ the COMAND controller.

Reading out traffic reports on the route

Introduction

The read-aloud function is only available while route guidance is active. It reads out traffic reports affecting the current route.







You can select the following text reader properties:

- Language ([▷ page 292](#))
- Text reader speed ([▷ page 291](#))







You can start the text reader function manually or set it to automatic.

Starting the text reader function manually

▶ **To switch to navigation mode:** press the [NAVI](#) function button.

- ▶ **To show the menu:** press  the COMAND controller.
- ▶ Select **Traffic** by turning  the COMAND controller and press  to confirm.
- ▶ Select **Read out all messages on route** and press  to confirm. COMAND reads out the reports in sequence.
- ❶ If there are no reports for the route, the **Read out all messages on route** menu item is shown in gray and cannot be selected.
- ▶ **To switch off the read-aloud function:** select **Cancel Read-Aloud Function** and press  to confirm or press the  button. COMAND reads out the current report and then exits the read-aloud function.

Automatic read-aloud function

- ▶ **To switch to navigation mode:** press the  function button.
- ▶ **To show the menu:** press  the COMAND controller.
- ▶ Select **Navi** by sliding  and turning  the COMAND controller and press  to confirm.
- ▶ Select **Read Traffic Messages Automatically** and press  to confirm. Depending on the previous state, switch the option on or off .

Recalculating the route dynamically





The route types **Dynamic Route** and **Dynamic Route Only After Request** take all relevant traffic messages into account when calculating a route (▷ page 297).

If you have set the route type **Dynamic Route**, COMAND guides you on the updated route to your destination.

If you have set the route type **Dynamic Route Only After Request**, a prompt appears.





You can now decide whether to:

- accept the route suggested by COMAND
- continue your original route
- ▶ **To accept the suggested route:** press  the COMAND controller.
- ▶ **To continue along the original route:** select **Reject** by turning  the COMAND controller and press  to confirm.

Destination memory

Home address (My Address)

Entering the home address via address entry

- ▶ Proceed as described under "Adopting an address book entry as a home address" (▷ page 338). Confirm **My Address** by pressing .
- ▶ **To enter the home address for the first time:** confirm **New Entry** by pressing .
- ▶ **To change the home address:** select **Change** in the menu showing the home address by turning  the COMAND controller and press  to confirm.
- ▶ Confirm **New Entry** by pressing .
- ▶ In both cases, enter the home address as a destination, e.g. as a city, street and house number (▷ page 299). Then, save the home address (▷ page 304).

Adopting an address book entry as a home address

- ▶ **To switch on navigation mode:** press the **NAVI** function button.
- ▶ **To show the menu:** press **COMAND** the COMAND controller.
- ▶ Select **Dest.** in the navigation system menu bar by turning **COMAND** the COMAND controller and pressing **OK** to confirm.
- ▶ Select **From Memory** and press **OK** to confirm.
You will see the destination memory list either with the character bar (option 1) or as a selection list (option 2).

Option 1: destination memory list with character bar



- ▶ Slide **COMAND** the COMAND controller repeatedly until the destination memory list appears as a selection list.

Option 2: destination memory list as selection list

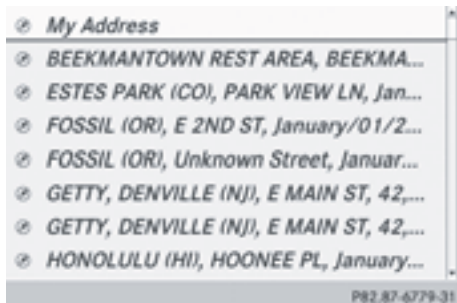

The **My Address** entry is listed as the first entry in the destination memory.

- ▶ Select **My Address** by turning **COMAND** the COMAND controller and press **OK** to confirm.

i If you have not yet entered any characters, **My Address** is automatically highlighted in the selection list.

If no home address has been stored yet, you can now assign an address book entry. If a home address already exists, it is displayed and you can alter it.

i If you select **New Entry**, you are also offered the option of entering the home address for the first time. You can then save the home address without having to start route guidance.

- ▶ **To enter the home address for the first time:** select **Assign To Address Book Entry** and press **OK** to confirm.

- ▶ Select **Home, Work** or **Not Classified** and press **OK** to confirm.

- ▶ **To change the home address:** select **Change** and press **OK** to confirm.

- ▶ Select **Assign To Address Book Entry** and press **OK** to confirm.

i If you select **New Entry**, you are also offered the option of changing the home address by entering an address. You can then save the home address without having to start route guidance.

- ▶ Select **Home, Work** or **Not Classified** and press **OK** to confirm.

In both cases, you will see the address book either with the character bar or as a selection list.

► **To select an address book entry:**

proceed as described in "Searching for an address book entry" (▷ page 379).

► **To confirm the selection:** press  the COMAND controller.

If there is no existing home address, COMAND saves the entry. You will see a message and then the address menu with the selected address. **Start** is highlighted automatically.

If a home address has already been stored, you will see a prompt asking you whether the **My Address** entry should be overwritten.

► Select **Yes** or **No** and press  to confirm.

If you select **Yes**, COMAND overwrites the destination. You will see a message and then the address menu with the selected address. **Start** is highlighted automatically.

If you select **No**, the list will appear again.

Selecting the home address for route guidance

- Proceed as described under "Selecting a destination from the destination memory" (▷ page 304).



Storing a destination in the destination memory

General notes





This function also stores the destination in the address book.

When the address book is full, no destinations can be saved in the destination memory. You must first delete address book entries (▷ page 379).







After destination entry

- The destination has been entered and is shown in the address entry menu (▷ page 299).
- Select **Save** by sliding  and turning  the COMAND controller and press  to confirm.
- You can now select storing options (▷ page 340).

During route guidance

- **To show the menu:** press  the COMAND controller.
- Select **Destination** in the navigation system menu bar by turning  the COMAND controller and pressing  to confirm.
- Select **Save Destination** and press  to confirm.
- You can now select storing options (▷ page 340).

From the list of previous destinations

- **To show the menu:** press  the COMAND controller.
- Select **Destination** in the navigation system menu bar by turning  the COMAND controller and pressing  to confirm.
- Select **From Last Destinations** and press  to confirm.
- The list of last destinations appears.
- Select a destination by turning  the COMAND controller and press  to confirm.
- The destination address is shown.
- Select **Save** and press  to confirm.
- You can now select storing options (▷ page 340).

Selecting storing options

Once you have chosen one of the following options for storing a destination, you can specify storage options:

- After destination entry (▷ page 339)
- During route guidance (▷ page 339)
- From the list of previous destinations (▷ page 305)

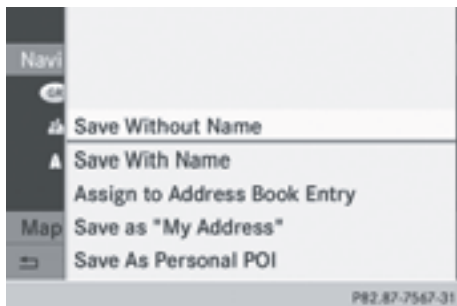

Storage options

- ▶ **To save the destination without a name:** select **Save Without Name** and press to confirm. COMAND stores the destination in the destination memory and uses the address as the destination name.
- ▶ **To save the destination as My Address:** select **Save as "My Address"** and press to confirm. COMAND stores the destination in the destination memory as **My Address**. If the selected address book entry already contains address data that can be used for navigation (icon), a prompt will appear asking whether you wish to overwrite the existing data.
- ▶ Select **Yes** or **No** and press to confirm. If you select **Yes**, the entry is overwritten. If you select **No**, the process will be canceled.
- ▶ **To save the destination with a name:** select **Save With Name** and press to confirm.

- ▶ Select a category, e.g. **Home**, and press to confirm.
- ▶ The input menu appears with data fields and the character bar.



Example: saving a destination with a name

- ① Selected data field with cursor
- ② Character bar
- ▶ Proceed as described under "Character entry (navigation)" (▷ page 283).
- ▶ Then select and press to confirm. COMAND stores the destination under the name entered.

Assigning a destination to an address book entry

An address with complete address data that is suitable for navigation can be assigned to a pre-existing address book entry.









- ▶ Select **Assign To Address Book Entry** from the storage options and press to confirm.
- ▶ Select a category, e.g. **Home**, and press to confirm. You will see the address book either with the character bar or as a selection list.
- ▶ **To select an address book entry:** proceed as described in "Searching for an address book entry" (▷ page 379). COMAND stores the data if the address book entry selected does not yet contain navigable address data.

If the selected address book entry already contains navigable address data, a prompt will appear asking whether you wish to overwrite the existing data.

- ▶ Select **Yes** or **No** and press  to confirm. If you select **Yes**, COMAND stores the data.

You can start route guidance to this address directly from the address book (▷ page 381).

Deleting a destination or the home address

- ▶ **To switch on navigation mode:** press the  function button.
- ▶ **To show the menu:** press  the COMAND controller.
- ▶ Select **Destination** in the navigation system menu bar by turning  the COMAND controller and pressing  to confirm.
- ▶ Select **From Memory** and press  to confirm. You will see the destination memory list either with the character bar (option 1) or as a selection list (option 2).
- ▶ **Option 1: destination memory list with character bar:** proceed as described under "Entering characters using the character bar" (▷ page 283).
- ▶ **Option 2: destination memory list as selection list:** select a destination by turning  the COMAND controller and press  to confirm. You see the address data of the selected entry.
- ▶ Select **Delete** and press  to confirm. A prompt appears asking whether you wish to delete the destination.
- ▶ Select **Yes** or **No** and press  to confirm. If you select **Yes**, COMAND deletes the destination. You will see a message to this effect.

If you select **No**, the process will be canceled.

-  If the navigable address data for the destination being deleted is also assigned to an address book entry, COMAND will also delete this data from there. If the corresponding address book entry does not contain any further data, such as telephone numbers, COMAND deletes the entire address book entry.

Previous destinations





Introduction

COMAND automatically stores the previous destinations for which route calculation has been started. If the memory is full, COMAND deletes the oldest destination. You can also save a destination from the list of previous destinations in the destination memory. It will be stored there permanently.

Storing a destination permanently in the destination memory

- ▶ Proceed as described in the "From the list of previous destinations" section (▷ page 305).

Storing the vehicle position in the list of previous destinations

- ▶ **To switch on navigation mode:** press the  function button.
- ▶ **To show the menu:** press  the COMAND controller.
- ▶ Select **Position** in the navigation system menu bar by turning  the COMAND controller and press  to confirm.
- ▶ Select **Save Vehicle Position** and press  to confirm. COMAND stores the current vehicle position as a destination in the list of previous destinations.

Storing the crosshair position in the list of previous destinations

A crosshair appears on the map if you have moved the map manually (▷ page 343). You can store the crosshair position as a destination in the list of previous destinations.

- ▶ **To show the menu:** press the COMAND controller.
- ▶ Select **Position** in the navigation system menu bar by turning the COMAND controller and press to confirm.
- ▶ Select **Save Crosshair Position** and press to confirm.

Deleting one of the previous destinations

- ▶ **To switch on navigation mode:** press the **NAVI** function button.
- ▶ **To show the menu:** press the COMAND controller.
- ▶ Select **Destination** in the navigation system menu bar by turning the COMAND controller and pressing to confirm.
- ▶ Select **From Last Destinations** and press to confirm. The list of last destinations appears.
- ▶ Select the desired destination and press to confirm. The destination address appears.
- ▶ Select **Delete** and press to confirm. A prompt appears asking whether the entry should be deleted.
- ▶ Select **Yes** or **No** and press to confirm. If you select **Yes**, the entry is deleted. If you select **No**, the process will be canceled.

Map operation and map settings

General notes

Company logos displayed on the map are trademarks of the respective companies and used solely for the purpose of indicating the locations of these companies. The use of such logos on the map does not indicate approval of, support of or advertising by these companies for the navigation system itself.

Setting the map scale

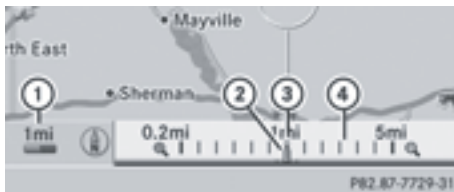

- ① Set map scale as a number with unit
- ② Currently set map scale as indicated by the needle on the scale bar
- ③ Map scale

Unit of measurement ① in the COMAND display depends on the selection made for the instrument cluster (▷ page 215).

- ▶ **To hide the menu:** slide the COMAND controller and, when the **Full Screen** menu item is shown, press .
- ▶ **To call up the scale bar:** as soon as you turn the COMAND controller, scale bar ③ appears.
- ▶ Turn until the desired scale is set.

Moving the map

Showing the crosshair



Map with crosshair

- ① Current vehicle position
 - ② Crosshair
 - ③ Details of the crosshair position
 - ④ Map scale selected
- ▶ **To hide the menu:** slide $\uparrow \odot$ the COMAND controller and, when the **Full Screen** menu item is shown, press \odot .
 - ▶ **To scroll the map:** slide $\leftarrow \rightarrow$, $\uparrow \downarrow$ or $\swarrow \searrow$ the COMAND controller. A crosshair appears on the map. If you slide it again, the map moves in the corresponding direction under the crosshair.

Display ③ may be the name of a street, for example, provided the digital map contains the necessary data. It shows the geo-coordinate position of the crosshair if the **Geo-coordinates** display is switched on (▶ page 345).

Hiding the crosshair and centering the map on the vehicle position or destination

- ▶ Press the \leftarrow back button twice. The crosshair disappears and the map is set to the vehicle position.

Centering the map on the vehicle's position

- ▶ **To show the menu:** press \odot the COMAND controller.

- ▶ Select **Position** in the navigation system menu bar by sliding $\odot \downarrow$ and turning $\swarrow \odot$ the COMAND controller and press \odot to confirm.
- ▶ Select **Vehicle Position Map** and press \odot to confirm or, if the crosshair is shown, press the \leftarrow back button. This hides the crosshair.

Centering the map on the destination position

This function requires that a route to a destination has been calculated. If the route includes waypoints and an intermediate stop, the map can also be set to these positions.

- ▶ **To show the menu:** press \odot the COMAND controller.
- ▶ Select **Position** in the navigation system menu bar by sliding $\odot \downarrow$ and turning $\swarrow \odot$ the COMAND controller and press \odot to confirm.
- ▶ Select **Destination Position Map** and press \odot to confirm. The crosshair position is set to the relevant destination.

Map settings

Calling up the map settings menu

Route Settings	Map Orientation
Map Settings	POI Symbols On Map
Personal POIs	Text Information On Map
Announce Street	Topographic Map
Audio Fadeout	Highway Information
Calculate Alternatives	City (3D)
Avoid Area	Next Intersecting Street
Map Version	Compass On Map

P82.87-4808-31

- ▶ **To show the menu:** press \odot the COMAND controller.

- ▶ Select **Navi** in the main function bar by sliding and turning the COMAND controller and press to confirm.
- ▶ Select **Map Settings** and press to confirm.
The map settings menu appears.

Map orientation

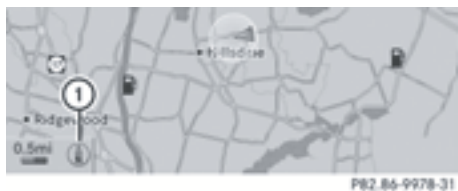

PB2.86-9978-31

Example: map orientation

- ① Current map orientation

Possible map orientations:

- North orientation (the map view is displayed so that north is always up)
- Orientation in direction of travel (the map is displayed so that the direction of travel is always up; the orange point of the symbol points north)
- Bird's-eye view (the map is displayed so that the direction of travel is always up; the map projection reproduces the curvature of the earth and the orange point of the symbol points north)
- 3D map (the map is displayed so that the heading is always up; from a scale of 1 km the map displays elevation; the orange point of the symbol points north).

North Up	Map Orientation
• Heading Up	POI Symbols On Map
Bird's-eye View	Text Information On Map
3-D Map	Topographic Map
	Highway Information
	City (3D)
	Next Intersecting Street
	Compass On Map

PB2.87-6809-31

Map orientation menu

Setting the map orientation

- ▶ **To show the menu:** press the COMAND controller.
- ▶ Select **Navi** in the main function bar by sliding and turning the COMAND controller and press to confirm.
- ▶ Select **Map Settings** and press to confirm.
The map settings menu appears.
- ▶ Select **Map Orientation** and press to confirm.
- ▶ Select **North Up, Heading Up, Bird's-eye View** or **3-D Map** by turning the COMAND controller and press to confirm.
A • dot indicates the new setting.

Selecting POI symbols

Default Symbols	Map Orientation
Custom Symbols	POI Symbols On Map
• No Symbols	Text Information On Map
	Topographic Map
	Highway Information
	City (3D)
	Next Intersecting Street
	Compass On Map

PB2.87-6810-31

Setting the POI symbol display

You can set the points of interest you wish to have displayed as symbols on the map. Points of interest are, for example, gas stations, hotels, cinemas and restaurants.

- ▶ **To show the menu:** press the COMAND controller.
- ▶ Select **Navi** in the main function bar by sliding and turning the COMAND controller and press to confirm.
- ▶ Select **Map Settings** and press to confirm.
The map settings menu appears.

- ▶ Select **POI Symbols On Map** and press  to confirm.

The following settings are possible:

- **Default Symbols**

Symbol display determined by the factory settings.

- **Custom Symbols**

You can determine the symbols yourself.

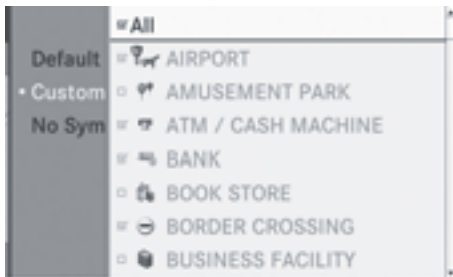

- **No Symbols**

The map does not show any symbols.



P82.87-4811-31

- ▶ Select **Default Symbols**, **Custom Symbols** or **No Symbols**.
If you select **Custom Symbols**, the POI list appears.

- ▶ **To switch the symbol display on/off:** select a POI by turning  the COMAND controller and press  to confirm. Depending on the previous state of the symbols, they will either be shown or hidden . You can switch on the symbol displays for more than one point of interest.
- ▶ **To switch all personal symbols on/off:** select **All** and press  to confirm. Depending on the previous status of the symbols, they will either be shown or hidden .

If the function is switched on , the individual POIs are grayed out and the previously selected settings remain unchanged.

If the function is switched off , you can reselect the individual POIs. They show the most recently selected settings.

- ▶ **To exit the menu:** press the  back button.
- i** The list shows all symbols that are contained on the digital map across all countries. However, not all points of interest are available in all countries. As a result, certain point of interest symbols may not be displayed on the map, even if the symbol display is switched on.



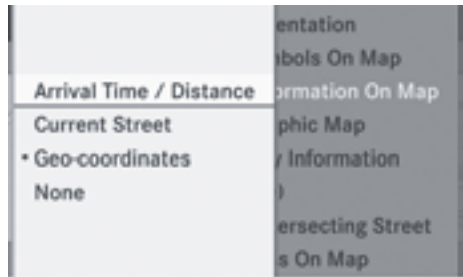





Selecting map information



P82.87-4812-31

Map information in the display

During route guidance, you can have map information shown at the bottom edge of the display.

- ▶ **To show the menu:** press  the COMAND controller.
- ▶ Select **Navi** in the main function bar by sliding  and turning  the COMAND controller and press  to confirm.
- ▶ Select **Map Settings** and press  to confirm. The map settings menu appears.
- ▶ Select **Text Information On Map** and press  to confirm. A • dot indicates the current setting.
- ▶ Select **Arrival Time / Distance**, **Current Street**, **Geo-coordinates** or **None** and press  to confirm.
- ▶ **To exit the menu:** slide  the COMAND controller.



P82.87-3772-31

Arrival time/distance to destination display

- ① Symbol for destination
- ② Distance to destination
- ③ Symbol for estimated time of arrival
- ④ Estimated time of arrival

You can only see this display during route guidance.

While moving the map, you will see additional data, depending on the crosshair position, if the digital map supports this data. This might be a street name, for example (▷ page 343).

During route calculation, or if the vehicle is traveling on a non-digitized road, the linear distance to the destination is shown. In this case, the display will be grayed out.



P82.87-3773-31

Road display

- ① Road names or numbers, e.g. for highways



P82.87-7731-31

Geo-coordinate display

- ① Current height above average sea level (rounded to the nearest 10 m)
- ② Current vehicle position: latitude coordinates

- ③ Current vehicle position: longitude coordinates
- ④ Number of GPS satellites currently being used

There must be sufficient GPS reception for all displays to be shown. If this is not the case, the display will be grayed out. Height display ① may vary from the actual value, because the navigation system uses the GPS signals for the calculation.

During the "Move map" function (▷ page 306), you will see the geo-coordinates of the crosshair position. Height display ① and number of satellites used ④ are not displayed.



P82.87-3775-31

Display switched off

- ① Current map orientation

While moving the map, you will see additional data, e.g. road names, depending on the crosshair position, if the digital map supports this data (▷ page 343).







Coordinates on the map

- ▶ **To show the menu:** press the COMAND controller.
- ▶ Select **Navi** in the main function bar by sliding and turning the COMAND controller and press to confirm.
- ▶ Select **Map Settings** and press to confirm.
The map settings menu appears.
- ▶ Select **Compass On Map** and press to confirm.
A menu appears.

- ▶ Select **Never**, **When Off-Road** or **When Route Guidance Inactive** and press  to confirm.
The selected setting is accepted.

Switching additional information on/off

Switching the topographical map on/off

- ▶ **To show the menu:** press  the COMAND controller.
- ▶ Select **Navi** in the main function bar by sliding  and turning  the COMAND controller and press  to confirm.
- ▶ Select **Map Settings** and press  to confirm.
The map settings menu appears.
- ▶ Select **Topographic Map** and press  to confirm.
Depending on the previous status, switch the option on or off .

The topographical map uses different colors to depict elevation. The color key generally reflects the topography's dominant vegetation or the ground's perceived color when seen from the air, for example:

- green (grass) for lowland
- yellow, brown (woodland) for hills
- gray (stone) and white (snow) for mountains.



Example: highway information

Switching freeway information on/off



When driving on the highway, you can see the following information on the right of the display:

- the nearest gas stations
- the nearest rest areas, etc.
- and their distance from the current vehicle position

The entries show the number of the highway and the highway exits as well as their distance from the current vehicle position.

- ▶ **To switch on navigation mode:** press the **NAVI** function button.

- ▶ **To show the menu:** press  the COMAND controller.

- ▶ Select **Navi** in the main function bar by sliding  and turning  the COMAND controller and press  to confirm.

- ▶ Select **Map Settings** and press  to confirm.
The map settings menu appears.

- ▶ Select **Highway Information** and press  to confirm.
Depending on the previous status, switch the option on or off .

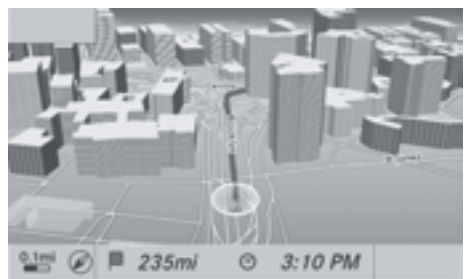

Example: city model

Switching city view on/off

When the city model is switched on, the map shows buildings as 3D models.

- ▶ **To show the menu:** press  the COMAND controller.

- ▶ Select **Navi** in the main function bar by sliding $\uparrow \odot$ and turning $\left\{ \odot \right\}$ the COMAND controller and press \odot to confirm.
- ▶ Select **Map Settings** and press \odot to confirm.
The map settings menu appears.
- ▶ Select **City (3D)** and press \odot to confirm.
Depending on the previous status, switch the option on or off .

i The city model is only shown for "Bird's-eye view" or "3D map".

It is available in the 0.05 mi and 0.1 mi map scales.

The data required for displaying buildings is not available for all cities.



Example: intersecting roads on city routes/highways

Showing/hiding intersecting streets

If route guidance is inactive, intersecting streets can be shown on the upper edge of the display.

- ▶ **To show the menu:** press \odot the COMAND controller.
- ▶ Select **Navi** in the main function bar by sliding $\uparrow \odot$ and turning $\left\{ \odot \right\}$ the COMAND controller and press \odot to confirm.
- ▶ Select **Map Settings** and press \odot to confirm.
The map settings menu appears.
- ▶ Select **Next Intersecting Street** and press \odot to confirm.
Depending on the previous status, switch the option on or off .



Traffic information on the map



- ① Speed & Flow
- ② Free Flow
- ③ Traffic incidents

If you subscribe to the SIRIUS XM Satellite Radio Traffic Message Service, traffic information can be displayed on the map. You can select three categories for the display.

- ▶ **To switch the display on/off:** press \odot the COMAND controller to show the menu.
- ▶ Select **Navi** in the main function bar by sliding $\uparrow \odot$ and turning $\left\{ \odot \right\}$ the COMAND controller and press \odot to confirm.

- ▶ Select **Traffic Information On Map** and press  to confirm.
- ▶ Select **Incidents** and/or **Speed & Flow** and/or **Free Flow** and press  to confirm.
Depending on the previous status, switch the option on or off .

Traffic information	Display on the map
Traffic incidents	Road sections with traffic incidents are illustrated with a yellow line and arrows.
Speed & Flow	Road sections with traffic jams are displayed with yellow or red car symbols. Yellow car symbols: traffic jams, average speed 25 - 45 mph (40 - 72 km/h). Red car symbols: traffic jam, average speed 5 - 20 mph (8 - 32 km/h).
Free Flow	Free flowing road sections are illustrated with a green line and arrows.

Additional settings

Avoiding an area

General information

COMAND enables you to avoid areas you do not wish to drive through.







If you activate or deactivate a route block while route guidance is active, COMAND will calculate a new route. If you activate or deactivate a route block while route guidance is inactive, COMAND will use the new setting for the next route guidance.

The calculated route may include an area to be avoided if:

- your destination is located in such an area.
 - the route uses roads that lead through an area to be avoided.
-  Highways within blocked areas are always taken into consideration in the route calculation.



Defining an area for the first time

Calling up the area menu

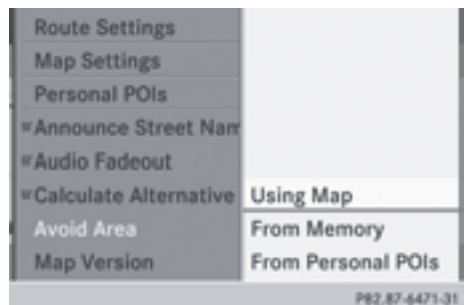







- ▶ **To switch on navigation mode:** press the  function button.
- ▶ **To show the menu:** press  the COMAND controller.
- ▶ Select **Navi** in the main function bar by sliding  and turning  the COMAND controller and press  to confirm.
- ▶ Select **Avoid Area** and press  to confirm.
If you have not previously blocked an area, a menu appears.





- ▶ Select **Using Map**, **From Memory** or **From Personal POIs** and press  to confirm.
If you select **Using Map**, the map with the crosshair appears.
If you select **From Memory** or **From Personal POIs**, either the destination memory or the list of categories for POIs appears.

- Destination memory (▷ page 304)
 - List of categories for personal POIs (▷ page 319)
- ▶ Select the desired destination or personal POI and press  to confirm.
- ▶ When the destination address is displayed, select **Continue** and press  to confirm. The map appears.

The crosshair marks the center of the area that is to be avoided.







- ▶ **To scroll the map:** slide , , ,  or  the COMAND controller.
- ▶ **To set the map scale:** as soon as you turn  the COMAND controller, the scale bar appears. Turning clockwise zooms out from the map; turning counter-clockwise zooms in.
- ▶ Turn  until the desired scale is set.
- ▶ **To apply a block:** press  the COMAND controller. A red square appears on the map.



- ▶ **To adjust the size of the square:** turn  the COMAND controller. The square is enlarged or reduced.
- ▶ **To confirm the settings:** press . The list appears. The previously selected area to be avoided has been added and activated.
- ▶ Follow the steps described in the "Defining further areas" section (▷ page 350).



Defining further areas

Calling up the list of areas

- ▶ **To switch on navigation mode:** press the  function button.
- ▶ **To show the menu:** press  the COMAND controller.
- ▶ Select **Navi** in the main function bar by sliding  and turning  the COMAND controller and press  to confirm.
- ▶ Select **Avoid Area** and press  to confirm. If you have already selected one or more areas to avoid, a list of areas appears.



Example: list of areas

-  Available positions in the list are named **Empty** and are shown in gray.
- ▶ Select **Avoid New Area** by turning  the COMAND controller and press  to confirm. A menu appears.

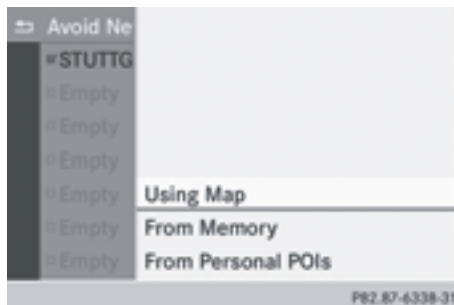

- ▶ Select **Using Map**, **From Memory** or **From Personal POIs** and press to confirm. If you select **Using Map**, the map with the crosshair appears. If you select **From memory** or **From Personal POIs**, either the destination memory or the list of categories for POIs appears.
 - Destination memory (▷ page 304)
 - List of categories for personal POIs (▷ page 319)
- ▶ Select the desired destination or personal POI and press to confirm.
- ▶ When the destination address is displayed, select **Continue** and press to confirm. The map appears.
- ▶ **To avoid a new area:** call up the area menu again (▷ page 349).

Switching an avoided area on/off

- ▶ Call up the area list (▷ page 350).
- ▶ Select an entry in the list by turning the COMAND controller and press to confirm. The avoided area is switched on or off depending on the previous status.

Displaying and changing an avoided area

- ▶ Call up the area list (▷ page 350).
- ▶ Select an entry in the list by turning the COMAND controller.
- ▶ Slide the COMAND controller and press to confirm.
- ▶ Select **Display / Change** and press to confirm. The area to be avoided is indicated in the map.
- ▶ **To change the location of the area:** slide or the COMAND controller. The area is moved on the map.

- ▶ **To adjust the size of the area:** turn the COMAND controller. The area is enlarged or reduced.
- ▶ **To confirm the change:** press the COMAND controller. The list appears and the change is entered.

Deleting a set area

- ▶ Call up the area list (▷ page 350).
- ▶ Select an entry in the list by turning the COMAND controller.
- ▶ Slide the COMAND controller and press to confirm.
- ▶ Select **Delete** and press to confirm. A query appears asking whether the entry should be deleted.
- ▶ Select **Yes** or **No**. If you select **Yes**, the entry is deleted. If you select **No**, the process will be canceled.

SIRIUS XM service

Displaying SIRIUS XM service information

You can display the SIRIUS XM service information.

- ▶ **To show the menu:** press the COMAND controller.
- ▶ Select **Navi** in the main function bar by sliding and turning the COMAND controller and press to confirm.
- ▶ Select **SIRIUS Service** and press to confirm. The window on the right half of the display shows the telephone number of the provider (SIRIUS XM) and the serial number of your service module.

Registering for the SIRIUS XM traffic report service

- ▶ Call the traffic report provider's phone number shown on the screen.
- ▶ You can also have the satellite service activated online. To do so, visit the SIRIUS

XM Radio website at
<http://www.sirius.com> (USA) or
<http://www.siriuscanada.com>
 (Canada).

Once the connection has been established:

- ▶ Follow the instructions of the operator.
 The activation process may take up to ten minutes.

If registration is not included when purchasing the system, your credit card details will be required to activate your account.

Compass function

In the compass view, you can see the current direction of travel, the current height above sea level and the coordinates of the vehicle position, for example.

- ▶ **To switch on navigation mode:** press the **NAVI** function button.
- ▶ **To show the menu:** press **COMAND** controller.
- ▶ Select **Position** in the navigation system menu bar by sliding **UP** and turning **RIGHT** the COMAND controller and press **COMAND** to confirm.
- ▶ Select **Compass** and press **COMAND** to confirm.



Example: compass

- ① Current direction of travel
- ② Current height above average sea level (rounded)

- ③ Current vehicle position: longitude coordinates
 - ④ Number of GPS satellites currently being used
 - ⑤ Current vehicle position: latitude coordinates
 - ⑥ Currently set steering angle of the front wheels
- i** To display current elevation ②, the system must be able to receive at least four satellites. Steering angle ⑥ can be a maximum of 35° in both directions.
- ▶ **To exit the display:** confirm **Back** by pressing **COMAND** or press the **BACK** button.

Showing the map data version



- ▶ **To show the map data menu:** press **COMAND** controller.
- ▶ Select **Navi** in the main function bar by sliding **UP** and turning **RIGHT** the COMAND controller and press **COMAND** to confirm.
- ▶ Select **Map Version** and press **COMAND** to confirm.
 The map data version number is shown. Information about new versions of the digital map can be obtained from an authorized Mercedes-Benz Center.

Updating the digital map

Introduction

The digital maps generated by the map software become outdated in the same way as conventional road maps. Optimal route guidance can only be provided by the navigation system in conjunction with the most up-to-date map software.

Information about new versions of the digital map can be obtained from an authorized Mercedes-Benz Center. You can have the digital map updated there with a DVD, or you can update it yourself.

Updating process

WARNING

Never leave the engine running in an enclosed space. The exhaust gases contain carbon monoxide. Inhaling exhaust gases constitutes a health hazard and could lead to loss of consciousness or even death.

- i** The update process can take a long time (over an hour), depending on the size of the digital map. During this time, you will only be able to switch on radio mode and to accept incoming calls. The update will be completed more quickly if the vehicle is stationary.

If you start the update with the engine switched off and the starter battery has insufficient power, COMAND may automatically switch off. This protects the battery. If this occurs, restart the update with the engine running.



- ▶ Insert the DVD:
 - in the single DVD drive (▷ page 421)
 - in the DVD changer (▷ page 421)
 COMAND checks whether the digital map on the DVD is compatible with the navigation system and system software. A prompt then appears asking if you want to install the database. Versions of the database currently installed and the

database that is to be installed are displayed.

- ▶ Select **Yes** or **No** and press  to confirm. After selecting **Yes**, an activation code must be entered when installing a database for the first time. You will receive the activation code when you buy the navigation DVD.

If you select **No**, the process will be canceled.

- ▶ Enter the activation code. After entering the activation code correctly, COMAND starts updating the digital map. Once the update is finished, you will see a message.
- ▶ **To confirm the message:** press  the COMAND controller.
- ▶ Take the DVD out of the slot. While the update is running, you will see a message to this effect and a progress bar. The navigation system is not operational until the update is complete.
- i** You cannot eject the DVD during the update. If you switch off COMAND during the update, the update is interrupted. It then continues from where it was interrupted when the system is restarted. COMAND may prompt you to change the DVD during the update.

- ▶ Press the  (for DVD changer) or  (for single DVD drive) load/eject button.
- ▶ Take the DVD out of the slot.
- ▶ Insert the requested DVD. Once the update has been successfully completed, you will see a message to this effect.
- ▶ **To confirm the message:** press  the COMAND controller.
- ▶ Take the DVD out of the slot. The update is complete. If the update is not successfully completed, you will see a message that the map update is not possible.

- ▶ **To confirm the message:** press  the COMAND controller.
- ▶ Take the DVD out of the slot.

Problems with the navigation system

Problem	Possible causes/consequences and ► Solutions
<p>COMAND is unable to continue route guidance after the journey has been interrupted.</p>	<p>Route guidance is canceled if you interrupt the journey for more than two hours.</p> <p>"Interrupting the journey" refers to stopping the vehicle.</p> <p>"Continuing route guidance" refers to switching COMAND back on and driving on.</p> <p>► Continue route guidance (> page 326).</p>

Problem	Possible causes/consequences and ► Solutions
<p>COMAND is unable to determine the vehicle's position.</p>	<p>COMAND has to redetermine the position of the vehicle if the vehicle has been transported.</p> <p>Example:</p> <ul style="list-style-type: none"> • After transporting the vehicle by ferry • After transporting the vehicle by motorail • After the vehicle has been towed <p>► Start the vehicle and pull away.</p> <p>COMAND determines the vehicle's position. Depending on the driving situation, this may take some time.</p> <p>Route guidance may be restricted during the determination of the vehicle's position.</p> <p>When positioning is complete, route guidance is resumed with navigation announcements and route guidance displays.</p>

Problem	Possible causes/consequences and ► Solutions
The Navigation Unavailable message appears.	<p>COMAND has an integrated hard drive on which the digital map is stored.</p> <p>To protect the integrated hard drive against damage, COMAND deactivates it at very high and low temperatures. The navigation system will then be temporarily unavailable.</p> <ul style="list-style-type: none"> ► Let the vehicle and COMAND cool down. ► To hide the message: switch COMAND off and then on again. <p>If an area of the hard disk has a malfunction, COMAND can no longer access the map data in this area. This may occur when calculating a route, for example.</p> <ul style="list-style-type: none"> ► To hide the message: switch COMAND off and then on again. The navigation system will be operational again until it has to access the faulty area of the hard drive once more. The message will then reappear. ► Consult an authorized Mercedes-Benz Center.

Problem	Possible causes/consequences and ► Solutions
You see a message informing you that the DVD containing the digital map is incompatible with the system software.	<p>The DVD containing the digital map cannot be used for the update.</p> <ul style="list-style-type: none"> ► To confirm the message: press  the COMAND controller. ► Eject the DVD. ► Have the system database checked at an authorized Mercedes-Benz Center.

Problem	Possible causes/consequences and ► Solutions
The map software update has failed.	<p>The DVD is dirty.</p> <ul style="list-style-type: none"> ► Clean the DVD. ► Restart the update. <p>The DVD is scratched.</p> <ul style="list-style-type: none"> ► Consult an authorized Mercedes-Benz Center. <p>There is overheating due to excessive temperatures in the vehicle interior.</p> <ul style="list-style-type: none"> ► Wait until the vehicle interior has cooled down. ► Restart the update. <p>COMAND's integrated hard disk is defective.</p> <ul style="list-style-type: none"> ► Consult an authorized Mercedes-Benz Center.

Problem	Possible causes/consequences and ► Solutions
COMAND asks for an activation code during the map update.	The digital map is secured with an activation code. ► Consult an authorized Mercedes-Benz Center.

Telephone

General notes

Introduction

COMAND provides telephony via the Bluetooth® interface.

When connecting Bluetooth®-capable mobile phones with PBAP (**P**hone **B**ook **A**ccess **P**rofile), the contacts are automatically downloaded to COMAND.

With a suitable mobile phone, you can use the hands-free system and receive vCards via the Bluetooth® interface.

You can use the text message function (receiving and reading) if the mobile phone supports the MAP (**M**essage **A**ccess **P**rofile) Bluetooth® profile.

Further information on suitable mobile phones and on connecting Bluetooth®-capable mobile phones to COMAND can be found on the Internet at

http://www.mbusa-mobile.com. Or call the Mercedes-Benz Customer Assistance Center on 1-800-FOR-MERCEdes (1-800-367-6372) for the USA or on 1-800-387-0100 for Canada.

Safety notes

WARNING

The driver must always concentrate on the road. For your safety and the safety of others, we recommend that you pull over to a safe location and stop before placing or taking a telephone call. If you choose to use the mobile phone while driving, please use the hands-free device and only use the mobile phone

when weather, road and traffic conditions permit.

Some jurisdictions prohibit the driver from using a mobile phone while driving a vehicle.

Bear in mind that at a speed of only 30 mph (approximately 50 km/h), the vehicle covers a distance of 44 feet (approximately 14 m) per second.

WARNING

Excessive electromagnetic radiation may constitute a health hazard to yourself and others.

There is scientific discussion surrounding the possible health risks posed by electromagnetic fields. You can reduce this risk by using an exterior aerial.

Therefore, only use mobile communication equipment if it is connected to the exterior aerial of the vehicle.

Call disconnection while the vehicle is in motion



A call may be disconnected if:

- there is insufficient network coverage in certain areas.
- you move from one transmitter/receiver area (cell) into another and no channels are free.
- you use a SIM card which is not compatible with the network available.





Operating options

You can operate the telephone by:

- using the COMAND controller:
Turn 

Slide  or 

Press 

- using the  or  button and using the telephone keypad on COMAND
- using the  or  button on the multifunction steering wheel
- using the Voice Control System (see the separate Voice Control System operating instructions)

Unless stated otherwise, the descriptions and illustrations in this section refer to COMAND.

Function restrictions

The telephone is not ready for use in the following situations:

- the telephone automatically tries to log on to a network. If no network is available, you may not be able to make a "911" emergency call. If you attempt to make an outgoing call, the **No Service** message will appear for a short while.

911 emergency call

WARNING

The 911 emergency call system is a public service. Using it without due cause is a criminal offense.

The following requirements must be fulfilled for a **911** emergency call:

- the mobile phone must be switched on.
- a network must be available.
- a valid and operational SIM card must be inserted in the mobile phone.
- the mobile phone is connected to COMAND via Bluetooth®.

If you cannot make an emergency call, you must arrange rescue measures yourself.

- ▶ Enter the number on COMAND (▷ page 365).
- ▶ Press . The telephone makes the connection.
- ▶ Wait until the emergency call center answers and describe the emergency situation.

Telephony via the Bluetooth® interface

Conditions

For telephony via COMAND's Bluetooth® interface, a Bluetooth®-capable mobile phone is required.

On COMAND

- ▶ Activate the Bluetooth® function in COMAND (▷ page 292).

On the mobile phone

- ▶ Switch on the mobile phone and enter the PIN when prompted to do so (see the mobile phone operating instructions).
- ▶ Activate Bluetooth® functions and, where necessary, Bluetooth® visibility on the mobile phone (see the mobile phone operating instructions).

The battery of the mobile phone should always be kept sufficiently charged in order to prevent malfunctions.

In preparation for telephoning via the Bluetooth® interface, you should check the following items on your mobile phone (see the mobile phone operating instructions):

- Hands-Free Profile
The mobile phone must support Hands-Free Profile 1.0 or above.
- Bluetooth® visibility
On certain mobile phones, the device itself must be made "visible" to other devices, as well as activating the Bluetooth® function (see the mobile phone operating instructions).

This visibility is for restricted periods of time on some mobile phones.

- Bluetooth® device name

Every Bluetooth® device has its own Bluetooth® device name. This device name is freely definable, but can be identical for all devices from the same manufacturer. It is therefore recommended that you change this name so that you can easily recognize your mobile phone (see the mobile phone operating instructions).

- i** Not all mobile phones available on the market are equally suitable. You can obtain more detailed information about suitable mobile phones and about connecting Bluetooth®-capable mobile phones to COMAND on the Internet at <http://www.mbusa-mobile.com>. Alternatively, call the Mercedes-Benz Customer Assistance Center at 1-800-FOR-MERCEdes (1-800-367-6372) (for USA) or Customer Relations at 1-800-387-0100 (for Canada).

- i** Some displays (e.g. the signal strength) depend on the supported version of the Hands-Free Profile.

Connecting a mobile phone

General information

Before using your mobile phone with COMAND for the first time, you will need to:

- search for it (> page 359) and then
- authorize (register) it (> page 360).

When you authorize a new mobile phone, it is connected automatically.

You can authorize up to 15 mobile phones.

If the mobile phone supports PBAP (Phone Book Access Profile) and MAP (Message Access Profile), the following contacts and messages are downloaded into COMAND when connecting:

- phone book
- call lists
- text messages

Further information on the conditions for connecting (> page 358).

Searching for a mobile phone

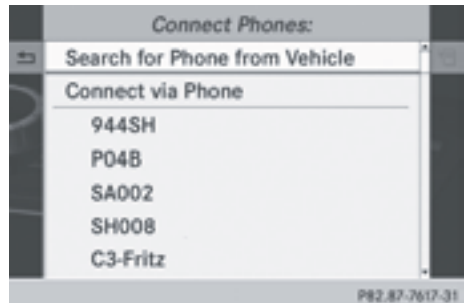

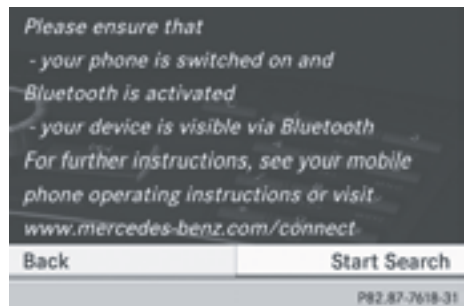

Bluetooth® telephones list





Conditions for searching

- ▶ Press the **TEL** function button on COMAND.
- ▶ Select **Connect Device** in the telephone basic menu by sliding **⊙↓** and turning **⌚** the COMAND controller and press **⊙** to confirm.

- ▶ Select **Search for Phone from Vehicle** and press the  button to confirm.
A message appears.
- ▶ Select **Start Search** and press the  button to confirm.
The message **Searching for Bluetooth Phones...** appears.
COMAND looks for Bluetooth® telephones within range and adds them to the Bluetooth® telephones list.
If a new phone is found, it appears in the list with the  symbol.
The duration of the search depends on the number of Bluetooth® telephones within range and their characteristics.

Symbols in the Bluetooth® phone list

Symbo l	Explanation
	New mobile phone in range, but not yet authorized
✓	Authorized mobile phone
•	Currently connected mobile phone
	Mobile phone in range and authorized
 (gray)	Mobile phone not in range, but already authorized

The Bluetooth® telephone list shows all mobile phones within range and all previously authorized mobile phones, whether or not they are in range.

- i** If the Bluetooth® telephones list is already full, you will be requested to de-authorize a mobile phone (▷ page 362). If COMAND does not find your mobile phone, external authorization may be necessary (▷ page 361).
- i** If you call up the telephone list again, the unauthorized devices are removed from the



list. In this case, start a new search to update the Bluetooth® telephone list.

Authorizing (registering) a mobile phone



Entering the passkey (above) and the telephone basic menu with a connected mobile phone 

Option 1: using the passkey (access code)

- ▶ Select the mobile phone with the  symbol from the Bluetooth® telephones list by turning  the COMAND controller and press  (▷ page 359) to confirm.
The input menu for the passkey appears.



The passkey is any one to sixteen-digit number combination which you can choose yourself. You must enter the same number combination in COMAND and in the Bluetooth®-capable mobile phone (see the mobile phone operating instructions).

- i** Some mobile phones require a passkey with four or more digits.
- i** If you want to reauthorize a mobile phone following de-authorization, you can select a different passkey.



i Mercedes-Benz recommends de-authorization in COMAND and on the mobile phone (▷ page 362). Subsequent authorization may otherwise fail.

▶ **To enter a passkey in COMAND:** press the number keys in turn.

or

▶ Select the digits in the digit bar one by one by turning  the COMAND controller and pressing  to confirm.

 is highlighted after the first number has been entered.

▶ In both cases, select  and press  to confirm.

▶ **To enter the passkey on the mobile phone:** if the Bluetooth® connection is successful, you will be requested to enter the passkey (access code, passkey; see the mobile phone operating instructions).

▶ Enter the same passkey in the mobile phone as the one already entered in COMAND.

The message **Connecting Bluetooth Profiles...** appears.

The **Authorization successful** message appears once authorization is completed.

The mobile phone is authorized and connected to COMAND. You can now make phone calls using the COMAND hands-free system.

i After entering the passkey, you may also need to enter a confirmation in your mobile phone to connect calls. Please check your mobile phone display. On some mobile phones, this confirmation can be saved. In this case, you do not need to enter it again. If the COMAND display shows the **Authorization failed** message, you may have exceeded the prescribed time period. Repeat the procedure.

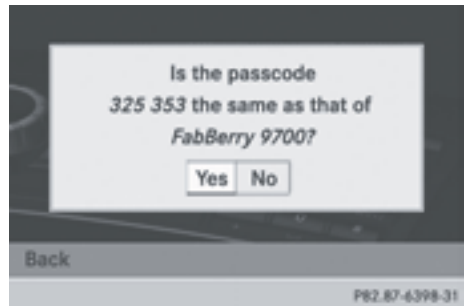

Option 2: use Secure Simple Pairing

The mobile phone (or the Bluetooth® audio device) must support the Bluetooth® version 2.1 for connection via Secure Simple Pairing. COMAND creates a six-digit code, which is displayed on both devices that are to be connected.

- ▶ If the code is the same on both devices, confirm **Yes** by pressing . If you select **Yes**, authorization is continued and the mobile phone is connected. If you select **No**, the process will be canceled.
- ▶ Confirm the message on the mobile phone.





External authorization



If COMAND does not detect your mobile phone, this may be due to particular security settings on your mobile phone. In this case, you can test if your mobile phone can find COMAND. The Bluetooth® device name of COMAND is **"MB Bluetooth"**.



Please note the following: some mobile phones require that you establish the

connection to COMAND again once you have entered the passkey (see the mobile phone operating instructions). The mobile phone cannot otherwise be authorized.

- ▶ Press the **TEL** function button on COMAND.
- ▶ Select **Connect Device** in the telephone basic menu by sliding  and turning  the COMAND controller and press  to confirm.
The Bluetooth® phone list appears (▶ page 359).
- ▶ Select **Connect via Phone** and press the  button to confirm.
The message on the left appears.
- ▶ Start the Bluetooth® search on the mobile phone; see the mobile phone operating instructions.
- ▶ Select COMAND (**MB Bluetooth**) on the mobile phone.
- ▶ **Option 1:** when requested to do so, enter the passkey first on the mobile phone and then in COMAND.
- ▶ **Option 2:** confirm the displayed codes on the mobile phone and in COMAND (Secure Simple Pairing).
With both options, you see the prompt **Do you want <device name> to be authorized?** on the COMAND display.
- ▶ If you select **Yes**, the mobile phone will be authorized. The messages **Waiting for a Connection to <name of B-tooth dev.>** and **Connecting Bluetooth Profiles...** are displayed. If the connection is successful, you see the telephone basic menu and the connected mobile phone is entered.
If you select **No**, the process will be canceled.

Switching between mobile phones

If you have authorized more than one mobile phone, you can switch between the individual phones.

- ▶ Select the mobile phone in the Bluetooth® telephones list by turning  the COMAND controller and press  to confirm.







The selected mobile phone is searched for and connected if it is within Bluetooth® range and if Bluetooth® is activated.

Only one mobile phone can be connected at any one time. The currently connected mobile phone is indicated by the • dot in the Bluetooth® telephones list.

- ▶ **i** You can only switch to another authorized mobile phone if you are not currently making a call.

De-authorizing (de-registering) a mobile phone

Mercedes-Benz USA, LLC recommends de-authorization in COMAND and on the mobile phone. Subsequent authorization may otherwise fail.

- ▶ Press the **TEL** function button on COMAND.
- ▶ Select **Connect Device** in the telephone basic menu by sliding  and turning  the COMAND controller and press  to confirm.
The Bluetooth® phone list appears (▶ page 359).
- ▶ Select the desired mobile phone in the Bluetooth® telephones list.
- ▶ Select the list symbol to the right of the entry by sliding  the COMAND controller and press  to confirm.
- ▶ Select **De-authorize** and press  to confirm.
A prompt appears asking whether you really wish to de-authorize this device.
- ▶ Select **Yes** or **No**.
If you select **Yes**, the device will be deleted from the Bluetooth® telephones list.
If you select **No**, the process will be canceled.

- i** Before re-authorizing the mobile phone, you should also delete the device name **MB Bluetooth** from your mobile phone's Bluetooth® list.

Displaying connection details

- ▶ Press the **TEL** function button on COMAND.
- ▶ Select **Connect Device** in the telephone basic menu by sliding **⊙↕** and turning **⊕⊙** the COMAND controller and press **⊕** to confirm.

The Bluetooth® phone list appears (▶ page 359).

- ▶ Select the desired mobile phone in the Bluetooth® telephones list.
- ▶ Select the list symbol to the right of the entry by sliding **⊙→** the COMAND controller and press **⊕** to confirm.
- ▶ Select **Details** and press **⊕** to confirm. The following information concerning the selected mobile phone is shown:
 - Bluetooth® name
 - Bluetooth® address
 - availability status (shown after a new search)
 - authorization status
- ▶ **To close the detailed view:** turn **⊕⊙** or slide **←⊙→** the COMAND controller.

Telephone basic menu (Bluetooth® interface)

Basic menu display



Telephone basic menu (Bluetooth® interface)

- ① Telephone status
- ② Signal strength of mobile phone network
- ③ Receiver icon or
- ④ To display call lists
- ⑤ Character bar
- ⑥ Bluetooth® name of the currently connected mobile phone
- ⑦ To display the COMAND phone book

- ▶ Press the **TEL** function button.

The basic telephone menu appears when the connected mobile phone is ready for use.

- i** Display ① may vary, depending on the mobile phone connected.
- Bars ② show the current signal strength of the mobile phone network. If all bars are filled, you have optimum reception.
- If no bars are shown, reception is either very poor or there is none at all.
- Receiver symbol ③ shows whether a call is active/being connected or not .

Text message display in telephone basic menu

The **Text Message** menu item is only available if the Bluetooth® phone supports the MAP Bluetooth® profile (**M**essage **A**ccess **P**rofile). The downloading of text messages

from the Bluetooth® phone must have been completed. The menu item is otherwise grayed out. Further information on SMS (▷ page 375).

If you have an unread text message, the ✉ mail symbol is displayed. The symbol disappears once you have read the text message. The ✉ mail symbol is displayed as soon as the text message memory is full. The symbol disappears once you delete at least one text message.

Reception and transmission volume

Once the mobile phone has been authorized, you can optimize the transmission and reception volume settings. Find out more about the optimum settings for your mobile phone online at

<http://www.mbusa-mobile.com>.

Alternatively, call the Mercedes-Benz Customer Assistance Center at 1-800-FOR-MERcedes(1-800-367-6372) (USA) or Customer Relations at 1-800-387-0100 (Canada).

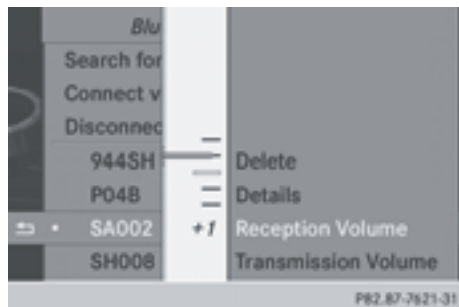

- ▶ Press the **TEL** function button.
- ▶ Select **Connect Device** in the telephone basic menu by sliding **⊙↓** and turning **Ⓢ** the COMAND controller and press **Ⓢ** to confirm.

- ▶ Select an authorized mobile phone from the list by turning **Ⓢ**.
- ▶ Select the list symbol to the right of the entry by sliding **⊙→** the COMAND controller and press **Ⓢ** to confirm.
- ▶ Select **Reception Volume** or **Transmission Volume** and press **Ⓢ** to confirm.
- ▶ Select a volume setting by turning **Ⓢ** the COMAND controller.
- ▶ **To close the setting scale:** press **Ⓢ** or slide **←⊙→**.

i Incorrect settings may have an impact on the quality of calls.

Telephone operation

Incoming call

Accepting a call

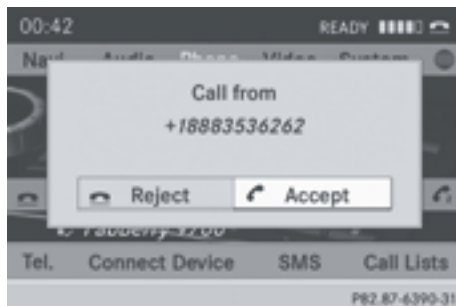

Example: incoming call

- ▶ **To accept:** confirm **Accept** by pressing **Ⓢ**.

or

- ▶ Press the **☎** button on COMAND or on the multifunction steering wheel.



i You can also accept the call by voice command using Voice Control (see the separate operating instructions).

Once you have accepted the call, you can use hands-free mode. The call volume can be adjusted (▷ page 277). Other functions during a call (▷ page 366).



If the phone number of the caller is transferred, it appears in the display. If there is an entry for the caller in the phone book, you will also see the name. If the phone number is not transferred, **Unknown** appears in the display.

- ▶ **i** You can also accept a call as described above when another main function is switched on in COMAND. Once you have accepted the call, the display switches to telephone mode. After the call is finished, you see the display of the previous main application again.

The display does not switch to telephone mode if you:

- press the  back button next to the COMAND controller and then
- accept the call using the  button on the multifunction steering wheel

Rejecting a call

- ▶ **To reject:** select **Reject** by turning  the COMAND controller and press  to confirm.

or



- ▶ Press the  button on COMAND or on the multifunction steering wheel.



Making a call

With the number keypad

- ▶ Call up the telephone basic menu (▷ page 363).
- ▶ Enter the digits using the number keypad.
- ▶ **To connect the call:** press the  button on COMAND or on the multifunction steering wheel.

Using the telephone basic menu



- ▶ Call up the telephone basic menu (▷ page 363).
- ▶ Select the digits one by one by turning  and sliding  the COMAND controller and press  to confirm.

- ▶ **To make a call:** select  in the character bar and press  to confirm.

or

- ▶ Press the  button on COMAND or on the multifunction steering wheel.

Redialing

- ▶ Call up the telephone basic menu (▷ page 363).
 - ▶ Select  in the character bar and press  to confirm.
- or
- ▶ If the telephone basic menu is displayed, press the  button on COMAND. In both cases, the calls dialed list appears. The most recently dialed number is at the top.

- ▶ **To select a call:** turn  the COMAND controller.

- ▶ **To connect the call:** press  the COMAND controller.

Using the call list or COMAND phone book

- ▶ Open a call list and select an entry (▷ page 372).

or

- ▶ Call up the COMAND phone book and select an entry (▷ page 369).

- ▶ **To make a call:** press  the COMAND controller or the  button.

Making a call via speed dial

The speed dial list contains stored entries from the phone book (▷ page 374).

Option 1:

- ▶ Hold down one of the number keys for longer than two seconds. The basic telephone menu displays the selected entry. This initiates dialing.

Option 2:

- ▶ Call up the telephone basic menu (▷ page 363).
- ▶ Select **Call Lists** by sliding $\odot \downarrow$ and turning $\left[\odot \right]$ the COMAND controller and press \odot to confirm. A menu appears.
- ▶ Select **Speed Dial Preset List** by turning $\left[\odot \right]$ the COMAND controller and press \odot to confirm. The speed dial list appears.
- ▶ Select preset and press \odot to confirm. The basic telephone menu displays the selected entry. This initiates dialing.

Functions available during a call**Overview**

Telephone operation with a single call

- ① Person you are calling
- ② Symbol for active telephone connection
- ③ To switch the hands-free microphone off/ on (▷ page 366)
- ④ To send DTMF tones (not possible with all mobile phones) (▷ page 366)
- ⑤ To end a call

Available functions:

- accepting a waiting call (▷ page 367)
- making a further call (▷ page 367)
- toggling (▷ page 368)

Availability depends on the network (only possible in the GSM network) and on the Bluetooth® mobile phone.

Switching the hands-free microphone on/off

This function is also available during an active phone call.

- ▶ Call up the telephone basic menu (▷ page 363).
- ▶ **To switch off:** select **Mic Off** and press \odot to confirm. If the microphone is switched off, the display shows the \otimes symbol and the **The microphone is off** message appears for a short period.
- ▶ **To switch on:** select **Mic On** and press \odot to confirm. The \otimes symbol disappears. You will briefly see the **The microphone is on** message.

Sending DTMF tones





This function is not supported by all mobile phones.

Answering machines or other devices can be controlled by DTMF tones, e.g. for remote query functions.

- ▶ If you would like to listen to the messages on your answering machine, for example, dial the corresponding number.
- ▶ **To transmit individual characters:** once a connection has been established to the answering machine, select the desired

characters in the character bar and press  to confirm each one.

or

- ▶ Press the corresponding key on the COMAND number keypad. Every character selected will be transmitted immediately.
- ▶ **To send a phone book entry as a DTMF sequence:** select **Name** by turning  the COMAND controller and press  to confirm.
- ▶ Select the desired phone book entry and press  to confirm. The entry is sent as a DTMF character string.
- ▶ **To return to the call display:** select **Back** and press  to confirm.

i You can also send DTMF tones using the Voice Control System (see the separate operating instructions).

Calls with several participants



Rejecting or accepting a waiting call

The mobile phone network provider must support and activate the call-waiting function. Depending on the mobile phone used, the system behavior differs when accepting a call.

If you have a call in progress and receive another call, a new window appears in the display. You also hear a tone. You can accept or reject the call.

- ▶ **To reject:** select **Reject** and press  to confirm.

or

- ▶ Press the  button on COMAND or on the multifunction steering wheel.
- ▶ **To accept:** select **Accept** and press  to confirm.

or

- ▶ Press the  button on COMAND or on the multifunction steering wheel.

The system behavior after accepting the incoming call depends on your mobile phone.

- The mobile phone supports the call waiting function (via Bluetooth®) when: the previously active call is held. You can then switch back and forth between both calls (toggling) (▷ page 368).
- The mobile phone does not support the call waiting function (via Bluetooth®) when: the previously active call is ended. This is also the case if you accept the waiting call using Voice Control (see the separate operating instructions).



The COMAND display changes. If you continue to operate functions on the mobile phone, the COMAND display may differ from that of the mobile phone.

Making a second call

If your mobile phone allows you to make a second call via Bluetooth®, you can make another call while on the phone with someone else. This action puts the previous call on hold. The function is available.



i Symbol for making a second call

- ▶ Select symbol **i** by turning  the COMAND controller and press  to confirm.

or

- ▶ Press the  button on COMAND.
- ▶ Enter the phone number:
 - manually (▷ page 365)
 - using the phone book (▷ page 369)

- using the call lists (▷ page 372)
- using speed dial (▷ page 365)

Call waiting

You can switch back and forth between calls with this function. The function is available if your mobile phone supports the toggling function (via Bluetooth®).

You can use the function if you are answering a second call or making a second call.



Switching between the active call and the call on hold

- ① Active call
- ② Call on hold

▶ Select symbol ② and press to confirm.

or

▶ Press the button on COMAND or on the multifunction steering wheel.
The previous call on hold is activated.

▶ **To end the active call:** select in the telephone basic menu and press to confirm.

or

▶ Press the button on COMAND or on the multifunction steering wheel.
The call on hold is activated.

Conference call

You can interconnect calls (active and on hold) on the mobile phone. This permits several parties to hear one another and speak with one another (see the mobile phone operating instructions).

You can also make a further call in COMAND (▷ page 367).

Using the phone book

Introduction

The phone book displays the names and phone numbers of all of the address book entries saved in the COMAND address book. If an address book entry does not have a telephone number, it does not appear in the phone book.

The phone book of the mobile phone is automatically downloaded to COMAND after connection.

In the telephone book, you can:

- save phone numbers (▷ page 370)
- search for entries (▷ page 369)
- delete entries (▷ page 370)
- import contacts (▷ page 383)
- delete contacts (▷ page 384)
- receive vCards (▷ page 384)

i The stored phone book and the vCards remain in COMAND even if you use COMAND with another mobile phone. The entries can be viewed without a mobile phone. For this reason, you should delete any phone book entries before handing over or selling the vehicle.

Calling up the phone book

Overview

- ▶ Press the function button.
- ▶ Select **Name** in the telephone basic menu by turning the COMAND controller and press to confirm.

If the phone book contains entries, they will be displayed in alphabetical order. The character bar at the bottom of the display is active.

The character bar is used for fast selection of an entry.

Enter the character using the character bar (▷ page 281).



- ▶ **To close the phone book:** select in the character bar by sliding and turning the COMAND controller and press to confirm.

or

- ▶ Press the back button.

Symbol overview

Sym bol	Explanation
	Address book entry that has been entered or changed via COMAND Imported contact that has been saved in the phone or address book
	Address book entry with voice tag These entries have also been assigned a voice tag. Voice tags are available in vehicles with Voice Control (see the separate operating instructions).
	Contact that has been imported from a mobile phone that supports PBAP
	Entry that has been imported from the memory card or USB device
	Entry imported via the Bluetooth® interface

Searching for a phone book entry

Using the character bar

You determine the first letter of the entry you are looking for with the first character you enter.

- ▶ Select a character by turning the COMAND controller and press to confirm.

The first entry in the list that starts with the letter selected is highlighted. If there are similar entries, the next different character is shown. For example, with entries such as **Christel** and **Christine**, the beginnings of the names are similar. In this case, you will be offered a choice between **E** and **I**.

- ▶ Select the characters of the entry you are searching for one by one and press to confirm.

When the selection is clear, COMAND switches automatically to the selection list.

- ▶ **To complete the search:** slide the COMAND controller repeatedly or press and hold until the character bar disappears.

The selection list appears.

Information about character entry (▷ page 281)

Using the number keypad

You can enter digits using the number keypad (direct entry) (▷ page 283).

Selecting an entry directly from the list

You can switch to the list at any time during character entry.





- ▶ Slide the COMAND controller repeatedly or press and hold until the character bar disappears.

or

- ▶ Select and press to confirm.





- ▶ **To select an entry:** turn the COMAND controller until the desired entry is highlighted and press to confirm.

To select a phone number: the  symbol indicates that an entry contains more than one phone number.

- ▶ Select a phone book entry with the  symbol and press  to confirm. The sub-entries appear. The  symbol changes to .







Phone book entry with several entries

- ▶ Select a sub-entry by turning  and press  to confirm.
- ▶ **To return to the phone book using the character bar:** select  in the list and press  to confirm.

or

- ▶ Press the  back button.

Displaying details for an entry

- ▶ Select an entry in the selection list by turning  the COMAND controller.
- ▶ Select the list symbol to the right of the entry by sliding  the COMAND controller and press  to confirm.
- ▶ Select **Details** and press  to confirm. The detailed view appears.
- ▶ **To close the detailed display:** slide  repeatedly until the entry is highlighted again.





or

- ▶ Press the  back button.

Deleting an entry from the phone book





If the entry contains only phone numbers, it is deleted from the phone book and address book.

If it contains additional data, such as a navigable destination, the entry is deleted in the phone book. However, the entry is retained in the address book.

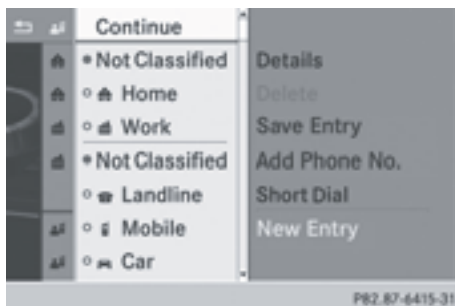
- ▶ Select an entry in the selection list by turning  the COMAND controller.
- ▶ Select the list symbol to the right of the entry by sliding  the COMAND controller and press  to confirm.
- ▶ Select **Delete** and press  to confirm. A prompt appears asking whether the entry should be deleted.
- ▶ Select **Yes** or **No** and press  to confirm. If you select **Yes**, the entry is deleted in accordance with the rules described above. If you select **No**, the process will be canceled.

Creating a new entry in the phone book



- ▶ Slide  the COMAND controller repeatedly in the phone book until the selection list appears.
- ▶ Select the list symbol on the right in the selection list by sliding  the COMAND controller and press  to confirm.
- ▶ Select **New entry** and press  to confirm.
- ▶ Select a category for the number, e.g. **Home**, and press  to confirm.

- ▶ Select a category for the phone, e.g. **Mobile**, and press to confirm.
- ▶ Select **Continue** and press to confirm. The input menu with data fields appears.



- ① Selected data field with cursor
- ② Character bar
- ▶ Entering characters (▷ page 281)
- ▶ Storing an entry (▷ page 282)
The entry is created in the phone book and in the address book.

Adding to a phone book entry

You can add telephone numbers to an existing phone book entry.

- ▶ Select an entry in the selection list by turning the COMAND controller.
- ▶ Select the list symbol to the right of the entry by sliding the COMAND controller and press to confirm.
- ▶ Select **Add Phone no.** and press to confirm.
- ▶ Select a category for the number, e.g. **Home**, and press to confirm.
- ▶ Select a category for the phone, e.g. **Mobile**, and press to confirm.
- ▶ Select **Continue** and press to confirm. COMAND stores the data if there are fewer than five numbers assigned to the entry you are searching for in the selected number category.

If five numbers are stored for the entry in the selected number category, a prompt

will appear. You can then choose whether to overwrite one of the existing numbers.

- ▶ Select **Yes** or **No** and press to confirm. If you select **Yes**, a selection list will appear containing the five existing numbers. If you select **No**, the process will be canceled.
- ▶ Select the number to be overwritten by turning the COMAND controller and press to confirm. An input menu appears. The data field for entering the new phone number is highlighted.
- ▶ Enter characters (▷ page 281)

Using call lists

Introduction

While the telephone is being used, COMAND stores individual lists for both incoming and outgoing calls (including missed calls). Call lists are not available unless a mobile phone is connected to COMAND.

COMAND supports the PBAP Bluetooth® profile. How COMAND processes call lists depends on the model of the mobile phone connected:

- Bluetooth® telephone with PBAP Bluetooth® profile:
The call lists are downloaded automatically from the mobile phone by COMAND as soon as the mobile phone is connected to COMAND.
- Bluetooth® telephone without PBAP Bluetooth® profile:
COMAND creates the call lists from both incoming and outgoing calls (including missed calls) as soon as the mobile phone is connected to COMAND.

- i** For Bluetooth® telephones without the PBAP Bluetooth® profile, the call lists in COMAND are not synchronized with those on your mobile phone. These calls may or

may not be listed on your mobile phone, depending on the model.

i If no mobile phone is connected, then the **Call Lists** menu item is grayed out and cannot be selected. If you connect a mobile phone other than the previous one to COMAND, the previously available call lists and their entries will be deleted automatically. They are still available on the mobile phone itself.

i You will only be able to select the respective menu items once calls have been received or dialed from COMAND. Displaying missed calls in the COMAND display is not supported by all mobile phones.

Opening the call list and selecting an entry

- ▶ Press the **TEL** function button.
- ▶ Select **Call Lists** in the telephone basic menu by sliding **○↓** and turning **Ⓜ** the COMAND controller and press **Ⓜ** to confirm.
A menu appears.

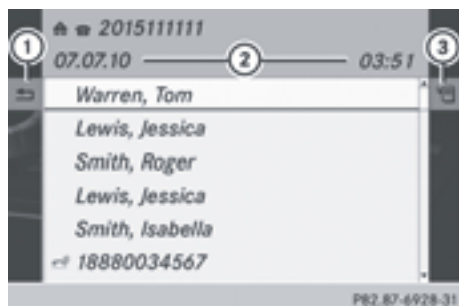

List of selected phone numbers (example)

- ① To close the list
- ② Date/time (if available), symbols (if assigned) and telephone number of the entry highlighted
- ③ To call up options

- ▶ Select **Calls Received** or **Calls Dialed** by turning **Ⓜ** and press **Ⓜ** to confirm.
The corresponding list appears.

i You can also call up the list of dialed calls by pressing the **☎** button when the telephone basic menu is shown. In this case, the list will only show phone numbers.

- ▶ Select an entry by turning **Ⓜ** the COMAND controller.

▶ **To dial a phone number:** press **Ⓜ**.

▶ **To close the list:** select the **☐** symbol and press **Ⓜ** to confirm.

or

▶ Press the **☐** back button.

Displaying details from a list entry

COMAND can also show a shortened list entry in full.

- ▶ Select a list entry by turning **Ⓜ** the COMAND controller.
- ▶ Select the list symbol to the right of the entry by sliding **○→** the COMAND controller and press **Ⓜ** to confirm.
- ▶ Select **Details** and press **Ⓜ** to confirm.
The detailed view appears.
- ▶ **To go back to the list:** slide **←○→** repeatedly until the list is highlighted.

Storing a phone number

New address book entry

For incoming calls from a person who is not in the address book, COMAND displays the phone number in the call list. You can save this entry.

- ▶ Open a call list and select an entry (▷ page 372).
- ▶ Select the list symbol to the right of the entry by sliding **○→** the COMAND controller and press **Ⓜ** to confirm.

- ▶ Select **Save** and press to confirm.
- ▶ Select **New Entry** and press to confirm.
- ▶ Select a category for the number, e.g. **Home**, and press to confirm.
- ▶ Select a category for the phone, e.g. **Mobile**, and press to confirm.

Number category	Display (phone book and address book)
Not Classified	No symbol
Home	
Work	

Telephone category	Display (phone book and address book)
Not Classified	
Mobile Phone	
Car	
Pager	

- ▶ Select **Save** and press to confirm.
An input menu with data fields is shown. The data field for the telephone number is filled in automatically.

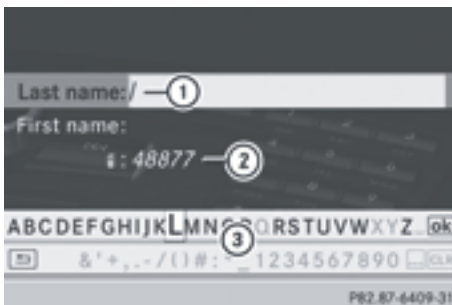

- ① Data field with cursor
- ② Telephone number and symbol for the phone category (automatically entered)
- ③ Character bar

Adding information to an address book entry

For incoming calls from a person who is not in the address book, COMAND displays the phone number in the call list. You can save this entry.

- ▶ Open a call list and select an entry (▷ page 372).
- ▶ Select the list symbol to the right of the entry by sliding the COMAND controller and press to confirm.
- ▶ Select **Save** and press to confirm.
- ▶ **Save** is shown in gray if the selected list entry has already been saved.
- ▶ Select **Add Phone No.** and press to confirm.
- ▶ Select a category for the number, e.g. **Home**, and press to confirm.
- ▶ Select a category for the phone, e.g. **Mobile**, and press to confirm.
- ▶ Select **Save**.
The search menu for address book entries appears.
- ▶ Search for the desired entry (▷ page 369).
- ▶ Press when you have finished searching. COMAND stores the data if there are fewer than five numbers assigned to the entry you are searching for in the selected number category.

You will see a message to this effect.

If five numbers are stored for the entry you are searching for, a prompt will appear asking whether you wish to overwrite one of the existing numbers.

- ▶ Select **Yes** or **No** and press to confirm. If you select **Yes**, a selection list with the five existing numbers is displayed.

If you select **No**, the process will be canceled.

- ▶ Select the number to be overwritten in the list by turning **⏏** the COMAND controller and press **⏏** to confirm.

COMAND overwrites the selected number with the new data.

Deleting call lists

If you are using a Bluetooth® phone that does not support the PBAP Bluetooth® profile, the call lists are generated and managed by COMAND. You can delete these call lists in COMAND.

If you download call lists from a Bluetooth® phone that supports the PBAP Bluetooth® profile, you cannot delete them from COMAND.

- ▶ Select **Call Lists** in the telephone basic menu by turning **⏏** the COMAND controller and press **⏏** to confirm.
- ▶ Select **Delete Call Lists** and press **⏏** to confirm.
A prompt appears asking whether you wish to delete all call lists.
- ▶ Select **Yes** or **No** and press **⏏** to confirm.
If you select **Yes**, the call lists are deleted.
If you select **No**, the process will be aborted.

- i** If you delete these call lists from the mobile phone (see the separate mobile phone operating instructions), COMAND updates the call list display the next time it connects.

Using the speed dial list

Storing an entry

You can assign ten speed dial presets (0 – 9) to the speed dial list. There are two options available for this purpose.

Option 1:

- ▶ Search for a phone book entry in the phone book (▶ page 369).
- ▶ If an entry has several phone numbers, select the desired number by turning **⏏** the COMAND controller.
- ▶ Select the list symbol to the right of the entry by sliding **⏏** the COMAND controller and press **⏏** to confirm.
A menu appears.
- ▶ Select **Speed Dial** by turning **⏏** the COMAND controller and press **⏏** to confirm.
A menu appears.

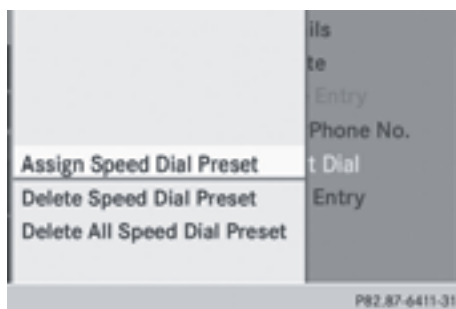

Speed dial menu

- ▶ Select **Assign Speed Dial Preset** and press **⏏** to confirm.
The speed dial list appears. The selected phone book entry is listed as the first entry. The next available speed dial preset is highlighted.

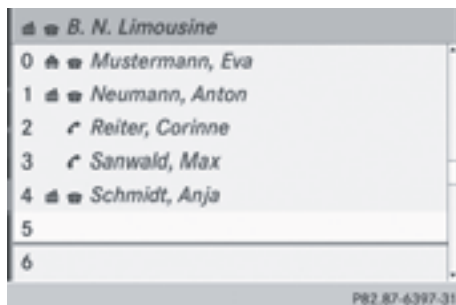

- ▶ Select the speed dial preset by turning the COMAND controller and press to confirm.
The phone book entry is saved in the speed dial preset.

Option 2

- ▶ Call up the telephone basic menu (▷ page 363).
- ▶ Select **Call Lists** by sliding and turning the COMAND controller and press to confirm.
- ▶ Select **Speed Dial Preset List** and press to confirm.
The speed dial list appears.
- ▶ Select the list symbol to the right of the entry by sliding the COMAND controller and press to confirm.
- ▶ Select **Assign Speed Dial Preset** and press to confirm.
- ▶ Proceed as described under option 1.

Making a call via speed dial

The speed dial list contains stored phone book entries (▷ page 374).

Option 1:

- ▶ Hold down one of the number keys for longer than two seconds.
The basic telephone menu displays the selected entry. This initiates dialing.

Option 2:

- ▶ Call up the telephone basic menu (▷ page 363).
- ▶ Select **Call Lists** by sliding and turning the COMAND controller and press to confirm.
The speed dial list appears.

- ▶ Select **Speed Dial Preset List** by turning the COMAND controller and press to confirm.
The speed dial list appears.
- ▶ Select preset and press to confirm.
The basic telephone menu displays the selected entry. This initiates dialing.

Deleting a speed dial number

- ▶ **To delete a speed dial number:** select **Delete Speed Dial Preset** in the "Speed dial" menu by turning the COMAND controller and press to confirm.
The speed dial number is deleted.
- ▶ **To delete all speed dial numbers:** select **Delete All Speed Dial Presets** in the "Speed dial" menu by turning the COMAND controller and press to confirm.
You will be asked whether you want to continue.
- ▶ Select **Yes** or **No** and press to confirm.
If you select **Yes**, all speed dial presets will be deleted from the speed dial list.
If you select **No**, the process will be canceled.

Text messages (SMS)

Information and requirements

If the above conditions are met, new incoming text messages appear in the COMAND text message inbox. In addition, a tone sounds and the symbol appears. The symbol is no longer displayed once you have read the text message. The mail symbol is displayed if the text message memory is full. The symbol is no longer displayed once you delete at least one text message.

- COMAND may not load all of the most recent text messages:

This may occur in exceptional cases, for example when using certain mobile phones/brackets and if the mobile phone inbox holds a large number of text messages.

- ▶ In order to be able to use the text message function, the Bluetooth® mobile phone has to support Bluetooth® MAP (Message Access Profile).

Displaying the text message inbox

Overview



Text message inbox

- ▶ Press the **TEL** function button.
- ▶ Select **Text Message** in the telephone basic menu by turning **⏻** the COMAND controller and press **⏻** to confirm. The text message inbox appears.

Reading a text message

- ▶ Select a text message in the text message inbox by turning **⏻** the COMAND controller and press **⏻** to confirm. The text message appears.
- ▶ **To scroll through the display or select phone numbers in a text message:** turn **⏻** the COMAND controller. The display scrolls up or down line by line, or skips to the next or previous telephone number and automatically highlights it.
- ▶ **To return to the list:** press **⏻** and select **Back**.

Text message read-aloud function

Settings for the read-aloud function:

- language (▷ page 292)
- speed (▷ page 291)
- ▶ Press **⏻** while a text message is being displayed, then select **Read Aloud** and press **⏻** to confirm. COMAND reads out the text message.

- ▶ **To cancel the read-aloud function:** press the **⏻** button.

or

- ▶ Press **⏻**, select **Cancel Read-Aloud Function** and press **⏻** to confirm.

Switching the display

You can switch between displaying the text message sender or the text message content. The sender display shows the sender of the text message. If the sender is stored in the COMAND phone book, the name is displayed. The text display shows the first few words of a text message.

- ▶ Select a text message in the text message inbox by turning **⏻** the COMAND controller.
- ▶ **To switch to the text display:** select the list symbol to the right of the text message by sliding **⏻** the COMAND controller and press **⏻** to confirm.
- ▶ Select **Display Text** and press **⏻** to confirm. The view changes.
- ▶ **To switch to the sender display:** select the list symbol to the right of the text message by sliding **⏻** the COMAND controller and press **⏻** to confirm.
- ▶ Select **Display Sender** and press **⏻** to confirm. The view changes.
- ▶ **To return to the telephone basic menu:** press the **BACK** button.

Displaying details and phone numbers

COMAND can also show a shortened sender display in full.

- ▶ Select a text message in the text message inbox by turning **⏏** the COMAND controller.
- ▶ Select the list symbol to the right of the text message by sliding **⏏** the COMAND controller and press **⏏** to confirm.
- ▶ Select **Details** and press **⏏** to confirm. The detailed view appears.
- ▶ **To close the detailed view:** slide **⏏** the COMAND controller.
- ▶ **To return to the telephone basic menu:** press the **BACK** button.

Managing text messages

Calling a text message sender

- ▶ Press **⏏** the COMAND controller while the text message is being displayed.
- ▶ Select **Call Sender** and press **⏏** to confirm. The telephone makes the call to the sender.

Using phone numbers in the text

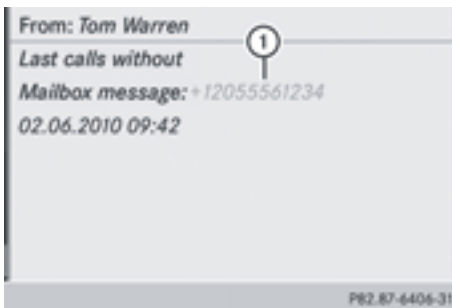

- ① Usable numerical sequence

Numbers in text messages that are highlighted in red can be used.

- ▶ Select a usable number when the text message is displayed.

- ▶ Press **⏏** the COMAND controller and select **Use**.
- ▶ Select **Call**. The telephone makes the call.

i It is possible that a highlighted numerical sequence may not contain a telephone number.

i You can use the "New entry" or "Add no." functions to save this telephone number or to add it to an existing entry.

Storing the sender of a text message in the address book

This function is not available if the sender's telephone number is already stored in the address book.



- ▶ Press **⏏** the COMAND controller while the text message is being displayed.
- ▶ Select **Save Number** and press **⏏** to confirm.
- ▶ Select **New Entry** and press **⏏** to confirm.
- ▶ For further procedures, see (▷ page 372).

Adding the sender of a text message to an address book entry

- ▶ Press **⏏** the COMAND controller while the text message is being displayed.
- ▶ Select **Save Number** and press **⏏** to confirm.
- ▶ Select **Add Phone No.** and press **⏏** to confirm.
- ▶ Proceed from the step "Select a category for the number" (▷ page 371).

Deleting a text message

- ▶ Select a text message in the text message inbox by turning **⏏** the COMAND controller.
- ▶ Select the list symbol to the right of the text message by sliding **⏏** the COMAND controller and press **⏏** to confirm.

- ▶ Select **Delete** and press  to confirm. A deletion prompt appears.
- ▶ Select **Yes** or **No** and press  to confirm. If you select **Yes**, the text message is deleted. If you select **No**, the process will be aborted.

i This delete function is not supported by all mobile phones. The **Delete failed** message appears.

Using the address book

Introduction

WARNING

Always focus your attention on the traffic conditions.

Before starting the journey, familiarize yourself with the address book functions.

Only use COMAND if road and traffic conditions permit. You could otherwise become involved in an accident in which you or others could be injured.

The address book organizes and stores entries which are entered from different sources (mobile phone, memory card, USB storage device, COMAND telephone book, navigation system).

You can use these entries to make telephone calls and for navigation.

i **Number of contacts in the address book:** the address book can store a total of 4000 contacts.

1500 entries each are reserved in the address book for:

- contacts from the mobile phone
- contacts that you create in COMAND or import from other sources

The remaining 1,000 entries are assigned by COMAND as necessary.

i **Display of mobile phone contacts:** contacts downloaded from the mobile phone remain in the address book even if



you disconnect the mobile phone from COMAND. Contacts that have previously been available can be displayed as soon as the mobile phone is reconnected. COMAND downloads the contacts again so that any new contacts that have been added to the mobile phone can be displayed.

Once you connect a new mobile phone to COMAND, all contacts in the address book from the previous mobile phone are replaced by those from the new mobile phone.



Address book entries remain stored when the mobile phone is disconnected. For this reason, delete your personal data using the reset function before selling your vehicle, for example (> page 294).

Calling up the address book

Using the function button:

- ▶ Press the  function button. You see either the telephone basic menu or the address book, depending on which was last active.
- ▶ If the telephone basic menu is displayed, press the  function button again.

Using the telephone basic menu:

- ▶ With the telephone basic menu shown, select **Phone** by sliding  the COMAND controller and press  to confirm.
- ▶ Select **Address Book** from the menu and press  to confirm.

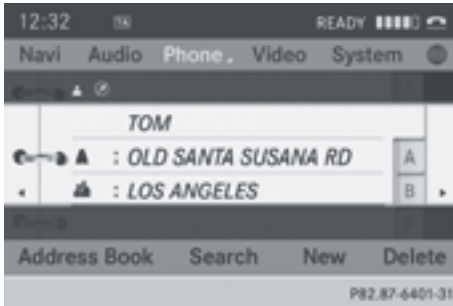

Address book with address book entry and navigable data

► **To browse in the address book:** turn the COMAND controller.

► **To close the address book:** press the **TEL** button.

① An address book entry can contain the following information:

- name
- first name
- company
- two addresses
- geo-coordinates
- up to five telephone numbers

Searching for an address book entry



Search menu with character bar

- ① Address book entry
- ② Complete address data from the navigation system
- ③ Character bar

④ Phone book entry on the mobile phone

⑤ Entry with voice tag

For more symbols, see the symbol overview ([▷ page 369](#)).

► Find an entry ([▷ page 369](#)).

Creating a new entry in the address book

You can enter address data directly into the address book. If you store telephone numbers in the COMAND phone book, these are also saved in the address book. If you store a navigation destination, COMAND creates an address book entry that includes the complete navigable address data.

► Call up the address book ([▷ page 378](#)).

► Select **New** in the address book by sliding and turning the COMAND controller and press to confirm.

An input menu with data fields appears.



Input menu with data fields

① Selected data field with cursor

② Character bar

► Enter characters ([▷ page 281](#))

► Store an entry ([▷ page 282](#))

Deleting an address book entry

► **Option 1:** select **Delete** by sliding and turning the COMAND controller and press to confirm.

- ▶ **Option 2:** search for an address book entry (▷ page 379).
- ▶ Select the list symbol to the right of the entry by sliding the COMAND controller and press to confirm.
- ▶ Select **Delete** and press to confirm. Irrespective of the option chosen, a prompt will appear.
- ▶ Select **Yes** or **No** and press to confirm. If you select **Yes**, the entry will be deleted. If you select **No**, the process will be canceled.

Displaying the detailed view for an address book entry

Selecting an entry



Detailed display of address book

- ① To return to the previous menu
 - ② Business details
 - ③ To call up options
- ▶ Search for an address book entry and turn the COMAND controller to select it in the selection list (▷ page 379).

or

- ▶ Call up the address book and select an entry by turning the COMAND controller (▷ page 378).
- ▶ Press the COMAND controller. The detailed view appears.

Starting route guidance to an address

- ▶ Select the address data field by turning the COMAND controller and press to confirm. The route to the destination address is calculated and route guidance starts (▷ page 303).

Calling a telephone number

- ▶ Select the phone number data field by turning the COMAND controller and press to confirm. This initiates dialing and you can then make your call (▷ page 366).

Showing the details of an address book entry

- ▶ Select the list symbol to the right of the entry by sliding the COMAND controller and press to confirm.
- ▶ Select **Details** and press to confirm. The display is shown in full.
- ▶ **To close the detailed display:** press the back button.

Changing an address book entry

- ▶ **Option 1:** search for an address book entry and turn the COMAND controller to select it in the selection list (▷ page 379).
- ▶ Select the list symbol to the right of the entry by sliding the COMAND controller and press to confirm. A menu appears.

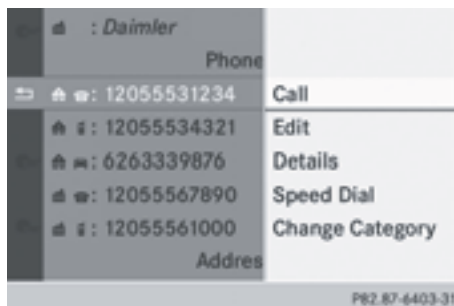

- ▶ Select **Edit** and press to confirm.

- ▶ **Option 2:** call up the detailed view for an address book entry (▷ page 380).
- ▶ Select the list symbol to the right of the entry by sliding the COMAND controller and press to confirm.
- ▶ Select **Edit** and press to confirm. Irrespective of the option, the input menu containing data fields appears.

Information about character entry (▷ page 281)

Changing the category of a telephone number data field

- ▶ Display the detailed view for an address book entry and highlight the telephone number data field (▷ page 380).
- ▶ Select the list symbol to the right of the entry by sliding the COMAND controller and press to confirm.
- ▶ Select **Change Category** and press to confirm.
- ▶ Select a number category, e.g. **Home**.
- ▶ Select a telephone category, e.g. **Mobile Phone**.
- ▶ If desired, select **Preferred** and press to confirm. Depending on the previous status, switch the option on or off . The phone number is displayed as the first number in the phone book and can be dialed immediately.
- ▶ Select **Save** and press to confirm. The new category is stored.

Calling a number stored in an entry

Conditions

The mobile phone must be connected via the Bluetooth® interface (▷ page 359).

Dialing a number

- ▶ Display details for an address book entry (▷ page 380).
- ▶ Select the phone number data field by turning the COMAND controller.

- ▶ Press the COMAND controller to confirm.

or

- ▶ Select the list symbol to the right of the data field by sliding the COMAND controller.
- ▶ Press the COMAND controller to confirm.
- ▶ Select **Call** and press to confirm. The telephone makes the call. The display switches to telephone mode.

Storing the phone number as a speed dial number

- ▶ Display details for an address book entry (▷ page 380).
- ▶ Select the phone number data field by turning the COMAND controller.
- ▶ Select the list symbol to the right of the data field by sliding the COMAND controller and press to confirm.
- ▶ Select **Speed Dial** and press to confirm. You can now store the number in one of the ten speed dial presets (▷ page 374).



Starting route guidance to an entry

Note



This function is available as soon as you have stored a destination in the destination memory (▷ page 339). COMAND also saves destinations in the address book together with all the data required for route guidance.

Address book entry with navigable data

- ▶ Search for an address book entry with the symbol and select it from the list (▷ page 379).

- ▶ Display details for an address book entry (▷ page 380).
- ▶ Select the address data field by turning  the COMAND controller and press  to confirm. Route guidance begins.

or

- ▶ Select the list symbol to the right of the entry by sliding  the COMAND controller and press  to confirm.
- ▶ Select **Navigate** and press  to confirm. Route guidance begins.

Address book entry without navigable data

Route guidance can also be started for an address book entry without the  symbol. If the address data or designations do not match the digital map, COMAND prompts you to re-enter the address.

- ▶ Enter the destination address (▷ page 298).
- ▶ Select **Save** from the address entry menu and press  to confirm.
- ▶ Assign a destination to an address book entry.





-  If you then save the newly entered address under the address book entry, it becomes a navigable address book entry.

Voice tags





Introduction

You can enter voice tags via the Voice Control System (see the separate operating instructions). Once you have assigned a voice tag to an address book entry, you can call up this entry with a voice command and dial a phone number, for example. You can add one voice tag per address book entry.





Adding or changing a voice tag

- ▶ Search for an address book entry with or without a voice tag () (▷ page 379).
- ▶ Select the list symbol to the right of the entry by sliding  the COMAND controller and press  to confirm.
- ▶ Select **Voice Name** and press  to confirm.
- ▶ Select **Add** or **Change** and press  to confirm. Subsequent operation is voice-controlled. The Voice Control System guides you through the dialogs.

Deleting a voice tag

- ▶ Search for an address book entry with a voice tag (▷ page 379).
- ▶ Select the list symbol to the right of the entry by sliding  the COMAND controller and press  to confirm.
- ▶ Select **Voice Name** and press  to confirm.
- ▶ Select **Delete** and press  to confirm. A deletion prompt appears.
- ▶ Select **Yes** or **No** and press the  button to confirm. If you select **Yes**, COMAND deletes the voice tag. If you select **No**, the process will be canceled.

Listening to a voice tag

- ▶ Search for an address book entry with a voice tag (▷ page 379).
- ▶ Select the list symbol to the right of the entry by sliding  the COMAND controller and press  to confirm.
- ▶ Select **Voice Name** and press  to confirm.
- ▶ Select **Listen** and press  to confirm. You hear the voice tag.





Importing phone book entries

This function allows you to store phone book entries from the mobile phone in the address book.



The following can be used as a source:

- the mobile phone
- the memory card
- the USB device
- the Bluetooth® Interface

Imported phone book entries are indicated in the phone book by different symbols (▷ page 369).

- ▶ Search for an entry in the phone book on the mobile phone  (▷ page 369).
- ▶ Select the list symbol to the right of the entry by sliding  the COMAND controller and press  to confirm.
- ▶ Select **Save Entry** and press  to confirm.

The **Data saved.** message appears. The phone book entry is now saved as an address book entry.

The  symbol is replaced by the  symbol.

Importing contacts

Information and requirements

You can import contacts (vCards) from the memory card and a USB device into the address book, or receive vCards via Bluetooth®.

- i** Up to 2500 entries can be imported into the address book. A message notifies you when the maximum number is reached. You then have to delete existing entries in order to import new entries (▷ page 379).

Depending on the source of the contact data, different requirements apply:

Source	Conditions
Memory card	The SD memory card is inserted (▷ page 424). It contains importable contact details.
USB device	The USB device is inserted into the USB port (▷ page 424). It contains importable contact details.

Requirements for receiving vCards via Bluetooth®

You can receive vCards from devices (e.g. from a PC) that support the sending of vCards via Bluetooth®.

It is not necessary to authorize the device in COMAND to do so.

Please bear the following in mind:

- Bluetooth® must be activated in COMAND and on the Bluetooth® device (see the operating instructions for the device).
- the Bluetooth® device must be able to send vCards via Bluetooth® (see operating instructions for the device).
- the Bluetooth® device in the vehicle must be switched on.

Importing from the memory card or USB device

Entries imported from the memory card or from a USB device have the  symbol.

The following conditions must be fulfilled in order to import vCards:

- vCards (vcf files) may be located in the main directory or in folders. COMAND allows you to select the relevant folders directly.
- vCards must have the file extension ".vcf".

- i** A vcf file can also contain several vCards. COMAND supports vCards in versions 2.1 and 3.0.

- ▶ Select **Address Book** in the address book or, if the telephone basic menu is shown,

select **Phone** by sliding $\odot \downarrow$ and turning $\{\odot\}$ the COMAND controller and press \odot to confirm.

- ▶ Select **Download Contacts** and press \odot to confirm.

A menu appears.

- ▶ Select **From The Memory Card** or **From USB device** in the menu by turning $\{\odot\}$ the COMAND controller and press \odot to confirm.

- ▶ Select **Add** or **Overwrite** and press \odot to confirm.

Add imports the entries from the memory card or USB device into the address book.

Overwrite imports the entries from the memory card or USB device and overwrites all entries in the address book with the $\{\text{BT}\}$ symbol. The previous entries are then no longer available.

After the contact data has been imported successfully, you will see a message to this effect. The address book or the respective telephone basic menu is displayed.

- i** You can select **Overwrite** if the address book already contains corresponding entries. A message notifies you when the address book is full.

Receiving vCards via Bluetooth®

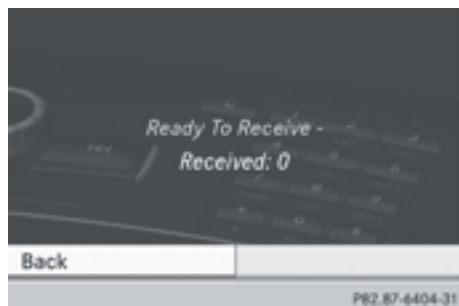

- ▶ Select **Address Book** in the address book or, if the telephone basic menu is shown, select **Phone** by sliding $\odot \downarrow$ and turning

$\{\odot\}$ the COMAND controller and press \odot to confirm.

A menu appears.

- ▶ Select **Download Contacts** and press \odot to confirm.

- ▶ Select **Receive Contacts From Phone** in the menu by turning $\{\odot\}$ the COMAND controller and press \odot to confirm.

This interrupts the Bluetooth® connection between COMAND and your active mobile phone. COMAND is, however, ready to receive vCards from another Bluetooth® device (PC, mobile phone).

- ▶ Start the data transfer on the external Bluetooth® device (see the operating instructions for the device).

The number of vCards received is displayed.

- ▶ **To end data transfer:** press \odot or the $\{\leftarrow\}$ back button.

COMAND then reconnects to the mobile phone.

Received vCards are identified by the $\{\text{BT}\}$ symbol in the address book.

- i** If you switch to another main function, e.g. navigation, while receiving vCards, the import process will be terminated.

Deleting contacts

- ▶ Select **Address Book** in the address book or, if the telephone basic menu is shown, select **Phone** by sliding $\odot \downarrow$ and turning $\{\odot\}$ the COMAND controller and press \odot to confirm.

A menu appears.

- ▶ Select **Delete Contacts** and press \odot to confirm.

- ▶ Select one of the following options:

- **Internal Contacts**
- **Contacts From Storage Device**

- Received Business Cards
- Delete All

A prompt corresponding to your selection appears.

- ▶ Select **Yes** or **No** and press  to confirm. If you select **Yes**, the contacts are deleted according to your selection. If you select **No**, the process will be canceled.

Online and Internet functions

General notes

Conditions for access

To use COMAND Mercedes-Benz Apps and Internet access, the following conditions must be fulfilled:

- mbrace is activated and operational
- mbrace is activated for COMAND Mercedes-Benz Apps and Internet access

Priority of connections: an emergency call has the highest priority. When a service call, e.g. a breakdown service call or the MB Info Call, is active, an emergency call can still be initiated.

A service call, on the other hand, has priority over a current Internet connection. For this reason, you cannot connect to the Internet during a service call.

- i** The availability of individual COMAND Mercedes-Benz Apps may vary depending on the country.
- i** The terms of use are shown when COMAND is used for the first time and then once a year thereafter. Only read and accept the terms of use when the vehicle is stationary.
- i** Internet pages cannot be shown while the vehicle is in motion.

Establishing/ending the connection







Establishing the connection



COMAND (top) or favorite panel

The conditions for establishing a connection are described in "General notes"

(▷ page 385).

- ▶ **1st option:** select the  icon in the main function bar by sliding  and turning  the COMAND controller and press  to confirm. The carousel view appears.
- ▶ Turn  or slide  the COMAND controller until the **COMAND** panel or a favourite is brought to the front, if these have been created (▷ page 408).
- ▶ **2nd option:** enter a web address (▷ page 402).

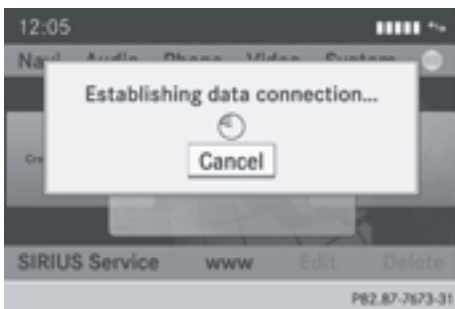

- ▶ For both options, press the COMAND controller. The Internet connection is established. An active Internet connection is identified with symbol ①. The example shows a menu in the Google™ Local Search function (▶ page 386).
- ▶ **To cancel the connection:** while the connection is being established, confirm **Cancel** by pressing .

or

- ▶ Press the button on COMAND or on the multifunction steering wheel.

Ending the connection

You cannot end the connection yourself. The Internet connection is automatically terminated if the system does not recognize any user input within a five-minute time period.

- ▶ The button is inoperative.

Local search

Calling up the local search menu



- ▶ Select the icon in the main function bar by sliding and turning the COMAND controller and press to confirm. The carousel view appears.
- ▶ Bring the **COMAND** panel to the front by turning the COMAND controller and press to confirm. The COMAND menu appears.
- ▶ Bring the **Google Local Search** panel to the front and press to confirm.
- ▶ **To exit the menu:** select **Back** by sliding and turning the COMAND controller and press to confirm.

Search

Entry restriction

It is only possible to enter a search term in the input menu when the vehicle is stationary.

Entering a search term



Input menu

- ▶ Confirm **Search** in the Local search menu by pressing . An input menu appears.
- ▶ **To enter using the character bar:** enter the search term. Enter the character using the character bar (▶ page 281).
- ▶ **To enter characters using the number pad:** press the number keys in rapid succession. The character appears when the key is pressed. The first available letter is highlighted. Entering characters using the number keypad (▶ page 283).

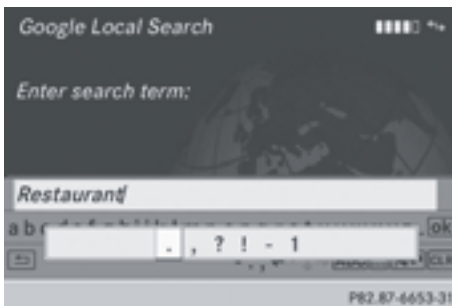

- ▶ After entering the search term, select by turning the COMAND controller and press to confirm. A menu appears. Here, you can select where the POI search should begin.

Selecting the search position

The POI is entered and confirmed.

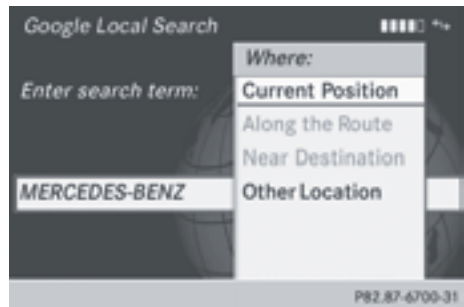

- ▶ Select an entry by turning the COMAND controller and press to confirm. COMAND searches for available POIs for the search term entered:
 - near the current vehicle position
 - along the calculated route
 - near the destination
 - near an address
- ▶ After selecting **Near Destination**, enter an address and confirm. Character entry (▶ page 283). The search results are displayed.

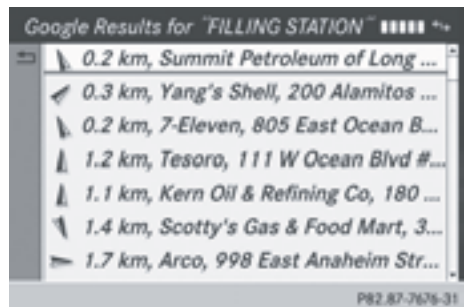

Google™ search results (example)

Using search results

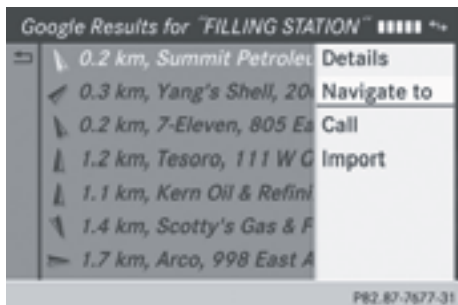

▶ Select an entry in the list of search results by turning **⏪** the COMAND controller and press **⏹** to confirm. A menu appears.

▶ **To show the detailed view:** confirm **Details** by pressing **⏹** the COMAND controller. The address of the selected entry is displayed.

▶ **To use a search result as the destination:** select **Navigate to** by turning **⏪** the COMAND controller and press **⏹** to confirm.

You then switch to navigation mode and can start route calculation (▷ page 303).

i The search result is stored in the "Last destinations" memory at the same time (▷ page 341). You can take the destination from this memory and save it permanently in the destination memory (▷ page 339).

▶ **To call up a destination:** select **Call** with the COMAND controller and press **⏹** to confirm.

You then switch to the telephone function and make the call (▷ page 365).

i The menu item is grayed out if there is no phone number available.

▶ **To import a destination:** select **Import** with the COMAND controller and press **⏹** to confirm.

You can choose whether you want to save the POI as a personal POI on the SD memory card or in the address book.

i If there is no SD memory card in the slot, the **Save As Personal POI** menu item is grayed out.

▶ Insert the SD memory card (▷ page 424).

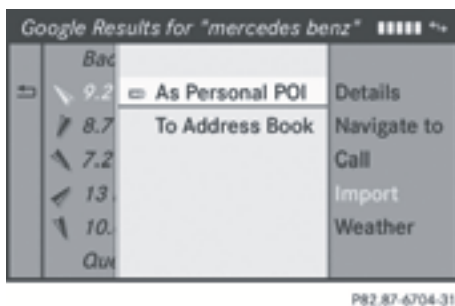

▶ **To save as a personal POI:** confirm **Save As Personal POI** by pressing **⏹** the COMAND controller. The entry is saved as a personal POI on the SD memory card.

i You can use a personal POI in navigation mode for route calculation (▷ page 319). If the personal POI is saved on the SD memory, you can also use it for route calculation in another vehicle.



▶ **To save to the address book:** select **To Address Book** by turning **⏪** the COMAND controller and press **⏹** to confirm.

The entry is stored in the address book.

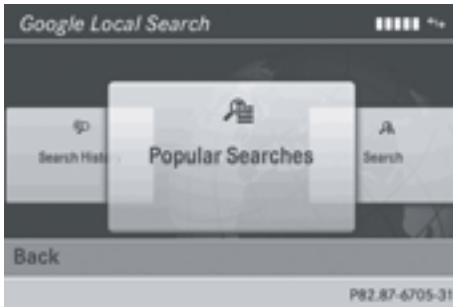
Popular searches



This function allows you to search using predefined search criteria.

- ▶ Bring **Popular Searches** in the local search menu to the front by turning  the COMAND controller and press  to confirm.
A menu displays the available search criteria.

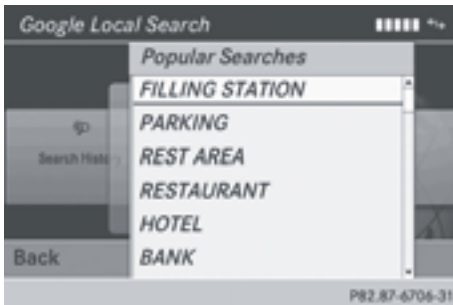



Example: popular Google™ searches

- ▶ Select the search criteria and press  to confirm.
- ▶ Proceed as described in the "Selecting the search position" section (▷ page 387). If the vehicle is stationary, the search results can be supplemented manually, e.g. "Hotel Adler".

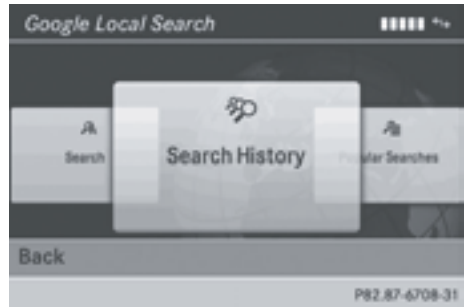
Search History



This function offers you all the previous search queries.

- ▶ Bring **Search history** in the local search menu to the front by turning  the COMAND controller and press  to confirm.
The previous search queries are shown with the most recent at the top.

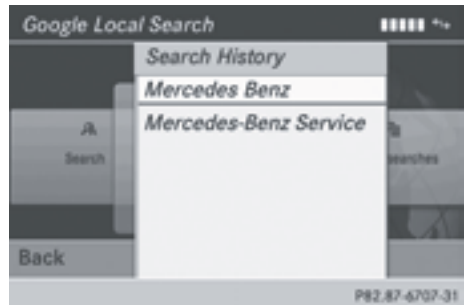

- ▶ Select the search criteria and press  to confirm.
- ▶ Proceed as described in the "Selecting the search position" section (▷ page 387). If the vehicle is stationary, the search results can be supplemented manually, e.g. "Hotel Adler".

Destination/route download

Introduction

You can send destinations and routes from Google™ maps to the server and download these via this function. You can use the

destinations and routes for route guidance and save them for further use.

In order to use the download destination/route function, the mbrace system must be:

- activated
- set up
- and activated for COMAND and Internet access services.







Step 1: sending destinations/routes to the server

- ▶ Call up the website for Google™ maps on the Internet.
- ▶ Select the destination.
- ▶ Select "Mercedes-Benz" as the company entry.
- ▶ Confirm "Send" on the Google™ maps website.
The destinations/routes are sent to the server.

i The availability of the Google™ maps function is country-dependent.

Step 2: downloading destinations/routes from the server

Proceed as follows to use destinations/routes that have been sent to the server:

- ▶ Select the  symbol in the main function bar by sliding  and turning  the COMAND controller and press  to confirm.
The carousel view appears.
- ▶ Bring the **COMAND** panel to the front by turning  the COMAND controller and press  to confirm.
The COMAND menu appears.



▶ Bring the **Dest./Route Download** panel to the front and press  to confirm.

i With **Exit**, you quit the destination/route download.

With **Options**, you set the options for the destination/route download (▷ page 400).

▶ Confirm the **Dest./Route Download** panel by pressing .

Available routes  and destinations

 are shown in the list.



You can save up to 20 routes and 50 destinations for your vehicle on the server and display these in the list. If you send further routes or destinations to the server, the existing entries are deleted from the list.

i The routes/destinations sent from Google™ maps to the server are automatically deleted from there after seven days.

Step 3: using destinations/routes

Calling up the menu



- ▶ Select an entry in the list by turning the COMAND controller and press to confirm. A menu appears.

Displaying details



- ▶ Confirm **Details** in the menu by pressing the COMAND controller. The route or destination is displayed.
- ▶ **To call up a POI:** confirm the entry by pressing .
- i** You can use the function if:
 - a mobile phone is connected (> page 359)
 - the destination address contains a telephone number

Using as the destination



- ▶ Select **Navigate to** in the menu by turning the COMAND controller and press to confirm. You then switch to navigation mode and can start route calculation (> page 303).
- i** A route can only be stored as a personal POI on an SD memory card or taken directly for route calculation (> page 392).

Calling up the destination



- ▶ Select **Call** in the menu by turning the COMAND controller and press to confirm. You then switch to the telephone function and make the call (> page 365).

Importing a destination/route



When importing, you can choose whether you want to save the destination as a personal POI on an SD memory card or in the address book. You can only save routes as personal POIs to an SD memory card, but not in the address book.

- ▶ Select **Import** in the menu with the COMAND controller and press to confirm.
- i** If there is no SD memory card in the slot, the **As Personal POI** menu item is grayed out.
- ▶ Insert the SD memory card (▷ page 424).
- ▶ **To save as a personal POI:** confirm **As Personal POI** by pressing the COMAND controller.
The entry is saved as a personal POI on the SD memory card.
- i** You can use a personal POI in navigation mode for route calculation (▷ page 319).
You can also use a personal POI in another vehicle for route calculation.
- ▶ **To save to the address book:** select **To Address Book** by turning the COMAND controller and press to confirm.
The entry is stored in the address book.

Deleting a destination/route from the server

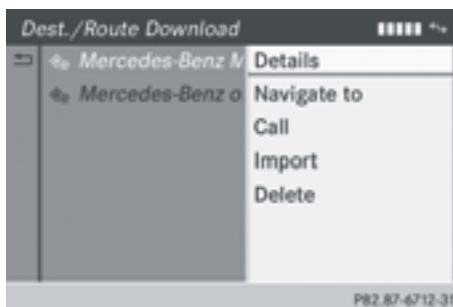

- ▶ Select an entry in the list by turning the COMAND controller and press to confirm.
- ▶ Select **Delete** and press to confirm.
A query appears asking whether the destination or the route should be deleted.
- ▶ Select **Yes** or **No** and press to confirm.
If you select **Yes**, the destination or route is deleted.
If you select **No**, the process will be canceled.

Weather





Introduction

COMAND can receive weather forecasts anywhere in the world via online connection and display it in an information chart (current day, five-day forecast) or in the weather map. The weather map can display the following weather data with symbols:



- hazard reports (e.g. storms, slippery conditions)
- precipitation radar (e.g. rain, snow)
- atmospheric pressure conditions
- temperatures
- cloud cover
- wind direction and speeds

Activating/deactivating the weather display

Activating



- ▶ Select the  icon in the main function bar by sliding  and turning  the COMAND controller and press  to confirm.

The carousel view appears.

- ▶ Turn  the COMAND controller until **COMAND** is brought to the front and press  to confirm.

The carousel view for COMAND appears.



- ▶ Turn  the COMAND controller until **Weather** is brought to the front and press  to confirm.

The information chart shows the current weather at the current vehicle position (factory setting). You can change the default view and the default location in the Options menu (> page 398).



You see the following information:

- the time of the current weather report
- the current temperature
- information on the weather (e.g. cloudy, rain)
- the maximum daytime temperature
- the minimum daytime temperature
- the probability of rain
- the forecast for the current day (three time intervals)

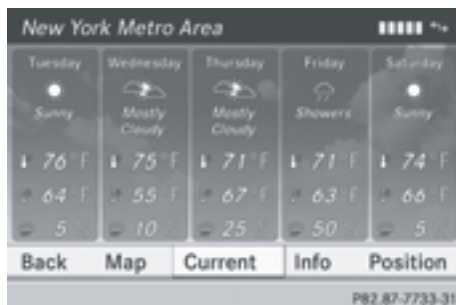

- ▶ **To switch to a five-day forecast:** confirm **5-Day** by pressing .



The information chart displays the forecast for the next five days in the currently selected location.

- ▶ **To return to the current weather information:** confirm **Current** by pressing .

Deactivating

- ▶ Press the  back button.

or

- ▶ Select **Back** by turning  the COMAND controller and press  to confirm. Irrespective of the option chosen, the carousel view will appear.

Displaying additional information

In addition to the current temperatures, you can also display information such as humidity and air quality (if the information is available).

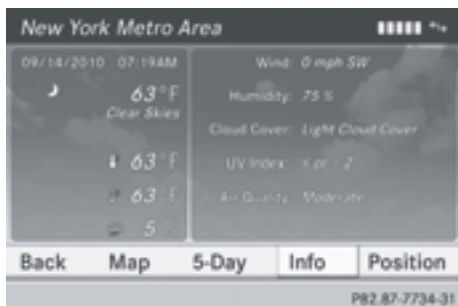

- ▶ Select **Info** in the information chart by turning **⏻** the COMAND controller and press **⏻** to confirm. The information chart displays information for the selected location.

Selecting the location

Introduction

You can select the following options for the weather forecast:

- the current vehicle position
- the destination
- a winter sports area
- a location anywhere in the world

You can select the location in the information chart (option 1) (▷ page 394) or in the map (option 2) (▷ page 395). Weather information is supplied by the nearest weather station.

Option 1: selecting the area in the information chart

- ▶ Select **Position** in the information chart by turning **⏻** the COMAND controller and press **⏻** to confirm. A menu appears.

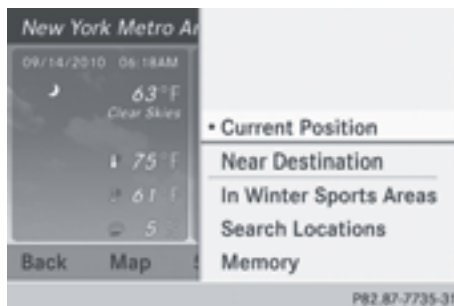

- ▶ **To select the current vehicle position:** confirm **Current Position** by pressing **⏻**.
- ▶ **To select the destination:** select **Near Destination** by turning **⏻** the COMAND controller and press **⏻** to confirm.

i If a route has been calculated, you can select **Near Destination** (▷ page 303). The menu item is otherwise grayed out.

- ▶ **To select a winter sports area:** select **In Winter Sports Areas** in the menu and press **⏻** to confirm.



- ▶ Select a state, e.g. **Colorado** and press **⏻** to confirm. The available winter sports areas are displayed.

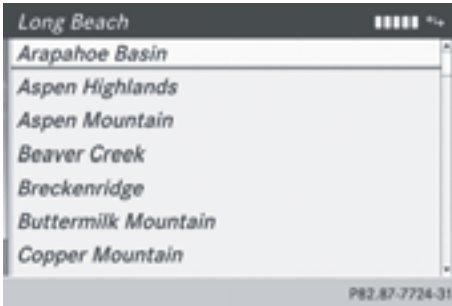

- ▶ Select a winter sports area from the menu and press to confirm. The information chart shows information on:
 - type of skiing
 - snow conditions
 - temperatures



- ▶ **To select the location:** select [Search Area](#) in the menu by turning the COMAND controller and press to confirm. An input menu appears.

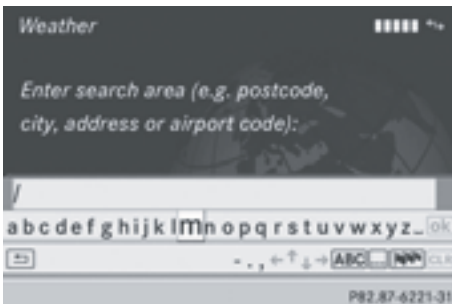

- ▶ Enter the search area. Character entry ([▷ page 283](#)). The information chart with the weather forecast appears when the search area has been entered.

Entry	Example
ZIP Code	11405
City	New York
Address	JFK Expy & S Cargo Rd
Airport code	JFK (John F. Kennedy International Airport, New York, NY)

Option 2: selecting the area in the weather map

- ▶ Call up the weather map and move to the desired location ([▷ page 395](#)).
- ▶ Press the COMAND controller. The menu bar is shown.
- ▶ Press the COMAND controller again and confirm [Display Weather](#). The information chart displays the current weather for the selected location.

Weather map

Calling up the weather map

- ▶ Select [Map](#) in the information chart by turning the COMAND controller and press to confirm. The map is displayed in 20 mi scale (20 km scale).
- ▶ **To display the crosshair:** slide the COMAND controller.
- ▶ **To scroll the weather map:** slide , , or the COMAND controller. The weather map moves in the corresponding direction under the crosshair.

- ▶ **To change the map scale:** as soon as you turn the COMAND controller, the scale bar appears.

- ▶ Turn until the desired scale is set.

i The data is downloaded again from the server for these functions. This can delay the display of the weather map.

Showing/hiding the menu in the weather map

- ▶ **To show:** press the COMAND controller in the weather map.

- ▶ **To hide:** slide up the COMAND controller.

Switching to the weather information display in the map

- ▶ Display the menu on the weather map (▷ page 396).
- ▶ Select **View** by turning the COMAND controller and press to confirm.

Weather characteristic	Display on the map
Hazard Icons	Displays warnings, calling up legend (▷ page 396)
Radar Map	Displays the rain radar as a colored area on the map, calling up legend (▷ page 396)
Atmospheric Pressure	Displays air pressure with isobars and as a colored area on the map
Temperatures	Displays the temperatures
Cloud Cover	Displays the clouds
Winds	Displays wind direction with an arrow and wind speed with coloring

i The hazard icon display is preset in the factory. This presetting can be changed in the Options menu (▷ page 398).

- ▶ Select a weather characteristic by turning the COMAND controller and press to confirm.
The • dot indicates which weather characteristic is currently displayed on the map. You can select one weather characteristic at a time.

Legend

- ▶ Display the menu on the weather map (▷ page 396).
- ▶ Select **View** by turning the COMAND controller and press to confirm.
- ▶ Select **Legend** and press to confirm.
The legend is displayed in accordance with the currently selected weather characteristic.
- ▶ **To return to the information chart:** display the menu in the weather map (▷ page 396)
- ▶ Select **Display Weather** and press to confirm.

Memory functions

Storing a location in the memory

You can save locations that are called up frequently in ten preset positions (0, 1 – 9).

- ▶ Select the location (▷ page 394).
- ▶ Press and hold a number key.
When the location is saved, the number of the selected preset comes before the name of the place in the caption.

Selecting a location from the memory

- ▶ **Quick select:** when the weather display (COMAND) is switched on and an entry is available, press a number key, e.g. . The information chart appears and displays the weather information.

- ▶ **From the weather memory:** select **Position** in the information chart by turning **⏪** the COMAND controller and press **⏩** to confirm.
- ▶ Select **Presets** and press **⏩** to confirm.
- ▶ Select a preset position that has an entry by turning **⏪** the COMAND controller and press **⏩** to confirm.
The information chart appears and displays the weather information.

Options

Introduction

You can select options for the following COMAND Mercedes-Benz Apps:

- local search (▶ page 397)
- weather display (▶ page 398)
- destination/route download (▶ page 400)

You can reset the selected options to the default settings (▶ page 401).

Calling up the options menu

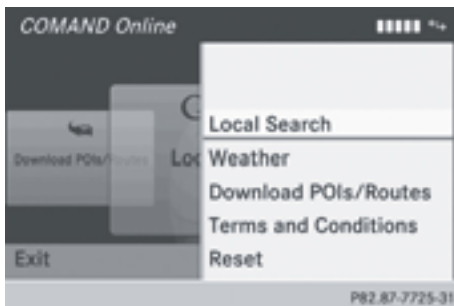

Options menu

- ▶ Select the **⊕** icon in the main function bar by sliding **↑** and turning **⏪** the

COMAND controller and press **⏩** to confirm.

The carousel view appears.

- ▶ Bring the **COMAND** panel to the front by turning **⏪** the COMAND controller and press **⏩** to confirm.
- ▶ Select **Options** by sliding **⊕** and turning **⏪** the COMAND controller and press **⏩** to confirm.

Selecting options for the local search

Setting the search radius

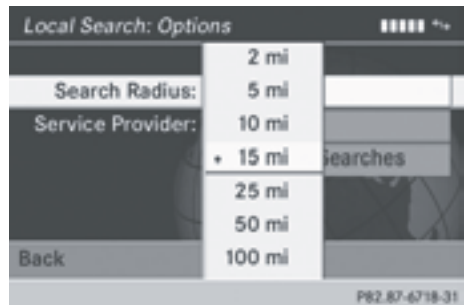
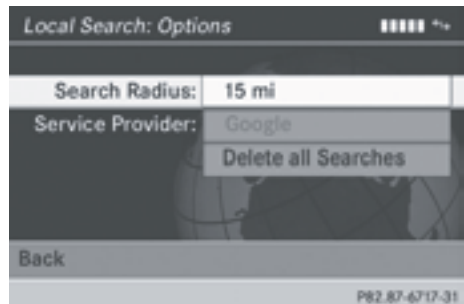

- ▶ Select **Local Search** in the Options menu by turning **⏪** the COMAND controller and press **⏩** to confirm.
The menu shows the current settings.
- ▶ Confirm the entry next to **Search radius:** by pressing **⏩**.
The **•** dot indicates the currently selected search radius.

- ▶ Select an entry by turning **⏏** the COMAND controller and press **⏏** to confirm.
The selected setting is accepted.
- ▶ **To exit the menu:** select **Back** by turning **⏏** the COMAND controller and press **⏏** to confirm.

Selecting a service provider

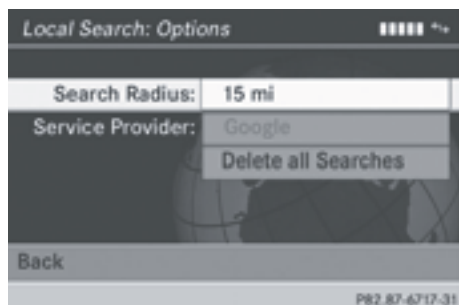

- ▶ Select **Local Search** in the Options menu by turning **⏏** the COMAND controller and press **⏏** to confirm.
The menu shows the current settings.
- ▶ Select the entry next to **Service provider:** by turning **⏏** the COMAND controller and press **⏏** to confirm.
The • dot indicates the currently selected service provider.

i If the entry is grayed out, you cannot select the service provider.

- ▶ Select an entry and press **⏏** to confirm.
The selected service provider is accepted.
- ▶ **To exit the menu:** select **Back** by turning **⏏** the COMAND controller and press **⏏** to confirm.

Deleting/saving search queries

- ▶ Select the **Delete all searches** entry by turning **⏏** the COMAND controller and press **⏏** to confirm.
A prompt appears, asking whether you really wish to delete the search queries.

- ▶ Select **Yes** or **No** and press **⏏** to confirm.
If you select **Yes**, the search queries are deleted.
If you select **No**, the process will be canceled.

Selecting options for the weather display

Setting the default view



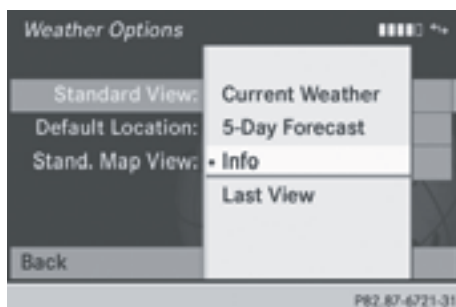
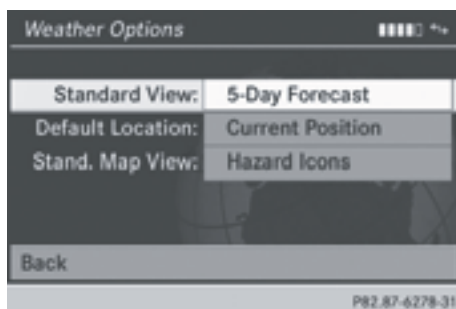

You can specify which view is called up after activating the weather display (▷ page 393).

You can make the following settings:

- current weather
- five-day forecast
- info view
- last view



- ▶ Select **Weather** in the options menu by turning **⏏** the COMAND controller and press **⏏** to confirm (▷ page 397).
The menu shows the current settings.



- ▶ Confirm the entry next to **Stand. Map view:** by pressing . The ● dot indicates the currently selected default view.
- ▶ Select an entry by turning  the COMAND controller and press  to confirm. The selected view is accepted.
- ▶ **To exit the menu:** select **Back** by turning  the COMAND controller and press  to confirm.





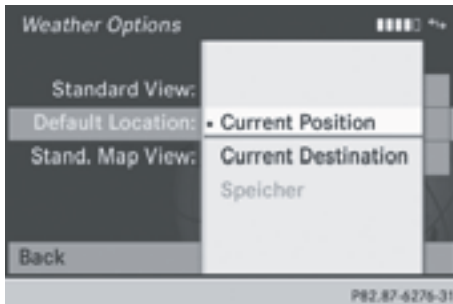
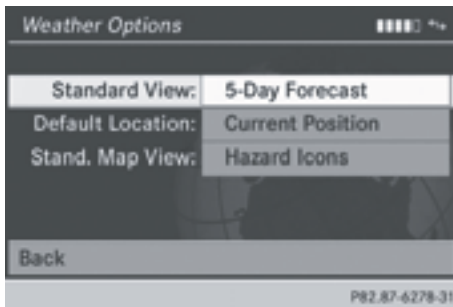

Setting the default location

You can make the following settings:

- current position
- current destination
- presets



- ▶ Select **Weather** in the options menu by turning  the COMAND controller and press  to confirm (▷ page 397). The menu shows the current settings.

- ▶ Select the entry next to **Default Location** by turning  the COMAND controller and press  to confirm. The ● dot indicates the currently selected default location.
- ▶ Select an entry by turning  the COMAND controller and press  to confirm. The selected location is accepted.
- ▶ **To exit the menu:** select **Back** by turning  the COMAND controller and press  to confirm.

Selecting weather data for the map view

The weather map can display the following weather data:

- hazard reports (e.g. storms, slippery conditions)
- precipitation radar (e.g. rain, snow)
- atmospheric pressure conditions
- temperatures
- cloud cover
- wind direction and speeds

You can select one feature each for the map view.

The availability of weather information is country-dependent.

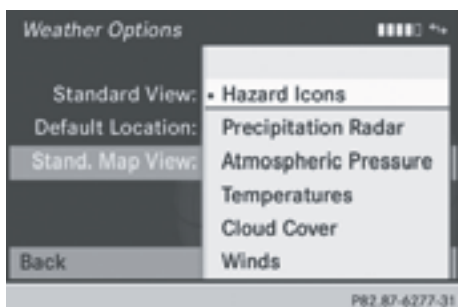
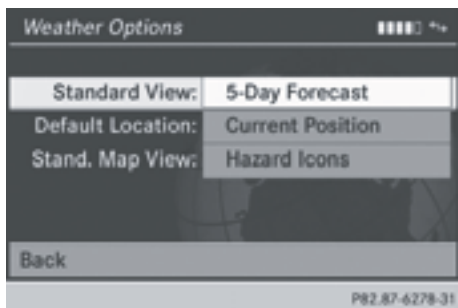

- ▶ Select **Weather** in the options menu by turning **⏏** the COMAND controller and press **⏏** to confirm (> page 397). The menu shows the current settings.
- ▶ Select the entry next to **Stand. Map view** by turning **⏏** the COMAND controller and press **⏏** to confirm. The • dot indicates the currently selected feature.
- ▶ Select an entry and press **⏏** to confirm. The selected feature is accepted.
- ▶ **To exit the menu:** select **Back** by turning **⏏** the COMAND controller and press **⏏** to confirm.

Setting options for destination/route download

Setting the type of import

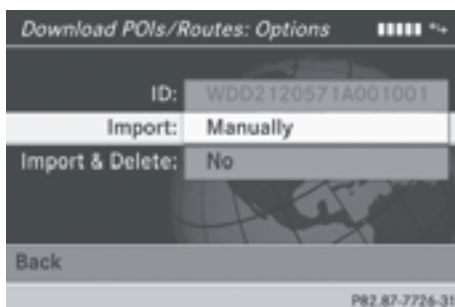
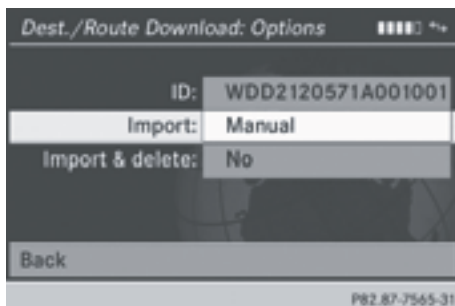





You can choose between manual and automatic importing.

- ▶ Select the entry next to **Import:** by turning **⏏** the COMAND controller and press **⏏** to confirm. The • dot indicates the current setting.
- ▶ Select **Manual** or **Automatic** and press **⏏** to confirm. The setting is accepted.
- ▶ **To exit the menu:** select **Back** by turning **⏏** the COMAND controller and press **⏏** to confirm.





Deleting/saving POIs after they have been imported to the server

- ▶ Select the entry next to **Import & delete:** by turning **⏏** the COMAND controller and press **⏏** to confirm. The • dot indicates the current setting.

- ▶ Select **Yes** or **No** and press  to confirm.
The setting is accepted.
Yes deletes the POIs after importing to the server.
No does not delete the POIs on the server.
- ▶ **To exit the menu:** select **Back** by turning  the COMAND controller and press  to confirm.
- i** Routes and destinations are automatically deleted on the server after seven days.
- ▶ Select **Reset** and press  to confirm.
A prompt appears asking whether you really wish to reset.
- ▶ Select **Yes** or **No** and press  to confirm.
If you select **Yes**, the settings are reset.
If you select **No**, the process will be aborted.
- i** Resetting your personal data in COMAND (reset function) does not reset the settings for the online functions (▶ page 294). Similarly, resetting the settings of the online functions has no influence on the reset function.











Conditions of use

You can review the terms of use for the COMAND Mercedes-Benz Apps and Google™.

- ▶ Select **Terms and conditions** in the options menu by sliding   the COMAND controller and press  to confirm (▶ page 397).
- ▶ Select **COMAND** or **Google** and press  to confirm.
The respective start page appears.
- ▶ Select **Continue** to view further content.

Resetting settings

The reset function resets all COMAND settings to the factory settings.



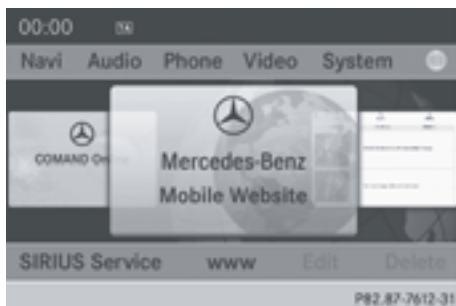

- ▶ Select the  icon in the main function bar by sliding   and turning  the COMAND controller and press  to confirm.
The carousel view appears.
- ▶ Bring the **COMAND** panel to the front by turning  the COMAND controller and press  to confirm.
- ▶ Select **Options** by sliding  and turning  the COMAND controller and press  to confirm.

Other services

Mercedes-Benz Mobile Website





The COMAND functions include the Mercedes-Benz Mobile Website as a predefined favorite.

- ▶ Select the  icon in the main function bar by sliding   and turning  the

COMAND controller and press  to confirm.

The carousel view appears.









- ▶ Bring the **Mercedes-Benz Mobile Website** panel to the front by turning  the COMAND controller and pressing  to confirm.
The Mercedes-Benz home page appears.

i You cannot delete the **Mercedes-Benz Mobile Website** panel.

Further Mercedes-Benz Apps

You can call up additional Mercedes-Benz Apps, such as Facebook, or Google™ services, such as Street View or Panoramio, here.

The following examples show how to call up a Mercedes-Benz App, for example Facebook, and generally how to call up Google™ services.

- ▶ **To call up Facebook:** select the  symbol in the main function bar by sliding  and turning  the COMAND controller and press  to confirm.
The carousel view appears.
- ▶ Bring the **COMAND** panel to the front by turning  the COMAND controller and press  to confirm.
The COMAND menu appears.
- ▶ Select **Facebook** by turning  the COMAND controller and press  to confirm.
The Facebook home page appears.
- ▶ **To call up Google™ services:** this is done through Google™ Local Search (> page 389).

i Facebook is a social network. This App allows you to log in from your vehicle and use Facebook's many functions.

Google™ Street View allows you to view streets in 360-degree panoramas.

Google™ Panoramio expands Google Local Search to include photos at the selected position

Internet





Display restriction

Internet pages cannot be shown while the vehicle is in motion.

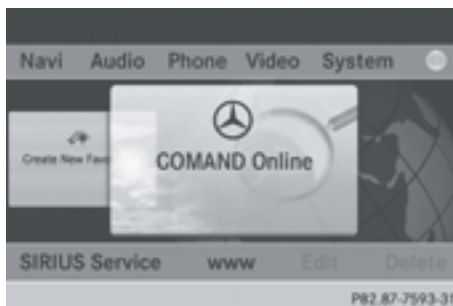
Calling up a website

Calling up the carousel view





- ▶ Select the  symbol in the main function bar by sliding  and turning  the COMAND controller and press  to confirm.
The carousel view appears.

You can now enter a web address (option 1 (> page 402)) or select it in the carousel view (option 2 (> page 403)).

To select in the carousel view, you must first create favorites (> page 408).

Option 1: entering the web address

You can enter the web address using either the character bar or the number keypad.

- ▶ Call up the carousel view (> page 402).
- ▶ Select **www** by sliding  and turning  the COMAND controller and press  to confirm.
An input menu appears.



- ▶ **To enter using the character bar:** enter the web address in the input line. Character entry (▷ page 281).





As soon as the first letter has been entered in the input line, a list appears below it. The list shows web addresses which begin with the letters you have entered and web addresses which have already been called up.

The list is empty the first time you call it up.



- ▶ **To enter characters using the number pad:** press the number keys in rapid succession. The character appears when the key is pressed. The first available letter is highlighted. Entering characters using the number keypad (▷ page 283).







- ▶ After entering the web address, select the  symbol by turning  or sliding  the COMAND controller and press  to confirm.

The website is called up.

- ▶ **To select a web address in the list:** slide  the COMAND controller in the input menu with the character bar. The list is activated.





- ▶ Select the web address by turning  or sliding  the COMAND controller and press  to confirm. The web address is entered in the input line.
- ▶ Press  the COMAND controller. The website is called up. The **Establishing data connection to <provider name>...** message appears.

Option 2: selecting favorites

You must create at least one favorite in the carousel view for this function (▷ page 408).









- ▶ Call up the carousel view (▷ page 402).
- ▶ In the carousel view, bring a favorite to the front by turning  or sliding  the COMAND controller and press  to confirm. The website is called up.



Navigating the website

Overview

Action	Result
▶ Turn  the controller.	Navigates from one item that can be selected (e.g. link, text field or selection list) to the next and highlights the respective element on the website.
Sliding the controller: ▶ Left or right  ▶ Up or down  ▶ Diagonally 	Moves the pointer on the page.
▶ Press  the controller.	Calls up the menu or opens the selected item.
▶ Press  .	Calls up the previous page.
▶ Press  .	Closes the Internet browser. If several windows are open, the current window is closed.

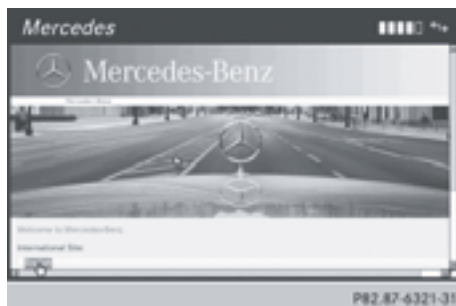

Example: highlighting an item that can be selected





- ▶ Turn  the COMAND controller.
A button is highlighted in the example.

Example: entering text



- ▶ Select an input line by turning  the COMAND controller and press  to confirm.
The character bar appears.





- ▶ Enter the text using the character bar or the number keypad. Character entry (▷ page 281).
- ▶ If the text has been entered, select the  icon by turning  the COMAND controller and press  to confirm.
The text has now been entered.

Menu functions

Calling up the menu



- ▶ **To call up the short menu:** highlight the selectable item on the page by turning  the COMAND controller and press  to confirm.

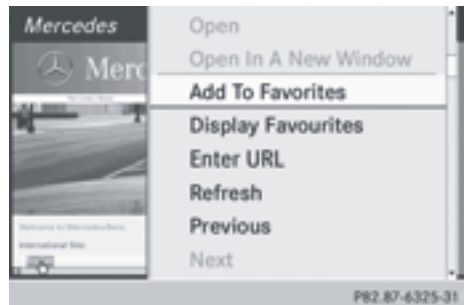



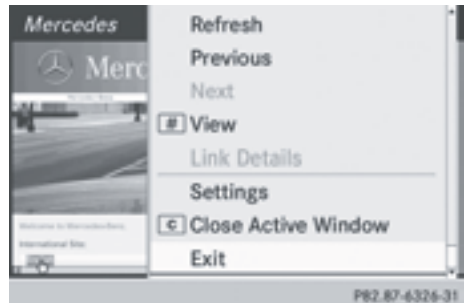

Start of menu



End of menu

- ▶ **To call up the entire menu:** when the shortcut is displayed, slide  the COMAND controller downwards.

or



- ▶ Select a free area on the website by sliding ,  or  the COMAND controller and press  to confirm.

Opening



Opens the website to the selected item.

- ▶ Call up the menu (▷ page 405).
- ▶ Confirm **Open** by pressing  the COMAND controller.



Entering a URL

- ▶ Call up the menu (▷ page 405).
- ▶ Select **Enter URL** by turning  or sliding  the COMAND controller and press  to confirm.
- ▶ Enter a web address (URL) (▷ page 402).

Calling up the previous website

- ▶ Call up the menu (▷ page 405).
- ▶ Select **Previous** by turning  or sliding  the COMAND controller and press  to confirm.



Calling up the next website

- ▶ Call up the menu (▷ page 405).
- ▶ Select **Next** by turning  or sliding  the COMAND controller and press  to confirm.

View

You can use this function to:

- position a selection window on websites that are larger than the display
- select a window that is already open

- ▶ Call up the menu (▷ page 405).
- ▶ Select **View** by turning  or sliding  the COMAND controller and press  to confirm.

or



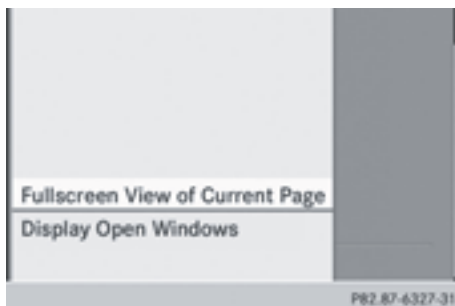

- ▶ Press the  key on the number keypad.

- i** You cannot use the  key if a phone call is being made.



- ▶ **To position the selection window:** confirm **Fullscreen View of Current Page** by pressing  the COMAND controller. A selection window appears on the website.



- ▶ Slide ,  or  the COMAND controller and position the selection window on the website.
- ▶ Press  the COMAND controller. The selected section is enlarged.
- ▶ **To display and select open windows:** select **Display Open Windows** by turning

⏏ or sliding ↑⏏↓ the COMAND controller and press ⏏ to confirm. The carousel view appears.



- ▶ Press ⏏ the COMAND controller. The website is displayed.

Exiting the menu

- ▶ Call up the menu (▷ page 405).
- ▶ Select **Exit** by turning ⏏ or sliding ↑⏏↓ the COMAND controller and press ⏏ to confirm. The Internet browser is closed. If other windows are opened in the background, another prompt appears.

Other menu functions

Opening in a new window

You can open up to five windows simultaneously.

- ▶ Call up the menu (▷ page 405).
- ▶ Select **Open In A New Window** by turning ⏏ or sliding ↑⏏↓ the COMAND controller and press ⏏ to confirm.
- ▶ **To select a window:** select **View** and press ⏏ to confirm.
- ▶ Select the website in the carousel view by turning ⏏ or sliding ←⏏→ the COMAND controller and press ⏏ to confirm.

Adding to favorites

Adds the current website to the favorites. The website can then be called up using the carousel view. You can save up to 20 favorites in the carousel view.

- ▶ Call up the menu (▷ page 405).
- ▶ Select **Add To Favorites** by turning ⏏ or sliding ↑⏏↓ the COMAND controller and press ⏏ to confirm. The following message appears: **The page has been added to your favorites**

Displaying favorites

- ▶ Call up the menu (▷ page 405).
- ▶ Select **Display Favorites** by turning ⏏ or sliding ↑⏏↓ the COMAND controller and press ⏏ to confirm. The favorites are shown in the carousel view.

Further information on favorites (▷ page 408).

Reloading a website

- ▶ Call up the menu (▷ page 405).
- ▶ Select **Refresh** by turning ⏏ or sliding ↑⏏↓ the COMAND controller and press ⏏ to confirm.

Closing the active window

- ▶ Call up the menu (▷ page 405).
- ▶ Select **Close Active Window** by turning ⏏ or sliding ↑⏏↓ the COMAND controller and press ⏏ to confirm.

or

- ▶ Press the **c** button to the right of the COMAND controller.

- ❗ You cannot use the **c** key if a phone call is being made.

Displaying the complete web address of the selected link

- ▶ Call up the menu (▷ page 405).
- ▶ Select **Link Details** by turning ⏏ or sliding ↑⏏↓ the COMAND controller and press ⏏ to confirm. The web address (URL) appears.
- ▶ Press ⏏ the COMAND controller and close the display.

Settings

The settings are described in a separate section (▷ page 410).

Favorites

Introduction

Favorites are frequently visited websites. You have the following options for creating a favorite:

- ▶ in the carousel view (▷ page 408)
- ▶ via the menu item **Add To Favorites** (▷ page 407)

Before creating a favorite in the carousel view, you must first close active connections (▷ page 386).

You can select and edit favorites that you have created.

Creating favorites

Creating favorites in the carousel view

- ▶ Call up the carousel view (▷ page 402).
- ▶ Bring the **Create New Favorite** panel to the front by turning **⏻** or sliding **←** the COMAND controller.



- ▶ Press **⏻** the COMAND controller. An input menu appears.



- ▶ Enter the web address (URL) and name using either the character bar or the number keypad. Character entry (▷ page 281).
- ▶ Select the **ok** icon and press **⏻** to confirm. The favorite has been created.

Adding a favorite via the menu

- ▶ When a website is displayed, call up the menu (▷ page 405).
- ▶ Select **Add To Favorites** in the menu and press **⏻** to confirm.

Selecting favorites

- ▶ Call up the carousel view (▷ page 402).
- ▶ Select the favorite in the carousel view by turning **⏻** or sliding **←** the COMAND controller and press **⏻** to confirm. The favorite is opened.

Editing favorites

Editing favorites in the carousel view

- ▶ Call up the carousel view (▷ page 402).
- ▶ Select **Edit** by sliding **⏻** and turning **⏻** the COMAND controller and press **⏻** to confirm. An input menu appears.



- ▶ Enter the web address (URL) and name using either the character bar or the number keypad. Character entry (▷ page 281).

Editing favorites in the Favorites menu

- ▶ Call up the menu (▷ page 405).
- ▶ Select **Display Favorites** by turning **⏮** the COMAND controller and press **⏹** to confirm. The favorite is displayed.
- ▶ Press **⏮** the COMAND controller. The favorites menu appears.



Favorites menu

- ▶ Select **Edit** by turning **⏮** or sliding **⏮** the COMAND controller and press **⏹** to confirm.

or

- ▶ Press the **⌘** key on the number keypad. An input menu appears.



- ▶ Enter the web address (URL) and name using either the character bar or the number keypad. Character entry (▷ page 281).

Other functions in the favorites menu

Opening current favorites

- ▶ Call up the Favorites menu (▷ page 408).
- ▶ Confirm **Open** by pressing **⏮** the COMAND controller.

Opens the current favorites in a new window.

Opening in a new window

- ▶ Call up the Favorites menu (▷ page 408).
- ▶ Select **Open In A New Window** by turning **⏮** or sliding **⏮** the COMAND controller and press **⏹** to confirm.

Calling up details

- ▶ Call up the Favorites menu (▷ page 408).
- ▶ Select **Details** by turning **⏮** or sliding **⏮** the COMAND controller and press **⏹** to confirm.

or

- ▶ Press the **#** key on the number keypad. The detailed view appears.

Exiting

- ▶ Call up the Favorites menu (▷ page 408).
- ▶ Select **Exit** by turning **⏏** or sliding **↑⏏↓** the COMAND controller and press **⏏** to confirm.

or

- ▶ Press the **⏏** back button on the left next to the COMAND controller.
The menu closes.

Deleting favorites

Deleting favorites in the carousel view

- ▶ Call up the carousel view (▷ page 402).
- ▶ Select **Delete** by sliding **⏏** and turning **⏏** the COMAND controller and press **⏏** to confirm.

A prompt appears.

- ▶ Select **Yes** and press **⏏** to confirm.
The favorite is deleted.

If you select **No**, the process will be canceled.

Deleting favorites in the Favorites menu

- ▶ Select **Delete** by turning **⏏** or sliding **↑⏏↓** the COMAND controller and press **⏏** to confirm (▷ page 408).

or

- ▶ Press the **c** button to the right of the COMAND controller.
The favorite is deleted.

Settings

Settings menu



- ▶ Call up the menu (▷ page 405).
- ▶ Select **Settings** by turning **⏏** or sliding **↑⏏↓** the COMAND controller and press **⏏** to confirm.

You can activate/deactivate the following settings:

- **Download Images Automatically**

It may take some time to download the contents of websites that contain a large amount of images. Therefore, it may be useful to deactivate this option.

- **Block Pop-Ups**

Pop-ups are windows (usually with advertisements) which are displayed automatically when you call up a website. You can block these displays.

- **Activate Javascript**

Javascript makes it possible to display and interact with dynamic content on the website.

- **Allow Cookies**

Some websites save information in small text files (cookies) in COMAND. You can determine whether cookies may be stored.

- **Character Size**

You can select the font size which is used when displaying the website.

- **Character Code**

You can select a different character set here, e.g. if the characters of a website appear distorted.

- **Delete Private Data**

Deletes data which has been saved by the browser during Internet use.

Changing settings

- ▶ Select a setting by turning **⏏** the COMAND controller and press **⏏** to confirm.
Switch the setting on or off .
- ▶ Select **Character Size** or **Character Code** by turning **⏏** or sliding **↑⏏↓** the

COMAND controller and press to confirm.

- ▶ Select a setting using the COMAND controller and press to confirm.

i If you change the settings, the websites may not be displayed correctly.

Deleting private data

- ▶ Select **Delete Private Data** and press to confirm.
A menu appears.

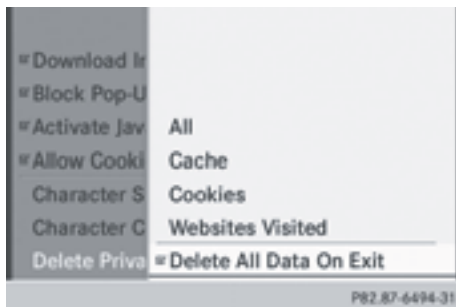

- ▶ Select the setting by turning or sliding the COMAND controller and press to confirm.

The • dot in front of an entry indicates which setting is active.

or

- ▶ Select **Delete All Data On Exit** and press to confirm.
Switch the setting on or off .

Option	Function
All	Deletes all private data.
Cache	Deletes data in the cache.
Cookies	Deletes cookies that are created by websites which you have called up.

Option	Function
URL History	Deletes all websites visited (path).
<input checked="" type="checkbox"/> Delete All Data On Exit	If this function is activated <input checked="" type="checkbox"/> , all private data is deleted when you exit the Internet browser.

i If you reset COMAND to the factory settings (reset function), these settings are deleted (▷ page 294).

Audio

Radio mode

Important notes

Portable electronic devices in the vehicle may seriously impair radio reception.

Switching to radio mode

Switching modes using the function button

- ▶ Press the **RADIO** function button.
The radio display appears. You will hear the last station played on the last waveband.

i Repeatedly pressing this function button switches through the wavebands in this order: FM, AM, WB. You then call up satellite radio mode. Pressing the button again takes you back to FM radio mode.

Switching modes via the audio menu



P82.87-6261-31

Example: audio menu

- ① Current audio operating mode
- ② Main function bar
- ③ Audio menu

▶ Select **Audio** in the main function bar by sliding $\uparrow \odot$ and turning $\left\{ \odot \right\}$ the COMAND controller and press \odot to confirm.

If radio mode was the last mode selected, it will now be active.

If another audio mode is switched on, you can now switch to radio mode in the audio menu.

▶ Select **Audio** by sliding $\uparrow \odot$ the COMAND controller and press \odot to confirm. The audio menu appears.

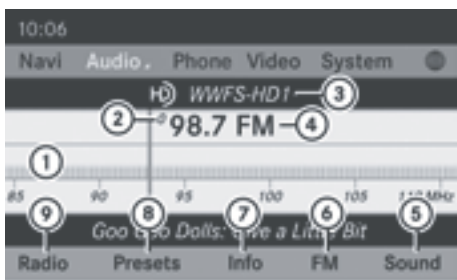

P82.87-6262-31

Example: HD Radio display

- ① Display window with station settings
- ② Preset position of the selected station
- ③ Name of the selected station (symbol for HD Radio™ and number of subprogram)
- ④ Frequency of the selected station

- ⑤ Sound settings
- ⑥ FM radio, AM radio or WB radio
- ⑦ Program information
- ⑧ Preset functions
- ⑨ Radio functions

▶ Select **FM/AM Radio** by turning $\left\{ \odot \right\}$ the COMAND controller and press \odot to confirm.

Deactivating HD Radio

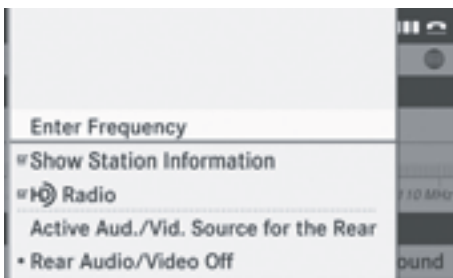

P82.87-6263-31

You can deactivate HD Radio™ for the selected frequency in the Radio submenu:

- ▶ Select **Radio** in the radio display by sliding $\odot \downarrow$ the COMAND controller and press \odot to confirm.
- ▶ Select **HD Radio** and press \odot to confirm. HD Radio™ is deactivated if the check box is empty.

You hear the analog program of this frequency.

As soon as you change to another HD Radio frequency, HD Radio™ is reactivated.

i Notes on HD Radio™:

HD Radio™ is a digital radio system from the U.S.A.

HD Radio™ provides:

- digital transmission on the same wavebands as analog AM/FM. The

analog AM/FM stations remain in the same position when selecting a station.

- ▶ broadcasting of several program streams over a single FM frequency (e.g. HD1, HD2, etc.).
- ▶ clear, interference free reception
- ▶ FM: CD quality sound
AM: analog FM station sound quality
- ▶ the display of text-based information (e.g. artist, track name) in the display

For further information on HD Radio™, visit <http://www.hdradio.com>.

Switching wavebands

You can switch the radio between the FM, AM and WB wavebands.

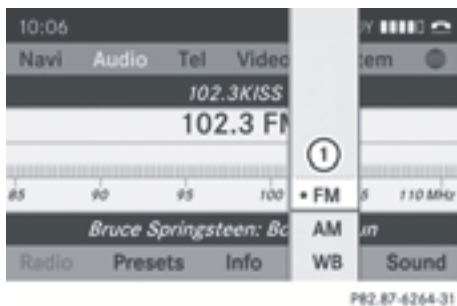

① Waveband submenu

- ▶ **Option 1:** press the **RADIO** function button until the desired waveband is set.
- ▶ **i** Repeatedly pressing this function button switches through the wavebands in this order: FM, AM, WB. You then call up satellite radio mode. Pressing the button again takes you back to FM radio mode.
- ▶ **Option 2:** select **FM**, **AM** or **WB** in the radio display by sliding $\odot \updownarrow$ and turning $\left\{ \odot \right\}$ the COMAND controller and press \odot to confirm.
- ▶ The waveband submenu is opened.
- ▶ Select a waveband and press \odot to confirm. You will hear the last station played on the selected waveband. The \bullet dot shows the currently selected waveband.

Selecting a station

Selecting stations via the station search function

- ▶ Press the \lll or \ggg button.

or

- ▶ Turn $\left\{ \odot \right\}$ or slide $\leftarrow \odot \rightarrow$ the COMAND controller while the display/selection window in the radio display is active. Station search scans up or down and stops at the next station found.

Selecting stations via the station presets

- ▶ **Quick setting:** press a number key, e.g.



- ▶ **Directly in the station presets:** select **Presets** by sliding $\odot \updownarrow$ and turning $\left\{ \odot \right\}$ the COMAND controller and press \odot to confirm.

or

- ▶ When the display/selection window is active, press \odot the COMAND controller. The station preset memory appears. The \bullet dot indicates under which preset the currently selected station is stored.
- ▶ Select a station by turning $\left\{ \odot \right\}$ and pressing \odot to confirm or press a number key, e.g. $\left[\begin{array}{c} 2 \\ ABC \end{array} \right]$.

Selecting stations by entering the frequency manually

- ▶ **Option 1:** press the $\left[\begin{array}{c} * \\ \pm \end{array} \right]$ button.
- ▶ **Option 2:** select **Radio** in the radio display by sliding $\odot \updownarrow$ and turning $\left\{ \odot \right\}$ the COMAND controller and press \odot to confirm.
- ▶ Select **Enter Frequency** and press \odot to confirm. Irrespective of the option chosen, an input menu will appear.
- ▶ Enter a frequency using the number keys. COMAND sets the frequency entered.

Waveband	Frequency
AM (MF)	530 – 1700 kHz
FM (VHF)	87.7 – 107.9 MHz
WB (Weather Band)	Weather report channels

- ❗ You can only enter currently permitted numbers.
- ❗ If you enter a frequency in the FM or AM wavebands which is outside the frequency range, COMAND sets the next lower frequency.

Storing a station

Storing stations manually

There are ten presets available for the FM and AM wavebands.

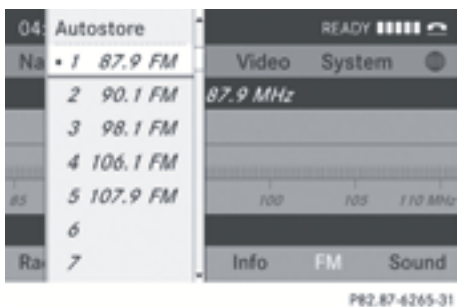

Example: station memory

- ▶ **Quick save:** press and hold a number key, e.g. **2** ABC, until you hear a tone. The station is stored.
 - ▶ **Directly in the station presets:** when the display/selection window is active, press **⏸** the COMAND controller.
- or
- ▶ Select **Presets** by sliding **⏸** and turning **⏸** the COMAND controller and press **⏸** to confirm.
- In both cases, the station presets appear. The **•** dot indicates under which preset the currently selected station is stored.

- ▶ Select a preset by turning **⏸** the COMAND controller and press and hold **⏸** until you hear a tone. The station is stored under the preset.

Storing stations automatically

This function automatically stores stations with adequate reception under the presets. The search starts at the lowest frequency. COMAND stores any stations found, beginning with preset 1. When the highest frequency is reached or 10 stations have been found, the storing process ends. Any stations stored manually under the presets will be lost. COMAND may not occupy all memory positions when storing.

- ▶ **Option 1:** when the display/selection window is active, press **⏸** the COMAND controller. The station preset memory appears.
- ▶ **Option 2:** select **Presets** by sliding **⏸** and turning **⏸** the COMAND controller and press **⏸** to confirm. The station preset memory appears.
- ▶ Irrespective of the option, select **Autostore** and press **⏸** to confirm. In both cases, COMAND searches for stations that can be received. You will see a message to this effect. The available stations are automatically stored in the preset positions.

- ▶ **To cancel storing:** select **Cancel** and press **⏸** to confirm.

Weather Band



Activating

- ▶ Press the **RADIO** function button repeatedly until the Weather Band is switched on.
- or
- ▶ Select the currently set waveband **FM** or **AM** by sliding **⏸** and turning **⏸** the



COMAND controller and press  to confirm.

- ▶ Select **WB** from the menu and press  to confirm.

Searching for a channel

- ▶ **Quick select:** turn  or slide  the COMAND controller while the display/selection window is active.



or

- ▶ Press the  or  button. Channel search scans up or down and stops at the next channel found.

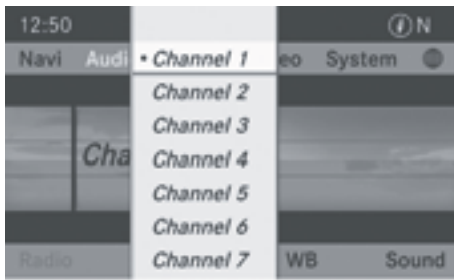

Selecting a channel from the channel list



P82.87-4266-31

- ▶ Select **Channel 1** by sliding  and turning  the COMAND controller and press  to confirm.

The channel list appears.

- ▶ Select a channel by turning  the COMAND controller and press  to confirm.

or

- ▶ Press a number key on the control panel, e.g. **4**, at any time.

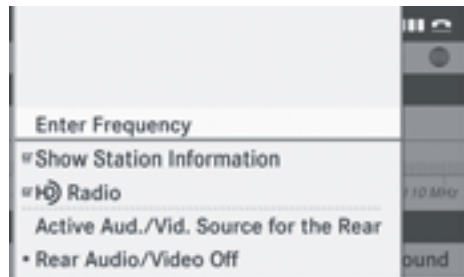

Displaying station information



P82.87-4263-31

This function is only available for analog FM programs and digital AM/FM programs (HD Radio™).

Information relevant to the current station is shown below the main function bar.

- ▶ Select **Show Station Information** by sliding  and turning  the COMAND controller and press  to confirm. Depending on the previous status, you switch **Show Station Information** on or off .





Displaying program information



P82.87-4268-31

This function is only available for analog FM programs and digital AM/FM programs (HD Radio™).

Information relevant to the current station is shown in the display window.

- ▶ Select **Info** in the radio display by sliding  and turning  the COMAND controller and press  to confirm. Information on the currently selected station is displayed. Content is dependent on the station.
- ▶ **To return to the radio display:** confirm **Info** by pressing .
- ▶ Slide  the COMAND controller up.

Satellite radio

Important notes

i The satellite radio mode described below requires optionally available satellite radio equipment and registration with a satellite radio provider.

i Note that the categories and channels shown in the illustrations depend on the program content offered by the provider. The program content may vary. The illustrations and descriptions in these operating instructions may therefore differ from the channels and categories offered by the provider.

Satellite radio mode may be temporarily unavailable or interrupted for a variety of reasons. These reasons include environmental or topographical conditions as well as other issues beyond the control of Mercedes-Benz USA, LLC. This means operation may not be possible in certain areas.

These include:

- tunnels
 - parking garages
 - locations inside or next to buildings
 - locations in the vicinity of other structures
- i** SIRIUS XM Radio offers more than 130 radio stations in digital quality, for example 100% commercial-free music, sports, news and entertainment.

SIRIUS XM Radio employs a fleet of high-performance satellites to broadcast around the clock throughout the USA and Canada.

The satellite radio program is available for a monthly fee. Details are available from the SIRIUS XM Service Center and at **<http://www.sirius.com>** (USA) or **<http://www.siriuscanada.com>** (Canada).

Registering satellite radio



Service information screen

- ① Provider's phone number (SIRIUS XM)
- ② SIRIUS XM ID of your satellite receiver

- ▶ Switch on satellite radio mode (**>** page 417).
The satellite radio main menu appears, showing the weather channel. You cannot select any other stations.
- ▶ In the lower menu line, select **Sat** and press .

- ▶ Select **Service** and press .
- The service information screen appears.

Once the connection has been established:

- ▶ Follow the instructions of the service staff.
The activation process may take up to ten minutes. If the activation is completed successfully, the **No Service** message appears in the display, followed by the satellite radio main menu.

i You can also have the satellite service activated online. To do so, visit the SIRIUS XM Radio website at

<http://www.sirius.com> (USA) or
<http://www.siriuscanada.com>
 (Canada).

- i** If registration is not included when purchasing the system, your credit card details will be required to activate your account.

If the satellite receiver is not installed or is not installed correctly, the **Device Unavailable** message will appear.

Switching on satellite radio mode

Notes

For example, to select a channel or scroll in the lists, you can also use the ◀ ▶ ▲ ▼ buttons on the multifunction steering wheel (▷ page 211).

Important information on registering the satellite radio (▷ page 416).

Option 1

- ▶ Press the **RADIO** function button.

The **No Service** message appears after switching on or if no signal is being received. Once COMAND receives the signal, the satellite radio display appears. The station last selected is played.

- i** Repeatedly pressing this function button switches through the wavebands in this order: FM, AM, WB and subsequently switches on the satellite radio. Pressing the button again takes you back to FM radio mode.

Option 2

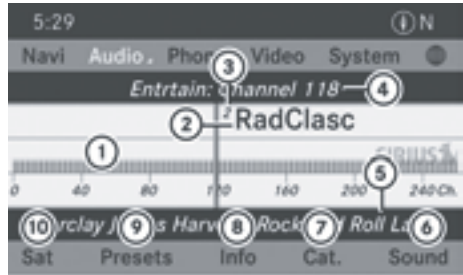

P82.87-6270-31

Satellite radio main menu

- ① Satellite radio main display
- ② Channel name
- ③ Preset
- ④ Selected category/channel number
- ⑤ Channel information (in brief)
- ⑥ Sound settings
- ⑦ Category list
- ⑧ Channel information (in detail)
- ⑨ Channel preset list
- ⑩ Satellite radio menu

Channel information ⑤ can be viewed in detail (▷ page 420).

- ▶ Select **Audio** in the main function bar by sliding **↑** and turning the COMAND controller and press **⏵** to confirm. If satellite radio mode was the last mode selected, it will now be active. If another audio mode is switched on, you can now switch to satellite radio mode in the audio menu.
- ▶ Select **Audio** by sliding **↑** the COMAND controller and press **⏵** to confirm. The audio menu appears.
- ▶ Select **Sat** and press **⏵** to confirm.

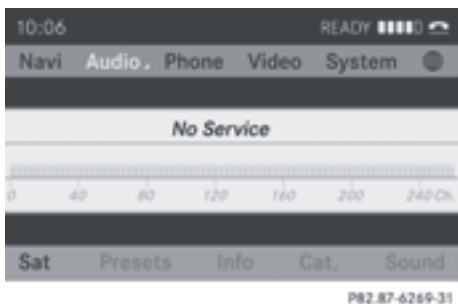

The **No Service** message appears when starting up or if no signal is being received. If the satellite receiver is not installed or is not installed correctly, the **Device Unavailable** message will appear.

Changing the category

Satellite radio stations are sorted into various categories. You can choose between various categories such as News/Discussions, Sports and Country (if available). The category list is sorted alphabetically.

- ▶ **To call up the category list:** select **Category** by turning **[COMAND]** the COMAND controller and press **[ENTER]** to confirm. The category list appears.
 - ▶ **To select a category:** select a category by turning **[COMAND]** the COMAND controller and press **[ENTER]** to confirm. The category selected is shown in the display. You hear the station last selected for this category.
- The **All Channels** category is at the top of the category list. This category is sorted by channel number and allows you to browse all available channels.

Selecting a channel

Channel search

- ▶ Turn **[COMAND]** or slide **[LEFT/RIGHT]** the COMAND controller while the display/selection window in the SatRadio display is active.
- or
- ▶ Press the **[LEFT]** or **[RIGHT]** button. COMAND searches in both directions (ascending and descending) and stops at the next channel found in the selected category.



Satellite radio menu

- ▶ Select **Sat** in the submenu bar by turning **[COMAND]** the COMAND controller and press **[ENTER]** to confirm. The satellite radio menu appears.



Entering channel numbers directly

- ▶ **Option 1:** press the button.
An input menu appears.
- ▶ **Option 2:** select **Sat** by turning the COMAND controller and press to confirm.
- ▶ Select **Enter Channel** and press to confirm.
An input menu appears.

Entering the channel

- ▶ With both options, press the corresponding number buttons on the control unit in succession.
COMAND sets the selected channel.

You can only select currently permitted digits.



P82.87-6726-31

Selecting a channel from the SatRadio channel list

You can select the channel from the channel list (option 1) or via the channel list that shows the artists and tracks that are currently being played (option 2).

- ▶ Select **Sat** in the submenu bar by turning the COMAND controller and press to confirm.

Option 1

- ▶ Select **Channel List** and press to confirm.
The channel list appears.
- ▶ Select a channel by turning the COMAND controller and press to confirm.

Option 2

- ▶ Select **Channel List with Artist, Title** and press to confirm.
The channel list appears and displays the artists and tracks currently being played.



P82.87-6725-31

- ▶ Select a channel by turning the COMAND controller and press to confirm.

Memory functions

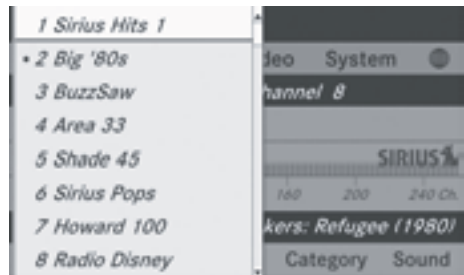

P82.87-6772-31

Channel presets

There are ten presets available.

Storing channels

- ▶ When the display/selection window is active, press the COMAND controller.

or

- ▶ Select **Presets** in the submenu bar by turning the COMAND controller and press to confirm.

In both cases, the channel presets appear. The **•** dot in front of a preset entry indicates that the currently selected channel is stored under this preset.

- ▶ Select a preset by turning **[⏪]** the COMAND controller and press and hold **[⏩]** until you hear a tone.

or

- ▶ Press and hold a number button, e.g. **[4]**, until you hear a tone. The channel is stored under the preset.

Storing channels automatically

This function automatically stores channels with adequate reception in the preset memory. Channels stored manually in the preset memory will be overwritten.

- ▶ **Option 1:** press **[⏪]** the COMAND controller when the display/selection window is active.
- ▶ Select **Autostore** in the presets by turning **[⏪]** the COMAND controller and press **[⏩]** to confirm.
- ▶ **Option 2:** select **Presets** in the submenu bar by sliding **[⏪]** and turning **[⏪]** the COMAND controller and press **[⏩]** to confirm.
- ▶ Select **Autostore** and press **[⏩]** to confirm. In both cases, COMAND searches for channels that can be received. You will see a message to this effect. The available channels are automatically stored in the preset positions.
- ▶ **To cancel storing:** select **Cancel** and press **[⏩]** to confirm.

Selecting a channel from the preset list

- ▶ **To call up the preset list:** select **Presets** by turning **[⏪]** the COMAND controller and press **[⏩]** to confirm. The channel preset list appears.
- ▶ **To set a channel:** select a preset by turning **[⏪]** the COMAND controller and press **[⏩]** to confirm.

or

- ▶ Press a number key, such as **[4]**.

Displaying information







- ▶ Select **Info** in the submenu bar by turning **[⏪]** the COMAND controller and press **[⏩]** to confirm. Information on the currently received program is displayed. If available, you will see:
 - the full channel name
 - the artist of the track that is currently being played
 - the track that is currently being played
- ▶ **To return to the radio display:** confirm **Info** by pressing **[⏩]**.
- ▶ Slide **[⏪]** the COMAND controller up.

Displaying service information



- 1 Provider's phone number (SIRIUS XM) or **Call Service Provider**
- 2 SIRIUS ID of your satellite receiver

The provider's customer service center is available by phone at any time to answer any general questions or questions on the versions available.

- ▶ Select **Sat Radio** in the submenu bar by turning  the COMAND controller and press  to confirm.
- ▶ Select **Service** and press  to confirm. The provider's details appear.
- ▶ **To return to the SatRadio main display:** slide  the COMAND controller.

Channel list updates

When receiving a new channel list, the display shows the **Updating Channels...** message.

The station last selected is switched to mute until the update has been completed. Satellite radio mode is not available during this process.

Once the update has been completed, the satellite radio main menu appears. The station last selected is played.

Sound settings

Information on sound settings (▷ page 278).

Audio CD/DVD and MP3 mode

Important safety notes

WARNING

COMAND is classified as a Class 1 laser product. Never open the housing. There is a risk of damage to the eyes due to exposure to invisible laser radiation if you open the casing, or if the casing is faulty or damaged.

COMAND does not contain any parts that can be serviced by the user. For safety reasons, all maintenance work must be carried out by qualified aftersales technicians.

WARNING

Only when the vehicle is stationary should you:

- insert a data carrier
- eject a disc

There is a risk of being distracted from the road and traffic conditions if you insert or eject a disc while the vehicle is in motion.

Inserting/ejecting CDs/DVDs

Notes

If the CD/DVD has a printed side, this must face upwards when the CD/DVD is inserted. If neither side is printed, the side to be played should face downwards. The system may not be able to play CDs/DVDs with copy protection.

-  If a medium contains other files in addition to music files, the loading time before the first track starts to play may be longer.

Inserting a disc into the single DVD drive

- ▶ Press the  eject button. If there is a disc already inserted, it will be ejected.
- ▶ Take the disc out of the slot.
- ▶ Insert a disc into the slot. If the disc is correctly inserted and is a suitable disc, it is drawn in by the drive and played.

Ejecting a disc from the single DVD drive

- ▶ Press the  eject button.
- ▶ Take the disc out of the slot. If you do not take the disc out of the slot, it is drawn in again automatically after a short while and reloaded.

Inserting discs into the DVD changer

The DVD changer has a fixed magazine with six trays.

- ▶ **To insert a CD/DVD into the magazine tray:** press the  load/eject button. A menu shows the current load status of the magazine trays. The last tray selected is identified by a red digit.



P82.87-2159-31

- ▶ Select a magazine tray to be filled by turning the COMAND controller and press to confirm.

or

- ▶ Press a number key, e.g. . The DVD changer switches to the selected magazine tray. You see the **Please Wait...** message.

You then see the **Please insert disc <x>** message.



P82.87-3901-31

- ▶ Insert a disc into the disc slot with the printed side facing upwards. The DVD changer loads the disc into the selected magazine tray. The **Loading disc...** message appears.
- i** It may take some time for the disc to be loaded, depending on the type of disc. If no disc is inserted for approximately 20 seconds, the display returns to the magazine menu.

The DVD changer plays the disc if:

- it has been inserted correctly.
- it is a permissible type of disc.



P82.87-2161-31

- ① Full magazine tray (eject function is available)
- ② Empty magazine tray (disc can be inserted)

- ▶ **To exit the menu:** press the eject/load button again or press the back button.

or



- ▶ Select **Back** by sliding and turning the COMAND controller and press to confirm.

- ▶ **To fill empty magazine trays:** press the load/eject button.

The magazine menu appears.

- ▶ Select **Fill Empty Slots**. You see the **Please Wait...** message. COMAND switches to the next free magazine tray. You then see the **Please insert disc <x>** message.

- i** Do not insert a disc into the magazine tray until you have seen this prompt.
- ▶ Insert a disc into the disc slot with the printed side facing upwards. You see the **Please Wait...** message. Once the disc is loaded, the DVD changer switches to the next empty tray. You see the **Please insert disc <x>** message.
- ▶ Repeat this step until all trays are loaded. The DVD changer plays the last disc you loaded if it has been inserted correctly and it is a permissible type.

▶ **To cancel loading:** press the  eject/load button again or press the  back button.

i If you cancel loading with the  back button, the system loads and plays the last CD you inserted.

Ejecting discs from the DVD changer



If you remove one disc while playing another disc, the DVD changer interrupts playback. Playback continues once the disc has been ejected.

▶ **To eject a CD/DVD:** press the  load/eject button.

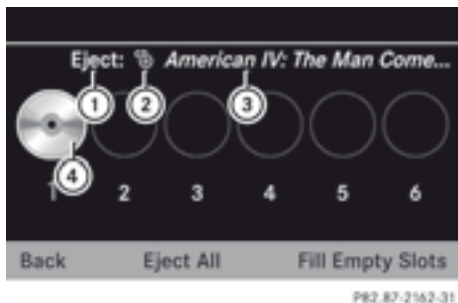
The magazine menu appears. The magazine tray with the current disc is highlighted.



- ① Eject possible
- ② Type of data medium
- ③ Disc name (only if stored on the disc)
- ④ Current disc

▶ Select a magazine tray containing a disc by turning  the COMAND controller and press  to confirm.

or



▶ Press a number key, e.g. . You see the message: **Ejecting disc <x>...** You then see the following message:

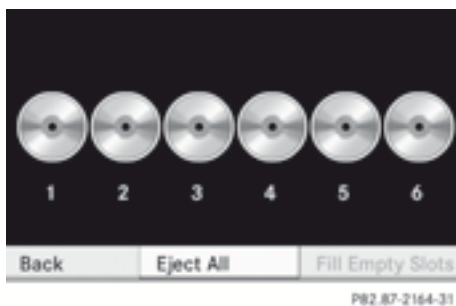

▶ Take the disc out of the slot. If you do not take the disc out of the slot, COMAND will draw it in automatically after a short while and load it again.



▶ **To eject all CDs/DVDs:** press the  load/eject button. The magazine menu appears.



▶ Select **Eject All** by sliding  and turning  the COMAND controller and press  to confirm.

The DVD changer ejects the last disc selected. You see the **Ejecting disc <x>...** message.



▶ Take the disc out of the disc slot when you see the **Please remove disc <x>** message.

The DVD changer switches to the next loaded magazine tray and ejects the disc.

▶ Repeat the last step until the magazine is empty.

- ▶ **To exit the menu:** press the  eject/load button again or press the  back button.

or

- ▶ Select **Back** by sliding  and turning  the COMAND controller and press  to confirm.

Inserting and ejecting an SD memory card

General information

COMAND supports SD memory cards (Secure Digital) and SDHC memory cards (Secure Digital High Capacity).

- i** Not all memory cards available on the market are designed for the temperatures which may be reached in the vehicle.

If the SD memory card is no longer in use, you should remove it from COMAND. High temperatures can damage the card.

Due to the wide range of SD memory cards available on the market, playback cannot be guaranteed for all brands of SD memory card.

The readable storage capacity depends on the memory card used. You can obtain further information at any authorized Mercedes-Benz Center.

Inserting an SD memory card

- ▶ Insert the memory card into the slot on the control panel until it engages in place. The side with the contacts must face downwards and point towards the slot. COMAND loads the memory card and shows a message to this effect. If no MP3 tracks can be found, you will see a message to this effect.

Ejecting an SD memory card

- ▶ Press the memory card.
The memory card is ejected.
- ▶ Remove the memory card from slot.

Connecting a USB device

The USB port is located in the stowage compartment in the center console.

Electrical consumption at this connection must not exceed a continuous current of 500 mA. If the electrical consumption is higher, use a separate source to provide power for the USB device (e.g. 12 V power supply).

- ▶ Connect the USB device (e.g. USB stick) to the USB port.

- i** Due to the wide range of USB devices available on the market, playback cannot be guaranteed for all brands of USB device. Information about suitable USB devices can be obtained from an authorized Mercedes-Benz Center.
MP3 players must support Media Transfer Protocol (MTP).

Activating audio CD/DVD or MP3 mode

Automatic switching

- ▶ Insert/eject CDs/DVDs (▷ page 421)
or
- ▶ Insert an SD memory card (▷ page 424)
or
- ▶ Connect a USB device (▷ page 424).
COMAND loads the medium inserted and starts to play it.

Switching modes using the function button

- ▶ Press the  function button one or more times.
- i** By pressing the function button repeatedly, you can change the operating mode in the following order:
 - audio CD/DVD/video DVD/MP3 CD/MP3 DVD in the DVD changer or single DVD drive (disc mode)
 - memory card mode
 - MUSIC REGISTER

- USB storage device
 - Media Interface or audio AUX mode
 - Bluetooth® audio mode
- ▶ Select an audio medium from the media list (▷ page 426).

Switching modes via the audio menu

- ▶ Select **Audio** in the main function bar by sliding **↑** and turning the COMAND controller and press **⏵** to confirm. The last active audio source is now activated.
- You can activate a different audio source using the audio menu.
- ▶ Select **Audio** by sliding **↑** and turning the COMAND controller and press **⏵** to confirm. The audio menu appears.
- ▶ Select **Disc, Memory Card, Music Register, USB Storage** or **Media Interface** and press **⏵** to confirm. This switches to the desired audio source.
- ▶ Select an audio medium from the media list (▷ page 426).

Example display: audio CD mode

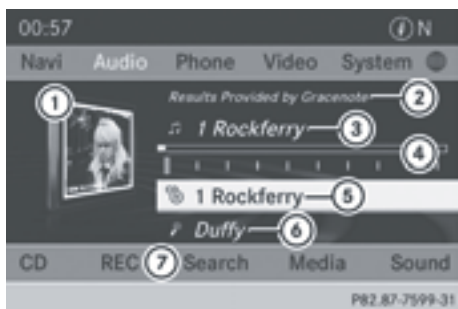

- ① CD cover (if available)
- ② Gracenote data is read, then the elapsed track time
- ③ Track number and track name (if stored on the disc as CD text or if Gracenote® data is available)
- ④ Graphic time and track display

- ⑤ Disc type, disc position in the media list and disc name (if stored on the disc as CD text or if Gracenote® data is available)
- ⑥ Artist (if stored on the disc as CD text or if Gracenote® data is available)
- ⑦ CD mode menu

Example display: audio DVD mode



- ① Cover (if available)
- ② Track time
- ③ Track number
- ④ Graphic time and track display
- ⑤ Disc type, disc position in the media list, disc name (only if stored on the disc)
- ⑥ Audio DVD mode menu

Example display: MP3 mode







- ① Cover (if available)
- ② Track time
- ③ Track number and name
- ④ Graphic time and track display
- ⑤ Medium type, position of medium in the media list, current folder











- ⑥ Artist (if available)
- ⑦ MP3 mode menu

Pause function

In audio CD/DVD and MP3 mode









- ▶ **To pause playback:** briefly press the  button.
The  symbol appears at the top left in the status bar.
- ▶ **To continue playback:** briefly press the  button again.
The  symbol disappears.



In audio DVD mode only

- ▶ **To pause playback:** switch on audio DVD mode (> page 424).
- ▶ Select  by sliding  and turning  the COMAND controller and press  to confirm.
The  display changes to .
- ▶ **To continue playback:** select  and press  to confirm.
Playback continues from the point where it was interrupted. The  display changes to .





Stop function

This function is only available in audio DVD mode.

- ▶ Switch on audio DVD mode (> page 424).
- ▶ **To interrupt playback:** select  by sliding  and turning  the COMAND controller and press  to confirm.
The  display changes to . The  symbol remains highlighted.
- ▶ **To continue playback:** select  and press  to confirm.
Playback continues from the point where it was interrupted.

- ▶ **To stop playback:** while playback is interrupted, select  again and press  to confirm.

or





- ▶ Select  and confirm by pressing  twice in rapid succession.
 is highlighted.
- ▶ **To restart playback:** select  and press  to confirm.
Playback starts at the beginning of the DVD.



Selecting audio CD/DVD/MP3 discs

Selecting via the media list



Media list when equipped with a DVD changer



- ▶ **In CD/audio DVD and MP3 mode:** select **Media** by sliding  or turning  the COMAND controller and press  to confirm.
The media list appears. The • dot indicates the current medium being played.
The media list shows the discs currently available.
View in ①:
 -  magazine tray not shown
 -  magazine tray shown

- ▶ **To switch the display:** select **1...6 Changer** by turning  the COMAND controller and press  to confirm. Depending on the previous setting, the magazine trays are shown or not shown.

i If a disc cannot be read, an entry appears next to the corresponding magazine tray.



Media list showing all magazine trays

- ▶ Select the data medium by turning  the COMAND controller and press  to confirm.

The following tables list the selection options in the media list for the respective equipment variants.

For DVD changer

Magazine trays, positions 1 to 6: readable data media are audio CDs, MP3 CDs or MP3 DVDs, audio DVDs and video DVDs.

Memory card, position 7

MUSIC REGISTER, position 8

USB storage device, position 9

Media Interface, position 0

Bluetooth® audio

Equipped with a single DVD drive

DVD drive, position 1: readable data media are audio CDs, MP3 CDs or MP3 DVDs, audio DVDs and video DVDs.

Memory card, position 2

MUSIC REGISTER, position 3

USB storage device: position 4

Media Interface: position 5

Bluetooth® audio: position 6

i If you select a video DVD, the system switches to video DVD mode (▷ page 453).

Selecting a track using the number keypad

- ▶ When the display/selection window is active, press a number key, e.g. . The medium at the corresponding position in the media list is loaded and then played.

Selecting a track

Selecting by skipping to a track

- ▶ **To skip forwards or back to a track:** turn  the COMAND controller when the display/selection window is active.

or

- ▶ Press the  or  button.

The skip forward function skips to the next track.

The skip back function skips to the beginning of the current track if the track has been playing for more than eight seconds. If the track has been playing for less than eight seconds, it skips to the start of the previous track.

If the **Random Tracks** or **Random Folder** playback option has been selected, the track order is random.

Selecting a track using the number keypad

- ▶ Press the  key on the number keypad. A numerical entry field appears. The number of positions offered corresponds to the number of tracks on the CD/DVD. Only

numbers that correspond to a track number on the CD/DVD can be entered.

- ▶ Enter the desired track number using the number keys.

The track plays after the last possible number is entered.

- ❗ Pressing and holding a number key for more than two seconds completes the entry, and the corresponding track is played.

Selecting a track using music search



- ▶ Select **Current Tracklist**, **Folder** or a category and press to confirm.

Select music via categories (e.g. album, artist) with the music search function.

If you select a category, COMAND starts a search for track information if the following conditions are fulfilled:

- the data carriers are inserted or connected
- the track information from these data carriers is not yet contained in the COMAND music database

COMAND imports track information from the following data carriers:

- disc (audio CD/DVD/MP3)
- memory card
- MUSIC REGISTER
- USB storage device

The **Track information is complete.**

message appears once the search is completed. COMAND stores the music data in its own database. You can now select the

available music data within the desired category.

You will find further information on searching for music in the "Music search" section (▶ page 433).

- ▶ In audio CD/audio DVD mode/MP3 mode, select **Search** by sliding and turning the COMAND controller and press to confirm.
The category list appears.



Example: current track list

- ▶ Select the track by turning the COMAND controller and press to confirm.
The basic display appears and the track is played.

Fast forwarding/rewinding

- ▶ While the display/selection window is active, slide and hold the COMAND controller until the desired position has been reached.

or

- ▶ Press and hold the or button until the desired position is reached.

Gracenote Media Database

Introduction

This function is only available in audio CD mode.



There is a version of Gracenote® music recognition technology, Emeryville, California, USA on the COMAND hard disk. You will recognize this by the logo which can be seen in the bottom right-hand corner of certain audio displays.

Many audio CDs contain CD text. COMAND uses the information contained therein to display the artist, album and track name.

If the audio CD does not contain any CD text information, COMAND can use the Gracenote® Media Database to identify unknown audio tracks when in audio CD mode. This is only possible if the relevant information is saved in the Gracenote Media Database and if the "Gracenote Media Database" function is activated.

If this is the case, COMAND will display the corresponding data such as artist, album and track name in the relevant displays and lists.

Selecting Gracenote® data to be displayed

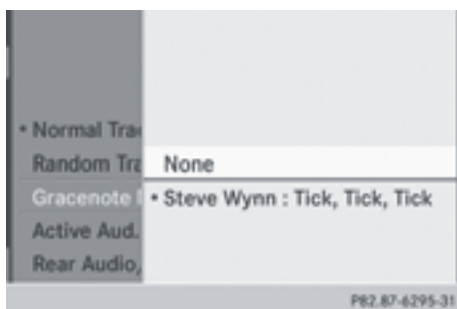

- ▶ Switch on audio CD mode (▷ page 424).
- ▶ Select **CD** by sliding $\odot \updownarrow$ and turning $\left\{ \odot \right\}$ the COMAND controller and press \odot to confirm.
- ▶ Select **Gracenote Media Database** by turning $\left\{ \odot \right\}$ the COMAND controller and press \odot to confirm.

A menu appears.

The \bullet dot indicates the current selection for the display.

If several entries exist for the CD of a particular artist, you can select which of the entries should be shown.

If the inserted CD does not contain any Gracenote® data, the **Gracenote Media Database** menu item is shown in gray and cannot be selected.

- ▶ Select an entry by turning $\left\{ \odot \right\}$ the COMAND controller and press \odot to confirm.

Switching the Gracenote® data display on/off

- ▶ Switch on audio CD mode (▷ page 424).
- ▶ Select **CD** by sliding $\odot \updownarrow$ and turning $\left\{ \odot \right\}$ the COMAND controller and press \odot to confirm.
- ▶ Select **Gracenote Media Database** by turning $\left\{ \odot \right\}$ the COMAND controller and press \odot to confirm.

- ▶ **To switch off the display:** select **None** and press \odot to confirm.

In the basic display, **Track 1**, **Track 2** etc. are shown instead of the Gracenote® data, for example (▷ page 425).

- ▶ **To switch on the display:** select an entry in the menu by turning $\left\{ \odot \right\}$ the COMAND controller and press \odot to confirm.

Updating Gracenote® music recognition technology and the Gracenote Media Database

Due to the release of new CDs, the digital data on the Gracenote Media Database must be

updated. Optimum functionality can only be attained with up-to-date Gracenote® music recognition technology. Information about new versions can be obtained from an authorized Mercedes-Benz Center.

You can have your music recognition software updated there with a DVD, or you can update it yourself.

- i** The Gracenote Media Database is updated in conjunction with the navigation system's digital map (▷ page 353).

Displaying the track and album

- ▶ Press . The current track and album are displayed in a window.

Displaying metadata (MP3 mode)

COMAND can also display the album name and artist (metadata) during playback if this information has been entered into the system.

For all media that contain MP3 data (e.g. MP3 CD, SD memory card, MUSIC REGISTER), you can determine whether:

- the metadata contained in the tags of the encoded music data should be displayed
 - the file and directory names should be displayed during playback
- ▶ **To display the album and artist name:** select **MP3** or **USB** in the basic display by sliding and turning the COMAND controller and press to confirm.
 - ▶ Select **Display Track Information** and press to confirm.

Selecting a group

The content of an audio DVD can be divided into up to 9 groups. The availability and type of group depends on the respective DVD.

A group can contain music in different sound qualities (stereo and multichannel formats, for example), or bonus tracks.

Each group can contain up to 99 tracks.

If an audio DVD only contains one audio format, the **Group** menu item(s) cannot be selected.

- ▶ Switch on audio DVD mode (▷ page 424).
- ▶ Select **DVD-A** by sliding and turning the COMAND controller and press to confirm.
- ▶ Select **Group** by turning and press to confirm. The **•** dot indicates the group currently selected.
- ▶ Select the desired group by turning and press to confirm.
- ▶ **To exit the menu:** slide the COMAND controller or press the back button.

Selecting an active partition (USB mass storage devices only)

You can select this function for USB mass storage devices when the storage device is partitioned. Up to 9 partitions (primary or logical; FAT and FAT32) are supported.

- ▶ Select **MP3** in the basic display by sliding and turning the COMAND controller and press to confirm.
- ▶ Select **Select Active Partition** and press to confirm.

Playback options

- ▶ **To select options:** switch on audio CD/ DVD or MP3 mode (▷ page 424).
- ▶ Select **CD**, **DVD-A** or **MP3** by sliding and turning the COMAND controller and press to confirm. The options list appears. The **•** dot indicates the option selected.
- ▶ Select an option by turning and press to confirm. The option is switched on. For all options except **Normal Track Sequence**, you will see a corresponding display in the display/

selection window. See the example of the display in audio CD mode (▷ page 425).

The following options are available to you:

- **Normal Track Sequence**

The tracks are played in the normal order (e.g. track 1, 2, 3, etc.).

In MP3 mode, the track order is determined by the order in which the tracks are written to the MP3 data carrier when it is created. Alphabetical order is the most common.

Once all the tracks in a folder have been played, the tracks in the next folder are played.

- **Random Medium**

All the tracks on the medium are played in random order (e.g. track 3, 8, 5 etc.).

- **Random Track List** (MP3 mode only)

You hear the tracks of the current track list or the currently active folder (including all subfolders) in random order.

i The **Normal Track Sequence** option is automatically selected when you change the disc you are currently listening to or when you select a different medium. If an option is selected, it remains selected after COMAND is switched on or off.

Notes on MP3 mode

General notes

Depending on the volume and format of the MP3 data, the length of time required for reading the data may increase.

Permissible data carriers

- CD-R and CD-RW
- DVD-R and DVD-RW
- DVD+R and DVD+RW
- SD memory card
- USB storage device

Permissible file systems

- ISO 9660/Joliet standard for CDs
- UDF for audio and video DVDs
- FAT16 or FAT32 for SD memory cards and USB storage media

Multisession CDs

For multisession CDs, the content of the first session determines how COMAND will process the CD. COMAND plays only one session and gives priority to the audio CD session.

If possible, use COMAND to play only CDs that have been written in one session.

File structure of a data carrier

When you create a disc with compressed music files, the tracks can be organized in folders. A folder may also contain subfolders. The disc may contain no more than eight directory levels. Files beyond the eighth level will not be recognized by the system.

Track and file names

When you create a disc with compressed music files, you can assign names to the tracks and folders.

COMAND uses these names accordingly for the display. Folders that contain data other than MP3 or WMA tracks are not displayed by COMAND.

If MP3 or WMA files are stored in the root directory itself, the root directory will also be treated as a folder. COMAND will then show the name of the root directory as the folder name.

You must observe the following when assigning track names:

- track names must have at least one character.
- track names must have the extension "mp3" or "wma".
- there must be a dot between the track name and the extension.

Example of a correct track name:
"Track 1.mp3".

Permissible formats

COMAND supports the following formats:

- MPEG1 Audio Layer 3 (MP3)
- Microsoft Windows Media Audio V8 and V9 (WMA) without copy protection
Microsoft Windows Media Audio V2, V7, V8 and V9 (WMA)
- additional music files in AAC format with the file extensions .aac, .mp4, .m4a and .m4b, but not copy-protected iTunes music files with the extension .m4p.

i If, in addition to MP3 files, there are other music files in these audio formats stored on the disc, the loading process may require a longer time before the first track is played.

i The MP3 audio encoding method is under license from Fraunhofer IIS (Institut Integrierte Schaltungen – Institute for Integrated Circuits) and Thomson.

Permissible bit and sampling rates

COMAND supports **MP3** files of the following types:

- fixed and variable bit rates from 32 kbit/s to 320 kbit/s
- sampling rates of 8 kHz to 48 kHz

COMAND supports **WMA** files of the following types:

- fixed bit rates from 5 kbit/s to 384 kbit/s
- sampling rates of 8 kHz to 48 kHz

COMAND does **not** support **WMA** files of the following types:

- DRM (Digital Rights Management) encrypted files
- variable bit rate
- WMA Pro
- 5.1 Surround

i Only use tracks with a bit rate of at least 128 kbit/s and a sampling rate of at least 44.1 kHz. Lower rates can cause a noticeable deterioration in quality. This is especially the case if you have activated a surround sound function.

Notes on copyright

MP3 or WMA tracks that you create or play back are generally subject to copyright protection in accordance with the applicable international and national regulations.

In many countries, reproductions, even for private use, are not permitted without the prior consent of the copyright holder.

Make sure that you know about the applicable copyright regulations and that you comply with these.

If you own these rights yourself, e.g. for your own compositions and recordings, or if the copyright holder has granted you permission, these restrictions do not apply.

Notes on CDs/DVDs

! COMAND is designed to play discs that comply with the EN 60908 standard. Therefore, you can only use discs with a maximum thickness of 1.3 mm.

If you insert thicker discs, e.g. those that contain data on both sides (DVD on one side and audio data on the other), they cannot be ejected and can damage the device.

Only use round discs with a diameter of 12 cm. Do not use discs with a diameter of 8 cm, even with an adapter.

Discs with copy protection are not compatible with the audio CD standard and therefore may not be able to be played by COMAND.

Playback problems may occur when playing copied discs. There is a wide range of data carriers, disc-writing software and writers available. This variety means that there is no guarantee that the system will be able to play discs that you have copied yourself.

There may be playback problems if you play CDs that you have copied yourself with a storage capacity of more than 700 MB. CDs of this type do not conform to the currently applicable standards.

i On many DVD audio discs, the last track does not contain any music. If COMAND

therefore switches to the next disc, it is normal system behavior and does not mean that there is a malfunction.

- ❶ COMAND is able to play back audio CDs in multichannel audio format.

Music search

Calling up a category list



Category list

- ▶ Switch on an audio source and call up the basic display, e.g. MP3 mode (▶ page 425).
- ▶ Select **Search** by sliding $\odot \downarrow$ and turning $\left\{ \odot \right\}$ the COMAND controller and press \odot to confirm. The category list appears.

The categories are displayed according to the data available. The categories **Current Tracklist**, **Folder**, **Playlists** (if available) and **Photos** (if available) are already assigned. The other available categories are filled by the music search.

Selecting a category

Starting a music search

Select music via categories (e.g. album, artist) with the music search function.

If you select a category, COMAND starts a music search under the following conditions:

- the data carriers are inserted or connected
- the music tracks on these data carriers are not yet in the COMAND music database.

COMAND reads music tracks from the following data carriers:

- disc (audio CD/DVD/MP3)
- memory card
- MUSIC REGISTER
- USB storage device

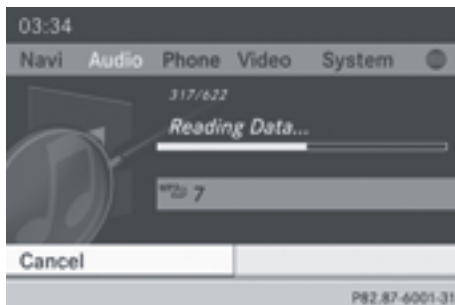

- ▶ Select a category in the category list by turning $\left\{ \odot \right\}$ the COMAND controller and press \odot to confirm. The **Reading Data...** message appears. The search may take some time, depending on the number of tracks available.

The **Track information is complete** message appears once the search is completed. Playback then starts with the previously active audio source.

- ▶ **To cancel the music search:** confirm **Cancel** by pressing \odot .

Selecting artists

- ▶ Select **Artists** in the category list by turning $\left\{ \odot \right\}$ the COMAND controller and press \odot to confirm. The available artists are displayed alphabetically.

Selecting an album

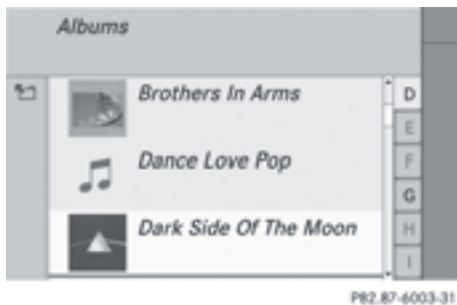

- ▶ Select **Albums** in the category list by turning **⏮** the COMAND controller and press **⏹** to confirm. The available albums are displayed alphabetically. If there is a cover available for an album, it is displayed in front of the album name.

Selecting a track



- ▶ Select **Tracks** in the category list (▷ page 433) by turning **⏮** the COMAND controller and press **⏹** to confirm. The available tracks are displayed.

Selecting a year of publication



- ▶ Select **Year** in the category list (▷ page 433) by turning **⏮** the COMAND controller and press **⏹** to confirm.
- ▶ Select an entry and press **⏹** to confirm. The genre list is displayed.
- ▶ Select a genre, e.g. pop, and press **⏹** to confirm. The track list is displayed.
- ▶ Select a track and press **⏹** to confirm. Playback starts.

Selecting composers

- ▶ Select **Composers** in the category list by turning **⏮** the COMAND controller and press **⏹** to confirm. The available composers are displayed alphabetically.

Selecting music genres

- ▶ Select **Genres** in the category list by turning **⏮** the COMAND controller and press **⏹** to confirm. The available music genres are displayed alphabetically.

Selecting a cover

- ▶ Select **Select By Cover** in the category list (▷ page 433) by turning **⏮** the COMAND controller and press **⏹** to confirm. The available covers are displayed in alphabetical order of the artists.

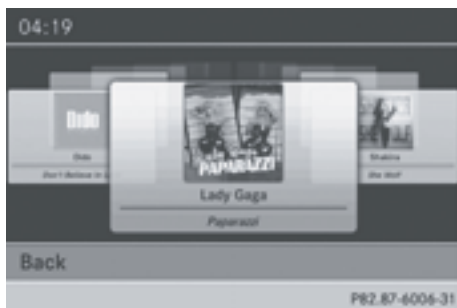

- ▶ Select the desired cover by turning **⏪** the COMAND controller and press **⏩** to confirm.
The corresponding album is played.

Selection via keyword search

- ▶ Select **Keyword Search** in the category list by turning **⏪** the COMAND controller and press **⏩** to confirm.
An input menu appears.



- ▶ **To change the character set used in the character bar:** highlight **Select** by sliding **⏪** and turning **⏪** the COMAND controller and press **⏩** to confirm.
A list of available character sets is shown.
- ▶ Select the desired character set and press **⏩** to confirm.
- ▶ Enter characters and confirm the entry.
Character entry (▷ page 281).
Depending on the entry, the hits are shown in a list.



- ▶ Select an entry by turning **⏪** the COMAND controller and press **⏩** to confirm.



- ▶ Select an entry, e.g. **Artists**, and press **⏩** to confirm.
The album and cover (if available) are displayed.



- ▶ Confirm the album with **⏩**.
The tracks on the album are displayed.



- ▶ Select a track and press to confirm. Playback starts and the basic display appears.

MUSIC REGISTER

General notes

- ! Retain the original music files in a secure location. An error in COMAND might result in the loss of the music files stored in the MUSIC REGISTER. Mercedes-Benz is not liable for any loss of data.

You can store music files in a compressed format in the MUSIC REGISTER (▷ page 437). The memory has a capacity of 10 GB.

Switching to MUSIC REGISTER

MUSIC REGISTER basic display



Example: MUSIC REGISTER

- ① Cover (if available)
- ② Track time

- ③ Track number and name
- ④ Graphic time and track display
- ⑤ Position of the medium in the media list and name of the medium, followed by the current playback option (no display for [Normal Track Sequence](#))
- ⑥ Artist
- ⑦ MUSIC REGISTER menu bar

Option 1

- ▶ Press the function button repeatedly until the MUSIC REGISTER is switched on. By pressing the function button repeatedly, you can change the operating mode in the following order:

- audio CD/DVD/MP3 (disc)
- memory card mode
- MUSIC REGISTER
- USB storage device
- Media Interface or audio AUX mode
- Bluetooth® audio mode

If music files are available, playback begins at the point last listened to.

If there are no music files, you will see a message to this effect.

- ▶ Confirm the message by pressing the COMAND controller and copy the music files (▷ page 437).

Option 2

- ▶ Select **Audio** in the main function bar by sliding and turning the COMAND controller and press to confirm. If MUSIC REGISTER was the last mode selected, it is now switched on. If another audio source is switched on, you can now switch on the MUSIC REGISTER in the audio menu.
- ▶ Select **Audio** by sliding and turning the COMAND controller and press to confirm. The audio menu appears.

- ▶ Select **Music Register** and press to confirm.

Option 3

- ▶ Press the number key (for a DVD changer).
The MUSIC REGISTER is switched on.

Importing music files

Introduction

You can copy music files in the following file formats from the data carrier in the single DVD drive or in the DVD changer:

- MP3
- WMA
- AAC (with file extensions .m4p, .m4a, .m4b and .aac)
- ▶ Switch on audio CD mode (▶ page 424).
- ▶ With an audio CD inserted, select **REC** in the basic CD display by sliding and turning the COMAND controller and press to confirm.

i CD information such as album name, disk name, artist and track is provided through Gracenote Media Database (▶ page 428).

Step 1: selecting tracks to import

- ▶ Select **Track(s)** by turning the COMAND controller and press to confirm.



- ① To record all music files (standard)
- ② To copy single tracks
- ③ To confirm your selection

If you do not select any tracks, every track on the CD will be imported.

Step 2: selecting the target folder

- ▶ Select **Folder** by turning the COMAND controller and press to confirm.

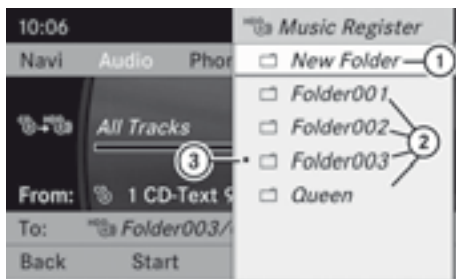

- ① To create a new folder (standard)
- ② Existing folders
- ③ Currently selected folder

- ▶ Select a folder by turning the COMAND controller and press to confirm.

If you do not select a target folder, a new one will be created.

Step 3: beginning the import

- ▶ Select **Start** by turning the COMAND controller and press to confirm. Information about the import source and target as well as the progress is displayed. The Audio CD basic display automatically appears after successful import.

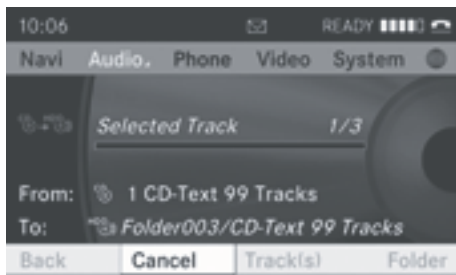





P82.87-6785-31

- ▶ **To cancel importing:** during importing, confirm **Cancel** by pressing  the COMAND controller. The Audio CD basic display appears.





Deleting all music files

- ! In order to prevent malfunctions, do not use COMAND during this time.

This function deletes all music files from the MUSIC REGISTER.

- ▶ Switch to the MUSIC REGISTER (▷ page 436).
- ▶ Select **Music Register** by sliding  and turning  the COMAND controller and press  to confirm.
- ▶ Select **Delete All Music Files** and press  to confirm. A prompt appears. **No** is highlighted. If you select **Yes**, all music files are deleted. You see the **Please Wait...** message. Then, you see the **Data deleted** message. If you select **No**, the process will be canceled.

Calling up memory space info



- ▶ Switch to the MUSIC REGISTER (▷ page 436).
- ▶ Select **Music Register** by sliding  and turning  the COMAND controller and press  to confirm.
- ▶ Select **Memory Info** and press  to confirm. The following is displayed:
 - storage capacity
 - available memory
 - occupied memory
 - content (folders, tracks)

Music search



Introduction

The music search finds tracks via all available media. The search begins with the audio source that is currently active.

The following media are included for the music search:



- disc (audio CD/DVD/MP3)
- memory card
- MUSIC REGISTER
- USB storage device
- ▶ Switch to the MUSIC REGISTER (▷ page 436).
- ▶ Select **Search** by sliding  and turning  the COMAND controller and press  to confirm. The category list appears.
- ▶ Select a track in a category (▷ page 433).

Example: opening a folder

- ▶ Select **Folder** in the category list by turning  the COMAND controller and press  to confirm. You see the contents of the current folder.



The name of the current folder is at the top and the track currently playing is indicated by a • dot.

- ▶ **To switch to the next folder up:** press the  back button or slide  the COMAND controller.

Changing the folder/track name

- ▶ Switch to the MUSIC REGISTER (▷ page 436).
- ▶ Select **Music Register** by sliding $\odot \downarrow$ and turning $\{\odot\}$ the COMAND controller and press \odot to confirm.
- ▶ Select **Rename / Delete Files** and press \odot to confirm.
- ▶ Select a folder/track by turning $\{\odot\}$.
- ▶ Select **Options** by sliding $\odot \rightarrow$ and press \odot to confirm.
- ▶ Select **Change** and press \odot to confirm.
- ▶ Enter a name for the folder/track. Instructions for entering characters can be found in the "Character entry" section (▷ page 281).
- ▶ **To save the changes:** select **ok** and press \odot to confirm.

Deleting folders/tracks

- ▶ Switch to the MUSIC REGISTER (▷ page 436).
- ▶ Select **Music Register** by sliding $\odot \downarrow$ and turning $\{\odot\}$ the COMAND controller and press \odot to confirm.
- ▶ Select **Rename / Delete Files** and press \odot to confirm.
- ▶ Select a folder/track by turning $\{\odot\}$.
- ▶ Select **Options** by sliding $\odot \rightarrow$ and press \odot to confirm.
- ▶ Select **Delete** and press \odot to confirm. A query appears. **No** is highlighted. If you select **Yes**, the folders/tracks are deleted. You see the **Please Wait...** message. Then, you see the **Data deleted** message. If you select **No**, the process will be canceled.

Playback options

The following options are available:

- **Normal Track Sequence**

The tracks are played in the normal order (e.g. track 1, 2, 3, etc.).

- **Random Medium**

All the tracks on the medium are played in random order.

- **Random Track List** (MP3 mode only)

The tracks in the currently active folder or the current track list are played in a random order.

- ▶ **To select options:** switch to the MUSIC REGISTER (▷ page 436).

- ▶ Select **Music Register** by sliding $\odot \downarrow$ and turning $\{\odot\}$ the COMAND controller and press \odot to confirm.

The options list appears. The • dot indicates the option selected.

- ▶ Select an option and press \odot to confirm. The option is switched on. For all options except **Normal Track Sequence**, you will see a corresponding display in the display/selection window.

- ▶ **i** The **Normal Track Sequence** option is automatically selected when you change the disc you are currently listening to or when you select a different medium. If an option is selected, it remains selected after COMAND is switched on or off.

Bluetooth® audio mode

Preconditions for the Bluetooth® audio device

Bluetooth® audio mode requires a Bluetooth®-capable audio device. Observe the information in the Bluetooth® audio device's operating instructions.

Before using Bluetooth® audio mode, you should check your Bluetooth® audio device for the following:

- Bluetooth® audio profile

The Bluetooth® audio device must support the A2DP and AVRCP Bluetooth® audio profiles.

- Bluetooth® visibility

Certain Bluetooth® audio devices do not just require activation of the Bluetooth® function. In addition, your device must be made "visible" to other devices.

- Bluetooth® device name

This device name is predetermined but can usually be changed. To make a clear selection of the Bluetooth® device possible, Mercedes-Benz recommends that you customize the device name.

i A2DP (**A**dvanced **A**udio **D**istribution **P**rofile): Bluetooth® audio profile for audio data transmission

AVRCP (**A**udio **V**ideo **R**emote **C**ontrol **P**rofile): Bluetooth® audio profile for audio data playback

i Not all Bluetooth® audio devices available on the market are equally suitable. To obtain more information about suitable Bluetooth® audio devices and about connecting Bluetooth® audio devices to COMAND, visit

<http://www.mbusa-mobile.com> (USA). Alternatively, call the Mercedes-Benz Customer Assistance Center at 1-800-FOR-MERCEdes(1-800-367-6372) (USA) or Customer Relations at 1-800-387-0100 (Canada).

▶ Activate Bluetooth® and Bluetooth® visibility on the Bluetooth® audio device.

Preconditions in COMAND

▶ Activate the Bluetooth® function in COMAND (▷ page 292).

Connecting Bluetooth® audio devices

General information

Before using your Bluetooth® audio device with COMAND for the first time, you will need to authorize it.

When you authorize a new Bluetooth® audio device, it is connected automatically.

Connection involves first searching for a Bluetooth® audio device and then authorizing it.

You can authorize up to fifteen Bluetooth® devices.

i If you authorize a mobile phone that supports Bluetooth® audio, the A2DP and AVRCP Bluetooth® audio profiles are connected automatically.

The mobile phone is then entered:

- in the Bluetooth® telephone list (▷ page 360)
- in the Bluetooth® device list (▷ page 440).

Mercedes-Benz recommends authorizing a mobile phone in Bluetooth® telephony (▷ page 360).

Searching for and authorizing a Bluetooth® audio device



Example: Bluetooth® device list

- ① Newly detected mobile phone with Bluetooth® audio function in range
- ② Bluetooth® audio player not within range but previously authorized (symbol appears in gray)

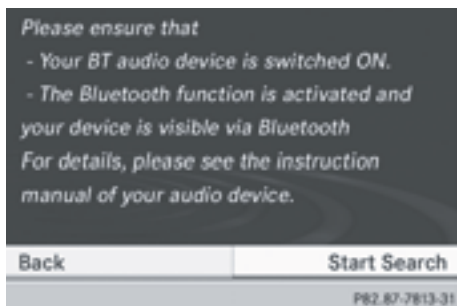

The Bluetooth® device list displays all authorized devices, whether they are within range or not. After a device search, devices which are within range but not authorized are also displayed.

- ▶ Switch on Bluetooth® audio mode (> page 443).
If you see the **No Bluetooth Audio Device Authorized** message, you will need to authorize the Bluetooth® audio device first.
- ▶ Select **BT Audio** by sliding $\odot \downarrow$ and turning $\{\odot\}$ the COMAND controller and press \odot to confirm.
- ▶ Confirm **Bluetooth Audio Device List** by pressing \odot the COMAND controller.
- ▶ **To search:** confirm **Search for BT Audio Devices** by pressing the COMAND controller \odot .

COMAND searches for Bluetooth® audio devices within range and adds them to the Bluetooth® device list. Bluetooth® audio devices are detected if they support the Bluetooth® audio profiles (A2DP, AVRCP).

The duration of the search depends on the number of Bluetooth® audio devices within range and their characteristics.

- ▶ **To authorize:** select an unauthorized Bluetooth® audio device from the list (① in the example) by turning $\{\odot\}$ the COMAND controller.
- ▶ Select the symbol to the right of the Bluetooth® audio device by sliding $\odot \rightarrow$ the

COMAND controller and press \odot to confirm.

- ▶ Select **Authorize** and press \odot to confirm. Depending on the Bluetooth® audio device used, you now have two options for continuing with authorization.

- ▶ **Option 1:** enter the passkey. You can find information on this in the "Authorizing (registering) a mobile phone" section (> page 360).

After successful authorization, the Bluetooth® audio device is connected and starts playing.

- ▶ **Option 2 (Secure Simple Pairing):** if the digit codes displayed in COMAND and on the Bluetooth® audio device are the same, confirm **Yes** by pressing \odot .

If you select **Yes**, authorization continues and the Bluetooth® audio device is connected. Playback starts.

If you select **No**, authorization will be canceled.

- ❗ The Bluetooth® audio device must support the Bluetooth® version 2.1 for connection via Secure Simple Pairing. COMAND creates a six-digit code, which is displayed on the two devices that are to be connected.

External authorization

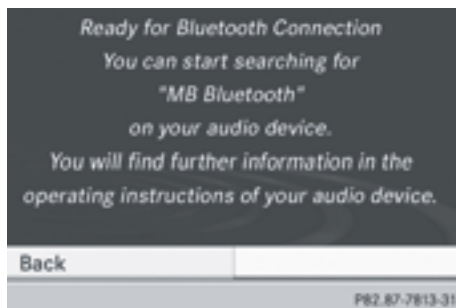

If COMAND does not find your Bluetooth® audio device, this may be due to particular security settings on your Bluetooth® audio device. In this case, check whether your Bluetooth® audio device can locate the

COMAND system. The Bluetooth® device name of COMAND is "MB Bluetooth".

- ▶ Switch on Bluetooth® audio mode (▷ page 443).
- ▶ Select **BT Audio** by sliding and turning the COMAND controller and press to confirm.
- ▶ Confirm **Bluetooth Audio Device List** by pressing the COMAND controller.
- ▶ **To search:** confirm **Connect via BT Audio Device** by pressing the COMAND controller .

The duration of the search depends on the number of Bluetooth® audio devices within range and their characteristics.

- ▶ **To authorize:** start the authorization on the Bluetooth® audio device, see the operating instructions of the Bluetooth® audio device. After successful authorization, the Bluetooth® audio device is connected and starts playing.

- i** On some Bluetooth® audio devices, playback must first be started on the device itself, so that COMAND can play the audio data.

Reconnecting a Bluetooth® audio device

The Bluetooth® audio profiles are connected automatically under the following circumstances:

- one of the last two mobile phones to have been connected has also been used as a Bluetooth® audio player (if this function is supported by the mobile phone).
- the mobile phone takes over the automatic connection itself.

A Bluetooth® audio player without telephone functions is not automatically reconnected, even if it was the last device connected.

If the **No Bluetooth Audio Device Connected** message appears, you have two options to connect a Bluetooth® audio device:

Connecting last device

- ▶ Confirm **Connect Last Device** in the basic display by pressing the COMAND controller. If COMAND can locate the Bluetooth® audio device, it will be connected and start playing.

- i** With some Bluetooth® audio devices, playback must first be started on the device itself, so that COMAND can play the audio data.

Connecting a device from a list

- ▶ Select **BT Audio** by turning the COMAND controller and press to confirm.
- ▶ Confirm **Bluetooth Audio Device List** by pressing the COMAND controller.
- ▶ Select a Bluetooth® audio device by turning the COMAND controller and press to confirm. If COMAND can locate the Bluetooth® audio device, it will be connected and start playing.

- i** With some Bluetooth® audio devices, playback must first be started on the device itself, so that COMAND can play the audio data.

Bluetooth® audio device and simultaneous search for mobile phones

During the search for mobile phones, the connection with the Bluetooth® audio device is terminated (▷ page 359). In the Bluetooth® audio basic display, you will see the **No Bluetooth Audio Device Connected** message and the **Connect Last Device** menu item cannot be selected.

Displaying details

- ▶ Select a Bluetooth® audio device in the Bluetooth® device list.
- ▶ Select the symbol to the right of the Bluetooth® audio device by sliding the COMAND controller and press to confirm.

- ▶ Select **Details** and press to confirm. The following information concerning the selected mobile phone is shown:
 - Bluetooth® name
 - Bluetooth® address
 - availability status (shown after an update)
 - authorization status
- ▶ **To close the detailed view:** turn or slide the COMAND controller.

De-authorizing (deregistering) a Bluetooth® audio device

- ▶ Select a Bluetooth® audio device in the Bluetooth® device list.
- ▶ Select the symbol to the right of the Bluetooth® audio device by sliding to the COMAND controller and press to confirm.
- ▶ Select **De-authorize** and press to confirm. A prompt appears asking whether you really wish to de-authorize this device.
- ▶ Select **Yes** or **No**.
 - If you select **Yes**, the device will be deleted from the Bluetooth® device list.
 - If you select **No**, the process will be canceled.
- ▶ **i** Before re-authorizing the Bluetooth® audio device, you should also delete the device name **MB Bluetooth** from your Bluetooth® audio device's Bluetooth® list. See the Bluetooth® audio device's operating instructions.

Switching to Bluetooth® audio mode

The Bluetooth® audio basic display



Example: Bluetooth® audio basic display

- ① Track name
 - ② Current playback settings (no symbol for "Normal track sequence")
 - ③ Album name
 - ④ Sound settings
 - ⑤ Media list
 - ⑥ Artist
 - ⑦ To stop or start playback
 - ⑧ To connect a Bluetooth® audio device, to increase the volume on COMAND
 - ⑨ Bluetooth® audio data medium type
 - ⑩ Data medium position in the media list
- i** If the Bluetooth® audio device connected supports metadata and corresponding data is available, then the artist, track and album name can be displayed.

Using the Bluetooth® audio basic display

- ▶ Connect (> page 440) the Bluetooth® audio device.
- or
- ▶ Reconnect the Bluetooth® audio device (> page 442). COMAND activates the Bluetooth® audio device. The basic display appears and the device starts playing.

Using the function button

- ▶ Press the **disc** function button one or more times.

By pressing the function button repeatedly, you can change the operating mode in the following order:

- audio CD/DVD/MP3 (disc)
- memory card mode
- MUSIC REGISTER
- USB storage device
- Media Interface or audio AUX mode
- Bluetooth® audio mode

Using the media list

- ▶ Select **Bluetooth Audio** in the media list by turning **⏮** the COMAND controller and press **⏹** to confirm (▷ page 426). COMAND activates the connected device. You will see a message to this effect. The basic display then appears.

Starting/stopping playback

- ▶ **To start playback:** select **▶** by sliding **⏮** and turning **⏮** the COMAND controller and press **⏹** to confirm. Playback starts. **■** is selected.
- ▶ **To stop playback:** select **■** by turning **⏮** the COMAND controller and press **⏹** to confirm. A message appears. **▶** is selected.
- ▶ **To continue playback:** select **▶** by turning **⏮** the COMAND controller and press **⏹** to confirm. A message appears. **■** is selected.

Restarting playback after stopping

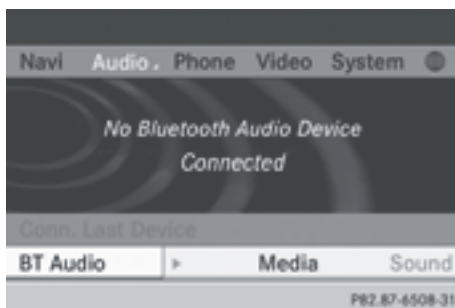

During the search for mobile phones, the connection with the Bluetooth® audio device is terminated (▷ page 359). In the Bluetooth® audio basic display (▷ page 443), you will see the **No Bluetooth Audio Device Connected** message and the **Connect Last Device** menu item cannot be selected.

When the search is finished, the Bluetooth® audio device can be reconnected.

- ▶ Confirm **Connect Last Device** by pressing **⏹**.

Depending on the Bluetooth® audio device used, playback starts immediately or you must start playback manually.



In this case, you will see the **Bluetooth Audio Device Paused** message.







- ▶ **To start playback:** select **▶** by turning **⏮** the COMAND controller and press **⏹** to confirm. Playback resumes from the beginning.



Selecting a track

This function is not supported by all Bluetooth® audio devices.

- ▶ **To skip forwards or backwards to a track:** press the  or  button on COMAND.

or

- ▶ Press the  or  button briefly on the multifunction steering wheel.
- ▶ **Rapid scroll:** press and hold the  or  button on the multifunction steering wheel until the desired track is reached.

If you press and hold the  or  button, the rapid scrolling speed is increased.

Selecting playback options

If the Bluetooth® audio device supports the corresponding function, the following options are available:



- **Normal Track Sequence**

The tracks are played in the normal order (e.g. track 1, 2, 3, etc.).



Audio data playback is determined by the order in which the tracks are written to the data carrier. Alphabetical order is the most common. Once all the tracks in a folder have been played, the tracks in the next folder are played.

- **Random Tracks**

All the tracks on the medium are played in random order (e.g. track 3, 8, 5 etc.).

- ▶ Select **BT Audio** by sliding  and turning  the COMAND controller and press  to confirm.

The  dot indicates the option selected.

- ▶ Select the option by turning  the COMAND controller and press  to confirm.







If you select **Random Tracks**, you will see a corresponding symbol in the display/selection window.

Adjusting the sound settings

Information about sound settings ( page 278).

Increasing the volume using COMAND



- ▶ Select **BT Audio** by sliding  and turning  the COMAND controller and press  to confirm.
- ▶ Select **Volume** and press  to confirm. A menu appears. The  dot indicates the current setting.
- ▶ Select **Standard** or **Boost** and press  to confirm.

You will find further information in the "Audio AUX mode" section ( page 451).

Media Interface mode

Connection options

Overview

The connection sockets are located in the stowage compartment in the center console.

Device-specific adapter cables are required to connect external devices to the Media Interface. Country-specific versions are supplied with the Media Interface.

You can connect the following data carriers to COMAND via the Media Interface:

- iPod®
- iPhone®
- certain MP3 players

- ① Store individual parts in a safe place.

Only use genuine Mercedes-Benz connection cables.

- ① iPod® and iPhone® are registered trademarks of Apple Inc., Cupertino, California, USA.

- ① MP3 players that support MTP (Media Transfer Protocol) can be used.

This allows the MP3 player to be easily connected to the Media Interface and removed after use. Audio data is played without problem.

On some MP3 players, you have to activate the relevant function (see the MP3 player operating instructions).

Supported devices

For details and a list of supported devices, visit <http://www.mbusa-mobile.com>.

Alternatively, call the Mercedes-Benz Customer Assistance Center at 1-800-FOR-MERCEDES (1-800-367-6372) (for USA) or Customer Relations at 1-800-387-0100 (for Canada).

Connecting an external device

Do not leave external devices in the vehicle. They may malfunction in extreme temperatures; see the operating instructions for the respective device. Examples of extreme temperatures are direct sunlight or very low outside temperatures.

Mercedes-Benz USA, LLC accepts no liability for damage to external devices.

- ① Never connect more than one device at a time. You will otherwise not be able to play back from the external device.

USB hubs (devices with several USB connections) are not supported.

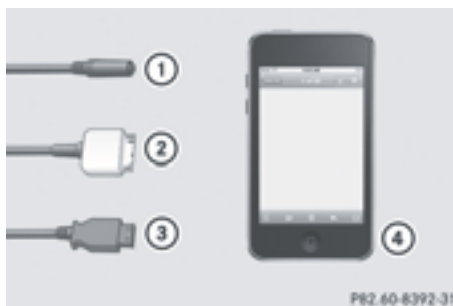

- ① Four-pin socket for 1/8 inch stereo jack, e.g. for MP3 players (audio and video)
- ② iPod® plug for connecting an iPod®
- ③ USB socket for connecting an MP3 player
- ④ Example of device: iPod®

- ▶ Connect the external device with suitable socket ①, ② or ③. COMAND activates the device, a message appears.

If you remove a device, the **No Device Connected** message appears.

- ① A connected iPod® or MP3 player should not be simultaneously operated via the Media Interface and the remote control (e.g. Bluetooth® remote control) or directly via the device itself, as this may cause unforeseen technical difficulties.

Applications (Apps) that are activated on the connected device may lead to malfunctions.

- ① Connecting a fully discharged iPod® or MP3 player can result in an extended initialization period.

Malfunction messages appear while the device is being activated if:

- the connected device is not supported (**External Device Unavailable** message).
- the connected device consumes too much power.

- the Media Interface connection is faulty.
- a mass storage device (e.g. a USB memory stick or USB hard drive) is connected to the Media Interface.

In this case the message **Please connect the device to the other USB port** appears.

- i** The separate USB connection ensures quick access and expanded media content options.
- i** Consult an authorized Mercedes-Benz Center if you have further questions.

Switching to Media Interface mode

General notes

In extreme cases, starting up individual functions can take up to several minutes – this depends on the external device and its content (e.g. video podcasts).

Only use the original software to save files on iPods® or MP3 players. Otherwise, some or all functions may not be available.

Automatic switching

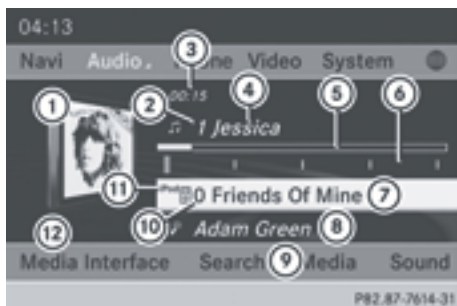

Media Interface mode (iPod® mode) when equipped with a DVD changer

- ① Cover (if available) or representation of device
- ② Track number
- ③ Elapsed track time (also in format 00:00:00 for audio books)
- ④ Track name
- ⑤ Graphic time display

- ⑥ Track position in playlist
- ⑦ Album name (if available)
- ⑧ Artist (if available)
- ⑨ Music search
- ⑩ Position in the media list
- ⑪ Type of data medium
- ⑫ Playback options

The type of device connected is indicated by the corresponding symbol for iPod®, iPhone® or MP3 player ⑪.

The current playback option is shown with a symbol behind album name ⑦ (no display for **Normal Track Sequence**) (▷ page 450).

- ▶ Connect an external device (▷ page 446). COMAND activates the device. The basic display then appears.

- i** If the device connected does not contain any playable tracks, a message appears to this effect.

Switching modes using the function button

The external device is connected to the Media Interface (▷ page 446).



- ▶ Press the **Disc** function button repeatedly until the Media Interface basic menu appears (▷ page 447).

By pressing the function button repeatedly, you can change the operating mode in the following order:

- audio CD/DVD/MP3 (disc)
- memory card mode
- MUSIC REGISTER
- USB storage device
- Media Interface or audio AUX mode
- Bluetooth® audio mode

Switching on using a number key



The external device is connected to the Media Interface (▷ page 446).

- ▶ Press the  number key (for a DVD changer) or the  number key (for a single DVD drive).

This selects the connected external audio device directly. The basic menu for Media Interface appears (▷ page 447).

Switching on via the media list

The external device is connected to the Media Interface (▷ page 446).

- ▶ Select the entry under position 0 (DVD changer) or position 5 (single DVD drive) in the media list by turning  the COMAND controller and press  to confirm (▷ page 426).

COMAND activates the connected device. You will see a message to this effect. Then, the basic menu for the Media Interface appears (▷ page 447).

If no device is connected, you will see the [Media Interface](#) entry instead of a device name.

Selecting music files



Note

COMAND displays the data stored on the iPod®, iPhone® or MP3 player according to the filing structure used in the respective medium.

Selecting by skipping to a track

- ▶ **To skip forwards or back to a track:** turn  the COMAND controller when the display/selection window is active.

or

- ▶ Press the  or  button. The skip forward function skips to the next track. The skip back function skips to the beginning of the current track if the track has been playing for more than eight seconds. If the track has been playing for less than eight seconds, it skips to the start of the previous track. If you have selected a playback option other than [Normal](#)

[Track Sequence](#), the track sequence is random.

Selecting using the number keypad

- ▶ **To make an entry:** press the  button.

An input menu appears. The number of characters available for input depends on the number of stored tracks.

- ▶ **To enter a track number:** press a number key, e.g. .



The digit is entered in the first position in the input line.

- ▶ **i** COMAND will ignore and not display an invalid digit.



- ▶ Enter more numbers if desired. The track plays after the last possible number is entered.

- ▶ **i** Pressing and holding a number key for more than two seconds completes the entry, and the corresponding track is played.

Fast forwarding/rewinding

- ▶ While the display/selection window is active, slide   and hold the COMAND controller until the desired position has been reached.

or

- ▶ Press and hold the  or  button until the desired position is reached.

- ▶ **i** On an iPod® or iPhone®, fast rewind only functions within the current track.

Selecting a category/playlist/folder

Overview

For an iPod®, iPhone® or certain MP3 players, you can select tracks using categories or folders.

Depending on the device connected, the following categories may be available, for example:

- [Current Tracklist](#)
- [Keyword Search](#)
- [Playlists](#) (e.g. [A11](#))

- Artists
- Albums
- Tracks
- Podcasts
- Genres
- Composers
- Audiobooks
- Videos

i Some playback categories contain the entry **All**. If this entry has been selected, the entire content of the category selected will be played.

The **Videos** category is available for iPods® and iPhones®.

i The functions are available as soon as the entire media content has been read and analyzed. For certain functions, such as Keyword search, this can take several minutes. The length of time required for reading the data depends on the size of the media content and the device connected. If the same device is reconnected with unchanged media content, these functions are available much more quickly. However, if you change the media content, it has to be read and analyzed again.

Calling up a category list

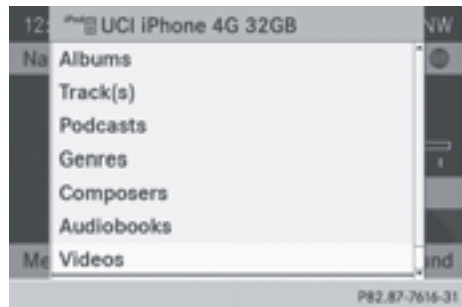

Example: category list

► Select **Search** in the basic display by sliding **⊙** and turning **⌂** the COMAND controller and press **⏻** to confirm. The category list appears.

i **Search** is not available until the device has been activated.

i When the media content of the connected device is being read, **Keyword Search** appears in gray.

The length of time required for reading the data depends on the size of the media content and the connected device and may take a few minutes. When the device is next started or reconnected, the advanced functions will be quickly available.

However, if you change the media content on your iPod®/iPhone®, it has to be read and analyzed again.

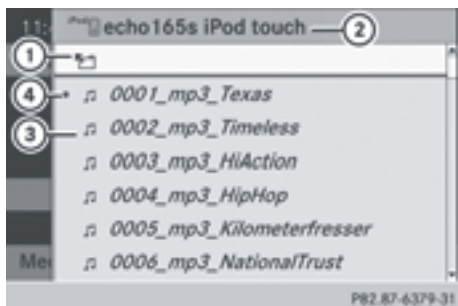

Example: current track list

- ① Symbol for next folder up
- ② Device icon and device name
- ③ Track symbol
- ④ Current title

- ▶ Select **Current Tracklist** by turning $\left\{ \text{Ⓞ} \right\}$ the COMAND controller and press Ⓞ to confirm.

The content of the current track list appears.

- ▶ Select the track by turning $\left\{ \text{Ⓞ} \right\}$ the COMAND controller and press Ⓞ to confirm.

The track is played.

- ▶ **To switch to the next folder up:** slide $\leftarrow \text{Ⓞ}$ the COMAND controller.

or

- ▶ Press the \leftarrow back button.

Playing back the content of a category or folder

- ▶ Select the category or folder by turning $\left\{ \text{Ⓞ} \right\}$ the COMAND controller.
- ▶ Press Ⓞ the COMAND controller for longer than two seconds.

The content of the category or folder selected is played in accordance with the playback option (▷ page 450) selected.

Alphabetical track selection

iPod®, iPhone® and MP3 player

This function is available for alphabetically sorted categories and folders. This function

is not available for albums or playlists, for example.

- ▶ Select a category, e.g. **Artists**, by turning $\left\{ \text{Ⓞ} \right\}$ the COMAND controller and press Ⓞ to confirm.

The available artists are displayed.

- ▶ Press the corresponding number key once or repeatedly to select the initial letter of the desired artist. For example, to select an artist whose name begins with C, press the 2 ABC number key three times.

The available letters are listed at the lower edge of the display.

After a message, the first entry in the list which matches the letter entered is highlighted.

- i** If no corresponding entry exists, the last entry corresponding to a previous letter is highlighted instead.

- i** iPods and MP3 players: the quality of the search results is highly dependent on the version and language variant of the software used to populate the device. iTunes is a well-known media program, for example.

If different sorting rules are defined (e.g. in iTunes®), the search is canceled without any result.

Additional selection functions

• Keyword Search

Selecting keyword search allows you to search through all categories on the connected device for keywords.

- i** More on **Keyword Search** under music search, selecting a category (▷ page 433).

Playback options

- ▶ **To select a playback option:** select **Media Interface** in the basic display by sliding $\text{Ⓞ} \downarrow$ and turning $\left\{ \text{Ⓞ} \right\}$ the COMAND controller and press Ⓞ to confirm. The options list appears. The \bullet dot indicates the option selected.

► Select an option and press  to confirm.

The following options are available:

- **Normal Track Sequence**

Normal track sequence: you hear the tracks in their normal order (e.g. numerical or alphabetical).

- **Random Medium**

All the tracks on the medium are played in random order.

- **Random Track List**

The tracks in the currently active category or folder, including any subfolders, are played in random order.

i For MP3 players, the random playlists offer a maximum of 300 tracks chosen at random.

MP3 player instructions

General notes

Up to 30,000 tracks per medium are supported.

You can speed up some functions and improve the search results by:

- making sure the names of tracks, albums and artists, for example, are written the same way
- labeling albums featuring various artists as “compilations”

i Multiple entries of tracks in playlists are filtered out for some players.

Data formats

MP3 and WMA are supported as data formats with fixed and variable bit rates (up to 320 kbits/s).

Special notes about MP3 players

Up to eight directory levels with up to 1,000 tracks per directory are supported.

Do not use USB extension leads or adapters. They can impair functionality.

i DRM (Digital Rights Management) protected files are not supported by the Media Interface.

Audio AUX mode

Notes on audio AUX mode

You can connect an external audio source (AUX) to COMAND. You will find the necessary socket in the center console stowage compartment.

If COMAND is equipped with a Media Interface, external audio sources are connected using the cable set provided. An AUX socket is not provided. The connections for the Media Interface are located in the stowage compartment in the center console.



i You will find further information online at <http://www.mbusa-mobile.com>. Alternatively, call the Mercedes-Benz Customer Assistance Center at 1-800-FOR-MERcedes (1-800-367-6372) (for USA) or Customer Relations at 1-800-387-0100 (for Canada).

Activating audio AUX mode

WARNING

External audio sources may have different volumes, which can mean that system messages such as traffic announcements and navigation system announcements are much louder. If necessary, please deactivate the system messages or adjust their volume manually.

When you connect an external audio source, audio AUX is not selected automatically.

► Select **Audio** in the main function bar by sliding  and turning  the COMAND controller and press  to confirm. If AUX mode was the last mode selected, it will now be active.

If another audio source is switched on, you can now switch to audio AUX mode in the audio menu.

- ▶ Select **Audio** using \uparrow \odot and press \odot to confirm.
The audio menu appears.
- ▶ Select **Aux** using $\left[\odot \right]$ and press \odot to confirm.
The audio AUX menu appears. The medium in the external audio source is played if the source is connected and playback selected.



Please see the respective operating instructions for how to operate the external audio source.

Information on:

- Volume settings (▷ page 277)
- Sound settings (▷ page 278)

Increasing the volume on COMAND

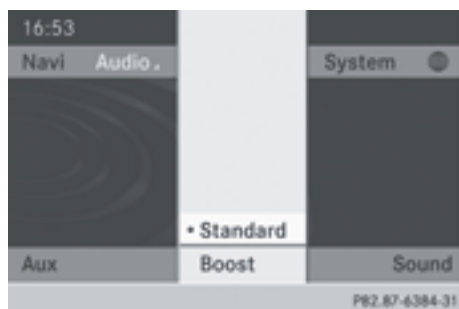

- ▶ Select **Volume** in the AUX display by turning $\left[\odot \right]$ the COMAND controller and press \odot to confirm.

A menu appears. The • dot indicates the current setting.

- ▶ Select **Standard** or **Boost** and press \odot to confirm.

Standard: the volume of the external audio source is adjusted to a standard value.

Boost: the volume of the external audio source is raised by approximately 10 dB.

A device which is connected as an external audio source may seem quieter or louder in the vehicle, or the usual maximum volume cannot be achieved. On some devices, it is possible to adjust the volume separately. In this case, start at a medium volume and increase it gradually. This enables you to determine whether the system is able to play the music at high volume without distorting it.

Video

General information

Automatic picture shutoff







The video image is shown only when the transmission selector lever is in position **P**.

If the transmission selector lever is moved out of position **P**, the **In order not to distract you from the traffic situation, the picture is faded out while the vehicle is in motion** message appears







As soon as the selector lever of the transmission is returned to position **P**, the video image is shown.

Basic settings

Adjusting the brightness, contrast or color

- ▶ In DVD video or video AUX mode, press  the COMAND controller and show the menu.
- ▶ Select **DVD-Video** by sliding  and turning  the COMAND controller and press  to confirm.
A menu appears.
- ▶ Select **Brightness, Contrast** or **Color** by turning  the COMAND controller and press  to confirm.

Changing the picture format

- ▶ Press  the COMAND controller to show the menu.
- ▶ Select **DVD-Video** by sliding  and  turning the COMAND controller and press  to confirm.
A menu appears.
- ▶ Select **16:9 Optimized, 4:3** or **Widescreen** and press  to confirm.
The dot in front of the entry indicates the currently selected format.
- ▶ Select a setting by turning  the COMAND controller and press  to confirm.

Video DVD mode

Safety notes

WARNING

COMAND is classified as a Class 1 laser product. Never open the housing. There is a risk of damage to the eyes due to exposure to invisible laser radiation if you open the casing, or if the casing is faulty or damaged.

COMAND does not contain any parts that can be serviced by the user. For safety reasons,

all maintenance work must be carried out by qualified aftersales technicians.

WARNING

Only when the vehicle is stationary should you:

- load a disc
- eject a disc

There is a risk of being distracted from the road and traffic conditions if this is done while the vehicle is in motion.

Notes on discs

 Do not affix stickers or labels to the discs. They could peel off and damage COMAND. Stickers can cause the disc to bend, which can result in read errors and disc recognition problems.

 COMAND is designed to play discs that comply with the EN 60908 standard. Therefore, you can only use discs with a maximum thickness of 1.3 mm.

If you insert thicker discs, e.g. those that contain data on both sides (DVD on one side and audio data on the other), they cannot be ejected and can damage the device.

Only use round discs with a diameter of 12 cm. Do not use discs with a diameter of 8 cm, even with an adapter.

Playback problems may occur when playing copied discs. There are a large variety of discs, DVD authoring software, writing software and writers available. This variety means that there is no guarantee that the system will be able to play discs that you have copied yourself.

DVD playback conditions

If video DVDs do not conform to the NTSC or PAL TV standards, they may create picture, sound or other problems during playback.

COMAND is capable of playing back video DVDs produced according to the following standards:

- region code 1 or region code 0 (no region code)
- PAL or NTSC standard

You will generally find the relevant details either on the DVD itself or on the DVD case.

- i** If you insert a video DVD with a different region code, you will see a message to this effect.
- i** COMAND is set to region code 1 at the factory. This setting can be changed at an authorized Mercedes-Benz Center. This will allow you to play video DVDs with a different region code, provided that they are produced in accordance with the PAL or NTSC standard. The region code can be changed up to five times.

Function restrictions

Depending on the DVD, it is possible that certain functions or actions will be temporarily blocked or may not function at all. As soon as you try to activate these functions or actions, you will see the  symbol in the display.

Inserting and removing DVDs

- ▶ Proceed as described in the "Inserting and ejecting CDs and DVDs" section (▷ page 421).

Switching to video DVD mode

Option 1

- ▶ **Single DVD drive:** insert a video DVD. COMAND loads the medium inserted and starts to play it.

- ▶ **DVD changer:** insert a video DVD.

- ▶ Press .







or

- ▶ Press the  back button. COMAND loads the medium inserted and starts to play it.



Option 2

- ▶ Press the  function button one or more times. COMAND switches to the previous disc operating mode.

By pressing the function button repeatedly, you can change the operating mode in the following order:

- audio CD/DVD / video DVD/MP3 in the DVD changer or DVD single drive (disc mode)
- audio CD/DVD, video DVD or MP3 disc in the DVD changer
- memory card mode
- MUSIC REGISTER
- USB storage device
- Media Interface or audio AUX mode
- Bluetooth® audio mode
- ▶ **DVD changer:** select **Media** or **Changer** by sliding  and turning  the COMAND controller and press  to confirm.
- ▶ **Single DVD drive:** select **Media** by sliding  and turning  the COMAND controller and press  to confirm.
- ▶ Select a  video DVD from the media list (▷ page 456).

Option 3

- ▶ Select **Video** in the main function bar by sliding  and turning  the COMAND controller and press  to confirm. Video DVD mode is switched on.

Hiding/showing the navigation menu

This function is not available while the DVD's own menu (▷ page 457) is being displayed.

► **To show:** in DVD video mode, slide $\uparrow \odot \downarrow$ the COMAND controller.

► **To hide:** slide $\uparrow \odot \downarrow$ the COMAND controller.

or

► Wait for approximately eight seconds.



Navigation menu displayed

- ① Type of data medium
- ② Current title
- ③ Current scene
- ④ Track time
- ⑤ To show the menu

Showing/hiding the menu

This function is not available while the DVD's own menu (► page 457) is being displayed.

► **To show:** in full-screen DVD video mode, press \odot the COMAND controller.

or

► Select **Menu** while the navigation menu is shown and press \odot to confirm.

► **To hide:** slide $\uparrow \odot$ the COMAND controller and confirm **Full Screen** by pressing \odot .

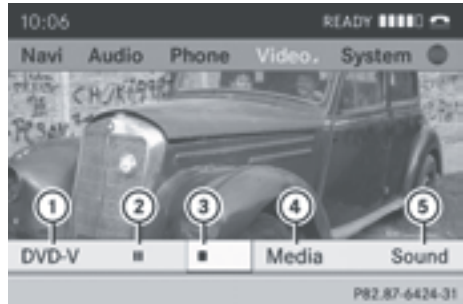

Menu shown

- ① Video DVD options
- ② Pause function
- ③ Stop function
- ④ Media selection
- ⑤ sound settings

Fast forwarding/rewinding

► In full-screen DVD video mode, slide $\leftarrow \odot \rightarrow$ and hold the COMAND controller until the desired position is reached.

or



► Press and hold the \lll or \ggg button until the desired position is reached. You see the navigation menu.

Stop function





► Show the menu (► page 455).

► **To interrupt playback:** select \blacksquare by turning $\uparrow \odot \downarrow$ the COMAND controller and press \odot to confirm. The \parallel display changes to \blacktriangleright . The video image is hidden.







► **To continue playback:** select \blacktriangleright and press \odot to confirm. Playback continues from the point where it was interrupted.

- ▶ **To stop playback:** while playback is interrupted, select  again and press  to confirm.

or

- ▶ During playback, confirm  by pressing  twice in rapid succession.  is selected.
- ▶ **To restart playback:** confirm  by pressing . Playback restarts from the beginning.





Pause function

- ▶ Show the menu (▷ page 455).
- ▶ **To pause playback:** select  by turning  the COMAND controller and press  to confirm. The  display changes to .
- ▶ **To continue playback:** select  and press  to confirm. The menu is hidden.

Selecting a scene/chapter

If the film is divided into scenes or chapters, you can select them directly while the film is running, or skip forwards step by step. Some DVDs do not permit this at certain points (e.g. during the opening credits).

It may also be possible to select the scene/chapter from within the menu stored on the DVD.

- ▶ **To skip forwards or back:** in full screen mode, turn  the COMAND controller or
- ▶ Slide  the COMAND controller or
- ▶ Press the  or  button on the control panel. The navigation menu (▷ page 454) appears for approximately eight seconds.

Selecting a film/title

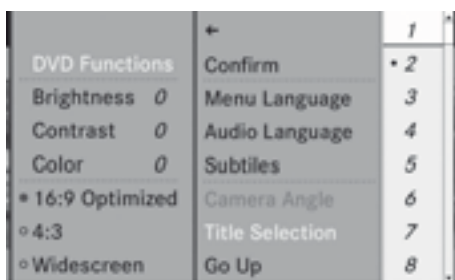







PH2.87-2181-31





DVD function menu



This function is only available if the DVD is divided into several films/titles. If the DVD contains several films, these can be selected directly. A film can be selected either when the DVD is being played back or when it is stopped.

The film can also be selected from the menu on the DVD itself.

- ▶ Show the menu (▷ page 455).
- ▶ Select **DVD-Video** by turning  the COMAND controller and press  to confirm.
- ▶ Select **DVD Functions** and press  to confirm. A menu appears.
- ▶ Select **Title Selection** by turning  the COMAND controller and press  to confirm.
- ▶ Select a film/title and press  to confirm.

Selecting a video DVD from the media list

- ▶ Show the menu (▷ page 455).
- ▶ Select **Changer** or **Media** by sliding  and turning  the COMAND controller and press  to confirm. The media list appears. The  dot indicates the current medium being played. Video DVDs are indicated by the  icon.





- ▶ **Equipped with a DVD changer:** press  the COMAND controller to display all magazine trays.
 - ▶ Select a video DVD by turning  the COMAND controller and press  to confirm. COMAND loads the video DVD and begins playing it.
- i** If you select a CD, an audio DVD or an MP3 medium, you switch to the respective audio mode. Further information about the media list on (▶ page 426).

DVD menu

Calling up the DVD menu

The DVD menu is the menu stored on the DVD itself. It is structured in various ways according to the individual DVD and permits certain actions and settings.



In the case of multi-language DVDs, for example, you can change the DVD language in the DVD menu.

- ▶ Show the menu (▶ page 455).
- ▶ Select **DVD-Video** in the menu by turning  the COMAND controller and press  to confirm.
- ▶ Select **DVD Functions** and press  to confirm.
- ▶ Select **Menu** and press  to confirm. The DVD menu appears.

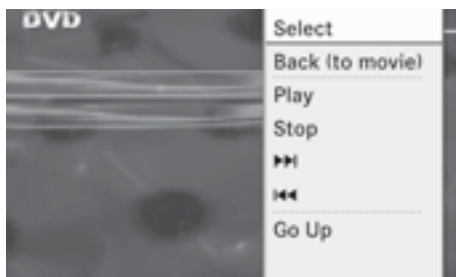

Selecting menu items in the DVD menu



P82.87-2182-31

- ▶ Show the DVD menu (▶ page 457).
- ▶ Select a menu item by sliding  the COMAND controller and press  to confirm.

or

- ▶ Select a menu item by sliding  the COMAND controller and press  to confirm. The menu appears.



- ▶ **To reconfirm your selection:** confirm **Select** by pressing .

COMAND carries out the action.

Make a selection from the further options, if necessary.

COMAND then switches back to the DVD menu.



- i** Menu items which cannot be selected are shown in gray.

- i** Depending on the DVD, the menu items: **Back (to movie)**, **Play**, **Stop**, ,  or **Go Up** may either not function at all or may not function at certain points in the DVD menu. To indicate this, the  symbol appears in the display.

Moving up one level in the DVD menu

- ▶ Show the DVD menu (▶ page 457).
- ▶ Select the corresponding menu item in the DVD menu and press  the COMAND controller to confirm.

or

- ▶ Select any menu item in the DVD menu and press  the COMAND controller to confirm.
- ▶ Select **Go Up** and press  to confirm.

Back to the film

- ▶ Press the  back button repeatedly until you see the movie.









or

- ▶ Select the corresponding menu item from the DVD menu.

- ▶ Select the **Back (to movie)** menu item in the menu and press  to confirm.



Setting the language and audio format





This function is not available on all DVDs. If it is available, you can set the DVD menu language, the audio language or the audio format. The number of settings is determined by the DVD content. It is possible that the settings may also be accessed in the DVD menu (▶ page 457).

- ▶ Show the DVD menu (▶ page 457).
- ▶ In full-screen mode, press  the COMAND controller to show the menu.
- ▶ Select **DVD-Video** in the menu by turning  the COMAND controller and press  to confirm.
- ▶ Select **DVD Functions** and press  to confirm.
- ▶ Select **Menu Language** or **Audio Language** and press  to confirm.
In both cases, a menu appears after a few seconds. The  dot in front of an entry indicates the currently selected language.
- ▶ Select a setting by turning  the COMAND controller and press  to confirm.

Subtitles and camera angle





These functions are not available on all DVDs. The number of subtitle languages and camera angles available depends on the content of the DVD. It is possible that the settings may also be accessed in the DVD menu (▶ page 457).

- ▶ Activate the DVD menu (▶ page 457).
- ▶ Select **DVD-Video** in the menu by turning  the COMAND controller and press  to confirm.
- ▶ Select **DVD Functions** and press  to confirm.

- ▶ Select **Subtitles** or **Camera Angle** and press  to confirm.
In both cases, a menu appears. The  dot in front of an entry indicates the current setting.
- ▶ Select a setting by turning  the COMAND controller and press  to confirm.

Interactive content

DVDs can contain interactive content (e.g. a video game). In a video game, for example, you may be able to influence events by selecting and triggering actions. The type and number of actions depend on the DVD.

- ▶ Select an action by sliding  or  the COMAND controller and press  to execute it.
A menu appears and the first entry, **Select**, is highlighted.
- ▶ Press  the COMAND controller.

AUX video mode

Connecting external video sources

WARNING

External video sources may have different volumes, which can mean that system messages such as traffic announcements and navigation system announcements are much louder. If necessary, please deactivate the system messages or adjust their volume manually.

If your vehicle is equipped with Media Interface, you can connect an external video source (AUX video) (▶ page 445).

The 1/8 inch audio/video jacks are in the center console stowage compartment.

-  In vehicles with a rear view camera, the AUX video jack cannot be used for external video sources.

Switching to AUX video mode



AUX video mode

- ▶ Press the **DISC** function button repeatedly until Media Interface mode is selected.

or

- ▶ Select **Video** in the main function bar by sliding **↑** and turning **⌂** the COMAND controller and press **⏵** to confirm.

If AUX video mode was the last mode selected, it will now be active.

If another video source is switched on, you can now switch to AUX video mode in the video menu.

- ▶ Select **Video** and press **⏵** to confirm.
- ▶ Select **Aux** and press **⏵** to confirm. The AUX video menu appears. You will hear and see the content of the external video source if it is connected and switched to playback.

Showing/hiding the menu

- ▶ **To show:** in video AUX mode, press **⏵** the COMAND controller.
- ▶ **To hide:** slide **↑** the COMAND controller and confirm **Full Screen** by pressing **⏵**.

Volume and sound settings

Information on:

- volume settings (▷ page 277)
- sound settings (▷ page 278)

⚠ WARNING

External video sources may have different volumes, which can mean that system messages such as traffic announcements and navigation system announcements are much louder. If necessary, please deactivate the system messages or adjust their volume manually.

- ▶ **i** A device which is connected as an external video source may seem quieter or louder in the vehicle, or the usual maximum volume cannot be achieved. On some devices, it is possible to adjust the volume separately. In this case, start at a medium volume and increase it gradually. This enables you to determine whether the system is able to play the sound at high volume without distorting it.

Increasing the volume on COMAND

- ▶ Show the video AUX menu (▷ page 459).
- ▶ Select **Volume** by turning **⌂** the COMAND controller and press **⏵** to confirm. A menu appears. The **•** dot indicates the current setting.
- ▶ Select **Standard** or **Boost** and press **⏵** to confirm.
 - Standard:** the volume of the external video source is adjusted to a standard value.
 - Boost:** the volume of the external video source is raised by approximately 10 dB.

Picture viewer

Introduction

If there are pictures on the active data medium, you can look at them. You can display pictures with a resolution of up to 20 megapixels.

Data medium	Supported picture formats
CD/DVD with picture files	jpeg, jpg
USB devices (sticks, hard drives) SD memory card	jpeg, jpg

Calling up a category list

- ▶ Select a data medium with pictures (e.g. a memory card):
 - In the Audio menu (▷ page 411)
 - In the media list (▷ page 426)
- ▶ Select **Search** in the basic display by sliding $\odot \downarrow$ and turning $\left\{ \odot \right\}$ the COMAND controller and press \odot to confirm. The category list appears (▷ page 433).

Displaying pictures

- ▶ Select (▷ page 433) **Photos** in the category list by turning $\left\{ \odot \right\}$ the COMAND controller and press \odot to confirm. A folder directory appears.
- ▶ Select a folder with photos and press \odot to confirm. The folder displays the existing picture files (example).



- ▶ Select a photo and press \odot to confirm. The photo is displayed and the music is stopped.



Changing the picture view

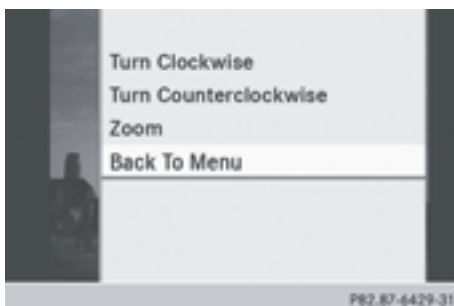



- ▶ While viewing a picture (▷ page 460), press \odot the COMAND controller. A menu appears.
 - ▶ **To turn the picture clockwise:** confirm **Turn Clockwise** by pressing \odot the COMAND controller.
 - ▶ **To turn the picture counter-clockwise:** select **Turn Counterclockwise** by turning the $\left\{ \odot \right\}$ COMAND controller and press \odot to confirm.
 - ▶ **To zoom into a picture:** select **Zoom** by turning the $\left\{ \odot \right\}$ COMAND controller and press \odot to confirm. After you have zoomed into the picture, you can move the section of the picture.
 - ▶ Slide $\uparrow \odot \downarrow$ or $\leftarrow \odot \rightarrow$ the COMAND controller.

▶ **To revert to the original size:** press  the COMAND controller.

or

▶ Press the  back button.



Exiting the picture viewer

▶ Select **Back To Menu** in the menu by turning  the COMAND controller and press  to confirm.



▶ **To start playing music:** confirm **Search** by pressing .

The category list appears (▷ page 433).

▶ Select a category by turning  the COMAND controller and press  to confirm.

▶ Select other entries within the category (e.g. track, album) until the music starts playing.

SIRIUS Weather

Introduction

 This function is currently not available for Canada.

For the reception of weather forecasts via satellite radio, you will need a SIRIUS XM Satellite Weather subscription.

When the **Call SIRIUS to activate system at 888-539-7474** message with the SIRIUS device identification number appears, you will first have to obtain access to the weather service. A description of the

procedure can be found in the "Registering satellite radio" section (▷ page 416).

COMAND can receive weather forecasts via satellite radio for the entire USA (including Alaska and Hawaii). The received weather data can be displayed as an information chart (daily forecast, five-day forecast, detailed information) or on the weather map.

The weather data received from a weather station is stored in COMAND for one hour. It can therefore be displayed again immediately after restarting the engine (for example after refueling).

The weather map can display the following weather data with symbols:

- rain radar
- storm characteristics
- areas of high-pressure/low-pressure, weather fronts
- course of tropical cyclones (hurricanes, typhoons)
- wind direction and speeds

 The rain radar cannot be displayed for Alaska, Hawaii and Puerto Rico.

 **Hurricane:** term used to describe the tropical cyclones that primarily develop in the Atlantic, North Pacific and South Pacific oceans. The wind speeds are above 74 mph (118 km/h). Five categories are used to classify the strength of a hurricane.

Typhoon: term used to describe a tropical cyclone that develops in the northwestern Pacific. The wind speeds are in the category of a hurricane.

Switching the SIRIUS weather display on/off

Activating

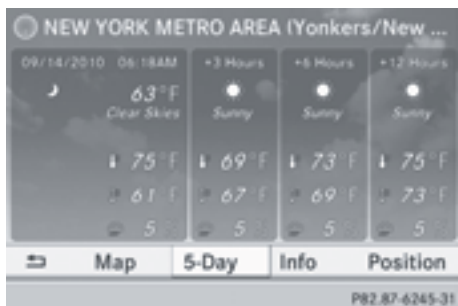

Example: daily forecast as an information chart

- ▶ Select the symbol in the main function bar by sliding and turning the COMAND controller and pressing to confirm. The SIRIUS weather basic display appears.
- ▶ Confirm **SIRIUS Weather** by pressing . The information chart shows the daily forecast at the current vehicle position.

You see the following information:

- the date and time of the weather message received last
- information on the current weather (temperature, cloud cover) and forecast for the next 3, 6, 12 hours
- the current highest temperature and forecasts
- the current lowest temperature and forecasts
- the probability of rain

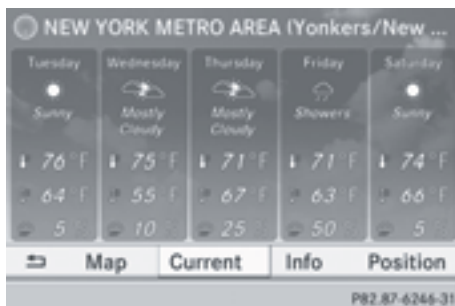

Example: five-day forecast as an information chart

- ▶ **To switch to the five-day forecast:** confirm **5-Day** by pressing .

The information chart displays the forecast for the next five days in the currently selected location.

- ▶ **To return to the daily forecast:** confirm **Current** by pressing .

Deactivating

- ▶ Press the back button.

or

- ▶ Select **Back** by turning the COMAND controller and confirm by pressing . Both options appear in the SIRIUS weather basic menu.

Displaying detailed information

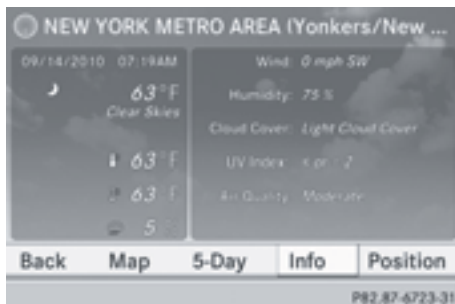

Besides the current temperatures, you can display information such as wind speeds and UV index.

- ▶ Select **Info** in the information chart by turning **[⊙]** the COMAND controller and press **[⏎]** to confirm.
The information chart shows detailed information for the selected location.

Selecting the location for the weather forecast

Introduction

You can select the following locations:

- the current vehicle position
- vicinity of the destination
- a winter sports area
- an area within the USA

You can select a location in the information chart (option 1), on the map (option 2) or from the memory. To select from the memory you must first save a location (> page 464).

- i** COMAND receives weather forecast data from the nearest weather station at the selected location.

Option 1: selecting the location in the information chart



"Selecting the location for the weather forecast" menu

- ▶ Select **Position** in the information chart by turning **[⊙]** the COMAND controller and press **[⏎]** to confirm.
A menu appears.
- ▶ **To select the current vehicle position:** select **Current Position** and press **[⏎]** to confirm.
COMAND receives the weather data for the current vehicle position from the nearest weather station and displays it automatically.
- ▶ **To select the vicinity of the destination:** select **Near Destination** in the menu by turning **[⊙]** the COMAND controller and press **[⏎]** to confirm.
- i** You can select **Near Destination** once a route has been calculated (> page 303). The menu item is otherwise grayed out.

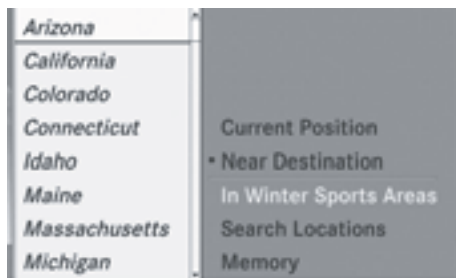



P82.87-6250-31

Selecting a state (searching for winter sport areas)



P82.87-6251-31

- ▶ **To select winter sport areas:** select **In Winter Sports Areas** in the menu, and confirm by pressing .
- ▶ Select a state, e.g. **Colorado**, and press  to confirm.
- ▶ Select a winter sports area from the menu and press  to confirm. The weather data and other information is displayed for the winter sports area that has been selected. The data is supplied by the nearest weather station.

The information chart shows the following information (if available):

- ski slopes/ski lifts
- snowboarding and nighttime opening
- snow conditions (e.g. snow depth)
- temperature



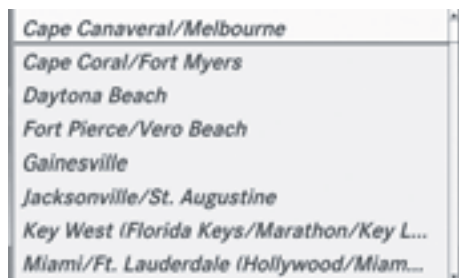

P82.87-6249-31

Selecting a state (searching for a location)



P82.87-6249-31

- ▶ **To search for a location:** select a state, e.g. **Florida** and press .

- ▶ Select a category, e.g. **Daytona Beach**, and press  to confirm. The information chart shows the weather forecast for the selected location. The data is supplied by the nearest weather station.







Option 2: selecting the location in the weather map

- ▶ Call up the weather map (▷ page 465).
- ▶ Move the weather map so that the crosshair is over the desired area (▷ page 465).
- ▶ Press  the COMAND controller. The information chart shows the weather forecast for the selected area. The data is supplied by the nearest weather station.

Memory functions

Storing the location in the weather memory

For areas that are frequently called up, 10 presets (0, 1 – 9) are available in the weather memory.

- ▶ **In the weather memory:** select the location for the weather forecast (▷ page 463). The selected area is shown at the top in the status bar.
- ▶ Select **Position** in the information chart by turning  the COMAND controller and press .
- ▶ Select **Memory** and press .
- ▶ Select the preset by turning  or sliding  the COMAND controller.
- ▶ Press and hold  the COMAND controller until you hear a tone. The area is entered on the selected preset.

- ▶ **To store rapidly:** in the daily forecast (▷ page 462) press and hold a number key, e.g. , until the preset position number

is shown in the status bar in front of the area name.

- i** You can also use this function in the five-day forecast (▷ page 462), and in the detailed information view (▷ page 462).

Selecting a location from the weather memory

- ▶ **From the weather memory:** in the information chart, select **Position** by turning **⏮** the COMAND controller and press **⏹** to confirm.
- ▶ Select **Memory** and press **⏹** to confirm.
- ▶ Select a preset that contains an entry by turning **⏮** or sliding **⏮** the COMAND controller and press **⏹** to confirm. The weather data for the selected area is displayed.
- ▶ **Rapid selection:** if there is an entry available in the weather memory, e.g. when the daily forecast is shown, briefly press a number key, such as **2** **ABC**. The weather data for the selected location is displayed.

Weather map

Calling up the weather map



Example: weather map

- ▶ Select **Map** in the information chart by turning **⏮** the COMAND controller and press **⏹** to confirm. The weather map is shown on a 500-mi (500-km) scale.

- i** For the map display, you can activate the topographic map style (▷ page 347).

Moving the weather map

- ▶ Slide **←→**, **↑↓** or **↻** the COMAND controller. The weather map moves in the corresponding direction under the crosshair.



Changing the scale





- ▶ As soon as you turn **⏮** the COMAND controller, you see the scale bar.
- ▶ Turn **⏮** until the desired scale is set.

Showing/hiding the menu in the weather map



- ▶ **To show:** press  the COMAND controller in the weather map.
- ▶ **To hide:** slide up  the COMAND controller.



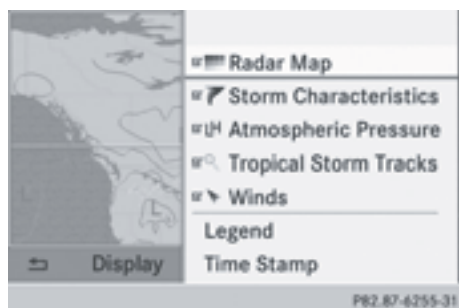

Selecting a weather station in the map

- ▶ Move the weather map and crosshair to the desired position (▷ page 465).
- ▶ Press  the COMAND controller. The menu is shown.
- ▶ Confirm **Display Weather** by pressing . COMAND receives the weather data for the selected position from the nearest weather station and displays it automatically as a daily forecast.

Switching layers on the map on/off



You can switch on different layers, for example to display the rain radar, weather fronts and the course of tropical storms on the map.

- ▶ Display the menu on the weather map (▷ page 465).
- ▶ Select **Map Options** by turning  the COMAND controller and pressing  to confirm. A menu appears.
- ▶ Select the layer by turning  and sliding  the COMAND controller and press  to confirm. Switch the display on or off .

Explanation of the layers on the weather map

Layer	Map display	Selectable scales
Radar Map	Shows the rain radar as a colored area on the map. For an explanation of the colors, see the legend (▷ page 470).	All
Storm Characteristics	Shows the characteristics of a storm Characteristics are: <ul style="list-style-type: none"> • tornadic storm: storm cell with strong winds (super cell), from which a tornado can develop. Tornadoes are also known as twisters. • cyclone: storm cells from which a tornadic storm can develop • hailstorm • the likelihood of a hailstorm 	All
Atmospheric Pressure	Shows the position of high and low-pressure areas (H, L), weather fronts and isobars	200 mi (200 km) 500 mi (500 km)
Tropical Storm Tracks	Shows the path/directional movement speed of a tropical storm with time and strength information	All
Winds	Shows the wind direction and wind speed	5 mi (5 km)

Sample displays of weather data in the map



Weather map showing the rain radar

Conditions: the **Radar Map** layer is active (▷ page 466) and weather data is available.

The precipitation radar legend can be called up at (▷ page 470).



Displaying storm characteristics

Conditions: the **Storm Characteristics** layer is active (▷ page 466) and weather data is available.

In the example, the weather map shows a hailstorm and tornadic storms with the path and directional movement speed.

The storms legend can be called up (▷ page 470).

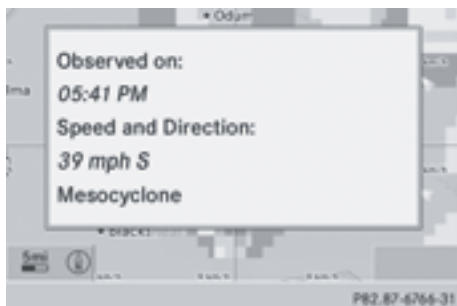

Example: weather map with information on a cyclone

- ▶ Slide ←⊙→, ↑⊙↓ or ↻⊙↻ the COMAND controller and move the crosshair onto a corresponding symbol.
- ▶ Press ⊕ the COMAND controller.

The following information is shown (if available):

- characteristics of the storm cell
- date and time of observation (time stamp)
- directional movement speed and path

- ① The directional movement speed is the speed at which the storm cell moves.



Example: weather map showing weather fronts

Conditions: the **Atmospheric Pressure** layer is switched on (▷ page 466) and weather data is available.

The example shows the position of high and low-pressure areas (H, L), weather fronts and isobars.

- ① Isobars are lines that show where the air pressure is the same.

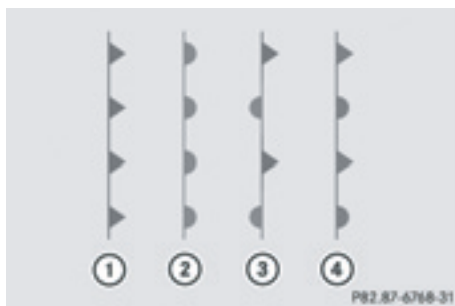

Legend: weather fronts

- ① Cold front (blue line with blue triangles)
- ② Warm front (red line with red semi-circles)
- ③ Stationary front (red-blue line with red semi-circles and blue triangles)
- ④ Occlusion (violet line with a violet semi-circle and triangles)

Weather front	Explanation
Cold front	If a cold front moves in, the weather remains changeable and there are often rain showers and thunderstorms. The air temperature decreases.
Warm front	This can mean longer periods of rain and can lead to an increase in cloud cover and a slow increase in temperature.

Weather front	Explanation
Stationary front	The weather front moves minimally. The weather remains changeable in this area.
Occlusion	This occurs when a faster cold front reaches an advancing warm front and combines with it. The weather remains changeable and rainy within an occlusion.



Example: weather map showing the progress of a tropical storm

- ① Position on the forecast path
- ② Current position of the cyclone
- ③ Position on the previous path

Conditions: the [Tropical Storm Tracks](#) layer is switched on (> page 466) and weather data is available.

A dotted line shows the previous path and the forecast path of a tropical low-pressure area (cyclone).

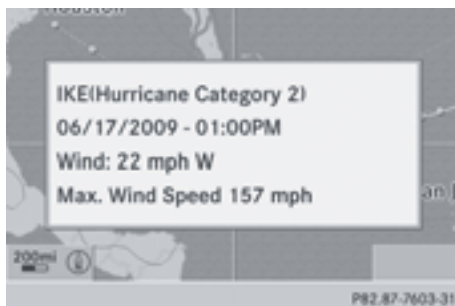

Information on a cyclone

You can select individual points (①, ② and ③) on the path and display further information on them.

- ▶ In the map, slide ←⊙→, ↑⊙↓ or ↻⊙↻ the COMAND controller and slide the crosshair to ①, ② or ③.
- ▶ Press ⊙ the COMAND controller.

Showing information (if available):

- name of the tropical storm and category
- time stamp
- directional movement speed and path ([Wind](#))
- maximum wind speed ([Max. Wind Speed](#))
- ❗ The directional movement speed is the speed at which the storm cell of a tropical storm moves.

A tropical storm is separated into different categories according to the location at which it develops.

Region of origin	Category
Atlantic, North and South Pacific Oceans	Tropical Low Pressure System
Atlantic, North and South Pacific Oceans	Tropical Rain Zone
Atlantic, North and South Pacific Oceans	Tropical Storm

Region of origin	Category
Atlantic, North and South Pacific Oceans	Hurricane Category 1 to Hurricane Category 5
Northwestern Pacific Ocean	Tropical Low Pressure System
Northwestern Pacific Ocean	Tropical Cyclone
Northwestern Pacific Ocean	Typhoon
Northwestern Pacific Ocean	Super-Typhoon



You can also see the time stamp for the weather data on map scales of 50 mi and smaller.

The weather map shows wind directions and wind speeds.

Legend (precipitation radar and storms)

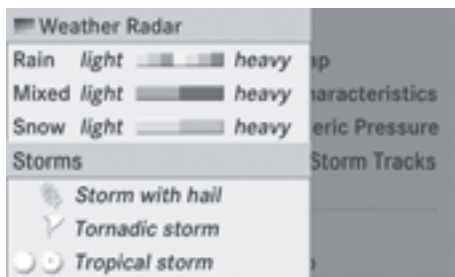

P82.87-6258-31

- ▶ Display the menu on the weather map (▷ page 465).
- ▶ Select **Map Options** by turning the COMAND controller and pressing to confirm.
- ▶ Select **Legend** and press to confirm.
- i** The symbol for a tornadic storm is also valid for a cyclone (mesocyclone).

Precipitation type	Color scale
Rain	Seven color levels from light (light green) to heavy (red)
Mixed	Light (light violet) to heavy (violet)
Snow	Light (light turquoise) to heavy (turquoise)

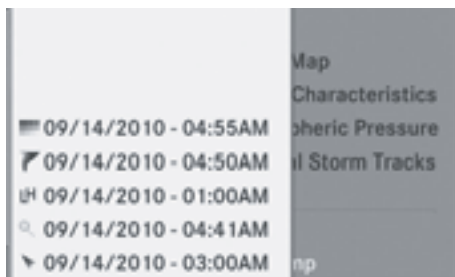

Time stamp



P82.87-6259-31

The time stamp shows when the weather data was created by the weather station.

A time stamp corresponds to the time at the vehicle's current position. The changeover from summer time to standard time is performed automatically.

- ▶ Display the menu on the weather map (▷ page 465).
- ▶ Select **Map Options** by turning  the COMAND controller and pressing  to confirm.
- ▶ Select **Time stamp** and press  to confirm.

Changing to the information chart

- ▶ Display the menu on the weather map (▷ page 465).
- ▶ Select **Display Weather** and press  to confirm.

Useful information	474
Stowage areas	474
Features	478

Useful information

- i** This Operator's Manual describes all models and all standard and optional equipment of your vehicle available at the time of publication of the Operator's Manual. Country-specific differences are possible. Please note that your vehicle may not be equipped with all features described. This also applies to safety-related systems and functions.
- i** Read the information on qualified specialist workshops: (> page 31).

Stowage areas

Stowage space

Important safety notes

WARNING

To help avoid personal injury during a collision or sudden maneuver, exercise care when storing objects in the vehicle. Put luggage or cargo in the trunk if possible.

Do not pile luggage or cargo higher than the seat backrests.

Keep compartment lids closed. This will help to prevent stored objects from being thrown about and injuring vehicle occupants during

- braking
- vehicle maneuvers
- an accident

Glove box



- ▶ **To open:** pull handle ① and open glove box flap ②.
- ▶ **To close:** fold glove box flap ② upwards until it engages.

- i** The glove box can be ventilated (> page 131).

In the glove box, there are a coin holder, a map holder and a pen holder.

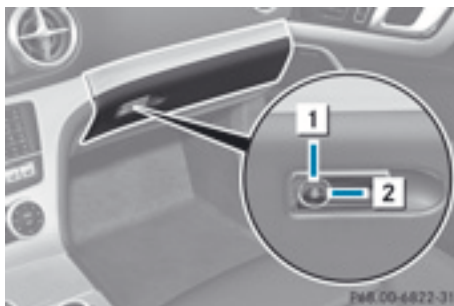

The glove box can be locked and unlocked using the mechanical key.

- ▶ **To lock:** insert the mechanical key into the lock and turn it to position ②.
- ▶ **To unlock:** insert the mechanical key into the lock and turn it to position ①.

Stowage compartment/telephone compartment under the armrest

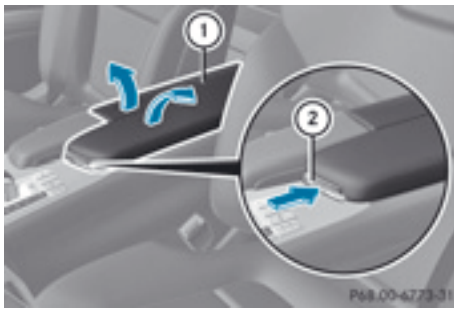

- ▶ **To open:** press button (2).
Armrest (1) opens.

In the stowage compartment, there is a stowage tray.

- ▶ **1** Depending on the vehicle's equipment, a 12 V socket, a USB port, and an AUX-IN connection or a Media Interface are installed in the stowage compartment. A Media Interface is a universal interface for mobile audio equipment, e.g. for an iPod® or MP3 Player (> page 445).

Eyeglasses compartment



- ▶ **To open:** press marking (1).
Eyeglasses compartment (2) opens.

Stowage compartment in the center console



- ▶ **To open:** press the trim element on cover (1).
- ▶ **To remove the rubber mat:** grasp the tabs on the rubber mat and pull up to remove.
- ▶ **To insert the rubber mat:** press the rubber mat into the housing.
- ▶ **To close:** swing cover (1) downwards until it engages.

You can remove the rubber mat from the stowage compartment to clean it. Clean with clear, lukewarm water only.

Depending on the vehicle's equipment, there are a cup holder and an ashtray in the center console stowage compartment.

Umbrella holder



Example: vehicle side, left

There are umbrella holders in the door stowage compartments on both sides of the vehicle. One compact umbrella can be stowed per side.

- ▶ **To remove:** grab strap ② and pull umbrella holder ① out of the stowage compartment in the direction of the arrow.
- ▶ **To insert:** push umbrella holder ① in the opposite direction from the arrow, into the stowage compartment, until it engages.

You can remove the umbrella holder to clean it. Clean with clear, lukewarm water only.

Stowage compartment in the rear center console



- ▶ **To open:** slide cover ① in the direction of the arrow.

On vehicles equipped with a bottle holder, the bottle holder is located in the stowage compartment (▷ page 479).

Stowage compartment in the rear

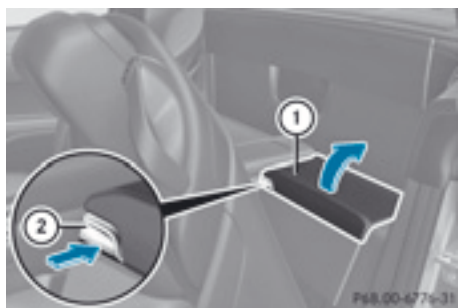

There is a stowage compartment in the rear on the left-hand side only.

- ▶ Open the seat belt guide and remove the seat belt (▷ page 99).
- ▶ Move the left-hand front seat forwards (▷ page 99) and fold the backrest forwards.
- ▶ **To open:** press release button ②. Cover ① folds upwards.
- ▶ **To close:** fold down cover ① and let it engage.
- ▶ Fold the backrest of the left-hand front seat back and move the seat backwards (▷ page 99).
- ▶ Route the seat belt back through the seat belt guide.

Stowage net

⚠ WARNING

Stowage nets are only intended for transporting light loads such as road maps, mail, etc.

Do not use stowage nets to transport heavy, bulky, sharp-edged or fragile objects. In an accident, during hard braking or during a change of direction, they could be thrown around inside the vehicle and cause injury to vehicle occupants.

Stowage nets cannot protect the transported loads in the event of an accident.



There is a stowage net ① in the front-passenger footwell.

Loading aid in the trunk

Raising/lowering the roof

WARNING

To prevent injuries, make sure that there is no possibility of body parts getting caught in moving parts. If potential danger exists, press the switch again. This will immediately stop the movement of the hardtop.

- ❗ Only close the trunk once the roof is lowered completely. Otherwise, you could damage the roof.

If you close the trunk lid before the roof is lowered completely, the loading aid switch lights up and a warning tone sounds.

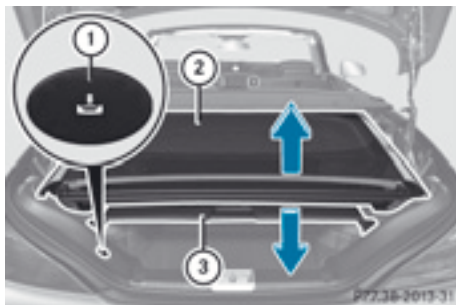

To make it easier to load your luggage, you can raise the stowed roof after you have opened the trunk lid.

You can only raise roof ② if trunk partition ③ is closed and the trunk lid is opened completely.

- ▶ **To raise the roof:** press switch ①. The roof is raised slightly. Switch ① lights up brightly.
- ▶ Slide trunk partition ③ back (▷ page 89).

You can only lower roof ② if trunk partition ③ is closed and the trunk lid is opened completely.

- ▶ **To lower the roof:** close the trunk partition (▷ page 89).
- ▶ Press switch ①. The roof is lowered slightly. Switch ① lights up dimly.

Problems with the loading aid

Problem	Possible causes/consequences and ► Solutions
It is no longer possible to lower the stowed roof in the trunk using the loading aid.	You cannot close the trunk any more. ► Call a qualified specialist workshop.

Stowage well under the trunk floor



- **To open:** open trunk partition ③ (► page 89).
- Swing trunk floor ④ up by loop ②.
- Pull hook with Velcro attachment ① off the underside of trunk floor ④.
- Attach hook with Velcro attachment ① to trunk partition ③ by its handle.

The TIREFIT kit, tire-change tool kit, etc. are located in the stowage compartment.

Features

Cup holders

Important safety notes

WARNING

In order to help prevent spilling liquids on vehicle occupants and/or vehicle equipment, only use containers that fit into the cup holder. Use lids on open containers and do not fill containers to a height where the contents, especially hot liquids, could spill

during braking, vehicle maneuvers, or in an accident. Liquids spilled on vehicle occupants may cause serious personal injury. Liquids spilled on vehicle equipment may cause damage not covered by the Mercedes-Benz Limited Warranty.

When not in use, keep the cup holder closed. An open cup holder may cause injury to you or others when contacted during braking, vehicle maneuvers, or in an accident.

Keep in mind that objects placed in the cup holder may come loose during braking, vehicle maneuvers, or in an accident and be thrown around in the vehicle interior. Objects thrown around in the vehicle interior may cause an accident and/or serious personal injury.

Cup holder in the center console

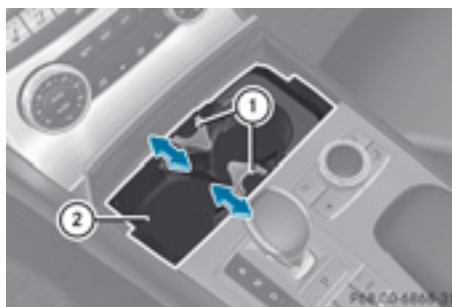

- **To open:** open stowage compartment ② (► page 475).
- **To remove the insert:** slide catches ① inwards in the direction of the arrow.
- Remove the cup holder insert upwards.

- ▶ **To re-install the insert:** place the insert in stowage compartment ②.
- ▶ Slide catches ① outwards in the direction of the arrow until they engage.

You can remove the cup holder's rubber mat for cleaning. Clean with clear, lukewarm water only.

Bottle holder

WARNING

Do not transport heavy, sharp-edged, or fragile bottles in the bottle holder.

In the event of an accident, the bottle holder cannot secure a bottle sufficiently. You and/or vehicle occupants could be injured.



- ▶ **To open:** open the stowage compartment (▶ page 476).
- ▶ **To remove the insert:** slide catches ① inwards in the direction of the arrow.
- ▶ Lift bottle holder insert ② up and remove.
- ▶ **To re-install the insert:** place insert ② in the stowage compartment.
- ▶ Slide catches ① outwards in the direction of the arrow until they engage.

The bottle holder does not secure the bottles; it merely prevents them from tipping over.

Sun visors

Overview

WARNING

Do not use the vanity mirror while driving. Keep the vanity mirrors in the sun visors closed while the vehicle is in motion. Reflected glare can endanger you and others.

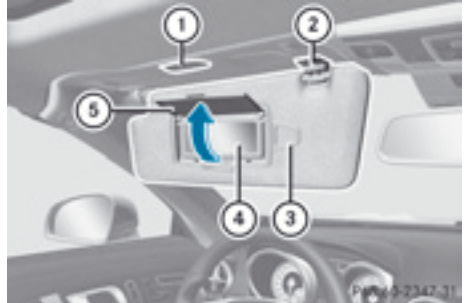

- ① Mirror light
- ② Bracket
- ③ Retaining strip, e.g. for a parking lot ticket
- ④ Vanity mirror
- ⑤ Mirror cover

Vanity mirror in the sun visor

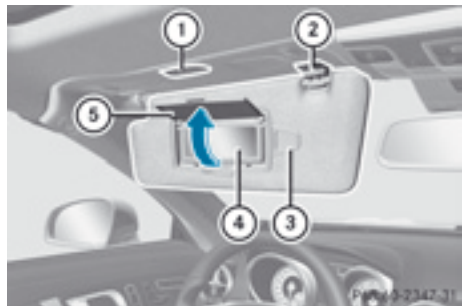

Mirror light ① only functions if the sun visor is clipped into retainer ② and mirror cover ⑤ has been folded up.

Glare from the side

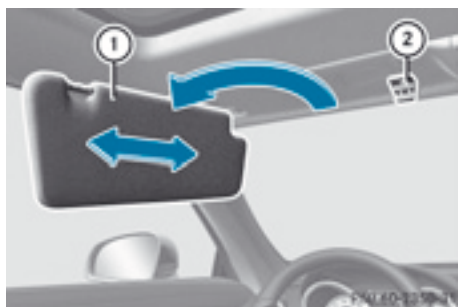

- ▶ Fold down sun visor ①.
- ▶ Pull sun visor ① out of retainer ②.
- ▶ Swing sun visor ① to the side.
- ▶ Slide sun visor ① forwards and back as required.

Ashtray



- ▶ **To open:** open stowage compartment ① (▷ page 475).
 - ▶ **To remove the insert:** pull insert ② up in the direction of the arrow, out of the cup holder.
 - ▶ **To replace the insert:** push insert ① on the left-hand side into the cup holder.
- i** Only install insert ① on the left-hand side of the cup holder.

Cigarette lighter

⚠ WARNING

Never touch the heating element or sides of the lighter; they are extremely hot. Hold the knob only.

Make sure any children traveling with you do not injure themselves or start a fire with the hot cigarette lighter.

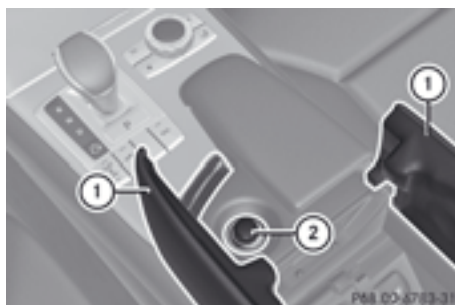

- ▶ Turn the SmartKey to position 2 in the ignition lock.
- ▶ **To open:** open stowage compartment ① under the armrest (▷ page 475).
- ▶ Press in cigarette lighter ②. Cigarette lighter ② will pop out automatically when the heating element is red-hot.

12 V sockets

General notes

You can use the sockets for accessories with a maximum power consumption of 180 W (15 A). Accessories include such items as lamps or chargers for mobile phones.

- ▶ Turn the SmartKey to position 1 in the ignition lock.

If you use the sockets for long periods when the engine is switched off, the battery may discharge.

- i** An emergency cut-out ensures that the on-board voltage does not drop too low. If the on-board voltage is too low, the power

to the sockets is automatically cut. This ensures that there is sufficient power to start the engine.

Socket in the front-passenger footwell



- ▶ Lift up the cover of socket ①.

Socket under the armrest



- ▶ Open the stowage compartment under armrest ① (▶ page 475).
- ▶ Lift up the cover of socket ②.

Socket in the trunk



- ▶ Lift up the cover of socket ①.

Floor mats

⚠ WARNING

Whenever you are using a floor mat, make sure there is enough clearance and that the floor mat is securely fastened.

The floor mat should always be securely fastened using the fastening equipment.

Before driving off, check that the floor mat is securely in place and adjust it if necessary. A loose floor mat could slip and hinder proper functioning of the pedals.

Do not place several floor mats on top of each other as this may impair pedal movement.

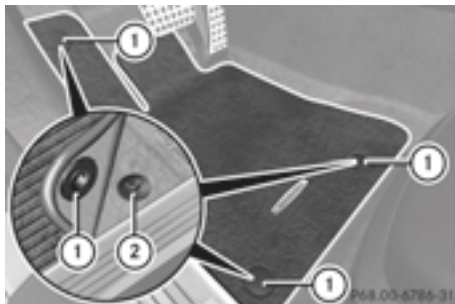

Example: floor mat, driver's side

- ▶ Slide the seat backwards.
- ▶ **To install:** place the floor mat in the footwell.
- ▶ Press studs ① onto retainers ②.
- ▶ **To remove:** pull the floor mat off retainers ②.
- ▶ Remove the floor mat.

Garage door opener

Important safety notes

⚠ WARNING

Before programming the integrated remote control to a garage door opener or gate

operator, make sure people and objects are out of the way of the device to prevent potential harm or damage. When programming a garage door opener, the door moves up or down. When programming a gate operator, the gate opens or closes.

Do not use the integrated remote control with any garage door opener that lacks safety stop and reverse features as required by U.S. federal safety standards (this includes any garage door opener model manufactured before April 1, 1982). A garage door that cannot detect an object - signaling the door to stop and reverse - does not meet current U.S. federal safety standards.

When programming a garage door opener, park vehicle outside the garage.

Do not run the engine while programming the integrated remote control. Inhalation of exhaust gas is hazardous to your health. All exhaust gas contains carbon monoxide (CO), and inhaling it can cause unconsciousness and possible death. All exhaust gas contains carbon monoxide (CO), and inhaling it can cause unconsciousness and possible death.

The HomeLink® garage door opener integrated in the rear-view mirror allows you to operate up to three different door and gate systems.

i Certain garage door drives are incompatible with the integrated garage door opener. If you experience difficulties programming the integrated garage door opener, contact an authorized Mercedes-Benz Center.

Alternatively, you can call the following telephone assistance services:

- **USA:** Mercedes-Benz Customer Assistance Center at 1-800-FOR-MERCEdes
- **Canada:** Customer Service at 1-800-387-0100

i USA only:

This device complies with part 15 of the FCC Rules. Operation is subject to the following two conditions:

1. This device may not cause harmful interference, and
2. this device must accept any interference received, including interference that may cause undesired operation.

Any unauthorized modification to this device could void the user's authority to operate the equipment.

FCC ID: CB2HMIHL4

i Canada only:

This device complies with RSS-210 of Industry Canada. Operation is subject to the following two conditions:

1. This device may not cause harmful interference, and
2. this device must accept any interference received, including interference that may cause undesired operation of the device.

Any unauthorized modification to this device could void the user's authority to operate the equipment.

IC: 279B-HMIHL4

Programming

Programming buttons

WARNING

Only press the button on the integrated garage door opener if there are no persons or objects present within the sweep of the garage door. Persons could otherwise be injured as the door moves.

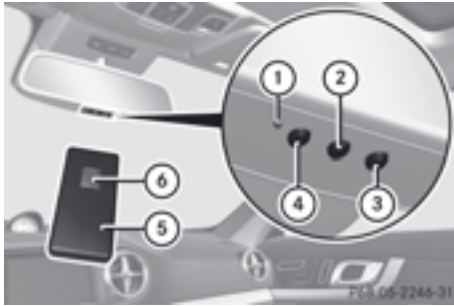

Integrated garage door opener on the rear-view mirror

Garage door remote control ⑤ is not part of the integrated garage door opener.

- ▶ Before programming for the first time, clear the memory of the integrated garage door opener (▷ page 485).
- ▶ Turn the SmartKey to position **2** in the ignition lock.
- ▶ Press and hold one of the buttons ② to ④ on the integrated garage door opener.

After a short time, indicator lamp ① starts flashing yellow.

- ① Indicator lamp ① flashes yellow immediately the first time button ②, ③ or ④ is programmed. If the selected button has already been programmed, indicator lamp ① will only start flashing yellow at a rate of once a second after ten seconds have elapsed.
- ▶ Release button ②, ③ or ④.
- ▶ Point garage door remote control ⑤ towards buttons ② to ④ on the rear-view mirror at a distance of 2 to 8 inches (5 to 20 cm).
- ① The required distance between remote control ⑤ and the integrated garage door opener depends on the garage door drive system. Several attempts might be necessary. You should test every position for at least 25 seconds before trying another position.

- ▶ Press and hold button ⑥ on remote control ⑤ until indicator lamp ① lights up green. If indicator lamp ① lights up green or flashes, then programming has been successful.
- ▶ Release button ②, ③ or ④ on the integrated garage door opener and button ⑥ on garage door remote control ⑤.

If indicator lamp ① lights up red:

- ▶ Repeat the programming procedure for the corresponding button on the rear-view mirror. When doing so, vary the distance between remote control ⑤ and the rear-view mirror.

- ① If the indicator lamp flashes green after successful programming, the garage door system is operating on a rolling code. After programming, you must synchronize the garage door opener integrated in the rear-view mirror with the receiver of the garage door system.

Synchronizing the rolling code

Your vehicle must be within reach of the garage door or exterior gate drive. Make sure that neither your vehicle nor any persons/objects are present within the sweep of the door or gate.

Observe the safety notes when performing the rolling code synchronization (▷ page 481).

- ▶ Turn the SmartKey to position **2** in the ignition lock.
- ▶ Press the programming button of the door or gate drive (see the door or gate drive operating instructions, e.g. under "Programming of additional remote controls").

- i** Usually, you now have 30seconds to initiate the next step.
- ▶ Press previously programmed button ②, ③ or ④ of the integrated garage door opener until the door starts to move. The rolling code synchronization is then complete.

Notes on programming the remote control

Canadian radio frequency laws require a "break" (or interruption) of the transmission signals after broadcasting for a few seconds. Therefore, these signals may not last long enough for the integrated garage door opener. The signal is not recognized during programming. Comparable with Canadian law, some U.S. garage door openers are designed to "time-out" in the same manner.

Proceed as follows:

- if you live in Canada
- if you have difficulties programming the garage door opener (regardless of where you live) when using the programming steps
- ▶ Press and hold one of buttons ② to ④ on the integrated garage door opener. After a short time, indicator lamp ① starts flashing yellow.
- ▶ Release the button.
- ▶ Press button ⑥ of garage door remote control ⑤ for two seconds, then release it for two seconds.
- ▶ Press button ⑥ again for two seconds.
- ▶ Repeat this sequence on button ⑥ of remote control ⑤ until indicator lamp ① lights up green. If indicator lamp ① turns red, repeat the process.
- ▶ Continue with the other programming steps (see above).

Problems when programming

If you are experiencing problems programming the integrated garage door opener on the rear-view mirror, take note of the following instructions:

- Check the transmitter frequency of garage door drive remote control ⑤. This can usually be found on the back of the remote control.

The integrated garage door opener is compatible with devices that have units which operate in the frequency range of 280to 390MHz.

- Replace the batteries in garage door remote control ⑤. This increases the likelihood that garage door remote control ⑤ will transmit a strong and precise signal to the integrated garage door opener in the rear-view mirror.
- When programming, hold remote control ⑤ at varying distances and angles from the button that you are programming. Try various angles at a distance between 2and 12 inches (5to 30 cm) or at the same angle but at varying distances.
- If another remote control for the same garage door drive is available, repeat the same programming steps with this remote control. Before performing these steps, make sure that new batteries have been installed in garage door drive remote control ⑤.
- Note that some remote controls only transmit for a limited amount of time (the indicator lamp on the remote control goes out). Press button ⑥ on remote control ⑤ again before transmission ends.
- Align the antenna cable of the garage door opener unit. This can improve signal reception/transmission.

Opening/closing the garage door

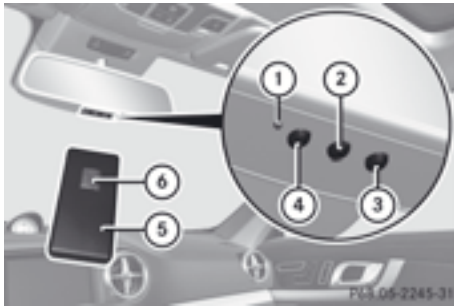

Integrated garage door opener on the rear-view mirror

After it has been programmed, the integrated garage door opener performs the function of the garage door system remote control. Please also read the operating instructions for the garage door system.

- ▶ Turn the SmartKey to position **2** in the ignition lock.
- ▶ Press one of the buttons **2**, **3** or **4**; whichever one is programmed to operate the garage door.

Garage door system with a fixed code: indicator lamp **1** lights up green.

Garage door system with a rolling code: indicator lamp **1** flashes green.

- i** The transmitter will transmit a signal for as long as the button is pressed. The transmission is halted after a maximum of ten seconds and indicator lamp **1** flashes yellow. Press button **2**, **3** or **4** again if necessary.

Clearing the memory

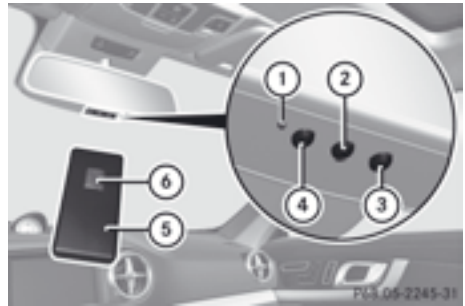

Integrated garage door opener on the rear-view mirror

- ▶ Turn the SmartKey to position **2** in the ignition lock.
- ▶ Press buttons **2** and **4**. The indicator lamp lights up yellow.
- ▶ Press and hold buttons **2** and **4** until the indicator lamp turns green.

- i** Make sure that you clear the memory of the integrated garage door opener before selling the vehicle.

mbrace

Important safety notes

- !** A license agreement must exist in order to activate the mbrace service. Ensure that your system is activated and ready for use, and press the  MB Info call button to register. If any of the steps mentioned is not carried out, the system may not be activated.

If you have questions about the activation, contact one of the following telephone assistance services:

- **USA:** Mercedes-Benz Customer Assistance Center under 1-800-FOR-MERCEdes (1-800-367-6372) or 1-888-990-9007
- **Canada:** Customer Service at 1-888-923-8367

Shortly after successfully registering with the mbrace service, a user ID and password will be sent to you by mail. USA only: you can use this password to log onto the mbrace area under "Owners Online" at <http://www.mbusa.com>.



The mbrace system is available if:

- it has been activated and is operational.
- the corresponding mobile phone network is available for transmitting data to the Customer Assistance Center.
- a service subscription is available.
- the starter battery is sufficiently charged.

- **i** Determining the location of the vehicle on a map is only possible if:
 - GPS reception is available
 - the vehicle position can be forwarded to the Customer Assistance Center.

The mbrace system

To adjust the volume during an mbrace call, proceed as follows:

- ▶ Press the  or  button on the multifunction steering wheel.

or

- ▶ Use the volume controller of COMAND.

The mbrace system provides various services, e.g.:





- automatic and manual emergency call
- Roadside Assistance call
- MB Info call

USA only: you can find information and a description of all available features under "Owners Online" at <http://www.mbusa.com>.

System self-test

WARNING

A malfunction in the system has been detected if one of the following conditions occurs:

- the indicator lamp in the SOS button does not light up during the system self-diagnosis.
- the indicator lamp in the  Roadside Assistance button does not light up during the system self-diagnosis.
- the indicator lamp in the  information button does not light up during self-diagnosis of the system.
- the indicator lamp in the SOS button, the  Roadside Assistance button or the  information button continues to light up red after the system self-diagnosis.
- The **mbrace Inoperative** or **mbrace Service Not Activated** message appears in the multifunction display after the system self-diagnosis.

If a malfunction is indicated as outlined above, the system may not operate as expected. In the event of an emergency, assistance must be summoned by other means.

Have the system checked at the nearest authorized Mercedes-Benz Center or contact the following service hotlines:

- **USA:** Mercedes-Benz Customer Assistance center at
1-800-FOR-MERcedes (1-800-367-6372)
or 1-888-990-9007
- **Canada:** Customer Service at
1-888-923-8367

After you have switched on the ignition, the system carries out a self-diagnosis.

Emergency call

Important safety notes

WARNING

If the indicator lamp in the SOS button is flashing continuously and no voice connection with the Response center has been established, then the mbrace system has not been able to initiate an emergency call (e.g. the relevant mobile phone network is not available).

The **Call Failed** message is displayed in the multifunction display and must be confirmed. Should this occur, assistance must be summoned by other means.

An emergency call is dialed automatically if an air bag or Emergency Tensioning Device is triggered.

 You cannot end an automatically triggered emergency call yourself.

An emergency call can also be initiated manually.

As soon as the emergency call has been initiated, the indicator lamp in the SOS button flashes. The **Connecting Call** message appears on the multifunction display.

The audio output is muted.

Once the connection has been made, the **Call Connected** message appears in the multifunction display.

All important information on the emergency is transmitted, for example:

- current location of the vehicle (as determined by the GPS system)
- vehicle identification number
- information on serious accidents

Shortly after the emergency call has been initiated, a voice connection is automatically established between the Mercedes-Benz Customer Assistance Center and the vehicle occupants. If the vehicle occupants respond, the Mercedes-Benz Customer Assistance Center attempts to get more information on the emergency.





 If there is no response from the vehicle occupants, an ambulance is immediately sent to the vehicle.

Making an emergency call

WARNING

If you feel at any way in jeopardy when in the vehicle (e.g. smoke or fire in the vehicle, vehicle in a dangerous road location), please do not wait for voice contact after you have pressed the SOS button. Carefully leave the vehicle and move to a safe location. The Response Center will automatically contact local emergency officials with the vehicle's approximate location if they receive an automatic SOS signal and cannot make voice contact with the vehicle occupants.



- ▶ **To manually initiate an emergency call:** press cover  briefly to open.
- ▶ Press SOS button  briefly. The indicator lamp in SOS button  flashes until the emergency call is concluded.
- ▶ Wait for a voice connection to the Mercedes-Benz Customer Assistance Center.
- ▶ After the emergency call, close cover .

Roadside Assistance button



- ▶ Press button ① for Roadside Assistance. This initiates a call to the Mercedes-Benz Customer Assistance Center. The indicator lamp in Roadside Assistance button ① flashes while the call is active. The **Connecting Call** message appears on the multifunction display. The audio output is muted.

If a connection can be made, the **Call Connected** message appears in the multifunction display.

If a cellular phone network is available and there is sufficient GPS reception, the mbrace system transmits data to the Mercedes-Benz Customer Assistance Center, for example:

- current location of the vehicle
- Vehicle identification number

- ❗ The COMAND display shows that an mbrace call is active. During the call, you can change to the navigation menu by pressing the NAVI button on COMAND, for example.

Voice output is not available.

A voice connection is established between the Mercedes-Benz Customer Assistance Center and the vehicle occupants.

From the vehicle remote malfunction diagnosis, the Mercedes-Benz Customer Assistance center can ascertain the nature of the problem (▷ page 492).

The Mercedes-Benz Customer Assistance Center either sends a qualified Mercedes-

Benz technician or organizes for your vehicle to be transported to the nearest authorized Mercedes-Benz Center. You may be charged for services such as repair work and/or towing. Further details are available in your mbrace manual.

- ❗ The mbrace system failed to initiate a Roadside Assistance call if:

- the indicator lamp for roadside assistance call button ① is flashing continuously
- no voice connection to the Mercedes-Benz Customer Assistance Center was established.

This may be because the corresponding mobile phone network is not available.

The **Call Failed** message appears in the multifunction display.

- ▶ **To end a call:** press the  button on the multifunction steering wheel.

or

- ▶ Press the corresponding button for ending a phone call on COMAND.

MB Info call button



- ▶ Press MB Info call button ①. This initiates a call to the Mercedes-Benz Customer Assistance Center. The indicator lamp in MB Info call button ① flashes while the connection is being made. The **Connecting Call** message appears in the multifunction display and the COMAND system is muted.

If a connection can be made, the **Call Connected** message appears in the multifunction display.

If a cellular phone network is available and there is sufficient GPS reception, the mbrace system transmits data to the Mercedes-Benz Customer Assistance Center, for example:

- current location of the vehicle
- vehicle identification number

i The COMAND display shows that an mbrace call is active. During the call, you can change to the navigation menu by pressing the NAVI button on COMAND, for example.

Voice output is not available.

A voice connection is established between the Mercedes-Benz Customer Assistance Center and the vehicle occupants. You can obtain information on how to operate your vehicle's systems, on the location of the nearest authorized Mercedes-Benz Center, and on further products and services offered by Mercedes-Benz USA.

USA only: you can find further information on the mbrace system under "Owners Online" at <http://www.mbusa.com>.

i The mbrace system failed to initiate an MB Info call if:

- the indicator lamp in MB Info call button **1** is flashing continuously
- no voice connection to the Mercedes-Benz Customer Assistance Center was established.

This may be because the corresponding mobile phone network is not available.

The **Call Failed** message appears in the multifunction display.

► **To end a call:** press the  button on the multifunction steering wheel.

or

► Press the corresponding button for ending a phone call on COMAND.

Call priority

When service calls are active, e.g. Roadside Assistance or MB Info calls, an emergency call can still be initiated. In this case, an emergency call will take priority and override all other active calls.

The indicator lamp of the respective button flashes until the call is ended. An emergency call can only be terminated by the Mercedes-Benz Customer Assistance Center.

All other calls can be ended by pressing:

- the  button on the multifunction steering wheel
- or the corresponding COMAND button for ending a telephone call

i If an mbrace call is initiated, audio output is muted. The mobile phone is no longer connected to COMAND. However, if you want to use your mobile phone, do so only when the vehicle is stationary and in a safe location.

Downloading destinations in COMAND

Downloading destinations

Downloading destinations gives you access to a data bank with over 15 million Points of Interest (POIs). These can be downloaded on the navigation system in your vehicle. If you know the destination, the address can be downloaded. Alternatively, you can obtain the location of Points of Interest (POIs)/ important destinations in the vicinity.

Furthermore, you can download routes with up to 20 way points.

You are prompted to confirm route guidance to the address entered.

The system calculates the route and subsequently starts the route guidance with the address entered.

i If you select **No**, the address can be stored in the address book.

i The Destination Download function is available if the corresponding mobile

phone network is available and data transfer is possible.

- i** You can only use the Destination Download function if the vehicle is equipped with a navigation system.

Route Assistance

This service is part of the mbrace PLUS Package and cannot be purchased separately.

- i** You can also use the Route Assistance function if your vehicle is not equipped with a navigation system.

Within the framework of this service, you receive a professional and reliable form of navigation support without having to leave your vehicle.

The customer service representative finds a suitable route depending on your vehicle's current position and the desired destination. You will then be guided live through the current route section.

Search and send

Points to observe before use

- i** To use "Search & Send", your vehicle must be equipped with mbrace and a navigation system. You must also have an mbrace service subscription.

"Search & Send" is a destination entry service. A destination address which is found on Google Maps® can be transferred via mbrace directly to your vehicle's navigation system.

Specifying and sending the destination address

- ▶ Go to the website <http://www.maps.google.com> and enter a destination address into the entry field.
- ▶ **To send the destination address to the E-Mail address of your mbrace account:** click on the corresponding button.



- i** Example:

If you select 'Send to vehicle' and then 'Mercedes-Benz', the destination address will be sent to your vehicle.

- ▶ When the "Send" dialog window appears: In the relevant field, enter the e-mail address which you specified when activating your mbrace account.
- ▶ Click "Send".

- i** Information on specific commands such as "Address entry" or "Sending" can be found on the website.

Calling up destination addresses

- ▶ Switch on the ignition. The destination address is loaded into the vehicle's navigation system. A display message appears, asking whether navigation should be started.
- ▶ Select **Yes** by sliding  and turning  the COMAND controller and press  to confirm. The system calculates the route and subsequently starts the route guidance with the address entered.

- i** If you select **No**, the address can be stored in the address book.
- i** If you have sent more than one destination address, each individual destination must be confirmed separately.
- i** Destination addresses are loaded in the same order as the order in which they were sent. If you own multiple Mercedes-Benz vehicles with mbrace and activated mbrace accounts:

if multiple vehicles are registered under the same e-mail address, the destination will be sent to all the vehicles.

Vehicle remote opening

You can use the vehicle remote unlocking if you have unintentionally locked your vehicle and a replacement key is not available. The

vehicle can be opened by the Mercedes-Benz Customer Assistance center.

The vehicle can be immediately remotely opened within four days of the ignition being turned off. After this time, the remote unlocking may be delayed by 15 to 60 minutes. After 30 days the vehicle can no longer be opened remotely.

► Contact the following service hotlines:

- **USA:** Mercedes-Benz Customer Assistance center at 1-800-FOR-MERcedes (1-800-367-6372) or 1-888-990-9007
- **Canada:** Customer Service at 1-888-923-8367

You will be asked for your password.

► Return to your vehicle at the time agreed upon with the Mercedes-Benz Customer Assistance Center.

USA only: alternatively, the vehicle can be opened via:

- the Internet, under the "Owners Online" section
- the telephone application (e.g. iPhone®, Blackberry)

To do this, you will need your identification number and password.

- i** Vehicle remote unlocking is only possible if the corresponding mobile phone network is accessible.

Vehicle remote closing

The remote closing feature can be used when you have forgotten to lock the vehicle and you are no longer nearby. The vehicle can then be locked by the Mercedes-Benz Customer Assistance center.

The vehicle can be immediately remotely locked within four days of the ignition being turned off. After this time, the remote closing may be delayed by 15 to 60 minutes. After 30 days the vehicle can no longer be closed remotely.

► Contact the following service hotlines:

- **USA:** Mercedes-Benz Customer Assistance center at 1-800-FOR-MERcedes (1-800-367-6372) or 1-888-990-9007

- **Canada:** Customer Service at 1-888-923-8367

You will be asked for your PIN.

The next time you are inside the vehicle and you switch on the ignition, the **Doors Locked Remotely** message appears in the multifunction display.

USA only: alternatively, the vehicle can be locked via:

- the Internet, under the "Owners Online" section
- the telephone application (e.g. iPhone®, Blackberry)

To do this, you will need your identification number and password.

- i** The vehicle valet locking feature is available when the relevant mobile phone network is available and data connection is possible.

Stolen vehicle recovery service

If your vehicle has been stolen:

- Notify the police. The police will issue a numbered incident report.
- This number will be forwarded to the Mercedes-Benz Customer Assistance Center together with your PIN. The Mercedes-Benz Customer Assistance Center then attempts to locate the mbrace system. The Mercedes-Benz Customer Assistance Center contacts you and the local law enforcement agency if the vehicle is located. However, only the law enforcement agency is informed of the location of the vehicle.

- i** If the anti-theft alarm system is activated for longer than 30 seconds, the Mercedes-Benz Customer Assistance center is automatically informed.

Vehicle remote malfunction diagnosis

With the vehicle remote malfunction diagnosis (Vehicle Health Check), the Customer Assistance center can provide improved support for problems with your vehicle. During an existing call, vehicle data is transferred to the Customer Assistance center. The customer service representative can use the received data to decide what kind of assistance is required. You are then, for example, guided to the nearest Mercedes-Benz Service center or a recovery vehicle is called.

If vehicle data needs to be transferred during an MB Info call or a Roadside Assistance call, this is initiated by the Customer Assistance center. You will see the **Roadside Assistance Connected** message in the COMAND display. If the vehicle remote malfunction diagnosis is able to be started, the **Request for vehicle diagnosis received. Start vehicle diagnosis?** message appears in the display.

- ▶ Press **Yes** to confirm the message.
- ▶ If the **Vehicle Diagnosis: Please switch on ignition.** message appears: turn the key to position **2** in the ignition lock.
- ▶ If the **Please follow the instructions received by phone and move your vehicle to a safe position.** message appears: follow the instructions of the customer service representative. The message in the display disappears. If you select **Cancel**, the vehicle remote malfunction diagnosis is canceled completely. The vehicle operating state check begins. Meanwhile, the **Vehicle diagnosis activated** message appears.

When the check is finished, the **Sending vehicle diagnosis data...(Voice connection may be interrupted during data transfer.)** message

appears. The vehicle data can now be sent to the Customer Assistance center.

- ▶ Press **OK** to confirm the message. The voice connection with the Customer Assistance center is terminated. The **Vehicle Diagnosis: Transferring data...** appears. The vehicle data is sent to the Customer Assistance center.

Depending on what the customer service representative agreed with you, the voice connection is re-established after the transfer is complete. If necessary, you will be contacted at a later time by another means, e.g. by E-Mail or telephone.

Further functions of the vehicle remote malfunction diagnosis include, for example:

- transfer of service data to the Customer Assistance center. If a service is overdue, the COMAND display shows a message about various special offers at your workshop.
- monthly status information E-Mail on oil level, air pressure, maintenance, brakes, etc. If applicable, you will receive information on special offers in the E-Mail. USA only: this information can also be called up under "Owners Online" at <http://www.mbusa.com>.

Information on the data stored in the vehicle (▷ page 32).

Information on roadside assistance (▷ page 29).

Downloading routes

Downloading routes allows you to transfer and save predefined routes in the navigation system. To do this, an SD memory card must be inserted into the COMAND system. If no SD memory card is inserted, you must insert the card into the card slot on the COMAND system before saving.

A route can be prepared and sent either by a customer service representative or via the mbrace portal on the Internet. Each route can

include up to 20 way points. When a route has been received by the navigation system, 'Route name' has been saved to memory card. Do you want to start route guidance? appears on the COMAND display. The route is saved to the SD memory card.

► **To start route guidance:** select **Yes**.

An overview of the route is shown in the display.

❶ If you select **No**, the saved route can be called up later in the navigation menu.

► Select **Start**.

Route guidance is started.

❶ Downloaded and saved data can be called up again in COMAND. Further information can be found in the "COMAND", "Online and Internet services" and "Download destination/route" sections.

Speed alert

You can define the upper speed limit, which must not be exceeded by the vehicle. If this selected speed is exceeded by the vehicle, a message will be sent to the Customer Assistance center. The Customer Assistance center then forwards this information to you. You can select the way in which you receive this information beforehand. Possible options include SMS, E-Mail or an automated call.

The data which is sent to the Customer Assistance center contains the following information:

- the location where the speed limit was exceeded
- the time at which the speed limit was exceeded
- the selected speed limit which was exceeded

Geo fencing

Geo fencing allows you to select areas which the vehicle should not enter or leave. You will be informed if the vehicle crosses the

boundaries of the selected areas. You can select the way in which you receive this information beforehand. Possible options include SMS, E-Mail or an automated call.

The area can be determined as either a circle or a polygon with a maximum of ten corners. You can specify up to ten areas simultaneously. Different settings are possible for each area.

USA only: these settings can be called up under "Owners Online" at <http://www.mbusa.com>.

Alternatively, you can trigger an MB Info call and inform the customer service representative that you wish to activate geo fencing.

Currently inactive areas can be activated by SMS.

Triggering the vehicle alarm

With this function, you can trigger the vehicle's panic alarm via SMS. An alarm sounds and the exterior lighting flashes. Depending on the setting, the panic alarm lasts five or ten seconds. Afterwards, the alarm switches off.

Useful information	496
Engine compartment	496
ASSYST PLUS	500
Care	500

Useful information

- i** This Operator's Manual describes all models and all standard and optional equipment of your vehicle available at the time of publication of the Operator's Manual. Country-specific differences are possible. Please note that your vehicle may not be equipped with all features described. This also applies to safety-related systems and functions.
- i** Read the information on qualified specialist workshops: (> page 31).

Engine compartment

Hood

Opening the hood

 **WARNING**

Do not pull the release lever while the vehicle is in motion. Otherwise, the hood could be forced open by passing air flow.

This could cause the hood to come loose and injure you and/or others.

 **WARNING**

Do not open the hood when the engine is overheated. You could be seriously injured. Observe the coolant temperature gauge to determine whether the engine may be overheated. If you see flames or smoke coming from the engine compartment, move away from the vehicle. Wait until the engine has cooled. If necessary, call the fire department.

 **WARNING**

There is a risk of injury if the hood is open, even if the engine is not running.

Some engine components can become very hot.

To avoid the risk of burns, only touch those components described in the Operator's Manual and observe the relevant safety notes.

 **WARNING**

To avoid injury, stay clear of moving parts when the hood is open and the engine is running.

The radiator fan may continue to run for approximately 30seconds or may even restart after the engine has been switched off. For this reason, you must not reach into the fan rotation area.

 **WARNING**

The engine is equipped with a transistorized ignition system. Because of the high voltage, it is dangerous to touch any components (ignition coils, spark plug sockets, diagnostic socket) of the ignition system:

- with the engine running
- while starting the engine
- when the ignition is switched on and the engine is turned manually

 **WARNING**

The windshield wipers and wiper linkage could be set in motion.

When the hood is open, you or others could be injured by the wiper linkage.

Make sure that the windshield wipers are switched off. Remove the SmartKey or make sure that no ignition position has been selected with KEYLESS-GO. All indicator lamps must be off in the instrument panel.

- !** Make sure that the windshield wipers are not folded away from the windshield. You could otherwise damage the windshield wipers or the hood.



- ▶ Make sure that the windshield wipers are turned off.
- ▶ Pull release lever ① on the hood. The hood is released.



- ▶ Reach into the gap, pull hood catch handle ② up and lift the hood. If you lift the hood approximately 15 inches (40cm) the hood is opened and held open automatically by the gas-filled struts.

Closing the hood

⚠ WARNING

When closing the hood, use extreme caution not to catch hands or fingers. Be careful that you do not close the hood on anyone.

Make sure the hood is securely engaged before driving off. Do not continue driving if the hood can no longer engage after an accident, for example. The hood could otherwise come loose while the vehicle is in motion and injure you and/or others.

- ▶ Lower the hood and let it fall from a height of approximately 8 inches (20cm).
- ▶ Check that the hood has engaged properly. If the hood can be raised slightly, it is not properly engaged. Open it again and close it with a little more force.

Engine oil

Notes on the oil level

Depending on the driving style, the vehicle consumes up to 0.9 US qt (0.8l) of oil over a distance of 600 miles (1000km). The oil consumption may be higher than this when the vehicle is new or if you frequently drive at high engine speeds.

Checking the oil level using the oil dipstick

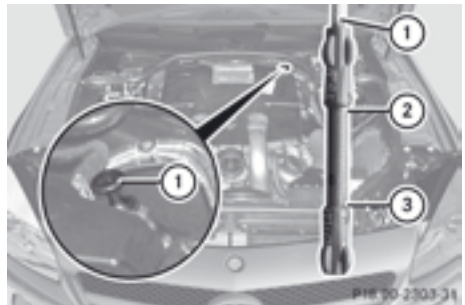

Example

- ▶ Park the vehicle on a level surface.
 - To check the oil level with the engine at operating temperature, switch the engine off and wait for approximately five minutes.
- ▶ Pull oil dipstick ① out of the dipstick guide tube.
- ▶ Wipe off oil dipstick ①.
- ▶ Slowly slide oil dipstick ① into the guide tube to the stop, and take it out again. If the level is between MIN mark ③ and MAX mark ②, the oil level is correct.
- ▶ Add oil if necessary.

Adding engine oil

WARNING

If engine oil comes into contact with hot engine parts, it may ignite and you could burn yourself. Do not spill any engine oil on hot engine parts.

Environmental note

When adding oil, take care not to spill any. If oil enters the soil or waterways, it is harmful to the environment.



- !** Use only engine oils and oil filters that have been approved for vehicles equipped with a service system. A list of the engine oils and oil filters tested and approved in accordance with the Mercedes-Benz Specifications for Service Products can be called up by visiting <http://www.mbusa.com> (USA only). More information about tested and approved engine oils and oil filters is available from any authorized Mercedes-Benz Center. Damage to the engine or exhaust system is caused by the following:

- using engine oils and oil filters which have not been specifically approved for the service system.
- replacing the engine oil or oil filter after the replacement interval required by the service system has elapsed
- using engine oil additives.

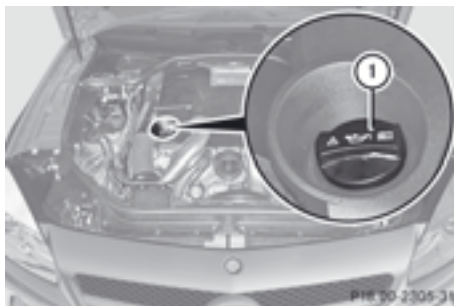
- !** Do not add too much oil. If the oil level is above the "max" mark on the dipstick, too much oil has been added. This can lead to damage to the engine or the catalytic converter. Have excess oil siphoned off.



Example: engine oil cap

- ▶ Turn cap  counter-clockwise and remove it.
- ▶ Add the amount of oil required.
Fill carefully to the maximum mark on the oil dipstick.
- ▶ Replace cap  on the filler neck and tighten clockwise.
Ensure that the cap locks into place securely.
- i** The difference between the minimum mark and the maximum mark on the oil dipstick is approximately 1.4 US qt (1.3l).
- i** Further information on engine oil
(▷ page 562).

Checking and adding other service products

Checking the coolant level

WARNING

In order to avoid potentially serious burns:

- use extreme caution when opening the hood if there are any signs of vapor or coolant leaking from the cooling system, or if the coolant temperature display indicates that the coolant is overheated.
- do not remove the pressure cap on the coolant tank if the coolant temperature is above 158 °F (70 °C). Allow the engine to cool down before removing the cap. The coolant tank contains hot fluid and is under pressure.

- using a cloth, slowly turn the cap approximately $\frac{1}{2}$ turn to relieve excess pressure. If you open the cap immediately, pressurized scalding hot fluid and vapor will be blown out.
- do not spill antifreeze on hot engine parts. Antifreeze contains ethylene glycol which may burn if it comes into contact with hot engine parts.

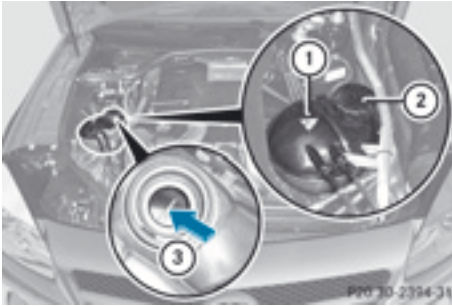

Example

- ▶ Park the vehicle on a level surface.
Only check the coolant level when the vehicle is on a level surface and the engine has cooled down.
- ▶ Turn the SmartKey to position **2** in the ignition lock (▷ page 135).
On vehicles with KEYLESS-GO, press the Start/Stop button twice (▷ page 135).
- ▶ Check the coolant temperature display in the instrument cluster.
The coolant temperature must be below 158 °F (70 °C).
- ▶ Slowly turn cap **2** half a turn counter-clockwise and allow excess pressure to escape.
- ▶ Turn cap **2** further counter-clockwise and remove it.
If the coolant is at the level of marker bar **3** in the filler neck when cold, there is enough coolant in coolant expansion tank **1**.
If the coolant level is approximately 0.6 in (1.5 cm) above marker bar **3** in the filler

neck when warm, there is enough coolant in coolant expansion tank **1**.

- ▶ If necessary, add coolant that has been tested and approved by Mercedes-Benz.
- ▶ Replace cap **2** and turn it clockwise as far as it will go.

For further information on coolant, see (▷ page 563).

Windshield washer system and headlamp cleaning system

⚠ WARNING

Washer solvent/antifreeze is highly flammable. Do not spill washer solvent/antifreeze on hot engine parts, because it may ignite and burn. You could be seriously burned.



Example

- ▶ **To open:** pull cap **1** upwards by the tab.
- ▶ Add the premixed washer fluid.
- ▶ **To close:** press cap **1** onto the filler neck until it engages.

The washer fluid reservoir is used for both the windshield washer system and the headlamp cleaning system.

For further information on the windshield washer system and headlamp cleaning system, see (▷ page 564).

ASSYST PLUS

The ASSYST PLUS service interval display informs you of the next service due date. Information on the type of service and service intervals (see separate Maintenance Booklet).

You can obtain further information from an authorized Mercedes-Benz Center or at <http://www.mbusa.com> (USA only).

- i** The ASSYST PLUS service interval display does not show any information on the engine oil level. Observe the notes on the engine oil level (▷ page 497).

Care

Notes on care

WARNING

Many cleaning products can be hazardous. Some are poisonous, others are flammable. Always follow the instructions on the particular container. Always open your vehicle's doors or windows when cleaning the inside.

Never use fluids or solvents that are not designed for cleaning your vehicle.

Always lock away cleaning products and keep them out of reach of children.

Environmental note

Dispose of empty packaging and cleaning cloths in an environmentally responsible manner.

- !** For cleaning your vehicle, do not use any of the following:

- dry, rough or hard cloths
- abrasive cleaning agents
- solvents
- cleaning agents containing solvents

Do not scrub.

Do not touch the surfaces or protective films with hard objects, e.g. a ring or ice

scraper. You could otherwise scratch or damage the surfaces and protective film.

- !** Do not park the vehicle for an extended period straight after cleaning it, particularly after having cleaned the wheels with wheel cleaner. Wheel cleaners could cause increased corrosion of the brake discs and brake pads/linings. For this reason, you should drive for a few minutes after cleaning. Braking heats the brake discs and the brake pads/linings, thus drying them. The vehicle can then be parked.

Regular care of your vehicle is a condition for retaining the quality in the long term.

Use care products and cleaning agents recommended and approved by Mercedes-Benz.

Washing the vehicle and cleaning the paintwork

Automatic car wash

WARNING

Braking efficiency is reduced after washing the vehicle. This could cause an accident. For this reason, you must drive particularly carefully after washing the vehicle until the brakes have dried.

WARNING

The vehicle is braked when the HOLD function or DISTRONIC PLUS is activated. Therefore, deactivate the HOLD function and DISTRONIC PLUS before the vehicle is washed in an automatic car wash.

- !** It is preferable to use car washes with adjustable high-pressure pre-cleaning that corresponds to the specification for the Cabriolet program. In car washes that use high water pressures, there is a risk that a small amount of water may leak into the vehicle.

- !** Never clean your vehicle in a Touchless Automatic Car Wash as these use special

cleaning agents. These cleaning agents can damage the paintwork or plastic parts.

! Make sure that the automatic transmission is in position **N** when washing your vehicle in a tow-through car wash. The vehicle could be damaged if the transmission is in another position.

! Make sure that:

- the side windows are fully closed.
- the ventilation/heating is switched off (the OFF button has been pressed).
- the windshield wiper switch is in position **0**.

Otherwise, the vehicle might be damaged.

You can wash the vehicle in an automatic car wash from the very start.

If the vehicle is very dirty, pre-wash it before cleaning it in an automatic car wash.

After using an automatic car wash, wipe off wax from the windshield and the wiper blades. This will prevent smears and reduce wiping noises caused by residue on the windshield.

Washing by hand

In some countries, washing by hand is only allowed at specially equipped washing bays. Observe the legal requirements in all countries concerned.

- ▶ Do not use hot water and do not wash the vehicle in direct sunlight.
- ▶ Use a soft sponge to clean.
- ▶ Use a mild cleaning agent, such as a car shampoo approved by Mercedes-Benz.
- ▶ Thoroughly hose down the vehicle with a gentle jet of water.
- ▶ Do not point the water jet directly towards the air inlets.
- ▶ Use plenty of water and rinse out the sponge frequently.

- ▶ Rinse the vehicle with clean water and dry thoroughly with a chamois.
- ▶ Do not let the cleaning agent dry on the paintwork.

When using the vehicle in winter, remove all traces of road salt deposits carefully and as soon as possible.

Power washers

WARNING

Do not use power washers with circular-jet nozzles (dirt grinders) to clean your vehicle, in particular the tires. You could otherwise damage the tires and cause an accident.

! Always maintain a distance of at least 11.8 in (30 cm) between the vehicle and the power washer nozzle. Information about the correct distance is available from the equipment manufacturer.

Move the power washer nozzle around when cleaning your vehicle.

Do not aim directly at any of the following:

- tires
- door gaps, roof gaps, joints, etc.
- electrical components
- battery
- connectors
- lights
- seals
- trim
- ventilation slots

Damaged seals or electrical components can lead to leaks or failures.

Cleaning the paintwork

! Do not affix:

- stickers
- films
- magnetic plates or similar items

to painted surfaces. You could otherwise damage the paintwork.

Scratches, corrosive deposits, areas affected by corrosion and damage caused by inadequate care cannot always be completely repaired. In such cases, visit a qualified specialist workshop.

- ▶ Remove dirt immediately, where possible, while avoiding rubbing too hard.
- ▶ Soak insect remains with insect remover and rinse off the treated areas afterwards.
- ▶ Soak bird droppings with water and rinse off the treated areas afterwards.
- ▶ Remove coolant, brake fluid, tree resin, oils, fuels and greases by rubbing gently with a cloth soaked in petroleum ether or lighter fluid.
- ▶ Use tar remover to remove tar stains.
- ▶ Use silicone remover to remove wax.

If water no longer forms "beads" on the paint surface, use the paint care products recommended and approved by Mercedes-Benz. This is the case approximately every three to five months, depending on the climate conditions and the care product used.

If dirt has penetrated the paint surface or if the paint has become dull, the paint cleaner recommended and approved by Mercedes-Benz should be used.

Do not use these care products in the sun or on the hood while the hood is hot.

- ▶ Use a suitable touch-up stick, e.g. MB Touch-Up Stick, to repair slight damage to the paintwork quickly and provisionally.

Matte finish care

- ❗ Never polish the vehicle or the light alloy wheels. Polishing causes the finish to shine.

- ❗ The following may cause the paint to become shiny and thus reduce the matte effect:

- Vigorous rubbing with unsuitable materials.
- Frequent use of car washes.
- Washing the vehicle in direct sunlight.

- ❗ Never use paint cleaner, buffing or polishing products, or gloss preserver, e.g. wax. These products are only suitable for high-gloss surfaces. Their use on vehicles with matte finish leads to considerable surface damage (shiny, spotted areas).

Always have paintwork repairs carried out at a qualified specialist workshop.

- ❗ Do not use wash programs with a hot wax treatment under any circumstances.

Observe these notes if your vehicle has a clear matte finish. This will help you to avoid damage to the paintwork due to incorrect treatment.

These notes also apply to light alloy wheels with a clear matte finish.

- i The vehicle should preferably be washed by hand using a soft sponge, car shampoo and plenty of water.
- i Use only insect remover and car shampoo from the range of recommended and approved Mercedes-Benz care products.

Cleaning the vehicle parts

Cleaning the wheels

- ❗ Do not use acidic wheel cleaning products to remove brake dust. This could damage wheel bolts and brake components.
- ❗ Do not park the vehicle for an extended period straight after cleaning it, particularly after having cleaned the wheels with wheel cleaner. Wheel cleaners could cause increased corrosion of the brake discs and brake pads/linings. For this reason, you

should drive for a few minutes after cleaning. Braking heats the brake discs and the brake pads/linings, thus drying them. The vehicle can then be parked.



Cleaning the windows

WARNING

Before cleaning the windshield or wiper blades, switch off the windshield wipers and remove the SmartKey from the ignition lock. On vehicles with KEYLESS-GO, press the Start/Stop button repeatedly until all indicator lamps in the instrument cluster have gone out. The windshield wipers could otherwise move and injure you.

WARNING



Do not clean the rear window with the retractable hardtop (vario-roof) in a position other than the fully raised and closed position. Otherwise, the retractable hardtop may move unexpectedly which may result in personal injury to you or others.

-  Only fold the windshield wipers away from the windshield when vertical. Otherwise, you will damage the hood.
-  Do not use dry cloths, abrasive products, solvents or cleaning agents containing solvents to clean the inside of the windows. Do not touch the insides of the windows with hard objects, e.g. an ice scraper or ring. There is otherwise a risk of damaging the windows.
-  Clean the water drainage channels of the windshield and the rear window at regular intervals. Deposits such as leaves, petals and pollen may under certain circumstances prevent water from draining away. This can lead to corrosion damage and damage to electronic components.
- ▶ Clean the inside and outside of the windows with a damp cloth and a cleaning agent that is recommended and approved by Mercedes-Benz.

Cleaning the wiper blades

WARNING

Before cleaning the windshield or wiper blades, switch off the windshield wipers and remove the SmartKey from the ignition lock. On vehicles with KEYLESS-GO, press the Start/Stop button repeatedly until all indicator lamps in the instrument cluster have gone out. The windshield wipers could otherwise move and injure you.

-  Do not pull the wiper blade. Otherwise, the wiper blade could be damaged.
-  Do not clean wiper blades too often and do not rub them too hard. Otherwise, the graphite coating could be damaged. This could cause wiper noise.
-  Hold the wiper arm securely when folding back. The windshield could be damaged if the wiper arm smacks against it suddenly.
- ▶ Fold the windshield wiper arms away from the windshield.
- ▶ Carefully clean the wiper blades with a damp cloth.
- ▶ Fold the windshield wiper arms back again before switching on the ignition.

Cleaning the exterior lighting

-  Only use cleaning agents or cleaning cloths which are suitable for plastic light lenses. Unsuitable cleaning agents or cleaning cloths could scratch or damage the plastic light lenses.
- ▶ Clean the plastic lenses of the exterior lighting using a wet sponge and a mild cleaning agent, e.g. Mercedes-Benz car shampoo or cleaning cloths.

Mirror turn signals

-  Only use cleaning agents or cleaning cloths that are suitable for plastic lenses. Unsuitable cleaning agents or cleaning

cloths could scratch or damage the plastic lenses of the mirror turn signals.

- ▶ Clean the plastic lenses of the mirror turn signals in the exterior mirror housing using a wet sponge and mild cleaning agent, e.g. Mercedes-Benz car shampoo or cleaning cloths.

Cleaning the sensors

- ❗ If you clean the sensors with a power washer, make sure that you keep a distance of at least 11.8 in (30 cm) between the vehicle and the power washer nozzle. Information about the correct distance is available from the equipment manufacturer.

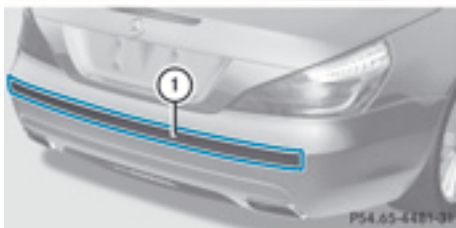
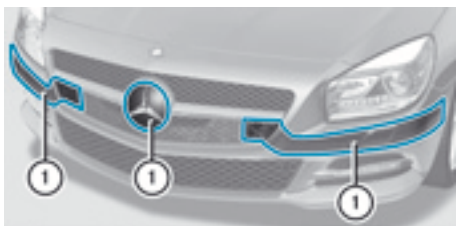

- ▶ Clean sensors ① of the driving systems with water, car shampoo and a soft cloth.

Cleaning the rear view camera

- ❗ Do not clean the camera lens and the area around the rear view camera with a power washer.



- ▶ Use clear water and a soft cloth to clean camera lens ①.

Cleaning the exhaust pipe

- ❗ Do not clean the exhaust pipe with alkaline-based cleaning agents, such as wheel cleaner.
- ▶ Clean the exhaust pipe with a chrome care product tested and approved by Mercedes-Benz.

Impurities combined with the effects of road grit and corrosive environmental factors may cause flash rust to form on the surface. You can restore the original shine of the exhaust pipe by cleaning it regularly, especially in winter and after washing.

Interior care

Cleaning the display

- ❗ For cleaning, do not use any of the following:
 - alcohol-based thinner or gasoline
 - abrasive cleaning agents
 - commercially-available household cleaning agents

These may damage the display surface. Do not put pressure on the display surface when cleaning. This could lead to irreparable damage to the display.

- ▶ Before cleaning the display, make sure that it is switched off and has cooled down.
- ▶ Clean the display surface using a commercially available microfiber cloth and TFT/LCD display cleaner.
- ▶ Dry the display surface using a dry microfiber cloth.

Cleaning the plastic trim

WARNING

When cleaning the steering wheel boss and dashboard, do not use cockpit sprays or cleaning agents containing solvents. Cleaning agents containing solvents cause the surface to become porous, and as a result, plastic parts may break away and be thrown around the interior when an air bag is deployed, which may result in severe injuries.

- ❗ Do not affix the following to plastic surfaces:

- stickers
- films
- scented oil bottles or similar items

You can otherwise damage the plastic.

- ❗ Do not allow cosmetics, insect repellent or sunscreen to come into contact with the plastic trim. This maintains the high-quality look of the surfaces.
- ▶ Wipe the plastic trim with a damp, lint-free cloth, e.g. a microfiber cloth.
- ▶ **Heavy soiling:** use car care and cleaning products recommended and approved by Mercedes-Benz.
The surface may change color temporarily. Wait until the surface is dry again.

Cleaning the steering wheel and gear or selector lever

- ▶ Thoroughly wipe with a damp cloth or use leather care agents that have been recommended and approved by Mercedes-Benz.

Cleaning genuine wood and trim elements

- ❗ Do not use solvent-based cleaning agents such as tar remover, wheel cleaners, polishes or waxes. There is otherwise a risk of damaging the surface.

- ❗ Do not use chrome polish on trim pieces. The trim pieces have a chrome look but are mostly made of anodized aluminum and can lose their shine if chrome polish is used. Use a damp, lint-free cloth instead when cleaning the trim pieces.

If the chrome-plated trim pieces are very dirty, you can use a chrome polish. If you are unsure as to whether the trim pieces are chrome-plated or not, consult an authorized Mercedes-Benz Center.

- ▶ Wipe the wooden trim and trim pieces with a damp, lint-free cloth, e.g. a microfiber cloth.
- ▶ **Heavy soiling:** use car care and cleaning products recommended and approved by Mercedes-Benz.

Cleaning the seat covers

- ❗ Observe the following when cleaning:
 - clean genuine leather covers carefully with a damp cloth and then wipe the covers down with a dry cloth. Make sure that the leather does not become soaked. It may otherwise become rough and cracked. Only use leather care agents that have been tested and approved by Mercedes-Benz. You can obtain these from a qualified specialist workshop.
 - clean artificial leather covers with a cloth moistened with a solution containing 1% detergent (e.g. dish washing liquid).
 - clean cloth covers with a microfiber cloth moistened with a solution containing 1% detergent (e.g. dish washing liquid). Rub carefully and always wipe entire seat sections to avoid leaving visible lines.

Leave the seat to dry afterwards.
Cleaning results depend on the type of dirt and how long it has been there.

- clean Alcantara® covers with a damp cloth. Make sure that you wipe entire seat sections to avoid leaving visible lines.

! Do not use microfiber cloths to clean genuine leather, artificial leather or Alcantara® covers. If used often, these can damage the cover.

i Note that regular care is essential to ensure that the appearance and comfort of the covers is retained over time.

Cleaning the seat belts

⚠ WARNING

Do not bleach or dye seat belts as this may severely weaken them. In a crash, they may not be able to provide adequate protection.

! Do not clean the seat belts using chemical cleaning agents. Do not dry the seat belts by heating at temperatures above 176 °F (80 °C) or in direct sunlight.

- ▶ Use clean, lukewarm water and soap solution.

Cleaning the headliner and carpets

- ▶ **Headliner:** if it is very dirty, use a soft brush or dry shampoo.
- ▶ **Carpets:** use the carpet and textile cleaning agents recommended and approved by Mercedes-Benz.

Useful information	508
Where will I find...?	508
Flat tire	509
Battery	513
Jump-starting	516
Towing and tow-starting	518
Fuses	521

Useful information

- i** This Operator's Manual describes all models and all standard and optional equipment of your vehicle available at the time of publication of the Operator's Manual. Country-specific differences are possible. Please note that your vehicle may not be equipped with all features described. This also applies to safety-related systems and functions.
- i** Read the information on qualified specialist workshops: (> page 31).

Where will I find...?

First-aid kit



First-aid kit ① is located in the trunk under the trunk floor.

- ▶ Open the trunk lid.
- ▶ Open the trunk partition (> page 89).
- ▶ Lift the trunk floor upwards (> page 478).
- ▶ Remove first-aid kit ①.

- i** Check the expiration date on the first-aid kit at least once a year. Replace the contents if necessary, and replace missing items.

Vehicle tool kit

General notes

The vehicle tool kit consists of the towing eye and the test gauge for measuring the brake pad thickness (> page 160). The towing eye is located in the trunk in a bracket below the trunk lid lock. The gauge for measuring brake pad/lining thickness is in the vehicle document wallet. If the vehicle is equipped with a TIREFIT kit, this will be located in the stowage space under the trunk floor.

Vehicles with a TIREFIT kit



- ① Towing eye
- ② Tire sealant filler bottle
- ③ Fuse allocation chart
- ④ Tire inflation compressor

- ▶ Open the trunk lid.
- ▶ Open the trunk partition (> page 89).
- ▶ Lift the trunk floor upwards (> page 478).

Tire-change tool kit



① Bag containing the tire-changing tools

- ▶ Open the trunk lid.
- ▶ Open the trunk partition (▷ page 89).
- ▶ Lift the trunk floor upwards (▷ page 478).

i Depending on the equipment, tools required for a wheel change, such as a jack or a lug wrench, are not available in all vehicles. Tools approved for your vehicle are available at a qualified specialist workshop.

Bag with the tire-changing tools ① contains:

- jack
- lug wrench
- alignment bolt
- wheel chock
- gloves

Flat tire

Preparing the vehicle

Information on changing a wheel/installing (▷ page 547).

Vehicle preparation is not necessary on vehicles with MOExtended tires.

Your vehicle may be equipped with:

- MOExtended tires (tires with run-flat characteristics) (▷ page 510)
- a TIREFIT kit (▷ page 510)

- ▶ Stop the vehicle on solid, non-slippery and level ground, as far away as possible from traffic.
- ▶ Switch on the hazard warning lamps.
- ▶ Secure the vehicle against rolling away (▷ page 154).
- ▶ If possible, bring the front wheels into the straight-ahead position.
- ▶ Switch off the engine.
- ▶ **Vehicles without KEYLESS-GO:** remove the SmartKey from the ignition lock.
- ▶ **Vehicles with KEYLESS-GO:** open the driver's door. The on-board electronics have status **0**, which is the same as the SmartKey having been removed.
- ▶ **Vehicles with KEYLESS-GO:** remove the Start/Stop button from the ignition lock (▷ page 135).
- ▶ All occupants must get out of the vehicle. Make sure that they are not endangered as they do so.
- ▶ Make sure that no one is near the danger area while a wheel is being changed. Anyone who is not directly assisting in the wheel change should, for example, stand behind the barrier.
- ▶ Get out of the vehicle. Pay attention to traffic conditions when doing so.
- ▶ Close the driver's door.

i Vehicles equipped with MOExtended tires are not equipped with a TIREFIT kit at the factory. It is therefore recommended that you additionally equip your vehicle with a TIREFIT kit if you mount tires that do not feature run-flat properties, e.g. winter tires. A TIREFIT kit can be obtained from a qualified specialist workshop.

MOExtended tires (tires with run-flat properties)

WARNING

When driving in emergency mode, the driving characteristics deteriorate, e.g. when cornering, accelerating quickly and when braking. There is a risk of an accident.

Do not exceed the stated maximum speed. Avoid abrupt steering and driving maneuvers, and driving over obstacles (curbs, potholes, off-road). This applies in particular to a laden vehicle.

Stop driving in emergency mode if:

- you hear banging noises.
- the vehicle starts to shake.
- you see smoke and smell rubber.
- ESP® is intervening constantly.
- there are tears in the sidewalls of the tire.

After driving in emergency mode, have the wheel rims checked at a qualified specialist workshop with regard to their further use. The defective tire must be replaced in every case.

With MOExtended tires (tires with run flat characteristics), you can continue to drive your vehicle even if there is a total loss of pressure in one or more tires.

MOExtended tires may only be used in conjunction with the activated tire pressure loss warning system or with the activated tire pressure monitor.

The maximum driving distance is approximately 50 miles (80 km) when the vehicle is partially laden, and approximately 18 miles (30 km) when the vehicle is fully laden.

In addition to the vehicle load, the driving distance possible depends upon:

- speed
- road condition
- outside temperature

The driving distance possible in run-flat mode may be reduced by extreme driving

conditions/maneuvers, or it can be increased through a moderate style of driving.

The maximum permissible distance which can be driven in run-flat mode is counted from the moment the tire pressure loss warning appears in the multifunction display.

You must not exceed a maximum speed of 50 mph (80 km/h).

- i** When changing or replacing one or all of the tires, note the label "MOExtended". Take note also of the size specified for the vehicle.
- i** Vehicles equipped with MOExtended tires are not equipped with a TIREFIT kit at the factory. It is therefore recommended that you additionally equip your vehicle with a TIREFIT kit if you mount tires that do not feature run-flat properties, e.g. winter tires. A TIREFIT kit is available, for example, from a qualified specialist workshop.

TIREFIT kit

Using the TIREFIT kit

TIREFIT is a tire sealant.

You can use TIREFIT to seal punctures of up to 0.16 in (4 mm), particularly those in the tire tread. You can use TIREFIT at outside temperatures down to -4 °F (-20 °C).

WARNING

In the following situations, the tire sealant is unable to provide sufficient breakdown assistance, as it is unable to seal the tire properly:

- there are cuts or punctures in the tire larger than those mentioned above.
- the wheel rim is damaged.
- you have driven at very low tire pressures or on a flat tire.

There is a risk of an accident.

Do not drive any further. Contact a qualified specialist workshop.

⚠ WARNING

The tire sealant is harmful and causes irritation. It must not come into contact with your skin, eyes or clothing or be swallowed. Do not inhale TIREFIT fumes. Keep tire sealant away from children. There is a risk of injury. If you come into contact with the tire sealant, observe the following:

- Rinse off the tire sealant from your skin immediately with water.
- If the tire sealant comes into contact with your eyes, immediately rinse them thoroughly with clean water.
- If tire sealant is swallowed, immediately rinse your mouth out thoroughly and drink plenty of water. Do not induce vomiting, and seek medical attention immediately.
- Immediately change out of clothing which has come into contact with tire sealant.
- If an allergic reaction occurs, seek medical attention immediately.

! Do not operate the tire inflation compressor for longer than eight minutes at a time without a break. It may otherwise overheat.

The tire inflation compressor can be operated again once it has cooled down.

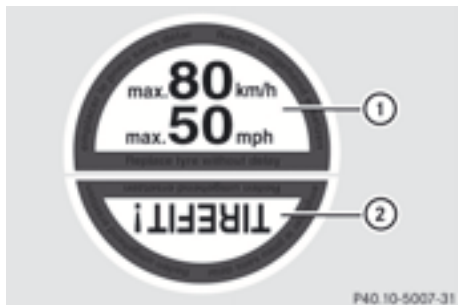

- ▶ Do not remove any foreign objects which have penetrated the tire, e.g. screws or nails.
- ▶ Remove the tire sealant bottle, the accompanying "max. 80 km/h" sticker and the tire inflation compressor from the

stowage well underneath the trunk floor (▷ page 508).

- ▶ Affix part ① of the sticker within the driver's field of vision.
- ▶ Affix part ② of the sticker near the valve on the wheel with the defective tire.

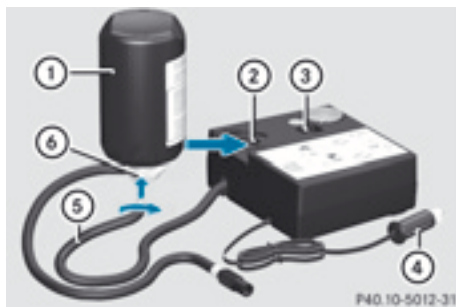

- ▶ Pull plug ④ with the cable and hose ⑤ out of the housing.
- ▶ Screw hose ⑤ onto flange ⑥ of tire sealant bottle ①.
- ▶ Place tire sealant bottle ① head downwards into recess ② of the tire inflation compressor.

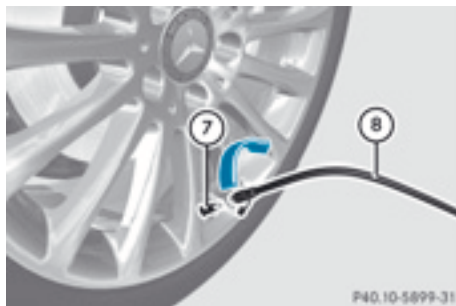

- ▶ Remove the cap from valve ⑦ on the faulty tire.
- ▶ Screw filler hose ⑧ onto valve ⑦.
- ▶ Insert plug ④ into the socket of the cigarette lighter or into a 12 V power socket in your vehicle.

Observe the notes on the cigarette lighter (▷ page 480). Observe the notes on sockets (▷ page 480).

- ▶ Turn the SmartKey to position **1** in the ignition lock (▷ page 135).
- ▶ Press on/off switch **③** on the tire inflation compressor to **I**.
The tire inflation compressor is switched on. The tire is inflated.

i First, tire sealant is pumped into the tire. The pressure can briefly rise to approximately 500 kPa (5.0 bar/73 psi).

Do not switch off the tire inflation compressor during this phase.

- ▶ Allow the tire inflation compressor to run for five minutes. The tire should then have attained a pressure of at least 180 kPa (1.8 bar/26 psi).

If a tire pressure of 180 kPa (1.8 bar/26 psi) has been attained after five minutes:
(▷ page 512).

If a tire pressure of 180 kPa (1.8 bar/26 psi) has not been attained after five minutes:
(▷ page 512).

- i** If tire sealant leaks out, allow it to dry. It can then be removed like a layer of film.
If your clothes are soiled with tire sealant, have them cleaned with perchloroethylene at a dry cleaner as soon as possible.

Tire pressure of at least 180 kPa (1.8 bar/26 psi) is not reached

If a pressure of 180 kPa (1.8 bar/26 psi) has not been achieved after five minutes:

- ▶ Switch off the tire inflation compressor.
- ▶ Unscrew the filler hose from the valve of the faulty tire.
- ▶ Very slowly drive forwards or reverse approximately 30 ft (10 m).
- ▶ Pump up the tire again.
After a maximum of five minutes the tire pressure must be at least 180 kPa (1.8 bar/26 psi).

⚠ WARNING

If the required tire pressure is not reached after the specified time, the tire is too badly damaged. The tire sealant cannot repair the tire in this instance. Damaged tires and a tire pressure that is too low can significantly impair the vehicle's braking and driving characteristics. There is a risk of accident.
Do not continue driving. Contact a qualified specialist workshop.

Tire pressure of 180 kPa (1.8 bar/26 psi) is reached

⚠ WARNING

A tire temporarily sealed with tire sealant impairs the driving characteristics and is not suitable for higher speeds. There is a risk of accident.

You should therefore adapt your driving style accordingly and drive carefully. Do not exceed the specified maximum speed with a tire that has been repaired using tire sealant.

- !** Residue from the tire sealant may come out of the filler hose after use. This could cause stains.

Therefore, place the filler hose in the plastic bag which contained the TIREFIT kit.

♻ Environmental note

Have the used tire sealant bottle disposed of professionally, e.g. at a qualified specialist workshop.

- ▶ Switch off the tire inflation compressor.
- ▶ Unscrew the filler hose from the valve of the faulty tire.
- ▶ Stow the tire sealant bottle and the tire inflation compressor.
- ▶ **Pull away immediately.**

The maximum speed for a tire sealed with tire sealant is 50 mph (80 km/h). The "max. 80 km/h" sticker must be affixed to the

instrument cluster within the driver's field of vision.

- ▶ Stop after driving for approximately ten minutes and check the tire pressure with the tire inflation compressor. The tire pressure must now be at least 130 kPa (1.3 bar/19 psi).

WARNING

If the required tire pressure is not reached after driving for a short period, the tire is too badly damaged. The tire sealant cannot repair the tire in this instance. Damaged tires and a tire pressure that is too low can significantly impair the vehicle's braking and driving characteristics. There is a risk of accident. Do not continue driving. Contact a qualified specialist workshop.

- ▶ Correct the tire pressure if it is still at least 130 kPa (1.3 bar/19 psi) (for the values, see the Tire and Loading Information placard on the driver's side B-pillar or tire pressure table on the fuel filler flap).
- ▶ **To increase the tire pressure:** switch on the tire inflation compressor.

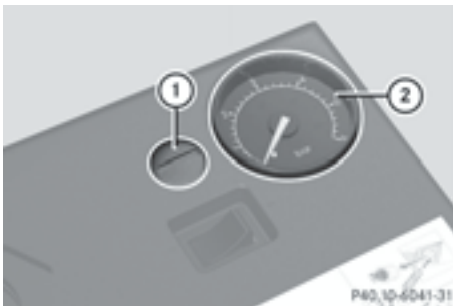

- ▶ **To reduce the tire pressure:** depress pressure release button ① next to pressure gauge ②.
- ▶ Stow the tire sealant bottle and the tire inflation compressor.
- ▶ Drive to the nearest qualified specialist workshop and have the tire changed there.

- ▶ Have the tire sealant bottle replaced as soon as possible at a qualified specialist workshop.
- ▶ Have the tire sealant bottle replaced every four years at a qualified specialist workshop.

Battery

Important safety notes

Special tools and expert knowledge are required when working on the battery, e.g. removal and installing. You should therefore have all work involving the battery carried out at a qualified specialist workshop.

WARNING

Work carried out incorrectly on the battery can, for example, lead to a short circuit and damage your vehicle's electronic system. This can disrupt driving safety systems such as ABS (anti-lock braking system) or ESP® (Electronic Stability Program).

- If ABS malfunctions, the wheels can lock during braking. This limits the steerability of the vehicle when braking and the braking distance may increase. There is a risk of accident.
- If ESP® malfunctions, the vehicle will not be stabilised if it starts to skid or a wheel starts to spin. There is a risk of accident.

You should therefore have all work involving the battery carried out at a qualified specialist workshop.

WARNING

Comply with safety precautions and take protective measures when handling batteries.

Risk of explosion



Fire, open flames and smoking are prohibited when handling the battery. Avoid creating sparks.



Battery acid is caustic. Avoid contact with the skin, eyes or clothing.

Wear suitable protective clothing, in particular gloves, an apron and a face mask.

Immediately rinse acid splashes off with clean water. Consult a doctor if necessary.

Wear eye protection.



Keep children away.



Observe this Operator's Manual.



WARNING

Failure to follow these instructions can result in severe injury or death.

Never lean over batteries while connecting. You might get injured.

Battery fluid contains sulfuric acid. Do not allow this fluid to come in contact with eyes, skin or clothing. In case it does, immediately flush affected area with water and seek medical help if necessary.

A battery will also produce hydrogen gas, which is flammable and explosive. Keep flames or sparks away from battery, avoid improper connection of jumper cables, smoking etc.

WARNING

Do not place any metal objects on the battery as this could result in a short circuit.

Use leak-proof batteries only to avoid the risk of acid burns in the event of an accident.

Take care that you do not become statically charged, e.g. by wearing synthetic clothing or

rubbing against textiles. For this reason, you also should not pull or push the battery over carpets or other synthetic materials.

Never touch the battery first. First, touch the outside body of the vehicle in order to release any possible electrostatic charges.

Do not rub the battery with rags or cloths. The battery could explode if touched due to electrostatic charge or due to spark formation.

Environmental note



Batteries contain dangerous substances. It is against the law to dispose of them with the household rubbish. They must be collected separately and recycled to protect the environment.



Dispose of batteries in an environmentally friendly manner. Take discharged batteries to a qualified specialist workshop or a special collection point for used batteries.

 Have the battery checked regularly at a qualified specialist workshop.

Observe the service intervals in the Maintenance Booklet or contact a qualified specialist workshop for more information.

 You should have all work involving the battery carried out at a qualified specialist workshop. In the exceptional case that it is necessary for you to disconnect the battery yourself, make sure that:

- you switch off the engine and remove the key. On vehicles with KEYLESS-GO, ensure that the ignition is switched off. Check that all the indicator lamps in the instrument cluster are off. Otherwise, electronic components, such as the alternator, may be damaged.
- you first remove the negative terminal clamp and then the positive terminal

clamp. Never swap the terminal clamps. Otherwise, the vehicle's electronic system may be damaged.

- in vehicles with automatic transmission, the transmission is locked in position **P** after disconnecting the battery. The vehicle is secured against rolling away. You can then no longer move the vehicle.

The battery and the cover of the positive terminal clamp must be installed securely during operation.

In order for the battery to achieve the maximum possible service life, it must always be sufficiently charged.

The vehicle battery, like other batteries, can discharge over time if you do not use the vehicle. In this case, have the battery disconnected at a qualified specialist workshop. You can also charge the battery with a charger recommended by Mercedes-Benz. Contact a qualified specialist workshop for further information.

Have the battery charge level checked more frequently if you use the vehicle mainly for short trips or if you leave it standing idle for a lengthy period. Consult a qualified specialist workshop if you wish to leave your vehicle parked up for a long period of time.

Only replace a battery with a battery that has been recommended by Mercedes-Benz.

- i** Remove the SmartKey if you park the vehicle and do not require any electrical consumers. The vehicle will then use very little energy, thus conserving battery power.
- i** After an interruption to the power supply, e.g. due to a discharged battery, you must reset the clock (▷ page 289).

Charging the battery

WARNING

Never charge a battery still installed in the vehicle unless a battery charger unit approved

by Mercedes-Benz is being used. Gases may escape during charging and cause explosions that may result in paint damage, corrosion or personal injury.

A battery charger unit specially adapted for Mercedes-Benz vehicles and tested and approved by Mercedes-Benz is available as an accessory. It permits the charging of the battery in its installed position. Contact an authorized Mercedes-Benz Center for further information and availability.

Charge the battery in accordance with the separate instructions for the battery charger.

WARNING

There is a risk of acid burns during the charging process due to the gases which escape from the battery. Do not lean over the battery during the charging process.

WARNING

Battery acid is caustic. Avoid contact with the skin, eyes or clothing.

- !** Only use battery chargers with a maximum charging voltage of 14.8 V.

- !** Only charge the battery using the jump-starting connection point.

The jump-starting connection point is in the engine compartment.

Read the battery charger's operating instructions before charging the battery.

- ▶ Open the hood (▷ page 496).
- ▶ Connect the battery charger to the positive terminal and ground point in the same order as when connecting the donor battery in the jump-starting procedure (▷ page 516).

Jump-starting

 **WARNING**

Failure to follow these directions will cause damage to the electronic components, and can lead to a battery explosion and severe injury or death.

Never lean over batteries while connecting or jump starting. You might get injured.

Battery fluid contains sulfuric acid. Do not allow this fluid to come in contact with eyes, skin or clothing. In case it does, immediately flush affected area with water, and seek medical help if necessary.

A battery will also produce hydrogen gas, which is flammable and explosive. Keep flames or sparks away from battery, avoid improper connection of jumper cables, smoking, etc.

Attempting to jump start a frozen battery can result in it exploding, causing personal injury.

Read all instructions before proceeding.

 **WARNING**

Non-combusted fuel can collect in the exhaust system and ignite. There is a risk of fire. Avoid repeated and lengthy starting attempts.

-  Avoid repeated and lengthy starting attempts. Otherwise, the catalytic converter could be damaged by the non-combusted fuel.

Do not start the vehicle using a rapid charging device. If your vehicle's battery is discharged, the engine can be jump-started from another vehicle or from a second battery using jumper cables. Observe the following points:

- The battery is not accessible in all vehicles. If the other vehicle's battery is not accessible, jump-start the vehicle using a second battery or a jump-starting device.
- You may only jump-start the vehicle when the engine and catalytic converter are cold.
- Do not start the engine if the battery is frozen. Let the battery thaw first.
- Only jump-start from batteries with a 12 V voltage rating.
- Only use jumper cables which have a sufficient cross-section and insulated terminal clamps.
- If the battery is fully discharged, leave the battery that is being used to jump-start connected for a few minutes before attempting to start. This charges the empty battery a little.
- Make sure that the two vehicles do not touch.

Make sure that:

- the jumper cables are not damaged.
- when the jumper cables are connected to the battery, uninsulated sections of the terminal clamp do not come into contact with other metal sections.
- the jumper cables cannot come into contact with parts such as the V-belt pulley or the fan. These parts move when the engine is started and while it is running.
- ▶ Secure the vehicle by applying the electric parking brake.
- ▶ Shift the transmission to position **P**.
- ▶ Turn the SmartKey to position **0** in the ignition lock and remove it (▷ page 135). On vehicles with KEYLESS-GO, make sure the ignition is switched off (▷ page 135). All indicator lamps in the instrument cluster must be off.

- ▶ Switch off all electrical consumers (e.g. radio, blower, etc.).
- ▶ Open the hood (▶ page 496).

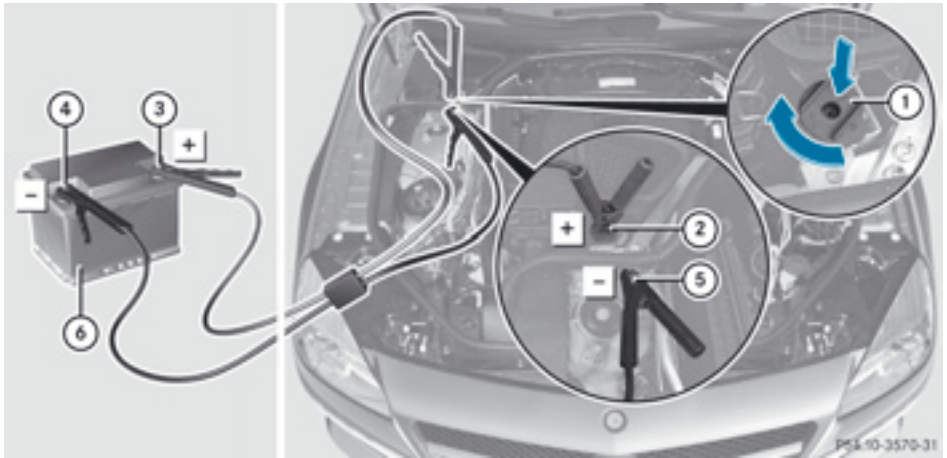

Position number ⑥ identifies the charged battery of the other vehicle or an equivalent jump-starting device.

- ▶ Press cover ① of positive terminal ② down (in the direction of the arrow) and turn it clockwise. Cover ① is held down in the lowered position, which exposes positive terminal ②.
 - ▶ Connect positive terminal ② on your vehicle to positive terminal ③ of donor battery ⑥ using the jumper cable, always begin with positive terminal ② on your own vehicle first.
 - ▶ Start the engine of the donor vehicle and run it at idling speed.
 - ▶ Connect negative terminal ④ of donor battery ⑥ to ground point ⑤ of your vehicle using the jumper cable, connecting the jumper cable to donor battery ⑥ first.
 - ▶ Start the engine.
 - ▶ Before disconnecting the jumper cables, let the engine run for several minutes.
 - ▶ First, remove the jumper cables from ground point ⑤ and negative terminal ④, then from positive terminal ② and positive terminal ③, each time beginning at the contacts on your own vehicle first.
 - ▶ After removing the jumper cables, press down cover ① of positive terminal ② and turn it counter-clockwise. Cover ① returns to its original position. Positive terminal ② is covered up and thus insulated again.
 - ▶ Have the battery checked at a qualified specialist workshop.
- i** Jump-starting is not considered to be a normal operating condition.
- i** Jumper cables and further information regarding jump starting can be obtained at any qualified specialist workshop.

Towing and tow-starting

Important safety notes

WARNING

If you tow the vehicle, you must use a rigid towing bar if:

- the engine is not running.
- there is a brake system malfunction.
- there is a malfunction in the power supply or the vehicle's electrical system.





The power assistance for the steering and the brake force booster do not work when the engine is not running. You will need more force to steer and brake, you may have to depress the brake pedal with maximum force.

Before towing away, make sure that the steering can be moved and is not locked.



If you tow or tow-start another vehicle, its weight must not exceed the maximum permissible gross vehicle weight of your vehicle.

WARNING

The vehicle is braked when the HOLD function or DISTRONIC PLUS is activated. Therefore, deactivate HOLD and DISTRONIC PLUS if the vehicle is to be towed.

-  Only secure the tow rope or tow bar at the towing eyes. Otherwise, the vehicle could be damaged.
-  Do not use the towing eye for recovery, this could damage the vehicle. If in doubt, recover the vehicle with a crane.
-  When towing, pull away slowly and smoothly. If the tractive power is too high, the vehicles could be damaged.
-  Do not tow with sling-type equipment. This could damage the vehicle.
-  When towing vehicles with KEYLESS-GO, use the key instead of the Start/Stop button. Otherwise, the automatic transmission may shift to position **P** when the driver's or front-passenger door are

opened, which could lead to damage to the transmission.

-  The vehicle can be towed a maximum of 30 miles (50km). The towing speed of 30 mph (50 km/h) must not be exceeded. If the vehicle has to be towed more than 30 miles (50km), the entire vehicle must be raised and transported.
-  If you tow or tow-start another vehicle, its weight must not exceed the maximum permissible gross vehicle weight of your vehicle.

Information on your vehicle's gross vehicle weight rating can be found on the vehicle identification plate (▷ page 559).

It is better to have the vehicle transported than to have it towed.

The automatic transmission must be in position **N** when the vehicle is being towed. The battery must be connected and charged. Otherwise, you:

- cannot turn the SmartKey to position **2** in the ignition lock
- cannot shift the automatic transmission to position **N**
-  Deactivate the automatic locking feature (▷ page 218). You could otherwise be locked out when pushing or towing the vehicle.

Installing/removing the towing eye

Installing the towing eye

WARNING

The exhaust tail pipe may be hot. You could burn yourself if you touch the tail pipe. Be particularly careful when removing the rear cover.



Example: towing eye mounting covers

- ① Front cover
- ② Back cover

The mountings for the screw-in towing eyes are located in the bumpers. They are at the front and at the rear, under the covers.

- ▶ Remove the towing eye from the bracket in the trunk (> page 508).
- ▶ **Front bumper:** grip with one finger into the recess on the bottom edge of cover ①.
- ▶ Pull cover ① forward out of the bumper in the direction of the arrow.
Cover ① is fastened with a strap to the opening.
- ▶ **Rear bumper:** push cover ② inwards on the marking in the direction of the arrow.
- ▶ Take cover ② off the opening.
- ▶ Screw the towing eye in clockwise to the stop and tighten it.

Removing the towing eye

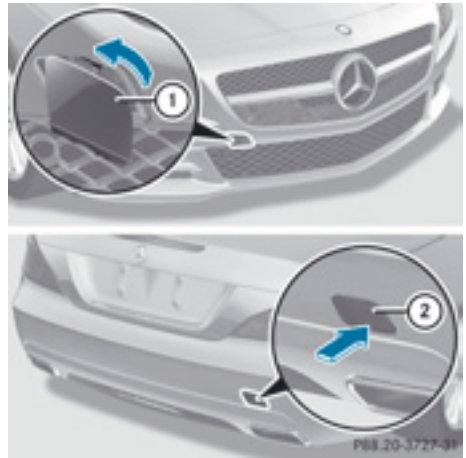

Example: towing eye mounting covers

- ① Front cover
- ② Back cover

- ▶ Loosen the towing eye and unscrew it.
- ▶ **Front bumper:** place cover ① on the opening in the bumper as shown.
- ▶ Screw cover ① into the opening in the direction of the arrow.
Cover ① is now hooked onto the upper edge of the opening.
- ▶ To close, push the lower section of cover ①.
- ▶ **Rear bumper:** place cover ② on the bumper and press it until it engages.
- ▶ Stow the towing eye in the bracket in the trunk (> page 508).

Towing the vehicle with the rear axle raised

- ❗ The ignition must be switched off if you are towing the vehicle with the rear axle raised. Intervention by ESP® could otherwise damage the brake system.

- ▶ Switch on the hazard warning lamps (▷ page 113).
- ▶ Turn the SmartKey to position **0** in the ignition lock and remove the SmartKey from the ignition lock.
- ▶ When leaving the vehicle, take the SmartKey or the KEYLESS-GO key with you.

When towing your vehicle with the rear axle raised, it is important that you observe the safety instructions (▷ page 518).

Towing a vehicle with both axles on the ground

WARNING

The power assistance for the steering and the brake force booster do not work when the engine is not running. You will then need much more effort to brake and steer the vehicle. Adapt your style of driving accordingly.

The automatic transmission automatically shifts to position **P** when you open the driver's or front-passenger door or when you remove the SmartKey from the ignition lock.

In order to ensure that the automatic transmission stays in position **N** when towing the vehicle, you must observe the following points:

- ▶ Switch on the hazard warning lamps (▷ page 113).
- i** In order to signal a change of direction when towing the vehicle with the hazard warning lamps switched on, use the combination switch as usual. In this case, only the turn signals for the desired direction flash. When the combination switch is reset, the hazard warning lamps start flashing again.
- ▶ Make sure that the vehicle is stationary and the SmartKey in the ignition lock is in position **0**.
- ▶ Turn the SmartKey to position **2** in the ignition lock.

On vehicles with KEYLESS-GO, use the SmartKey instead of the Start/Stop button (▷ page 135).

- ▶ Depress and hold the brake pedal.
- ▶ Shift the automatic transmission to position **N**.
- ▶ Release the brake pedal.
- ▶ Release the electric parking brake.
- ▶ Leave the SmartKey in position **2** in the ignition lock.

It is important that you observe the safety instructions when towing away your vehicle (▷ page 518).

Transporting the vehicle

- !** Only lash the vehicle down by the wheels or wheel rims, not by parts of the vehicle such as axle or steering components. Otherwise, the vehicle could be damaged.

The towing eye can be used to pull the vehicle onto a trailer or transporter for transporting purposes.

- ▶ Turn the SmartKey to position **2** in the ignition lock.
- ▶ Shift the automatic transmission to position **N**.

As soon as the vehicle is loaded:

- ▶ Prevent the vehicle from rolling away by applying the electric parking brake.
- ▶ Shift the automatic transmission to position **P**.
- ▶ Turn the SmartKey to position **0** in the ignition lock and remove it.
- ▶ Secure the vehicle.

Tow-starting (emergency starting)

- !** Vehicles with an automatic transmission must not be tow-started. You could otherwise damage the automatic transmission.

Fuses

Important safety notes

WARNING

Only use fuses that have been approved for Mercedes-Benz vehicles and that have the correct fuse rating for the systems concerned. Do not attempt to repair or bridge faulty fuses. Using fuses that have not been approved or attempting to repair or bridge faulty fuses could cause the fuse to be overloaded and result in a fire. Have the cause traced and rectified at a qualified specialist workshop.

- !** Only use fuses that have been approved for Mercedes-Benz vehicles and which have the correct fuse rating for the system concerned. Otherwise, components or systems could be damaged.

The fuses in your vehicle serve to close down faulty circuits. If a fuse blows, all the components on the circuit and their functions stop operating.

Blown fuses must be replaced with fuses of the same rating, which you can recognize by the color and value. The fuse ratings are listed in the fuse allocation chart.

If a newly inserted fuse also blows, have the cause traced and rectified at a qualified specialist workshop, e.g. an authorized Mercedes-Benz Center.

Before changing a fuse

- ▶ Secure the vehicle against rolling away (▷ page 154).
- ▶ Switch off all electrical consumers.
- ▶ Turn the key to position **0** in the ignition lock and remove it (▷ page 135). On vehicles with KEYLESS-GO, make sure the ignition is switched off (▷ page 135). All indicator lamps in the instrument cluster must be off.

The fuses are located in various fuse boxes:

- fuse box in the engine compartment on the right-hand side of the vehicle, when viewed in the direction of travel
- Dashboard fuse box
- Fuse box in the rear

The fuse allocation chart is located in the vehicle tool kit (▷ page 508).

Fuse box in the engine compartment

- !** Make sure that no moisture can enter the fuse box when the cover is open.
- !** When closing the cover, make sure that it is lying correctly on the fuse box. Moisture seeping in or dirt could otherwise impair the operation of the fuses.



- ▶ Open the hood (▷ page 496).
- ▶ Remove any existing moisture from the fuse box using a dry cloth.
- ▶ **To open:** open clamps ②.
- ▶ Fold cover ① upwards in the direction of the arrow and remove it.



- ▶ **To close:** check whether the seal is lying correctly in cover ①.
- ▶ Insert both openings ③ at the rear of cover ① into the brackets on the fuse box. The brackets on the fuse box must be completely visible in the two openings ③ on the fuse box.
- ▶ Fold down cover ①.
- ▶ Hook clamps ② into the fuse box and close.
- ▶ Close the hood (▷ page 497).

Dashboard fuse box

- ❗ Do not use a pointed object such as a screwdriver to open the cover in the dashboard. You could damage the dashboard or the cover.
- ❗ Make sure that no moisture can enter the fuse box when the cover is open.
- ❗ When closing the cover, make sure that it is lying correctly on the fuse box. Moisture seeping in or dirt could otherwise impair the operation of the fuses.



- ▶ **To open:** pull cover ① outwards in the direction of the arrow and remove it.
- ▶ **To close:** clip in cover ① at the front of the dashboard.
- ▶ Fold cover ① inwards until it engages.

Fuse box in the rear

- ❗ Make sure that no moisture can enter the fuse box when the cover is open.
- ❗ When closing the cover, make sure that it is lying correctly on the fuse box. Moisture seeping in or dirt could otherwise impair the operation of the fuses.

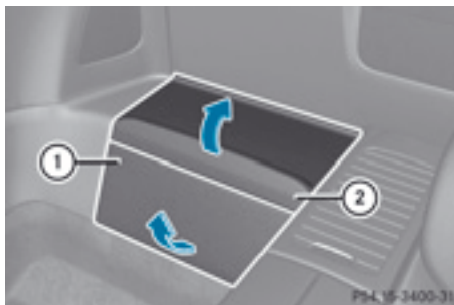

The fuse box in the rear is located on the right-hand side when viewed in the direction of travel.

- ▶ **To open:** open the seat belt guide on the right-hand seat and remove the seat belt (▷ page 99).
- ▶ Move the right-hand front seat as far forward as possible (▷ page 99).
- ▶ Insert your fingers at the bottom of front cover ① between the cover and floor covering.
- ▶ Remove front cover ① towards the front by pulling it in the direction of the arrow.
- ▶ Lift off top cover ② by pulling it in the direction of the arrow.

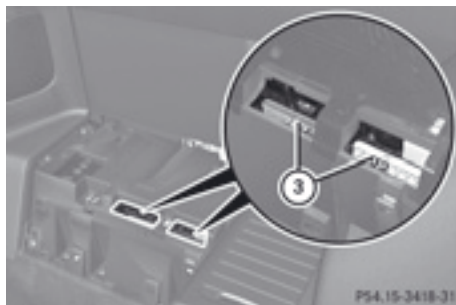

Fuses ③ are accessible through the two openings in the top of the fuse box.

- ▶ **To close:** insert the securing tags underneath top cover ② in the recesses at the top of the fuse box.
- ▶ Fold down top cover ② until it engages audibly.
- ▶ Insert the securing tags underneath top cover ① in the recesses at the front of the fuse box.
- ▶ Push front cover ① towards the rear until it engages audibly.
- ▶ Move the right-hand seat backwards (▷ page 99).
- ▶ Hook the seat belt into the seat belt guide on the right-hand seat (▷ page 99).

Useful information	526
Important safety notes	526
Operation	526
Winter operation	528
Tire pressure	529
Loading the vehicle	537
All about wheels and tires	540
Changing a wheel	547
Wheel and tire combinations	552

Useful information

- i** This Operator's Manual describes all models and all standard and optional equipment of your vehicle available at the time of publication of the Operator's Manual. Country-specific differences are possible. Please note that your vehicle may not be equipped with all features described. This also applies to safety-related systems and functions.
- i** Read the information on qualified specialist workshops: (> page 31).

Important safety notes

WARNING

If wheels and tires of the wrong size are used, the wheel brakes or suspension components may be damaged. There is a risk of accident. Always replace wheels and tires with those that fulfill the specifications of the original part (designation, manufacturer, model).

WARNING

A flat tire severely impairs the driving, steering and braking characteristics of the vehicle. There is a risk of accident.

Tires without run-flat characteristics:

- do not drive with a flat tire.
- immediately replace the flat tire with your emergency spare wheel or spare wheel, or consult a qualified specialist workshop.

Tires with run-flat characteristics:

- pay attention to the information and warning notices on MOExtended tires (tires with run-flat characteristics).

Accessories that are not approved for your vehicle by Mercedes-Benz or are not being used correctly can impair the operating safety.

Before purchasing and using non-approved accessories, visit a qualified specialist workshop and inquire about:

- suitability
- legal stipulations
- factory recommendations

Information on dimensions and types of wheels and tires for your vehicle can be found (> page 552).

Information on air pressure for the tires on your vehicle can be found:

- on the vehicle's Tire and Loading Information placard on the B-pillar
- on the tire pressure label on the fuel filler flap
- under "tire pressure"

Operation

Information on driving

If the vehicle is heavily laden, check the tire pressures and correct them if necessary.

While driving, pay attention to vibrations, noises and unusual handling characteristics, e.g. pulling to one side. This may indicate that the wheels or tires are damaged. If you suspect that a tire is defective, reduce your speed immediately. Stop the vehicle as soon as possible to check the wheels and tires for damage. Hidden tire damage could also be causing the unusual handling characteristics. If you find no signs of damage, have the tires and wheels checked at a qualified specialist workshop.

When parking your vehicle, make sure that the tires do not get deformed by the curb or other obstacles. If it is necessary to drive over curbs, speed humps or similar elevations, try to do so slowly and at an obtuse angle.

Otherwise, the tires, particularly the sidewalls, may be damaged.

Regular checking of wheels and tires

WARNING

Damaged tires can cause tire inflation pressure loss. As a result, you could lose control of your vehicle. There is a risk of accident.

Check the tires regularly for signs of damage and replace any damaged tires immediately.

Regularly check the wheels and tires of your vehicle for damage at least once a month, as well as after driving off-road or on rough roads. Damaged wheels can cause a loss of tire pressure. Pay particular attention to damage such as:

- cuts in the tires
- punctures
- tears in the tires
- bulges on tires
- deformation or severe corrosion on wheels

Regularly check the tire tread depth and the condition of the tread across the whole width of the tire (▷ page 527). If necessary, turn the front wheels to full lock in order to inspect the inner side of the tire surface.

All wheels must have a valve cap to protect the valve against dirt and moisture. Do not mount anything onto the valve other than the standard valve cap or other valve caps approved by Mercedes-Benz for your vehicle. Do not use any other valve caps or systems, e.g. tire pressure monitoring systems.

Regularly check the pressure of all the tires particularly prior to long trips. Adjust the tire pressure as necessary (▷ page 529).

The service life of tires depends on the following factors amongst other things:

- driving style
- tire pressure
- distance covered

Tire tread

WARNING

Insufficient tire tread will reduce tire traction. The tire is no longer able to dissipate water. This means that on wet road surfaces, the risk of hydroplaning increases, in particular where speed is not adapted to suit the driving conditions. There is a risk of accident.

If the tire pressure is too high or too low, tires may exhibit different levels of wear at different locations on the tire tread. Thus, you should regularly check the tread depth and the condition of the tread across the entire width of all tires.

Minimum tire tread depth for:

- Summer tires: $\frac{1}{8}$ in (3 mm)
- M+S tires: $\frac{1}{16}$ in (4 mm)

For safety reasons, replace the tires before the legally prescribed limit for the minimum tire tread depth is reached.

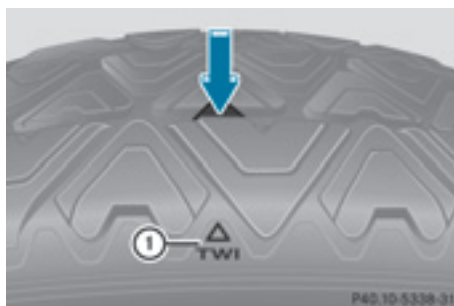

Bar indicator  for tread wear is integrated into the tire tread.

Tread wear indicators (TWI) are required by law. Six indicators are positioned on the tire tread. They are visible once the tread depth is approximately $\frac{1}{16}$ in (1.6 mm). If this is the case, the tire is so worn that it must be replaced.

Selecting, mounting and replacing tires

- Only mount tires and wheels of the same type and make.
- Only mount tires of the correct size onto the wheels.
- Break in new tires at moderate speeds for the first 60 miles (100 km). They only reach their full performance after this distance.
- Do not drive with tires which have too little tread depth. as this significantly reduces the traction on wet roads (hydroplaning).
- Replace the tires after six years at the latest, regardless of wear.

MOExtended tires (tires with run-flat properties)

With MOExtended tires (tires with run flat characteristics), you can continue to drive your vehicle even if there is a total loss of pressure in one or more tires.

MOExtended tires may be used only in conjunction with the activated tire pressure loss warning system or the activated tire pressure monitor and only on wheels specifically tested by Mercedes-Benz.

Notes on driving with MOExtended tires with a flat tire (▷ page 510).

- ❗ Vehicles equipped with MOExtended tires are not equipped with a TIREFIT kit at the factory. It is therefore recommended that you additionally equip your vehicle with a TIREFIT kit if you mount tires that do not feature run-flat properties, e.g. winter tires. A TIREFIT kit can be obtained from a qualified specialist workshop.

Winter operation

General notes

Have your vehicle winterproofed at a qualified specialist workshop at the onset of winter.

Observe the notes in the "Changing a wheel" section (▷ page 547).

Driving with summer tires

At temperatures below 45 °F (+7 °C), summer tires lose elasticity and therefore traction and braking power. Change the tires on your vehicle to M+S tires. Using summer tires at very cold temperatures could cause tears to form, thereby damaging the tires permanently. Mercedes-Benz cannot accept responsibility for this type of damage.

M+S tires

WARNING

M+S tires with a tire tread depth of less than 1/8 in (4 mm) are not suitable for use in winter and do not provide sufficient traction. There is a risk of an accident.

M+S tires with a tread depth of less than 1/8 in (4 mm) must be replaced immediately.

At temperatures below 45 °F (+7 °C), use winter tires or all-season tires. Both types of tire are identified by the M+S marking.

Only winter tires bearing the  snowflake symbol in addition to the M+S marking provide the best possible grip in wintry road conditions.

Only these tires will allow driving safety systems such as ABS and ESP® to function optimally in winter. These tires have been developed specifically for driving in snow.

Use M+S tires of the same make and tread on all wheels to maintain safe handling characteristics.

Always observe the maximum permissible speed specified for the M+S tires you have mounted.

Once the winter tires are mounted:

- ▶ Check the tire pressures (▷ page 533).
- ▶ Restart the tire pressure monitor (▷ page 534).

Snow chains

- !** You must drive at raised vehicle level (level 1) if snow chains have been mounted. The vehicle may otherwise be damaged.
- !** On some tire sizes there is not enough space for snow chains. To avoid damage to the vehicle or tires, observe the "Wheel and tire combinations" section under "Tires and wheels".
- !** If snow chains are mounted on the front wheels, the snow chains could grind against the bodywork or components of the chassis. This could result in damage to the vehicle or the tires.

For safety reasons, Mercedes-Benz recommends that you only use snow chains that have been specially approved for your vehicle by Mercedes-Benz, or are of a corresponding standard of quality.

If you intend to mount snow chains, please bear the following points in mind:

- Snow chains cannot be mounted on all wheel-tire combinations; see the information under "Wheel and tire combinations" in the "Wheels and tires" section.
- Mount snow chains only in pairs and only on the rear wheels. Observe the manufacturer's mounting instructions.
- Only use snow chains when driving on roads completely covered by snow. Remove the snow chains as soon as possible when you come to a road that is not snow-covered.
- Local regulations may restrict the use of snow chains. Observe the relevant regulations when mounting snow chains.

- Do not exceed the maximum permissible speed of 30 mph (50 km/h).
- On vehicles with Active Body Control (ABC), you must drive at a raised vehicle level if snow chains have been mounted (▷ page 179).

- i** You may wish to deactivate ESP® when pulling away with snow chains mounted (▷ page 59). This way you can allow the wheels to spin in a controlled manner, achieving an increased driving force (cutting action).

Tire pressure

Tire pressure specifications

Important safety notes

WARNING

Tires with tire pressures that are too low or too high are associated with the following hazards:

- they can burst, in particular if the vehicle is heavily laden or when driven at high speeds.
- the tires can wear excessively and/or unevenly, which can severely impair tire traction.
- the driving, steering and braking characteristics may be severely impaired.

There is a risk of accident.

Follow recommended tire inflation pressures and check the pressure of all the tires including the spare wheel:

- monthly, at least
- if the load changes
- before beginning a long journey
- under different operating conditions, e.g. off-road driving

If necessary, correct the tire pressure.

- i** The specifications on the sample Tire and Loading Information placard and tire pressure tables are examples. Tire

pressure specifications are vehicle-specific and may deviate from the data shown here. The tire pressure specifications that are valid for your vehicle can be found on the Tire and Loading Information placard and tire pressure table on the vehicle.

General notes

The recommended tire pressures for the tires mounted at the factory can be found on the labels described here.

Further information on tire pressures can be obtained at a qualified specialist workshop.

Tire and Loading Information placard

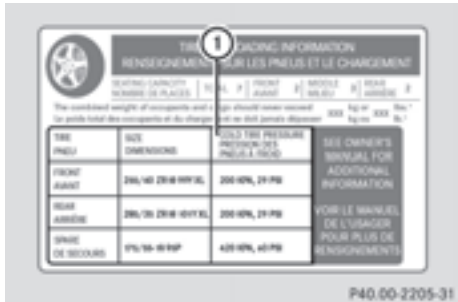

① Recommended tire pressures

The Tire and Loading Information placard is on the B-pillar on the driver's side of the vehicle (▷ page 537).

The Tire and Loading Information placard contains the recommended tire pressures for cold tires. The recommended tire pressures are valid for the maximum permissible load and up to the maximum permissible vehicle speed.

Tire pressure table

The tire pressure table is on the inside of the fuel filler flap.

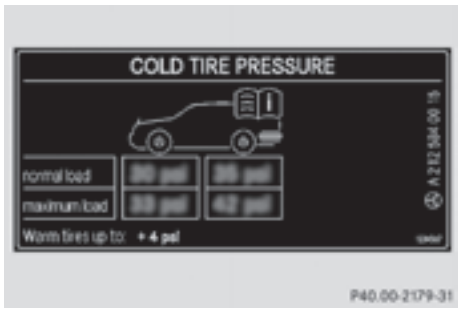

Example: tire pressure table for all tires permitted for this vehicle by the factory

The tire pressure table contains the recommended pressures for cold tires for various operating conditions, i.e. differing load and speed conditions.

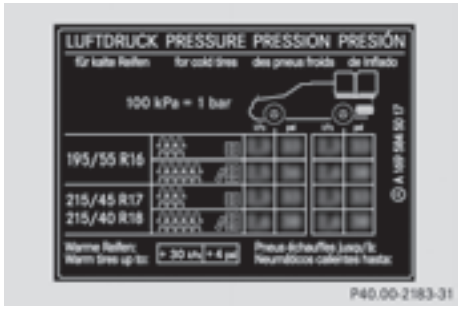

Example: tire pressure table with tire dimensions

If a tire size precedes a tire pressure, the tire pressure information following is only valid for that tire size. The load conditions "partially laden" and "fully laden" are defined in the table for different numbers of passengers and amounts of luggage. The actual number of seats may differ.

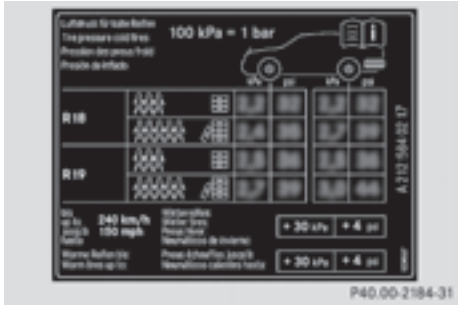

Some tire pressure tables show only the rim diameters instead of the full tire size, e.g.

R18. The rim diameter is part of the tire size and can be found on the tire sidewall (▷ page 541).

If the tire pressures have been set to the lower values for lighter loads and/or lower road speeds, the pressures should be reset to the higher values:

- if you want to drive with an increased load and/or
- if you want to drive at higher road speeds.

i The tire pressures for increased loads and/or higher road speeds, shown in the tire pressure table, may have a negative effect on driving comfort.

If the tire pressure is not set correctly, this can lead to an excessive build up of heat and a sudden loss of pressure.

For more information, contact a qualified specialist workshop.

Important notes on tire pressure

WARNING

If the tire pressure drops repeatedly, the wheel, valve or tire may be damaged. Tire pressure that is too low may result in a tire blow-out. There is a risk of an accident.

- Check the tire for foreign objects.
- Check whether the wheel is losing air or the valve is leaking.

If you are unable to rectify the damage, contact a qualified specialist workshop.

WARNING

If you fit unsuitable accessories onto tire valves, the tire valves may be overloaded and malfunction, which can cause tire pressure loss. Due to their design, retrofitted tire pressure monitors keep the tire valve open. This can also result in tire pressure loss. There is a risk of an accident.

Only screw the standard valve cap or other valve caps approved by Mercedes-Benz for your vehicle onto the tire valve.

Use a suitable pressure gauge to check the tire pressure. The outer appearance of a tire does not permit any reliable conclusion about the tire pressure. On vehicles equipped with the electronic tire pressure monitoring system, the tire pressure can be checked using the on-board computer.

The tire temperature and pressure increase when the vehicle is in motion. This is dependent on the driving speed and the load. Therefore, you should only correct tire pressures when the tires are cold.

The tires are cold:

- if the vehicle has been parked without direct sunlight on the tires for at least three hours and
- if the vehicle has not been driven further than 1 mile (1.6 km)

The tire temperature changes depending on the outside temperature, the vehicle speed and the tire load. If the tire temperature changes by 18 °F (10 °C), the tire pressure changes by approximately 10 kPa (0.1 bar / 1.5 psi). Take this into account when checking the pressure of warm tires. Only correct the tire pressure if it is too low for the current operating conditions. If you check the tire pressure when the tires are warm, the resulting value will be higher than if the tires were cold. This is normal. Do not reduce the tire pressure to the value specified for cold tires. The tire pressure would otherwise be too low.

Observe the recommended tire pressures for cold tires:

- on the Tire and Loading Information placard on the B-pillar on the driver's side
- in the tire pressure table on the inside of the fuel filler flap

Underinflated or overinflated tires

Underinflation

WARNING

Tires with pressure that is too low can overheat and burst as a consequence. In addition, they also suffer from excessive and/or irregular wear, which can severely impair the braking properties and the driving characteristics. There is a risk of an accident. Avoid tire pressures that are too low in all the tires, including the spare wheel.

Underinflated tires may:

- overheat, leading to tire defects
- have an adverse effect on handling characteristics
- wear quickly and unevenly
- have an adverse effect on fuel consumption

Overinflation

WARNING

Tires with excessively high pressure can burst because they are damaged more easily by road debris, potholes etc. In addition, they also suffer from irregular wear, which can severely impair the braking properties and the driving characteristics. There is a risk of an accident.

Avoid tire pressures that are too high in all the tires, including the spare wheel.

Overinflated tires may:

- increase the braking distance
- have an adverse effect on handling characteristics
- wear quickly and unevenly
- have an adverse effect on ride comfort
- be more susceptible to damage

Maximum tire pressures



① Example: maximum permissible tire pressure

Never exceed the maximum permissible tire inflation pressure. Always observe the recommended tire pressure for your vehicle when adjusting the tire pressure ([▷ page 529](#)).

 The actual values for tires are vehicle-specific and may deviate from the values in the illustration.

Checking the tire pressures

Important safety notes

Observe the notes on tire pressure ([▷ page 529](#)).

Information on air pressure for the tires on your vehicle can be found:

- on the vehicle's Tire and Loading Information placard on the B-pillar ([▷ page 537](#))
- on the tire pressure label on the fuel filler flap ([▷ page 153](#))
- in the "Tire pressure information" section ([▷ page 529](#))

Checking tire pressures manually

To determine and set the correct tire pressure, proceed as follows:

- ▶ Remove the valve cap of the tire that is to be checked.
- ▶ Press the tire pressure gauge securely onto the valve.
- ▶ Read the tire pressure and compare it with the recommended value on the Tire and Loading Information placard (▷ page 529).
- ▶ If the tire pressure is too low, increase it to the recommended value.
- ▶ If the tire pressure is too high, release air by pressing down the metal pin in the valve. Use the tip of a pen, for example. Then, check the tire pressure again using the tire pressure gauge.
- ▶ Screw the valve cap onto the valve.
- ▶ Repeat these steps for the other tires.

Tire pressure loss warning system (Canada only)

Important safety notes

While the vehicle is in motion, the tire pressure loss warning system monitors the set tire pressure using the rotational speed of the wheels. This enables the system to detect significant pressure loss in a tire. If the speed of rotation of a wheel changes as a result of a loss of pressure, a corresponding warning message will appear in the multifunction display.

The tire pressure warning system does not warn you of an incorrectly set tire pressure. Observe the notes on the recommended tire pressure (▷ page 529).

The tire pressure loss warning system does not replace the need to regularly check your vehicle's tire pressures, since an even loss of pressure on several tires at the same time cannot be detected by the tire pressure loss warning system.

The tire pressure monitor is not able to warn you of a sudden loss of pressure, e.g. if the tire is penetrated by a foreign object. In the event of a sudden loss of pressure, bring the vehicle to a halt by braking carefully. Avoid abrupt steering maneuvers.

The function of the tire pressure loss warning system is limited or delayed if:

- snow chains are mounted to your vehicle's tires.
- road conditions are wintry.
- you are driving on sand or gravel.
- you adopt a very sporty driving style (cornering at high speeds or driving with high rates of acceleration).
- you drive with a heavy load.



Restarting the tire pressure loss warning system



Restart the tire pressure loss warning system if you have:

- changed the tire pressure
- changed the wheels or tires
- mounted new wheels or tires





- ▶ Before restarting, make sure that the tire pressures are set properly on all four tires for the respective operating conditions. The recommended tire pressures can be found on the Tire and Loading Information placard on the B-pillar on the driver's side or the tire pressure table on the fuel filler flap.

The tire pressure loss warning system can only give reliable warnings if you have set the correct tire pressure. If an incorrect tire pressure is set, these incorrect values will be monitored.

- ▶ Observe the notes on tire pressure (▷ page 529).
- ▶ Make sure that the key is in position **2** (▷ page 135) in the ignition lock.
- ▶ Press  or  on the steering wheel to select the **Service** menu.





- ▶ Press the  or  button to select **Tire Pressure**.
- ▶ Press the  button.
The **Run Flat Indicator Active Press OK to Restart** message appears in the multifunction display.

If you wish to confirm the restart:

- ▶ Press the  button.
The **Tire Pressure Now OK?** message appears in the multifunction display.
- ▶ Press  or  to select **Yes**.
- ▶ Press the  button.
The **Run Flat Indicator Restarted** message appears in the multifunction display.

After a teach-in period, the tire pressure loss warning system will monitor the set tire pressures of all four tires.

If you wish to cancel the restart:

- ▶ Press the  button.
- or
- ▶ If the **Tire Pressure Now OK?** message appears, use  or  to select **Cancel**.
- ▶ Press the  button.
The tire pressure values stored at the last restart will continue to be monitored.

Tire pressure monitor

Important safety notes

WARNING

Each tire, including the spare (if provided), should be checked at least once a month when cold and inflated to the pressure recommended by the vehicle manufacturer on the Tire and Loading Information placard on the driver's door B-pillar or the tire pressure label on the inside of the fuel filler flap. If your vehicle has tires of a different size than the size indicated on the Tire and Loading Information placard or the tire pressure label,

you should determine the proper tire pressure for those tires.

As an added safety feature, your vehicle has been equipped with a tire pressure monitoring system (TPMS) that illuminates a low tire pressure telltale when one or more of your tires are significantly underinflated.

Accordingly, when the low tire pressure telltale illuminates, you should stop and check your tires as soon as possible, and inflate them to the proper pressure. Driving on a significantly underinflated tire causes the tire to overheat and can lead to tire failure. Underinflation also reduces fuel efficiency and tire tread life, and may affect the vehicle's handling and stopping ability.

Please note that the TPMS is not a substitute for proper tire maintenance, and it is the driver's responsibility to maintain correct tire pressure, even if underinflation has not reached the level to trigger illumination of the TPMS low tire pressure telltale.

USA only:

Your vehicle has also been equipped with a TPMS malfunction indicator to indicate if the system is not operating properly. The TPMS malfunction indicator is combined with the low tire pressure telltale. When the system detects a malfunction, the warning lamp will flash for approximately a minute and then remain continuously illuminated. This sequence will be repeated every time the vehicle is started as long as the malfunction exists.

When the malfunction indicator is illuminated, the system may not be able to detect or signal low tire pressure as intended. TPMS malfunctions may occur for a variety of reasons, including the installation of incompatible replacement or alternate tires or wheels on the vehicle that prevent the TPMS from functioning properly. Always check the TPMS malfunction telltale after replacing one or more tires or wheels on your vehicle to ensure that the replacement or

alternate tires and wheels allow the TPMS to continue to function properly.

It is the driver's responsibility to set the tire inflation to the recommended cold tire pressure suitable to the operating situation (▷ page 529). Note that the correct tire pressure for the current operating situation must first be taught-in to the tire pressure monitor. If there is a substantial loss of pressure, the warning threshold for the warning message is aligned to the reference values taught-in. Restart the tire pressure monitor after adjusting to the cold tire pressure. (▷ page 536) The current pressures are saved as new reference values. As a result, a warning message will appear if the tire pressure drops significantly.

The tire pressure monitor does not warn you of an incorrectly set tire pressure. Observe the notes on the recommended tire pressure (▷ page 529).

The tire pressure monitor is not able to warn you of a sudden loss of pressure, e.g. if the tire is penetrated by a foreign object. In the event of a sudden loss of pressure, bring the vehicle to a halt by braking carefully. Avoid abrupt steering maneuvers.

If a tire pressure monitor system is installed, the vehicle's wheels have sensors installed that monitor the tire pressures in all four tires. The tire pressure monitor warns you if the pressure drops in one or more of the tires. The tire pressure monitor only functions if the correct wheel electronics units are installed on each wheel.

The tire pressure monitor has a yellow warning lamp in the instrument cluster for indicating pressure loss/malfunctions (USA) or pressure loss (Canada). Whether the warning lamp flashes or lights up indicates whether a tire pressure is too low or the tire pressure monitor is malfunctioning:

- if the warning lamp is lit continuously, the tire pressure on one or more tires is

significantly too low. The tire pressure monitor is not malfunctioning.

- USA only: if the warning lamp flashes for around a minute and then remains lit constantly, the tire pressure monitor is malfunctioning.

Information on tire pressures is displayed in the multifunction display. After a few minutes of driving, the current tire pressure of each tire is shown in the multifunction display.

USA only: if there is a malfunction with the tire pressure monitor it can take more than ten minutes until the malfunction is shown by the tire pressure warning lamp flashing for approximately one minute and then lighting up continuously. When the malfunction has been rectified, the tire pressure warning lamp goes out after a few minutes of driving.

The tire pressure values indicated by the on-board computer may differ from those measured at a gas station with a pressure gauge. The tire pressures shown by the on-board computer refer to those measured at sea level. At high altitudes, the tire pressure values indicated by a pressure gauge are higher than those shown by the on-board computer. In this case, do not reduce the tire pressures.

The operation of the tire pressure monitor can be affected by interference from radio transmitting equipment (e.g. radio headphones, two-way radios) that may be being operated in or near the vehicle.

i USA only:

This device complies with Part 15 of the FCC Rules. Operation is subject to the following two conditions:

1. This device may not cause harmful interference, and
2. this device must accept any interference received, including interference that may cause undesired operation of the device.

Any unauthorized modification to this device could void the user's authority to operate the equipment.





i Canada only:

This device complies with RSS-210 of Industry Canada. Operation is subject to the following two conditions:

1. This device may not cause harmful interference, and
2. this device must accept any interference received, including interference that may cause undesired operation of the device.

Any unauthorized modification to this device could void the user's authority to operate the equipment.

Checking tire pressure electronically

- ▶ Make sure that the key is in position 2 (▶ page 135) in the ignition lock.
- ▶ Press the  or  button on the steering wheel to select the **Service** menu.
- ▶ Press the  or  button to select **Tire Pressure**.
- ▶ Press the  button.
The current tire pressure for each wheel will be displayed in the multifunction display.

If the vehicle has been parked for over 20 minutes, the message **Tire pressure will be displayed after driving a few minutes** appears.

After a teach-in period, the tire pressure monitor automatically recognizes new wheels or new sensors. As long as a clear allocation of the tire pressure values to the individual wheels is not possible, the **Tire Pressure Monitor Active** display message is shown instead of the tire pressure display. The tire pressures are already being monitored.

Tire pressure monitor warning messages

If the tire pressure monitor detects a significant pressure loss on one or more tires, a warning message is shown in the multifunction display. A warning tone also

sounds and the tire pressure warning lamp lights up in the instrument cluster.

Each tire that is affected by a significant loss of pressure is highlighted in the pressure display.

- ▶ If the **Correct Tire Pressure** message appears in the multifunction display, check the tire pressure on all four wheels and correct it if necessary.



i If the wheel positions on the vehicle are interchanged, the tire pressures may be displayed for the wrong positions for a short time. This is rectified after a few minutes of driving, and the tire pressures are displayed for the correct positions.





Restarting the tire pressure monitor

When you restart the tire pressure monitor, all existing warning messages are deleted and the warning lamps go out. The monitor uses the currently set tire pressures as the reference values for monitoring. In most cases, the tire pressure monitor will automatically detect the new reference values after you have changed the tire pressure. However, you can also define reference values manually as described here.

- ▶ Set the tire pressure to the value recommended for the corresponding driving situation on the Tire and Loading Information placard on the driver's side B-pillar (▶ page 529).

Additional tire pressure values for different loads can also be found on the tire pressure table on the inside of the fuel filler flap (▶ page 529).

- ▶ Make sure that the tire pressure is correct on all four wheels.
- ▶ Make sure that the SmartKey is in position 2 in the ignition lock.
- ▶ Press the  or  button on the steering wheel to select the **Service** menu.

- ▶ Press the  or  button to select **Tire Pressure**.
- ▶ Press the  button.
The multifunction display shows the current tire pressure for the individual tires or the **Tire Pressure will be displayed after driving a few minutes** message.
- ▶ Press the  button.
The **Use Current Pressures As New Reference Values** message appears in the multifunction display.

If you wish to confirm the restart:

- ▶ Press the  button.
The **Tire Press. Monitor Restarted** message appears in the multifunction display.
After driving for a few minutes, the system checks whether the current tire pressures are within the specified range. The new tire pressures are then accepted as reference values and monitored.

If you wish to cancel the restart:

- ▶ Press the  button.
The tire pressure values stored at the last restart will continue to be monitored.

Loading the vehicle

Instruction labels for tires and loads

WARNING

Overloaded tires can overheat, causing a blowout. Overloaded tires can also impair the steering and driving characteristics and lead to brake failure. There is a risk of accident.

Observe the load rating of the tires. The load rating must be at least half of the GAWR of your vehicle. Never overload the tires by exceeding the maximum load.

Two instruction labels on your vehicle show the maximum possible load.

- (1) The Tire and Loading Information placard is on the B-pillar on the driver's side. The Tire and Loading Information placard shows the maximum permissible number of occupants and the maximum permissible vehicle load. It also contains details of the tire sizes and corresponding pressures for tires installed at the factory.
- (2) The vehicle identification plate is on the B-pillar on the driver's side. The vehicle identification plate informs you of the gross vehicle weight rating. It is made up of the vehicle weight, all vehicle occupants, the fuel and the cargo. You can also find information about the maximum gross axle weight rating on the front and rear axle.

The maximum gross axle weight rating is the maximum weight that can be carried by one axle (front or rear axle). Never exceed the maximum load or the maximum gross axle weight rating for the front or rear axle.

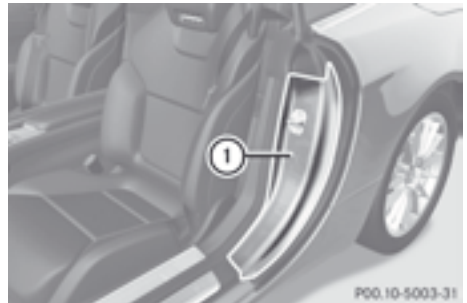

- ① B-pillar, driver's side

Maximum permissible gross vehicle weight rating

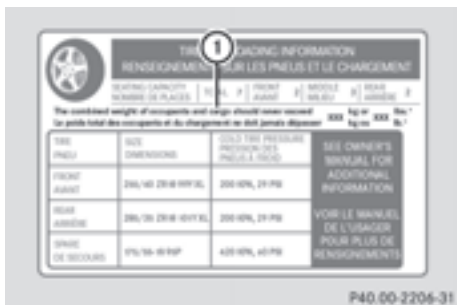

- ▶ The Tire and Loading Information placard gives you details on maximum permissible gross vehicle weight rating (1): "The gross weight of occupants and luggage must never exceed XXX kilograms or XXX pounds."

The gross weight of all vehicle occupants, load and luggage must not exceed the specified value.

- 1 The specifications shown on the Tire and Loading Information placard in the illustration are examples. The maximum permissible gross vehicle weight rating is vehicle-specific and may differ from that in the illustration. You can find the valid maximum permissible gross vehicle weight rating for your vehicle on the Tire and Loading Information placard.

Number of seats

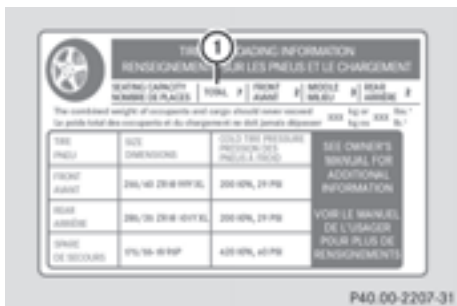

Maximum number of seats (1) determines the maximum number of occupants allowed to travel in the vehicle. This information can be found on the Tire and Loading Information placard.

- 1 The specifications shown on the Tire and Loading Information placard in the illustration are examples. The number of seats is vehicle-specific and can differ from the details shown. The number of seats in your vehicle can be found on the Tire and Loading Information placard.

Determining the correct load limit

Step-by-step instructions

The following steps have been developed as required of all manufacturers under Title 49, Code of U.S. Federal Regulations, Part 575 pursuant to the "National Traffic and Motor Vehicle Safety Act of 1966".

- ▶ **Step 1:** Locate the statement "The combined weight of occupants and cargo should never exceed XXX kg or XXX lbs." on your vehicle's Tire and Loading Information placard.
- ▶ **Step 2:** Determine the combined weight of the driver and passengers that will be riding in your vehicle.
- ▶ **Step 3:** Subtract the combined weight of the driver and passengers from XXX kilograms or XXX lbs.
- ▶ **Step 4:** The resulting figure equals the available amount of cargo and luggage load capacity. For example, if the "XXX" amount equals 1400 lbs and there will be five 150 pound passengers in your vehicle, the amount of available cargo and luggage load capacity is 650 lbs (1400 - 750 (5 x 150) = 650 lbs).
- ▶ **Step 5:** Determine the combined weight of luggage and cargo being loaded on the vehicle. That weight may not safely exceed the available cargo and luggage load capacity calculated in step 4.

Example: steps 1 to 3

The following table shows examples on how to calculate total and cargo load capacities with varying seating configurations and number and size of occupants. The following examples use a maximum load of 1500 lbs (680 kg). **This is for illustration purposes only.** Make sure you are using the actual load limit for your vehicle stated on your vehicle's Tire and Loading Information placard (▷ page 537).

The higher the weight of all the occupants, the smaller the maximum load for luggage.

Step 1

	Example 1	Example 2
Combined maximum weight of occupants and cargo (data from the Tire and Loading Information placard)	1500 lbs (680 kg)	1500 lbs (680 kg)

Step 2

	Example 1	Example 2
Number of people in the vehicle (driver and occupants)	1	2
Weight of the occupants	Occupant 1: 175 lbs (80 kg)	Occupant 1: 175 lbs (80 kg) Occupant 2: 195 lbs (88 kg)
Gross weight of all occupants	175 lbs (80 kg)	370 lbs (168 kg)

Step 3

	Example 1	Example 2
Permissible load (maximum gross vehicle weight rating from the Tire and Loading Information placard minus the gross weight of all occupants)	1500 lbs (680 kg) -175 lbs (80 kg) = 1325 lbs (600 kg)	1500 lbs (680 kg) -370 lbs (168 kg) = 1130 lbs (512 kg)

Vehicle identification plate

Even if you have calculated the total load carefully, you should still make sure that the gross vehicle weight rating and the gross axle weight rating are not exceeded. Details can be found on the vehicle identification plate on the B-pillar on the driver's side of the vehicle (▷ page 537).

Permissible gross vehicle weight: the gross weight of the vehicle, all passengers and the load must not exceed the permissible gross vehicle weight.

Gross axle weight rating: the maximum permissible weight that can be carried by one axle (front or rear axle).

To ensure that your vehicle does not exceed the maximum permissible values (gross vehicle weight and maximum gross axle weight rating), have your loaded vehicle (including driver, occupants and the load) weighed on a suitable vehicle weighbridge.

All about wheels and tires

Uniform Tire Quality Grading Standards

Overview of Tire Quality Grading Standards

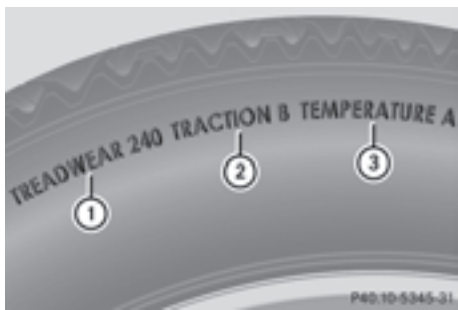

Uniform Tire Quality Grading Standards are U.S. government specifications. Their purpose is to provide drivers with uniform reliable information on tire performance data. Tire manufacturers have to grade tires using three performance factors: treadwear grade ①, traction grade ② and temperature grade ③. These regulations do not apply to Canada. Nevertheless, all tires sold in North America are provided with the corresponding quality grading markings on the sidewall of the tire.

Where applicable, the tire grading information can be found on the tire sidewall between the tread shoulder and maximum tire width.

Example:

- **Treadwear grade:** 200
- **Traction grade:** AA
- **Temperature grade:** A

All passenger car tires must conform to the statutory safety requirements in addition to these grades.

- i** The actual values for tires are vehicle-specific and may deviate from the values in the illustration.

Treadwear

The treadwear grade is a comparative rating based on the wear rate of the tire when tested under controlled conditions on a specified U.S. government course. For example, a tire graded 150 would wear one and one-half times as well on the government course as a tire graded 100.

The relative performance of tires depends upon the actual conditions of their use, however, and may depart significantly from the norm, due to variations in driving habits, service practices and differences in road characteristics and climate conditions.

Traction

WARNING

The traction grade assigned to this tire is based on straight-ahead braking traction tests, and does not include acceleration, cornering, hydroplaning, or peak traction characteristics.

- !** Avoid wheelspin. This can lead to damage to the drive train.

The traction grades, from highest to lowest, are AA, A, B, and C. Those grades represent the tire's ability to stop on a wet surface as measured under controlled conditions on specified government test surfaces of asphalt and concrete. A tire marked C may have poor traction performance.

The safe speed on a wet, snow covered or icy road is always lower than on dry road surfaces.

You should pay special attention to road conditions when temperatures are around freezing point.

Mercedes-Benz recommends a minimum tread depth of $\frac{1}{8}$ in (4 mm) on all four winter tires. Observe the legally required minimum tire tread depth (▷ page 527). Winter tires can reduce the braking distance on snow-covered surfaces in comparison with summer tires. The braking distance is still much further than

on surfaces that are not icy or covered with snow. Take appropriate care when driving. Further information on winter tires (M+S tires) (▷ page 528).

Temperature

WARNING

The temperature grade for this tire is established for a tire that is properly inflated and not overloaded. Excessive speed, underinflation, or excessive loading, either separately or in combination, can cause excessive heat build-up and possible tire failure.

The temperature grades are A (the highest), B, and C. These represent the tire's resistance to the generation of heat and its ability to dissipate heat when tested under controlled conditions on a specified indoor laboratory test wheel. Sustained high temperature can cause the material of the tire to degenerate and reduce tire life, and excessive temperature can lead to sudden tire failure. The grade C corresponds to a level of performance which all passenger car tires must meet under the Federal Motor Vehicle Safety Standard No. 109. Grades B and A represent higher levels of performance on the laboratory test wheel than the minimum required by law.

Tire labeling

Overview

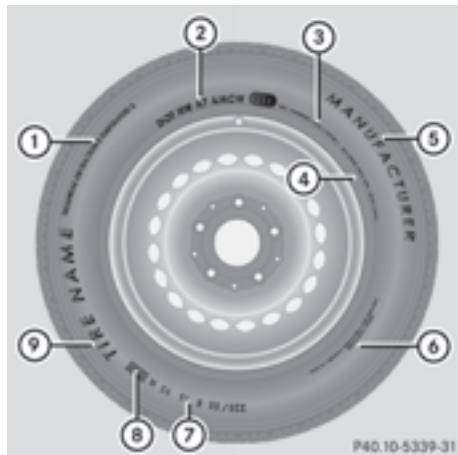

- ① Uniform Tire Quality Grading Standard (▷ page 545)
- ② DOT, Tire Identification Number (▷ page 544)
- ③ Maximum tire load (▷ page 544)
- ④ Maximum tire pressure (▷ page 532)
- ⑤ Manufacturer
- ⑥ Tire material (▷ page 545)
- ⑦ Tire size designation, load-bearing capacity and speed index (▷ page 541)
- ⑧ Load index (▷ page 544)
- ⑨ Tire name

The markings described above are on the tire in addition to the tire name (sales designation) and the manufacturer's name.

-  Tire data is vehicle-specific and may deviate from the data in the example.

Tire size designation, load-bearing capacity and speed rating

WARNING

Exceeding the stated tire load-bearing capacity and the approved maximum speed could lead to tire damage or the tire bursting. There is a risk of accident.

Therefore, only use tire types and sizes approved for your vehicle model. Observe the tire load rating and speed rating required for your vehicle.



- ① Tire width
- ② Nominal aspect ratio in %
- ③ Tire code
- ④ Rim diameter
- ⑤ Load bearing index
- ⑥ Speed rating

General: depending on the manufacturer's standards, the size imprinted in the tire wall may not contain any letters or may contain one letter that precedes the size description.

If there is no letter preceding the size description (as shown above): these are passenger vehicle tires according to European manufacturing standards.

If "P" precedes the size description: these are passenger vehicle tires according to U.S. manufacturing standards.

If "LT" precedes the size description: these are light truck tires according to U.S. manufacturing standards.

If "T" precedes the size description: these are compact emergency spare wheels at high tire pressure, to be used only temporarily in an emergency.

Tire width: tire width ① shows the nominal tire width in millimeters.

Height-width ratio: aspect ratio ② is the size ratio between the tire height and tire width and is shown in percent. The aspect

ratio is calculated by dividing the tire width by the tire height.

Tire code: tire code ③ specifies the tire type. "R" represents radial tires; "D" represents diagonal tires; "B" represents diagonal radial tires.

Optionally, tires with a maximum speed of over 149 mph (240 km/h) may have "ZR" in the size description, depending on the manufacturer (e.g. 245/40 ZR 18).

Rim diameter: rim diameter ④ is the diameter of the bead seat, not the diameter of the rim flange. The rim diameter is specified in inches (in).

Load-bearing index: load-bearing index ⑤ is a numerical code that specifies the maximum load-bearing capacity of a tire.

Do not overload the tires by exceeding the specified load limit. The maximum permissible load can be found on the vehicle's Tire and Loading Information placard on the B-pillar on the driver's side (▷ page 537).

Example:

The load bearing index 91 indicates a maximum load of 1356 lb (615 kg) that the tires can bear. For further information on the maximum tire load in kilograms and pounds, see (▷ page 544).

For further information on the load bearing index, see "Load index" (▷ page 544).



Speed rating: speed rating ⑥ specifies the approved maximum speed of the tire.

i Tire data is vehicle-specific and may deviate from the data in the example.

Regardless of the speed rating, always observe the speed limits. Drive carefully and adapt your driving style to the traffic conditions.

Summer tires	
Index	Speed rating
Q	up to 100 mph (160 km/h)
R	up to 106 mph (170 km/h)
S	up to 112 mph (180 km/h)
T	up to 118 mph (190 km/h)
H	up to 130 mph (210 km/h)
V	up to 149 mph (240 km/h)
W	up to 168 mph (270 km/h)
Y	up to 186 mph (300 km/h)
ZR...Y	up to 186 mph (300 km/h)
ZR...(..Y)	over 186 mph (300 km/h)
ZR	over 149 mph (240 km/h)

- Optionally, tires with a maximum speed of over 149 mph (240 km/h) may have "ZR" in the size description, depending on the manufacturer (e.g. 245/40 ZR18).

The service specification is made up of load-bearing index  and speed rating .



- If the size description of your tire includes "ZR" and there are no service specifications, ask the tire manufacturer in order to find out the maximum speed.

If a service specification is available, the maximum speed is limited according to the speed rating in the service specification. Example: 245/40 ZR 18 97 Y. In this example, "97 Y" is the service specification. The letter "Y" represents the speed rating. The maximum speed of the tire is limited to 186 mph (300 km/h).

- The size description for all tires with maximum speeds of over 186 mph (300 km/h) must include "ZR" **and** the service specification must be given in

parentheses. Example: 275/40 ZR 18 (99 Y). The speed rating "(Y)" indicates that the maximum speed of the tire is over 186 mph (300 km/h). Ask the tire manufacturer about the maximum speed.

All-weather tires and winter tires	
Index	Speed rating
Q M+S ²	up to 100 mph (160 km/h)
T M+S ²	up to 118 mph (190 km/h)
H M+S ²	up to 130 mph (210 km/h)
V M+S ²	up to 149 mph (240 km/h)

-  Not all tires with the M+S marking provide the driving characteristics of winter tires. In addition to the M+S marking, winter tires also have the  snowflake symbol on the tire wall. Tires with this marking fulfill the requirements of the Rubber Manufacturers Association (RMA) and the Rubber Association of Canada (RAC) regarding the tire traction on snow. They have been especially developed for driving on snow.

An electronic speed limiter prevents your vehicle from exceeding the following speeds:

- 130 mph (210 km/h):
 - all vehicles (except AMG vehicles)
- 155 mph (250 km/h):
 - SL 63 AMG
 - SL 65 AMG
- 186 mph (300 km/h):
 - SL 63 AMG (Performance Package)
 - SL 65 AMG with increased maximum speed

² or M+S  for winter tires.

The speed rating of tires mounted at the factory may be higher than the maximum speed that the electronic speed limiter permits.

Make sure that your tires have the required speed rating, e.g. when buying new tires. The required speed rating for your vehicle can be found in the "tires" section (▷ page 552).

Further information about reading tire data can be obtained from any qualified specialist workshop.

Load index



In addition to the load bearing index, load rating ① may be imprinted after the letters that identify speed rating on the sidewall of the tire (▷ page 541).

- If no specification is given: no text (as in the example above), represents a standard load (SL) tire
- XL or Extra Load: represents a reinforced tire
- Light Load: represents a light load tire
- C, D, E: represents a load range that depends on the maximum load that the tire can carry at a certain pressure

① Tire data is vehicle-specific and may deviate from the data in the example.

Maximum load rating

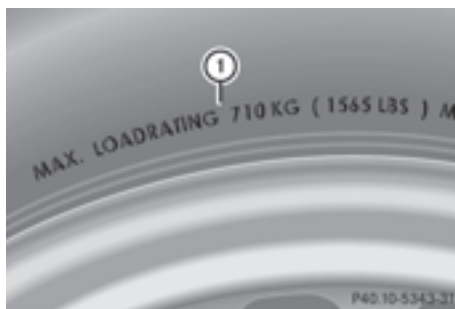

Maximum load rating ① is the maximum permissible weight for which the tire is approved.

Do not overload the tires by exceeding the specified load limit. The maximum permissible load can be found on the vehicle's Tire and Loading Information placard on the B-pillar on the driver's side (▷ page 537).

① The actual values for tires are vehicle-specific and may deviate from the values in the illustration.

DOT, Tire Identification Number (TIN)

U.S. tire regulations prescribe that every tire manufacturer or retreader must imprint a TIN in or on the sidewall of every tire produced.

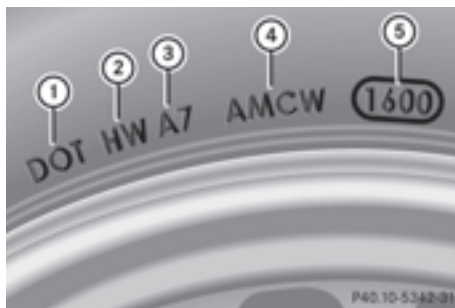

The TIN is a unique identification number. The TIN makes it easier for tire manufacturers or retreaders to notify customers of recalls or other safety-related matters. It makes it

possible for the purchaser to easily identify the affected tires.

The TIN consists of the manufacturer identification code (2), tire size (3), tire type code (4) and manufacturing date (5).

DOT (Department of Transportation): tire symbol (1) indicates that the tire complies with the requirements of the U.S. Department of Transportation.

Manufacturer identification code: manufacturer identification code (2) provides details on the tire manufacturer. New tires have a code with two symbols. Retreaded tires have a code with four symbols.

For further information about retreaded tires, see (▷ page 526).

Tire size: identifier (3) describes the tire size.

Tire type code: tire type code (4) can be used by the manufacturer as a code to describe specific characteristics of the tire.

Date of manufacture: date of manufacture (5) provides information about the age of a tire. The first and second positions represent the week of manufacture, starting with "01" for the first calendar week. Positions three and four represent the year of manufacture. For example, a tire that is marked with "3208", was manufactured in week 32 in 2008.

i Tire data is vehicle-specific and may deviate from the data in the example.

Tire characteristics



This information describes the type of tire cord and the number of layers in sidewall (1) and under tire tread (2).

i Tire data is vehicle-specific and may deviate from the data in the example.

Definition of terms for tires and loading

Tire ply composition and material used

Describes the number of plies or the number of layers of rubber-coated fabric in the tire tread and sidewall. These are made of steel, nylon, polyester and other materials.

Bar

Metric unit for tire pressure.

14.5038 pounds per square inch (psi) and 100 kilopascals (kPa) are the equivalent of 1 bar.

DOT (Department of Transportation)

DOT marked tires fulfill the requirements of the United States Department of Transportation.

Normal occupant weight

The number of occupants which the vehicle is designed for, multiplied by 68 kilograms (150 lb).

Uniform Tire Quality Grading Standards

A uniform standard to grade the quality of tires with regards to tread quality, tire traction and temperature characteristics. Ratings are determined by tire manufacturers using U.S. government testing procedures. The ratings are molded into the sidewall of the tire.

Recommended tire pressure

The recommended tire pressure applies to the tires mounted at the factory.

The Tire and Loading Information placard contains the recommended tire pressures for cold tires on a fully loaded vehicle and for the maximum permissible vehicle speed.

The tire pressure table contains the recommended pressures for cold tires for

various operating conditions, i.e. differing load and speed conditions.

Increased vehicle weight due to optional equipment

This is the combined weight of all standard and optional equipment available for the vehicle, regardless of whether it is actually installed on the vehicle or not.

Rim

This is the part of the wheel on which the tire is mounted.

GAWR (Gross Axle Weight Rating)

The GAWR is the maximum permissible axle weight. The actual load on an axle must never exceed the gross axle weight rating. The gross axle weight rating can be found on the vehicle identification plate on the B-pillar on the driver's side.

Speed rating

The speed rating is part of the tire identification. It specifies the speed range for which the tire is approved.

GVW (Gross Vehicle Weight)

The gross vehicle weight includes the weight of the vehicle including fuel, tools, the spare wheel, accessories installed, occupants, luggage and the drawbar noseweight, if applicable. The gross vehicle weight must not exceed the gross vehicle weight rating GVWR as specified on the vehicle identification plate on the B pillar on the driver's side.

GVWR (Gross Vehicle Weight Rating)

The GVWR is the maximum permissible gross weight of a fully loaded vehicle (the weight of the vehicle including all accessories, occupants, fuel, luggage and the drawbar noseweight, if applicable). The gross vehicle weight rating is specified on the vehicle identification plate on the B-pillar on the driver's side.

Maximum loaded vehicle weight

The maximum weight is the sum of:

- the curb weight of the vehicle
- the weight of the accessories
- the load limit
- the weight of the factory installed optional equipment

Kilopascal (kPa)

Metric unit for tire pressure. 6.9 kPa corresponds to 1 psi. Another unit for tire pressure is bar. There are 100 kilopascals (kPa) to 1 bar.

Load index

In addition to the load-bearing index, the load index may also be imprinted on the sidewall of the tire. This specifies the load-bearing capacity more precisely.

Curb weight

The weight of a vehicle with standard equipment including the maximum capacity of fuel, oil and coolant. It also includes the air-conditioning system and optional equipment if these are installed in the vehicle, but does not include passengers or luggage.

Maximum load rating

The maximum tire load is the maximum permissible weight in kilograms or lbs for which a tire is approved.

Maximum permissible tire pressure

Maximum permissible tire pressure for one tire.

Maximum load on one tire

Maximum load on one tire. This is calculated by dividing the maximum axle load of one axle by two.

PSI (pounds per square inch)

A standard unit of measure for tire pressure.

Aspect ratio

Relationship between tire height and tire width in percent.

Tire pressure

This is pressure inside the tire applying an outward force to each square inch of the tire's surface. The tire pressure is specified in pounds per square inch (psi), in kilopascal (kPa) or in bar. The tire pressure should only be corrected when the tires are cold.

Cold tire pressure

The tires are cold:

- if the vehicle has been parked without direct sunlight on the tires for at least three hours and
- if the vehicle has been driven for less than 1 mile (1.6 km).

Tread

The part of the tire that comes into contact with the road.

Bead

The tire bead ensures that the tire sits securely on the wheel. There are several steel wires in the bead to prevent the tire from coming loose from the wheel rim.

Sidewall

The part of the tire between the tread and the bead.

Weight of optional extras

The combined weight of those optional extras that weigh more than the replaced standard parts and more than 2.3 kilograms (5 lbs). These optional extras, such as high-performance brakes, level control, a roof rack or a high-performance battery, are not included in the curb weight and the weight of the accessories.

TIN (Tire Identification Number)

This is a unique identifier which can be used by a tire manufacturer to identify tires, for example for a product recall, and thus identify

the purchasers. The TIN is made up of the manufacturer's identity code, tire size, tire type code and the manufacturing date.

Load bearing index

The load bearing index (also load index) is a code that contains the maximum load bearing capacity of a tire.

Traction

Traction is the result of friction between the tires and the road surface.

Treadwear indicators

Narrow bars (tread wear bars) that are distributed over the tire tread. If the tire tread is level with the bars, the wear limit of $\frac{1}{16}$ in (1.6 mm) has been reached.

Occupant distribution

The distribution of occupants in a vehicle at their designated seating positions.

Total load limit

Rated cargo and luggage load plus 68 kilograms (150 lb) multiplied by the number of seats in the vehicle.

Changing a wheel**Flat tire**

Information on the procedure in the event of a flat tire ([▷](#) page 509). You will also find information on driving with MOExtended tires in the event of a flat tire.

Interchanging the wheels**⚠ WARNING**

Interchanging the front and rear wheels may severely impair the driving characteristics if the wheels or tires have different dimensions. The wheel brakes or suspension components may also be damaged. There is a risk of accident.

Rotate front and rear wheels only if the wheels and tires are of the same dimensions.

! On vehicles equipped with a tire pressure monitor, electronic components are located in the wheel.

Tire-mounting tools should not be used near the valve. This could damage the electronic components.

Only have tires changed at a qualified specialist workshop.

Always pay attention to the instructions and safety notes when changing a wheel (▷ page 548).

The wear patterns on the front and rear tires differ, depending on the operating conditions. Rotate the wheels before a clear wear pattern has formed on the tires. Front tires typically wear more on the shoulders and the rear tires in the center.

If your vehicle's tire configuration allows, you can rotate the wheels according to the intervals in the tire manufacturer's warranty book in your vehicle documents. If this is not available, the tires should then be replaced every 3000 to 6000 miles (5000 to 10,000 km), or earlier if the tire wear requires this. Do not change the direction of wheel rotation.

Clean the contact surfaces of the wheel and the brake disc thoroughly every time a wheel is interchanged. Check the tire pressure and, if necessary, restart the tire pressure loss warning system or the tire pressure monitor.

Direction of rotation

Tires with a specified direction of rotation have additional benefits, e.g. if there is a risk of hydroplaning. You will only gain these benefits if the correct direction of rotation is maintained.

An arrow on the sidewall of the tire indicates its correct direction of rotation.

Storing wheels

Store wheels that are not being used in a cool, dry and preferably dark place. Protect the tires from oil, grease, gasoline and diesel.

Cleaning the wheels

WARNING

Do not use power washers with circular-jet nozzles (dirt grinders) to clean your vehicle, in particular the tires. You could otherwise damage the tires and cause an accident.

Mounting a wheel

Preparing the vehicle

- ▶ Stop the vehicle on solid, non-slippery and level ground.
- ▶ Unload the vehicle. The jack can only be used when the vehicle is unladen.
- ▶ Apply the electric parking brake manually.
- ▶ Bring the front wheels into the straight-ahead position.
- ▶ Shift the transmission to position **P**.
- ▶ Switch off the engine.
- ▶ **Vehicles without KEYLESS-GO:** remove the SmartKey from the ignition lock.
- ▶ **Vehicles with KEYLESS-GO:** open the driver's door.
The on-board electronics have status **0**, which is the same as the SmartKey having been removed.
- ▶ **Vehicles with KEYLESS-GO:** remove the Start/Stop button from the ignition lock (▷ page 135).
- ▶ If included in the vehicle equipment, remove the tire-change tool kit from the vehicle.
- ▶ Secure the vehicle to prevent it from rolling away.

Securing the vehicle to prevent it from rolling away

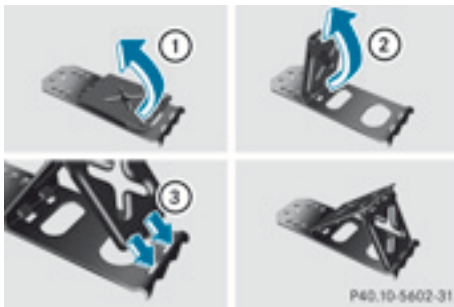

If your vehicle is equipped with a wheel chock, it can be found in the tire-change tool kit (▷ page 508).

The folding wheel chock is an additional securing measure to prevent the vehicle from rolling away, for example when changing a wheel.

- ▶ Fold both plates upwards ①.
- ▶ Fold out lower plate ②.
- ▶ Guide the lugs on the lower plate fully into the openings in base plate ③.

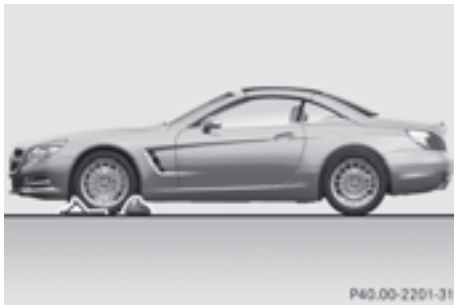

Securing the vehicle on level ground

- ▶ **On level ground:** place chocks or other suitable items under the front and rear of the wheel that is diagonally opposite the wheel you wish to change.

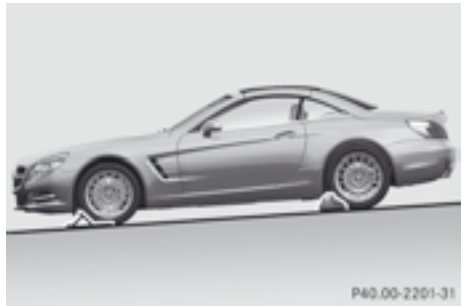

Securing the vehicle on slight downhill gradients

- ▶ **On light downhill gradients:** place chocks or other suitable items in front of the wheels of the front and rear axle.

Raising the vehicle

⚠ WARNING

If you do not position the jack correctly at the appropriate jacking point of the vehicle, the jack could tip over with the vehicle raised. There is a risk of injury.

Only position the jack at the appropriate jacking point of the vehicle. The base of the jack must be positioned vertically, directly under the jacking point of the vehicle.

- ❗ The jack is designed exclusively for jacking up the vehicle at the jacking points. Otherwise, your vehicle could be damaged.

The following must be observed when raising the vehicle:

- to raise the vehicle, only use the vehicle-specific jack that has been tested and approved by Mercedes-Benz. If used incorrectly, the jack could tip over with the vehicle raised.
- the jack is designed only to raise and hold the vehicle for a short time while a wheel is being changed. It is not suited for performing maintenance work under the vehicle.
- avoid changing the wheel on uphill and downhill slopes.

- before raising the vehicle, secure it from rolling away by applying the parking brake and inserting wheel chocks. Never disengage the parking brake while the vehicle is raised.
- the jack must be placed on a firm, flat and non-slip surface. On a loose surface, a large, load-bearing underlay must be used. On a slippery surface, a non-slip underlay must be used, e.g. rubber mats.
- do not use wooden blocks or similar objects as a jack underlay. Otherwise, the jack will not be able to achieve its load-bearing capacity due to the restricted height.
- make sure that the distance between the underside of the tires and the ground does not exceed 1.2 in (3 cm).
- never place your hands and feet under the raised vehicle.
- never lie under the raised vehicle.
- never start the engine when the vehicle is raised.
- never open or close a door or the trunk lid when the vehicle is raised.
- make sure that no persons are present in the vehicle when the vehicle is raised.

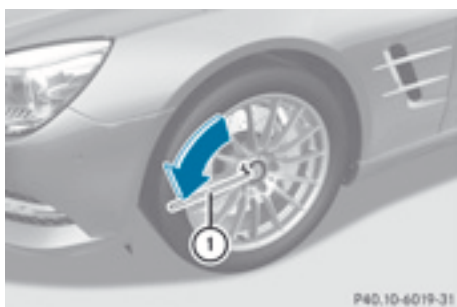

- Using lug wrench ①, loosen the bolts on the wheel you wish to change by about one full turn. Do not unscrew the bolts completely.

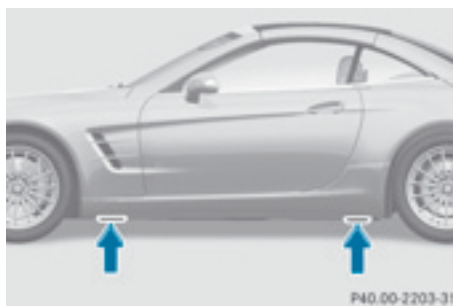

The jacking points are located just behind the front wheel housings and just in front of the rear wheel housings (arrows).



Covers, front (example: vehicles with AMG equipment)

AMG vehicles and vehicles with AMG equipment: to protect the vehicle body, the vehicle has covers next to the jacking points on the outer sills.

- **AMG vehicles and vehicles with AMG equipment:** fold cover ② upwards.

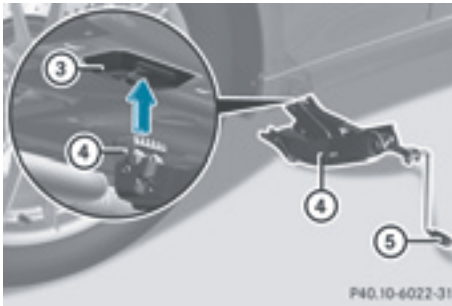

- ③ Jacking points
- ④ Jack
- ⑤ Crank

► Position jack ④ at jacking point ③.

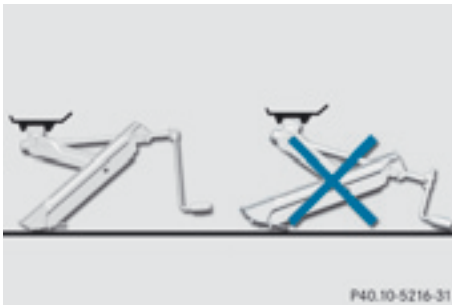

Example

- Make sure the foot of the jack is directly beneath the jacking point.
- Turn crank ⑤ clockwise until jack ④ sits completely on jacking point ③ and the base of the jack lies evenly on the ground.
- Turn crank ⑤ until the tire is raised a maximum of 1.2 in (3 cm) off the ground.

Removing a wheel

! **AMG vehicles:** during removal and repositioning of the wheel, the wheel rim can strike the ceramic-brake disc and damage it. Therefore, take precautions and get a second person to assist you. Alternatively, you can use a second alignment bolt.

! Do not place wheel bolts in sand or on a dirty surface. The bolt and wheel hub threads could otherwise be damaged when you screw them in.

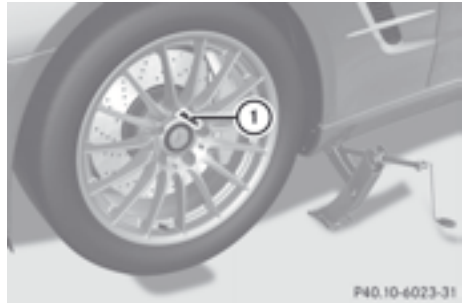

- Unscrew the uppermost wheel bolt completely.
- Screw alignment bolt ① into the thread instead of the wheel bolt.
- Unscrew the remaining wheel bolts fully.
- Remove the wheel.

Mounting a new wheel

WARNING

Oiled or greased wheel bolts or damaged wheel bolts/hub threads can cause the wheel bolts to come loose. As a result, you could lose a wheel while driving. There is a risk of accident.

Never oil or grease wheel bolts. In the event of damage to the threads, contact a qualified specialist workshop immediately. Have the damaged wheel bolts or hub threads replaced/renewed. Do not continue driving.

WARNING

If you tighten the wheel bolts or wheel nuts when the vehicle is raised, the jack could tip over. There is a risk of injury.

Only tighten the wheel bolts or wheel nuts when the vehicle is on the ground.

Always pay attention to the instructions and safety notices in "Changing a wheel" (> page 547).

Only use wheel bolts that have been designed for the wheel and the vehicle. For safety reasons, Mercedes-Benz recommends that you only use wheel bolts which have been approved for Mercedes-Benz vehicles and the respective wheel.

! **AMG vehicles:** during removal and repositioning of the wheel, the wheel rim can strike the ceramic-brake disc and damage it. Therefore, take precautions and get a second person to assist you. Alternatively, you can use a second alignment bolt.

! To prevent damage to the paintwork, hold the wheel securely against the wheel hub while screwing in the first wheel bolt.

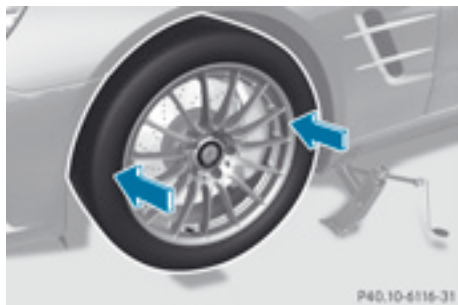

- ▶ Clean the wheel and wheel hub contact surfaces.
- ▶ Slide the wheel to be mounted onto the alignment bolt and push it on.
- ▶ Tighten the wheel bolts until they are finger-tight.
- ▶ Unscrew the alignment bolt.
- ▶ Tighten the last wheel bolt until it is finger-tight.

Lowering the vehicle

WARNING

The wheels could work loose if the wheel nuts and bolts are not tightened to the specified tightening torque. There is a risk of accident.

Have the tightening torque immediately checked at a qualified specialist workshop after a wheel is changed.



- ▶ Turn the crank of the jack counter-clockwise until the vehicle is once again standing firmly on the ground.
 - ▶ Place the jack to one side.
 - ▶ Tighten the wheel bolts evenly in a crosswise pattern in the sequence indicated (① to ⑤). The specified tightening torque is **96 lb-ft (130 Nm)**.
 - ▶ Turn the jack back to its initial position.
 - ▶ Stow the jack and the rest of the vehicle tools in the trunk again.
 - ▶ **AMG vehicles and vehicles with AMG equipment:** insert the cover into the outer sill.
 - ▶ Check the tire pressure of the newly mounted wheel and adjust it if necessary. Make sure to observe the recommended tire pressure (▷ page 529).
- i** Vehicles with tire pressure monitor: all wheels mounted must be equipped with functioning sensors.

Wheel and tire combinations

General notes

- !** For safety reasons, Mercedes-Benz recommends that you only use tires and wheels which have been approved by Mercedes-Benz specifically for your vehicle.

These tires have been specially adapted for use with the control systems, such as ABS or ESP®, and are marked as follows:

- MO = Mercedes-Benz Original
- MOE = Mercedes-Benz Original Extended (tires featuring run-flat characteristics)
- MO 1 = Mercedes-Benz Original (only certain AMG tires)

Mercedes-Benz Original Extended tires may only be used on wheels that have been specifically approved by Mercedes-Benz.

Only use tires, wheels or accessories tested and approved by Mercedes-Benz. Certain characteristics, e.g. handling, vehicle noise emissions or fuel consumption, may otherwise be adversely affected. In addition, when driving with a load, tire dimension variations could cause the tires to come into contact with the bodywork and axle components. This could result in damage to the tires or the vehicle.

Mercedes-Benz accepts no liability for damage resulting from the use of tires, wheels or accessories other than those tested and approved.

Information on tires, wheels and approved combinations can be obtained from any qualified specialist workshop.

Overview of abbreviations used in the following tire tables:

- BA: both axles
- FA: front axle
- RA: rear axle

The recommended pressures for various operating conditions can be found:

- on the Tire and Loading Information placard with the recommended tire pressures on the B-pillar on the driver's side
- in the tire pressure table on the inside of the fuel filler flap

Observe the notes on recommended tire pressures under various operating conditions (▷ page 529).

Check tire pressures regularly, and only when the tires are cold. Comply with the maintenance recommendations of the tire manufacturer in the vehicle document wallet. Notes on the vehicle equipment – always equip the vehicle with:

- tires of the same size on a given axle (left/right)
- the same type of tires at a given time (summer tires, winter tires, MOExtended tires)

Vehicles equipped with MOExtended tires are not equipped with a TIREFIT kit at the factory. It is therefore recommended that you additionally equip your vehicle with a TIREFIT kit if you mount tires that do not feature run-flat properties, e.g. winter tires. A TIREFIT kit may be obtained from a qualified specialist workshop.

i Not all wheel and tire combinations are available ex factory for all countries.

i On the following pages, you can find information on approved wheel rims and tire sizes for equipping your vehicle with winter tires. Winter tires are not available ex factory as standard equipment or optional extras.

If you would like to equip your vehicle with approved winter tires, you may also, in certain circumstances, require rims of the appropriate size. The sizes of the approved winter tires may deviate from that of the standard tires. This is dependent on the model and the equipment installed at the factory.

The tires and wheel rims, as well as further information, can be obtained at a qualified specialist workshop.

Tires

SL 550 BlueEFFICIENCY

Summer tires

R18

Tires	Alloy wheels
FA: 255/40 R18 95 Y RA: 285/35 R18 97 Y ³	FA: 8.5 J x 18 H2 Wheel offset: 1.40 in (35.5 mm) RA: 9.5 J x 18 H2 Wheel offset: 1.87 in (47.5 mm)
FA: 255/40 R18 95 Y MOExtended RA: 285/35 R18 97 Y MOExtended ³	FA: 8.5 J x 18 H2 Wheel offset: 1.40 in (35.5 mm) RA: 9.5 J x 18 H2 Wheel offset: 1.87 in (47.5 mm)



R19

Tires	Alloy wheels
FA: 255/35 R19 96 Y XL RA: 285/30 R19 98 Y XL ³	FA: 8.5 J x 19 H2 Wheel offset: 1.40 in (35.5 mm) RA: 9.5 J x 19 H2 Wheel offset: 1.87 in (47.5 mm)
FA: 255/35 R19 96 Y XL MOExtended RA: 285/30 R19 98 Y XL MOExtended ³	FA: 8.5 J x 19 H2 Wheel offset: 1.40 in (35.5 mm) RA: 9.5 J x 19 H2 Wheel offset: 1.87 in (47.5 mm)
FA: 255/35 ZR 19 96 Y XL RA: 285/30 ZR19 98 Y XL ³	FA: 8.5 J x 19 H2 Wheel offset: 1.40 in (35.5 mm) RA: 9.5 J x 19 H2 Wheel offset: 1.89 in (48 mm)

³ The use of snow chains is not permissible. Observe the notes in the "Snow chains" section.

Winter tires

R18

Tires	Alloy wheels
BA: 255/40 R18 99 V XL M+S 	BA: 8.5 J x 18 H2 Wheel offset: 1.40 in (35.5 mm)
BA: 255/40 R18 99 V XL M+S  MOExtended	BA: 8.5 J x 18 H2 Wheel offset: 1.40 in (35.5 mm)

R19

Tires	Alloy wheels
BA: 255/35 R19 96 V XL M+S 	BA: 8.5 J x 19 H2 Wheel offset: 1.40 in (35.5 mm)
FA: 255/35 R19 96 V XL M+S  RA: 285/30 R19 98 V XL M+S  ³	FA: 8.5 J x 19 H2 Wheel offset: 1.40 in (35.5 mm) RA: 9.5 J x 19 H2 Wheel offset: 1.89 in (48 mm)

AMG vehicles

Summer tires



R19/R20

Tires	Alloy wheels
FA: 255/35 ZR19 (96 Y) XL RA: 285/30 ZR19 (98 Y) XL ³	FA: 9.0 J x 19 H2 Wheel offset: 1.06 in (27 mm) RA: 10.0 J x 19 H2 Wheel offset: 1.89 in (48 mm)
FA: 255/35 ZR19 (96 Y) XL RA: 285/30 ZR20 (99 Y) XL ³	FA: 9.0 J x 19 H2 Wheel offset: 1.06 in (27 mm) RA: 10.0 J x 20 H2 Wheel offset: 1.89 in (48 mm)

³ The use of snow chains is not permissible. Observe the notes in the "Snow chains" section.

Winter tires

R19

Tires	Alloy wheels
FA: 255/35 R19 96 V XL M+S 	FA: 9.0 J x 19 H2
RA: 285/30 R19 98 V XL M+S 	Wheel offset: 1.06 in (27 mm)
	RA: 10.0 J x 19 H2
	Wheel offset: 1.89 in (48 mm)

Useful information	558
Information regarding technical data	558
Genuine Mercedes-Benz parts	558
Warranty	558
Identification plates	559
Service products and filling capacities	560
Vehicle data	565

Useful information

- i** This Operator's Manual describes all models and all standard and optional equipment of your vehicle available at the time of publication of the Operator's Manual. Country-specific differences are possible. Please note that your vehicle may not be equipped with all features described. This also applies to safety-related systems and functions.
- i** Read the information on qualified specialist workshops: (> page 31).

Information regarding technical data

- i** The data stated here specifically refers to a vehicle with standard equipment. Consult a Mercedes-Benz Center for the data for all vehicle variants and trim levels.

Genuine Mercedes-Benz parts

WARNING

Driving safety may be impaired if non-approved parts, tires and wheels or safety-relevant accessories are used.

This could lead to malfunctions in safety-relevant systems, e.g. the brake system. This could cause you to lose control of your vehicle and cause an accident.

For this reason, Mercedes-Benz recommends that you use genuine Mercedes-Benz parts or parts of equal quality. Only use tires, wheels and accessories that have been specifically approved for your vehicle.

Environmental note

Daimler AG also supplies reconditioned major assemblies and parts which are of the same quality as new parts. They are covered by the same Limited Warranty entitlements as new parts.

! Air bags and Emergency Tensioning Devices, as well as control units and sensors for these restraint systems, may be installed in the following areas of your vehicle:

- doors
- door pillars
- door sills
- seats
- cockpit
- instrument cluster
- center console

Do not install accessories such as audio systems in these areas. Do not carry out repairs or welding. You could impair the operating efficiency of the restraint systems.

Have aftermarket accessories installed at a qualified specialist workshop.

Genuine Mercedes-Benz parts are subject to strict quality control. Each part has been specially developed, manufactured or selected for Mercedes-Benz vehicles and fine-tuned for them. Only genuine Mercedes-Benz parts should therefore be used.

More than 300,000 different genuine Mercedes-Benz parts are available for Mercedes-Benz models.

All Mercedes-Benz Centers maintain a supply of genuine Mercedes-Benz parts for necessary service and repair work. In addition, strategically located parts delivery centers provide quick and reliable parts service.

Always specify the vehicle identification number (VIN) (> page 559) and the engine number (> page 560) when ordering genuine Mercedes-Benz parts.

Warranty

Your vehicle is covered under the terms of the warranties printed in the Service and Warranty Information booklet.

Your authorized Mercedes-Benz Center replaces and repairs all factory-fitted parts in accordance with the following warranty terms and conditions:

- New Vehicle Limited Warranty
- Emission Systems Warranty
- Emission Performance Warranty
- California, Connecticut, Maine, Massachusetts, New York, Pennsylvania, Rhode Island and Vermont Emission Control System Warranty
- State warranty enforcement laws (Lemon Laws)

Replacement parts and accessories are covered by the Mercedes-Benz Parts and Accessories warranties. These are available at any authorized Mercedes-Benz Center.

- i** If you lose the Service and Warranty Information booklet, contact an authorized Mercedes-Benz Center to arrange a replacement. The new Service and Warranty Information booklet will be mailed to you.

Identification plates

Vehicle identification plate with vehicle identification number (VIN)



- Open the driver's door. You will see the vehicle identification plate ①.



Example: vehicle identification plate (USA only)



Example: vehicle identification plate (Canada only)

- ② VIN
- ③ Paint code
- i** The data shown on the vehicle identification plate is used only as an example. This data is different for every vehicle and can deviate from the data shown here. You can find the data applicable to your vehicle on the vehicle's identification plate.

VIN



- ▶ Move the front-passenger front seat to its rearmost position.
- ▶ Fold up floor covering ① in front of the front-passenger seat.
You will see the VIN ② stamped into the vehicle body.

The VIN can also be found in the following locations:

- on the vehicle identification plate
(▷ page 559)
- on the lower edge of the windshield
(▷ page 560)

Engine number



- ① Emission control information plate, including the certification of both federal and Californian emissions standards
- ② Engine number (stamped into the crankcase)
- ③ VIN (on the lower edge of the windshield)

Service products and filling capacities

Important safety notes

⚠ WARNING
Comply with all valid regulations with respect to handling, storing and disposing of service fluids. Otherwise, you could endanger persons or the environment.
Keep service fluids out of the reach of children.

For health reasons, you should prevent service fluids from coming into direct contact with your skin or clothing.
If a service fluid is swallowed, contact a physician immediately.

♻ Environmental note
Dispose of service products in an environmentally responsible manner.

Service products include the following:

- fuels
- lubricants (e.g. engine oil, transmission oil)
- coolant
- brake fluid
- windshield washer fluid
- climate control system refrigerant

Vehicle components and their respective lubricants must match. Therefore only use products tested and approved by Mercedes-Benz.

Information about tested and approved products can be obtained from an authorized Mercedes-Benz Center or on the Internet at <http://bevo.mercedes-benz.com>.

You can recognize service products approved by Mercedes-Benz by the following inscription on the containers:

- MB-Freigabe (e.g. MB-Freigabe 229.51)
- MB Approval (e.g. MB Approval 229.51)

Other designations or recommendations indicate a level of quality or a specification in accordance with an MB Sheet number (e.g. MB 229.5). They have not necessarily been approved by Mercedes-Benz.

Tank capacity

Total capacity	
All models	19.8 US gal (75.0 l)

Of which reserve	
SL 550 BlueEFFICIENCY	approximately 2.4 US gal (9.0 l)
AMG vehicles	approximately 3.7 US gal (14.0 l)

Fuel

Important safety notes

WARNING

Gasoline is highly flammable and poisonous. It burns violently and can cause serious personal injury.

Never allow sparks, flames or smoking materials near gasoline.

Turn off the engine before refueling.

Whenever you are around gasoline, avoid inhaling fumes and any skin or clothing contact.

Direct skin contact with fuels and the inhalation of fuel vapors are damaging to your health.

Gasoline

Fuel grade

! Do not use diesel to refuel vehicles with a gasoline engine. Even small amounts of the wrong fuel result in damage to the fuel system and engine.

! You should only refuel with unleaded premium-grade gasoline as this avoids damaging the catalytic converter.

If engine running problems are apparent, have the cause checked immediately and repaired. Excess unburned fuel can otherwise enter the catalytic converter, leading to overheating and possibly causing a fire.

! To ensure the longevity and full performance of the engine, only premium-grade unleaded gasoline may be used. If there is no premium-grade unleaded gasoline available and regular unleaded gasoline must be used, please observe the following precautions:

- only fill the fuel tank to half full with regular unleaded gasoline and fill the rest with premium-grade unleaded gasoline as soon as possible.
- do not drive at the maximum speed.
- avoid sudden acceleration.
- if the vehicle is carrying a light load, e.g. two passengers without luggage, do not allow the engine to rev above 3000 rpm.
- if the vehicle is fully loaded or is being operated in mountainous terrain, do not depress the accelerator pedal further than $\frac{2}{3}$ of the pedal travel.

Only refuel using unleaded gasoline with a minimum octane rating of 91.

Reformulated Gasoline (RFG) and/or unleaded gasoline with additives can be used. The concentration of additives in the fuel must, however, remain below 10 %, such as:

- Ethanol
- TAME
- ETBE
- IPA
- TBA

For MTBE, the concentration should not exceed 15 %.

The concentration of methanol in gasoline including other additives must not exceed 3 %.

Using mixtures of methanol and ethanol is not permitted. Gasohol, a mixture of 10 % ethanol and 90 % unleaded gasoline, can be used.

All of these mix fuels must fulfill the fuel requirements, e.g.:

- knock resistance
- boiling point
- vapor pressure

You will usually find information about the fuel grade on the pump. If you cannot find the label on the pump, ask the staff for assistance.

- i** For further information, consult an authorized Mercedes-Benz Center or on the Internet at <http://www.mbusa.com> (USA only).

Information on refueling (> page 152).

Additives in gasoline

- !** Do not refuel with low-grade fuel and do not use fuel additives that are not tested and approved for Mercedes-Benz vehicles. Damage to or malfunctions of the fuel system may otherwise occur.

One of the main problems of poor fuel quality is the forming of deposits that are created during the gasoline combustion process. Mercedes-Benz recommends that you use branded fuels that have additives.

If you use fuels without these additives over a longer period of time, carbon deposits may build up. These deposits form at the inlet valves and in the combustion chamber in particular.

This could lead to engine problems, e.g.:

- longer engine warm-up phase
- uneven idle
- engine noise
- misfiring
- loss of power

Carbon deposits may form if the availability of gasoline with relevant additives is insufficient (in certain regions). In this case, Mercedes-Benz recommends additives approved for use in Mercedes-Benz vehicles; see <http://bevo.mercedes-benz.com>.

For a list of approved products, consult an authorized Mercedes-Benz Center. Comply with the instructions for use on the product label.

Do not mix other fuel additives with fuel. This causes unnecessary costs and could damage the engine.

Engine oil

General notes

- !** Never use engine oil or an oil filter of a specification other than is necessary to fulfill the prescribed service intervals. Do not change the engine oil or oil filter in order to achieve longer replacement intervals than those prescribed. You could otherwise cause engine damage or damage to the exhaust gas aftertreatment.

Follow the instructions in the service interval display regarding the oil change. Otherwise, you may damage the engine and the exhaust gas aftertreatment.

The engine oils are matched to the performance of Mercedes-Benz engines and service intervals. You should therefore only use engine oils and oil filters that are approved for vehicles with maintenance systems.

For a list of approved engine oils and oil filters, consult an authorized Mercedes-Benz Center. Or visit the website <http://bevo.mercedes-benz.com>.

The table shows which engine oils have been approved for your vehicle.

Model	Engine model	MB Approval
SL 550 BlueEFFICIENCY	278	229.5
SL 63 AMG	157	229.5
SL 65 AMG	279	229.5

Use only SAE 0W-40 or SAE 5W-40 engine oils for AMG vehicles.

- i** MB approval is indicated on the oil containers.

Filling capacities

The following values refer to an oil change including the oil filter.

Model	Capacity
SL 550 BlueEFFICIENCY	With external oil cooler: 9.5 US qt(9.0 l)
SL 63 AMG	Without external oil cooler: 9.0 US qt (8.5 l) With external oil cooler: 10 US qt (9.5 l)
SL 65 AMG	Without external oil cooler: 10.6 US qt (10.0 l) With external oil cooler: 11.6 US qt (11.0 l)

Additives

- !** Do not use any additives in the engine oil. This could damage the engine.

Engine oil viscosity

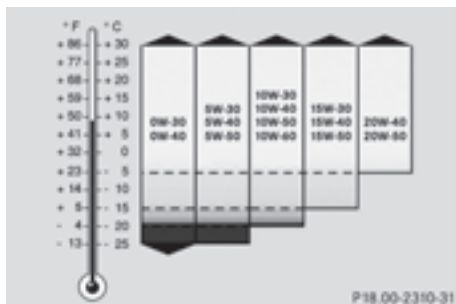

Viscosity describes the flow characteristics of a fluid. If an engine oil has a high viscosity, this means that it is thick; a low viscosity means that it is thin.

Select an engine oil with an SAE (viscosity) classification suitable for the prevailing outside temperatures. The table shows you which SAE classifications are to be used. The low-temperature characteristics of engine oils can deteriorate significantly, e.g. as a result of aging, soot and fuel deposits. It is therefore strongly recommended that you carry out regular oil changes using an approved engine oil with the appropriate SAE classification.

Brake fluid

⚠ WARNING

Over a period of time, the brake fluid absorbs moisture from the air; this lowers its boiling point.

If the boiling point of the brake fluid is too low, vapor pockets may form in the brake system when the brakes are applied hard (e.g. when driving downhill). This would impair braking efficiency.

You should have the brake fluid renewed at regular intervals. The brake fluid change intervals can be found in the Maintenance Booklet.

Only use brake fluid approved by Mercedes-Benz. Information about approved brake fluid can be obtained at any qualified specialist workshop or on the Internet at <http://bevo.mercedes-benz.com>.

Coolant

Important safety notes

⚠ WARNING

Antifreeze is highly flammable. Fire, open flames and smoking are prohibited when handling antifreeze.

If antifreeze comes into contact with hot engine parts, it may ignite and you could burn yourself. Do not spill any antifreeze on hot engine parts.

! Only add coolant that has been premixed with the desired antifreeze protection. You could otherwise damage the engine. Further information on coolants can be found in the Mercedes-Benz Specifications for Service Products, MB Specifications for Service Products 310.1, e.g. on the Internet at <http://bevo.mercedes-benz.com>. Or contact a qualified specialist workshop.

! Always use a suitable coolant mixture, even in countries where high temperatures prevail. Otherwise, the engine cooling system is not sufficiently protected from corrosion and overheating.

The coolant is a mixture of water and antifreeze/corrosion inhibitor. It performs the following tasks:

- corrosion protection
- antifreeze protection
- raising the boiling point

If the coolant has antifreeze protection down to -35 °F (-37 °C), the boiling point of the coolant during operation is approximately 266 °F (130 °C).

The antifreeze/corrosion inhibitor concentration in the engine cooling system should:

- be at least 50 %. This will protect the engine cooling system against freezing down to approximately -35 °F (-37 °C).
- not exceed 55 % (antifreeze protection down to -49 °F [-45 °C]). Otherwise, heat will not be dissipated as effectively.

If the vehicle has lost coolant, add equal amounts of water and antifreeze/corrosion inhibitor. Mercedes-Benz recommends an antifreeze/corrosion inhibitor concentrate in

accordance with MB Specifications for Service Products 310.1.

The coolant is checked with every maintenance interval at a qualified specialist workshop.

i When the vehicle is first delivered, it is filled with a coolant mixture that ensures adequate antifreeze and corrosion protection.

Capacity

Model	Capacity
SL 550 BlueEFFICIENCY	Approximately 15.3 US qt (14.5 l)
SL 63 AMG	Approximately 15.2 US qt (14.4 l)
SL 65 AMG	Approximately 13.5 US qt (12.8 l) Low-temperature circuit: approximately 3.7 US qt (3.5 l)

i Use antifreeze/corrosion inhibitor according to MB approval 325.0 or 326.0.

Windshield/headlamp cleaning system

⚠ WARNING

Washer solvent/antifreeze is highly flammable. Do not spill washer solvent/antifreeze on hot engine parts, because it may ignite and burn. You could be seriously burned.

! Only use washer fluid that is suitable for plastic lamp lenses, e.g. MB SummerFit or MB WinterFit. Unsuitable washer fluid could damage the plastic lenses of the headlamps.

! Do not add distilled or de-ionized water to the washer fluid container. Otherwise, the level sensor may be damaged.

! Only MB SummerFit and MB WinterFit washer fluid should be mixed together. The spray nozzles may otherwise become blocked.

At temperatures above freezing:

- ▶ Fill the washer fluid reservoir with a mixture of water and windshield washer fluid, e.g. MB SummerFit.
- ▶ Add 1 part MB SummerFit to 100 parts water.

At temperatures below freezing:

- ▶ Fill the washer fluid reservoir with a mixture of water and windshield washer fluid, e.g. MB WinterFit. Adapt the mixing ratio to the outside temperature.
- ▶ Down to 14 °F (-10 °C): mix 1 part MB WinterFit with 2 parts water.
- ▶ Down to -4 °F (-20 °C): mix 1 part MB WinterFit with 1 part water.
- ▶ Down to -20.2 °F (-29 °C): mix 2 parts MB WinterFit with 1 part water.

Model	Capacity
All models	5.6 US qt(5.3 l)

i Add windshield washer fluid, e.g. MB SummerFit or MB WinterFit, to the washer fluid all year round.

Vehicle data

General notes

Please note that for the specified vehicle data:

- The heights specified may vary as a result of:
 - tires
 - load
 - condition of the suspension
 - optional equipment
- The vehicle length specified includes the front license plate adapter.

Dimensions and weights



All models (except AMG vehicles)

① **Opening height** 75.8 in (1925 mm)

AMG vehicles

① **Opening height** 75.6 in – 79.3 in (1921 mm – 2013 mm)

Missing values were not available at time of going to print.

SL 550 BlueEFFICIENCY	
Vehicle length	181.7 in (4616 mm)
Vehicle length when opening/ closing the roof	188.9 in (4797 mm)
Vehicle width including exterior mirrors	82.6 in (2099 mm)
Vehicle height	51.8 in (1316 mm)
Vehicle height when opening/ closing the roof	66.8 in (1697 mm)
Wheelbase	101.8 in (2585 mm)
Turning radius	36.2 ft (11.04 m)
Maximum trunk load	220 lb (100 kg)

SL 63 AMG and SL 65 AMG	
Turning radius	36.3 ft (11.05 m)
Maximum trunk load	

SL 63 AMG and SL 65 AMG	
Vehicle length	182.9 in (4646 mm)
Vehicle length when opening/ closing the roof	190.8 in (4846 mm)
Vehicle width including exterior mirrors	82.6 in (2099 mm)
Vehicle height	51.4 in – 53.7 in (1305 mm – 1363 mm)
Vehicle height when opening/ closing the roof	67.5 in – 70.5 in (1714 mm – 1791 mm)
Wheelbase	101.8 in (2585 mm)

Publication details

Internet

Further information about Mercedes-Benz vehicles and about Daimler AG can be found on the following websites:

<http://www.mbusa.com> (USA only)

<http://www.mercedes-benz.ca> (Canada only)

Editorial office

Not to be reprinted, translated or otherwise reproduced, in whole or in part, without the written permission of Daimler AG.



2315841781

Order no. 6515 3114 13 Part no. 231 584 17 81 Edition Edition A 2013