











Operating Instructions

Audio 20



Mercedes-Benz

Symbols

-  Warning
-  Environmental note
-  Possible damage to the vehicle
-  Tip
-  Instruction
-  Continuation symbol
-  Page reference
-  Image in the display

Welcome to the world of Mercedes-Benz.

First of all, familiarize yourself with your audio equipment and read the operating instructions, especially the safety and warning notes, before operating the audio equipment. This will help you to obtain the maximum use from the system and avoid endangering yourself and others.

Depending on the model and equipment level, the functions of your audio equipment may deviate from certain descriptions and illustrations.

Mercedes-Benz is constantly updating its audio equipment to the state of the art and therefore reserves the right to introduce changes in design, equipment and technical features at any time.

You cannot, therefore, base any claims on the data, illustrations or descriptions in this manual.

Please consult an authorized Mercedes-Benz Center should you have any questions.

This manual is an integral part of the vehicle. You should always keep it in the vehicle and pass it on to the new owner if you sell the vehicle.

The technical documentation team at Daimler AG wishes you safe and pleasant motoring.

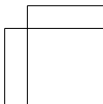
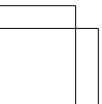
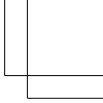
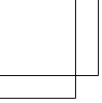

Index	4	At a glance	11
Introduction	8	System settings	29
		Telephone	35
		Audio	53
		Rear Seat Entertainment System	81

1, 2, 3 ...

911 emergency call 37

A

Active partition (USB devices only)

Selecting 66

Adjusting the bass 21

Adjusting the volume 21

Alphabetical track selection 77

Audio AUX 78

Audio CD/DVD or MP3 mode

Switching to (Rear Seat Entertainment System) 86

Audio CD/MP3 mode

Switching to 63

Audio DVD

Pause function 89

Stop function 89

Audio format

Setting (audio DVD mode) 89

AUX 78

AUX (Rear Seat Entertainment System)

Connecting 96

Switching to 96

AUX jacks

CD/DVD drive 26

AUX mode

Setting the brightness/contrast/color 97

Switching picture format 97

B

Basic functions 20

Basic menu

Calling up 18

Bluetooth®

Activating/deactivating 33

Connecting another mobile phone ... 40

Settings 32

Bluetooth® audio device

Connecting 68

Reconnecting 70

Bluetooth® audio mode

Switching on 71

Bluetooth® interface

Telephony 37

Bluetooth® interface telephony

Conditions 37

C

Call lists 48

Opening and selecting an entry 49

Category

Satellite radio 59

CD

Ejecting 62

Fast forward/fast rewind 65

Inserting 62

Mode, switching to 63

Multisession 66

Pause function 64

Playback options 66

Selecting a medium 64

Selecting a track 64

CD/DVD

Ejecting (Rear Seat Entertainment System) 86

Inserting (Rear Seat Entertainment System) 86

CD mode 62

Connecting a USB device 62

Controller 14

Control panel

Audio 20 13

Correct use 8

D

Data medium

MP3 66

Video DVD 91

Display 16

Adjusting the brightness 31

Selecting the design 31

E

External audio source (AUX) 78

External devices (Media Interface)

Connecting 73

F

Fast forward/rewind	88
Favorites button	32
Folders	
Selecting (MP3 mode)	65
Function restrictions	
Telephone operation	37
Video DVD mode	84

I

Indicator lamp	
Remote control	27
Inserting/removing CDs	
Single CD drive	62

M

Media Interface	
Activating	74
Active partition	66
Connection options	73
iPod®	73
Mode	73
Playback options	77
Selecting categories	76
Selecting folders	76
Selecting music files	75
Selecting playlists	76
Media list	64
Menu	
Overview	17
Showing/hiding	92
Menu system	18
Mobile phone	
Connecting (Bluetooth® interface) ...	38
De-authorizing	41
External authorization	40
Registering (authorizing)	39
MP3	
Bit/sampling rates	67
Copyright	67
Data medium	66
File systems	66
Formats	67
Operation	62
Selecting a medium	64

MP3 mode

Selecting a folder	88
--------------------------	----

Multifunction steering wheel	18
---	----

Multisession CDs	66
-------------------------------	----

N**Navigation menu**

Showing/hiding	91
----------------------	----

O**Operating system**

Audio 20	12
----------------	----

Operation

Example	19
---------------	----

P**Passcode**

Entering	39
----------------	----

Phone book	46
-------------------------	----

Icon overview	47
---------------------	----

Receiving vCards	46
------------------------	----

Playback options	90
-------------------------------	----

R**Radio**

Autostore	57
-----------------	----

Entering a frequency	56
----------------------------	----

Preset memory	55, 56
---------------------	--------

Searching for a station	55
-------------------------------	----

Selecting a station	55
---------------------------	----

Storing stations automatically	57
--------------------------------------	----

Storing stations manually	56
---------------------------------	----

Switching wavebands	55
---------------------------	----

Radio mode

Switching to	54
--------------------	----

RDS

Radiotext	57
-----------------	----

Rear-compartment screens	24
---------------------------------------	----

Rear Seat Entertainment System

Adjusting sound settings	83
--------------------------------	----

AUX mode	96
----------------	----

CD/DVD audio and MP3 mode	85
---------------------------------	----

Changing the batteries	82
------------------------------	----

Components	24
------------------	----

Cordless headphones	27
---------------------------	----

- Hiding/showing the picture 85
 - Multiple users 84
 - Operating with the headphones 83
 - Remote control 25
 - Safety notes 85
 - Selecting the display language 85
 - Setting the brightness 85
 - Switching the display design 85
 - System settings 84
 - Video DVD mode 90
 - Reception problems** 9
 - Redial** 44
 - Remote control**
 - Switching SmartKey illumination on/off 25
- S**
- Safety notes**
 - Operating safety 8
 - SatRadio** 57
 - Displaying information 61
 - Registering 58
 - Selecting a category 59
 - Switching to 59
 - Screen**
 - Selecting for remote operation 25
 - Switching on/off (Rear Seat Entertainment System) 25
 - Single call**
 - Functions 45
 - Sound**
 - Balance/fader 21
 - Setting balance 21
 - Switching on/off 21
 - Sound settings** 21
 - Speed dial list**
 - Storing a phone book entry in the speed dial list 50
 - Surround sound** 22
 - Surround sound (harman/kardon® surround sound system)**
 - Notes 22
 - Switching on/off 22
 - Switching off** 20
 - Switching on** 20
- System settings**
 - Display 31
 - Language 33
 - Reset 33
- T**
- Telephone**
 - Accepting/ending a call 42
 - Ending an active call 45
 - Incoming call 42
 - Making a call via speed dial 45
 - Operating options 36
 - Outgoing call 43
 - Redialing 44
 - Sending DTMF tones 45
 - Switching the hands-free microphone on/off 45
 - Telephone basic menu**
 - Bluetooth® interface 41
 - Telephone book**
 - Calling up 47
 - Importing external data 46
 - Multifunction steering wheel 48
 - Text messages (SMS)** 51
 - Calling the sender 52
 - Deleting 52
 - Inbox 51
 - Information and requirements 51
 - Reading 52
 - Track**
 - Selecting 88
 - Treble**
 - Setting 21
- U**
- Using the telephone** 42
- V**
- Video DVD**
 - DVD menu 94
 - Fast forward/rewind 92
 - Function restrictions 91
 - Interactive content 96
 - Pause function 92
 - Picture settings 94
 - Selecting a film/title 93

Selecting a scene/chapter	93
Setting the language	95
Stop function	92
Subtitles	95
Video DVD mode	
DVD playback restrictions	91
Switching to	91
Volume	
Adjusting (multifunction steering wheel)	18
Phone calls	21

Operating safety

General information

WARNING

To avoid distractions that could lead to an accident, you should only change system settings when the vehicle is stationary and operate the system only when road, weather, and traffic conditions permit.

Bear in mind that at a speed of just 30 mph (approximately 50 km/h), your vehicle covers a distance of 44 feet (approximately 14 m) every second.

For safety reasons, we recommend that you stop the vehicle in accordance with traffic conditions before answering or placing a call or before consulting the Audio20 screen to read instructions or downloaded information.

i Canada only: This device complies with RSS-210 of Industry Canada. Operation is subject to the following two conditions:

1. This device may not cause interference, and
2. this device must accept any interference received, including interference that may cause undesired operation of the device.

Any unauthorized modification to this device could void the user's authority to operate the equipment.

i USA only: This device complies with Part 15 of the FCC Rules. Operation is subject to the following two conditions:

1. This device may not cause interference, and
2. this device must accept any interference received, including interference that may cause undesired operation.

Any unauthorized modification to this device could void the user's authority to operate the equipment.

WARNING

Change or modification not expressly approved by the party responsible for

compliance could void the user's authority to operate this equipment.

! Note: This equipment has been tested and found to comply with the limits for a Class A digital device, pursuant to Part 15 of the FCC Rules. These limits are designed to provide reasonable protection against harmful interference when the equipment is operated in a commercial environment. This equipment generates, uses and can radiate radio frequency energy and, if not installed and used in accordance with the instruction manual, may cause harmful interference to radio communications.

WARNING

This equipment complies with FCC radiation exposure limits set forth for uncontrolled equipment and meets the FCC radio frequency (RF) Exposure Guidelines in Supplement C to OET65.

This equipment has very low levels of RF energy that is deemed to comply without maximum permissive exposure evaluation (MPE). But it is desirable that it should be installed and operated with at least 8 inches (20 cm) and more between the radiator and a person's body (excluding extremities: hands, wrists, feet and legs.)

Correct use

Always observe the following when using the audio equipment:

- the safety notes in this manual
- all road traffic regulations

WARNING

Modifications made to electronic components or software can cause malfunctions.

The radio, satellite radio, amplifier, CD changer and telephone are interlinked. If one component is not functional or if it has been

incorrectly removed/replaced, this could impair the operation of other components.

This could seriously jeopardize the operational safety of your vehicle.

We recommend that you always have maintenance work on electronic components carried out at an authorized Mercedes-Benz Center.

- i** Roof antenna functionality (telephone, satellite radio, GPS) can be affected by the use of roof carrier systems.

Retrofitting metalized plastic films to the windows can affect radio reception and lead to poorer reception of all other antennas (e.g. emergency call antennas) inside the vehicle.

- i** **Protection against theft:** this device is equipped with technical provisions to protect it against theft. Further information on protection against theft can be obtained from an authorized Mercedes-Benz Center.

- !** Electronic devices that you bring into the vehicle yourself can cause significant problems with the radio reception.

Audio device features

These Operating Instructions describe all standard and optional equipment available for your audio device at the time of going to print. Country-specific deviations are possible. Please note that your audio equipment may not offer all the features described. This includes safety-related systems and functions. The equipment in your vehicle may therefore differ from some of the descriptions or illustrations.

The original purchase agreement lists all systems installed in your vehicle. Contact an authorized Mercedes-Benz Center if you have any questions about equipment or operation.

Function restrictions

For safety reasons, some Audio 20 functions are restricted or unavailable while the vehicle is in motion. You will notice this, for example, because you will either not be able to select certain menu items or because Audio 20 will display a message to that effect.

Audio 20 operating system	12
Multifunction steering wheel	18
Operating Audio 20	18
Basic functions of Audio 20	20
Rear Seat Entertainment System	24
Rear view camera	28

Audio 20 operating system

Overview



P82.60-8369-31

Example

	Function	Page
①	Display	16
②	Control panel with a single CD drive	13
③	Controller	14

Audio 20 components

Audio 20 consists of:

- the control panel with a single CD drive
- the display
- the controller

In addition, Audio 20 can be operated via the multifunction steering wheel.

Audio 20 control panel

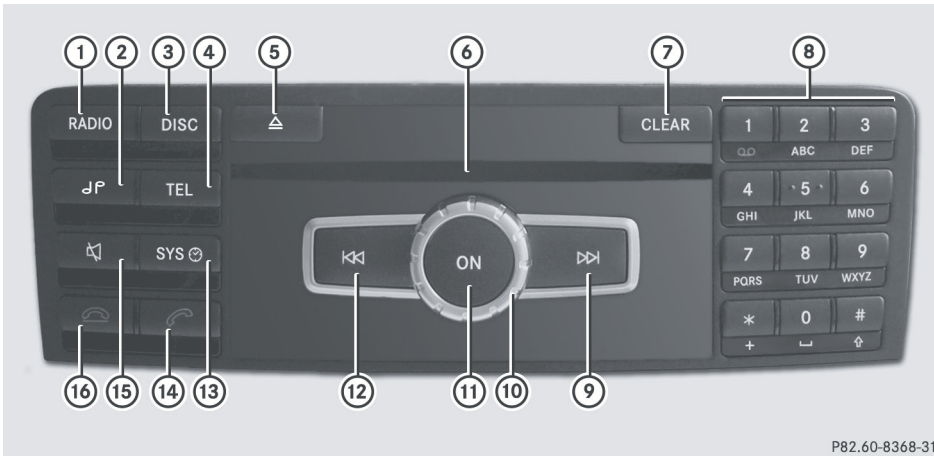



P82.60-8368-31

At a glance

	Function	Page
①	RADIO Switches to radio mode Switches wavebands Switches to SatRadio mode	54 55 57
②	JP Calls up sound settings	21
③	DISC Switches to audio CD or MP3 mode	63
④	TEL Activates telephone mode	41
⑤	Eject Eject button	62
⑥	Disc slot Inserts CDs Removes CDs	62 62
⑦	CLEAR Clear button • Deletes characters • Deletes an entry	

	Function	Page
⑧	Number pad • Selects stations via the station presets • Stores stations manually • Telephone number entry • Sends DTMF tones • Character entry	55 56 43 45
⑨	Next track Selects a station using the station search function Selects the next track Fast forwards	55 64 65
⑩	Adjusts the volume	21
⑪	ON Switches Audio 20 on/off	20
⑫	Previous track Selects a station using the station search function Selects the previous track Rewinds	55 64 65
⑬	SYS Calls up the basic menu	17

	Function	Page
⑭	 Accepts a call	42
	Dials a number	43
	Redials	44
⑮	 Mute	21
	Switches the hands-free system on/off	

	Function	Page
⑯	 Rejects a call	42
	Ends an active call	45

Audio 20 controller

Introduction

You can use the controller to select functions in the display. To do so, move the selection bar.



P82.60-8370-31

① Controller

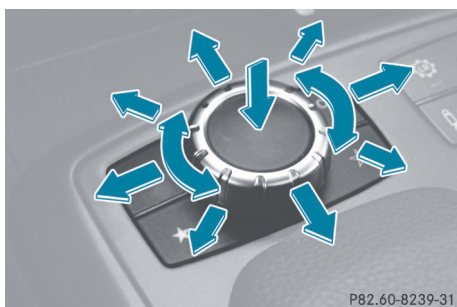

P82.60-8239-31

The controller can be:

- pressed briefly or pressed and held
- turned clockwise or counterclockwise
- slid to the left, to the right, up or down

In this way you can:

- scroll within menus
- select menu items
- exit menus

Overview

Symbol	Controller operation	Function (examples)
⏏	Press briefly	<ul style="list-style-type: none"> • Selects a menu item
	Press and hold until the selected action is carried out.	<ul style="list-style-type: none"> • Stores stations
⏏	Turn	<ul style="list-style-type: none"> • Scrolls through vertical or horizontal menus • Scrolls through text • Makes settings
↑⏏↓	Slide	<ul style="list-style-type: none"> • Scrolls through a vertical menu • Exits a horizontal menu
←⏏→	Slide	<ul style="list-style-type: none"> • Scrolls through a horizontal menu • Exits a vertical menu
	Slide and hold	<ul style="list-style-type: none"> • Fast forward or rewind during CD playback • Scrolls through lists

Controller buttons

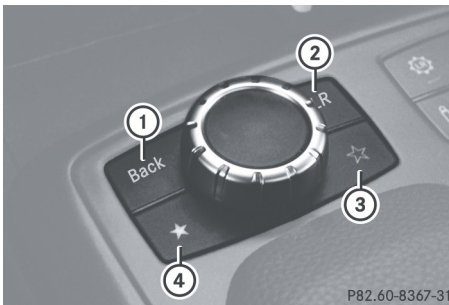

- ① Back button **BACK**
 - ② Clear button **CLR**
 - ③ Right favorites button (star, empty)
 - ④ Left favorites button (star, filled)
- i** Depending on the equipment, the controller may have no favorites button, one favorites button or two favorites buttons.

- ▶ **To go up a menu level:** briefly press the **BACK** back button
Audio 20 changes to the next higher menu level in the current operating mode.
 - ▶ **To switch to the basic menu:** press and hold the **BACK** back button.
Audio 20 changes to the basic menu of the current operating mode.
 - ▶ **To delete individual characters:** briefly press the **CLR** button.
 - ▶ **To delete an entire entry:** press and hold the **CLR** button.
 - ▶ **To call up the favorites function:** press the left or right star button.
- i** Information on setting the Favorites function (▶ page 32).

Audio 20 display

Display overview

The display shows the function currently selected and its associated menus. The display is divided into several areas.



P82.60-8173-31

Example radio



- ① Status bar
- ② Main function bar
- ③ Waveband/frequency
- ④ Display/selection window
- ⑤ Radio text plus (if available)
- ⑥ Submenu bar
- ⑦ HD Radio logo (only with HD Radio reception)

i The layout of the menus may vary, depending on the vehicle's equipment.

Depending on the current setting of Audio 20, the following information can be displayed in the status bar:





- time

If a mobile phone is operational, additional information is shown:

- name of the mobile phone network provider
- signal strength of the mobile phone network  (> page 41)
- receiver symbol ,  (> page 41)

Menu overview

The main functions, i.e. radio mode, CD mode, telephone mode and systems settings, can be reached at the touch of a button. Each main function has a basic menu. Each item in the basic menu can have several submenu items.

Function button	Basic menu	Menu items
	Radio	Radio presets Info FM/AM/WB Sound
	Disc	CD/MP3/USB/BT Audio ¹ /Media Int. ² Tracklist/folder Media Sound
	Telephone	Telephone Text message (SMS) Call lists
	System	Settings Time Display off

Notes on cleaning

! When cleaning the display must be switched off and cooled down.

Please clean the display screen, when necessary, with a commercially available microfiber cloth and cleaning agent formulated for TFT/LCD displays. Afterwards dry and polish the screen with a dry microfiber cloth.

! Avoid using alcoholic thinners, gasoline or abrasive cleaning agents. These products can damage the display surface.

¹ Bluetooth® audio.

² Media Interface.

Multifunction steering wheel

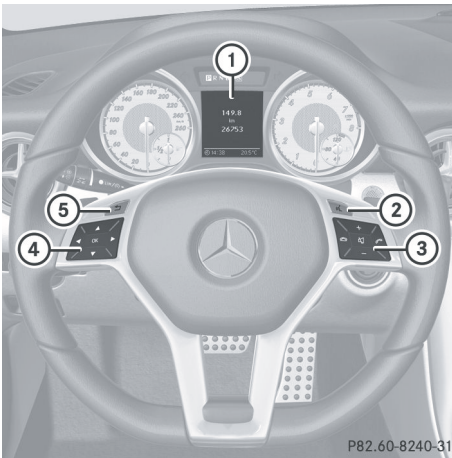

P82.60-8240-31

Example illustration

	Function	Page
①	Multifunction display	
②	Voice control system - not installed	
③	Increases the volume	21
	Decreases the volume	21
	Accepts a call	42
	Ends a call	42
	Press briefly: mutes the audio source	21

	Function	Page
④	<p> Calls up the menu bar and selects menus</p> <p> Press briefly: selects a submenu or scrolls through lists. In the Audio menu, this selects a stored station or an audio track. In the Tel menu, this switches to the phone book and selects a name or phone number.</p> <p> Press and hold: in the Audio menu, this selects the next/previous station or selects an audio track using rapid scrolling. In the Tel menu, this starts rapid scrolling through the phone book.</p> <p> Confirms selections and fades out messages. In the Tel menu, this switches to the phone book and starts dialing.</p>	
⑤	<p> Press briefly: returns to the previous menu and fades out display messages</p> <p> Press and hold: selects the standard display; see vehicle Operator's Manual</p>	

Operating Audio 20

Selecting menus

Basic menu

- Press the appropriate **RADIO**, **DISC**, **TEL** or **sys** function button.

The basic menu of the respective function is shown. The main area is active.

The active area is highlighted.

- i** The following pictures show the display in daytime design (> page 31). The menu highlighting appearance is different depending on the display design.



Switching from the display window to the submenu bar

- ▶ Slide the controller.

Horizontal menus



P82.60-8175-31

Navigating within a menu

- ▶ Slide or turn the controller. The menu item selected is highlighted in white.

Selecting a menu item

- ▶ Press the controller.

Exiting a menu without making a selection

- ▶ Slide the controller in the opposite direction to the direction of the list.
- or
- ▶ Press the **BACK** button on the controller.

Vertical menus

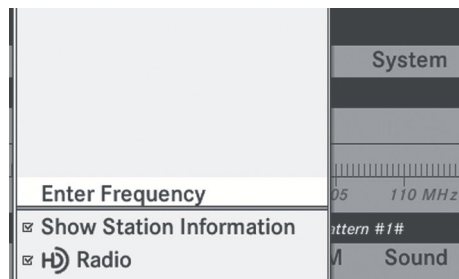

P82.60-8176-31

Navigating within a menu

- ▶ Slide or turn the controller. The menu item selected is highlighted in white.

Selecting a menu item

- ▶ Press the controller.

Exiting a menu without making a selection

- ▶ Slide the controller in the opposite direction to the direction of the list.
- or
- ▶ Press the **BACK** button on the controller.

Operating example

Example: setting the radio station to FM 104.6 MHz.

- ▶ Press the **RADIO** button once or several times until the **FM** waveband appears in the status bar.
- ▶ **To switch to the submenu bar:** slide the controller.
- ▶ **To highlight Radio in the submenu bar:**

Slide \leftarrow \odot or turn $\left\{ \odot \right\}$ the controller.



P82.60-8175-31

- ▶ **To confirm your selection:** press \odot the controller.

A selection list with the functions in the **Radio** submenu appears.

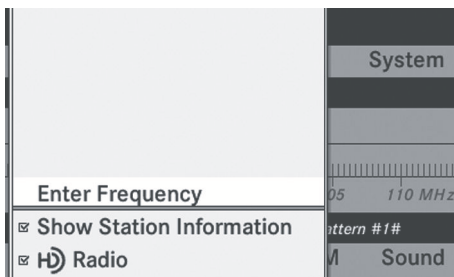

P82.60-8176-31

- ▶ **To highlight the Enter Frequency function:**
Slide \uparrow \odot \downarrow or turn $\left\{ \odot \right\}$ the controller.
- ▶ **To confirm your selection:** press \odot the controller.

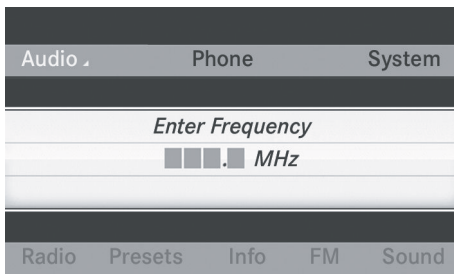

P82.60-8177-31

- i** Only permissible numbers for the frequency range can be entered in front of

the decimal point. If non-permissible numbers are entered after the decimal point, the next lowest frequency is set.

- ▶ Press the $\boxed{1}$ $\boxed{0}$ $\boxed{4}$ $\boxed{6}$ number keys on the keypad.
The station selected is played.

Basic functions of Audio 20

Switching Audio 20 on/off

Overview

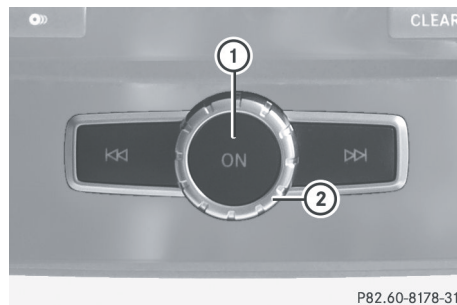

P82.60-8178-31

- ① \odot Button
- ② Thumbwheel

Switching Audio 20 on

- ▶ Press the \odot button.
- or
- ▶ If Audio 20 was on the last time the ignition was switched off, turn the SmartKey to position 2 in the ignition lock.

The last main function used is reactivated after switching on.

Switching Audio 20 off

- ▶ Press the \odot button.
- or
- ▶ Turn the SmartKey to position 0 in the ignition lock and remove the SmartKey.

- i** If you switch off Audio 20, playback of the current audio source will also be switched



off. Your mobile phone can also no longer be operated via the Audio 20 system.

Mute

Switching the audio source on/off

- ▶ Press the  button.

The sound from the audio source is switched on or off.



- i** When the sound is switched off, you will see the  symbol in the status bar. If you change the audio source or adjust the volume using thumbwheel , the sound switches on automatically.

Adjusting the volume

Adjusting the volume for the audio source

- ▶ Turn thumbwheel .

or



- ▶ Press the  or  button on the multifunction steering wheel. The volume of the audio source currently selected changes.

Adjusting the volume for phone calls

You can adjust the volume for hands-free mode during a phone call.

- ▶ Turn thumbwheel  during a phone call.

or

- ▶ Press the  or  button on the multifunction steering wheel during a telephone call.

Adjusting the sound settings

Selecting the sound menu





The sound settings can be selected to suit a variety of different audio sources. The sound menu of the current audio source (radio, CD,

USB audio, Bluetooth® audio, Media Interface, AUX) can be reached via the respective basic menu or by pressing the  button.

Adjusting treble and bass

- ▶ Press the  sound button.

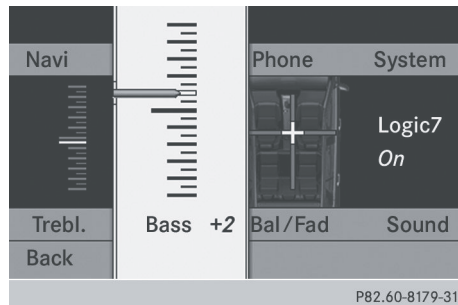

or

- ▶ Select **Sound** using the controller (slide ,  or turn ) and press  to confirm.
- ▶ Select **Treble** or **Bass** and press  to confirm.



Example: setting the bass

The current setting is indicated by a red needle.







- ▶ **To change the setting:** slide ,  or turn  the controller until the desired treble and bass levels are set. When you exit the menu, the current setting is stored.

Adjusting balance and fader

With the Balance function, you can control whether the sound is louder on the driver's or front-passenger side.





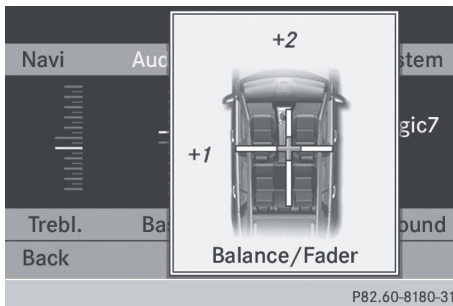

The Fade function is used to control whether the sound is louder in the front or the rear of the vehicle.

Fader	Vehicle
Function available	C-Class, M-Class
Function not available	SLK

- ▶ Press the  sound button.
- or
- ▶ Select **Sound** using the controller (slide ,  or turn ) and press  to confirm.
- ▶ Select **Balance** or **Bal/Fad** (balance/fader) and press  to confirm.



Example: adjusting the balance

- ▶ Select a balance setting by sliding ,  the controller and press  to confirm.
- ▶ Select a fader setting by sliding ,  the controller and press  to confirm. The setting is stored and you exit the menu.

Surround sound

General information

If your vehicle is equipped with the Harman Kardon® Logic 7® surround sound system, you can choose between the settings **Logic7on** and **Logic7 off**.





The Harman Kardon® Logic 7® surround sound system is available for the following operating modes:

- audio CD
- MP3

- radio (FM) and satellite radio
-
- AUX

i If you select **Logic7off**, the sound system plays the tracks as stored on the medium. Due to the design of the passenger compartment, an optimum audio experience cannot be guaranteed for all passengers.



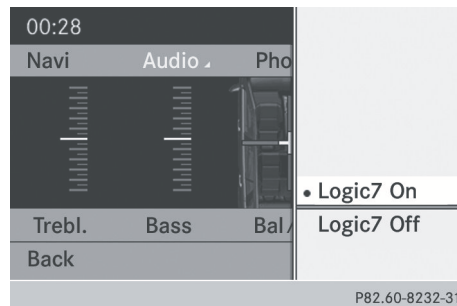

Switching surround sound on/off

- ▶ Press the  sound button.
- or
- ▶ Select **Sound** using the controller (slide ,  or turn ) and press  to confirm.



Example: setting surround sound

The **•** dot indicates the current setting.

- ▶ **To select a setting:** slide ,  or turn .
- ▶ **To save a setting:** press  on the controller. The setting is stored and you exit the menu.

i The balance setting is automatically reset to the default value (0) when Logic 7® is switched on or off.

- i** Please bear the following in mind:
- to provide the optimum audio experience for all passengers when Logic 7® is switched on, the balance should be set

to the center of the passenger compartment.

- MP3 tracks should have a bit rate of at least 128 kbit/s.
- surround-sound playback does not function for mono signal sources, such as the medium wave range (MW) in radio mode.
- if radio reception is poor, e.g. in a tunnel, you should switch off Logic 7[®], as it may otherwise switch between stereo and mono and cause temporary sound distortions.
- on some stereo recordings, the sound characteristics may differ from conventional stereo playback.

Rear Seat Entertainment System

Components

At a glance

Overview

The Rear Seat Entertainment System is comprised of:

- two rear-compartment screens behind the front-seat head restraints
- a remote control
- a CD/DVD drive
- AUX jacks on both screens (display AUX) and on the CD/DVD drive (drive AUX)
- two sets of cordless headphones

Rear-compartment screens



- ① AUX jacks, detailed view in the "CD/DVD drive and AUX jacks" section (▷ page 26)
- ② Display

Remote control

Overview



P82.B7-6643-31

- ① To switch the screen on/off
- ② To switch the button lighting on/off
- ③ To select the screen for the remote control
- ④ To select a menu or menu item
- ⑤ To confirm a selection or setting
- ⑥ To switch the sound on/off (for corded headphones)
- ⑦ To adjust the volume (for corded headphones)
- ⑧ To skip to a track, fast-forward/fast-rewind
- ⑨ To select a track; direct entry
- ⑩ To exit a menu (back)

Selecting the screen for the remote control

You can use the remote control to operate one of the two rear screens at a time. To do so, you must switch the remote control to the desired screen.

- ▶ **To select the left-hand screen:** turn thumbwheel ③ until "L REAR" is highlighted in the window.
- ▶ **To select the right-hand screen:** turn thumbwheel ③ until "REAR R" is highlighted in the window.

Switching the screen on/off

- ❗ If the SmartKey is in position **0** or **1** in the ignition lock (see the vehicle Operator's Manual), or the SmartKey is not inserted, the screens in the rear will switch off after 30 minutes.

Before the screens switch off, they show a message to this effect.

You can switch the screens back on. However, this will discharge the starter battery.

- ▶ Point the remote control at the rear-compartment screen which has been selected for remote operation.
- ▶ Press button ① on the remote control. The respective rear screen switches on or off.
- ❗ You can only switch the screens on using the remote control if the ignition is switched on.





Switching the button lighting on/off

- ▶ Press button ② on the remote control. Depending on the previous status, the button lighting is switched on or off.
- ❗ If you do not use the remote control for about 15 seconds, the button lighting switches off automatically.

Mute

- ▶ Press button ⑥ on the remote control.
The sound is on or off.

Selecting a menu/menu item and confirming your selection

- ▶ Select a menu/menu item using the     buttons on the remote control and press the  button to confirm.

CD/DVD drive and AUX jacks

The CD/DVD drive is located in the center behind the front seats.

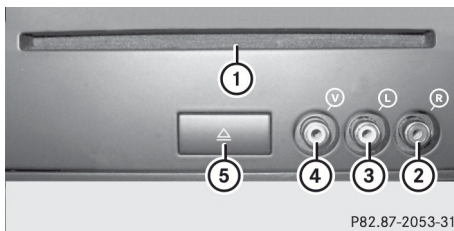

- ① CD/DVD slot
- ② AUX, right-hand (R) jack for audio signal
- ③ AUX, left-hand (L) jack for audio signal
- ④ AUX, jack for video signal (V)
- ⑤ CD/DVD eject button

The AUX jacks shown are for the AUX drive. Identical jacks can be found on the right-hand side of the rear-compartment screens (AUX display) (> page 24).

Cordless headphones

Overview



- ① Volume control
- ② To select a screen for the headphones
- ③ Battery compartment cover
- ④ To switch the cordless headphones on/off
- ⑤ Indicator lamp with various displays (▷ page 27)

- ▶ Open both sides of the headphones and adjust the fit of the headphones by pulling the headphone band in the direction of the arrow.

Switching the cordless headphones on/off

- ▶ Press button ④.
Depending on the previous status, the headphones are switched on or off.
To save the battery, the headphones are switched off automatically if they do not receive an audio signal within three minutes.

Adjusting the volume of the headphones

- ▶ Turn volume control ① until the desired volume has been set.

- ❗ If you have connected corded headphones to a rear-compartment screen, you can adjust the volume by pressing buttons ⑦ on the remote control (▷ page 25).

Selecting a screen for the headphones

- ▶ Move push slider ② to **L** (left-hand screen) or **R** (right-hand screen).

Indicator lamp displays

The color of the indicator lamp shows whether the headphones are switched on or off and indicates the charge level of the batteries inserted.

LED display	Status
Green	The batteries are fine.
Red	The batteries are almost discharged.
Lit continuously	The headphones are switched on and connected to a screen.
Flashing	The headphones are searching for the connection to a screen.
No display (dark)	The headphones are switched off or the batteries are discharged.

Connecting additional headphones

You can connect one additional set of corded headphones to each of the two rear screens (▷ page 24). The socket is designed for headphones with a 3.5 mm stereo jack plug and an impedance of 32 ohms.

Changing batteries

Batteries are required for the remote control and for the two sets of cordless headphones. For changing batteries, see (▷ page 82).

Rear view camera

WARNING

The rear view camera is merely an aid. Please observe the corresponding notes in your vehicle's Operator's Manual.

If your vehicle is equipped with a rear view camera, its image is automatically relayed to the audio display if the "Activation by R gear" function is activated and you shift into reverse gear.

After completion of the maneuver, the audio display returns to the previous screen.

i Further information on the rear view camera driving system can be found in the vehicle Operator's Manual.

- ▶ Press the **sys** function button. The system menu appears.
- ▶ Select **Settings** by turning **⏮** the audio controller and press **⏹** to confirm.
- ▶ Select **Activation by R gear** and press **⏹** to confirm. The function is switched on or off , depending on the previous status.

Audio device features	30
System menu	30
Switching the display on/off	30
Display settings	31
Time settings	31
Favorites button (asterisk key)	32
Bluetooth® settings	32
System language settings	33
Reset function	33

Audio device features

- i** These Operating Instructions describe all standard and optional equipment available for your audio device at the time of going to print. Country-specific deviations are possible. Please note that your audio equipment may not offer all the features described.

System menu

Calling up the basic menu

- ▶ Press the **sys** button.
- or
- ▶ Select **System** from the main function bar using the controller (slide $\odot \downarrow$, $\leftarrow \odot \rightarrow$ or turn $\odot \uparrow$) and press \odot to confirm.

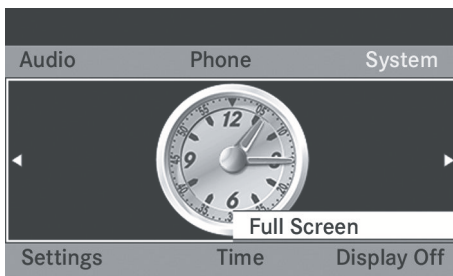

P82.60-8182-31

Full screen display

- ▶ With the **Full Screen** menu item highlighted, press \odot the controller. The main function bar and the submenu bar disappear.
- ▶ **To make the main function bar and submenu bar reappear:** press \odot the controller.



P82.60-8183-31

Changing the screen

You can change the screen to display either the clock or the consumption indicator.

- ▶ Slide $\leftarrow \odot \rightarrow$ or turn $\odot \uparrow$ the controller. The display changes.

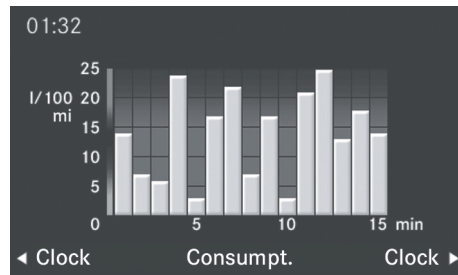

P82.60-8194-31

Switching the display on/off

- ▶ **To call up the basic menu:** press the **sys** button.
- ▶ Switch to the submenu bar by sliding $\odot \downarrow$ the controller.
- ▶ Select **Display Off** by sliding $\odot \rightarrow$ the controller and press \odot to confirm.
- ▶ **To switch the display on again:** press \odot .

or

- ▶ Press the **ON** button.

- i** You can also press one of the function buttons, such as the **DISC** button, to display the relevant basic menu.

Display settings

Display design

You can adjust the brightness of the display to suit the prevailing ambient light.

- ▶ **To call up the basic menu:** press **sys**.
- ▶ Switch to the submenu bar by sliding **⊙** the controller.
- ▶ Select **Settings** using the controller (slide **←⊙→** or turn **⌚**) and press **⊗** to confirm.
- ▶ Select **Display** and press **⊗** to confirm.
- ▶ Select **Brightness, Day Mode, Night Mode** or **Automatic** and press **⊗** to confirm.

- i** If you select **Brightness**, an adjustment scale appears which you can use to adjust the brightness manually.

In the **Automatic** setting, Audio 20 evaluates the readings from the automatic vehicle light sensor and automatically switches the display designs.

Time settings

Accessing the date/time settings menu

- ▶ **To call up the basic menu:** press the **sys** button.
- ▶ Switch to the submenu bar by sliding **⊙** the controller.
- ▶ Select **Time** using the controller (slide **←⊙→** or turn **⌚**) and press **⊗** to confirm.

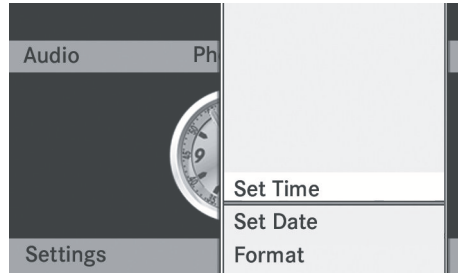

P82.60-8233-31

Setting the time

- ▶ Select **Set Time** using the controller (slide **⊙** or turn **⌚**) and press **⊗** to confirm.

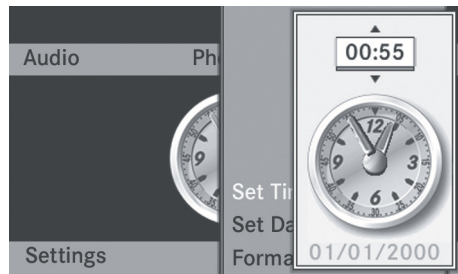

P82.60-8234-31

- ▶ **To set the time:** slide **↑⊙↓** or turn **⌚** the controller and press **⊗** to confirm.

Setting the date

- ▶ Select **Set Date** using the controller (slide **⊙** or turn **⌚**) and press **⊗** to confirm.

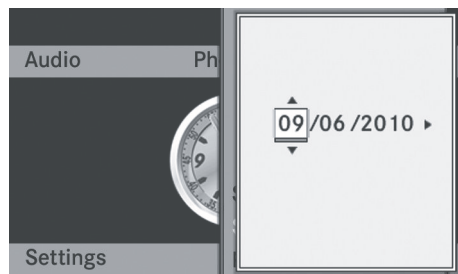

P82.60-8235-31

- ▶ **To set the date:** slide $\uparrow \odot \downarrow$ or turn $\left\{ \odot \right\}$ the controller and press \odot to confirm.

Setting the format

- ▶ Select **Format** using the controller (slide $\odot \uparrow$ or turn $\left\{ \odot \right\}$) and press \odot to confirm.

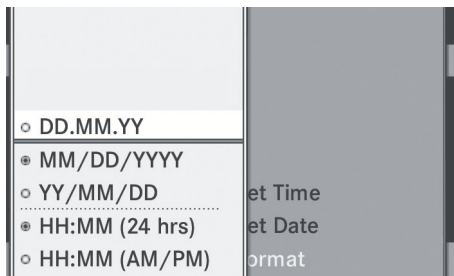

P82.60-8236-31

- i** You can set the format for the date and time separately.
- ▶ **To set the date/time format:** slide $\uparrow \odot \downarrow$ or turn $\left\{ \odot \right\}$ the controller and press \odot to confirm.

Favorites button (asterisk key)

- i** You can assign a function from the favorites menu to the favorites button (star button) on the controller.
- ▶ **To call up the basic menu:** press the **sys** button.
- ▶ Switch to the submenu bar by sliding $\odot \downarrow$ the controller.
- ▶ Select **Settings** using the controller (slide $\leftarrow \odot$ or turn $\left\{ \odot \right\}$) and press \odot to confirm.
- ▶ Select **Assign as Favorite** by sliding $\uparrow \odot \downarrow$ the controller and press \odot to confirm.

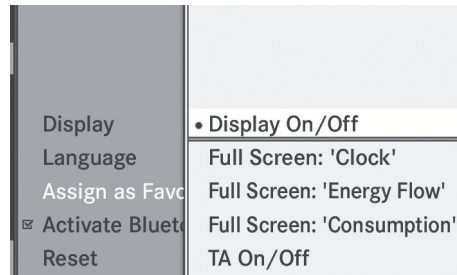

P82.60-8188-31

Favorites menu (example: vehicle with a favorites button)

- ▶ Select the desired function by sliding $\uparrow \odot \downarrow$ the controller and press \odot to confirm. The selected function is assigned to the favorites button.

- i** If your vehicle has two favorites buttons, you can assign a function to each favorites button. The favorites menu will then have an additional submenu where you can choose the favorites button to which you want to assign a function.

Bluetooth® settings

General information about Bluetooth®

Bluetooth® technology is a standard for short-range wireless data transmissions up to approximately 10 meters. To call using the hands-free mode and to receive electronic business cards (vCards) via Audio 20, the Bluetooth® function must be activated.

Further information on telephone mode (\triangleright page 37).

Bluetooth® is a registered trademark of Bluetooth Special Interest Group (SIG) Inc.



Activating/deactivating Bluetooth®

- ▶ **To call up the basic menu:** press **[SYS]**.
- ▶ Switch to the submenu bar by sliding **⊙** ↓ the controller.
- ▶ Select **Settings** using the controller (slide **←⊙→** or turn **[⊙]**) and press **[OK]** to confirm.
- ▶ Select **Activate Bluetooth** using the controller (slide **↓⊙↑**) and press **[OK]** to confirm.
This switches Bluetooth® on or off . Audio 20 is now ready to utilize Bluetooth® functions, such as receiving data from other devices or connecting mobile phones.

System language settings

- ▶ **To call up the basic menu:** press **[SYS]**.
- ▶ Switch to the submenu bar by sliding **⊙** ↓ the controller.
- ▶ Select **Settings** using the controller (slide **←⊙→** or turn **[⊙]**) and press **[OK]** to confirm.
- ▶ Select **Language** using the controller (slide **↑⊙↓** or turn **[⊙]**) and press **[OK]** to confirm.
- ▶ Select the desired language and press **[OK]** to confirm.
The menu system is shown in the selected language.

Reset function

- i** You can reset Audio 20 to the factory settings. Among other things, this will

delete all personal data (e.g. phone book entries), and all system settings are returned to the factory settings. A system reset is recommended, e.g. before selling the vehicle.

- ▶ **To call up the basic menu:** press **[SYS]**.
- ▶ Switch to the submenu bar by sliding **⊙** ↓ the controller.
- ▶ Select **Settings** using the controller (slide **←⊙→** or turn **[⊙]**) and press **[OK]** to confirm.
- ▶ Select **Reset** and press **[OK]** to confirm.
A prompt appears asking whether you wish to reset.
- ▶ Select **Yes** or **No**.
If you select **Yes**, a prompt will appear again asking whether you really wish to reset.
- ▶ Select **Yes** or **No** and press **[OK]** to confirm.
If you select **Yes**, Audio 20 will be reset and restarted.

Audio device features	36
General notes	36
Telephony via the Bluetooth® inter- face	37
Reception and transmission volume .	42
Telephone operation	42
Using the phone book	46
Using call lists	48
Using the speed dial list	50
Text messages (SMS)	51

Audio device features

i These Operating Instructions describe all standard and optional equipment available for your audio device at the time of going to print. Country-specific deviations are possible. Please note that your audio equipment may not offer all the features described.

General notes

Introduction

Audio 20 allows you to use a Bluetooth®-capable mobile phone via the Bluetooth® interface. Using the Bluetooth® interface and a suitable mobile phone, you can use the Audio 20 hands-free system to receive electronic business cards (vCards).

With a suitable mobile phone, you can use the hands-free system via the Bluetooth® interface, import contacts from the mobile phone via PBAP (Phone Book Access Profile) and receive vCards.

You can obtain more detailed information on suitable mobile phones and on connecting Bluetooth®-capable mobile phones to Audio 20 from your authorized Mercedes-Benz Center or on the Internet at <http://www.mbusa-mobile.com> (customers in the USA only).

Important safety notes

WARNING

Excessive electromagnetic radiation may constitute a health hazard to yourself and others.

There is scientific discussion surrounding the possible health risks posed by electromagnetic fields. You can reduce this risk by using an exterior antenna. Therefore, only use mobile communication equipment if

it is connected to the exterior antenna of the vehicle.

Two-way radios and fax machines without low-reflection exterior antennas may interfere with the vehicle electronics and thereby compromise the operational safety of the vehicle and thereby your safety as well. Therefore, only use these if they are correctly connected to a separate, low-reflection exterior antenna.

WARNING

Excessive electromagnetic radiation may constitute a health hazard to yourself and others.

There is scientific discussion surrounding the possible health risks posed by electromagnetic fields. You can reduce this risk by using an exterior aerial.

Therefore, only use mobile communication equipment if it is connected to the exterior aerial of the vehicle.

Call disconnection while the vehicle is in motion

A call may be disconnected if:

- there is insufficient network coverage in certain areas.
- you move from one transmitter/receiver area (cell) into another and no channels are free.
- you use a SIM card which is not compatible with the network available.
- you are using a mobile phone with "Twincard" and the mobile phone with the second SIM card is already logged into the network.

Operating options





You can operate the telephone by using the following controls:

- Audio 20 controller

turn .

slide  or .

press .

- the  or  button and the number keypad on Audio 20
- the  or  button on the multifunction steering wheel

All descriptions and illustrations in this section refer to the Audio 20 operating system unless stated otherwise.

Function restrictions

The telephone is not ready for use in the following situations:

- the telephone automatically tries to log on to a network. If no network is available, you may not be able to make a "911" emergency call. If you attempt to make an outgoing call, the **No Service** message will appear for a short while.

If Audio 20 is switched off during a call in hands-free mode, the call is disconnected. This can be avoided by taking the following measure; before deactivating Audio 20, switch over to "Private Mode" on the mobile phone (see the mobile phone operating instructions).

911 emergency call

WARNING

The 911 emergency call system is a public service. Using it without due cause is a criminal offense.

The following requirements must be fulfilled for a **911** emergency call:

- the mobile phone must be switched on.
- a network must be available.
- a valid and operational SIM card must be inserted in the mobile phone.
- the mobile phone must be connected to Audio 20 via Bluetooth®.

If you cannot make an emergency call, you must arrange rescue measures yourself.

- ▶ Enter the digits on Audio 20 (▷ page 43).
- ▶ Press the  button.
The telephone makes the connection.
- ▶ Wait for the emergency call center to respond and then describe the emergency.

Telephony via the Bluetooth® interface

Conditions

On the mobile phone

To use Bluetooth® interface telephony in conjunction with Audio 20, you need a Bluetooth®-capable mobile phone.

Not all mobile phones available on the market are equally suitable. You can obtain more detailed information on suitable mobile phones and on connecting Bluetooth®-capable mobile phones to Audio 20 from your authorized Mercedes-Benz Center or on the Internet at <http://www.mbusa-mobile.com> (customers in the USA only).

The battery of the mobile phone should always be kept sufficiently charged in order to prevent malfunctions.

In preparation for telephoning via the Bluetooth® interface, you should check the following items on your mobile phone (see the mobile phone operating instructions):

- Hands-Free Profile
The mobile phone must support Hands-Free Profile 1.0 or above.
Some displays (e.g. the signal strength) depend on the supported version of the hands-free profile.
- Bluetooth® visibility
On certain mobile phones, the device itself must be made "visible" to other devices, as well as activating the Bluetooth® function (see the mobile phone operating instructions).

- Bluetooth® device name

Every Bluetooth® device has its own Bluetooth® device name. This device name is freely definable, but can be identical for all devices from the same manufacturer. It is recommended that the device is given its own name so that your mobile phone can be clearly identified (see separate mobile phone operating instructions).

- Have the mobile phone switched on and, if required, enter your PIN (see the mobile phone operating instructions).
- Activate Bluetooth® functions and, if necessary, activate Bluetooth® visibility on the mobile phone (see the mobile phone operating instructions).

On Audio 20

- ▶ Bluetooth® must be activated in Audio 20 (▷ page 33).

Connecting a mobile phone

General information

Before using your mobile phone with Audio 20 for the first time, you will need to authorize it.

Device-specific information on connecting Bluetooth®-capable mobile phones can be found on the Internet at <http://www.mercedes-benz.com/connect>.

When you authorize a new mobile phone, it is connected automatically.





Connecting comprises:

- searching for a Bluetooth®-capable mobile phone
- subsequently authorizing it

You can connect up to 15 mobile phones.

Once connected, the phone book, call lists and text messages will automatically download to Audio 20 if this function is supported by the connected mobile phone.



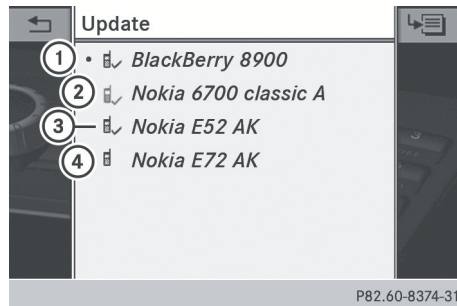

Searching for a mobile phone

- ▶ Press the **TEL** function button on Audio 20.
- ▶ Select **Phone** from the telephone basic menu using the controller (slide  and turn ) and press  to confirm.
- ▶ Select **Connect Phones** and press  to confirm.
- ▶ Select **Update** and press  to confirm.

Audio 20 scans for Bluetooth® devices within range and enters them into the Bluetooth® phone list. The duration of the search depends on the number of Bluetooth® telephones within range and their characteristics.



Example: Bluetooth® phone list

- ① Currently connected • and authorized mobile phone 
- ② Mobile phone not within range but previously authorized ( appears in gray)
- ③ Mobile phone in range and authorized ( appears in black)
- ④ Newly detected mobile phone within range but not yet authorized (no icon yet )

The Bluetooth® telephone list shows all mobile phones within range and all previously authorized mobile phones, whether or not they are in range.

- ❗ If the Bluetooth® telephones list is already full, you will be requested to de-authorize a mobile phone (▷ page 41). If Audio 20

does not find your mobile phone, external authorization (▷ page 40) may be necessary.

- ❗ If you call up the telephone list again, the unauthorized devices are removed from the list. In this case, start a new search to update the Bluetooth® telephone list.

Authorizing a mobile phone

Option 1: using the passcode (access code)

- ▶ Select the mobile phone that is not yet authorized from the Bluetooth® telephone list by turning **⏻** the controller.
- ▶ Select the list symbol to the right of the entry by sliding **⏻** the controller and press **⏻** to confirm.
- ▶ Select **Authorize** and press **⏻** to confirm. The input menu for the passcode appears.



P82.60-8189-31

The passcode is any one to sixteen-digit number combination which you can choose yourself. You must enter the same number combination in Audio 20 and in the Bluetooth®-capable mobile phone (see the mobile phone operating instructions).

- ❗ Some mobile phones require a passcode with four or more digits.

If you want to reauthorize a mobile phone following de-authorization, you can select a different passcode.

- ▶ **To enter a passcode in Audio 20:** press the number keys in succession.

OK is highlighted after the first number has been entered.

or

- ▶ Select the numbers one after another by turning **⏻** the controller and press **⏻** to confirm. Then, select **OK**.

- ▶ **To confirm an entry in Audio 20:** press **⏻** the controller.

- ▶ Now enter the same passcode in the mobile phone.

To make entries on the mobile phone: if the Bluetooth® connection is successful, you will be requested to enter the passcode (access code, code) (see the mobile phone operating instructions).

- ▶ Enter the same passcode in the mobile phone as already entered in Audio 20.

- ❗ After entering the passcode, you may also need to enter a confirmation in your mobile phone to connect calls. Please check your mobile phone display.

If the Audio 20 display shows the **Authorization failed.** message, you may have exceeded the prescribed time period. Repeat the procedure.

The mobile phone is connected to Audio 20 (authorized). You can now use the Audio 20 hands-free function to make calls on your mobile phone.

Option 2: using Secure Simple Pairing

The mobile phone (or the Bluetooth® audio device) must support the Bluetooth® version 2.1 for connection via Secure Simple Pairing. Audio 20 generates a six-digit numeric code that appears simultaneously on both devices that will be connected.

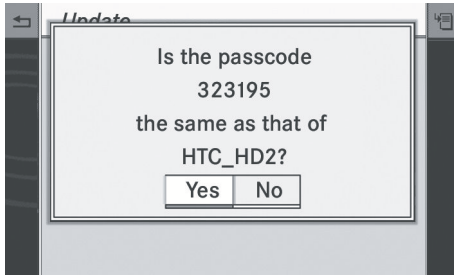

P82.60-8241-31

- ▶ If the numeric code on both devices matches, confirm **Yes** by pressing . If you select **Yes**, the authorization process is completed and the mobile phone is connected. If you select **No**, the process will be canceled.
- ▶ Confirm the message on the mobile phone.

External authorization

If Audio 20 is unable to detect your mobile phone, this may be due to your mobile phone security settings. In this case, please check to see whether your mobile phone can find the Audio 20 system. The Bluetooth® device name for Audio 20 is **MB Bluetooth**.

- ▶ Select **Phone** using the controller (slide , or turn) and press to confirm.
- ▶ Select **Connect Phones** and press to confirm.
- ▶ Select **Update**.
- ▶ Select the list symbol to the right of the entry by sliding the controller and press to confirm.
- ▶ Select **External Authorization** and press to confirm.
- ▶ Start the Bluetooth® search on the mobile phone (see the mobile phone operating instructions).
- ▶ Select Audio 20(**MB Bluetooth**) on the mobile phone.

- ▶ **Option 1:** when requested to do so, enter the passcode on the mobile phone and then in the Audio 20 system.
- ▶ **Option 2:** confirm the numeric code on the mobile phone and in the Audio 20 system (Secure Simple Pairing).

Reconnecting automatically

Audio 20 always searches for the last mobile phone connected.

If no connection can be made to the most recently connected mobile phone, the system searches for the mobile phone that was connected before that one.

Connecting another mobile phone

If you have authorized more than one mobile phone, you can switch between the individual phones.













You can only switch to another authorized phone if you are not currently making a call.

- ▶ Select **Phone** using the controller (slide , or turn) and press to confirm.
- ▶ Select **Connect Phones** and press to confirm.
- ▶ Select the mobile phone from the list and press to confirm. If the selected mobile phone is within Bluetooth® range and Bluetooth® is activated, a search is started and the phone is connected.

Only one mobile phone can be connected at any one time. The currently connected mobile phone is indicated by the dot in the phone list.











Displaying details

For each mobile phone in the telephone list, there is a detailed view.

- ▶ Select **Phone** using the controller (slide ,  or turn ) and press  to confirm.
- ▶ Select **Connect Phones** and press  to confirm.
- ▶ Select the mobile phone from the list.
- ▶ Select the list symbol to the right of the entry by sliding  the controller and press  to confirm.
- ▶ Select **Details** and press  to confirm. The following information concerning the selected mobile phone is shown:
 - Bluetooth® name
 - Bluetooth® address
 - availability status (shown after a search)
 - authorization status
- ▶ **To close the detailed display:** turn , slide ,  or press .

De-registering (de-authorizing) a mobile phone

Mercedes-Benz recommends de-authorization in Audio 20 and in the mobile phone. Subsequent authorization may otherwise fail.

- ▶ Select **Phone** using the controller (slide ,  or turn ) and press  to confirm.
- ▶ Select **Connect Phones** and press  to confirm.
- ▶ Select the mobile phone from the list and press  to confirm.
- ▶ Select the list symbol to the right of the entry by sliding  the controller and press  to confirm.
- ▶ Select **De-Authorize** and press  to confirm. A prompt appears asking whether you really wish to de-authorize this device.
- ▶ Select **Yes** or **No** and press  to confirm. If you select **Yes**, the device will be deleted from the phone list.

If you select **No**, the process will be canceled.

- i** Before re-authorizing the mobile phone, you should also delete the device name **MB Bluetooth** from your mobile phone's Bluetooth® list.



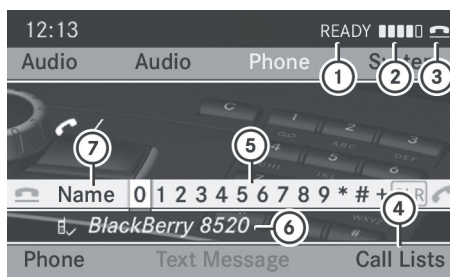

Telephone basic menu (Bluetooth® interface)

- ▶ Press the **TEL** button.



If the connected telephone is ready for use, the following display appears (example):



P82.60-8383-31

- ① Network provider's name (depends on the connected phone)
- ② Signal strength of mobile phone network 
- ③ Receiver icon  or 
- ④ To display call lists
- ⑤ Character bar
- ⑥ Bluetooth® name of the currently connected mobile phone
- ⑦ To display the Audio 20 phone book
- i** Displays ① and ② are shown, depending on the mobile phone connected. Bars ② display the current signal strength of the mobile phone network. If all bars are filled, you have optimum reception. If all bars are empty, there is very poor reception or none at all. Receiver icon ③ shows whether a call is active/being connected  or not .

Text message (SMS) display in telephone basic menu

The  mail symbol is displayed if at least one text message has been received but not yet read. The symbol disappears after all the text messages have been read. The  mail symbol is displayed if the text message memory is full. The symbol disappears after at least one text message has been deleted. The SMS menu item is available if the Bluetooth® telephone supports the Bluetooth® MAP (Message Access Profile) profile and the text messages have been downloaded from the Bluetooth® telephone. The menu item is otherwise grayed out and is not available.

You will find further information in the "Text messaging (SMS)" section (▶ page 51).



Reception and transmission volume





Once the mobile phone has been authorized, you can optimize the transmission and reception volume settings. Find information on the optimal setting for your mobile phone on the Internet at

<http://www.mbusa-mobile.com>.



Alternatively, call the Mercedes-Benz Customer Assistance Center at 1-800-FOR-MERCEDES (1-800-367-6372) (for USA) or Customer Relations at 1-800-387-0100 (for Canada).

 Incorrect settings may have an impact on the quality of calls.

- ▶ Press the **TEL** function button.
- ▶ Select **Phone** from the telephone basic menu by turning  the controller and press  to confirm.

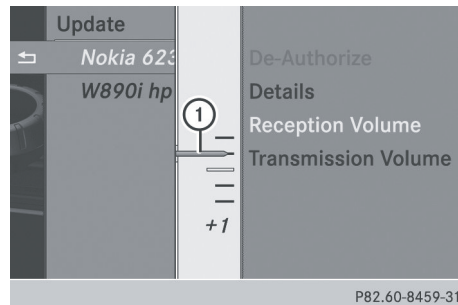
- ▶ Select **Connect Phones** and press  to confirm.
- ▶ Select an authorized mobile phone from the list by turning  the controller.
- ▶ Select the list symbol to the right of the entry by sliding  the controller and press  to confirm.
- ▶ Select **Reception Volume** or **Transmission Volume** and press  to confirm.



- ① Scale with indicator showing current volume
- ▶ Select a volume setting by turning  the controller.
- ▶ **To close the setting scale:** press  or slide .

Telephone operation

Incoming call

Rejecting or accepting a call

When you receive a call, you will hear a ring tone and the incoming call will appear in the display.

i Depending on the mobile phone, the Audio 20 ring tone may differ from the one you set. You could hear one of the following:

- the mobile phone ring tone
- the Audio 20 ring tone
- the Audio 20 ring tone and the mobile phone ring tone.

If the caller's name and number are stored in the Audio 20 phone book and caller ID is enabled, the name and number are displayed. Otherwise, the following appears (example):

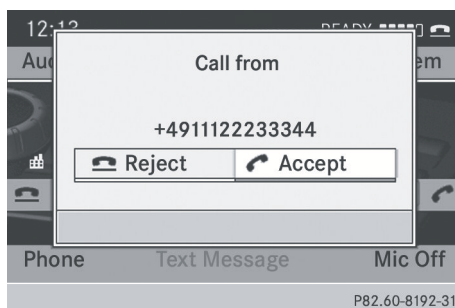



▶ **To accept:** press the  button on Audio20 or on the multifunction steering wheel.

or

▶ Press  the controller.

▶ **To reject:** press the  button on Audio 20 or on the multifunction steering wheel.



or

▶ Select **Reject** using the controller (slide  or turn ) and press  to confirm.

Once you have accepted the call, you can use hands-free mode. You can adjust the call volume (▶ page 21). For more information, see the "Functions available during a call" section (▶ page 45).

i You can also accept a call if the display is showing a display other than the telephone mode. Once you have accepted the call, the display shows telephone mode. After the



call has been ended, the Audio 20 display shows the previously selected mode again. The display does not switch to telephone mode if you:

- hide the window with the  button next to the controller
- accept the call with the  button on the multifunction steering wheel
- accept the call using the  button on Audio 20

Making a call

Entering a telephone number using the number keypad

You can use the number keypad to enter numbers and special characters.

▶ **To enter:** use the  to , and  buttons to enter the characters.

For the * character: press the  button once. Press the button a second time within 1.5 seconds for the + character.

▶ **To delete individual digits:** press the  button.

▶ **To delete an entire number:** press and hold the  button until the entire number has been deleted.

or

▶ Press the  button.

▶ **To finish entry and make a call:** press the  button.

Entering a phone number using the number keypad

In addition to the menu bar, a number bar is displayed in the telephone basic menu.

When the number bar is active (highlighted), you can select an item.

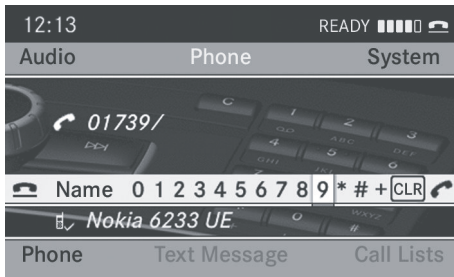

P82.60-8193-31

- ▶ **To enter digits:** slide $\leftarrow \odot \rightarrow$ or turn $\left[\odot \right]$ the controller until the desired number is selected.
- ▶ **To confirm your selection:** press \odot the controller.
- ▶ Repeat this procedure to select all of the desired digits in sequence from the number bar.
- ▶ **To delete individual digits:** slide $\leftarrow \odot \rightarrow$ or turn $\left[\odot \right]$ the controller until **CLR** is highlighted.
- ▶ Press \odot the controller.
- ▶ **To delete a number sequence:** slide $\leftarrow \odot \rightarrow$ or turn $\left[\odot \right]$ the controller until **CLR** is selected.
- ▶ Press \odot the controller until the number sequence is deleted.

or

- ▶ Select $\left[\text{Call} \right]$ using the controller (slide $\leftarrow \odot \rightarrow$ or turn $\left[\odot \right]$) and press \odot to confirm.
- ▶ **To make a call:** select $\left[\text{Call} \right]$ and press \odot to confirm.

Using a number from the phone book

- ▶ Select **Name** using the controller (slide $\leftarrow \odot \rightarrow$ or turn $\left[\odot \right]$) and press \odot to confirm.
- ▶ Select the entry using the controller (slide $\uparrow \odot \downarrow$ or turn $\left[\odot \right]$) and press \odot to confirm (\triangleright page 47).
- ▶ Press the $\left[\text{Call} \right]$ button or the \odot controller.

- i** Operation using the multifunction steering wheel (\triangleright page 48)

Dialing a telephone number from a call list

- ▶ Select **Call Lists** using the controller (slide $\leftarrow \odot \rightarrow$, $\leftarrow \odot \rightarrow$ or turn $\left[\odot \right]$) and press \odot to confirm.
- ▶ Select **Calls Received** or **Calls Dialed** and press \odot to confirm.
- ▶ Select the entry and press \odot to confirm (\triangleright page 49).
- ▶ Press the $\left[\text{Call} \right]$ button or the \odot controller.

- i** Operation using the multifunction steering wheel (\triangleright page 49)

Redialing

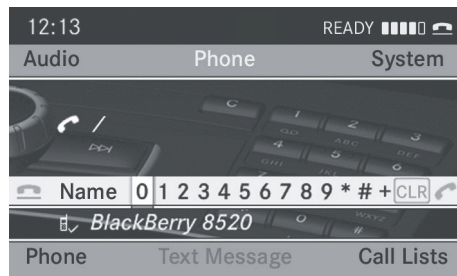

P82.60-8380-31

- i** Requirement: no characters should have been entered.

- ▶ Press the $\left[\text{Call} \right]$ button.

or

- ▶ Select $\left[\text{Call} \right]$ and press \odot the controller. The most recently dialed telephone numbers are displayed.







- ▶ Select the desired telephone number.

- ▶ Press the $\left[\text{Call} \right]$ button.

or

- ▶ In the telephone basic menu in the instrument cluster: press the $\left[\text{Call} \right]$ button on the multifunction steering wheel.

Canceling dialing or ending a call

- ▶ Select  in the display using the controller (slide ,  or turn ) and press  to confirm.
- ▶ Press the  button on Audio 20 or on the multifunction steering wheel.







Making a call via speed dial

The speed dial list contains stored phone book entries (▷ page 46).

Option 1:

- ▶ Hold down one of the number keys for longer than two seconds.





Option 2:

- ▶ Call up the telephone basic menu:
 - telephony via the Bluetooth® interface (▷ page 41)
- ▶ Select **Call Lists** using the controller (slide ,  or turn ) and press  to confirm.
- ▶ Select **Speed Dial Preset List** by turning  the controller and press  to confirm. The speed dial list appears.
- ▶ Select the storage location and press  to confirm. Irrespective of the option chosen, the telephone basic menu appears and displays the selected entry. This initiates dialing.

Functions available during a call

Switching the hands-free microphone on/off

The menu bar changes when you make a call. Instead of the **Call Lists** menu item, you will see **Mic Off** or **Mic On**.

- ▶ **To switch off:** select **Mic Off** using the controller (slide ,  or turn ) and press  to confirm.

The message: **The microphone is off** appears briefly.

If the microphone is switched off, the  symbol appears in the main area. The person you are calling cannot hear any sounds from inside your vehicle.

- ▶ **To switch on:** select **Mic On** and press  to confirm.

The message: **The microphone is on** appears briefly.

The  symbol disappears.



Sending DTMF tones

- ▶  This function is not supported by all mobile phones.



Answering machines or other devices can be controlled by DTMF tones, e.g. for remote query functions.

- ▶ During an active call, press the respective keys on the number keypad. Every character selected will be transmitted immediately.

or

- ▶ **To select a character:** slide ,  or turn .

- ▶ **To confirm your selection:** press the  controller.

- ▶ **To send a phone book entry as a DTMF sequence:** select **Name** by turning  the controller and press  to confirm.

- ▶ Select the desired phone book entry and press  to confirm.

The entry is sent as a DTMF character string.

- ▶ **To return to the call display:** select **Back** and press  to confirm.

Using the phone book

Introduction

As long as the mobile phone supports downloading contacts via PBAP (Phone Book Access Profile), the mobile phone book will automatically download to the Audio 20 system when connected. You can also import contacts to the phone book from a USB device or use Bluetooth® to receive vCards.

- i** The phone book can store between 1,000 and 2,000 entries, depending on the size of the entries. Imported vCards are given priority when storing, and overwrite existing PBAP contacts if the memory is full.
- i** Imported contacts are stored permanently in the phone book. For this reason, you should delete the call lists before selling the vehicle.







Importing external data

Receiving vCards (via the Bluetooth® interface)

Received vCards are identified by the  symbol.

You can import vCards from external Bluetooth®-capable phones into the address book. Please bear the following in mind:







- Bluetooth® must be active on Audio 20 and on the external Bluetooth®-capable telephone; see (> page 33) and the operating instructions of the respective mobile phone.
- the external Bluetooth® phone must be able to send vCards via Bluetooth® (see the operating instructions of the respective mobile phone).
- i** If you switch to another operating mode during vCard reception (e.g. press the  button), vCard reception is canceled.

- ▶ Select **Phone** using the controller (slide ,  or turn ) and press  to confirm.
- ▶ Select **Download Contacts** and press  to confirm.
The Bluetooth® connection between Audio 20 and your active mobile phone is interrupted. Audio 20 is now ready to receive vCards from other mobile phones.
- ▶ Start data transfer on the external Bluetooth® phone (see operating instructions of the respective mobile phone).
The data on the vCards is automatically transferred to the address book. The number of vCards received is displayed.
- ▶ Select **Back** and press  to confirm, or switch to another operating mode to cancel reception.

Importing from a USB device

Imported USB device entries are marked with the  symbol.

The following conditions must be fulfilled in order to import vCards:

- vCards (vcf files) can be placed in folders. Audio 20 allows you to select the relevant folders directly.
- vCards must have the file extension "vcf".
- i** One vCard file may contain several vCards.
Audio 20 supports vCards in versions 2.1 and 3.0.
- ▶ Select **Phone** from the telephone basic menu using the controller (slide  and turn ) and press  to confirm.
- ▶ Select **Download Contacts** and press  to confirm.
A menu appears.
- ▶ Select **From USB device** from the menu by turning  the controller and press  to confirm.

- ▶ Select **Add** or **Overwrite** and press to confirm.
Add imports the entries from the USB device to the phone book.
Overwrite imports the entries from the USB device and overwrites all entries in the phone book marked with the symbol. The previous entries are then no longer available.

After the contact data has been imported successfully, you will see a message to this effect. The corresponding telephone basic menu appears.

- i** You can select the **Overwrite** menu item if the phone book already contains corresponding entries. A message notifies you if the phone book is full.

Deleting contacts

This function allows you to delete personal data from the phone book.

- ▶ Select **Phone** using the controller (slide or turn) and press to confirm.
- ▶ Select **Delete Contacts** and press to confirm.
A prompt appears asking whether the data should be deleted.
- ▶ Select **Yes** or **No** and press to confirm.

Calling up the phone book

Overview

- ▶ Select **Name** using the controller (slide or turn) and press to confirm.

If the phone book contains entries, they will be displayed in alphabetical order. The character bar appears at the bottom and is active.

The character bar serves to reduce the number of entries needed.

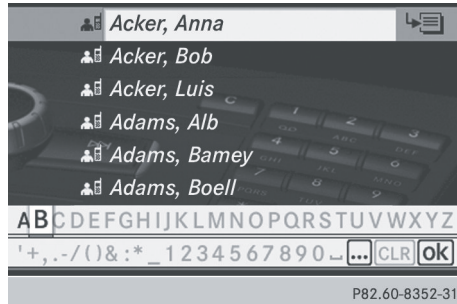

- ▶ **To switch from the character bar to the list:** slide the controller or press repeatedly until the character bar disappears.
- ▶ **To switch from the list to the character bar:** press the **BACK** button on the controller.

Symbol overview

Symbol	Explanation
	Contact imported from a mobile phone that supports PBAP
	Entry imported from the USB device
	Entry imported via the Bluetooth® interface

Selecting an entry using the character bar

Selecting a character from the character bar

- ▶ First switch to the character bar when the list appears.

You determine the first letter of the entry you are looking for with the first character you enter.

- ▶ Slide or turn the controller.
- ▶ **To confirm your selection:** press the controller.

The first entry in the list that starts with the letter selected is highlighted. If there are similar entries, the next different character is shown. For example, with entries such as **Hil**den and **Hil**gers, the beginnings of the names are similar. In this case you will be offered a choice between **D** and **G**.



- ▶ Select the characters of the entry you are searching for one by one and press  to confirm.

As soon as you make a clear selection, Audio 20 switches automatically to the list.



- ▶ **To complete the search:** switch from the character bar to the list.

The first list entry is automatically highlighted.

Changing the language of the character bar



- ▶ Select  and press  to confirm.
- ▶ Select the desired language and press  to confirm.

Changing the character set of the character bar





- ▶ Select  and press  to confirm.
Depending on the previous setting, the entry mode changes to special characters or to letters with numbers.

Selecting an entry directly from the list

Using the controller







- ▶ You can switch to the list after the character bar appears.
- ▶ Turn  or slide  the controller to select an entry and press  to confirm.

Using the buttons on the multifunction steering wheel

- ▶ In the telephone basic menu in the instrument cluster: press the  or  button briefly.
The previous/next entry in the phone book is displayed.
- ▶ In the telephone basic menu in the instrument cluster: press and hold the  or  button for longer than two seconds.
The first entry in the list that has the previous/next first letter in the phone book is shown.
- ▶ **To make a call:** press the  button.

Displaying details for an entry

Audio 20 can also display a shortened entry in full.

- ▶ Select an entry from the list.
- ▶ Select the list symbol to the right of the entry by sliding  the controller and press  to confirm.
- ▶ Select **Details** and press  to confirm.
The detailed view appears.
- ▶ **To close the detailed display:** turn  or slide  or  the controller and press .

Using call lists

Introduction

Audio 20 displays calls dialed and received (including missed calls) during phone operation in separate lists. Call lists are not available unless a mobile phone is connected with Audio 20.

Audio 20 supports the PBAP Bluetooth® profile. For this reason, note that the system behavior differs, especially when telephoning via the Bluetooth® interface:

- Bluetooth® telephone with PBAP Bluetooth® profile:

the call lists are downloaded automatically by Audio 20 as soon as the mobile phone is connected to Audio 20.

- Bluetooth® telephone without PBAP Bluetooth® profile:





the call lists are generated and displayed by Audio 20.

- ① Bluetooth® phones without PBAP Bluetooth® profile: the call lists generated by Audio 20 are not synchronous with the call lists of your mobile phone. These calls may or may not be listed on your mobile phone, depending on the model.

- ② If no mobile phone is connected, then the **Call Lists** menu item is grayed out and cannot be selected. If you connect a different mobile phone with Audio 20 then the previously available call lists and their entries will be deleted automatically. They are still available on the mobile phone itself.

- ③ The respective menu item can only be selected if calls have been received or made using Audio 20.

Opening the call list and selecting an entry

- ▶ Select **Call Lists** using the controller (slide ,  or turn ) and confirm with .
- ▶ Select **Calls Received** or **Calls Dialed** and press  to confirm. The corresponding list appears (example):

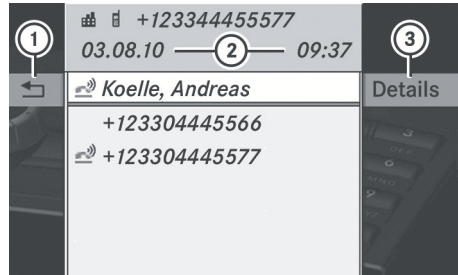





P82.60-8197-31

- ① To close the list
- ② Date/time (if available), symbols (if assigned) and telephone number of the entry highlighted
- ③ To call up details

Missed calls are marked by the telephone symbol to the left of the name or the number.



- ④ You can also call up the list of dialed calls by pressing the  button when the telephone basic menu is shown. In this case, the list will only show phone numbers.

▶ **To select a list entry:** slide  or turn  the controller.

▶ **To make a call:** press  the controller or the  button.

Using the buttons on the multifunction steering wheel

- ▶ In the telephone basic menu in the instrument cluster: press the  button. The **Calls Dialed** call list is shown. The entry at the top of the list (the last number dialed) is highlighted.

▶ **To select a list entry:** press the  or  button.

▶ **To make a call:** press .

Deleting call lists

This function is available if Audio 20 creates and manages call lists. This is the case if you use a Bluetooth® telephone without the support of the PBAP Bluetooth® profile.

- ▶ Select **Call Lists** from the telephone basic menu by turning the controller and confirm with .
- ▶ Select **Delete Call Lists** and press to confirm.
A prompt appears asking whether you wish to delete all call lists.
- ▶ Select **Yes** or **No** and press to confirm.
If you select **Yes**, the call lists are deleted.
If you select **No**, the process will be canceled.

Using the speed dial list

Storing a phone book entry in the speed dial list

You can assign ten speed dial presets (0 – 9) to the speed dial list.

Option 1:

- ▶ Search for a phone book entry in the phone book (▶ page 47).
- ▶ Select the list symbol to the right of the entry by sliding the controller and press to confirm.
A menu appears.
- ▶ Select **Speed Dial** by turning the controller and press to confirm.
A menu appears.

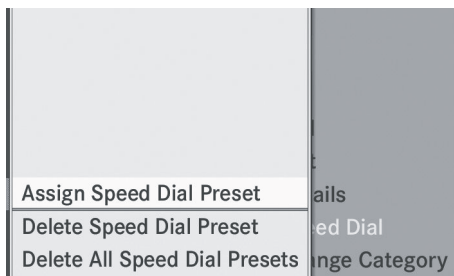

P82.60-8249-31

Speed dial menu

- ▶ Select **Assign Speed Dial Preset** using the controller and press to confirm.
The speed dial list appears. The selected phone book entry is listed as the first entry.

The next available speed dial preset is highlighted.

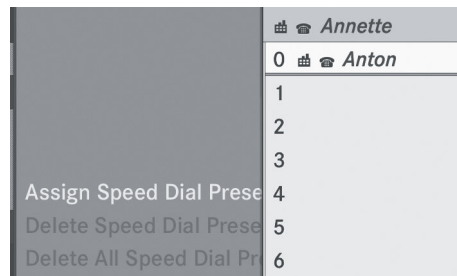

P82.60-8250-31

- ▶ Select the speed dial preset by turning the controller and press to confirm.
The phone book entry is saved in the speed dial preset.

Option 2



- ▶ Call up the telephone basic menu:
 - telephony via the Bluetooth® interface (▶ page 41)
- ▶ Select **Call Lists** using the controller (slide and turn) and press to confirm.
- ▶ Select **Speed Dial Preset List** and press to confirm.
The speed dial list appears.
- ▶ Select the list symbol to the right of the entry by sliding the controller and press to confirm.
- ▶ Select **Assign Speed Dial Preset** and press to confirm.
- ▶ Proceed as described under option 1.



Making a call via speed dial

A description can be found in the "Telephone operation" section (▶ page 45).

Deleting a speed dial number

- ▶ **To delete a speed dial preset:** select **Delete Speed Dial Preset** from the

speed dial menu by turning  the controller and press  to confirm. The speed dial number is deleted.

- ▶ **To delete all speed dial presets:** select **Delete All Speed Dial Presets** from the speed dial menu by turning  the controller and press  to confirm. You will be asked whether you want to continue.
- ▶ Select **Yes** or **No** and press  to confirm. If you select **Yes**, all speed dial presets will be deleted from the speed dial list. If you select **No**, the process will be canceled.

Text messages (SMS)

Information and requirements



The following conditions must be met in order to use the functions:

The Bluetooth® mobile phone supports the MAP Bluetooth® profile (**M**essage **A**ccess **P**rofile).

When the mobile phone is connected, the 30 most recent text messages currently stored in the phone's text message inbox are loaded to Audio 20's text message (SMS) inbox and displayed.

- ❗ Audio 20 does not load all the newest text messages:





This may occur in exceptional cases, for example when using certain mobile phones and when the mobile phone inbox holds many text messages.

Once the above conditions are met, new text messages arriving in the Audio 20 text message inbox are displayed. In addition, an audible signal sounds and the  symbol appears. The symbol disappears once you have read the text message. The  mail symbol is displayed when the text message

memory is full. The symbol disappears after at least one text message has been deleted.

Displaying the text message (SMS) inbox

Overview

- ▶ Select **Text Message** using the controller (slide ,  or turn ) and press  to confirm. The list of received text messages appears. Unread messages are displayed using the  message icon.

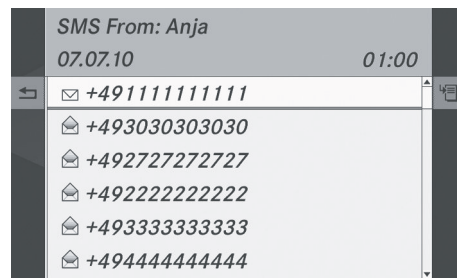

There are two types of display: the sender display and the text display.



P82.87-6405-31

The sender display shows the sender of the text message. If the sender is stored in the phone book, the name will be displayed. If the sender is not stored in the phone book, the telephone number will be displayed.

The text display shows the first few words of a text message.

- ▶ **To switch to text display:** select the list symbol to the right of the text message by sliding  the controller and press  to confirm.
- ▶ Select **Display Text** and press  to confirm. The view changes.

- ▶ **To switch to the sender display:** select **Display Sender** and press to confirm. The view changes.
- ▶ **To select a text message:** turn or slide the controller.

Reading a text message (SMS)

- ▶ Select **Text Message** using the controller (slide , or turn) and press to confirm.
- ▶ Select a text message and press . The text message appears.
- ▶ **To scroll through the display or select telephone numbers in the text:** turn or slide the controller. The display scrolls up or down line by line, or skips to the next or previous telephone number and automatically highlights it.
- ▶ **To return to the list:** press , or select **Back** and press to confirm.

Displaying details

Audio 20 can also show the full details instead of the shortened sender view.

- ▶ Select a text message and press (> page 51) to confirm.
- ▶ Select the list symbol to the right of the text message by sliding the controller and press to confirm.
- ▶ Select **Details** and press to confirm. The detailed view appears.
- ▶ **To close the detailed view:** slide or press the controller.

Managing text messages

Calling a text message (SMS) sender

- ▶ Press , select **Call Sender** and press to confirm.

Using phone numbers in the text

- i** This function requires that the text message contain numbers that can be interpreted as telephone numbers.
- ▶ **To call the telephone number used in the text message:** highlight the telephone number, press the controller, select **Call Number** and press to confirm.

Deleting a text message (SMS)

The symbol is displayed when the text message memory is full. In order to be able to receive new text messages, you must delete old messages.

- i** This function deletes a text message from Audio 20 and the mobile telephone. Some mobile phones do not support this function. In such cases, the text message is only deleted from the memory of Audio 20.

Select **Text Message** using the controller (slide , or turn) and press to confirm.

- ▶ Select a text message and press (> page 51) to confirm.
- ▶ Select the list symbol to the right of the text message by sliding the controller and press to confirm.
- ▶ Select **Delete** and press to confirm. A prompt appears asking whether the data should be deleted.
- ▶ Select **Yes** or **No** and press to confirm. The text message will either be deleted or not, depending on your selection.

Audio device features	54
Radio mode	54
Satellite radio	57
Audio CD and MP3 mode	62
Bluetooth® audio	68
Media Interface mode	73
Audio AUX mode	78

Audio device features

i These Operating Instructions describe all standard and optional equipment available for your audio device at the time of going to print. Country-specific deviations are possible. Please note that your audio equipment may not offer all the features described.

Audio

Radio mode

Introduction

i Information about operating Audio 20 can be found in the "At a glance" section (> page 18).

Information about the sound settings can be found in the "Basic functions of Audio 20" (> page 21) section.

i Portable electronic devices in the vehicle may seriously impair radio reception.

Notes on HD Radio™

- i** The functions of HD Radio include:
- digital transmission in the same wavebands as analog AM/FM. The analog AM/FM stations remain in the same position when selecting a station.
 - ability to broadcast several program streams over a single AM/FM frequency (e.g. HD1, HD2 etc.)
 - interference-free, clear reception
 - FM: sound in CD quality; AM: sound as on analog FM stations
 - a wide range of data services, text-based information – name of artist, name of song etc. – on the display

For further information on HD Radio, visit <http://www.hdradio.com>.

You can deactivate HD Radio for the selected frequency in the radio submenu.

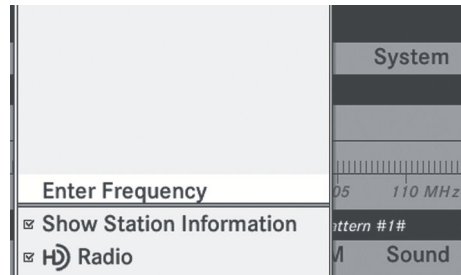

P82.60-8176-31

- ▶ Select **Radio** in the radio display by sliding **⊙** ↓ the COMAND controller and press **⊙** to confirm.
- ▶ Select **HD Radio** and press **⊙** to confirm. HD Radio is deactivated if the check box is empty. You hear the analog program of this frequency. As soon as you change to another HD Radio frequency, the HD Radio is reactivated.

Switching to radio mode

Switching to radio mode

Option 1

- ▶ Press the **RADIO** function button. The radio display appears.

Radio mode: you will hear the last station played on the last waveband selected.

- i** Repeatedly pressing the **RADIO** function button switches between the FM, AM and WB wavebands in that order and then calls up SatRadio mode. Pressing the button again takes you back to FM radio mode.

Option 2

- ▶ Select **Audio** from the main function bar using the controller (slide **↑** **⊙** and turn **⊙**) and press **⊙** to confirm. If radio mode was the last mode selected, it will now be active.

If another audio mode is switched on, you can now switch to radio mode in the audio menu.

Radio display



P82.60-8201-31

Radio display

- ① Main function bar
 - ② Display showing station name (if available)
 - ③ Frequency of the selected station
 - ④ Display/selection window showing station name or frequency
 - ⑤ Sound settings
 - ⑥ To switch between FM, AM and WB
 - ⑦ To display radio text
 - ⑧ Memory functions
 - ⑨ Radio functions
 - ⑩ HD Radio logo (only with HD Radio reception)
- i** If the station supports radio text and information is available, the system shows it below the display/selection window.

Switching wavebands

You can switch the radio waveband between FM, MW, WB and SatRadio.

Waveband	Frequency
FM (VHF)	87.7.....107.9 Mhz
MW (medium wave)	530.....1710 kHz

Waveband	Frequency
WB (weather band)	Weather report channels
Satellite radio	Satellite radio stations

- ▶ Press the **RADIO** button as often as necessary.

Subprograms (HD Radio mode)

In HD Radio mode several subprograms can be transmitted on a single frequency. The subprograms are marked HD1, HD2 etc.

Selecting a station

Selecting a station using the station search function

- ▶ Press the **RADIO** button once or several times until the **FM**, **AM** or **WB** waveband appears in the submenu bar.
- ▶ When the main area is selected, slide **←** or **→** or turn **⏻** the controller.

or

- ▶ Press the **⏮** or **⏭** button. Station search scans up or down and stops at the next station, subprogram (HD Radio mode) or channel (SatRadio mode) found.

Selecting channels via the channel presets

- ▶ **Quick setting:** press a number key, e.g. **2** **ABC**.
- ▶ **Directly in the station memory:** slide **⏮**, **←** or **→** or turn **⏻** the controller to select **Preset**s and press **⏻** to confirm.
- ▶ Select the desired station and briefly press **⏻**.

Selecting stations by entering the frequency manually

- ▶ Select **Radio** using the controller (slide $\odot \updownarrow$, $\leftrightarrow \odot$ or turn $\odot \left[\odot \right]$) and press \odot to confirm.
- ▶ Select **Enter Frequency** and press \odot to confirm.

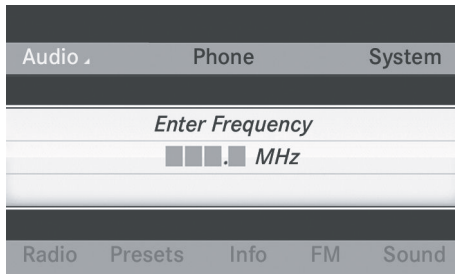

P82.60-8177-31

- i** Only permissible numbers for the frequency range can be entered in front of the decimal point. If a non-permissible number is entered after the decimal point, the next lowest frequency is set.
- ▶ Press the number keys on the number keypad.
Audio 20 tunes in to the frequency.

Setting a station via the multifunction steering wheel

- ▶ In the audio menu in the instrument cluster: press the \blacktriangle or \blacktriangledown button briefly.
The next or the previous station from the station list is set.
- ▶ In the audio menu in the instrument cluster: press and hold the \blacktriangle or \blacktriangledown button for longer than two seconds.
The previous or next station/channel in the waveband will be set.

Storing stations

Storing stations manually

Ten stations can be stored for each waveband.

- i** If a selected preset is already occupied, the new station will be stored in place of the old station.

- ▶ **Quick save:** once you have selected the main area, press and hold a number key (0 to 9) until you hear a tone.

The station is now stored on the selected preset.

- ▶ **Directly in the station memory:** press \odot the controller when the main area is selected.

or

- ▶ Select **Presets** using the controller (slide $\odot \updownarrow$, $\leftrightarrow \odot$ or turn $\odot \left[\odot \right]$) and press \odot to confirm.

The station preset display appears.



P82.60-8204-31

The \bullet dot in front of a preset position indicates that the currently selected channel is stored there.

- ▶ **To assign a new preset:** slide $\updownarrow \odot$ or turn $\left[\odot \right]$ the controller and press \odot until you hear a tone.

or

- ▶ Press and hold a number key (0 to 9) on the number keypad until you hear a tone.
The station is now stored on the selected preset.

Storing channels automatically

- i** This function automatically stores receivable stations in order of their reception quality. Any channels stored manually in the preset memory will be lost. If the process is interrupted by a traffic announcement, you must repeat it.
- ▶ Select **Presets** using the controller (slide $\odot \updownarrow$, $\leftarrow \odot \rightarrow$ or turn $\{\odot\}$) and press \odot to confirm.
 - ▶ Select **Autostore** and press \odot to confirm. Audio 20 searches for stations with adequate reception. The available stations are automatically stored in the preset positions. The first station found is played automatically.

Radio text/radio text plus

Radio text is additional data that has been transmitted and is shown in the Audio 20 display. Such additional data can be the station name, the name of the program or current news.

- ▶ **To display radio text:** slide $\odot \updownarrow$, $\leftarrow \odot \rightarrow$ or turn $\{\odot\}$ the controller to select **Info** and press \odot to confirm. If the station supports radio text and information is available, the system displays it.

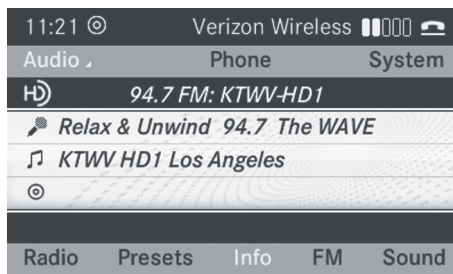

P82.60-8217-31

Radio text: example display

If no additional text information is available, the **No Information** message appears.

- ▶ **To exit the menu:** slide $\odot \updownarrow$, $\leftarrow \odot \rightarrow$ or turn $\{\odot\}$ the controller to select **Info** and press \odot to confirm.
- or
- ▶ Press the **BACK** back button on the controller.

Switching the station information display on/off

- ▶ In the radio display slide $\odot \updownarrow$ and turn $\{\odot\}$ the controller to select **Radio** and press \odot to confirm.
- ▶ Select **Show Station Information** and press \odot to confirm. Switch the display on or off .

Satellite radio

Important notes

This section provides detailed information on the following topics:

- selecting a channel and program category
 - memory functions
 - sound settings
- i** The satellite radio mode described below requires optionally available satellite radio equipment and registration with a satellite radio provider.
- i** Note that the categories and channels shown in the illustrations depend on the program content offered by the provider. The program content may vary. The illustrations and descriptions in these operating instructions may therefore differ from the channels and categories offered by the provider.
- SatRadio mode may be temporarily interrupted or unavailable for a variety of reasons. These reasons include

environmental or topographical conditions as well as other issues beyond the control of Mercedes-Benz USA, LLC. Operation may also be impaired in certain locations (e.g. tunnels, parking garages as well as inside or next to buildings) or in the vicinity of other constructions.

- i** SIRIUS XM Radio offers more than 130 digital-quality radio channels providing 100% commercial-free music, sport, news and entertainment.

SIRIUS XM Radio employs a fleet of high-performance satellites to broadcast around the clock throughout the USA and Canada. The satellite radio program is available for a monthly fee. Details are available from the SIRIUS XM Service Center and at <http://www.sirius.com> (USA) or <http://www.siriuscanada.com> (Canada).

Registering satellite radio

- ▶ Switch on satellite radio mode (▷ page 59).
The SatRadio basic menu appears showing the weather channel. You cannot select any other stations.
- ▶ Select **Sat** in the menu bar and press **↵** to confirm.
- ▶ Select **Service** and press **↵** to confirm.
The service information screen appears.



P82.60-8353-31

Service information screen

- ① Telephone number of the satellite radio provider (SIRIUS XM Radio)
 - ② SIRIUS XM ID of your satellite radio receiver
- ▶ Call the phone number of your satellite radio provider shown on the screen.
- i** You can also have the satellite service activated online. To do so, visit the SIRIUS XM Radio website at <http://www.sirius.com> (USA) or <http://www.siriuscanada.com> (Canada).

Once the connection has been established:

- ▶ Follow the instructions of the service staff. The activation process may take up to ten minutes. If the activation is successful, the **Updating Channels...** message appears in the display, followed by the SatRadio basic menu.
- i** If registration is not included when purchasing the system, your credit card details will be required to activate your account.
If the satellite radio receiver is not installed or is not installed correctly, the **Device Unavailable** message will appear.

Switching on satellite radio mode

Notes

You can also use the multifunction steering wheel to tune in channels or scroll through lists, e.g. by pressing the ◀ ▶ buttons

▲ ▼ buttons (▷ page 18).

For important notes on registration, see "Registering satellite radio" (▷ page 58).

▶ Press the **RADIO** function button.

The **No Service** message appears when starting up or if no signal is being received. Once Audio20 receives the signal, the SatRadio basic menu appears. The station last selected is played.

i Repeatedly pressing this function button switches through the wavebands in the order FM, AM, WB and subsequently switches on the satellite radio. Pressing the button again takes you back to FM radio mode.

If the satellite radio receiver is not installed or is not installed correctly, the **Device Unavailable** message will appear.

Once Audio20 receives the signal, the SatRadio basic menu appears. The station last selected is played.

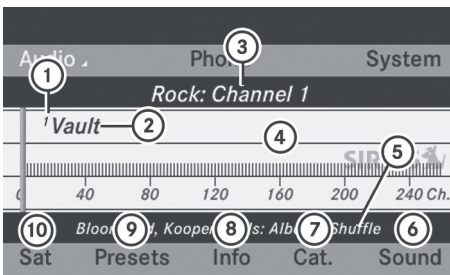

P82.60-8354-31

- ① Channel preset number
- ② Channel name
- ③ Selected category/channel number
- ④ Display/selection window
- ⑤ Channel information
- ⑥ Sound settings

- ⑦ To call up the category list
- ⑧ To show channel information (detailed) in the display/selection window
- ⑨ To call up the channel preset list
- ⑩ To call up the SatRadio menu

Channel information ⑧ can be viewed in detail (▷ page 61).

Changing the category

Satellite radio stations are sorted into various categories. You can choose between the different categories, such as news/talk shows, sports or country, if they are available. The category list is sorted alphabetically.

Selecting a category

▶ **To call up the category list:** select **Category** by turning **⏪** the controller and press **⏩** to confirm.

The category list appears.

▶ **To select a category:** select a category by turning **⏪** the controller and press **⏩** to confirm.

The category selected is shown in the display. You hear the station last selected for this category.

The **All Channels** category is shown at the top of the category list. This category is sorted numerically by channel number and allows you to browse all available channels.

Selecting a channel

Channel search

▶ When the display/selection window is active, turn **⏪** or slide **←→** the controller.

or

▶ Press the **⏮** or **⏭** button.

Audio 20 searches in both directions (ascending and descending) and stops at

the next channel found in the selected category.

SatRadio menu

- ▶ In the menu bar, select **Sat** by turning **[⊙]** the controller and press **[⊙]** to confirm.
The SatRadio menu appears.

Entering channel numbers directly

Option 1

- ▶ Press the **[*]** button.
An input menu appears.

Option 2

- ▶ In the menu bar, select **Sat** by turning **[⊙]** the controller and press **[⊙]** to confirm.
- ▶ Select **Enter Channel** and press **[⊙]** to confirm.
An input menu appears.
- ▶ **To enter a channel:** irrespective of the option, press the corresponding number keys on the control panel one after the other.
Audio 20 sets the selected channel.

i You can only select currently permitted digits.

Selecting a channel from the SatRadio channel list

You can call up two different channel lists:

- channel lists with a channel number and channel name
- channel lists with additional information about the artist and track name on the current program, if transmitted with the program.

- ▶ In the menu bar, select **Sat** by turning **[⊙]** the controller and press **[⊙]** to confirm.
- ▶ Select **Channel List** or **Channel List with Artist, Title** and press **[⊙]** to confirm.
The selected channel list appears.
- ▶ Select a channel by turning **[⊙]** the controller and press **[⊙]** to confirm.

Memory functions

Storing channels

- i** There are ten presets available.
 - ▶ Press **[⊙]** the controller when the display/selection window is active.
- or
- ▶ In the menu bar, select **Presets** by turning **[⊙]** the controller and press **[⊙]** to confirm.
In both cases, the channel presets appear.
The **•** dot in front of a preset entry indicates that the currently selected channel is stored under this preset.

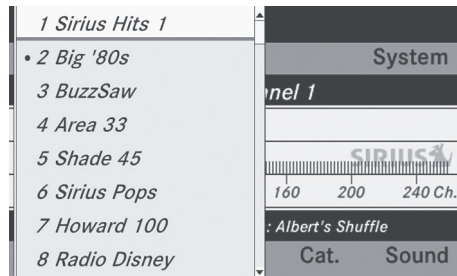

P82.60-8355-31

Channel presets

- ▶ Select a preset by turning the controller, then press and hold until a tone sounds.

or

- ▶ Press and hold a number button, e.g. , until you hear a tone. The current channel is stored under the preset.

Selecting a channel from the preset list

- ▶ **To call up the preset list:** in the menu bar, select **Presets** by turning the controller, then press to confirm. The channel preset list appears.
 - ▶ **To set a channel:** select a preset by turning the controller and press to confirm.
- or
- ▶ Press a number key, such as .

Displaying information

- ▶ In the menu bar, select **Info** by turning the controller and press to confirm. Information on the currently received program is displayed.

If available, you see:

- the full name
- additional information

- ▶ **To return to the SatRadio basic menu:** slide the controller.

Displaying service information

The provider's customer service center is available by phone at any time to answer any general questions or questions on the versions available.

- ▶ In the menu bar, select **Sat** by turning the controller and press to confirm.
- ▶ Select **Service** and press to confirm. The provider's details appear.

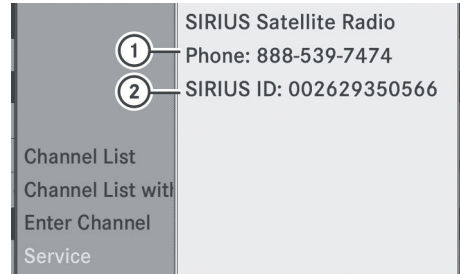

P82.60-8353-31

Service information screen

- ① Telephone number of the satellite radio provider (SIRIUS XM Radio)
- ② SIRIUS XM ID of your satellite radio receiver

- ▶ **To return to the SatRadio basic menu:** slide the controller.

Channel list updates

When receiving a new channel list, the display shows the **Updating Channels...** message.

The station last selected is switched to mute until the update has been completed. Satellite radio mode is not available during this process.

Once the update has been completed, the satellite radio main menu appears. The station last selected is played.

Sound settings

You will find details on the sound settings in the "At a glance" section (▶ page 21).

Audio CD and MP3 mode

Important safety notes

WARNING

The CD drive is a class 1 laser product. There is a risk of damage to the eyes due to exposure to invisible laser radiation if you open the casing, or if the casing is faulty or damaged.

You must not open the casing. The unit contains no parts on which you can carry out maintenance. For safety reasons, all maintenance work must be carried out by qualified aftersales technicians.

WARNING

Only when the vehicle is stationary should you:

- insert a data carrier
- eject a disc

There is a risk of being distracted from the road and traffic conditions if you insert or eject a disc while the vehicle is in motion.

Audio 20 is equipped with a single CD drive. The drive can play back audio CDs and MP3 CDs. The settings available in the menu may vary depending on the type of disc.

Inserting and removing CDs

Notes

If the CD has a printed side, this must face upwards when the CD is inserted. If neither side is printed, the side to be played should face downwards. The system may not be able to play discs with copy protection.

-  If a medium contains other files in addition to music files, the loading time before the first track starts to play may be longer.

Inserting a disc into the single CD drive

- ▶ Press the  eject button.
If there is a disc already inserted, it will be ejected.
- ▶ Take the disc out of the slot.
- ▶ Insert a disc into the slot.
The disc is drawn in and playback starts if the disc has been inserted correctly and if it is a permissible type.

Removing a disc from the single CD drive

- ▶ Press the  eject button.
- ▶ Take the disc out of the slot.
If you do not remove the disc from the slot, Audio 20 will draw it in again automatically after a short time and reload it.

Connecting a USB device

The USB port is located under the center console armrest.

Electrical consumption at this connection must not exceed a continuous current of 500 mA. If the electrical consumption is higher, use a separate source to provide power for the USB device (e.g. 12 V power supply).

The following data formats are supported:

- AAC: fixed and variable bit rates (Low Complexity Profile)
- MP3, WMA: fixed and variable bit rates up to 320 kbit/s
- ▶ Connect the USB device (e.g. USB stick) to the USB port.

Switching to audio CD or MP3 mode

Option 1

- ▶ Insert the CD (▷ page 62) or connect the USB device (▷ page 62).
Audio 20 loads the inserted medium and playback starts.

Option 2

- ▶ Press the **[disc]** function button one or more times.

- i By pressing the function button repeatedly, you can change the operating mode in the following order:
 - audio CD/MP3 CD in the single CD drive (disc mode)
 - USB storage device
 - Media Interface or audio AUX mode
 - Bluetooth® audio mode

- ▶ Select an audio medium from the media list.

Option 3

- ▶ Select **Audio** from the main function bar using the controller (slide \uparrow and turn \leftarrow) and press \rightarrow to confirm. The last active audio source is now activated.

You can activate a different audio source using the audio menu.

- ▶ Select **Audio** using the controller (slide \uparrow and turn \leftarrow) and press \rightarrow to confirm. The audio menu appears.
- ▶ Select **Disc**, **USB Storage**, **Media Interface** or **Bluetooth Audio** and press \rightarrow to confirm. This switches to the desired audio source.
- ▶ Select an audio medium from the media list (▷ page 64).

Example display: audio CD mode

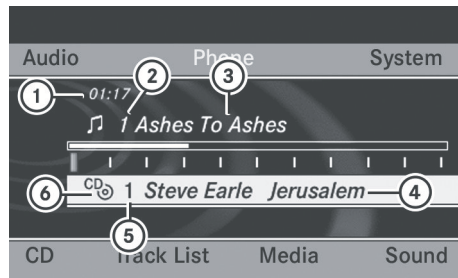

P82.60-8212-31

- 1 Track time
- 2 Track number
- 3 Track name (only if stored on the disc)
- 4 Disc name (only if stored on the disc as CD text)
- 5 Data carrier position in the media list
- 6 Disc type

- i The artist may appear below ④ if this information is available.

Example display: MP3 mode







P82.60-8362-31

- 1 Cover (if available)
- 2 Track time
- 3 Track number and name
- 4 Graphic time and track display
- 5 Medium type, position of medium in the media list, current folder
- 6 Artist (if available)
- 7 Basic MP3 mode menu





- i Cover display ① is only available for MP3 files on USB storage devices.

Pause function

- ▶ **To pause playback:** briefly press the  button.
The  symbol appears at the top left in the status bar.
- ▶ **To continue playback:** briefly press the  button again.
The  symbol disappears.

Selecting an audio CD or MP3 disc

Selecting via the media list

- ▶ **In Audio CD and MP3 mode:** select **Media** using the controller (slide  and turn  and press  to confirm.
The media list appears. The  dot indicates the current medium being played.

The media list shows the discs currently available.



Media list

Magazine tray, position 1: readable data media are audio CDs or MP3 CDs

USB, position 2

Media Interface, position 3

Bluetooth® audio, position 4



-  If a disc cannot be read, an entry appears next to the corresponding magazine tray.
- ▶ Select a medium by turning  the controller and press  to confirm.

Selecting a track using the number keypad

- ▶ Press a number key, e.g. , when the display/selection window is active.
The medium at the corresponding position in the media list is loaded and then played.



Selecting a track

Selecting by skipping to a track

- ▶ **To jump forwards or backwards to a track:** turn  when the display/selection window is active.
- or
- ▶ Press the  or  button.
The skip forward function skips to the next track.







The skip back function skips to the beginning of the current track if the track has been playing for more than eight seconds. If the track has been playing for less than eight seconds, it skips to the start of the previous track.

If you have selected the playback options **Random Tracks** or **Random Folder**, the track order is random.

- ▶ **On the multifunction steering wheel:** switch to audio CD or MP3 mode on the Audio 20 system (▷ page 63).
- ▶ Press the  or  button to select the **Audio** menu.



P54_32-9488-31

- ① Track display
- ▶ Press the  or  button briefly.
- ▶ Press and hold the  or  button until the desired track has been reached.
If you hold down the  or  button, the system runs through the list more quickly. Not all audio drives or data carriers support this function.

If track information is stored on the audio drive or data storage device, the multifunction display shows the number and name of the track.

Selecting a track using the number keypad

- ▶ Press the  button on the number keypad.
A numerical entry field appears. The number of positions offered corresponds to the number of tracks on the CD. Only numbers that correspond to a track number on the CD can be entered.
- ▶ Enter the desired track number using the number keys.
The track plays after the last possible number is entered.

i Pressing and holding a number key for more than two seconds completes the entry, and the corresponding track is played.



Selecting by track list

Calling up the track list

Option 1



- ▶ Press  the controller when the display/selection window is active.

Option 2

- ▶ In audio CD, MP3 or USB audio mode, select **Random Track List**, **Folder** or **Music** using the controller (slide  and turn ) and press  to confirm.



The track list appears. The  dot indicates the current track.

Selecting a track





- ▶ Select the desired track by turning  the controller and press  to confirm.
The track is played.

Selecting a folder





i This function is only available in MP3 mode (CD and USB).

- ▶ Select **Folder** or **Music** from the menu bar by sliding  to the controller and press  to confirm.

or

- ▶ Press  the controller when the display/selection window is active.
The folder list appears.
- ▶ Select the desired folder by turning  the controller and press  to confirm.
You will see the tracks in the folder.
- ▶ Select a track and press  to confirm.
The track is played.

Fast forwarding/rewinding

- ▶ Select the display/selection window using the  controller.
 - ▶ Slide  the controller and hold it until the desired position has been reached.
- or
- ▶ Press and hold the  or  button.



Displaying metadata (MP3 mode)

Audio 20 can also display the album name and artist (metadata) during playback if this information was previously entered into the system.

For USB devices, you can choose to display the metadata contained in the tags of the encoded music data, or to display the file and folder names during playback.

i If the metadata characters are not displayed correctly, the **Display Track Information** option should be deactivated.

- ▶ **To display the album and artist name:** select **MP3** or **USB Storage** in the basic





display using the controller (slide  and turn  and press  to confirm.

- ▶ Select **Display Track Information** and press  to confirm.

This switches the track information display on or off .

Selecting an active partition (USB mass storage devices only)

You can select this function for USB mass storage devices when the storage device is partitioned. Up to four partitions (primary or logical; FAT format) are supported.

- ▶ **i** The Windows formatting program supports FAT partitioning up to 32 GB as standard.
- ▶ Select **USB Storage** using the controller (slide  and ) and press  to confirm.
- ▶ Select **Select Active Partition** and press  to confirm.

Playback option

The following options are available to you:

- **Normal Track Sequence**
The tracks are played in the normal order (e.g. 1, 2, 3, etc.).
- **Random Tracks**
The tracks are played in random order (e.g. 3, 8, 5 etc.).
- **Random Folder** (only in MP3 mode)
The tracks in the currently active folder are played in random order.
- ▶ **To select an option:** select **CD/MP3**.
The options list appears. The • dot indicates the option selected.
- ▶ Select an option.
The option is switched on. For all options except **Normal Track Sequence**, a corresponding display will appear in the main area.

- ▶ **i** The **Normal Track Sequence** option is automatically selected if you change the disc you are currently listening to or if you select a different medium. If an option is selected, it remains selected after Audio 20 is switched on or off.

Notes on MP3 mode

General information

- ▶ **i** Depending on the volume and format of the MP3 data, the length of time required for reading the data may increase.

Permissible discs

- CD-R and CD-RW
- USB storage device

Permissible file systems

- ISO 9660/Joliet standard for CDs
- FAT16 or FAT32 for USB storage media

Multisession CDs

For multisession CDs, the content of the first session determines how Audio 20 will process the CD. Audio 20 plays only one session and gives priority to the audio CD session.

If possible, use Audio 20 to play only CDs that have been written in one session.

File structure of a data carrier

When you create a disc with compressed music files, the tracks can be organized in folders. A folder may also contain subfolders. A disc can contain a maximum of 255 folders. Each folder can contain a maximum of 255 tracks and 255 subfolders. A maximum of 512 files are permitted on an MP3 CD.

The disc may contain no more than eight directory levels. Files beyond the eighth level will not be recognized by the system.

Track and file names

Audio 20 does not support ID3 tags. Music files can contain meta information such as artist, album or track names. Audio 20 displays this information during playback.

When you create a disc with compressed music files, you can assign names to the tracks and folders. Audio 20 displays these names if no meta information is available.

If MP3 or WMA files are stored in the root directory itself, the root directory will also be treated as a folder. Audio 20 will then show the name of the root directory as the folder name.

You must observe the following when assigning track names:

- track names must have at least one character.
- track names must have the extension "mp3" or "wma".
- there must be a dot between the track name and the extension.

Example of a correct track name:
"Track 1.mp3".

Permissible formats

Audio 20 supports the following formats:

- MPEG1 Audio Layer 3 (MP3)
- Microsoft Windows Media Audio V2, V7, V8 and V9 (WMA)
- music files in AAC format with the aac and m4a extension, but not copy-protected iTunes music files with the extension "m4p".

i If, in addition to MP3 files, there are other music files in these audio formats stored on the disc, the loading process may require a longer time before the first track is played.

i The MP3 audio encoding method is under license from Fraunhofer IIS (Institut Integrierte Schaltungen – Institute for Integrated Circuits) and Thomson.

Permissible bit and sampling rates

Audio 20 supports the following types of **MP3** files:

- fixed and variable bit rates from 32 kbit/s to 320 kbit/s
- sampling rates of 8 kHz to 48 kHz

Audio 20 supports the following types of **WMA** files:

- fixed bit rates from 5 kbit/s to 384 kbit/s
- sampling rates of 8 kHz to 48 kHz

Audio 20 **does not** support the following types of **WMA** files:

- DRM (Digital Rights Management) encrypted files
- variable bit rate
- WMA Pro
- 5.1 Surround

i Only use tracks with a bit rate of at least 128 kbit/s and a sampling rate of at least 44.1 kHz. Lower rates can cause a noticeable deterioration in quality. This is especially the case if you have activated a surround sound function.

Notes on copyright

MP3 or WMA tracks that you create or play back are generally subject to copyright protection in accordance with the applicable international and national regulations.

In many countries, reproductions, even for private use, are not permitted without the prior consent of the copyright holder.

Make sure that you know about the applicable copyright regulations and that you comply with these.

If you own these rights yourself, e.g. for your own compositions and recordings, or if the copyright holder has granted you permission, these restrictions do not apply.

Notes on compact discs

i Discs with copy protection are not compatible with the audio CD standard. Consequently, it may not be possible to play them on the Audio 20 system. Playback problems may occur when playing copied discs. A wide range of data media, burning software and burners is available. This variety means that there is no guarantee that the system will be able to play discs that you have copied yourself. There may be playback problems if you play CDs that you have copied yourself with a storage capacity of more than 700 MB. CDs of this type do not conform to the currently applicable standards.

! Do not affix stickers or labels to the discs. They could peel off and damage the drive. The drive is designed to hold discs which comply with the EN 60908 standard. Therefore, you can only use discs with a maximum thickness of 1.3 mm.

If you insert thicker discs, e.g. those that contain data on both sides (DVD on one side and audio data on the other), they cannot be ejected and can damage the drive.

Do not use discs with a diameter of 8 cm, even with an adapter. Only use round discs with a diameter of 12 cm.

Bluetooth® audio

Connecting a Bluetooth® device

Conditions

Bluetooth® audio device

Bluetooth® audio mode requires a Bluetooth®-capable audio device.

i Not all Bluetooth® audio devices available on the market are equally suitable. For more detailed information on suitable Bluetooth® audio devices and on

connecting Bluetooth® audio devices to Audio 20, visit

<http://www.mbusa-mobile.com>.

Alternatively, call the Mercedes-Benz Customer Assistance Center at 1-800-FOR-MERcedes (1-800-367-6372) (for USA) or Customer Relations at 1-800-387-0100 (for Canada).

Before using Bluetooth® audio mode, you should check your Bluetooth® audio device for the following (see the Bluetooth® audio device's operating instructions):

- ▶ **Bluetooth® audio profile**
The Bluetooth® audio device must support the A2DP and AVRCP Bluetooth® audio profiles.
- i** **A2DP (Advanced Audio Distribution Profile):** Bluetooth® audio profile for audio data transmission
AVRCP (Audio Video Remote Control Profile): Bluetooth® audio profile for audio data playback
- ▶ **Bluetooth® visibility**
On certain Bluetooth® audio devices, as well as activating the Bluetooth® function, the device itself must also be made "visible" to other devices (see the Bluetooth® audio device's operating instructions).
- ▶ **Bluetooth® device name**
Every Bluetooth® device has its own Bluetooth® device name. This device name is freely definable, but can be identical for all devices from the same manufacturer. You should therefore change the name of the device so that you can correctly identify your Bluetooth® audio device (see the Bluetooth® audio device's operating instructions).
- ▶ **Activate Bluetooth® and Bluetooth® visibility on the Bluetooth® audio device.**

On Audio 20

- ▶ Bluetooth® must be activated in Audio 20 (> page 32).

General information

Before using your Bluetooth® audio device with Audio 20 for the first time, you will need to authorize it.

When you authorize a new Bluetooth® audio device, it is connected automatically.





Connecting comprises:

- searching for a Bluetooth® audio device
- subsequently authorizing it

You can connect up to 15 Bluetooth® devices.

- i** When you authorize a mobile phone that supports Bluetooth® audio, it will be entered in the Bluetooth® telephone list (> page 39) as well as in the Bluetooth® device list. Mercedes-Benz recommends authorizing a mobile phone in Bluetooth® telephony (> page 39).

Searching for and authorizing a Bluetooth® audio device

- ▶ Switch on Bluetooth® audio mode (> page 71).
If you see the **No Bluetooth Audio Device Authorized** message, you will need to authorize the Bluetooth® audio device first.
- ▶ Select **BT Audio** using the controller (slide  and turn ) and press  to confirm.
- ▶ Select **BT Audio** and press  to confirm.
- ▶ **To search:** select **Update** and press  to confirm.
Audio 20 scans for Bluetooth® audio devices within range and enters them in the Bluetooth® device list if they support the A2DP and AVRCP Bluetooth® audio profiles.



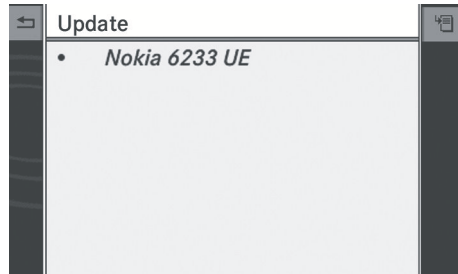

The duration of the search depends on the number of Bluetooth® audio devices within range and their characteristics.



P82.60-8372-31

Example: Bluetooth® device list

The Bluetooth® device list shows all Bluetooth® audio devices within range and all previously authorized Bluetooth® audio devices, whether or not they are in range.

- ▶ **To authorize:** select a Bluetooth® audio device that has not yet been authorized from the list by turning  the controller.
- ▶ Select **Options** by sliding  the controller and press  to confirm.
- ▶ Select **Authorize** and press  to confirm.
After successful authorization, the Bluetooth® audio device is connected and starts playing.
- ▶ **External authorization:** Audio 20 may not be able to locate your Bluetooth® audio device due to the specific security settings of the Bluetooth® audio device itself. In this case, check whether your Bluetooth® device can locate the Audio 20 system (> page 40). The Bluetooth® device name of Audio 20 is **MB Bluetooth**.
After successful authorization, the Bluetooth® audio device is connected and starts playing.

- i** With some Bluetooth® audio devices, playback must be initially started on the device itself so that Audio 20 can play the audio data.

Reconnecting a Bluetooth® audio device

The Bluetooth® audio profiles are connected automatically under the following circumstances:

- one of the last two mobile phones to have been connected has also been used as a Bluetooth® audio player (if this function is supported by the mobile phone).
- the mobile phone takes over the automatic connection itself.

A Bluetooth® audio player without telephone functions is not automatically reconnected, even if it was the last device connected.





If the **No Bluetooth Audio Device Connected** message appears, you have the following options to connect a Bluetooth® audio device:

Option 1

- ▶ Confirm **Connect Last Device** in the basic display by pressing  the controller. If Audio 20 can locate the Bluetooth® audio device, it will be connected and playback will start.

i With some Bluetooth® audio devices, playback must be initially started on the device itself so that Audio 20 can play the audio data.





Option 2

- ▶ Select **BT Audio** by turning  the controller and press  to confirm.
- ▶ Select **Bluetooth Audio Device List** by pressing  the controller.
- ▶ Select a Bluetooth® audio device by turning  the controller and press  to confirm. If Audio 20 can locate the Bluetooth® audio device, it will be connected and playback will start.



i With some Bluetooth® audio devices, playback must be initially started on the

device itself so that Audio 20 can play the audio data.

Displaying details

- ▶ Select a Bluetooth® audio device in the Bluetooth® device list.
- ▶ Select **Options** by sliding  the controller and press  to confirm.
- ▶ Select **Details** and press  to confirm. The following information concerning the selected mobile phone is shown:
 - Bluetooth® name
 - Bluetooth® address
 - availability status (shown after a new search)
 - authorization status
- ▶ **To close the detailed view:** turn  or slide  the controller.

De-authorizing (de-registering) a Bluetooth® audio device

- ▶ Select a Bluetooth® audio device in the Bluetooth® device list.
- ▶ Select **Options** by sliding  the controller and press  to confirm.
- ▶ Select **De-Authorize** and press  to confirm. A prompt appears asking whether you really wish to de-authorize this device.
- ▶ Select **Yes** or **No**. If you select **Yes**, the device will be deleted from the Bluetooth® device list. If you select **No**, the process will be canceled.
- i** Before re-authorizing the Bluetooth® audio device, you should also delete the device name **MB Bluetooth** from your Bluetooth® audio device's Bluetooth® list.

Switching to Bluetooth® audio mode

Option 1

- ▶ Connect (▷ page 68) or reconnect (▷ page 70) a Bluetooth® audio device. Audio 20 activates the Bluetooth® audio device. The basic display appears and the device starts playing.

Option 2

- ▶ Press the **[disc]** function button one or more times.

i By pressing the function button repeatedly, you can change the operating mode in the following order:

- Audio CD/MP3 disc in the single CD drive
- USB storage media
- Media Interface or audio AUX mode
- Bluetooth® audio mode

Option 3

- ▶ Press the **[9 wxyz]** number key in the Bluetooth® audio basic display. This will select the connected Bluetooth® audio device directly.

Option 4

- ▶ In the media list (▷ page 64), turn **[⏪]** the controller to select the entry at position 4 and press **[⏩]** to confirm. Audio 20 activates the connected device. You will see a message to this effect. The basic display then appears.

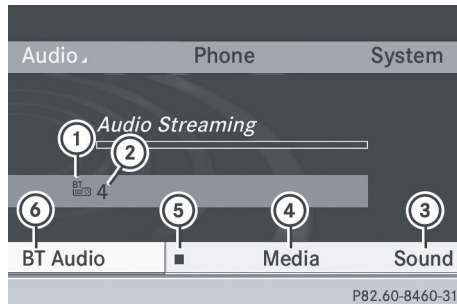

Example: Bluetooth® audio display

- 1 Bluetooth® audio data medium type
- 2 Position in the media list
- 3 Sound settings
- 4 Media list
- 5 To stop **[■]** or start **[▶]** playback
- 6 To connect Bluetooth® audio devices

i If the Bluetooth® audio device connected supports metadata and corresponding data is available, then the artist, track and album name can be displayed.

Starting/stopping playback

- ▶ **To start playback:** select **[▶]** using the controller (slide **[⏪]** and turn **[⏪]**) and press **[⏩]** to confirm. Playback starts. Selection is at **[■]**.
- ▶ **To stop playback:** select **[■]** by turning **[⏪]** the controller and press **[⏩]** to confirm. A message appears. Selection is at **[▶]**.
- ▶ **To resume playback:** select **[▶]** by turning **[⏪]** the controller and press **[⏩]** to confirm. A message appears. Selection is at **[■]**.

Starting playback when the Bluetooth® audio device has stopped

During the search for mobile phones (▷ page 38), the connection with the

Bluetooth® audio device is terminated. In the Bluetooth® audio (> page 41) basic display, the **No Bluetooth Audio Device Connected** message appears and the **Conn. Last Device** menu item cannot be selected as long as the search for mobile phones is running.

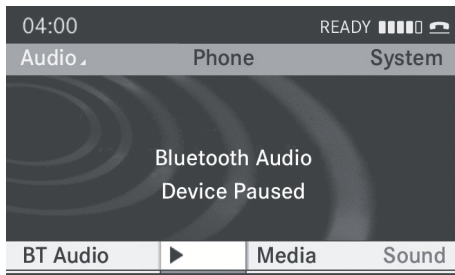



P82.60-8247-31

When the search is finished, the Bluetooth® audio device can be reconnected.

- ▶ Confirm **Conn. Last Device** by pressing .



Depending on the Bluetooth® audio device used, playback starts immediately or you must start playback manually.

In this case, you will see the **Bluetooth Audio Device Paused** message.

- ▶ **To start playback:** select  by turning  the controller and press  to confirm. Playback resumes from the beginning.

Selecting a track

The function is not supported by all Bluetooth® audio devices.

- ▶ **To skip forwards or backwards to a track:** press the  or  button.

Selecting playback options

If the Bluetooth® audio device supports the corresponding function, the following options are available:



- **Normal Track Sequence**

The tracks are played in the normal order (e.g. track 1, 2, 3, etc.).



Audio data playback is determined by the order in which the tracks are written to the data carrier. Alphabetical order is the most common. Once all the tracks in a folder have been played, the tracks in the next folder are played.

- **Random Tracks**

All the tracks on the medium are played in random order (e.g. track 3, 8, 5 etc.).

- ▶ Select **BT Audio** using the controller (slide  and turn ) and press  to confirm.

The  dot indicates the option selected.





- ▶ Select an option by turning  the controller and press  to confirm.

If you select **Random Tracks**, you will see a corresponding symbol in the display/selection window.

Adjusting the sound settings

A description of the sound settings using radio mode as an example can be found under "Basic functions of Audio 20" (> page 21).

Increasing the Audio 20 volume

- ▶ Select **BT Audio** using the controller (slide  and turn ) and press  to confirm.
- ▶ Select **Volume** and press  to confirm. A menu appears. The  dot indicates the current setting.

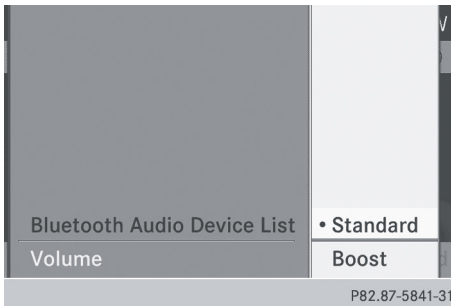

- ▶ Select **Standard** or **Boost** and press to confirm.

You will find further information in the "Audio AUX mode" section (▶ page 78).

Media Interface mode

Connection options

Overview

You will find the connection sockets in the center console stowage compartment. Device-specific adapter cables, included with the Media Interface, are required to connect external devices to the Media Interface.

WARNING

Only connect or disconnect an external audio source when the vehicle is stationary. There is a risk of being distracted from the road and traffic conditions if you insert or eject a disc while the vehicle is in motion.

- Store individual parts in a safe place.
Only use genuine Mercedes-Benz connection cables.

The Media Interface allows you to connect the following devices to Audio 20:

- iPod®
- certain MP3 players
- iPod® is a registered trademark of Apple Inc., Cupertino, California, USA.

Supported devices

For further details and a list of supported devices, please visit <http://www.mbusa-mobile.com> (customers in the USA only). Then follow the instructions in the "Media Interface" section. You can also call Mercedes-Benz Customer Service at 1-800-FOR-MERCEdes (1-800-367-6372) (US), or Customer Relations at 1-800-387-0100 (Canada).

Connecting an external device

- Do not leave external devices in the vehicle as extreme temperatures (e.g. direct sunlight or extremely low outside temperatures) could cause them to malfunction (see the operating instructions for the respective device). Mercedes-Benz accepts no liability for damage to external devices.

Never connect more than one device at a time. You will otherwise not be able to play back from the external device. Please consult an authorized Mercedes-Benz Center for further information.

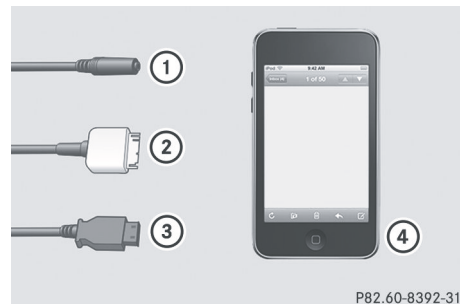

- ① Socket for 3.5 mm jack plug, e.g. for MP3 players
- ② iPod® plug, to connect an iPod®
- ③ USB socket for connecting an MP3 player
- ④ Example of device: iPod®

- ▶ Connect the external device with suitable socket ①, ② or ③.
Audio 20 activates the device and a message appears.

If you remove a device, the **No Device Connected** message appears.

i A connected iPod® or MP3 player should not be operated simultaneously via the Media Interface and the remote control (e.g. Bluetooth® remote control) or operated directly on the device itself, as this may produce unpredictable results.

i Connecting a fully discharged iPod® or MP3 player can result in an extended initialization period.

Error messages appear while the device is being activated if:

- Audio 20 does not support the device connected (**External Device Unavailable** message).
- the connected device consumes too much power.
- the Media Interface connection is faulty.
- a mass storage device (such as a USB stick or USB hard drive) is connected to the Media Interface (**Please connect the device to the other USB port.** message).

i The separate USB connection ensures quick access and expanded media content options.

Consult an authorized Mercedes-Benz Center if required.

Switching to Media Interface mode

General information

i In extreme cases, starting up individual functions can take up to several minutes. This depends on the external device and the nature of the stored data (e.g. video podcasts).

Only use the original software to store data on an iPod® or MP3 player. Otherwise, some or all functions may not be available.

Option 1

- ▶ Connect an external device (> page 73).
Audio 20 activates the device. The basic display then appears.

Option 2

- ▶ Press the **DISC** function button one or more times.

By pressing the function button repeatedly, you can change the operating mode in the following order:

- Audio CD/MP3 (disc)
- USB storage device
- Media Interface or audio AUX mode
- Bluetooth® audio mode

Option 3

- ▶ Press the **3** number button (single CD drive). This selects the connected external audio device directly.

Option 4

- ▶ In the media list, turn **⏪** the controller to select the entry at position 3 (single CD drive) and press **⏩** the controller to confirm.

Audio 20 activates the connected device. You will see a message to this effect. The basic display then appears.

If no device is connected, you will see the **Media Interface** entry instead of a device name.

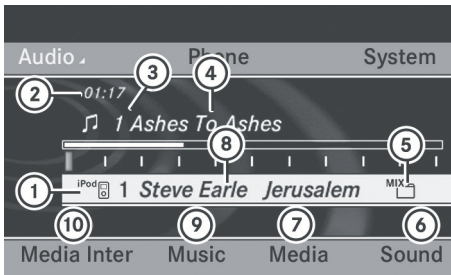

P82.60-8242-31

Example iPod® display

- ① Disc type
- ② Track time
- ③ Track number
- ④ Track name
- ⑤ Current playback option
- ⑥ Sound settings
- ⑦ Media list
- ⑧ Album name (if available)
- ⑨ Categories, playlists and/or folders
- ⑩ Playback options

The type of data medium connected ① is indicated by the corresponding iPod® or MP3 player symbol.

Symbol ⑤ displays the current playback option (not displayed in [Normal Track Sequence](#) mode).

- ❗ If the device connected does not contain any playable tracks, a message appears to this effect.

Selecting music files

Note

- ❗ Audio 20 displays the files on the iPod® or MP3 player according to the file structure on the respective medium.

Selecting by skipping to a track

- ▶ **To skip forward or back to a track:** slide ←⏪ or turn ⏩ the controller when the display/selection window is active.

or

- ▶ Press the ⏩ or ⏪ button.

The skip forward function skips to the next track. The skip back function skips to the beginning of the current track if the track has been playing for more than eight seconds. If the track has been playing for less than eight seconds, it skips to the start of the previous track. If you have selected a playback option other than [Normal Track Sequence](#), the track sequence is random.

- ▶ **On the multifunction steering wheel:** switch on Media Interface mode on the Audio 20 system (▷ page 74).
- ▶ Press the ◀ or ▶ button on the multifunction steering wheel to select the [Audio](#) menu.
- ▶ Press the ▲ or ▼ button briefly. If you hold down the ▲ or ▼ button, the system runs through the list more quickly. Not all media players support this function.

If track information is available on the media player, the multifunction display shows the number and name of the track.

Selecting using the number keypad

- ▶ **To make an entry:** press the * button. An input menu appears. The number of characters available for input depends on the number of stored tracks.

- ▶ **To enter a track number:** press a number key, e.g. . The digit is entered in the first position in the input line.

- ❗ Audio 20 will ignore and not display an invalid digit.



- ▶ Enter more numbers if desired. The track plays after the last possible number is entered.

i Pressing and holding a number key for more than two seconds completes the entry, and the corresponding track is played.

Fast forwarding/rewinding

- ▶ While the display/selection window is active: slide ←Ⓞ→ and hold the controller until the desired position is reached.

or

- ▶ Press and hold the  or  button until the desired position is reached.

i On an iPod®/iPhone®, fast rewind only functions within the current track.

Selecting a category/playlist/folder

iPod® and certain MP3 players

For an iPod® or MP3 player, you can select tracks using categories or folders.

Depending on the device connected, the following categories may be available, for example:



- **Current Tracklist**
- **Playlists** (e.g. **All** or "My Top 25")
- **Artists**
- **Albums**
- **Tracks**
- **Podcasts**
- **Genres**
- **Composers**
- **Audiobooks**

i Some playback categories contain the entry **All**. If this entry has been selected, the entire content of the category selected will be played.

Calling up a category list

- ▶ **To open a category list/folder:** press  the controller when the display/selection window is active.

or

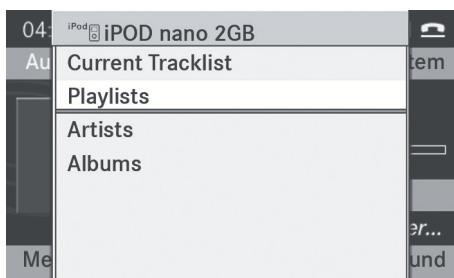

- ▶ Select **Music** from the basic display using the controller (slide ↓ Ⓞ or turn ) and press  to confirm. The category list appears.

i The **Music** menu item is not available until the device has been activated.



P82.60-8243-31

Example: category list

- ▶ Select **Current Tracklist** by turning  the controller and press  to confirm. The content of the current track list appears.

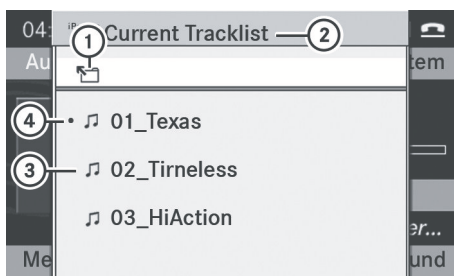

P82.60-8244-31

Example display: current tracklist

- ① Symbol for next folder up
- ② Current category
- ③ Track symbol
- ④ Current title

- ▶ Select the desired track by turning the controller and press to confirm. The track is played.
- ▶ **To switch to the next higher folder:** select the symbol and press to confirm.
- i** The symbol always appears at the top of the track list.

Playing back the content of a category or folder

- ▶ Select a category or folder by turning the controller.
- ▶ Press for longer than two seconds. The content of the category or folder selected is played in accordance with the playback option (▶ page 77) selected.

Alphabetical track selection

iPod® and MP3 players

- i** This function is available for alphabetical categories and folders. It is not available within albums or playlists.
- ▶ Turn the controller to select a category, such as **Artists**, and press to confirm. The available artists are displayed.
- ▶ Press the corresponding number key once or several times to select the first letter of the artist's name (e.g. for an artist beginning with the letter "C", press the number key three times). The available letters are listed at the lower edge of the display. After a message, the first entry in the list which matches the letter entered is highlighted.
- i** If no entry matches the entered letter, the first item in the list is the last entry to correspond to a selection.
- i** For iPods® and MP3 players, the quality of the search results is highly dependent on the version and language variant of the

software (e.g. iTunes® version) used to populate the device.

If differing sorting rules are defined (such as in iTunes®), the search will be canceled without providing any results.

Playback options

The following options are available:

- **Normal Track Sequence**
Normal track sequence: you hear the tracks in their normal order (e.g. numerical or alphabetical).
- **Random Medium**
All the tracks on the medium are played in random order.
- **Random Track List**
The tracks in the currently active category or folder, including any subfolders, are played in random order.
- ▶ **To select the playback option:** select **Media Interface** from the basic display by turning the controller and press to confirm. The options list appears. A • dot indicates the option selected.
- ▶ Select an option and press to confirm.

MP3 player instructions

Data formats

MP3 and WMA data formats with fixed and variable bit rates (up to 320 kbit/s) are supported.

Special considerations when using MP3 players

- Up to eight directory levels with up to 1,000 tracks per directory are supported.
- Do not use USB extension leads or adapters. They can impair functionality.
- DRM (Digital Rights Management) protected files are not supported by the Media Interface.

Audio AUX mode

Notes on audio AUX mode

You can connect an external audio source (AUX) to Audio 20 using the jack plug in the glove box. Please consult an authorized Mercedes-Benz Center for further information.

Activating audio AUX mode

When you connect an external audio source, audio AUX is not selected automatically.

- ▶ Select **Audio** from the main function bar using the controller (slide $\leftarrow \odot \rightarrow$ or turn $\{\odot\}$) and press \odot to confirm. If AUX mode was the last mode selected, it will now be active.

If another audio source is switched on, you can now switch to audio AUX mode in the audio menu.

- ▶ Slide $\uparrow \odot$ the controller to select **Audio** and press \odot to confirm. The audio menu appears.
- ▶ Turn $\{\odot\}$ the controller to select **Aux** and press \odot to confirm. The audio AUX menu appears. The medium in the external audio source is played if the source is connected and playback selected.

- ① Please see the respective operating instructions for how to operate the external audio source.

You can select a sound setting specifically for audio AUX mode. See (▶ page 21).

Adjusting the volume

- ① The volume of external audio sources can vary greatly. In some cases, the volume of the external audio device may be quieter or louder, or the usual maximum possible volume may be lower. On some devices, it is possible to adjust the volume separately. In this case, start at a medium volume and increase it gradually. This enables you to determine whether the system is able to play the music at high volume without distorting it.

You can increase the volume of the external audio sources.

- ▶ Select **Volume** from the AUX basic menu using the controller (slide $\odot \uparrow$, $\leftarrow \odot \rightarrow$ or turn $\{\odot\}$) and press \odot to confirm. The selection list appears. The \bullet dot indicates the option selected.

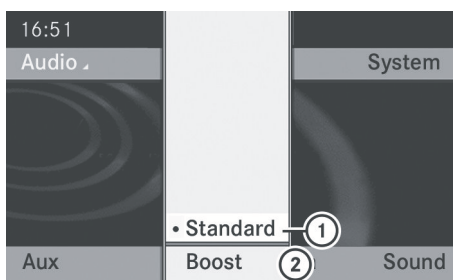

P82.60-8248-31

- ① Default setting
- ② Volume amplification





⚠ WARNING

External audio sources may have different volumes, which can mean that system messages such as traffic announcements and navigation system announcements are much louder. If necessary, please deactivate the system messages or adjust their volume manually.

Switching to other audio modes

- ▶ Press **DISC** repeatedly until the desired mode is activated.

or

- ▶ Slide **↑**  the controller to select **Audio** and press  to confirm.
The audio menu appears.
- ▶ Select the desired audio mode from the Audio menu by turning **⏪**  **⏩** the controller and press  to confirm.
The selected audio mode is activated.



Audio device features	82
General information	82
Basic functions	83
System settings	84
Audio CD/DVD and MP3 mode	85
Video DVD mode	90
AUX mode	96

Audio device features

i These Operating Instructions describe all standard and optional equipment available for your audio device at the time of going to print. Country-specific deviations are possible. Please note that your audio equipment may not offer all the features described.

General information

Changing batteries

Batteries are required for the remote control and for the two sets of cordless headphones.

WARNING

Batteries contain toxic substances.
Swallowing batteries can lead to serious health issues or death.
Keep batteries out of the reach of children.
Seek medical attention immediately if a battery is swallowed.

Environmental note

Dispose of discharged batteries in an environmentally responsible manner.

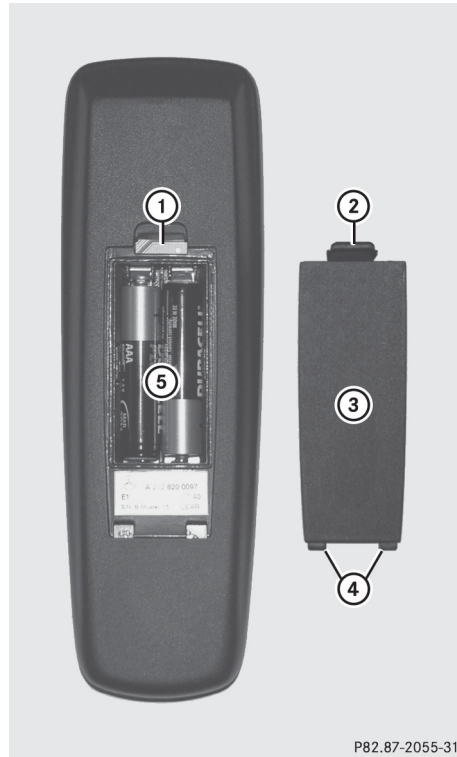

P82.87-2055-31

- ① Battery compartment
- ② Catch tab
- ③ Battery compartment cover
- ④ Retaining lugs
- ⑤ Batteries

The remote control contains two AAA, 1.5 V batteries.

- ▶ **To open the battery compartment:** remove battery compartment cover ③ on the back of the remote control.
- ▶ To do so, push catch tab ② downwards and take off battery compartment cover ③.
- ▶ Remove discharged batteries ⑤ from the tray.
- ▶ Insert the new batteries. Observe the polarity markings on the batteries and battery compartment when doing so.
Left-hand battery: the positive pole (+) must face upwards.

Right-hand battery: the positive pole (+) must face downwards.

- ▶ **To close the battery compartment:** insert battery compartment cover ③ starting with retaining lugs ④ into the battery compartment and allow catch tab ② to engage in place.

On the cordless headphones

The battery compartment cover is located on the left headphone.



P82.87-2056-31

- ① Battery compartment cover

The cordless headphones contain 2 type AAA, 1.5 V batteries.

- ▶ **To open the battery compartment:** flip battery compartment cover ① upwards. As you do so, hold the left-hand side of the headphones as shown to prevent the batteries from falling out.
- ▶ Remove the discharged batteries from the tray.
- ▶ Insert the new batteries. Observe the polarity markings on the batteries and battery compartment when doing so. Left-hand battery: the positive pole (+) must face upwards. Right-hand battery: the positive pole (+) must face downwards.
- ▶ **To close the battery compartment:** press battery compartment cover downwards until it engages into place. If the batteries have been inserted correctly, the indicator lamp will light up

green when the headphones are switched on.

- ❗ The operating duration of the headphones with a set of batteries is up to 40 hours.

Basic functions

Introduction

The following operating modes are available for the Rear Seat Entertainment System:

- CD/DVD audio and MP3 mode (▷ page 85)
- Video DVD operation (▷ page 85)
- AUX mode (▷ page 96)

In AUX mode, you can view external video sources which are connected either to the rear screens (display AUX) or to the CD/DVD drive (drive AUX).

The system settings allow you to adjust screen-related settings, such as the design and the language (▷ page 84).

Using headphones

You can use the cordless headphones supplied and/or up to two sets of corded headphones connected to the corresponding jack of the rear-compartment screens (▷ page 24).

Adjusting the sound settings

Call up the menu for the respective mode:

- Audio CD (▷ page 86)
- Audio DVD (▷ page 86)
- MP3 (▷ page 86)
- Video DVD (▷ page 91)
- AUX (▷ page 96)

- ▶ Select **Treble** or **Bass** and press the **OK** button to confirm. An adjustment scale appears.
- ▶ **To make a setting:** press the **▲** or **▼** button until the desired format has been selected.
- ▶ **To confirm your selection:** press the **OK** button.

Multiple users

Simultaneous use of the rear-compartment disc drive

The two rear-compartment screens can be operated almost entirely independently from one another. However, there can be a conflict in some menus if the two screens are used simultaneously.

If the rear-compartment disc drive is being used for both screens simultaneously, selecting certain menus or settings on one of the screens also affects the other screen.

The following functions affect both screens:

- changing playback options
- selecting a track (from a track list or folder)
- using play, pause and stop
- fast forwarding/rewinding or scrolling
- calling up the DVD menu and navigating within it
- setting the language, subtitles and camera angle
- calling up interactive DVD content

The following functions affect only one screen:

- audio and video functions as well as picture settings
- switching between full screen and the menu

Switching between operating modes

When you exit an operating mode (e.g. audio CD mode), the current setting is saved. If you call up this operating mode again later, there are two possibilities:

- the operating mode has been changed on the other screen.
- the operating mode has not been changed.

In the first case, the operating mode appears as it is on the other screen.

In the second case, the setting appears on the screen as it was when you last exited the operating mode.

Function restrictions in video DVD mode

Certain functions or actions may be temporarily or completely unavailable. As soon as you try to activate these functions or actions, you will see the **⊘** symbol in the display.

System settings

Note

You can adjust almost all system settings individually for each screen without affecting the other screen. Use the remote control to adjust the settings (▷ page 25).

Calling up the system menu

- ▶ Select **System** in the main functions menu bar and confirm with the **OK** button. You see the system menu on the selected rear screen.

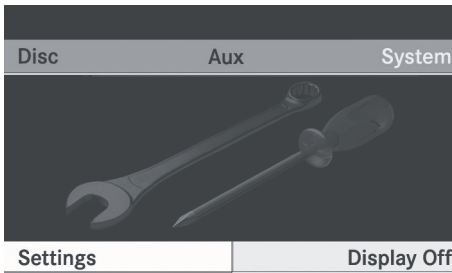

P82.87-2036-31

Selecting the display language

- ▶ Select **Settings** using the ◀ or ▶ button and press **OK** to confirm.
- ▶ Using the ▼ or ▲ button, select **Language** and press the **OK** button to confirm.
The list of languages appears. The • dot indicates the current setting.
- ▶ **To change the setting:** use the ▲ or ▼ button to select a language.
- ▶ Press the **OK** button.
The Rear Seat Entertainment System activates the selected language.

Switching the display design

- ▶ Select **Settings** using the ◀ or ▶ button and press **OK** to confirm.
- ▶ Select **Day Mode**, **Night Mode** or **Automatic** using the ▲ ▼ buttons and press the **OK** button to confirm.
The dot in front of the menu item indicates the currently selected setting.

Design	Explanation
Day Mode	The display is set permanently to day design.
Night Mode	The display is set permanently to night design.
Automatic	The display design changes depending on the vehicle instrument cluster illumination.

Setting the brightness

- ▶ Select **Settings** using the ◀ or ▶ button and press **OK** to confirm.
- ▶ Select **Brightness** and confirm with the **OK** button.
A scale appears.
- ▶ Adjust the brightness using the ▲ ▼ buttons and press the **OK** button to confirm.
The brightness bar moves up or down. The picture becomes lighter or darker in accordance with the scale.

Showing/hiding the picture

- ▶ **To hide the picture:** select **Display Off** in the system menu using the ▼ ▶ buttons on the remote control and press the **OK** button to confirm.
The picture is hidden.
- ▶ **To show the picture:** press the **OK** button on the remote control.

Audio CD/DVD and MP3 mode

Important safety notes

WARNING

The CD/DVD drive is a class 1 laser product. You must not open the casing. There is a risk

of exposure to invisible laser radiation if you open the casing or if the casing is faulty or damaged.

The Rear Seat Entertainment System contains no parts which you can repair yourself. For safety reasons, all maintenance work must be carried out by qualified aftersales technicians.

General information

You will find information on the following topics in the Audio section:

- notes on CDs/DVDs (▷ page 66)
- notes on MP3 mode (▷ page 66)
- notes on copyright (▷ page 67)

Inserting a CD/DVD

- ① The CD/DVD drive is located in the center behind the front seats.

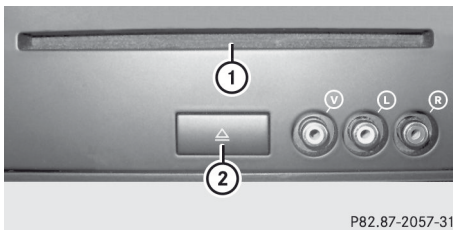

- ① Disc slot
- ② Eject button

The CD/DVD drive holds one disc. If there is already a disc inserted, this must be ejected before another is inserted.

- ▶ Insert a disc into the disc slot.
The printed side of the disc must face upwards. If neither side of the disc is printed, the side you wish to play must face downwards.
The CD/DVD drive draws the disc in.



The CD/DVD drive plays the disc:

- if it has been inserted correctly and is a permissible disc, and
- if you have switched to disc mode (audio CD, audio DVD and MP3 mode) (▷ page 86)

Data on an MP3 CD first needs to be loaded by the drive. Loading may take some time, depending on the number of folders and tracks.

Removing a CD/DVD

- ▶ Press eject button ②.
The drive ejects the disc.
- ▶ Take the disc out of the slot.
If you do not take the disc out of the slot, the drive will draw it in again automatically after a short while.

Switching to audio CD, audio DVD or MP3 mode

Introduction

- ▶ Insert a CD/DVD (▷ page 86).
The Rear Seat Entertainment System loads the inserted disc.
- ▶ Select **D**isc with the remote control and confirm with **(OK)**.
- ▶ The corresponding mode is activated. The Rear Seat Entertainment System plays the disc.

Example display: audio CD mode

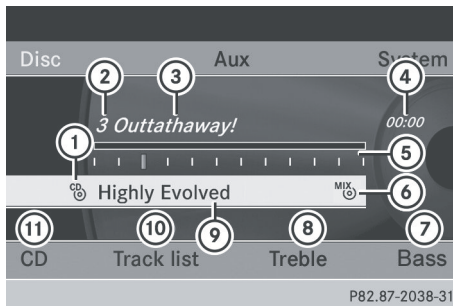

- ① Type of data medium
- ② Track number
- ③ Track name (only if stored on the disc as CD text)
- ④ Track time
- ⑤ Graphic time and track display
- ⑥ Current playback settings (no symbol for "Normal track sequence")
- ⑦ To set the bass
- ⑧ To set the treble
- ⑨ Disc name (only if stored on the disc as CD text)
- ⑩ To call up the track list
- ⑪ To select playback options

Example display: audio DVD mode

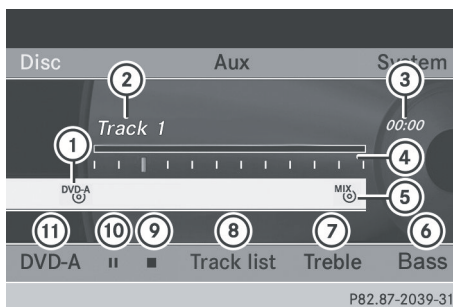

- ① Type of data medium
- ② Track number
- ③ Track time
- ④ Graphic time and track display

- ⑤ Current playback settings (no symbol for "Normal track sequence")
- ⑥ To set the bass
- ⑦ To set the treble
- ⑧ To call up the track list
- ⑨ Stop function
- ⑩ Pause function
- ⑪ To select playback options

Example display: MP3 mode

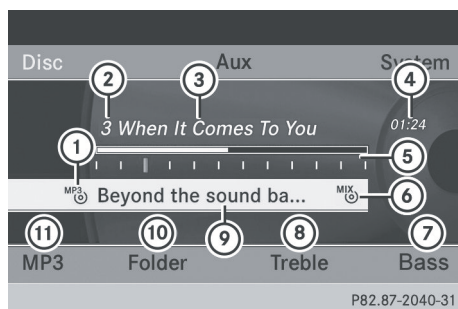

- ① Type of data medium
 - ② Track number
 - ③ Track name
 - ④ Track time
 - ⑤ Graphic time and track display
 - ⑥ Current playback settings (no symbol for "Normal track sequence")
 - ⑦ To set the bass
 - ⑧ To set the treble
 - ⑨ Disc name or current folder
 - ⑩ To call up the folder list
 - ⑪ To select playback options, switch track information on or off
- i** Variable bit rates in MP3 tracks can result in the elapsed time shown being different from the actual elapsed time.

Selecting a track

Selecting by skipping to a track

- ▶ **To skip forwards or backwards to a track:** press the ◀ or ▶ button when the display/selection window is active.

or

- ▶ Press the ⏮ or ⏭ button.

Skip forwards: you hear the next track.

Skip back: the current track is restarted if it has been playing for longer than approximately 10 seconds. If it has been playing for less time, the previous track is played.

Selecting by track list

- ❗ In audio CD mode, the track list contains all tracks on the disc currently playing.

In audio DVD mode, the track list contains all tracks in the currently active group; see "Setting the audio format" (> page 89).

In MP3 mode, the track list shows all tracks in the currently active folder as well as the folder structure, allowing you to select any track on the MP3 CD.

- ▶ Select **Track List** (audio CD/audio DVD mode) or **Folder** (MP3 mode).

or

- ▶ Press the Ⓞ button when the display/selection window is selected. The track list appears. The • dot indicates the current track.

- ▶ **To select a track:** press the ▲ or ▼ button.

- ▶ Press the Ⓞ button.

Making a selection by entering the track number directly

- ▶ Press the ✖ button. The track entry display appears.

Example: track 2

- ▶ Press the **2** number key.

Example: track 12

- ▶ Press the corresponding number keys in rapid succession.

- ❗ It is not possible to enter numbers that exceed the number of tracks on the CD or in the currently active folder.

- ▶ Wait for approximately three seconds after making an entry. You will hear the track which has been entered. The corresponding basic menu then reappears.

Fast forwarding/rewinding

- ▶ With the display/selection window active, press the ◀ or ▶ button repeatedly until you reach the desired position.

or

- ▶ Press and hold the ⏮ or ⏭ button until the desired position is reached.

Selecting a folder

- ❗ This function is only available in MP3 mode.

- ▶ In MP3 mode, select **Folder** and confirm with Ⓞ.

or

- ▶ Press the Ⓞ button when the display/selection window is selected. The folder content appears.



- ① Folder selection symbol
- ② Current folder name
- ③ Track symbol

- ▶ To switch to the next folder up: select icon ①.
The display shows the next folder up.

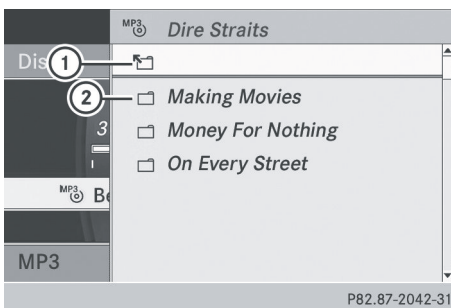

- ① Folder selection symbol
- ② Folder icon
- ▶ Select a folder using the ▲ or ▼ button and press the (OK) button to confirm.
You will see the tracks in the folder.
- ▶ Select a track using the ▲ or ▼ button and press the (OK) button to confirm.
The track is played and the corresponding folder is now the active folder.

Pause function

- ❗ This function is only available in audio DVD mode.











- ▶ **To pause playback:** select ■ and confirm with (OK).
The ■ display changes to ▶.
- ▶ **To continue playback:** select ▶ and press (OK) to confirm.
The ▶ display changes to ■.

Stop function

- ❗ This function is only available in audio DVD mode.
- ▶ **To stop playback:** select ■ and press (OK) to confirm.
The ■ display changes to ▶.
- ▶ **To continue playback:** select ▶ and press (OK) to confirm.
Playback continues from the point where it was interrupted.
- ▶ **To stop playback:** while playback is interrupted, select ■ again and press (OK) to confirm.
Playback stops and returns to the beginning of the DVD. ▶ is highlighted.
- ▶ **To restart playback:** select ▶ and press (OK) to confirm.
Playback starts from the beginning of the DVD.

Setting the audio format





- ❗ You can only set the audio format in audio DVD mode. The number of audio formats available depends on the DVD. The content of an audio DVD is called an "album", and this can be divided into up to nine groups. A group can contain music in different sound qualities (stereo and multichannel formats, for example), or bonus tracks. Each group can contain up to 99 tracks. If an audio DVD only contains one audio format, the **Group** menu item cannot be selected.

- ▶ Press the  or  button to select **DVD-A** and confirm with the .
- ▶ Press the  or  button to select **Group** and confirm with the .
- The list of available audio formats appears. The  dot indicates the format currently selected.
- ▶ **To change a setting:** press the  or .
- ▶ Press the .
- ▶ **To exit the menu:** press the .

Playback options

Introduction

The following options are available:

- **Normal Track Sequence**
- **Random Tracks**
- **Random Folder** (only in MP3 mode)
- ▶ **To select an option:** select **CD** or **DVD-A** or **MP3**.
The options list appears. The  dot indicates the option currently selected.
- ▶ Press the  or  button to select a different option.
- ▶ Press the .
- The option is switched on. For all options except **Normal Track Sequence**, you will see a corresponding display in the display/selection window.
-  If you change the disc, the **Normal Track Sequence** option is activated automatically. If an option is selected, it remains selected after the Rear Seat Entertainment System is switched on or off.

Explanation of the playback options

- **Normal Track Sequence**

In audio CD/DVD mode, you hear all the tracks in their normal sequence (e.g. track 1, 2, 3 etc.).

In MP3 mode, the track order is determined by the order in which the tracks are written to the MP3 data carrier when it is created. Alphabetical order is the most common. Once all the tracks in a folder have been played, the tracks in the next folder are played.

- **Random Tracks**

The tracks are played in a random order (e.g. track 3, 8, 5, etc.).

- **Random Folder** (MP3 mode only)

This option is limited to the tracks in the currently active folder. You hear the tracks in random order.

Switching track information on/off (MP3 mode only)

When the function is activated, the folder and track names are displayed.

When the function is deactivated, the disc and file names are displayed.

- ▶ Select **Display Track Information**.
The function is switched on or off , depending on the previous status.

Video DVD mode

Important safety notes

WARNING

The CD/DVD drive is a class 1 laser product. You must not open the casing. There is a risk of exposure to invisible laser radiation if you open the casing or if the casing is faulty or damaged.

The Rear Seat Entertainment System contains no parts which you can repair yourself. For safety reasons, all maintenance work must be carried out by qualified aftersales technicians.

Notes about discs

Notes about CDs/DVDs can be found here (▷ page 66).

DVD playback conditions

There are video DVDs available on the market which do not conform to the current standards.

Such DVDs may have picture, sound or other playback problems.

The Rear Seat Entertainment System can play back video DVDs produced according to the following standards:

- region code 2 (for Europe) or region code 0 (no region code)
- PAL or NTSC standard

You will generally find the relevant details either on the DVD itself or on the DVD case.

- i** If you insert a video DVD with a different region code, you will see a message to this effect.
- i** The Rear Seat Entertainment System is set to region code 2 at the factory. This setting can be changed at an authorized Mercedes-Benz Center. This will allow you to play video DVDs with a different region code, provided that they are produced in accordance with the PAL or NTSC TV standard.

Playback problems may occur when playing copied discs. There is a large variety of discs, DVD authoring software, writing software and writers available. This variety means that there is no guarantee that the Rear Seat Entertainment System will be able to play video DVDs that you have copied yourself.

Function restrictions

Depending on the DVD, it is possible that certain functions or actions described in this section will be temporarily blocked or may not

function at all. As soon as you try to activate these functions or actions, you will see the  symbol in the display.

Inserting and removing DVDs

- ▶ Proceed as described in the "Audio CD / DVD and MP3 mode" (▷ page 86) section.

Switching to video DVD mode





- ▶ Insert a video DVD.
The Rear Seat Entertainment System loads the disc.
- ▶ Select **Disc** with the remote control and confirm with .
You switch to video DVD mode.

The video DVD meets the playback

criteria: either the film will begin playing automatically or the DVD menu stored on the DVD will appear. If the DVD menu appears, you must start the film manually.

- ▶ Select the corresponding menu item in the DVD menu (▷ page 94).
- i** If disc mode was selected previously, the Rear Seat Entertainment System automatically plays a disc once you have inserted it.

Hiding/showing the navigation menu

- ▶ **To show:** press the  or  button.
 - ▶ **To hide:** press the  or  button.
- or
- ▶ Wait for approximately eight seconds.

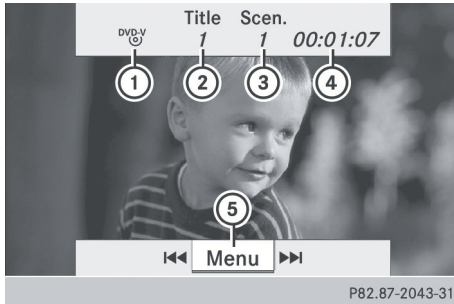

Navigation menu

- ① Disc type
- ② Current title
- ③ Current scene
- ④ Track time
- ⑤ To show the menu system

Showing/hiding the menu

- ▶ **To show:** press the **OK** button.
- or
- ▶ When the navigation menu is shown, select **Menu**.

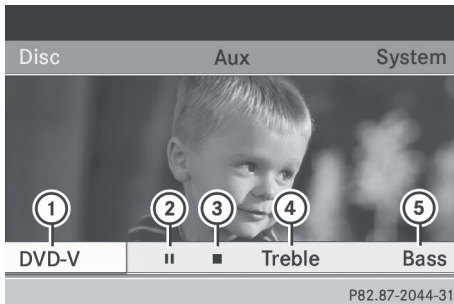

Menu system

- ① Video DVD options
 - ② Pause function
 - ③ Stop function
 - ④ To set the treble
 - ⑤ To set the bass
- ▶ **To hide:** press the **△** button, select **Full Screen** and press the **OK** button to confirm.

Fast forwarding/rewinding

- ▶ Press and hold the **⏮** or **⏭** button until the desired position is reached. You see the navigation menu.

Pause function

- ▶ Display the menu system (> page 92).
- ▶ **To pause playback:** select **⏸** and press the **OK** button to confirm. The **⏸** display changes to **▶**.
- ▶ **To continue playback:** select **▶** and press the **OK** button to confirm. The menu system is hidden.

Stop function

- ▶ Display the menu system (> page 92).
- ▶ **To stop playback:** select **■** and press the **OK** button to confirm. The **■** display changes to **▶**. The video image is hidden.
- ▶ **To continue playback:** select **▶** and press the **OK** button to confirm. Playback continues from the point where it was interrupted. The menu system is hidden.
- ▶ **To stop playback:** while playback is interrupted, select **■** again and press the **OK** button to confirm. Playback stops and returns to the beginning of the DVD. **▶** is highlighted.
- ▶ **To restart playback:** select **▶** and press the **OK** button to confirm. Playback starts from the beginning of the DVD.

Selecting a scene/chapter

Introduction

If the film is divided into scenes or chapters, you can select them directly while the film is running, or skip forwards step-by-step. Some DVDs do not permit this at certain points (e.g. during the opening credits).

- ▶ **To skip forwards or backwards:** press the or button.

or

- ▶ Press the or button. The navigation menu (▷ page 91) appears for approximately eight seconds.

Selecting a scene/chapter directly

Example: scene/chapter 5

- ▶ Press the button while the movie is playing.
- ▶ Press the corresponding number key, such as .

or

- ▶ Display the menu system (▷ page 92).
- ▶ Select **DVD-V** using the or button and confirm with the .
- ▶ Select **DVD Functions** using the or button and confirm with the .
- ▶ Select **Scene Selection** from the menu and press the to confirm.
- ▶ Select number **5** and confirm with the .

In both cases, playback will begin from the fifth scene/chapter after a brief pause.

- i** It may also be possible to select the scene/chapter from within the menu stored on the DVD.

Selecting a film/title

Introduction

If the DVD contains several films, these can be selected directly. A film can be selected either when the DVD is being played back or when it is stopped.

- ▶ Display the menu system (▷ page 92).
- ▶ Select **DVD-V** using the or button and confirm with the .
- ▶ Select **DVD Functions** using the or button and confirm with the .

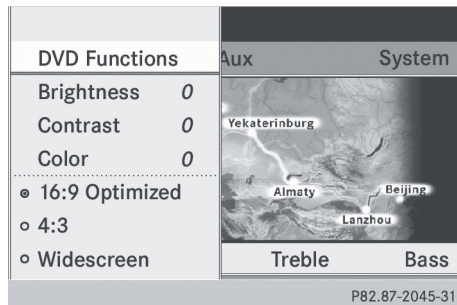

- ▶ Select **Title** from the menu.
- ▶ **To call up the selection list:** press the .
- ▶ Select a film/track.

Selecting a film/track directly

Example: selecting film 2

- ▶ Press the button. After a brief pause, the second film is played.
- i** The film can also be selected from the menu on the DVD itself.

Picture settings

Adjusting the brightness, contrast or color

- ▶ Display the menu system (▷ page 92).
- ▶ Select **DVD-V** using the ◀ or ▶ button and confirm with the OK button.
- ▶ Select **Brightness**, **Contrast** or **Color** with the ▲ or ▼ button and confirm with the OK button.
- ▶ **To change a setting:** press and hold the ▲ or ▼ button until the desired setting has been reached.
- ▶ **To store a setting:** press OK.

Changing the picture format

- ▶ Display the menu system if necessary (▷ page 92).
- ▶ Select **DVD-V** using the ◀ or ▶ button and confirm with the OK button. The DVD-V menu appears. The ● icon in front of the **16:9 Optimized**, **4:3** or **Widescreen** menu item indicates the format currently set.
- ▶ **To change the format:** press and hold the ▲ or ▼ button until the desired format is selected.
- ▶ **To store a setting:** press OK.

DVD menu

Calling up the DVD menu

The DVD menu is the menu stored on the DVD itself. It is structured in various ways according to the individual DVD and permits certain actions and settings.

In the case of multi-language DVDs, for example, you can change the DVD language in the DVD menu.

- ▶ Display the menu system (▷ page 92).
- ▶ Select **DVD-V** using the ◀ or ▶ button and confirm with the OK button.

- ▶ Select **DVD Functions** using the ▲ or ▼ button and confirm with the OK button.
- ▶ Select **Menu** and press the OK button to confirm. The DVD menu appears.

Selecting menu items in the DVD menu

- ▶ Press the ▲, ▼, ◀ or ▶ button.
- ▶ **To confirm your selection:** press the OK button. The selection menu appears.
- ▶ **i** Menu items which cannot be selected are grayed out.



- ▶ Confirm **Select**. The Rear Seat Entertainment System carries out the action or displays a submenu for the item selected in the DVD menu.
- ▶ Make a selection from the further options, if necessary. The Rear Seat Entertainment System then switches back to the DVD menu.
- ▶ **i** Depending on the DVD, the menu items: **Back (to movie)**, **Play**, **Stop**, **◀◀**, **▶▶** or **Go Up** may not function or not function at certain points in the DVD menu. To indicate this, the ⊙ symbol appears in the display.

Stopping a film or skipping to the beginning or end of a scene

- ▶ Select any menu item from the DVD menu. The selection menu appears.
- ▶ **To stop a film:** select **Stop** from the menu.
- ▶ **To skip to the end of a scene:** select **▶▶▶** from the menu.
- ▶ **To skip to the beginning of a scene:** select **◀◀◀** from the menu.

Moving up one level in the DVD menu













- ▶ Press the  back button.
- or
- ▶ Select the corresponding menu item from the DVD menu.
- or
- ▶ Select any menu item from the DVD menu.
- ▶ Select the **Go Up** menu item from the menu.

Back to the film

- ▶ Press the  back button repeatedly until you see the film.
- or
- ▶ Select the corresponding menu item from the DVD menu.
- or
- ▶ Select any menu item from the DVD menu.
- ▶ Select the **Back (to movie)** menu item from the selection menu.













Setting the language and audio format

This function is not available on all DVDs. If it is available, you can set the audio language or the audio format. The number of settings is determined by the DVD content. It may also be possible to access the settings from the DVD menu.

- ▶ Display the menu system (▷ page 92).
- ▶ Select **DVD-V** using the  or  button and confirm with the  button.
- ▶ Select **DVD Functions** using the  or  button and confirm with the  button.
- ▶ Select **Audio Language** and press the  button to confirm. A selection menu appears after a short while. The **•** dot in front of an entry indicates the currently selected language.
- ▶ **To change a setting:** press and hold the  or  button until the desired setting has been reached.
- ▶ **To store a setting:** press .
- ▶ **To exit the menu:** press the  or  button.







Subtitles and camera angle

These functions are not available on all DVDs. The number of subtitle languages and camera angles available depends on the content of the DVD. It may also be possible to access the settings from the DVD menu.

- ▶ Display the menu system (▷ page 92).
- ▶ Select **DVD-V** using the  or  button and confirm with the  button.
- ▶ Select **DVD Functions** using the  or  button and confirm with the  button.
- ▶ Select **Subtitles** or **Camera Angle** and press the  button to confirm. In both cases, a selection menu appears after a short while. The **•** dot in front of an entry indicates the current setting.
- ▶ **To change a setting:** press and hold the  or  button until the desired setting has been reached.
- ▶ **To store a setting:** press .
- ▶ **To exit the menu:** press the  or  button.

Interactive content

DVDs can also contain interactive content (e.g. a video game). In a video game, you may be able to influence events by selecting and triggering actions. The type and number of actions depend on the DVD.

- ▶ **To select an action:** press the , ,  or  button.
- ▶ **To trigger an action:** press the  button. A menu appears and the first entry, **Select**, is highlighted.
- ▶ Press the  button.

AUX mode

Introduction

You can connect one external video source to each of the displays of the Rear Seat Entertainment System (AUX display) and also one external video source to the rear-compartment CD/DVD drive (AUX drive) with a sound and video signal.

Please see the corresponding operating instructions for information on how to operate the external video source.

For further details about external video sources, please consult an authorized Mercedes-Benz Center.

Connecting AUX equipment

AUX drive

The AUX drive jacks are located on the CD/DVD drive next to the CD/DVD eject button (▷ page 26).

Displaying AUX



The AUX display jacks are on the side of the screen (▷ page 24).

Audio and video connection

- ▶ Insert the audio plugs for the left and right signals into the corresponding **L** and **R** jacks.
- ▶ Insert the video plug into the **V** jack.

Activating AUX mode





AUX drive

- ▶ Select **Aux** using the  or  button and confirm with the  button. The AUX menu appears.





P82.60-7389-31

AUX menu

- ▶ Select **Source** and confirm with the  button.
- ▶ Select the **Disc Drive Aux** with the  or  button and confirm with the  button.

You will hear and see the content of the video source if it is connected to the CD/DVD drive and switched to playback. If no video image is available from the AUX source connected, you will see an audio menu.

Displaying AUX

- ▶ Select the screen to which an external video source is connected for the remote control.
- ▶ Select **Aux** using the  or  button and confirm with the  button.

- ▶ Select **Source** and confirm with the **OK** button.
- ▶ Select **Display Aux** with the **▼** or **▲** button and confirm with the **OK** button.
You will see and hear the content of the video source if it is switched to playback. If no video image is available from the AUX source connected, you will see an audio menu.

Adjusting the brightness, contrast or color

- ▶ Select **Display Aux** or **Disc Drive Aux** in the Aux menu.
- ▶ Select **Brightness**, **Contrast** or **Color**. An adjustment scale appears.
- ▶ **To make a setting:** press the **▲** or **▼** button.
- ▶ **To confirm your selection:** press the **OK** button.

Changing the picture format

- ▶ Select **Display Aux** or **Disc Drive Aux** in the Aux menu and confirm with the **OK** button.
The **●** icon in front of the **16:9 Optimized**, **4:3** or **Widescreen** menu item indicates the format currently set.
- ▶ **To change the format:** press and hold the **▲** or **▼** button until the desired format is selected.
- ▶ **To store a setting:** press **OK**.

Publication details

Internet

Further information about Mercedes-Benz vehicles and about Daimler AG can be found on the following websites

<http://www.mercedes-benz.com>

<http://www.daimler.com>

Editorial office

You are welcome to forward any questions or suggestions you may have regarding this manual to the technical documentation team at the following address:

Daimler AG, HPC: R822, D-70546 Stuttgart, Germany

Not to be reprinted, translated or otherwise reproduced, in whole or in part, without written permission of Daimler AG.



1725842081

Order no. 6515 6931 13 Part no. 172 584 20 81 Edition B 2012